

554

SCIENTIFIC LIBRARY



UNITED STATES PATENT OFFICE

CASE SHELF

GOVERNMENT PRINTING OFFICE

11-8625

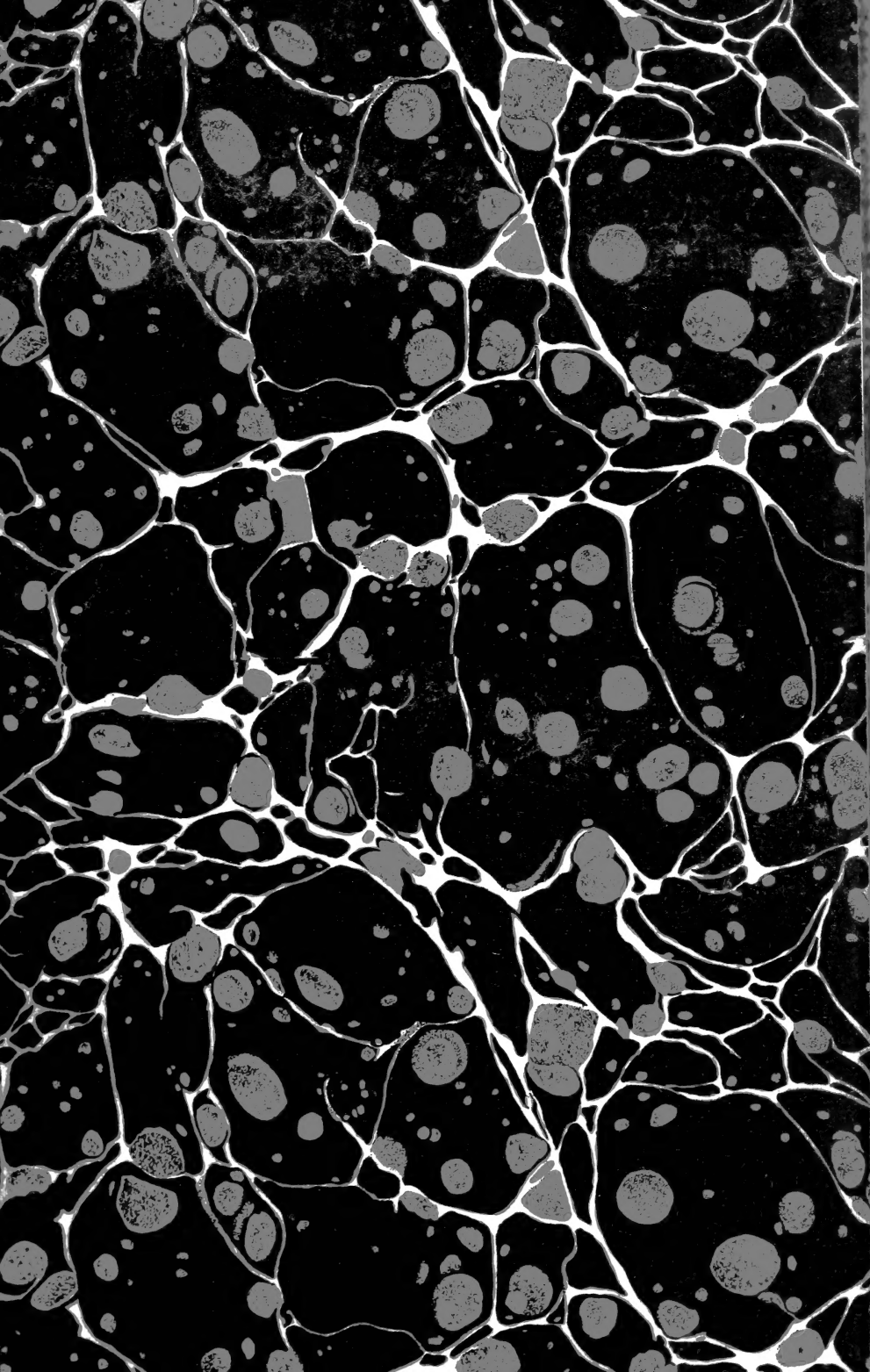

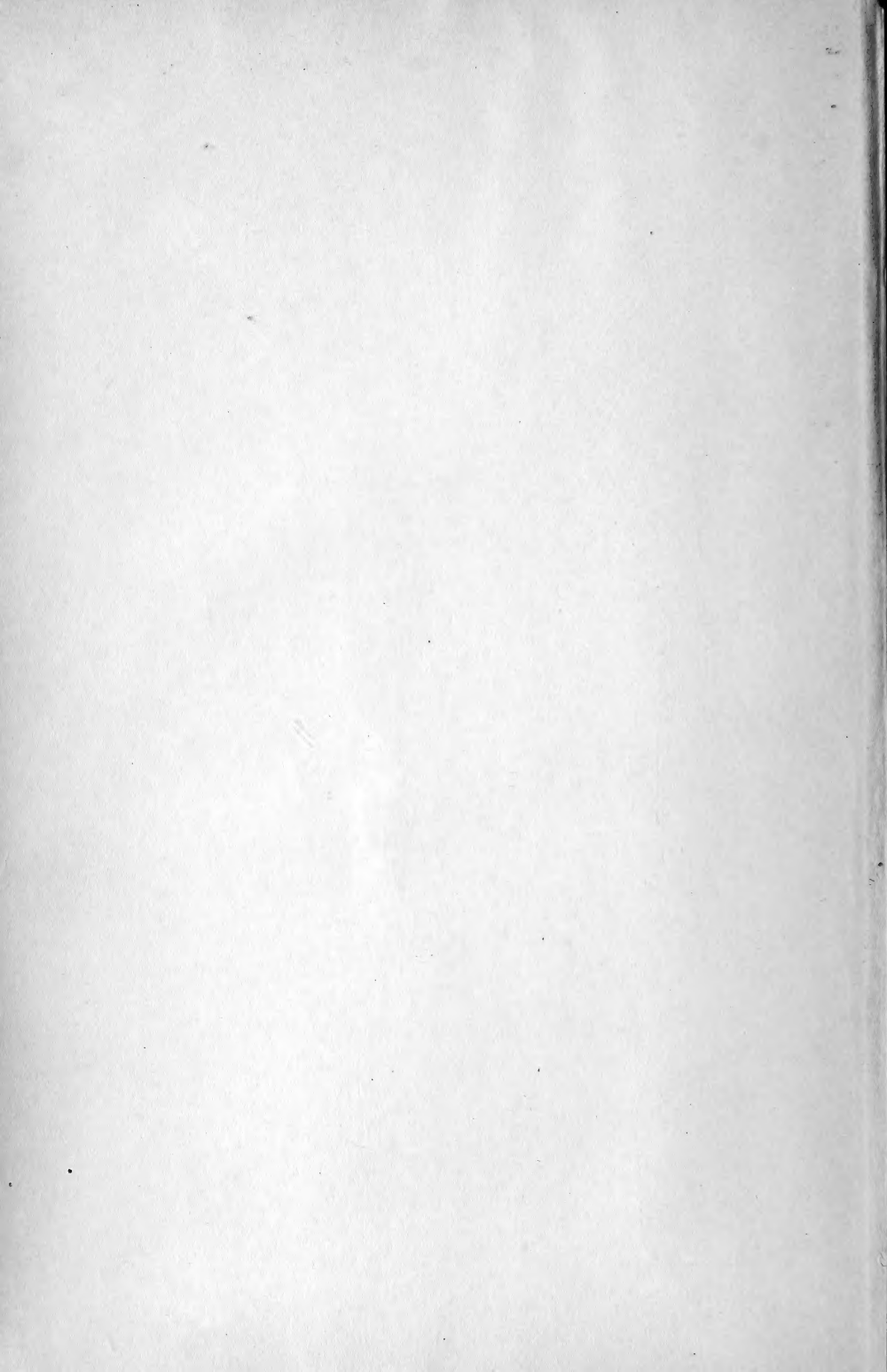



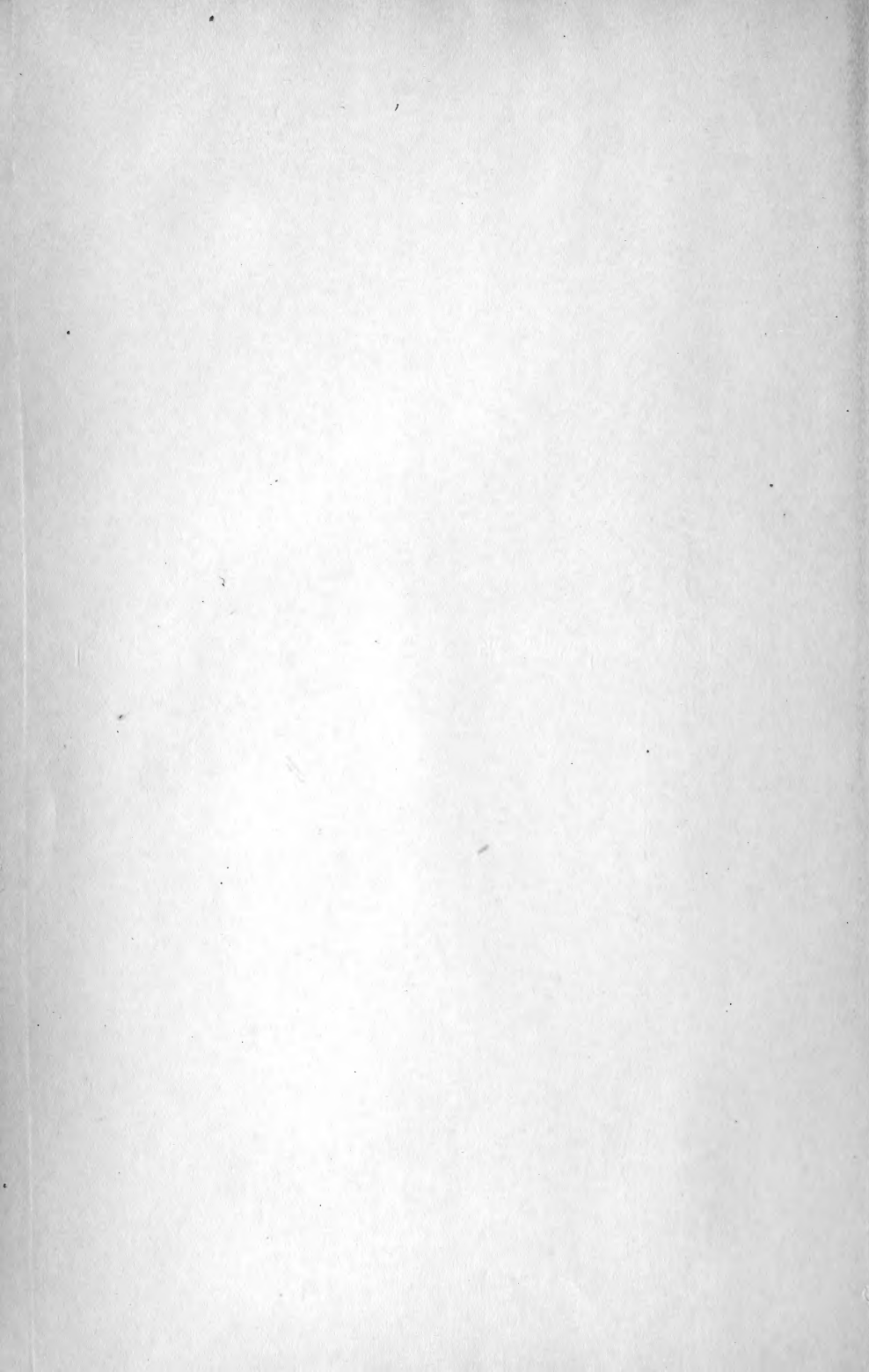

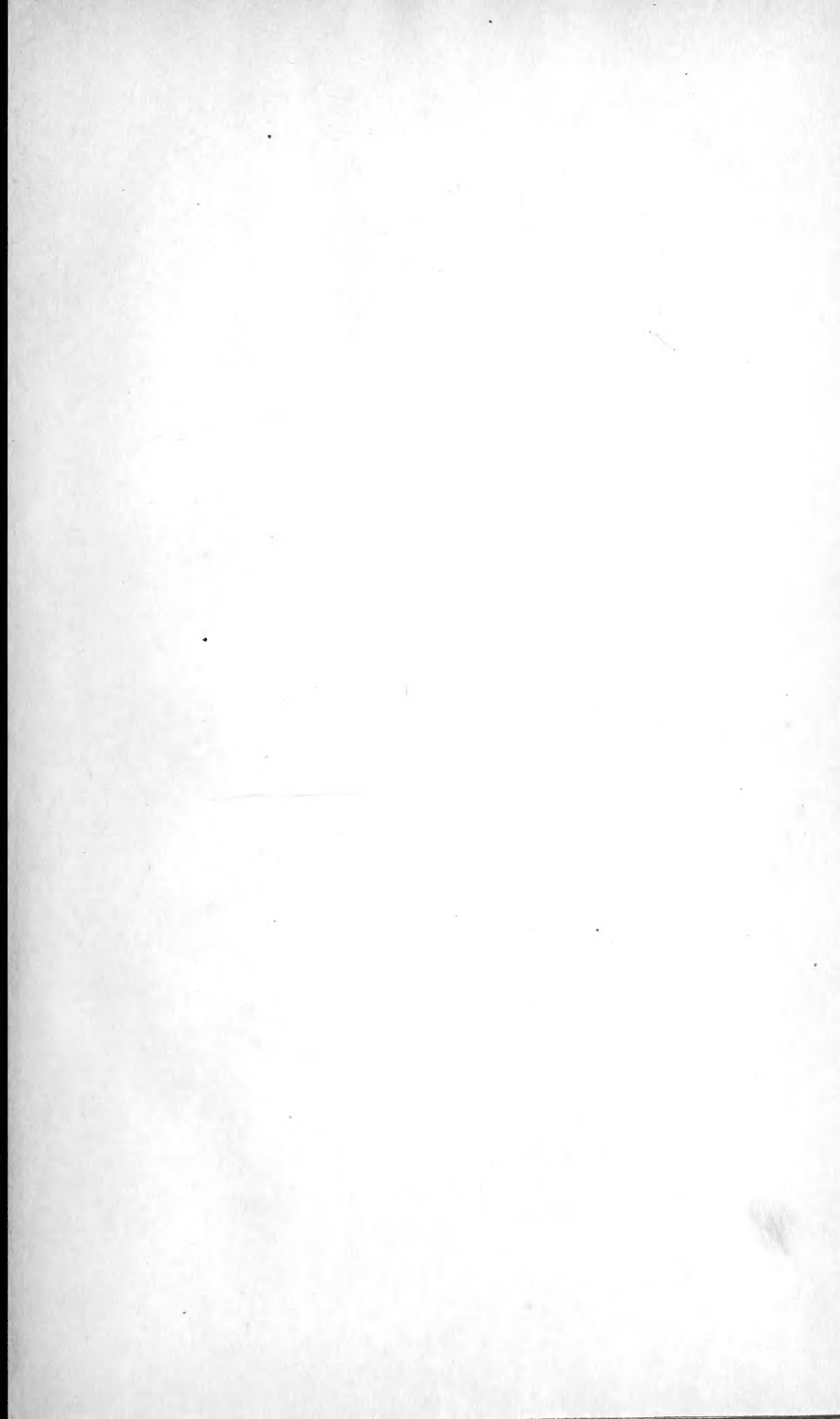

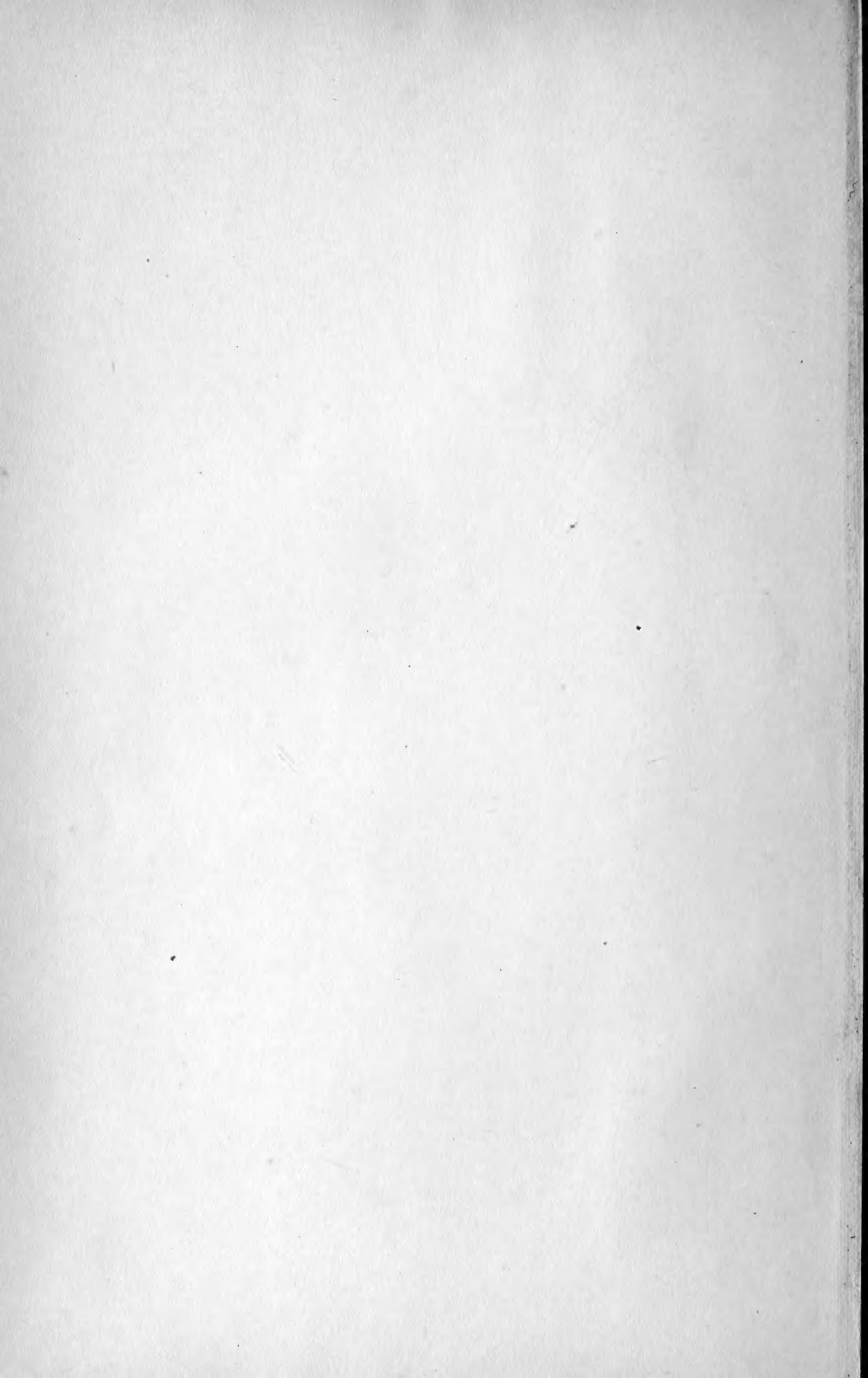

THE

LONDON, EDINBURGH, AND DUBLIN

PHILOSOPHICAL MAGAZINE

AND

JOURNAL OF SCIENCE.

CONDUCTED BY

LORD KELVIN, G.C.V.O., D.D.E., LL.D. F.R.S. &c.

JOHN JOLY, M.A. D.Sc. F.R.S. F.G.S.

AND

WILLIAM FRANCIS, F.L.S.

“Nec araneorum sane textus ideo melior quia ex se fila gignunt, nec noster vilior quia ex alienis libamus ut apes.” JUST. LIPS. *Polit. lib. i. cap. 1. Not.*

VOL. VII.—SIXTH SERIES.

JANUARY—JUNE 1904.

LONDON:

TAYLOR AND FRANCIS, RED LION COURT, FLEET STREET.

SOLD BY SIMPKIN, MARSHALL, HAMILTON, KENT AND CO., LD.—T. AND T. CLARK,
EDINBURGH;—SMITH AND SON, GLASGOW;—HODGES, FIGGIS, AND
CO., DUBLIN;—PUTNAM, NEW YORK;—VEUVE J. BOYVEAU,
PARIS;—AND ASHER AND CO., BERLIN.

81093

21

Q
175

“Meditationis est perscrutari occulta; contemplationis est admirari
perspicua Admiratio generat quæstionem, quæstio investigationem,
investigatio inventionem.”—*Hugo de S. Victore.*

—“Cur spirent venti, cur terra dehiscat,
Cur mare turgescat, pelago cur tantus amaro,
Cur caput obscurâ Phoebus ferrugine condat,
Quid toties diros cogat flagrare cometas,
Quid pariat nubes, veniant cur fulmina cœlo,
Quo micet igne Iris, superos quis conciat orbis
Tam vario motu.”

J. B. Pinelli ad Mazonium.

ALERE FLAMMAM.

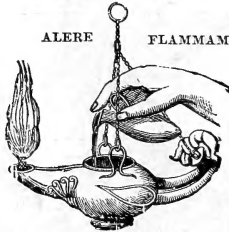

CONTENTS OF VOL. VII.

(SIXTH SERIES).

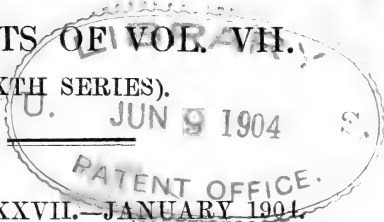

NUMBER XXXVII.—JANUARY 1904.

| | Page |
|---|------|
| Prof. A. Schuster on a Simple Explanation of Talbot's Bands. | 1 |
| Dr. H. A. Bumstead on the Variation of Entropy as treated by Prof. Willard Gibbs | 8 |
| Rev. O. Fisher on Deflexions of the Plumb-line in India.... | 14 |
| Mr. A. H. Pfund: A Study of the Selenium Cell..... | 26 |
| Dr. C. Chree on the Bending of Magnetometer Deflexion-Bars. | 39 |
| Dr. G. E. Allan on the Magnetism of Basalt and the Magnetic Behaviour of Basaltic Bars when Heated in Air. (Plates I. & II.)..... | 45 |
| Mr. P. E. B. Jourdain on the Transfinite Cardinal Numbers of Well-ordered Aggregates | 61 |
| Prof. J. D. Everett on Borgnet's Method of Dividing an Angle in an Arbitrary Ratio | 75 |
| Notices respecting New Books:— | |
| Charles Nordmann: Essai sur le rôle des Ondes Hertz- ennes en Astronomie Physique | 77 |
| Proceedings of the Geological Society:— | |
| Mr. E. E. Walker on the Garnet-bearing and Associated Rocks of the Borrowdale Volcanic Series | 79 |
| Prof. J. W. Gregory on the Glacial Geology of Tasmania. | 80 |

NUMBER XXXVIII.—FEBRUARY.

| | |
|--|-----|
| Mr. R. K. McClung on the Effect of Temperature on the Ionization produced in Gases by the Action of Röntgen Rays | 81 |
| Dr. E. Weintraub: Investigation of the Arc in Metallic Vapours in an Exhausted Space. (Plates III.—XI.) | 95 |
| Mr. C. A. Chant on the Variation of Potential along the Transmitting Antenna in Wireless Telegraphy. (Plates XII. & XIII.) | 124 |
| Mr. S. J. Allan on the Radioactivity of the Atmosphere. (Plate XIV.) | 140 |

| | Page |
|--|------|
| Prof. A. Schuster on the Number of Electrons conveying the Conduction Currents in Metals | 151 |
| Prof. E. Hagen and Prof. H. Rubens on some Relations between the Optical and the Electrical Qualities of Metals. | 157 |
| Mr. Franz Leininger on the Relation of the Electric Charges transported by Cathode and Canal Rays to the Exciting Current | 180 |
| Prof. Karl Pearson on a Novel Instrument for Drawing Parabolas. (Plate XV.) | 200 |
| Profs. E. Rutherford and H. T. Barnes on the Heating Effect of the Radium Emanation | 202 |
| Contribution by Lord Kelvin to the Discussion on the Nature of the Emanations from Radium which was opened by Professor E. Rutherford at the Meeting of the British Association last September | 220 |
| Rev. P. J. Kirkby on the Effect of the Passage of Electricity through a Mixture of Oxygen and Hydrogen at Low Pressures | 223 |
| Editorial Note | 233 |
| Notices respecting New Books:— | |
| Dr. J. A. Fleming's Handbook for the Electrical Laboratory and Testing Room, Vol. II. | 233 |
| Prof. A. A. Michelson's Light Waves and Their Uses .. | 235 |
| Prof. E. Mathias's Le Point Critique des Corps Purs .. | 235 |
| Prof. A. Classen's Ausgewählte Methoden der Analytischen Chemie, Vol. II. | 236 |
| Annuaire pour l'an 1904 | 236 |

NUMBER XXXIX.—MARCH.

| | |
|--|-----|
| Prof. J. J. Thomson on the Structure of the Atom: an Investigation of the Stability and Periods of Oscillation of a number of Corpuscles arranged at equal intervals around the Circumference of a Circle; with Application of the results to the Theory of Atomic Structure | 237 |
| Mr. O. W. Richardson on the Solubility and Diffusion in Solution of Dissociated Gases | 266 |
| Mr. J. R. Cotter on an Instrument for Drawing Conics | 274 |
| Prof. J. S. Townsend on the Charges on Ions | 276 |
| Mr. R. Appleyard on the Conductometer | 281 |
| Mr. T. C. Porter on a Method of Mechanically Reinforcing Sounds. (Plate XVI.) | 283 |
| Mr. S. Skinner on the Photographic Action of Radium Rays. | 288 |
| Major S. G. Burrard on Deflexions of the Plumb-line in India | 292 |
| Mr. P. E. B. Jourdain on the Transfinite Cardinal Numbers of Number-Classes in General | 294 |
| Dr. J. Joly on the Motion of Radium in the Electric Field .. | 303 |

| | Page |
|--|------|
| Notices respecting New Books :— | |
| Jean Perrin's <i>Traité de Chimie Physique</i> | 307 |
| Dr. Max Planck's <i>Treatise on Thermodynamics</i> | 308 |
| Prof. W. Ostwald's <i>Die Schule der Chemie</i> | 309 |
| J. M. Pernter's <i>Allerlei Methoden, das Wetter zu prophezeien</i> | 310 |
| Prof. H. Poincaré's <i>La Science et l'Hypothèse</i> | 310 |
| Proceedings of the Geological Society :— | |
| Prof. C. I. Morgan & S. H. Reynolds on the Igneous Rocks associated with the Carboniferous Limestone of the Bristol District | 310 |
| Mr. A. R. Short on the Rhætic Beds of England | 311 |
| Mr. & Mrs. Clement Reid on a Palæolithic Floor at Prah Sands, in Cornwall | 312 |
| Mr. W. S. Boulton on the Igneous Rocks at Spring Cove, near Weston-super-Mare | 313 |
| Prof. H. N. Rau on a Deep-Sea Deposit from an Artesian Boring at Kilacheri, near Madras | 313 |
| Prof. S. H. Reynolds and Mr. A. Vaughan on the Rhætic Beds of the South-Wales Direct Line | 314 |
| Intelligence and Miscellaneous Articles :— | |
| Note on " π ," by R. Chartres | 315 |
| Obituary Notice: Dr. William Francis | 315 |

NUMBER XL.—APRIL.

| | |
|--|-----|
| Prof. D. B. Brace on Double Refraction in Matter moving through the <i>Æther</i> | 317 |
| Mr. S. Skinner on the Occurrence of Cavitation in Lubrication. (Plates XVII.—XIX.) | 329 |
| Prof. W. M ^c F. Orr on the Radiation from an Alternating Circular Electric Current | 336 |
| Messrs. Simmance and Abady on the Simmance-Abady "Flicker" Photometer. (Plate XX.) | 341 |
| Prof. F. T. Trouton and Mr. E. S. Andrews on the Viscosity of Pitch-like Substances | 347 |
| Prof. J. A. McClelland on the Emanation given off by Radium. | 355 |
| Prof. J. A. McClelland on the Comparison of Capacities in Electrical Work; an Application of Radioactive Substances. | 362 |
| Prof. R. Threlfall on a New Form of Sensitive Hot-Wire Voltmeter | 371 |
| Prof. R. W. Wood on some New Cases of Interference and Diffraction. (Plate XXI.) | 376 |
| Messrs. L. Holborn and L. W. Austin on Disintegration of the Platinum Metals in Different Gases. | 388 |
| Dr. W. Watson on a Quartz-Thread Vertical Force Magnetograph. (Plates XXII. & XXIII.) | 393 |
| Mr. G. W. Walker on Stresses in a Magneto-static Field | 399 |
| Mr. W. Sutherland on the Dielectric Capacity of Atoms | 402 |

| | Page |
|---|------|
| Mr. W. Sutherland on the Crémieu-Pender Discovery | 405 |
| Mr. H. Darwin on an Electric Thermostat. (Plate XXIV.) . | 408 |
| Notices respecting New Books :— | |
| Dr. Johannes Stark's Die Dissoziierung und Umwandlung Chemischer Atome | 414 |
| Proceedings of the Geological Society :— | |
| Lieut.-Col. T. English on Eocene and Later Formations surrounding the Dardanelles | 414 |
| Dr. C. Davison on the Derby Earthquakes of March 24th and May 3rd, 1903 | 416 |

NUMBER XLI.—MAY.

| | |
|--|-----|
| Mr. W. Sutherland on the Electric Origin of Rigidity and Consequences | 417 |
| Prof. H. Nagaoka on the Kinetics of a System of Particles illustrating the Line and the Band Spectrum and the Phenomena of Radioactivity | 445 |
| Mr. R. A. Houstoun's Spectroscopic Notes | 456 |
| Mr. S. H. Burbury on the Kinetic Theory of Gases | 467 |
| Mr. R. Hosking on the Electrical Conductivity and Fluidity of Solutions | 469 |
| Mr. J. Barnes on the Analysis of Bright Spectrum Lines. (Plates XXV. & XXVI.) | 485 |
| Dr. C. Chree on the Whirling and Transverse Vibrations of Rotating Shafts | 504 |
| Mr. C. G. Barkla on the Energy of Secondary Röntgen Radiation | 543 |
| Mr. S. C. Laws on the Thomson Effect in Alloys of Bismuth and Tin | 560 |
| Prof. J. Larmor on the Intensity of the Natural Radiation from Moving Bodies and its Mechanical Reaction | 578 |
| Prof. J. A. Fleming on the Measurement of Small Inductances and Capacities, and on a Standard of Small Inductance . . | 586 |
| Prof. J. A. Fleming on a Hot-Wire Ammeter for the Measurement of very small Alternating Currents | 595 |
| Notices respecting New Books :— | |
| Mr. E. T. Whittaker's Course of Modern Analysis | 605 |
| Mr. H. Hilton's Mathematical Crystallography and the Theory of Groups of Movements | 605 |
| Prof. P. Duhem's Thermodynamics and Chemistry | 606 |
| Prof. S. Young's Fractional Distillation | 607 |
| Intelligence and Miscellaneous Articles :— | |
| An Instrument for Drawing Conics, by Mr. J. R. Cotter. | 608 |

NUMBER XLII.—JUNE.

| | Page |
|--|------|
| Lord Kelvin on Deep-water Two-dimensional Waves produced by any given Initiating Disturbance | 609 |
| Prof. J. Larmor on the ascertained Absence of Effects of Motion through the \AA ether, in relation to the Constitution of Matter, and on the FitzGerald-Lorentz Hypothesis .. | 621 |
| Dr. E. P. Harrison on the Temperature-Variation of the Coefficient of Expansion of Pure Nickel..... | 626 |
| Prof. J. A. Pollock: A Comparison of the Periods of the Electrical Vibrations associated with Simple Circuits. With an Appendix by J. C. Close..... | 635 |
| Mr. O. U. Vonwiller: Contribution to the Study of the Dielectric Constant of Water at Low Temperatures..... | 655 |
| Mr. E. W. Morley on the Vapour-Pressure of Mercury at Ordinary Temperatures | 662 |
| Prof. M. Smoluchowski-Smolán on the Principles of Aerodynamics and their Application, by the Method of Dynamical Similarity, to some special Problems | 667 |
| Mr. C. T. R. Wilson on the Condensation Method of Demonstrating the Ionisation of Air under Normal Conditions .. | 681 |
| Dr. G. Johnstone Stoney on Escape of Gases from Atmospheres | 690 |
| Mr. W. Bennett on Non-homocentric Pencils, and the Shadows produced by them.—I. An Elementary Treatment of the Standard Astigmatic Pencil..... | 700 |
| Mr. W. Bennett on Non-homocentric Pencils, and the Shadows produced by them.—II. Shadows produced by Axially Symmetrical Pencils possessing Spherical Aberration. (Plate XXVII.) | 706 |
| Index | 716 |

PLATES.

- I. & II. Illustrative of Dr. G. E. Allan's Paper on the Magnetism of Basalt and the Magnetic Behaviour of Basaltic Bars when Heated in Air.
- III.-XI. Illustrative of Dr. E. Weintraub's Paper on the Arc in Metallic Vapours in an Exhausted Space.
- XII. & XIII. Illustrative of Mr. C. A. Chant's Paper on the Variation of Potential along the Transmitting Antenna in Wire-less Telegraphy.
- XIV. Illustrative of Mr. S. J. Allan's Paper on the Radioactivity of the Atmosphere.
- XV. Illustrative of Prof. Karl Pearson's Paper on a Novel Instrument for Drawing Parabolas.
- XVI. Illustrative of Mr. T. C. Porter's Paper on a Method of Mechanically Reinforcing Sounds.
- XVII.-XIX. Illustrative of Mr. S. Skinner's Paper on the Occurrence of Cavitation in Lubrication.
- XX. Illustrative of Messrs. Simmance and Abady's Paper on the Simmance-Abady "Flicker" Photometer.
- XXI. Illustrative of Prof. R. W. Wood's Paper on some new Cases of Interference and Diffraction.
- XXII. & XXIII. Illustrative of Dr. W. Watson's Paper on a Quartz-Thread Vertical Force Magnetograph.
- XXIV. Illustrative of Mr. H. Darwin's Paper on an Electric Thermostat.
- XXV. & XXVI. Illustrative of Mr. J. Barnes's Paper on the Analysis of Bright Spectrum Lines.
- XXVII. Illustrative of Mr. W. Bennett's Paper on Non-homocentric Pencils, and the Shadows produced by them.

ERRATUM.

Page 24, line 16, for $\tan^{-1} \frac{lh}{xv}$ read $x \frac{\tan^{-1}lh}{xv}$

THE
LONDON, EDINBURGH, AND DUBLIN
PHILOSOPHICAL MAGAZINE
AND
JOURNAL OF SCIENCE.

[SIXTH SERIES.]

JANUARY 1904.

I. *A Simple Explanation of Talbot's Bands.*
By ARTHUR SCHUSTER, F.R.S.*

1. **T**HESE bands are observed in a spectrum when half the aperture of the pupil is covered with a thin plate of mica or glass, provided that the plate be inserted on that side on which the blue of the spectrum appears. The explanation of these bands which has been given by Airy and Stokes involves a rather elaborate mathematical process which, though convincing, does not leave the mind completely satisfied. The essential reason for the want of symmetry which causes the bands to appear only when the plate is introduced on one side, ought to be capable of being rendered obvious in a more simple manner. This I propose to do in the present communication.

As the bands are seen with "white light," a single luminous impulse should be sufficient to produce them, and as the distribution of intensity in the spectrum is clearly not an essential factor in the case, we may choose the shape and duration of the impulse as we like.

Let an indefinitely short impulse spread out from a distant point, and strike a plane grating GG' normally. This grating may be imagined to be made up of a series of narrow reflecting parallel strips $A_1, A_2, \&c.$, separated by intervals which reflect no light. A lens SS' having its focus at F receives the luminous disturbance. The impulsive velocity spreading from A_1 reaches F sooner than that reflected from

* Communicated by the Author.

A_2 , and so on as the optical distances of the reflecting strips gradually increase from A_1 to A_n . Hence the disturbance at F consists of a series of impulses, following each other at intervals equal to the period of a homogeneous wave which, starting from the same luminous point, and reflected by the grating, would have its first principal maximum at F . All this, of course, is simply the elementary illustration, first given, I believe, by Lord Rayleigh, of the ordinary action of a grating when analysing white light. The question now is: How can the impulses which succeed each other at F be made to interfere? Clearly only by retarding those which first reach F , or accelerating those which reach that point last. A plate of appropriate thickness introduced from the left-hand side of the figure as it is drawn, can be made to answer the purpose. If, on the contrary, the same plate were introduced on the right-hand side, it would only retard those impulses which already arrive late, and therefore no interference could take place. This is really all that need be said in explanation of the bands; but a more detailed consideration of this view of the problem leads easily to a clearer expression for the calculation of the best thickness of the interposed plate than the more elaborate calculations of previous investigations.

The best thickness is secured when the whole series of impulses is divided into two equal portions, the impulses arriving in pairs simultaneously at F . If A_s be the central line of the grating, the retardation ought to be such that the impulses coming from A_1 and from A_s reach F at the same time. If N be the total number of lines of the grating, the best retardation is therefore $\frac{1}{2}N\lambda$, and the plate should be pushed sufficiently far into the beam to affect half its width. The wave-length λ here means the wave-length of that homogeneous train of waves which has its first principal maximum at F , so that the retardation of each impulse compared with the next is λ . If the retardation is either greater or smaller, some of the impulses arrive too soon or too late to overlap others, and the bands are less clear. If the retardation has more than twice its best value, the series of impulses from A_1 to

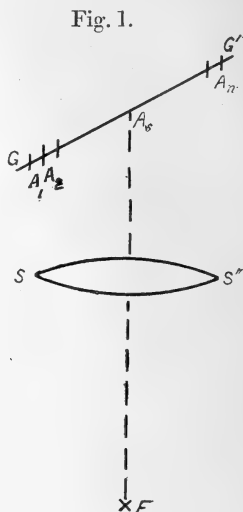

A_s pass through F later than those coming from A_s , A_{s+1} , &c., and hence there cannot be any interference.

If at a certain point of the spectrum corresponding to a wave-length λ there is a maximum of light, the relative retardation of the two interfering impulses must be equal to $m\lambda$, m being an integer; the next adjoining band towards the violet will appear at a wave-length λ' such that

$$m\lambda = (m+1)\lambda'.$$

Hence for the distance between the bands

$$\frac{(\lambda - \lambda')}{\lambda'} = \frac{1}{m},$$

with the best thickness of interposed plate, $m = \frac{1}{2}N$, and hence

$$\frac{\lambda - \lambda'}{\lambda'} = \frac{2}{N},$$

where λ' in the denominator may with sufficient accuracy be replaced by λ . If λ'' be that wave-length nearest to λ at which there is a *minimum* of light, it follows that

$$\frac{\lambda - \lambda''}{\lambda} = \frac{1}{N}.$$

If a linear homogeneous source of light of wave-length λ be examined by means of a grating, the central image extends to a wave-length λ_1 such that

$$\frac{\lambda - \lambda_1}{\lambda} = \frac{1}{N},$$

where N , as before, is the total number of lines on the grating. Hence the following proposition:—If, in observing Talbot's bands, that thickness of retarding-plate be chosen which reduces the minimum illumination of the dark spaces to zero, the distance between each maximum and the nearest minimum is equal to the distance between the central maximum and the first minimum of the diffractive image of homogeneous light, observed in the same region of the spectrum with the same optical arrangement. This proposition holds for all orders of spectra; but the appropriate thickness of the retarding plate increases in the same proportion as the order.

Lord Rayleigh's remark* that "the thickness of the plate must not exceed a certain limit, however pure the spectrum may be," requires the qualification that for infinite purity the limiting thickness also becomes infinite.

To examine the case in which the thickness of the retarding

* 'Encyclopædia Britannica' and 'Collected Works,' vol. iii. p. 133.

plate is not that which gives no light at the minimum, consider a certain retardation A_1B_1 introduced into half the beam. The effect is the same as if the impulses, instead of starting from $A_1, A_2, \dots A_s$, were sent off simultaneously from $B_1, B_2, \dots B_s$, where $A_1B_1 = A_2B_2 = \dots A_sB_s$ (fig. 2). If B_1A_p and B_sA_g are lines drawn parallel to the principal plane of the focussing-lens so that the optical distances of B_1 and A_p and of B_s and A_g to the focus are the same, the impulses starting from points between B_f and B_s may interfere with those starting from points between A_s and A_g ; but the parts of the grating A_1A_e and A_gA_n are not effective as regards interference, the impulses from A_1A_e arriving too soon and those from A_gA_n too late.

Fig. 2.

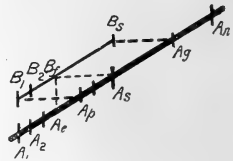

If the useless portions are cut off by means of screens, the bands become black again, and we return to the best retardation, but with a reduced aperture, and consequently a reduced resolving power. The introduction of these screens does not alter the width of the bands; but these will be further apart than for the best retardation on account of the reduced cross-section of the effective portion of the beam. If the retarding plate is thicker than that which gives the most distinct bands, it may similarly be shown that the blackness of the darkest portions may be restored by screening off the *central* portions of the beam; but the bands will be closer together in this case. The point at which the bands disappear altogether is that at which each homogeneous component of the impulse gives a central diffraction-image equal in width to the distance between the bands. In each case the width of the bands is easily seen to be the same as that given by the interference of two points of light separated laterally in the beam by a distance equal to that of any two of the pulses which reach the focus simultaneously.

Powell's experiment in which bands are obtained by introducing plates into part of the beam traversing a hollow prism filled with a refracting substance is only a modification of Talbot's, and is explained in a similar manner.

2. An objection might be raised to the above explanation in so far as it is not perhaps at once obvious how darkness may result by the interference of a succession of impulses which are all in the same direction. The answer to the objection is, that if the impulses belonging to the first half of the beam are retarded in such a way as to fit in exactly half-way between those belonging to the second half, the

disturbance at F would be a succession of impulses corresponding to the half period of the original impulse. There is light at F, but it is light which belongs to the overlapping spectrum of the second order. As regards the wave-length λ under consideration, there is darkness. The difficulty, if it is still felt to be one, may be avoided by considering a grating giving rise to the "corrugated waves" of Lord Rayleigh*. I have called these gratings "simple gratings," as all other gratings may be imagined to be made up of superposed simple gratings. The light of a simple grating is concentrated into the two spectra of the first order†. It may readily be shown that any device which gets rid of the spectra of different orders will change impulses which were originally in one direction into disturbances which are alternately in one and the other direction, so that no further question can arise as to the way in which, according to the view here adopted, the dark bands are formed in Talbot's experiment.

3. The proposition proved in § 1 allows us to extend the investigation to the case where the spectrum is produced by a prism. In the immediate neighbourhood of a given wave-length, the spectrum may be taken to be a normal one, and there can be no intrinsic difference between the bands seen in this case and those observed when a grating of the same resolving power is used. It has been shown by Lord Rayleigh that in all questions relating to resolving power the number of lines in the grating has to be replaced in the case of prisms by $t \frac{d\mu}{d\lambda}$, where t is the aggregate effective thickness of the prisms, μ the refractive index, and λ the wave-length. It follows at once that the retardation which gives black bands is for prisms

$$\frac{1}{2} \lambda t \frac{d\mu}{d\lambda}.$$

4. It is interesting to follow out the *modus operandi* of a prism when an impulse is transmitted through it. For the sake of simplicity we may confine ourselves to the case that the law of refraction is such that the group velocity is independent of the wave-length. If the impulse be confined to the wave-front W F (fig. 3) before entering a refracting substance, it will at a given time in its passage through it

* 'Encyclopædia Britannica,' "Wave Theory," and 'Collected Works.'

† Phil. Mag. xxxvii. p. 509 (1894).

lie near some surface $G G'$ which moves forward with the *group* velocity. I have shown, in a paper communicated to the recent meeting of the British Association, that the shape of the impulse changes periodically and alternately passes through its original shape and one exactly equal but opposite in direction. If now the impulse has passed through the prism and a wave-front for a homogeneous wave of length λ would lie in the direction $R S$, the "impulses" will be confined to a region immediately surrounding a plane $H S$, the position of which may be calculated by the ordinary law of refraction, substituting the group velocity for the wave velocity. But on $H S$ the impulsive motion is not uniform, but alters periodically from the original type to that which is equal and opposite to it. Hence if the emergent beam be received by a lens, the disturbance at the focus of the lens consists of a periodic motion which is the more homogeneous the greater the resolving power of the prism. It will be noticed that this explanation of the *modus operandi* of a prism differs materially from that given by Dr. J. Larmor ('Æther and Matter,' p. 248); but as we may imagine continuous media of such elastic properties as to give dispersion, the true explanation must be independent of the sympathetic vibrations which Dr. Larmor calls to his aid. To calculate the angle between $R S$ and $H S$, we note that $H R$ is equal to the space passed over in air in the time equal to the difference between that necessary to traverse the thickness t of the prism when the velocity is that of a homogeneous wave and when it is that of the group. Hence U being the group velocity, V the wave velocity *in vacuo*, and V' the wave velocity in the prism,

$$\begin{aligned} R H &= V \left(\frac{t}{U} - \frac{t}{V'} \right) \\ &= \frac{V t}{U V'} (V' - U), \end{aligned}$$

and if $\mu = V/V'$ be the refractive index,

$$= \frac{\mu t}{U} (V' - U).$$

Fig. 3.

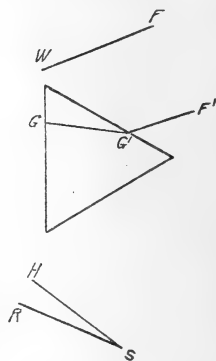

But k being the frequency,

$$\begin{aligned} U &= \frac{dkV'}{dk} \\ &= V' + k \frac{dV'}{dk} \\ &= V' - \lambda \frac{dV'}{d\lambda} = V' + \frac{\lambda}{\mu} V' \frac{d\mu}{d\lambda}. \end{aligned}$$

hence

$$RH = \frac{\lambda V' t d\mu}{U d\lambda}.$$

We may put with sufficient accuracy $V' = U$ in this expression. To observe Talbot's bands, the retarding plate must be brought in on the side of the thin edge of the prism and the best thickness, according to § 1, is that in which that half of the beam which is nearest the thin end of the prism is retarded through half the distance RH . The appropriate thickness is therefore $\frac{\lambda t d\mu}{2 d\lambda}$ in accordance with the results of the previous paragraph.

5. The previous investigation gives the retardation which the plate should produce if the best effect is to be observed. If we wish to determine in an actual case the best thickness of plate, we must remember that as we have been dealing with impulses the group velocity comes into play. Hence the usual expression $(\mu - 1)e$ for the retardation, the thickness being e , is not quite accurate.

If U be the group velocity, and V' the velocity of light *in vacuo*, the retardation in time is $e \left[\frac{1}{U} - \frac{1}{V'} \right]$; this corresponds to a distance in air of

$$e \left[\frac{V'}{U} - 1 \right],$$

or if V be the velocity in the substance of the plate, the retardation is

$$e \left[\mu' \frac{V}{U} - 1 \right],$$

μ' being the refractive index of the material of the retarding plate.

We obtain the right result by adding to $(\mu - 1)e$ the distance through which the group has fallen behind the wave; this corresponds to the quantity RH calculated as above, if for the thickness of the prism we substitute e and write μ'

for the refractive index of the plate. This gives for the retardation

$$e \left(\mu' - 1 - \lambda \frac{d\mu'}{d\lambda} \right),$$

and for the best thickness of the plate this must be equal to $\frac{1}{2}N\lambda$ or $-\frac{1}{2}\lambda t \frac{d\mu}{d\lambda}$ according as a grating or prism is used to produce the spectrum.

6. We are so much accustomed to regard the homogeneous wave as the simplest element into which all wave-motions may be resolved that we sometimes overlook the fact that the phenomena of white light may all be reproduced by a single disturbance of short duration. There are cases, and the phenomenon of Talbot's bands may serve as a conspicuous example, where the consideration of the combined group yields to a simpler treatment than the resolution into homogeneous waves. I have shown in my paper on "Interference Phenomena" how group velocities may be used to determine the conditions of achromatism. Considerations similar to those used in that paper may perhaps be usefully employed to simplify the treatment of achromatized interference-bands.

II. *On the Variation of Entropy as treated by Prof. Willard Gibbs.* By H. A. BUMSTEAD, Ph.D., Assistant Professor of Physics, Yale University*.

IN the August number of the Philosophical Magazine Mr. S. H. Burbury has discussed certain difficulties which present themselves in Chapter XII. of the "Principles of Statistical Mechanics," by the late Prof. J. Willard Gibbs. Unless I have misunderstood Mr. Burbury's statement, I believe these difficulties may be surmounted, and shall endeavour to give, as briefly as possible, my reasons for this belief. For the sake of brevity I shall assume that the reader has Mr. Burbury's paper before him, and shall refrain from quoting from it unless it seems necessary for clearness of statement.

The first difficulty (which may be more conveniently discussed in terms of the hydrodynamical analogue than in terms of the ensemble of systems) is in regard to Prof. Gibbs's statement that "one may perhaps be allowed to say that a finite amount of stirring will not affect the mean square of the density of the colouring matter, but an infinite amount of stirring may be regarded as producing a condition

* Communicated by the Author.

in which the mean square of the density has its minimum value, and the density is uniform." It seems to me that this statement may be justified as follows:—If, after a certain amount of stirring, we should determine the density of the colouring matter in the liquid, using finite elements of volume sufficiently large, we should find the density sensibly constant in the different elements; but if the elements were chosen small enough (but still finite) some of them would be entirely within the coloured portions and some in the uncoloured portions, and the density in such an estimate would no longer appear to be uniform. If now the stirring were continued, a time would come when these smaller elements would all have the same average density, and so on indefinitely; and no system of finite elements, however small, could be assigned in advance in which the average density could not be made the same for all by a sufficient amount of stirring. In other words, if we are allowed to stir as long as we please, we may use elements (in the estimate of density) as small as we please. That this is what Prof. Gibbs means by his somewhat guarded statement about an infinite amount of stirring, seems plain in the light of the preceding paragraphs in which he discusses the effect of altering the order in which limits are taken. This latter consideration was one of which he not infrequently made use; I recall that he once employed it to reconcile conflicting views as to the interpretation of Fourier's series in a discussion which arose in the columns of 'Nature' (vol. lix. p. 200).

Although it seems to me that the statement can be thus justified, I nevertheless must agree with Mr. Burbury that the other way of escaping the difficulty, viz. by defining the density by finite elements of volume (or of extension-in-phase) is preferable. If I understand the matter correctly, this is not because there is anything in the structure of the ensemble of systems corresponding to a molecular structure in the liquid, for a system of n degrees of freedom occupies no finite extension in the $2n$ -fold space in which its possible phases lie; but it is because we are unable, owing to the finiteness of our perceptions, to recognize very small differences of phase, just as we are unable to recognize very small differences of position in the analogous case of the liquid. And it is certainly nearer the truth to base the doctrine of the increase of entropy upon the finiteness of our perceptions rather than upon the infiniteness of time. That this was also Prof. Gibbs' opinion I believe is evidenced by the sentence following the one quoted ("one may perhaps be allowed," &c.) in which he says, "We may certainly say that a sensibly

uniform density of the coloured component may be produced by stirring." And it is really this latter form which he uses when he comes to apply the principle, as in the third paragraph on page 154, in which the qualification, "if very small differences of phase are neglected," is of course equivalent to taking finite elements of extension-in-phase. The infinite time idea was, I believe, introduced merely as an alternative (and not a preferable) way of regarding the subject.

Admitting then the possibility of variation of the density-in-phase D in the finite elements through which a moving system passes, Mr. Burbury finds a difficulty in the definition of η in the expression $D = Ne^\eta$. He says, "so long as η remains constant for the same system, we may define η to be the entropy which that system has. . . . But η being now supposed to be variable for the same system, we require a definition." Here I think the whole trend and spirit of Prof. Gibbs' method has been misapprehended; unless I have mistaken his position, Prof. Gibbs would not have admitted that the η for a single system, although exactly determined, corresponds to what we call entropy in bodies met with in nature. So far as he applies his results to thermodynamics, he regards the bodies of nature as corresponding, not to a definite system, but to a system chosen at random out of a properly distributed ensemble; so that it is certain average properties of the ensemble which we observe experimentally, and not the properties of a single system. The average value of η for the whole ensemble (taken with the negative sign) corresponds to the entropy of any body which the ensemble is capable of representing, and we are no more concerned about the η of a single system (except in so far as a knowledge of it may be necessary to get a correct average) than we are concerned with the exact configuration of the system. But it is evident that we may get a sufficiently close value of the average for the whole ensemble by adding, not the η for every system, but the mean values of η for each one of a set of finite elements of extension-in-phase taken sufficiently small. Thus all we are concerned to know is the mean value of η in an element, and hence the equation $D = Ne^\eta$ may still serve as the definition of η , for all necessary purposes, even though D is no longer the exact density at a point but is the mean density throughout an element. Prof. Gibbs' statement in a succeeding paragraph (p. 148) that η "is an arbitrary function of the phase," which Mr. Burbury takes to be a new definition, is, I think, not a definition at all, but the statement of an assumed initial condition in the particular problem which he is then considering.

It is this problem (p. 148) which gives rise to Mr. Burbury's final difficulty, and which leads him to the conclusion that the hypotheses made by Prof. Gibbs concerning the mechanical systems are not sufficient to serve as a basis of rational thermodynamics. Perhaps I may best show why Prof. Gibbs' conclusions seem to me legitimate by restating his demonstration, as I understand it, in slightly different form and with special reference to the objections which have been brought against it. Let us consider an ensemble of systems not in statistical equilibrium. An ensemble is in statistical equilibrium if, during any interval of time, as many systems enter any fixed element of extension-in-phase as leave it during the same interval; the density-in-phase in any fixed element (finite or infinitesimal) does not change with the time. But when the ensemble is not in statistical equilibrium the density in fixed elements of extension-in-phase will vary with the time, and therefore the value of η associated with a fixed finite element (as explained above) will obviously vary. The question is whether the average value, $\bar{\eta}$, for the whole ensemble, as determined by the use of these elements, will increase or decrease with the time. At a certain initial instant t' let the density be distributed in any arbitrary manner throughout the extension-in-phase, that is, at this instant, we may consider D (or η) to be given as "an arbitrary function of the phase." Later, of course, it will be a function of the phase and of the elapsed time. With this initial distribution given we may now choose a system of fixed finite elements of extension-in-phase, DV , small enough so that the density may be regarded as sensibly constant throughout any one of them. At a later time t'' (unless the motion in phase is of a highly special and relatively improbable kind) the systems which were together in one element at t' will not all be in a single element. Thus some of the systems which were at t' in the element DV' may now be in the element DV'' , but they will have mixed with them systems which, at t' , occupied other elements, DV_1' , DV_2' , &c. If, now, we ascertain the average density in DV'' and take its logarithm (η), thus assuming that η has a constant value for all the systems in the element, we shall, by Theorem IX. of Chapter XI., get a less value than if we took the actual values of η which the separate systems have. But the actual values of η for the separate systems are those which they have brought with them into DV'' , and are the same which they had in their scattered condition in DV_1' , DV_2' , &c. at the instant t' . Therefore the value of η which we have obtained by averaging the density in the element

DV'' at t'' is less than that based on the same systems as they were at t' ; and, as this is true for every element, the average value of η for the whole ensemble so determined is less at t'' than at t' . This diminution in the average is wholly the result of mixing, in the elements, systems each of which preserves a constant value of η . It may be well illustrated by the hydrodynamical case which Prof. Gibbs uses earlier in the same chapter (p. 146), in which a cylindrical mass of liquid is imagined, one sector of 90° being black and the rest white. If it is given a motion of rotation about the axis of the cylinder, in which the angular velocity is any function of the distance from the axis (except in the highly special case when this function is a constant), "the black and white portions would become drawn out into thin ribbons which would be wound spirally about the axis." At any given instant t' we might choose a system of finite elements of volume so small that the density of the black colour in any one would be constant, either unity or zero; but at a later time the same elements would each contain a mixture of black and white, provided of course that the motion continues long enough.

But the chief difficulty is that the analytical demonstration will work either forward or backward in time, as Mr. Burbury points out. Assuming that the motion of the systems, or of the liquid in the illustration, extends backward in time *uninterruptedly*, we shall inevitably come to a prior time, say t_1 , at which the average η in an element is less than at t' , or at which the black and white portions of the liquid are better mixed than at the later epoch. Prof. Gibbs has not overlooked this fact, and has, I think, given the true solution of the difficulty, although so briefly that the true import of his remarks may easily be overlooked. He says (p. 150) "It is to be observed that if the average index of probability $[\bar{\eta}]$ in an ensemble may be said in some sense to have a less value at one time than at another, it is not necessarily priority in time which determines the greater average index. If a distribution, which is not one of statistical equilibrium, should be given for a time t' , and the distribution at an earlier time t'' should be defined as that given by the corresponding phases*, if we increase the interval leaving t' fixed and taking t'' at an earlier and earlier date, the distribution at t'' will in general approach a limiting distribution which is in statistical equilibrium. The determining difference in such cases is that between a definite distribution at a definite time and the

* Italics are mine.

limit of a varying distribution when the moment considered is carried either forward or backward indefinitely.

“ But while the distinction of prior and subsequent events may be immaterial with respect to mathematical fictions, it is quite otherwise with respect to the events of the real world. It should not be forgotten, when our ensembles are chosen to illustrate the probabilities of events in the real world, that while the probabilities of subsequent events may often be determined from the probabilities of prior events, it is rarely the case that probabilities of prior events can be determined from those of subsequent events, for we are rarely justified in excluding the consideration of the antecedent probability of the prior events.”

Let us consider first the rotating cylinder of liquid. It is quite true, if we imagine the motion to be continued backward in time from the instant when we have the black sector according to the same distribution of angular velocity along the radius, that we shall have the black and white portions more and more drawn out into thin ribbons the further back we go. But that there should have been the nice adjustment of distribution of colouring matter and of angular velocity necessary in order that these ribbons should, at a given instant, resolve themselves into the black and white sectors is exceedingly improbable. In all reasonable probability such a distribution is essentially an initial one, that is one produced by outside causes and not by antecedent motion of the same type; as a matter of fact we do not separate liquids by stirring them.

In the same manner the thermodynamic states of natural bodies which correspond to ensembles not in statistical equilibrium are, except in very improbable cases, produced by external causes. In Chapter XIII., in which Prof. Gibbs considers the effects of external influences upon an ensemble of systems, he shows that an ensemble originally in statistical equilibrium will have that equilibrium disturbed by changes in the “ external coordinates.” This is truly an initial state, and thereafter the mean value of η will decrease* as time goes on; that it would also decrease if we supposed the same motions carried back into the past is of no practical importance since that is not the way in which the existing state of things has arisen. An ensemble may unquestionably be arranged, as to distribution and motion, so that its $\bar{\eta}$ shall increase, but only up to a certain time, after which it will decrease; that such a preliminary arrangement should

* It is to be remembered that it is $-\bar{\eta}$ which is analogous to entropy.

fortuitously occur is exceedingly improbable. If there were something like an attraction in phase between systems with the same values of η , some sorting effect might be expected to occur, but scarcely otherwise; and thus, as it appears to me, instead of requiring an assumption to make η decrease, we should require an assumption to keep it from decreasing.

III. *On Deflexions of the Plumb-line in India.* By Rev. O. FISHER, M.A., F.G.S., Hon. Fellow of Jesus College, Cambridge, and of King's College, London*.

EARLY in 1902 I received, kindly sent to me by the author at the suggestion of my friend Mr. Oldham, Superintendent of the Geological Survey of India, a Report on the attraction of the Himalaya Mountains upon the plumb-line in India †. The observed phenomena led the Surveyors to suspect the existence of what they term a hidden chain of excessive density, traversing India from Balasore near the mouth of the Hooghly to Jodhpur in Rajputana, and underlying Manata and Bhopal. The position of this supposed chain is given in chart No. 6 of the Report. It appears however that, if such a chain exists as to cause deflexion of the plumb-line towards it, its presence ought likewise to be betrayed by its influence upon the pendulum; because gravity ought to be locally increased above it.

Now, in the 'Account of the Great Trigonometrical Survey of India' ‡, we learn that there is no escape from the conclusion that there is a more or less marked negative variation of gravity over the whole of the Indian continent. These variations are tabulated in my 'Physics of the Earth's Crust' §, and it appears that there is a slight increase of density at Kalianpur in latitude $24^{\circ} 7'$, which is in the position of the supposed hidden chain, but at the same time there is another nearly of the same amount at Usira in latitude $26^{\circ} 57'$, so that if the one affect the plumb-line the other ought to do so in the same manner. The deficiency in the vibration number calculated for the sea-level, which is due to diminished

* Communicated by the Author.

† By Major S. G. Burrard, R.E., Superintendent of the Trigonometrical Surveys of India. Dehra Dun, 1901.

‡ Calcutta, 1879. By General Walker.

§ 2nd ed. p. 208.

density at the stations in that part of the meridian as compared with Punnae, is :—

| N. latitude. | Station. | Height in feet. | Deficiency in number of vibrations in 24 hours estimated for the sea-level. |
|--------------|-----------|-----------------|---|
| 20° 44' | Badgaon | 1120 | — 1.41 |
| 23 36 | Ahmadpur | 1693 | — 1.76 |
| 24 7 | Kalianpur | 1763 | — 0.98 |
| 24 56 | Pahargarh | 1641 | — 2.96 |
| 26 57 | Usira | 810 | — 0.99 |
| 28 44 | Dataira | 717 | — 1.80 |
| 29 30 | Kaliana | 810 | — 3.53 |
| 29 53 | Nojli | 879 | -- 4.25 |
| 30 19 | Dehra Dun | 2242 | — 6.68 |
| 30 27 | Mussooree | 6920 | — 5.48 |
| 33 15 | Moré | 15406 | --21.19 |

Prefixed to the Report is given a cross-section of outer Himalayan ranges on the meridian of $77^{\circ} 25'$ to the scale of one inch to four miles. This was constructed by Col. St. G. C. Gore, R.E., Surveyor-General of India. It appears from this section that through a distance of 124 miles the summits rise fairly regularly from the plains to the height of 18,000 feet, so that as far as attraction is concerned the outer ranges may be taken to be approximately represented by an inclined plane, whose base is 124 miles, and angle of elevation $1^{\circ} 31' 28''$. Beyond these ranges lies the Tibetan plateau, estimated to be on an average three miles high and 400 miles across. To facilitate calculation I suppose the entire area to be rectangular, and to extend to an equal distance on each side of the meridian of the station. Pratt estimated the area to be equal to that of a circle of radius 335 miles*. This would make the length of the rectangular area about 880 miles. I suppose this mass to have been accumulated

* 'Figure of the Earth,' 4th ed. art. 201.

out of the compression of a crust 25 miles thick, and that by far the greater volume of the crushed-together mass went down into the denser substratum upon which it is supported by isostacy. I take the density of the crust rock to be 2.68 (that of granite), and that of the substratum to be 2.96 (that of basalt). The consequence of this arrangement will be that the "root" of the plateau would dip about 29 miles* into the substratum, and that the root of the inclined plane of the outer ranges would be represented by an inverted plane having an angle of $24^{\circ} 31' 5''$.

Major Burrard has calculated by the method of compartments the deflexions which the mountains might be expected to produce at various stations in the meridian of Kalianpur, and at p. 94 of the Report he has given a table containing an analysis of the calculated deflexions, separating the components of the deflexion due to the Himalaya from those due to other areas. This affords a criterion as to what extent our assumption respecting the form and position of the visible mass represent for our purpose the actual high land. Major Burrard has assumed 2.65 to be the density, while I have taken 2.68, to agree with the value used in 'Physics of the Earth's Crust,' but the discrepancy is immaterial.

My calculations give the deflexions in a direction perpendicular to the range, and not in the meridian, and it is not easy to say what ought to be taken as the inclination of the range to the meridian of Kalianpur. Referring to Mr. Oldham's map of the Himalayas in his 'Geology of India,' it seems as if we may consider it about 45° . Hence the deflexions in the Report being given for the meridian, we may

* This depth assumes exact isostacy. It appears very great, and it might be asked whether a less amount of protrusion of the root into the substratum would not suffice. But the Himalaya Mountains appear to be rising, as is shown by the enormous quantity of detritus which they furnish. This would point to the depth of the root being maintained too great for isostacy rather than too small: indeed, it may extend beyond the foot of the slope and beneath the plains, which are above the sea-level.

"Ever since our great pioneer in Himalayan geology, Mr. Medlicott, first examined and described the sub-Himalaya in his memoir (Mem. Geol. Surv. of I. vol. iii.) and since the Rev. O. Fisher wrote his far-seeing 'Physics of the Earth's Crust,' it has been gradually becoming evident to all who really examine the question in detail, that the Himalaya are and have been in a constant state of change: a state of elevation along the main axis and depression along the mountain foot, with intermediate zones of crushing, crumpling, and over-riding along shear and thrust planes. This is so evident that, if one desired to be very particular, one might say literally that the Himalaya of to-day are not the same as those of yesterday."—Memoirs of the Geological Survey of India, vol. xxvi. by C. S. Middlemiss, p. 285.

multiply our results by the cosine of 45° for the purpose of comparison.

It must be borne in mind that the object of this investigation is one of principle, and that no exact accordance with the results of the Survey is to be expected, because the natural data cannot be presented in a form amenable to mathematical treatment.

The following is a summary of the results of the hypothesis.

At the foot of the slope.

| | |
|--|---------------|
| Deflexion due to the slope | 39.484 |
| " " plateau | 44.396 |
| Total due to the visible masses ... | <u>83.880</u> |
| Negative deflexion due to the root | 68.189 |
| Residual deflexion towards the range | <u>15.691</u> |

At sixty miles from the foot of the slope.

| | |
|--|--------------|
| Deflexion due to the slope | 17.384 |
| " " plateau | 33.006 |
| Total due to the visible masses ... | 50.390 |
| Negative deflexion due to the root | 49.275 |
| Residual deflexion towards the range | <u>1.115</u> |

At 293 miles from the foot of the slope (representing the position of Kalianpur).

| | |
|--|--------------|
| Deflexion due to the slope | 4.234 |
| " " plateau | 14.691 |
| Total due to the visible masses ... | 18.925 |
| Negative deflexion due to the root | 19.110 |
| Residual deflexion away from the range ... | <u>0.185</u> |

In order to discover how nearly the hypothesis made regarding the form, dimensions, and position of the mass taken to represent the mountain, agree with those of the actual highlands as regards their horizontal attraction, we may reduce the deflexions thus obtained to the meridian by multiplying them by cosine 45° , and compare the results with the

meridian deflexions which Major Burrard has calculated that the actual masses of the Himalayas would produce*.

Thus the deflexion $83''\cdot880$ at the foot of the slope, when multiplied by cosine 45° , gives $59''\cdot313$, while Major Burrard's value at Dehra Dun, which is nearly in that position, is $72''$, or $13''$ more.

In like manner the deflexion of $50''\cdot390$ at sixty miles from the foot of the slope, when multiplied by cosine 45° , gives $35''\cdot656$, while Major Burrard's value at Kaliana, which is somewhere near sixty miles from the slope, is $36''$. Lastly, the deflexion $18''\cdot925$ at Kalianpur, when multiplied by cosine 45° , gives $13''\cdot379$, while Major Burrard's calculated value is $18''$.

In each instance the hypothesis makes the meridian deflexion rather too small; but it is obvious that, by taking the trend of the range more nearly east and west, the results would be brought to agree more closely.

The residual result so far is that the hypothesis of exact isostasy causes the attraction of the visible masses to be almost exactly compensated except at places near the foot of the range. This is in accordance with Airy's prediction †. But it is doubtful whether this hypothesis is sufficiently near the truth, because the 'Transcontinental Gravity Measures, U.S.A.', seemed to show that "general continental elevations are compensated by a deficiency of density in the matter below sea-level, but that local topographical irregularities are not compensated for, but are maintained by the partial rigidity of the earth's crust" ‡.

Following up the suggestion made by Mr. Putnam we notice how Mr. Oldham tells us that "the very close resemblance between the upper Sivalik beds and the recent deposits of the Gangetic Plain leaves little room for doubt that the Sivalik beds were deposited subaerially by streams and rivers." "The thickness attained by the Sivalik series is immense. Mr. Wynne estimated it at 14,000 feet in the North-west Punjab. In the Sivalik Hills there are at least 15,000 feet of beds and the series is by no means complete, and similar vast thicknesses may be measured in any section." In Mr. Oldham's diagram (*Man. Geol. India*, p. 473) (fig. 1) he represents the Sivalik strata as lying beneath modern alluvium except at the northern edge where they have been disturbed and elevated into the sub-Himalayan Sivalik range. Following the above description, we may assume a layer of rock of some-

* Report, tab. x. p. 94.

† *Phil. Trans.* vol cxlv. p. 102.

‡ G. R. Putnam. *Phil. Soc. Bulletin*, Washington, U.S.A., vol. xiii.

what less than crust density three miles thick where it abuts on the foot of the Himalayan slope, and thinning out to nothing against the trappean area. It will be observed that a pile

Fig. 1.

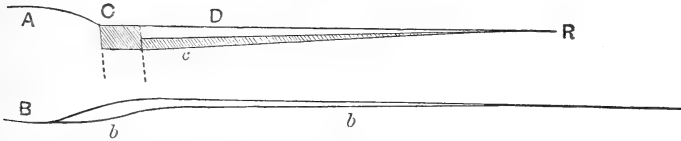

“Diagram to illustrate the theory of the elevation of the Himalayas corresponding to the right-hand half of fig. 26 (copied from ‘Physics of the Earth’s Crust’). Horizontal scale about 60 miles, vertical about 30 miles to one inch. [This makes the crust much thinner than assumed in P. E. C.]

- A. Massif of the Himalayas.
- B. Root of the same.
- C. Earlier marginal deposits compressed and elevated.
- c. Continuation of the same, depressed and undisturbed.
- D. Subsequent deposits overlapping C.
- b. Sinking of lower surface of crust due to C and D.”*

of rock three miles thick above the surface of the sphere would reach an altitude equal to that of the Tibetan plateau, but the Gangetic plains do not rise to as much as a thousand feet above the sea-level, and the recent alluvium has to be allowed for. The conclusion is that the crust of the earth must be depressed 15,000 feet at least into the substratum at the foot of the Himalayan slope. We need, therefore, to calculate the effect of this arrangement upon the plumb-line.

According to the present hypothesis, the Himalayas and Tibetan plateau are not supported solely by the root immediately beneath them, but partly by the depressed crust beneath the Sivalik rock of the plains. It follows that for isostasy the root of the plateau and slope will not need to be quite so deep; but since the difference will be small, it will be legitimate to consider the attraction of the diminished root to bear to the attraction of the hitherto considered root the proportion of their masses, *i. e.*, the proportion of their depths below the bottom of the crust, which we must calculate. In doing this we may take the height of the plains above the sea-level as compensating their presumable defect of density from that of the general crust.

The width of the alluvium, where the meridian of Dehra Dun in Mr. Oldham’s geological map crosses its boundary, appears to be about 230 miles. This will give for the base

* ‘Manual of the Geology of India,’ 2nd ed., Calcutta, 1893, p. 473.

of the Sivalik beds an inverted inclined plane, whose depth is three miles and length 230. If we apply the principle of *general isostasy* to half of the area we are dealing with, that

Fig. 2.

Modification of Mr. Oldham's diagram to suit the present hypothesis.

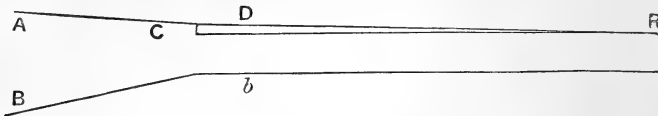

Scale about 105 miles to an inch.

- A. Slope of the Himalayas, including the marginal deposit C of Mr. Oldham's diagram.
- B. Root of the same.
- D. Sivaliks undisturbed and covered by subsequent deposits.
- b. Sunken lower surface of the crust contributing to the general support of half the highlands according to Mr. Putnam's theory.

is from the middle of the Tibetan plateau to the further edge of the alluvial deposit 230 miles from the foot of the slope, we find that the depth of the root of the plateau will be diminished by one mile and three tenths. The attractions of the visible masses and the crust will of course remain as before, but the negative attraction of the root will be diminished by 0.045 of its amount, and by so much will the attraction towards the range at any station be approximately increased. This will raise the attraction of the plateau and slope with their roots

at the foot of the slope to $18''\cdot757$,

at 60 miles from the foot of the slope to $3''\cdot212$,

at 293 miles it will convert the deflexion of $0''\cdot186$ away from the range into one of $0''\cdot628$ towards it.

These are not the final results, because the deflexions due to the area of the Gangetic plain have yet to be considered and added to them.

The estimates just made of the structure and dimensions of the Gangetic plain, assumed to be rectangular, and of the depression of the coast beneath it into the substratum, when submitted to calculation yield the following results.

Where the plain abuts upon the foot of the Himalayan slope it will cause a deflexion of $5''\cdot009$ towards it.

At 60 miles from the foot of the slope there will be a deflexion of $1''\cdot352$ away from the range.

At the extreme edge of the plain, where it abuts on the

trappean area, it will produce a deflexion of 3''·006 away from the range.

Combining these results with those previously obtained, the deflexion at the foot of the slope of 18''·759 is now raised to 23''·768. At 60 miles from the range, the deflexion of 3''·212 towards it will be reduced to 1''·857 towards it. At the edge of the plain the deflexion, which was 0''·682 towards the range, will now be 2''·324 away from it; and at greater distances will still be away from the range in a decreasing ratio.

Thus the hypothesis of general isostasy of the Himalayan area and Gangetic plain combined, gives a considerable deflexion northward at the foot of the range; at some distance beyond 60 miles the deflexion disappears, while further towards the edge of the plain—towards Kalianpur—the deflexion becomes southerly, and so continues till it disappears.

The extreme difference of the deflexions at the northern and southern edges of the plain will thus be about 26'', and in the meridian 20''. In the table following p. 14 of the Report it is, in the meridian of Kalianpur, about 30'', as observed*.

It is obvious that the dense rock of the Deccan will tend to intensify the southerly deflexion on the southern edge of the plain, and that, in general, irregularities in the geological structure of the country buried beneath the post-eocene deposits will be responded to by irregularities in the deflexion of the plumb-line. That this must occur appears from the table, where, in the column of deflexions, there are irregularities over the plain which seem inexplicable in any other way.

Nevertheless, on the whole the trend of the deflexions from

* The following is taken from the above table. N signifying a northern and S a southern deflexion as referred to Kalianpur.

| | N. lat. | Deflexion. | | N. lat. | Deflexion. |
|--------------------|---------|------------|-----------------|---------|------------|
| Banog | 30 28 | 33''04 N | Noh | 27 51 | 0''26 N |
| Mussooree | 30 27 | 36''84 N | Agra | 27 10 | 5''72 N |
| Rajpoor | 30 24 | 47''65 N | Usira | 26 57 | 6''03 N |
| Amsot | 30 22 | 29''15 N | Kesri | 25 46 | 5''45 S |
| Dehra Dun | 30 19 | 37''82 N | Pahargarh | 24 56 | 0''76 N |
| E. end ditto, base | 30 17 | 30''37 N | Daiadhari | 24 38 | 1''01 S |
| Nojli | 29 53 | 13''95 N | Surantal | 24 14 | 0''82 S |
| Kaliana | 29 31 | 7''03 N | Sironj | 24 9 | 1''69 S |
| Dataira | 28 44 | 6''13 N | Bhaorass | 24 8 | 1''17 S |
| Bostan | 28 31 | 5''67 N | Kalianpur | 24 7 | 0''0 |
| Chanlaos | 28 5 | 1''16 N | | | |

the foot of the slope to the southern edge of the plain in the meridian of Kalianpur is fairly well accounted for by the hypothesis of general isostasy of the area as a whole.

It must be remembered that certain gratuitous hypotheses have been made, which will affect the quantitative, though not the qualitative, results of this investigation. Such are the relative densities of the crust and substratum and the thickness of the crust. But the quantitative agreement of the results with the observed facts shows that the assumptions made are not very improbable.

Addendum.

The above calculations have been made on the hypothesis that the "cross-section of the outer Himalayan Ranges," prefixed to the Report, had been taken at right angles to their direction, whereas it is really on the *meridian* of $77^{\circ} 25'$. According to the maps, the range in this meridian appears to be inclined at about 40° to the prime vertical. Since then the length of the meridian cross-section is 124 miles, the section perpendicular to the range will be about 95 miles. On this more correct hypothesis I have recalculated the deflexion at the foot of the range.

The deflexion at 60 miles distance from it might be similarly recalculated, if thought desirable.

The deflexion due to the plains will not be altered.

The deflexions which follow are referred to the meridian, and therefore are immediately comparable with those given in the table following p. 14 of Major Burrard's Report.

The meridian deflexion at the foot of the slope, due to the slope and plateau, recalculated on the present hypothesis, is $70''\cdot254$, whereas Major Burrard's estimate, as already mentioned, is $72''$. This shows that the hypothesis nearly reproduces the correct attraction.

The negative meridian deflexion at the foot of the slope, due to the roots of the slope and plateau, will be $53''\cdot446$; leaving a balance of $18''\cdot348$ northward at the foot of the slope. Add to this a meridian deflexion northward due to the plains of $3''\cdot830$, and we have on the whole $22''\cdot178$ northward at the foot of the slope. The southern deflexion in the meridian at the further edge of the plains is $1''\cdot776$. Hence the total difference of meridian deflexion at the foot of the slope, as compared with that at the edge of the plains, is $23''\cdot954$. The observed difference, as already stated, is about $30''$. A closer agreement could hardly be expected; some of the discrepancy being due to the assumptions regarding the magnitude and form of the highlands, which,

as we have seen, gives the attraction of the visible masses rather too little.

Where the outer ranges rise from the plains more abruptly, and their trend is more nearly east and west, it is evident that the meridian deflexion at their foot will be increased.

The numerical calculations have been tedious. I have happily been able to obtain the help of A. R. Hinks, Esq., M.A., chief assistant, and of Miss Bell of Girton College, computer, at the Cambridge Observatory. They have verified my formulæ and corrected the numerical results, and to them my best thanks are due.

MATHEMATICAL NOTES.

I.—Attraction of the Mountains.

The diagram (fig. 3) represents a section perpendicular to the range. It is drawn approximately on a scale of $\frac{1}{10}$ of an inch to 5 miles. K M C F B is the crust, out of which the

Fig. 3.

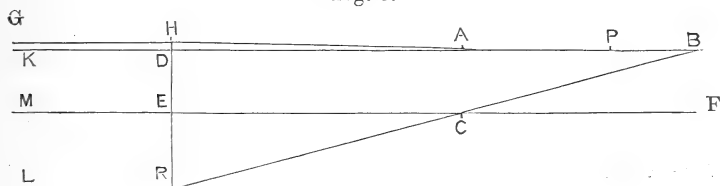

mountains and their roots were formed, and is supposed to be 25 miles thick. G H D K is the Tibetan plateau, three miles high and 400 miles across. D A H is the slope of the mountains, A D being 124 miles. D H is 3.3 miles. M L R E is the root of the plateau. E R equals 28.71 miles. E R C is the root of the slope.

We require to find the horizontal attraction at a station P on the surface of the crust. P may be either to the right or left of B. Sphericity is neglected. Then the horizontal attraction of the mountain and root together at P equals the horizontal attraction positive of the slope, *plus* that of the plateau, combined with the horizontal attraction negative produced by the substitution of their less dense roots for the more dense substratum. The crust, whether disturbed or not, will produce no horizontal attraction. The negative attraction of the root will be the same in amount as if the root was composed of matter whose density was equal to

the excess of the density of the substratum over that of the crust, and the attraction of the root *MLRC* at *P* will be the same as would be produced by a mass *KLR CB minus* that which would be produced by a mass *KMCB*, each mass being of similar density. Consequently we need to calculate these several attractions. The attraction having been calculated from the formulæ, the corresponding deflexion may be found by multiplying it by a factor whose logarithm is 0.3541084*.

$$\left. \begin{aligned} \text{Attraction} \\ \text{of the slope} \end{aligned} \right\} = 2\rho \left\{ (a \pm p \cos^2 \alpha) \tan^{-1} \left(\frac{a}{a \pm p} \tan \alpha \right) \right. \\ \left. \mp \frac{p}{2} \sin \alpha \cos \alpha \log_e \left(1 + \frac{a(a \pm 2p \cos^2 \alpha)}{p^2 \cos^2 \alpha} \right) \right. \\ \left. - \frac{ha}{2l^2} \left(\frac{a}{3} \pm \frac{p}{2} \right) \right\}.$$

The upper or lower sign is to be used according as the attracted particle *P* is to the right or left of the foot of the slope under consideration.

$$\left. \begin{aligned} \text{Attraction of} \\ \text{the plateau} \end{aligned} \right\} = 2\rho \left\{ \tan^{-1} \frac{lh}{xv} - \frac{h}{2} \log_e \frac{v+l}{v-l} - \frac{l}{2} \log_e \frac{v+h}{v-h} \right\} + \text{const.}$$

The limits of x are the nearest and furthest distances of the base of the plateau from the station *P*, viz. *PD* and *PD* + 400.

$v = \sqrt{l^2 + h^2 + x^2}$ and its limits depend upon those of x .

The unit of length is a mile.

$2l$ is the length of the range = 880.

(1) When the attraction of the slope *HDA* is required :

$$\rho = 2.68.$$

$$a = DA = 124 \text{ miles } \dagger.$$

$$h = 3.3 \text{ miles.}$$

$$\tan \alpha = \frac{HD}{DA} = \frac{h}{a} = \frac{3.3}{124}.$$

$$l = 440.$$

p is the distance from the foot of the slope *A* of the station where the attraction is required.

* See Clarke's 'Geodesy,' p. 296.

† Observe: In the Addendum *DA* is taken at 95 miles.

(2) When the attraction of DRB is required :

$$DE = 25.$$

$$\rho = 2.96 - 2.68 = 0.28.$$

$$h = ER = 28.71.$$

$$\tan \alpha = \tan ECR = \frac{ER}{DA} = \frac{28.71}{124}.$$

$$a = AD + AB = 124 + DE \cot \alpha = 222.145.$$

p is the distance from B of the station.

(3) When the attraction of ACB is required :

$$\rho = 0.28.$$

$$\tan \alpha = \frac{28.71}{124}.$$

$$a = 25 \cot \alpha = 98.145.$$

$$h = 53.71.$$

p is the distance from B of the station.

II.—Attraction of the Plain.

Referring to figure 2,

Let a be the width of the plain $DR = 230$ miles.

k the thickness of the crust = 25 miles.

p the distance from the southern edge of the plain of a station P where the deflexion is required.

ρ the difference of the densities of the crust and the substratum = 0.28.

m the tangent of the angle at which the under side of the crust is depressed into the substratum = $3/230$.

l the length of the area supposed rectangular, and conterminous with the mountain range.

Then the attraction of the plain at P may be found from the following formula, it being premised that the attraction so obtained will be a negative attraction, due to the displacement of the dense substratum by the lighter crust thrust down into it. Consequently negative results will indicate deflexions towards R the southern edge of the plain, and positive ones deflexions towards C the foot of the slope of the Himalayas.

Attraction of $\left\{ \begin{array}{l} \text{the plain} \end{array} \right\} =$

$$2\rho \left\{ a \tan^{-1} \frac{ma(a-p)}{(a-p)^2 + k(k+ma)} - \frac{mk-p}{1+m^2} \tan^{-1} \frac{a(mp+k)}{(p^2+k^2) + (mk-p)a} \right. \\ \left. - \frac{ak}{p k^2 - p(a-p)} + \frac{mp+k}{1+m^2} \frac{1}{2} \log_e \left(\frac{a(a(1+m^2) + 2(mk-p))}{p^2+k^2} + 1 \right) \right. \\ \left. - \frac{k}{2} \log_e \frac{(a-p)^2 + k^2}{p^2+k^2} - \frac{ma^2}{2l^2} \left(\frac{a}{3} - \frac{p}{2} \right) \right\}.$$

IV. *A Study of the Selenium Cell.* By A. H. PFUND*.

THE theory accepted to-day in explanation of the fact that a selenium cell changes its resistance when exposed to radiation, is due to Bidwell. Briefly, this theory attributes the sensibility of a cell to the presence of selenides from which selenium apparently never is free. The facts in support of this view are:—

1. The conduction of a cell is electrolytic in character †.
2. Selenium is a very poor conductor, while a selenide is, comparatively, a good one.
3. Sunlight actually brings about a combination of metal and selenium, forming a stable selenide, capable of conducting an electric current ‡.

In enlarging upon his theory, Bidwell § says:—“If, as is commonly believed, electrolytic conduction involves a series of decompositions and recompositions throughout the electrolyte, any cause which will assist either the separation or recombination (or both) of the components of the electrolyte might be expected to increase its conductivity; and it seems reasonable to suppose that the same influence which would assist the union of two substances when they have a tendency to unite would also be favourable to their separation when they have a tendency to separate. It is not impossible, therefore, that radiation, acting upon the surface of a thin layer of selenide of silver through which an electric current is passing, might, by facilitating the molecular rearrangement of the atoms of selenium and silver, exert a material influence upon the conductivity.”

As, in the above theory, the phenomenon is ascribed entirely to the selenide, it seemed worthy of interest to undertake experiments with cells containing different selenides. In the course of the work it soon appeared that the sensibility of the selenium cell reaches a maximum in the visible spectrum, and it was thought that the position of the maximum might be a function of the metal in the selenide. While it is possible, it is hardly probable, that light from the same region of the spectrum which is most favourable to the combination between copper and selenium, will also be most favourable to the combination between mercury, silver, lead, and other metals with selenium.

Furthermore, in consequence of Bidwell's statement that

* Communicated by Prof. Benjamin W. Snow.

† Adams and Day, Proc. Roy. Soc. 1876, p. 113.

‡ Shelford Bidwell, Phil. Mag. vol. xl. p. 233 (1895).

§ Shelford Bidwell, Phil. Mag. vol. xx. p. 191 (1885).

light produces an increase in the conductivity of a cell by facilitating the molecular rearrangement in the surface-layer of a selenide through which an electric current is passing, the question has presented itself, does the resistance of a cell undergo changes if it be exposed to light while no current is flowing?

Selenium.

It appears that, in spite of the most painstaking efforts, selenium cannot be obtained absolutely pure, although the process of purification may be carried to so high a degree as to make the amount of impurity still present very small indeed. As a preliminary series of experiments, cells were made with metallic electrodes and of crude selenium to which definite selenides had been added; these cells were subjected to light from various portions of the spectrum and the position of maximum sensibility was determined for each. It appeared that the position of the maximum was the same for all cells. On account of the impurity of the selenium some doubt was cast upon the trustworthiness of the results and it was thought advisable to repeat the experiments with purified selenium. As distillation does not effectively remove impurities, a chemical method* was resorted to. I wish to take this opportunity of acknowledging my indebtedness to Professor Victor Lehner, of the Department of Chemistry, for the details of this process, which yielded selenium of great excellence and purity. Briefly the method is as follows:—

Commercial selenium is dissolved in hot nitric acid and the resulting selenious acid is evaporated to hard dryness when the dioxide is formed. This is dissolved in distilled water and barium hydrate is added until a permanent precipitate is no longer formed. After filtering, the solution is boiled to dryness in an evaporating-dish, and the residue is covered by an inverted funnel whose base fits snugly upon the inside of the evaporating-dish. Continued heating brings about a sublimation of the dioxide upon the inner walls of the funnel in the form of white needles. As the slightest amount of impurity imparts to the selenium dioxide a reddish colour, it is necessary to repeat the process of sublimation until pure white needles are obtained. These are dissolved in distilled water, the solution is acidified with hydrochloric acid and acid sodium sulphite is added, bringing about a liberation of sulphur dioxide, which in turn precipitates the selenium in the form of a red powder. By boiling the mass for a few minutes the selenium forms into a hard black lump which, when washed and dried, is ready for use.

* Victor Lehner, *Journal Am. Chem. Soc.* vol. xx. no. 8.

Selenium prepared in this manner is deemed sufficiently pure for atomic and molecular weight determinations.

Selenium Cell.

A departure was made from the usual manner of making selenium cells in that carbon electrodes were used in place of metallic electrodes. The reason for this is, that when metallic electrodes are used a selenide is formed wherever metal and selenium come in contact, the amount formed being dependent upon the character of the metal and the length of time during which the cell is subjected to heat. The difficulty of knowing the exact amount of selenide in such a cell is obvious. As actual tests have proved that no conducting compound is formed when selenium is heated in contact with a carbon surface, it was thought that by using carbon electrodes the above difficulty would be avoided, or, in other words, that it would be possible to know the exact amount of selenide contained in a completed cell. Furthermore, when electrodes of silver and mercury are used, the strong affinity of these metals for selenium brings about such a copious formation of selenide that, after a few minutes of heating, the cell becomes worthless. The use of carbon electrodes overcomes this difficulty entirely.

Fig. 1.

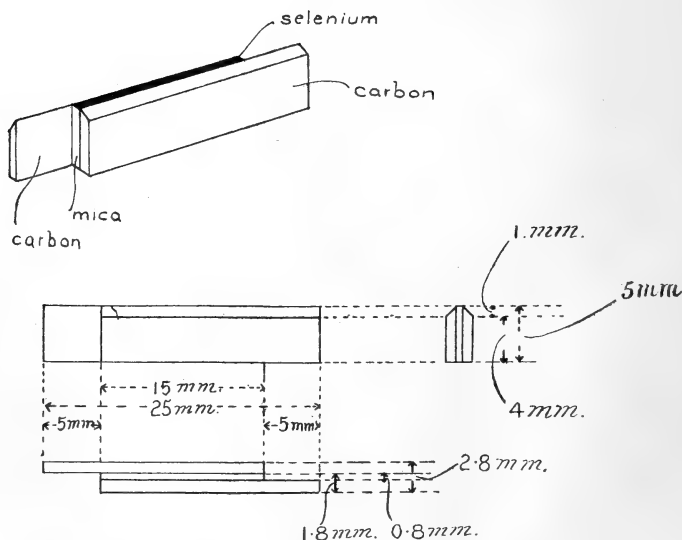

The above sketch (fig. 1) represents a full-sized selenium cell as actually used in these experiments. Two small

slabs of Atchison graphite, an especially pure form, were separated by a layer of mica, securely bound and shellacked together and then baked so as to form a compact mass. While the cell was still hot a very thin layer of molten selenium was spread over one side, as shown in the diagram. In the average the selenium layer was 15 mms. long, 1 mm. wide, and 0.08 mm. thick. Before being applied to the cell the selenium had been ground up to a fine powder in an agate mortar with 3 per cent. of a definite selenide*, for this proportion of selenide in selenium, as shown by Bidwell †, is approximately that necessary to develop the highest sensibility in a cell. The selenides of copper, lead, mercury, and silver were used for the reason that they form with great readiness and conduct electricity well.

The details followed out in the process of forming and annealing were similar to those described by Bidwell ‡, and, in general, this procedure yielded cells of fair, though not excessive sensibility. In the average a cell had a resistance of about 20 megohms, and, when new, increased its conductivity from three to twelve times upon being illuminated by a 32 candle-power incandescent lamp at a distance of 30 cms.

Apparatus.

The spectrometer was of the usual fixed-arm type, designed for work in the visible and infra-red spectrum.

Light from a Nernst lamp L (fig. 2) was dispersed by a rock-salt prism P, the resulting spectrum being brought to a focus on a brass plate B which contained a vertical slit. By rotating the prism, light of any desired wave-length could be made to pass through the slit. Directly behind this a Rubens thermopile, T, and a selenium cell, S, were rigidly mounted on a vertical bar, pivoted near its lower end and working between stops so that the selenium cell and thermopile could be mutually interchanged in position. By the use of the slit at B there is no question but that light from the same region of the spectrum which fell upon the thermopile would also illuminate the selenium cell, thus avoiding numerous complications which are certain to arise if the one instrument does not replace the other with absolute exactness. K is a device placed in the path of the parallel beam to cut down the intensity of the energy. While a rotating sector would have

* Obtained from Dr. Theodor Schuckhardt.

† Shelford Bidwell, *Phil. Mag.* vol. xl. p. 233 (1895).

‡ *Ibid.*

answered just as well, this device was chosen on account of its simplicity and ease of manipulation.

Fig. 2.

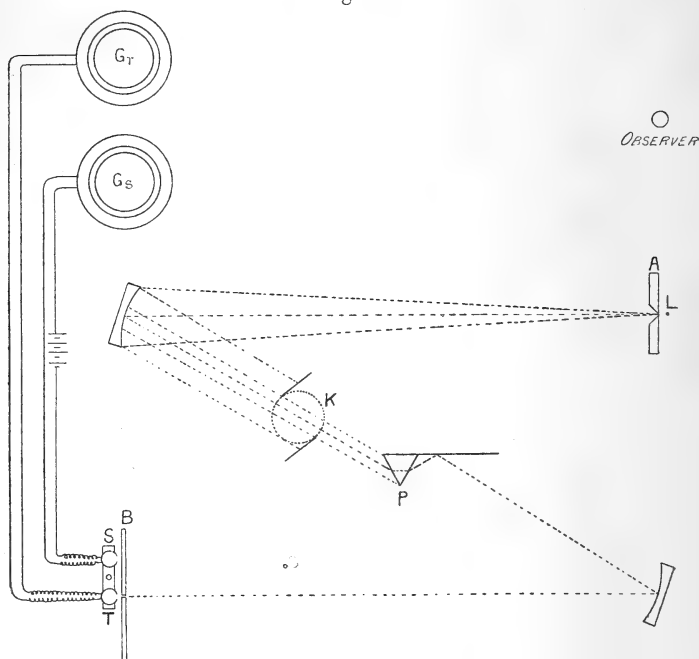

The galvanometer, G_T , connected to the thermopile was of the four-coil Thomson type, being of low resistance and high sensibility; the other galvanometer, G_S , connected to the selenium cell was of the same type, but had a higher resistance and lower sensibility. Both were effectively shielded against magnetic disturbances by three concentric cylinders of soft iron.

On account of the large number of readings which must be taken in a work of this character, the changes in resistance of a cell were determined by using a method of direct deflection rather than by using the Wheatstone's bridge. Although the data recorded are percentage-change in conductivity, the absolute value of this change in ohms may be determined readily as the initial dark resistance of a cell is always given.

The specific nature of a cell determined the method of procedure which was to be used in the measurements of resistance, for the difference between various cells was quite

marked. Not only were cells containing pure selenium much more sensitive than those containing impure selenium, but also more steady and prompt in action. The latter, when exposed, required considerable time to reach a constant resistance, as was shown by the fact that the galvanometer would creep for half a minute or more before finally coming to rest. It was quite impossible to obtain concordant results by exposing the cell until creeping had ceased. However, readings agreeing within about 3 per cent. were obtained by exposing the slit at A automatically for 2.5 seconds and recording the maximum ballistic throw of the galvanometer. When a cell containing pure selenium was exposed to radiation, the spot of light of the galvanometer rapidly moved to a position of steady deflexion, which it maintained for a short time; however, if the exposure continued, creeping would set in. As the actual amount of creeping was small in comparison with the first deflexion, this additional deflexion due to creeping was left out of consideration in taking measurements. Another very important reason why this should be done is that, while an exposure of less than 3 seconds was required to bring about the first deflexion, it became necessary to prolong this exposure eight or ten times until the creeping had ceased. When a cell thus exposed was again returned to darkness, it would take five minutes or more for the resistance to reach its original value and occasionally a permanent change in resistance would have been produced. In view of these facts an exposure of two to three seconds was given, just long enough to obtain the first deflexion. By proceeding in this manner, the uncertainty of creeping was eliminated and the cell would return to its original resistance in less than one minute.

Measurements.

In determining the selective action of a selenium cell in different portions of the spectrum, the conductivity of the cell in darkness and its change in conductivity upon exposure to radiation were measured. By the ratio of the latter to the former of these two quantities, I wish to define the term "sensibility." As it is the purpose to measure the *selective* action of a cell, it is, of course, necessary that the energy of radiation falling upon the cell at different times be the same; in other words, in the final plotting of results the only two permissible variables are *sensibility* and *wave-length*: energy must be constant.

The actual procedure in obtaining results was the following:—The thermopile T (fig. 2) was brought into position

behind slit B and exposed to visible radiation; and the deflexion of galvanometer G_T was recorded. Then the selenium cell was brought into position and exposed; the reading which its galvanometer G_S indicated was also recorded. Having rotated the prism slightly, so that light of greater wave-length passed through the slit, the thermopile was replaced, and upon exposure was found to give rise to a larger galvanometer-deflexion than before. Now by means of the device at K the intensity of the light was cut down to such an extent that the galvanometer G_T indicated the same reading as at first. This meant that, though the wave-length had been changed, the energy was still the same. The selenium cell was again brought into position and exposed, and the deflexion of its galvanometer was observed. The width of the slit at A was changed at intervals to approach more nearly the condition of equal purity of spectrum, although it did not matter much in the final results whether this precaution was taken or not.

The results are given in Table I. (p. 33) and are plotted in fig. 3.

Fig. 3.

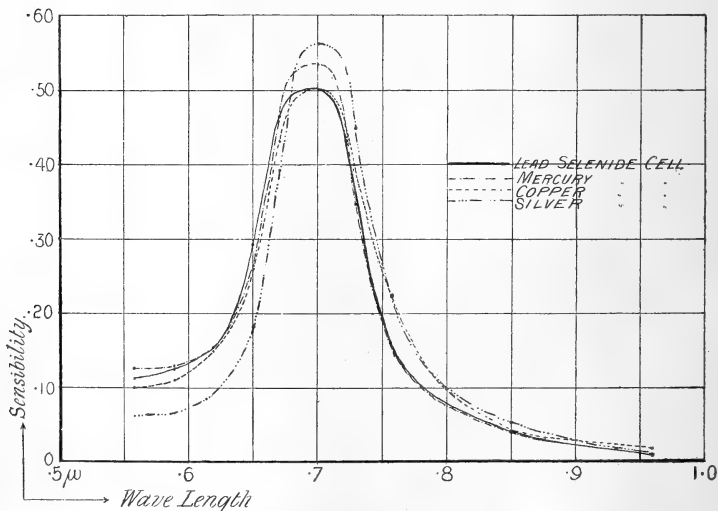

Discussion of Results.

When the first sensibility curve had been obtained, it was thought that the prominent maximum (near 0.7μ) might be a function of the metal contained in the selenide. In consequence, cells with electrodes of tin, nickel, copper, lead,

TABLE I.

| Copper-Selenium Cell. E.M.F. 12 volts; Res. = 2.3×10^6 ohms. | | | | Mercury-Selenium Cell. E.M.F. 8 volts; Res. = 2.2×10^6 ohms. | | | | Lead-Selenium Cell. E.M.F. 4 volts; Res. = 8.5×10^6 ohms. | | | | Silver-Selenium Cell. E.M.F. 4 volts; Res. = 1.3×10^6 ohms. | | | |
|---|-------------------------------|---|-------------------------|---|---|-------------------------|-------------------------------|--|-------------------------|-------------------------------|---|--|-------------------------------|---|-------------------------|
| A. Wave-length. | A. Galv. cell, in dark. | B. Increased Galv. cell, exposed. | B A. Sensibility. | A. Galv. cell, in dark. | B. Increased Galv. cell, exposed. | B A. Sensibility. | A. Galv. cell, in dark. | B. Increased Galv. cell, exposed. | B A. Sensibility. | A. Galv. cell, in dark. | B. Increased Galv. cell, exposed. | B A. Sensibility. | A. Galv. cell, in dark. | B. Increased Galv. cell, exposed. | B A. Sensibility. |
| μ . | mms. | mms. | | mms. | mms. | | mms. | mms. | | mms. | mms. | | mms. | mms. | |
| .56 | 260 | 26 | .10 | 180 | 22 | .12 | 220 | 24 | .11 | 150 | 33 | .22* | | | |
| .59 | " | 29 | .11 | " | 23 | .13 | " | 26 | .12 | " | 37 | .25* | | | |
| .62 | " | 39 | .15 | " | 27 | .15 | " | 35 | .16 | " | 55 | .37* | | | |
| .65 | " | 67 | .26 | " | 47 | .26 | " | 63 | .29 | " | 107 | .71* | | | |
| .67 | " | 112 | .43 | " | 85 | .47 | " | 102 | .46 | " | 230 | 1.53* | | | |
| .70 | " | 130 | .50 | " | 95 | .53 | " | 111 | .50 | " | 340 | 2.27* | | | |
| .73 | " | 101 | .39 | " | 61 | .34 | " | 74 | .34 | " | 270 | 1.80* | | | |
| .76 | " | 60 | .23 | " | 26 | .14 | " | 30 | .14 | " | 125 | .83* | | | |
| .85 | " | 10 | .04 | " | 6 | .04 | " | 8 | .04 | " | 30 | .20* | | | |
| .96 | " | 5 | .02 | " | 4 | .02 | " | 3 | .01 | " | 12 | .08* | | | |
| 1.28 | " | 0 | .00 | " | 1 | .00 | " | 1 | .00 | " | 2 | .01 | | | |
| 2.35 | " | 0 | .00 | " | 0 | .00 | " | 0 | .00 | " | 0 | .00 | | | |
| 3.98 | " | 0 | .00 | " | 0 | .00 | " | 0 | .00 | " | 0 | .00 | | | |

* In the final plotting of results these quantities, as ordinates, were given but one-fourth of their full value.

zinc, and iron were made; but upon investigation it was found that the maximum had not been shifted. Thinking that some impurity, always present, was the cause of this, I purified the selenium chemically, added selenides of copper, silver, mercury, lead, and used carbon electrodes. However, the maximum of the curve was not shifted. In these experiments the only substance present in every case was selenium, and it appears to me that, after all, this is probably the determining factor rather than the selenide. In view of the fact that the amount of selenide added to the cell was approximately that necessary to produce highest sensibility, the conditions favourable to a shift in the maximum could not have been better. The persistence of the maximum in the same position indicates that the nature of the metal in the selenide does not control the selective sensibility of the cell.

Any attempt to couple this phenomenon with the optical properties of amorphous selenium has thus far been unsuccessful. As far as the reflecting and transmitting power of selenium is concerned, the facts are that a very thin layer of amorphous selenium, which is practically opaque to violet and ultra-violet rays, transmits red and infra-red rays with great readiness, and has no absorption-band in the region of maximum sensibility of the selenium cell. The reflecting power is at a maximum in the greenish yellow, decreasing gradually with light of increasing wave-length. These results do not seem to warrant the forming of any definite conclusions. However, as we are dealing not with amorphous but with metallic selenium, and as we know but very little about the latter, the question must be considered as still open.

While it is difficult to determine the optical constants of amorphous selenium, it is doubly so to make similar determinations for metallic selenium. For example, an attempt was made to convert a film of selenium which had been deposited upon glass by cathode discharge, into the metallic modification. Originally the film had a pale orange colour, being perhaps less than the wave-length of violet light in thickness, but during conversion it lost its colour, appearing finally as a uniform dark grey film, which permitted but little light to pass through. A film, thicker than the first but still easily transparent to red light, was also converted into the metallic modification, with the result that it had become absolutely opaque, had received numerous cracks, and had drawn itself away from the glass completely. However, by pressing out some molten selenium between two glass

plates into a layer about 1 mm. in thickness, and converting this into the metallic modification, excellent reflecting surfaces may be obtained. By employing the katoptric method of obtaining the angle of maximum polarization, it ought to be possible to determine values of n and k (refraction and extinction coefficients) through a considerable range, and thus to determine whether the anticipated relationship exists or not.

Mode of Action of the Selenium Cell.

It is the purpose of this part of the work to gain some slight insight into the molecular mechanism called into play when a cell changes its resistance upon exposure to light. The problem was attacked by investigating whether the flowing of an electric current is essential to the development of sensibility in a selenium cell.

The following experiment was performed to decide whether light in falling upon a cell produced some conducting compound, and whether the current eventually decomposed this compound, bringing the resistance of the cell back to its original value. A selenium cell, in circuit with two dry batteries, galvanometer, and key, was exposed to the light of an incandescent lamp for 15 seconds, which gave rise to a large deflexion of the galvanometer. When the light was extinguished, the galvanometer-needle returned to its original position, requiring 65 seconds to do so. For the second part of the experiment the circuit was broken, so that no current was flowing through the cell, and again an exposure of 15 seconds was given. When the circuit was closed 65 seconds later, it was found that the resistance of the cell was the same as in the beginning.

If a stable, conducting compound had been formed in the second case, its presence would have been detected upon closing the circuit by giving rise to a galvanometer deflexion greater than the original one which corresponded to the resistance of the cell in darkness. It is possible to account for the above negative result by assuming either that nothing occurs in a cell unless an electric current is flowing, or that an unstable condition is set up which breaks down of its own accord in darkness. An experiment, based upon the following consideration, was undertaken to clear up this point.

When a cell is taken from light into darkness its conductivity falls off rapidly at first, and more slowly afterwards. If changes in resistance do actually occur while no current is flowing, they ought to be observable by exposing a cell on open circuit to light for perhaps 30 seconds, and then closing

the circuit immediately after extinguishing the light. If no changes had occurred, the galvanometer would indicate a deflexion corresponding to the former resistance of a cell in darkness: but, if a change had occurred, the galvanometer would indicate a larger deflexion, and would gradually settle back to its original position. As a preliminary experiment bore out these conjectures so admirably, an exact determination was undertaken.

A new cell was made and, upon *closed circuit*, was exposed to light for 30 seconds. The galvanometer-needle, upon extinction of the light, moved gradually towards its original position and, at definite time-intervals, readings of the galvanometer were taken. Then, *with the circuit open*, the cell was again exposed for 30 seconds, and, at the same intervals as before (after turning off the light), the circuit was closed for an instant, just long enough for the galvanometer needle to come to rest so as to obtain a reading. An inspection of the following Table II. and fig. 4 shows that, at corresponding intervals of time, the cell had the same resistance whether a current had been flowing during the time of exposure or not.

TABLE II.

| Circuit closed during the exposure of 30 seconds. | | Circuit open during the exposure of 30 seconds. | |
|---|-------|---|--------------------------|
| Time. | | Galvanometer deflexions. | Galvanometer deflexions. |
| min. | secs. | mms. | mms. |
| | 0 | 205 | 0 |
| | 30 | 390 | 0 |
| 1 | 00 | 240 | 239 |
| | 15 | 236 | 0 |
| 2 | 00 | 230 | 229 |
| | 30 | 227 | 0 |
| 3 | 00 | 224 | 223 |
| | 30 | 221 | 0 |
| 4 | 00 | 219 | 218 |
| 5 | 00 | 215 | 215 |
| 6 | 00 | 212 | 212 |
| 7 | 00 | 209 | 0 |
| 8 | 00 | 207 | 207 |

On account of the first rapid drop in the curve, and also due to the comparatively slow motion of the galvanometer-needle, it was not possible to obtain readings on the steeper parts of the curve. However, the excellent agreement

between the two parts of this experiment would indicate that a selenium cell, when exposed to light, experiences the same changes in resistance whether a current is flowing or not.

Fig. 4.

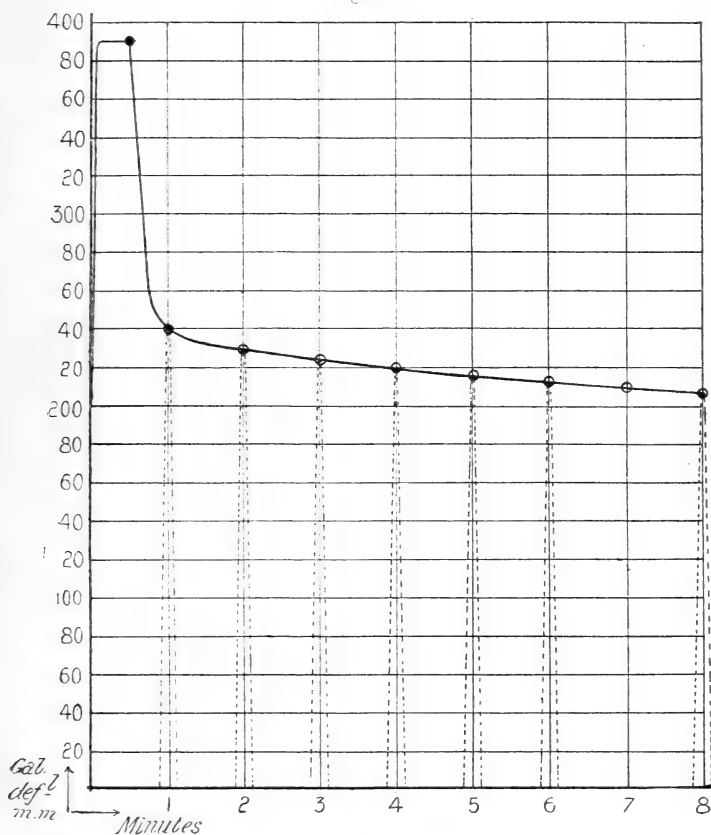

In Bidwell's theory the phenomenon is explained by assuming that light facilitates the molecular re-arrangement in the surface-layer of a selenide "through which an electric current is passing." The experiments just described show that apparently the changes in resistance occur independently of the flow of current. Furthermore, according to Bidwell's theory it is most difficult to account for the rôle played by the large excess of free selenium, whose presence is absolutely necessary to the development of sensibility in a cell.

Granting that in a selenium cell most, if not all, of the conduction is electrolytic in character, due to the presence of

a selenide, it follows that there is an actual motion of the components of the selenide towards the electrodes of the cell. Any cause which will increase the velocity of these components will decrease the resistance of the cell. Selenium is known to exist in at least four allotropic modifications *, the metallic or crystalline form being represented in the selenium cell. As it is an established fact that light affects the character of certain crystalline compounds, it is not unreasonable to suppose that light, in falling upon selenium, might also change its crystalline character, and that this new modification might offer less resistance to the components of the selenide as they wander towards the electrodes, thereby producing indirectly an increase in their velocities, which is equivalent to a decrease in the resistance of the cell. This view gains in plausibility if, with Bidwell, we think of the particles of selenide as being packed in between the particles of selenium. Assuming that this new modification of selenium is stable only in light, it would revert to its original condition when light is cut off, the change taking place more rapidly at first and more slowly afterwards (comparable perhaps to the molecular changes in soft iron when the magnetizing force has been withdrawn). This would decrease the velocity of the components of the selenide, which would mean eventually bringing the resistance of the cell back to its original value.

An explanation of this character has the following advantages:—

1. It ascribes, with Bidwell, the electrical conduction to the selenide.
2. It assigns a definite *rôle* to the free selenium.
3. It accounts for the fact that light produces changes in the resistance of a cell whether a current be flowing or not.
4. It affords a possible explanation of the fact that the position of maximum sensibility is independent of the metal in the selenide.

Of course, quite a number of other explanations are conceivable. It appears to me, however, that, as soon as the action of light directly upon the selenide is involved, some further hypotheses must be made to account for the fact that the position of maximum sensibility is independent of the nature of the selenide. The reason is at once apparent if the action initially be ascribed to the selenium itself, which is present in such abundance in all cases.

* A. P. Saunders, *Journal of Phys. Chemistry*, vol. iv. p. 423.

Résumé.

1. The sensibility of selenium cells, containing highly purified selenium mixed with various metallic selenides, was examined in different parts of the spectrum, and it was found that the position of the maximum, near 0.7μ , remained fixed. It was concluded that the position of the maximum was not governed by the metal in the selenide, but probably by the free selenium itself.

2. It has been shown that a selenium cell, taken from darkness into light and again returned to darkness, undergoes changes in resistance whether an electric current flows or does not flow through the cell.

3. A suggestion as to the possible action of a selenium cell has been made. It is supposed that light affects the selenium directly rather than the selenide. This explanation, expressed of necessity in rather indefinite terms, gives promise of accounting for certain phenomena, the explanation of which fails at the hands of the existing theory.

This investigation has been carried on during the past year under the supervision of Professor C. E. Mendenhall, to whom I wish to express my warmest thanks for his many valuable suggestions, and for the kindly interest he has taken in the progress of the work.

Physical Laboratory,
University of Wisconsin.

*V. The Bending of Magnetometer Deflexion-Bars. By C. CHREE, Sc.D., LL.D., F.R.S. (From the National Physical Laboratory.)**

IN May 1901 I communicated to the Society a paper † making various applications of Elastic Solid Equations to Metrology. Amongst the examples treated was the bending of magnetometer deflexion-bars. As explained (*l. c.* pp. 613–615), the deflecting magnet is carried by the deflexion-bar at an appreciable height above the c.g. of the cross-section, and the bending of the bar when in use, under its own weight and that of the magnet with its carriage, results in an increase of the distance between the deflecting and deflected magnets. To keep the instrument properly level, there ought to be a counterpoise on the other arm of the deflexion-bar, at the same distance as the deflecting magnet from the centre. In the absence of such a counterpoise, supposing the instrument originally level, the weight

* Communicated by the Physical Society : read October 23, 1903.

† *Phil. Mag.* [6] vol. ii. pp. 532–558 & 594–616.

of the magnet and carriage causes a slight tilting. In consequence of this, the point of suspension of the deflected magnet moves towards the deflecting magnet, thus reducing the horizontal distance between them. This compensating effect increases with the length of the suspension of the deflected magnet; it also depends on the pattern and massiveness of the magnetometer. The tilting is objectionable for several reasons, and suitable counterpoises exist in some instruments. In others, however, there is no regular counterpoise, the only equivalent being a thermometer, usually considerably lighter than the magnet and carriage, whose position varies according to the ideas of the observer, who may even put it on the same arm as the magnet. I have investigated the tilting effect in one or two cases, but refer to it at present only to put observers on their guard. If it exists, but is overlooked, the corrections deduced from a pure bending experiment are not strictly applicable.

Since the publication of my first paper on the subject measurements of the bending effect have been made on over twenty magnetometers at the National Physical Laboratory; and it is now the regular practice to take the effect into account in framing the certificates, as these record lengths to 0.001 cm.

The earlier measurements were made by Mr. F. E. Smith, the bar being symmetrically loaded, and the consequent increase in distance between two carried points being read by microscopes.

After regular work was commenced at Bushy House, the measuring-apparatus was transferred there, and for some time magnetometers were sent over from Kew to Bushy, so that the measurements might be made by Mr. Smith on the bars supported as in use. The transport of heavy magnetometers being troublesome, and the degree of accuracy absolutely necessary being comparatively small, I devised the following method which enables the measurements to be taken at Kew. As actually carried out, the method makes no claim to the highest precision; but it is, I believe, novel and capable of development, and it could easily be applied by the owner of any of the older magnetometers which have been verified at Kew, the great majority of which are probably situated where there is no ready access to physical laboratories.

The magnetometer is set up exactly as in an ordinary deflexion experiment, with the deflecting magnet on its carriage at any convenient position on the deflexion-bar, and equal weights are hung up symmetrically, one on each arm. The consequent increase of distance between the two magnets

diminishes slightly the deflecting force on the deflected magnet, and a slight change of reading is observed in the magnetometer-telescope. Putting the weights off and on, one gets in a few minutes sufficient measurements to supply a good mean. As a check, it is well to observe at two distances. Also if one takes a distance as large as 30 cms.—usually the shorter of the two distances employed in determining the horizontal force—it is advantageous to employ two deflecting magnets simultaneously, situated at equal distances on the two arms, on carriages of equal height. When only one magnet or carriage is available, a distance of 25 cms. is a convenient one in this country, with a deflecting magnet of normal moment (say 800 to 1000 c.g.s.). The smaller the horizontal force at the place, the larger is the distance at which deflexions may conveniently be taken, and the more favourable, *ceteris paribus*, are the conditions for the experiment. One can of course increase the bending effect most easily by increasing the weights applied. But if one uses weights much larger than those used at Kew (660 grms. each approximately) there is a risk of tilting the magnetometer over—which would probably entail disastrous results. It is also desirable that the experimental weights should together not much exceed the weight of the bar (usually under a kilogram).

To a first approximation the deflexion-angle u due to a magnet of moment m , at distance r , when the horizontal force is H , is given by

$$r^3 \sin u = 2m/H. \quad \dots \dots \dots (1)$$

The deflecting and deflected magnets are supposed to be mutually perpendicular, as in the ordinary horizontal-force experiment. Answering to an increment δr in r , we have an increment δu in u ; and by (1)—assuming m and H unchanged—the two increments are connected by the relation

$$3(\delta r/r) + \cot u \delta u = 0,$$

or
$$\delta r = -\frac{1}{3} r \cot u \delta u. \quad \dots \dots \dots (2)$$

In the present case r is a distance read off from the deflexion-bar, u is the inclination of the deflected magnet to the magnetic meridian, as given by the azimuth-circle of the magnetometer, and $-\delta u$ is the change in u answering to loading by given weights*. In practice $-\delta u$ represents a number of scale-divisions, as read off on the magnetometer-telescope.

* Necessarily δr is positive and δu negative, *i. e.* the deflexion-angle is always diminished by loading.

Supposing α to be the value in minutes of arc of a scale-division, and $(-\delta u)$ to represent the number of scale-divisions, the working equation answering to (2) is

$$\delta r = \frac{1}{3} r (-\delta u) \cdot \alpha \times \cdot 000291 \cot u. \quad (3)$$

The angle u varies of course with changes in natural declination or horizontal force, with change of temperature in the deflecting magnet, and with any artificial magnetic disturbances peculiar to the locality. Except at times of pronounced magnetic storm, natural magnetic changes or changes of temperature present no real difficulty, as loadings and unloadings occupy so little time that a few repetitions secure a mean from which slow regular disturbing effects are satisfactorily eliminated. Large irregular magnetic disturbances, such as may be experienced near an electric railway, would unquestionably be troublesome; but sites where such disturbances exist are in any case unsuitable for magnetometers.

The degree of accuracy obtainable by the method may be judged by reference to the results obtained by Mr. T. W. Baker on the first occasion when it was tried. Independent measurements were made in this instance by Mr. F. E. Smith, who employed the microscope apparatus previously in use.

| | Magnetic Method at Kew. | | | | Direct Measurement | |
|--|-----------------------------|---------------------|-------|-------|--------------------|-----|
| | Weights used each 658 grms. | | | | at Bushy House. | |
| | Using | | | | Weights used each | |
| | one | two | | | 493 grms. | |
| | magnet | deflecting magnets. | | | | |
| Distance where bending } effect observed ... cms. } | 25 | 27.5 | 30 | 40 | 30 | 40 |
| $-\delta u$ (minutes of arc) | 2.72 | 4.67 | 2.57 | 1.05 | | |
| Calculated δr , cm. | .0088 | .0098 | .0098 | .0156 | | |
| Calculated $EI \times 10^{-6}$ | 363 | 351 | 368 | 265 | 359 | 370 |
| Means | 361 | | | | 364 | |

Here E is Young's modulus for the bar, and I the moment of inertia of the cross-section about a perpendicular to the plane of bending through the c.g. What either method really gives directly is EI/h , where h is the height of the magnet's centre above that of the cross-section. In the magnetic method h represented of course the exact height at which the magnet is found in actual use. In Mr. Smith's measurements h had a slightly different value, so the value of EI formed the most convenient basis for comparison.

Excluding the observations at 40 cms. in the magnetic method—to which we shall return presently—we have an exceedingly close agreement between the results from the two

methods. This is partly fortuitous, as the third significant figure is probably ornamental in either case. For one thing, there is an uncertainty of probably at least 1 or 2 per cent. in the values of h . Again δu was actually observed to only 0.1 scale-division, or 0.1 approximately, and only four or five observations with weights off and on were made at each distance. Finally, electric tram disturbances at Kew, though not absolutely large, are sufficient to interfere appreciably with the accuracy of the method when the change of deflexion-angle is small. This applies more particularly to the observations at 40 cms., where the change of deflexion-angle was only about 1'. In fact it was decided on the spot that these observations were too uncertain, and the observations at 27.5 cms. were taken to replace them.

The formula employed in calculating EI/h from δr is

$$EI/h = W'(-a^2 + 2cr - r^2)/(2\delta r), \dots (4)$$

where W' is the mean weight of the two applied weights (which should be equidistant from the centre of the bar and at least nearly equal),

$2a$ the distance between the two supports of the bar,

$2c$ " " " weights W' ,

r the distance from the centre of the bar where δr is observed.

If all the lengths are measured in cms., and W' is in grammes, then E is in grammes weight per sq. cm.

In applying the result it is not really necessary to calculate EI/h , supposing the observation made on the actual magnet of the magnetometer in its own carriage. Also, for practical purposes, an experiment at a single suitable distance would suffice, though two distances are better. The general formula giving the change in the distance x between the deflecting and deflected magnets due to bending under the ordinary conditions of use is

$$\delta x = \frac{h}{EI} \left[\frac{W}{2}(x^2 - a^2) + \frac{w}{6} \{ l(l^2 - 3a^2) - (l-x)^3 \} \right], \dots (5)$$

where

$2l$ = whole length of deflexion-bar,

$2wl$ = whole weight of deflexion-bar,

W = weight of magnet and carriage;

while a , h , and EI have the same meanings as before.

Thus, combining (4) and (5), we have

$$\delta x = \delta r \left[W(x^2 - a^2) + \frac{1}{3}w \{ l(l^2 - 3a^2) - (l-x)^3 \} \right] \div [W'(-a^2 + 2cr - r^2)], \dots (6)$$

where δr is given by (2) or (3).

Bending experiments have now been made on magnetometers by four makers. So far as elastic quality is concerned, all the bars from any one of the makers have been sufficiently alike to be grouped together. There have been differences, however, in the weights carried, which render it necessary to arrange the bars in seven groups when considering the size of the bending effect. In every case, except that of a single special Dover bar, there have been at least two specimens in each group. What is here called a "Cooke-Elliott" bar is really an old Elliott bar adapted for use with Cooke magnets &c. in India. So far as elastic property is concerned, these may be classed with ordinary Elliott bars. The means of the results obtained appear in the following table.

| Maker or type of bar. | EI × 10 ⁻⁶ . | E × 10 ⁻⁷ . | Increase of distance between magnets due to bending at distances stated. | | | | | | | |
|----------------------------|-------------------------|------------------------|--|-----|-------|----|----|----|-----|---------|
| | | | (Unity = 1μ ≡ .001 mm., or .0001 cm.) | | | | | | | |
| | | | 22.5 | 25 | 26.25 | 30 | 35 | 40 | 45 | 50 cms. |
| Cambridge Instrument Co. | 375 | 110 | ... | 27 | ... | 31 | 36 | 41 | 45 | 51 |
| Cooke } older | ... | ... | 30 | ... | 35 | 42 | 49 | 58 | ... | ... |
| India Office } newer | 561 | 82 | 24 | ... | 28 | 32 | 38 | 45 | ... | ... |
| pattern } usual ... | 379 | 83 | ... | 35 | ... | 41 | 46 | 51 | 56 | ... |
| Dover } special ... | | | ... | 46 | ... | 55 | 64 | 73 | 82 | 92 |
| Cooke-Elliott } | 336 | 102 | 43 | ... | 50 | 58 | 70 | 84 | ... | ... |
| Elliott usual } | | | ... | 30 | ... | 35 | 40 | 45 | 50 | 56 |

The great majority of the measurements on which the calculations depend have been made by Mr. F. E. Smith, to whose skill and care as an observer the consistency in the results obtained in bars from the same maker owes much. Owing to the shape of the Cooke bars, the calculation of *I* in their case, and hence that of *E*, is exposed to greater uncertainties than with the others.

In actual magnetic work distances are measured only to .001 cm., or to 10μ, and to this degree of accuracy the results in the table are probably representative of the great majority of old magnetometers by the respective makers.

In my previous paper I remarked on the fact that in many cases the increase in distance due to the bending varied roughly as the distance itself. This accidental phenomenon—accidental in so far as it is due to an undesigned relationship between the weight of the bar and that of the magnet and carriage—is shown by the bars of all the different makers, but

will be most readily seen in the table in the case of the bars by the Cambridge Instrument Co. and by Messrs. Elliott Bros. In the former case the bending increased the distance by almost exactly 1 part in 10,000 at all distances.

It is not at all improbable that the method or modifications of it might be found useful in a variety of elasticity measurements, especially when made on non-magnetic materials. The deflecting magnet might be replaced by a coil traversed by an electric current. It would be easy to carry a small coil or light magnet at the end of an arm, so as to bring it very close to the magnet or suspended coil meant to be deflected. In this way one could arrange that an elastic displacement, largely multiplied if desired, should produce a large effect on the field of a galvanometer-needle. Readings of the deflexion-angle of a calibrated galvanometer, or of the movement of a compensating coil situated at some distance, and movable by a fine screw so as to secure a balance, might afford an exceedingly sensitive method.

VI. *On the Magnetism of Basalt and the Magnetic Behaviour of Basaltic Bars when Heated in Air.* By G. E. ALLAN, D.Sc. (Birm.), late Lecturer in Physics in the University of Birmingham*.

[Plates I. & II.]

THAT the magnetism of rocks has an important bearing not only from the geological but also from the physical standpoint, viz. in its relations to regional magnetic disturbances, has been shown by Prof. Sir A. Rücker †, in a paper on this subject, in the first part of which are given determinations of the susceptibility of a large number of different kinds of rock, basaltic and others. The magnetic properties of the numerous ferriferous minerals have also been the object of many investigations ‡.

The subject matter of the present paper is confined chiefly to one kind of rock, viz. basalt; and the experiments described were made in order to find at what temperature basalt becomes non-magnetic. The effect of temperature on magnetite is, to a large extent, already known, and as the magnetism of basalt is taken to be due chiefly to the magnetite it contains, it might be assumed that the magnetic properties of this rock are always similar to, while feebler than, those

* Communicated by the Physical Society: read October 23, 1903.

† A. W. Rücker, Proc. Roy. Soc. vol. xlviii. p. 505 (1890).

‡ *Congrès Int. de Physique*, Rapports 2, p. 470 (1900).

of magnetite. But this, although in a certain measure true, is not always the case.

Messrs. Barton and Williams found in 1892 that magnetite has a maximum susceptibility at 325°C . * and a minimum at 557° †, whilst P. Curie ‡, in 1895, using a rougher method, found its temperature of magnetic transformation to lie in the neighbourhood of 535°C .

The basalt specimens were obtained from two localities, Rowley Regis near Birmingham, and Linz on the Rhine. Two kinds were obtained at Rowley, being known locally as the blue and grisly grey. The former variety resembles the ordinary basalt, whilst the latter is formed of much larger crystals and is a dolerite. The German basalt, which I was enabled to obtain through the instrumentality of the late Herr Boden of Rotterdam, and which the Basalt Company of Linz gave me every facility to choose, was also a finely crystalline dark blue variety (being, indeed, similar in outward appearance to the Rowley blue basalt) and was obtained from the above Company's quarry on the Dattenberg.

The magnetic tests were made on bars cut from pieces of the above-named rocks to a pattern 10.5 cms. long by 1.5 cm. square, the expense of the cutting being defrayed by a grant made by the Birmingham Philosophical Society.

Method and Apparatus.

The magnetometric method was chosen as being probably the most convenient for testing different rock specimens

Fig. 1.—Combined magnetizing-coil MM and electric furnace PP with water-jacket A B.

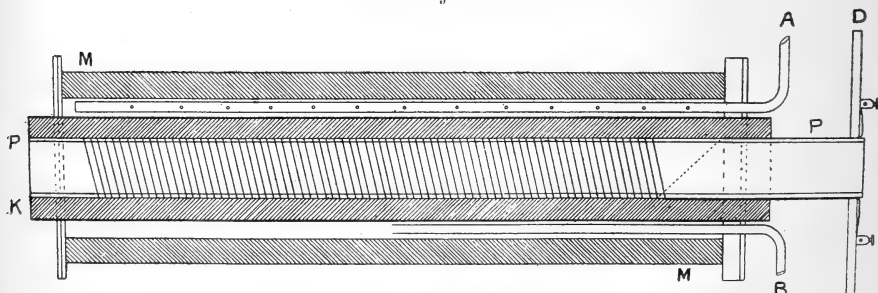

under similar temperature conditions from time to time, and the temperatures were measured by means of a platinum thermometer. Accordingly a combined magnetizing solenoid

* E. H. Barton & W. Williams, *Electrician*, vol. xxix. p. 432 (1892).

† E. H. Barton & W. Williams, *B. A. Report*, Edinburgh, 1892.

‡ P. Curie, *Ann. de Chim. et de Phys.* vol. v. ser. 7, p. 289 (1895).

and furnace was made (see fig. 1). The furnace was constructed by winding, on an unglazed porcelain tube PP, 37 cms. long and 2·7 cms. in diameter, 40 double coils of platinum wire, the coils covering 25 cms. length of the tube, and the winding being closer at the ends than in the middle. The porcelain tube, the internal diameter of which was 2·3 cms., was supported within a wide glass cylinder, and the platinum wire was kept in position by means of a packing, K, of kaolin clay which filled up the space between the glass and the porcelain, and the ends of the glass cylinder were stopped up with a wet paste of kaolin clay, which was afterwards hardened by heat. The porcelain tube projected a few centimetres at one end, this projection being employed to carry a perforated disk, D, of biscuit ware to which the terminals of the heating-coil were attached. The glass cylinder fitted like a cartridge into the brass water-jacket on which the magnetizing-coil, MM, was wound. Water, entering the water-jacket at a low pressure by the tube A, was distributed by means of the small holes along the tube and drawn off through the tube B. A bar of basalt could thus be placed within the furnace and heated to any required temperature in a magnetic field while the magnetizing-coil was kept cool by a slow current of water. The resistance of the furnace-wire when cold was 12 ohms, and an E.M.F. of 110 volts could raise the temperature inside the furnace to 800° C., the current then being 3·75 to 3·5 amperes.

The furnace described above differs from that of Ledeboer* in having within the heating-coil a tube to hold the specimen, but, on the other hand, it appears to be similar to one employed by Prof. Holborn †.

It might be remarked here that in the furnaces of Holborn, Barton & Williams, S. W. Richardson, and others asbestos is employed as the heat-insulating material. This, in the ordinary commercial form, whether of sheet, twine, or wool, was found to be quite unsuitable for use in working with basalt as it gave rise to considerable magnetic disturbances on account of the iron it contained. After testing various substances as heat-insulators, kaolin clay was substituted for the asbestos.

The magnetizing-coil consisted of six layers of No. 16 silk-covered copper wire wound on the water-jacket, the total number of turns being 956, the length of coil 29·2 cms., and the field per ampere approximately 40 c.g.s. ‡, and the

* Ledeboer, *Journ. de Physique*, p. 199 (1888).

† *Nature*, p. 350, Feb. 17, 1902.

‡ Corrected for the end effect. See Maxwell, *Elec. and Mag.* vol. ii. section 676; and J. S. Townsend, *Phil. Trans.* p. 533 (1896).

resistance 1.93 B. A. ohms. A wide-mouthed compensating-coil was placed between the magnetometer and the scale. The two coils and the magnetometer were carried on a wooden stand provided with levelling-screws, the magnetizing-coil being fixed on the stand, whilst the stand holding the compensating-coil was movable by means of a screw, and was held in position by brass springs.

The magnetometer consisted of a small piece of steel spring, 1 cm. long, stuck on the back of a cross cut out of thin sheet copper. The cross held in front a mirror, 1 cm. in diameter, which had been cut from a thin convex lens silvered on one side, and was suspended by a fine quartz fibre 30 cms. long, the needle hanging inside a block of bronze that served to damp its vibrations. The mirror had a focal length of 1 metre, and cast the image of a cross-wire on a transparent scale at a distance of 175.5 cms. The arrangement of the apparatus, so as to allow the necessary readings and manipulations to be made by one observer, is shown in fig. 2,

Fig. 2.—Diagram to show arrangement of apparatus.

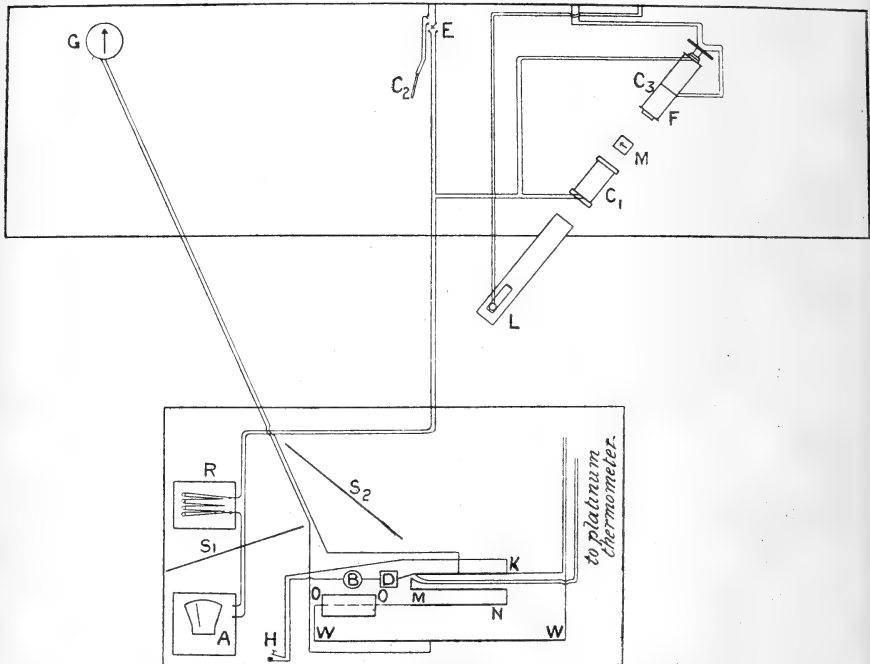

where F is the furnace and magnetizing solenoid and C the compensating-coil. M is the magnetometer with its lamp L and scale S_2 . The coil C_2 neutralizes the disturbing effect of

the current supplied to the magnetizing-coil, and C_3 that due to the furnace current. The current in the magnetizing-coil was measured by the amperemeter A, and regulated by the rheostat R. The resistance measurements were made by means of the box K M N, along with the divided ohm O O, the bridge-wire W W, and the galvanometer G, with its scale S; B is a Leclanché cell and D a resistance of 60 ohms. An observer standing near the key H could thus take all the readings, the commutator E being manipulated by two threads passing between E and H.

For the platinum thermometer a length of about 110 cms. of pure platinum wire, 0.15 mm. in diameter, obtained from Messrs. Johnson & Matthey, was wound on a flat strip of mica and connected with thicker leads, compensating leads being also employed. The strip of mica on which the thermometer was wound was nearly the same length as the bars of basalt, so that the temperature measured would be the mean temperature of the part of the furnace occupied by the bar. No trouble was experienced from laying the bare thermometer on the basalt, and measurements of the surface conductivity of the bars before and after heating showed that, when cold at least, the insulation was quite sufficient. Further, the constants of the thermometer did not change by any greater amount than could be attributed to the handling the latter underwent in being placed in the furnace at the beginning of the experiments. Resistances were measured by means of an old but very accurate Elliott B. A. box combined with a divided ohm and a metre bridge, the values of the two latter being expressed in terms of the Elliott box 1 ohm coil. The Elliott box was one which had been used and standardized by Mr. R. H. Housman, and its 1 ohm coil, when compared with two standard B. A. units, was found to be correct to the fourth decimal place. The thermometer was standardized and temperatures reckoned according to the methods recommended by Callendar and Griffiths*, except that boiling mercury was employed to determine the third fixed point instead of boiling sulphur. The values obtained for the constants gave a value of δ closely approximating to 1.57, and the latter constant was therefore employed.

The thermometer was first used to find to what extent the temperature within the furnace might be taken as uniform, and the latter was explored while being heated by 25 and 48 accumulator cells respectively. The results showed that at

* H. L. Callendar, *Phil. Trans.* p. 161 (1887); Callendar & Griffiths, *Proc. Roy. Soc.* vol. xlix. p. 56 (1890); E. H. Griffiths, 'Nature,' vol. liii. p. 39, Nov. 14th, 1895.

two points towards the ends of the furnace the temperature was at a maximum, the extreme difference being about 10° for temperatures in the neighbourhood of 400°C. , the difference being smaller for higher temperatures. The basalt bars were of such a length as to lie within the two points at maximum temperature, and the actual temperature-difference between the ends of the bar and the middle probably did not exceed 6° or 7° .

In employing the magnetometric method it was, of course, necessary to reduce all magnetic disturbances to a minimum. These were found to be caused chiefly by the two circuits which supplied currents to the magnetizing-coil and the furnace from a distant battery of accumulators, and the small compensating-coils C_2 and C_3 were included in the two circuits and adjusted to neutralize the disturbances mentioned. It was also found impossible to carry out extended magnetic observations except on Sundays or during the night. A 4-minute electric tram service passing at a distance of over 300 yards did not cause any serious inconvenience.

To test the apparatus and thermometer together, a small strip of mild transformer steel, obtained from Dr. D. K. Morris, the critical temperature of which was known to lie between 770° and 780° , was placed in the furnace with the thermometer and heated up. The temperature of the critical point was found to be 776°C. The apparatus was therefore considered to give satisfactory results, the difficulty of course remaining, however, with regard to the difference of temperature that must in all probability exist between the outside and inside of a bar with such low heat-conducting power as that of basalt, when it is being heated or cooled.

Before testing the effect of temperature on basalt, some of the bars were passed through cycles of magnetization. A 4-coil manganin rheostat with mercury cups was made, the resistances of the coils being such that currents of about 0.25, 0.5, 0.75, and 1 ampere could be obtained by putting the coils in series, by steps. The current was measured by a Weston ammeter of the type called the Century Standard Testing Set, which gave 100 divisions per ampere.

The three curves given, viz. for Rowley Blue No. 2, Rowley Dolerite No. 2, and Dattenberg No. 1, show that hysteresis exists in these bars, but only in a very limited degree; and curves Nos. I. and II. (Pl. I.) form an illustration of the point emphasised by Prof. Sir A. Rücker in the paper mentioned, "that powerful permanent magnetization affords no proof of high permeability." The dolerite when first obtained and tested had the greatest effect on a long compass-needle,

and appeared to be much more magnetic than the Rowley blue basalt from the same locality.

The Magnetic Behaviour of Bars of Basalt Heated in Air.

Profs. Roberts-Austen and Rücker, when measuring the specific heat of basalt*, found that, "in the processes of heating and cooling, the basalt undergoes more or less important changes in constitution, and that frequent heatings and coolings, and the nature of the flame—whether oxidizing or reducing—appeared to affect the results very seriously."

The bars, being heated in air, were therefore subject to change of constitution, and it appeared that the greatest change occurred during the first heating, and diminished rapidly after each subsequent heating, the magnetic properties being tolerably constant at about the sixth heating. A reddish, rust-like coating was formed on the surface of the bar, the colour increasing in intensity with the number of heatings, and the coating forming soonest on the Rowley specimens. The above changes are accompanied by loss of water, more than 0·5 gram of water, or about 0·88 per cent., being given off in some cases.

The procedure by means of which the following results were obtained may be shortly described. Each experiment took about seven hours to complete, and was carried out mostly on Sundays, as during the week the compensation of the magnetic coil was liable to change from hour to hour owing to the wall tremors caused by the motion of machinery situated on the ground-floor beneath. Great care had to be taken to prevent any motion of the compensating-coil, since there was no means of detecting any disturbance due to this cause until the end of an experiment. Further, the effect to be measured was small, and, also, a motion of the compensating-coil was accompanied by a change in the magnetic field round the needle. Compensation having been effected, the middle of the bridge was found, this chiefly depending on the plug resistance of the circuit. The bar of basalt to be tested was then, with the platinum thermometer on the top, pulled carefully into its position in the furnace by means of thread, and the ends of the furnace stopped with cotton-wool to prevent air currents. Water was then passed slowly through the water-jacket, and corresponding thermometer readings and magnetometer deflexions, due to the reversal of a current of about 1·15 amperes in the magnetizing-coil, were taken as the temperature was gradually raised or lowered. A small damping-coil, not shown in fig. 2, was

* Roberts-Austen and Rücker, *Phil. Mag.* Oct. 1891, p. 353.

employed to prevent violent oscillation of the needle on reversal of the current.

The following numbers are given as an example of the series of readings taken during an experiment.

Feb. 15th, 1903.

| Time. | | Current in magnetizing-coil. | Scale-reading. | Platinum thermometer. | Observed deflexion. |
|-------|---------|------------------------------|---|-----------------------|---------------------|
| h | m | amp. | mm. | ohms. | mm. |
| 11 | 19 A.M. | ± 1.17 | 214.0 215.8 | 7.4 | Coil effect -1.8 |
| 32 | | | Rowley Blue No. 2 in furnace, with near end 8.5 cms. from end of furnace. | | |
| | | ∓ 1.17 | 207.0 215.5 | ... | 8.5 |
| | | | 10 cells on furnace. | | |
| 37 | | +1.169 | 215.8 206.3 | 8.0 | 9.5 |
| 55 | | 1.167 | 206.2 215.6 | 9.0 | 9.4 |
| | | 1.167 | 215.6 206.3 | 9.5 | 9.3 |
| | | | 20 cells. | | |
| 12 | 11 P.M. | 1.165 | 205.4 214.8 | 11.0 | 9.4 |
| 28 | | 1.164 | 214.5 204.7 | 12.5 | 9.8 |
| 34 | | 1.163 | 204.2 214.0 | 13.0 | 9.8 |
| | | | 25 cells. | | |
| 41 | | 1.163 | 214.3 204.0 | 14.0 | 10.3 |
| 50 | | 1.162 | 203.9 214.3 | 15.0 | 10.4 |
| 1 | 0 | 1.162 | 213.8 203.5 | 15.5 | 10.3 |
| | | | 30 cells. | | |
| 9 | | 1.161 | 203.3 214.2 | 16.5 | 10.9 |
| 19 | | 1.161 | 214.3 202.5 | 17.5 | 11.8 |
| | | | 32 cells. | | |
| 27 | | 1.163 | 202.0 214.5 | 18.0 | 12.5 |
| 32 | | 1.164 | 215.2 201.6 | 18.2 | 13.6 |
| 38 | | 1.163 | 200.8 215.0 | 18.4 | 14.2 |
| 45 | | 1.162 | 215.6 201.6 | 18.5 | 14.0 |

| Time. | | Current in magnetizing-coil. | Scale-reading. | Platinum thermometer. | Observed deflexion. |
|-----------|----|------------------------------|----------------|-------------------------|---------------------|
| h | m | amp. | mm. | ohms. | mm. |
| 35 cells. | | | | | |
| 1 | 49 | P.M. | 1.160 | 216.5 } 202.3 } 18.7 | 14.2 |
| | 51 | | 1.160 | 202.0 } 216.6 } 19.0 | 14.6 |
| | 56 | | 1.160 | 217.8 } 202.0 } 19.3 | 15.8 |
| 2 | 1 | | 1.159 | 201.7 } 216.7 } 19.5 | 15.0 |
| 37 cells. | | | | | |
| | 6 | | 1.183 | 216.5 } 204.0 } 19.8 | 12.5 |
| | 10 | | 1.183 | 204.5 } 215.0 } 20.0 | 10.5 |
| | 14 | | 1.183 | 214.2 } 206.3 } 20.2 | 7.9 |
| | 21 | | 1.183 | 208.2 } 213.0 } 20.4 | 4.8 |
| 40 cells. | | | | | |
| | 26 | | 1.159 | 212.6 } 209.5 } 20.6 | 3.1 |
| | 32 | | 1.159 | 209.5 } 212.5 } 21.1 | 3.0 |
| | 43 | | 1.159 | 213.3 } 210.5 } 21.5 | 2.8 |
| 50 cells. | | | | | |
| | 49 | | 1.150 | 211.2 } 214.3 } 23.0 | 3.1 |
| 40 cells. | | | | | |
| | 53 | | 1.157 | 214.3 } 211.3 } 23.0 | 3.0 |
| 3 | 10 | | 1.158 | 211.5 } 214.6 } 22.2 | 3.1 |
| 35 cells. | | | | | |
| | 17 | | 1.159 | 214.5 } 211.7 } 21.5 | 2.8 |
| 32 cells. | | | | | |
| | 25 | | 1.180 | 212.0 } 215.1 } 20.7 | 3.1 |
| | 27 | | 1.180 | 215.5 } 212.3 } 20.4 | 3.2 |
| | 29 | | 1.180 | 211.0 } 215.8 } 20.1 | 4.8 |
| | 32 | | 1.182 | 218.0 } 209.5 } 19.9 | 8.5 |
| | 36 | | 1.181 | 206.5 } 220.4 } 19.7 | 13.9 |
| | 41 | | 1.182 | 223.0 } 206.7 } 19.5 | 16.3 |
| | 44 | | 1.182 | 205.5 } 221.8 } 19.4 | 16.3 |
| | 49 | | 1.183 | 223.1 } 206.3 } 19.3 | 16.8 |
| | 56 | | 1.183 | 205.8 } 222.7 } 19.2 | 16.9 |

| Time. | Current in magnetizing- coil. amp. | Scale- reading. mm. | Platinum thermometer. ohms. | Observed deflexion. mm. |
|---------------|---|--|-----------------------------------|-------------------------------|
| h m | | 30 cells. | | |
| 4 3 P.M. | 1.160 | 224.0 | 19.0 | 16.7 |
| | | 207.3 | | |
| 8 | 1.160 | 207.2 | | |
| | | 222.5 | 18.7 | 15.3 |
| | | | | |
| | | 25 cells. | | |
| 16 | 1.160 | 225.0 | 18.0 | 13.0 |
| | | 212.0 | | |
| 23 | 1.160 | 213.4 | 17.4 | 13.0 |
| | | 226.4 | | |
| 30 | 1.160 | 228.5 | 17.0 | 12.5 |
| | | 216.0 | | |
| | | Furnace current off. | | |
| 33 | 1.160 | 216.2 | 16.0 | 12.8 |
| | | 229.0 | | |
| 38 | 1.160 | 231.0 | 14.0 | 12.5 |
| | | 218.5 | | |
| 45 | 1.162 | 218.9 | 12.0 | 12.5 |
| | | 231.4 | | |
| 56 | 1.163 | 230.2 | 10.0 | 11.9 |
| | | 218.3 | | |
| 5 11 | 1.163 | 215.6 | 8.5 | 11.7 |
| | | 227.3 | | |
| 34 | ± 1.165 | 225.7 | 7.7 | 11.4 |
| | | 214.3 | | |
| | | Thermometer and basalt removed from furnace. | | |
| 40 | ± 1.168 | 216.0 | ... | Coil effect -1.5 |
| | | 217.5 | | |

From the above figures, which are those for the sixth heating of Rowley Blue No. 2, it may be seen that whilst the temperature was made to vary rapidly at the beginning and at the end of the experiment, previous work having shown that there was very little change in the susceptibility of the bar under test up to about 300° C., the rate of heating or cooling was slowed down as the temperature of maximum or minimum susceptibility was approached, the temperature change in the furnace being reduced to 2° or less per minute. The effect due to the coils alone having been almost constant throughout the experiment, 1.7 mm. were added to each deflexion. The deflexions were then calculated for a current of 1.15 amperes in the magnetizing coil, and these plotted with the temperatures.

The experiments on Rowley blue basalt No. 2 show that during the first heating the susceptibility increases to a maximum at about 340° C., and then diminishes, at first slowly, then rapidly, until a minimum is reached at about 500° C. As the bar cools it does not regain its magnetic qualities, but, after passing through a maximum point at

about the same temperature as during the heating, reaches the temperature of the air with about $1/7$ of its initial strength. The further heating of the bar develops a maximum point, or it may be two maxima (see Curve VIII.) about 480° , the minimum being near 540° .

Curve IV. (fig. 4) was obtained as the result of a test made on the bar Rowley Blue No. 1, which had previously been used in furnace trials. The curve had retained the same character for at least six previous heatings. There is no sudden change, and the susceptibility increases gradually to a maximum at about 185° , and then diminishes to a minimum in the neighbourhood of 550° .

The next three Curves (IX., X., and XI. in fig. 6) represent the results obtained for two bars cut from a piece of Dattenberg basalt. It will be seen at once that their behaviour is very different from that of the Rowley basalt, being distinguished by a low temperature of maximum susceptibility and a gradual loss of magnetic strength with rise of temperature. For four out of five bars from this kind of rock the temperature of maximum strength was considerably below 100° C. The Dattenberg rock also does not deteriorate with heat so rapidly as that from Rowley, presumably because the former rock is of more recent formation. The bar Dattenberg No. 1 showed maximum permeability at 32° C. when being heated, and 35° on cooling. The curve for the first heating is not given, as it was marred by motion of the compensating-coil. During the third heating a maximum appeared at about 45° C., and on cooling the maximum had not been reached at 24° . The second bar gave a maximum at 143° , whilst the cooling curve was very similar to that obtained for Rowley Blue No. 1 (fig. 5). The effect of heating was to raise the susceptibility of the cold bar to nearly 2.4 times its initial value; an increase in strength due to heating may also be noted in Curves VI., VII., and VIII. The two bars were cut from a slice taken transversely from a basaltic column, and their temperature-magnetization curves are distinguished from the others by the fact that whilst an ill-defined minimum is reached at a comparatively low temperature, the bar retains considerable magnetic susceptibility at that temperature.

With a more numerous series of experiments it is probable that an explanation of the difference between the two Dattenberg bars Nos. 1 and 2 might have been forthcoming. At present it can only be surmised that No. 2, which was the only one of its kind to exhibit exceptional behaviour, was from a piece of rock which had deteriorated by weathering.

Some of the basaltic columns on the Dattenberg, after lying exposed for a long time to the action of the weather, deteriorate to such an extent that a large column can be shattered into fragments with one blow of a hammer.

The curves for Dattenberg bars Nos. 3, 4, and 5, shown in fig. 7, are similar to those for bars 1 and 2. Three bars were cut from a strip of rock taken lengthwise from the edge of a basaltic column. When in position bars 3 and 5 lay near two adjacent and almost parallel faces of the column, which both showed signs of weathering; bar 4 was taken from between the other two. Whilst the initial susceptibility is different for each bar, being highest for the inside one, the temperature of maximum strength also varies, being 68° , 48° , and 57° respectively for bars 3, 4, and 5. The temperature of minimum permeability is not distinct, but all the bars show little sign of magnetization at about 250° C. These three curves were taken for the purpose of comparing the magnetic properties of bars taken from adjacent positions in the rock; and it holds for these bars and for Nos. 1 and 2, that the bar with the lowest temperature of maximum susceptibility has also the highest initial susceptibility.

Curves Nos. XIII. and XIV. are for bars Nos. 1 and 2 of Rowley dolerite. They each show feeble signs of a maximum at 109° , and another at 263° ; but whilst the strength of bar No. 1 then decreases to a minimum at 445° followed by a maximum at 467° , magnetism disappearing almost entirely at 597° , bar No. 2 goes on increasing in strength, and has another maximum at 362° , reaching a minimum at a little over 600° . Bar No. 1 is unique in the series in this respect that no other exhibited so great a variation of magnetic strength as that shown in Curve XIII. between the temperatures 380° and 520° , the susceptibility of the bar at 425° being almost half the value it had at 380° and 470° . During the cooling, bar No. 1 showed a maximum susceptibility at 488° , whilst bar No. 2 was strongest at 446° . In their general character the two cooling curves are similar to those for Rowley Blue No. 2 (see Curves V., VI., and VII.). It may be noted that in the heating curves for Rowley Blue No. 2 (Curve IV.), and for Rowley dolerite No. 2 (Curve XIV.) which are very similar, and also in that for dolerite No. 1 (Curve XIII.), there is a brow in the dip of the curve corresponding to the period at which each bar has almost completely lost its magnetism.

The last curve given is for a bar of magnetite from Magnet Cove, Arkansas, cut to the same pattern as the bars of basalt. This one was placed 3.3 cms. farther from the

magnetometer needle than the basalt bars, and the field employed was 3.6 c.g.s., or 1/13 of the field used to magnetize the basalt. The curve for ascending temperature is somewhat irregular, and there appears to be a maximum at or near 280°, and also at 475°, just before the magnetite begins to lose magnetism. During both the heating and the cooling the thermometer indicated a sudden change of temperature at 552°. In magnetite, therefore, the magnetic transformation is accompanied, as in iron, by a sudden change of temperature. The value 552° and the general form of the heating curve are in good agreement with the results obtained by Messrs. Barton and Williams, who give, in the volume mentioned*, the value 557° for the temperature of the minimum and also a curve, drawn to an arbitrary scale of permeability, which, however, shows no maximum at the higher temperature. Heating has the effect of considerably reducing the susceptibility of the magnetite, and during the cooling a maximum was reached at 344° C. The magnetite, when withdrawn from the furnace, was coated in places with the same red oxide (?) as the bars of basalt, the coating being present chiefly at one spot where a part of the original exposed surface of the magnetite still remained.

Microscopic examination of the rocks was next proceeded with with a view to elucidating the effect of heat on the bars. Sections of the three different kinds of rock having been procured, the chips from which these sections had been taken were placed in the furnace and raised to 700°–800° for an hour. Sections of the heated chips were also obtained, and the photomicrographs given in figs. 10–15 (Pl. II.) show parts of the sections, figs. 10, 12, and 14 being unheated rock, and figs. 11, 13, and 15 heated rock. No change could be detected in the chief magnetic constituents of the rocks, viz. magnetite in the Dattenberg basalt, and ilmenite in the Rowley rocks, the magnetite being easily distinguished in fig. 14 as black opaque granules, often in well-formed crystals, scattered uniformly throughout the section, whilst the ilmenite appears in fig. 10 as larger black masses, and in fig. 12 in the form of long black needles and plates. The observed change had taken place in the alteration products of the rocks, such as chlorite and serpentine. The general appearance after heating indicated a cracking of the crystals, the cracks being filled with the same reddish powder as had appeared on the outside of the bars. This powder being opaque the micrographs of the heated rocks appear darker in consequence. Heat appeared to have little effect on the

* B. A. Report, Edinburgh, 1892.

Dattenberg specimens, it being difficult to find any difference between the heated and the unheated sections when examined either by eye or under the microscope. The redness which was so prominent in the other heated sections was wanting in that of the Dattenberg basalt. This agrees with what was found in regard to its magnetic behaviour, viz. that heating produces less permanent change in the magnetic properties of Dattenberg basalt than in those of Rowley rock. Fig. 15 is from a thin negative and the effect of heat on the section is exaggerated. The photomicrographs, for which I am indebted to Mr. J. D. Whittles, are taken with a magnification of 40 diameters.

Susceptibility of Basalt.

The magnetometric method, when employed to test bars of the size used in the foregoing experiments, does not lead to accurate values of the susceptibility. The results below are therefore to be taken as giving a comparison of magnetic intensities of the different specimens rather than as a series of accurate absolute values of the susceptibility.

The bars employed, and their dimensions, are given in the following table.

| Bar. | Weight. | Density. | Length. | Volume. |
|-------------------------|---------|----------|---------|---------|
| <i>Rowley Blue.</i> | gms. | | cms. | c.c. |
| No. 1 | 63·054 | 2·895 | 10·4 | 21·77 |
| No. 2 | 63·437 | 2·864 | 10·4 | 22·14 |
| <i>Rowley Dolerite.</i> | | | | |
| No. 1 | 59·261 | 2·727 | 10·2 | 21·73 |
| No. 2 | 58·642 | 2·715 | 10·4 | 21·46 |
| <i>Dattenberg.</i> | | | | |
| No. 1 | 73·809 | 3·006 | 10·4 | 24·56 |
| No. 2 | 66·3 | 2·99 | 10·4 | 22·2 |
| No. 3 | 67·010 | 2·956 | 10·4 | 22·68 |
| No. 4 | 70·017 | 3·024 | 10·4 | 23·16 |
| No. 5 | 69·706 | 3·006 | 10·4 | 23·19 |
| <i>Magnetite</i> | 117·49 | 4·628 | 10·4 | 25·39 |

To determine the susceptibilities of the rocks, a constant was found, from experiments on two bars, which, when multiplied by the deflexion produced by any bar, gave the magnetic moment of the latter. For example, the bar Rowley dolerite No. 2 was placed in the magnetizing coil, with its centre 27·8 cms. from the magnetometer-needle. By reversing a field of 46 c.g.s. the bar produced a deflexion of 32·2 mms. on a scale at a distance of 175·5 cms. The

value of H at the magnetometer-needle was taken as 0.12 , and was obtained by vibrating a short magnet in the position occupied by the magnetometer, and at a place where H had been measured with a magnetometer somewhat after the Kew pattern.

Employing the formula for the magnetic moment of the bar

$$M = H \frac{(r^2 - \lambda^2)^2}{2r} \tan \theta,$$

and putting $H = 0.12$, $r = 27.8$ cms., λ (= half the pole-distance) = 4.2 if we assume that the poles are 1 cm. from the ends of the bar, and

$$\tan \theta = \frac{1.61 \text{ cm.}}{2 \times 175.5 \text{ cms.}},$$

$$M = \frac{0.12(27.8^2 - 4.2^2)^2 \times 1.61}{2 \times 27.8 \times 2 \times 175.5} = 5.65.$$

Hence, the volume of the bar being 21.5 c.c., the intensity of magnetization is $\frac{5.65}{21.5} = 0.263$, and the susceptibility = 0.0057 .

Since the moment of the bar is proportional to the deflexion produced, and as all the bars were placed at the same distance from the needle, subjected to the same magnetic field, and had the same length, with one exception, we shall not be far wrong in taking 3.6 , the mean of experiments on two bars, as the magnetic moment per 20 mms. double deflexion. Employing this constant, the following values of K , the susceptibility, are found.

| Bar. | Initial Deflexion, H=46 c.g.s. | K at beginning. | K at end. | Number of Heatings. |
|-------------------------|-----------------------------------|-----------------|-----------|---------------------|
| <i>Rowley Blue.</i> | mm. | | | |
| No. 1 | 31.7 | 0.053 | 0.057 | One |
| No. 2 | 36.2 | 0.064 | 0.025 | Six |
| <i>Rowley Dolerite.</i> | | | | |
| No. 1 | 32.2 | 0.058 | 0.013 | One |
| No. 2 | 32.2 | 0.059 | 0.009 | One |
| <i>Dattenberg.</i> | | | | |
| No. 1 | 35.2 | 0.056 | 0.039 | Two |
| No. 2 | 7.5 | 0.013 | 0.031 | One |
| No. 3 | 14.2 | 0.025 | | |
| No. 4 | 28.3 | 0.048 | | |
| No. 5 | 22.5 | 0.038 | | |
| <i>Magnetite</i> | 61.3 (H=3.6) | 0.166 | 0.126 | One |

The next table gives the initial, maximum, minimum, and final values of the susceptibility for each heating, along with the temperatures of the maxima and minima. The last column gives the percentage increase in susceptibility between the temperature of the air and the temperature of maximum susceptibility during heating.

| Bar. | K at beginning. | K maximum, during heating. | K minimum. | K at end. | Temp. of maximum K. | Temp. of minimum K. | Per cent. increase in K. |
|-------------------------------|-----------------|----------------------------|----------------|----------------|---------------------|---------------------|--------------------------|
| <i>Rowley Blue.</i> | | | | | | | |
| No. 1 (10th heating) | ·0053 | ·0056 | ·0005 | ·0057 | 185 | 550 | 6 |
| No. 2 (1st heating) | ·0064 | ·0087 | ·0009 | ·0009 | 340 | 500 | 36 |
| No. 2 (6th heating) | ·0017 | ·0031 | ·0008 | ·0022 | 480 | 540 | 82 |
| <i>Rowley Dolerite.</i> | | | | | | | |
| No. 1 No. 2 | ·0058 ·0059 | ·0087 ·0089 | ·0004 ·0009 | ·0013 ·0009 | 260 360 | 597 619 | 50 51 |
| <i>Dattenberg.</i> | | | | | | | |
| No. 1 (2nd heating) | ·0056 | ·0059 | ·0011 | ·0056 | 32 | 500 | 5 |
| No. 1 (3rd heating) | ·0058 | ·0060 | ·0010 | ·0039 | 45 | 510 | 3 |
| No. 2 | ·0013 | ·0042 | ·0010 | ·0031 | 140 | 260 | 223 |
| No. 3 | ·0025 | ·0030 | ·0002 | ... | 68 | 250 | 20 |
| No. 4 | ·0048 | ·0050 | ·0002 | ... | 48 | 250 | 4 |
| No. 5 | ·0038 | ·0042 | ·0004 | ... | 57 | 250 | 11 |
| <i>Magnetite</i> | ·0166 | ·0214 } ·0206 } | ·0003 | ·0126 | 280 } 475 } | 552 | 29 |

The values found for the susceptibility of Rowley basalt are much greater than those given by Prof. Rücker in the paper mentioned at the beginning; but differences quite as great present themselves in the values found for the five Dattenberg bars.

In the same paper Prof. Rücker gives a theory of regional magnetic disturbances, the latter being explained by the magnetism of the rocks. By assuming that the temperature increases 1° for every 90 feet, a depth of 12 miles is found, below which magnetic matter ceases to exist. Now A. Harker has objected*, on geological grounds, to the assumption of a thickness of 12 miles, and puts the depth at $\frac{1}{50}$ of this amount. Prof. Rücker shows, however, that the

* A. Harker, Proc. Camb. Phil. Soc. vol. x. pt. 5 (1900).

average range of vertical disturbance being about $\cdot 00140$ c.g.s., differences of this order may be obtained by supposing that the slabs of magnetic matter are 16 kiloms. (10 miles) thick, and that the upper surfaces are 4 kiloms. from the surface of the earth. We may, however, arrive at a similar result by assuming that iron exists in the crust of the earth chiefly in the form of magnetite and iron ores, and that the temperature at which these cease to be magnetic is 555° C. With a rise of temperature of 1° per 90 feet of depth this would give a depth of 15 kiloms, or $9\frac{1}{2}$ miles, as the thickness of the magnetic floor, a value which corresponds with that calculated from a knowledge of the range of vertical disturbance.

In concluding this description of the experiments, which were carried out in the Physical Laboratory of Birmingham University, I take the opportunity of expressing my thanks to Prof. Poynting for suggesting the investigation, providing the necessary apparatus and space, and for much encouragement and assistance during the progress of the experiments.

I am also indebted to all the members of the Geological Department of the same University for their cordial assistance with the geological side of the investigation.

Physical Laboratory,
Birmingham University,
May, 1903.

VII. *On the Transfinite Cardinal Numbers of Well-ordered Aggregates.* By PHILIP E. B. JOURDAIN, B.A., Trinity College, Cambridge*.

IN the memoir † in which the transfinite ordinal numbers first appeared in a form independent of the theory of the derivatives of aggregates of points representing real numbers, the illustrious author, Georg Cantor, defined a series of "powers" which belong to various classes of the transfinite numbers, and which series possesses the remarkable property of being ordinally similar to the whole class of transfinite numbers ‡.

* Communicated by the Author.

† "Ueber unendliche, lineare Punktmannichfaltigkeiten, v.," *Math. Ann.* xxi. pp. 545-591 (1883) [dated December, 1882]; also as a separate pamphlet, 'Grundlagen einer allgemeinen Mannichfaltigkeitslehre. Ein mathematisch-philosophischer Versuch in der Lehre des Unendlichen,' Leipzig, 1883. Page n of the "Grundlagen" corresponds to page $n + 544$ of the article mentioned first.

‡ 'Grundlagen,' pp. 43-44.

It is essential for clearness that we should adopt the names and notations introduced by Cantor in 1895 and 1897 †. What were before called "powers" were then called (finite or transfinite) *cardinal numbers*, the transfinite numbers received the fuller designation of transfinite *ordinal numbers*, and finally, the above-mentioned series of cardinal numbers received the notation,

$$\aleph_0, \aleph_1, \aleph_2, \dots, \aleph_\omega, \aleph_{\omega+1}, \dots, \aleph_\gamma, \dots, \dots \quad (1)$$

where the suffixes form the whole series of the finite and transfinite ordinal numbers.

It is now easy to state precisely the fundamental results of Cantor ‡ with respect to the series (1).

Ordinal numbers belong only to what Cantor has called "well-ordered" aggregates §, and every part of numbers of the whole aggregate of ordinal numbers up to any number, arranged in order of magnitude,

$$\begin{aligned} 1, 2, \dots, \nu, \dots, \omega, \omega + 1, \omega + 2, \dots, \omega + \nu, \dots, \omega \cdot 2, \omega \cdot 2 + 1, \\ \dots, \omega \cdot \nu, \dots, \omega^2, \dots, \omega^\nu, \dots, \omega^\omega, \dots, \omega^{\omega^\omega}, \dots, \alpha, \\ \dots, \Omega, \Omega + 1, \dots, \gamma, \dots, \dots \quad (2) \end{aligned}$$

itself forms a well-ordered aggregate ||. The series of Alephs (1) is defined as the series of the cardinal numbers of well-ordered aggregates, and the Alephs are therefore the cardinal numbers of certain of the parts of (2) referred to. Cantor has, now, proved, in particular, that \aleph_1 is the next greater cardinal number to \aleph_0 ; and, in fact, in general ¶: If \aleph_γ is any cardinal number of the series (1), then $\aleph_{\gamma+1}$ is the next greater; and, inversely: if \aleph_γ is any number of (1), and \aleph_γ has an immediate predecessor (that is, if γ has an immediate predecessor in the series (2)), then \aleph_γ is the next greater than this predecessor. If, on the other hand, \aleph_γ has no immediate predecessor (that is, if γ is a Limes-number of

† "Beiträge zur Begründung der transfiniten Mengenlehre," *Math. Ann.* xlv. pp. 481-512 (1895), and xlix. pp. 207-246 (1897). See especially pp. 481-482, 492, 495, and 497 of the first article, and p. 216 of the second.

Cantor had, already in 1883, arrived at many of the formulations which were only published much later. (cf. 'Zur Lehre vom Transfiniten,' Halle a. S., 1890, pp. 11, 12).

‡ See 'Grundlagen,' pp. 35-39. Cf. Schönflies 'Die Entwicklung der Lehre von den Punktmannigfaltigkeiten,' Leipzig, 1900, pp. 44-50.

§ 'Grundlagen,' pp. 4-5; *Math. Ann.* xlix. pp. 207-208.

|| Cf. also *Math. Ann.* xlix. foot of p. 216, and §§ 2 and 3 below.

¶ A detailed proof of this will be given in the continuation of this paper; cf. end of § 10.

(2), like ω , $\omega \cdot 2$, $\omega \cdot \nu$, ω^ω , Ω , ...), \aleph_γ is the next greater cardinal number to all the cardinal numbers \aleph_β such that

$$\beta < \gamma.$$

Further, \aleph_0 is the smallest transfinite cardinal number †; it is the cardinal number of any enumerable aggregate, an aggregate which can always be re-arranged (if a re-arrangement is necessary) in the form of a well-ordered aggregate of type ω .

1.

We have thus an illimitable series of ascending cardinal numbers. But there are cardinal numbers, such as the cardinal number \mathfrak{c} of the real-number-continuum ($0 \dots 1$), which are not defined as cardinal numbers of well-ordered aggregates, and of which we cannot therefore immediately say that they occur in the series (1). However, Cantor showed ‡ that

$$\mathfrak{c} > \aleph_0, \dots \dots \dots (3)$$

and has always believed § that

$$\mathfrak{c} = \aleph_1;$$

though the latter equality has never yet been proved. But since \aleph_1 is the next cardinal number to \aleph_0 it is possible to take elements from the number-continuum corresponding to *all* the numbers of Cantor's first and second classes of ordinal numbers. For if this process were to stop we should have

$$\mathfrak{c} = \aleph_0,$$

which is contradicted by (3). Using, then, the theorem of Schröder and Bernstein ||, we can state that

$$\mathfrak{c} \geq \aleph_1 \text{ ¶.}$$

If, now $\mathfrak{c} > \aleph_1$, we can conclude similarly that

$$\mathfrak{c} \geq \aleph_2;$$

and so on. And if

$$\mathfrak{c} > \aleph_\nu$$

† *Math. Ann.* xlvi. p. 492. (Cf. Cantor, "Ein Beitrag zur Mannigfaltigkeitslehre," *Journ. für Math.* lxxxiv. 1878, p. 242.)

‡ "Ueber eine Eigenschaft des Inbegriffs aller reellen algebraischen Zahlen," *Journ. für Math.* lxxvii. 1874, pp. 258-263.

§ Cf. "Ein Beitrag zur Mannigfaltigkeitslehre," *Journ. für Math.* lxxxiv. 1878, p. 257; "Grundlagen," p. 7.

|| See below, §§ 7 and 8.

¶ The fact that $2^{\aleph_0} \geq \aleph_1$ follows, perhaps even more simply, from the consideration that 2^{\aleph_0} is the cardinal number of the transfinite classes which can be formed out of \aleph_0 members, while \aleph_1 is the cardinal number of some of these classes.

for all finite ordinal numbers ν , then

$$\aleph > \aleph_\omega;$$

and so on for all the numbers of (1). From this reasoning, which first appeared in a published form in a paper in which Hardy † constructed an aggregate of points of cardinal number \aleph_1 in the continuum, it follows that every cardinal number is either contained in the series of Alephs (1), or is greater than any Aleph.

If, now, Cantor's ‡ view that every cardinal number is an Aleph—which he expressed in the equivalent form that every well-defined aggregate can be put, by re-arrangement if necessary, in the form of a well-ordered aggregate—is to be substantiated, we must prove that the supposition that a cardinal number is greater than any Aleph leads to a contradiction.

2.

If a cardinal number were greater than any Aleph, it would be equal to or greater than the cardinal number of the series (1) of all Alephs. For to this series can be correlated § the series (2) of all ordinal numbers, and every Aleph is the cardinal number of some segment || of the series (2); the cardinal number in question must, then, be at least equal to the cardinal number of the whole series (2), and, consequently, to that of the whole series (1).

If, now, the series (2) and consequently (1), be *well-ordered*, the ordinal type of (2) (or (1)) is an ordinal number, β , and the cardinal number of (1) (or (2)) is an Aleph, \aleph_β . Further, this ordinal number β must be the greatest ordinal number, and, consequently, \aleph_β must be the greatest Aleph. But there can be neither a greatest ordinal nor a greatest Aleph; for, given β , the type of the aggregate $(1 \dots \beta)$ is the ordinal number $\beta + 1$, and

$$\beta + 1 > \beta,$$

$$\aleph_{\beta+1} > \aleph_\beta.$$

This contradiction was first published by Burali-Forti ¶,

† "A Theorem concerning the Infinite Cardinal Numbers," *Quart. Journ. of Math.* 1903, pp. 87-94.

‡ 'Grundlagen,' p. 6.

§ This word is to imply that the two aggregates are *similarly* ordered in the sense of *Math. Ann.* xlv. p. 497.

|| I use this word to translate Cantor's 'Abschnitt' of *Math. Ann.* xlix. p. 210.

¶ "Una questione sui numeri transfiniti," *Rend. del circolo mat. di Palermo*, xi. (1897).

who concluded from it that one must deny both Cantor's † fundamental theorem in the theory of ordinal numbers that : if α_1 and α_2 are any two ordinal numbers, then either

$$\alpha_1 < \alpha_2, \text{ or } \alpha_1 = \alpha_2, \text{ or } \alpha_1 > \alpha_2;$$

and the corresponding theorem for Alephs. This conclusion is, in fact, necessary if one admits Burali-Forti's premisses ; and, since Cantor's demonstration of the above theorem is beyond all possible objection, Russell ‡ avoided the contradiction by denying the premiss that the series of all ordinal numbers, arranged in order of magnitude, is well-ordered. Then the ordinal type (β) of (1) or (2) ceases to be an ordinal number, and we can no longer assert, in general, that

$$\beta + 1 > \beta.$$

Further, the cardinal number ceases to be necessarily an Aleph, and we cannot therefore assert, as we could before, that one of the Alephs surpasses it.

But it appears possible to prove that this series of all ordinal numbers *is* well-ordered ; to this proof the following section is devoted.

3.

If we adopt, as definition of a well-ordered aggregate (M) the property which Cantor § has proved to be the characteristic of well-ordered aggregates among all simply-ordered aggregates ; namely, that both it and everyone of its partial aggregates should have a first element ; it becomes evident that no part of M can be of ordinal type

$$*\omega.$$

But in no publication known to me does it appear to have been remarked explicitly that this gives a *sufficient*, as well as a necessary, condition that the simply-ordered aggregate M should be well-ordered. However, if M contains no part of ordinal type

$$*\omega,$$

it is well-ordered ; for if not, at least one of its parts would have no first element, and in this part a part of type

$$*\omega$$

can always be found. Thus, in order that a simply-ordered

† *Math. Ann.* xlix. p. 216.

‡ 'The Principles of Mathematics,' Cambridge, 1903, p. 323. Cf. Cantor, *Math. Ann.* xlix. foot of p. 216.

§ *Math. Ann.* xlix. pp. 208-209. This property has been taken as the *definition* of a well-ordered aggregate by Schönflies (*op. cit.* p. 36) and Russell (*op. cit.* p. 319, last note).

aggregate M should be well-ordered, it is necessary and sufficient † that M should contain no part of type

* ω .

It is, now, easy to prove that the aggregate (2) is well-ordered ‡. If, namely, the aggregate of all ordinal numbers, arranged in order of magnitude, so that it is certainly a *simply*-ordered aggregate, were not well-ordered, there would be a part in it of type

* ω ;

let this be

$$\alpha_1 > \alpha_2 > \dots > \alpha_\nu > \dots, \dots \dots \dots (4)$$

where $\alpha_1, \alpha_2, \dots, \alpha_\nu, \dots$ are ordinal numbers. Then in the *well*-ordered aggregate, A_1 , of all the ordinal numbers up to and including α_1 , there would be, since all the numbers $\alpha_1, \alpha_2, \dots, \alpha_\nu, \dots$ would be contained in this aggregate, the partial aggregate (4) of type

* ω ;

but it is impossible that a part of this type should be contained in the *well*-ordered aggregate A_1 .

Hence the aggregate (2), which I will call W , of all ordinal numbers, arranged in order of magnitude, is well-ordered; together with the aggregate (1) of all Alephs, which is similarly ordered to W .

4.

There arises, then, an insuperable contradiction if we speak of W , or any similar aggregate, as having a cardinal number or ordinal type; and, if the foundations of what is called the theory of aggregates, and with it the whole of pure mathematics §, is to be free from self-contradiction, we must agree that certain aggregates (like W) have no cardinal number and no ordinal type. It appears to me that such aggregates may be conveniently called *inconsistent* aggre-

† This characterization of well-ordered aggregates makes it very easy to construct simply-ordered aggregates which, in spite of their having many of the properties of well-ordered aggregates, are not well-ordered. Thus, an aggregate with a first term and an immediately consecutive term to every term in it (and even with an immediate predecessor to every term) need not be well-ordered (*cf.* end of § 6). Such examples do not seem superfluous in view of the incorrect definition of a well-ordered aggregate given, *e. g.* by Hadamard (*Verh. d. math. Congr. Zürich, 1897*).

‡ *Cf.* Schönflies, *op. cit.* p. 41.

§ To have given precision to the somewhat vague term "pure mathematics," and to have shown that all pure mathematics depends uniquely on the logical concepts at the foundation of Cantor's theory of aggregates, are two of the great merits of Russell, to whose work I have already referred.

gates †; and, for a name for an aggregate which implies that the aggregate is consistent,—and, consequently, has a cardinal number, and, if (simply) ordered, an ordinal type,—I shall, in future, use the word *manifold* ‡.

Cantor has repeatedly emphasized his view that what is essential in the conception of a manifold is the “collection by the mind of definite, distinct objects to a whole” §. In conformity with this view, we may attempt to define an inconsistent aggregate as an aggregate of which it is impossible to think as a whole without contradiction.

But for formal purposes, I use the following definition: An ‘inconsistent’ aggregate is an aggregate such that there is a part of it which is equivalent to W . Further, since “ M is a consistent aggregate” is a necessary hypothesis (*i. e.*, an hypothesis necessary to avoid contradiction) to the definitions of the cardinal number and type of M , we cannot use W (the aggregate of all ordinal numbers) in the above definition; but must use the (well-ordered) aggregate of which every well-ordered aggregate is a segment ||, which is ordinally similar to W .

5.

If, now, a cardinal number could be greater than any $Aleph$, there must be a part of the aggregate to which this cardinal number belongs, which can be made to have a one-one correspondence with W ; that is to say, the aggregate first mentioned is also inconsistent, and hence there cannot be such a cardinal number.

We may express this in other words by saying that *the cardinal number of every manifold is a definite Aleph*. Consequently all those manifolds whose cardinal numbers, although not primarily defined as Alephs, are known, must be Alephs. Such cardinal numbers are those of the continuum ($0 \dots 1$) of real numbers, of real one-valued (or even \mathfrak{C} -valued) functions of one, or a finite number, or even \aleph_0 , real variables, and of all (even \mathfrak{C} -valued) functions of \mathfrak{C} real variables; which are known to be respectively,

$$\mathfrak{C} = 2^{\aleph_0}, 2^{\mathfrak{C}}, \text{ and } 2^{2^{\mathfrak{C}}}.$$

† The name I have taken from Schröder (‘Vorlesungen über die Algebra der Logik,’ i.). Cantor had also arrived, long before me, at the same concept and name; but I only learnt of these (unpublished) investigations of his after communicating my results to him. I shall shortly return to this point.

‡ Thus, one may speak of the well-ordered aggregate (1), which has no ordinal number.

§ Cf., e. g. ‘Grundlagen,’ p. 53, remark (1); *Math. Ann.* xlvi. p. 481.

|| See Schönflies, *op. cit.*, pp. 36, 40, 41.

6.

We also deduce, from the known fact † of the magnitude relations of any two ordinal numbers, and, consequently, of any two Alephs, the theorem that: if **a** and **b** are any two cardinal numbers, then one of the relations: 'less than,' 'equal to,' or 'greater than,' holds between **a** and **b**.

This theorem was stated by Cantor in 1895 ‡, but the proof was postponed until a view over the ascending sequence of the transfinite cardinal numbers and an insight into their connexion had been obtained. This is, now, supplied by the theorem that every cardinal number is an Aleph §; but it may be observed that even if the general occurrence of one of the relations $<$, $=$, or $>$ between any two cardinal numbers **a** and **b** could be proved independently, it would by no means follow, inversely, that the cardinal numbers, when arranged in order of magnitude, form a well-ordered aggregate. For this would only prove that the cardinal numbers formed a *simply*-ordered aggregate. But further, even if we also knew that to every cardinal number was one immediately greater, and there was no greatest cardinal number, but there was a least, there would still be nothing to prevent the aggregate of all cardinal numbers from being, for example, of type

$$\omega + * \omega + \omega.$$

In this aggregate there is an immediate predecessor to *every* element, but in the aggregate of type

$$\omega + * \omega + \omega . 2,$$

this is not the case. Still, neither of the aggregates is well-ordered, since in each there is a part of type

$$* \omega.$$

7.

From the theorem:

A. If **a** and **b** are any two cardinal numbers, then either

$$\mathbf{a} = \mathbf{b}, \text{ or } \mathbf{a} < \mathbf{b}, \text{ or } \mathbf{a} > \mathbf{b}.$$

Cantor deduced || the following theorems:

B. If two manifolds M and N are such that M is equivalent to a part N_1 of N, and N to a part M_1 of M, then M and N are equivalent;

† *Math. Ann.* xlix. p. 216.

‡ *Math. Ann.* xlvi. p. 484.

§ When, of course, the existence of the series of Alephs itself is clearly established, as I shall endeavour to do in a continuation of this paper (cf. below, § 10). || *Ibid.* foot of p. 484.

- C. If M_1 is a part of M , M_2 is a part of M_1 , and M and M_2 are equivalent, then M_1 is equivalent to M ;
- D. If N is equivalent neither to M nor to a part of M , then there is a part of N which is equivalent to M ;
- E. If M and N are not equivalent, and if there is a part of N which is equivalent to M , then no part of M is equivalent to N .

Of these, B has been proved independently by Schröder † and by Bernstein ‡, and hence, if \mathfrak{a} and \mathfrak{b} are the cardinal numbers of, respectively, M and N , and M is equivalent to some part of N , we can always say that

$$\mathfrak{a} \leq \mathfrak{b}.$$

The theorems C and E, therefore, follow from A, and are thus proved independently of the theorem that every cardinal number is an Aleph.

As for the theorem D, it is easy to see that it both implies and is implied by the theorem :

It is impossible that neither a part of M should be equivalent to N nor a part of N should be equivalent to M , provided that both M and N are transfinite.

This theorem contains the settlement of the fourth possibility in the relations of equivalence of M and N and parts M_1, N_1 of them, which is the only one left undecided by the definitions of

$$\mathfrak{a} < \mathfrak{b}, \mathfrak{a} > \mathfrak{b},$$

and the theorem of Schröder and Bernstein §.

In the suppositions which I have made,—namely, in the proof of the theorem that every cardinal number is either an Aleph or is greater than any Aleph—this theorem of Schröder and Bernstein is already used, so that D is the only one of the theorems B to E which can, without a circle, be deduced from a proof that every cardinal number is an Aleph.

† “Ueber G. Cantor'sche Sätze,” *Jahresber d. d. Math.-Ver.* v. pp. 81–82 (1897); “Ueber zwei Definitionen der Endlichkeit und G. Cantor'sche Sätze,” *Nova Acta Leop.-Carol. Akad.* (Halle) lxxi. pp. 303–362 (1898).

‡ Borel, “Leçons sur la théorie des fonctions,” Paris, 1898, pp. 104–107. Cf. Schönflies, *op. cit.* pp. 16–18.

§ See Borel, *op. cit.* p. 102; Schönflies, *op. cit.* p. 15. It may be remarked that the statement in Borel's book, p. 103, may lead one to error. In his fourth case, it is obviously impossible that A should be equivalent to B if A and B are transfinite (for if it were, A would also be equivalent to some part of B) and Borel apparently contemplates this impossible state of things as possible and says that if, in this fourth case, A is not equivalent to B , there can be aggregates A and B such that their cardinal numbers are not comparable in respect of magnitude.

However, Professor Cantor † drew my attention to the fact that the method of the proof does not require this supposition.

In fact, we can, successively, make the elements of W correspond to elements (in any order) of any given aggregate C . If this process comes to an end, the cardinal number of C is an Aleph; if not, C must contain as part the inconsistent aggregate W , and is thus itself inconsistent and has no cardinal number.

With this formulation we obtain a new proof of the theorem proved by Schröder and Bernstein.

The problem as to the relations of magnitude of any two cardinal numbers is thus completely solved by the consideration of the well-ordered aggregate of the cardinal numbers of well-ordered manifolds. This entry of ordinal notions has not appeared satisfactory to Schröder ‡, since the question is one of the elementary properties of cardinal numbers; but, in fact, Schröder's proof also involves ordinal conceptions. To show this, I have given, in preference to giving a version of the original proof, a slightly different form to Zermelo's § proof; for this latter proof may be described as an exceedingly happy analysis of the Schröder-Bernstein proof,—analysis because the ordinal conceptions are brought out more clearly in it.

8.

Let \mathfrak{a} , \mathfrak{b} , \mathfrak{d} , and \mathfrak{e} be any four cardinal numbers, such that

$$\mathfrak{a} = \mathfrak{d} + \mathfrak{e}, \quad \mathfrak{d} = \mathfrak{a} + \mathfrak{b} \quad \dots \dots \dots (5)$$

This is the statement, in the language of cardinal numbers, of the hypothesis in Cantor's theorem B (which is that proved by Schröder and Bernstein), when the cardinal numbers of M_1 , N_1 , $M - M_1$, $N - N_1$ are respectively \mathfrak{a} , \mathfrak{d} , \mathfrak{b} , and \mathfrak{e} .

Then we have to prove that

$$\mathfrak{a} + \mathfrak{b} = \mathfrak{d} + \mathfrak{e}.$$

From (5),

$$\mathfrak{d} + \mathfrak{e} = (\mathfrak{a} + \mathfrak{b}) + \mathfrak{e} = \mathfrak{a} + (\mathfrak{b} + \mathfrak{e});$$

or

$$\mathfrak{a} = \mathfrak{a} + (\mathfrak{b} + \mathfrak{e}). \quad \dots \dots \dots (6)$$

† In a letter of November 4th, 1903. I had previously communicated to Professor Cantor my proof that every cardinal number is an Aleph, and, in this reply, he gave the (unpublished) proof in essentials identical with mine, which he had used in 1895 to establish the theorem A of §7, and had communicated in 1896 to Professor Hilbert and in 1899 to Professor Dedekind. I am indebted to Professor Cantor for his kindly encouragement to publish my proof.

‡ *Nova Acta Leop.-Carol. Akad.* lxxi. p. 303 (1898).

§ "Ueber die Addition transfiniten Cardinalzahlen," *Gött. Nachr.*, 1901, pp. 34-38.

Hence

$$\mathbf{a} = \mathbf{a} + \nu(\mathbf{b} + \epsilon), \dots \dots \dots (7)$$

where ν is any finite cardinal number.

If now, we can conclude, from (7), that also

$$\mathbf{a} = \mathbf{a} + \aleph_0(\mathbf{b} + \epsilon). \dots \dots \dots (8)$$

we can say, because the right-hand side of (7) becomes

$$\mathbf{a} + \aleph_0 \cdot \mathbf{b} + (\aleph_0 + 1)\epsilon = [\mathbf{a} + \aleph_0(\mathbf{b} + \epsilon)] + \epsilon,$$

that

$$\mathbf{a} = \mathbf{a} + \epsilon.$$

Similarly

$$\mathbf{a} = \mathbf{a} + \mathbf{b}. \dots \dots \dots (9)$$

From (5) and (9), now,

$$\mathbf{b} = \mathbf{a},$$

or

$$\mathbf{a} + \mathbf{b} = \mathbf{b} + \epsilon.$$

which is the equation required.

This part of the proof is purely cardinal; the ordinal part appears in the proof of equation (8) from equations (7); in other words, in the proof that it is possible to conclude from $\{\nu\}$ to \aleph_0 † in the case of (7).

From the manifold M_1 , of cardinal number \mathbf{a} , we can take away, by (6), a manifold (P_1) of cardinal number

$$\mathbf{b} + \epsilon. \dots \dots \dots (10)$$

while the remainder has still the cardinal number \mathbf{a} ; let M_2 be this remaining manifold. From M_2 we can again (by (7)) take in a similar manner, a manifold (P_2) of the cardinal number (10), and we thus obtain another remainder M_3 of

† That one cannot, in general, conclude from $\{\nu\}$ to \aleph_0 is evident from the consideration of the known relations:

$$\aleph_0^\nu = \aleph_0, \quad \aleph_0^{\aleph_0} = 2^{\aleph_0} > \aleph_0.$$

That, however, this "extended principle of cardinal induction" is legitimate in the case of the text, I had found, independently of Zermelo, in October, 1902; and the remark of the ordinal character of the proof has led me to emphasize this point in Zermelo's proof.

The extended principle of ordinal induction, or conclusion from $\{\nu\}$ to ω , as used by Schönflies (*op. cit.* pp. 45, 52, 60, 67, 235), should be compared with this. It seems true that mathematics is principally occupied with sufficient (and necessary and sufficient, in closer investigations) conditions under which one can conclude from $\{\nu\}$ to ω . Thus, if $\{s_\nu(x)\}$ be a convergent sequence of functions, and $s_\omega(x)$ thus properly denotes its limit, the most fundamental problem here is to know when one can conclude from $\{s_\nu(x)\}$ to $s_\omega(x)$ as to continuity, regularity, etc., and uniformity of convergence is important because it gives a wide sufficient condition.

cardinal number \mathfrak{a} . Proceeding in this way, we obtain a series of manifolds

$$P_2, P_3, P_4, \dots, P_\nu, \dots, \dots \quad (11)$$

and this series can stop at no finite ν , for, if it did, the equations (7) would be contradicted. Further, each P_ν has no point in common with any other P_μ and there exists † a manifold

$$M_\omega,$$

which may, however, consist of no elements, which is the *first* (in the above process) of all manifolds which is not contained in all the manifolds P_ν . This M_ω is thus defined by essentially ordinal considerations.

Let, then, \mathfrak{g} be the cardinal number of M_ω ; then, since the series (11) is of type ω , and therefore of cardinal number \aleph_0 , while each P_ν is of cardinal number (10); we have

$$\begin{aligned} \mathfrak{a} &= \aleph_0(\mathfrak{b} + \mathfrak{e}) + \mathfrak{g} \\ &= 2 \cdot \aleph_0(\mathfrak{b} + \mathfrak{e}) + \mathfrak{g} = [\aleph_0(\mathfrak{b} + \mathfrak{e}) + \mathfrak{g}] + \aleph_0(\mathfrak{b} + \mathfrak{e}) \\ &= \mathfrak{a} + \aleph_0(\mathfrak{b} + \mathfrak{e}), \end{aligned}$$

which is the required equation (8).

Accordingly, the independent proof of the theorem B appears to depend essentially on ordinal conceptions, although it is true ‡ that whatever may be the cardinal numbers of M and N, the proof requires only an *enumerable* manifold (of type $\omega + 1$) of steps.

9.

We may now deduce some general laws of calculation with transfinite cardinal numbers, analogous to those given by Cantor § for \aleph_0 ; namely, where ν is any finite cardinal number,

$$\aleph_0 + \nu = \aleph_0, \nu \cdot \aleph_0 = \aleph_0, \aleph_0^\nu = \aleph_0.$$

For this purpose I shall now prove the first of the two theorems denoted by Whitehead || in his memoir "On Cardinal Numbers" as unsolved, namely:

If \mathfrak{a} and \mathfrak{b} are cardinal numbers, \mathfrak{a} is transfinite, and

$$\mathfrak{a} \geq \mathfrak{b};$$

then

$$F. \quad \mathfrak{a} + \mathfrak{b} = \mathfrak{a};$$

† Cf. Schönflies, *op. cit.* p. 14.

‡ Cf. Schönflies, *op. cit.* p. 18.

§ *Math. Ann.* xlv. pp. 492-495.

Amer. Journ. of Math. xxiv. pp. 367-394 (1902); see especially, pp. 368, 381-383, 393.

If \mathfrak{a} belongs to the class considered by Whitehead † in a series of interesting propositions, and which is characterized by the property that

$$\mathfrak{a} = \aleph_0 \cdot \mathfrak{a}; \quad (12)$$

or, what is evidently the same thing, that there exists a cardinal number \mathfrak{D} such that

$$\mathfrak{a} = \aleph_0 \cdot \mathfrak{D};$$

the theorem F at once follows. For then

$$\mathfrak{a} = \aleph_0 \cdot \mathfrak{a} = (\aleph_0 + \aleph_0) \mathfrak{a} = \mathfrak{a} + \mathfrak{a};$$

and

$$\mathfrak{a} + \mathfrak{b} \leq \mathfrak{a} + \mathfrak{a}, \quad \mathfrak{a} + \mathfrak{b} \geq \mathfrak{a};$$

so that

$$\mathfrak{a} + \mathfrak{b} = \mathfrak{a}. \quad (13)$$

Also—and this was not pointed out by Whitehead—from (13) follows (12). For we can apply the conclusion from $\{\nu\}$ to \aleph_0 of § 8 to the equality

$$\mathfrak{a} = \mathfrak{a} + \mathfrak{a} = \nu \cdot \mathfrak{a}, \quad (14)$$

which results from the hypothesis.

If, now, M is a definite one of the well-ordered manifolds of cardinal number \mathfrak{a} , and we replace each element of M by a well-ordered manifold of two elements; then, since M consists of a cardinal number \mathfrak{b} ‡ of series, each of which is of type ω , together with perhaps, a finite number (ν) of elements §, the manifold resulting from M also consists of \mathfrak{b} series, each of which is of type ω , together with, perhaps, a finite number (2ν) of elements. This results from the known equation

$$2 \cdot \omega = \omega.$$

Since then, the resulting manifold is of cardinal number

$$\mathfrak{a} + \mathfrak{a},$$

we get equation (14).

Thus if \mathfrak{a} is any transfinite cardinal number, \mathfrak{a} is unaltered by the addition of any (finite or transfinite) cardinal number \mathfrak{b} equal to or less than \mathfrak{a} , and of these alone. Accordingly the class of such numbers \mathfrak{b} is hereby completely determined, and consequently for any cardinal number \mathfrak{a} the following rules of calculation hold:

† *Op. cit.* p. 393.

‡ It is easy to see that $\mathfrak{b} = \mathfrak{a}$.

§ Thus, if $\mathfrak{a} = \aleph_1$, M may be of type $\Omega + \omega + \nu$.

$$a + b = a \quad (b \leq a),$$

$$a + \aleph_0 \cdot b = a,$$

$$a = \aleph_0 \cdot a = \aleph_0^\gamma \cdot a.$$

The first two equations contain the properties proved by Zermelo for the class of numbers **b**, which, however, was not determined by him. This class of numbers was called by him a "group belonging to **a**" inasmuch as the members reproduce themselves or other members of the class by their diminution, by their multiplication with \aleph_0 , and by their addition in a finite or enumerable manifold of summands. If we add that the members also reproduce other members of the class also by *increase*, when this is necessary, till they become equal to **a**, we have a characterization of the group in question. Further, we shall prove later that

$$a^\nu = a,$$

and so that

$$a + b^\nu = a \cdot b^\nu = a,$$

which gives a further self-reproductive property of members of the group.

10.

If we attempt to use the method of § 9 to prove the second theorem denoted by Whitehead † as unproved; namely,

$$a \cdot b = a \quad (b \leq a),$$

or its equivalent

$$a^2 = a; \dots \dots \dots (15)$$

we are met by the fact that, just as it is necessary to have proved that

$$\aleph_0^2 = \aleph_0$$

in order to prove ‡ that

$$\aleph_1 > \aleph_0,$$

so it is necessary to prove previously the equation (15), or

$$\aleph_\gamma^2 = \aleph_\gamma,$$

where γ is any ordinal number, before the existence of the series of Alephs (1) can be proved. It is, then, necessary to investigate in greater detail the series (1) †. The importance of this may be considered as established by the fact that, having arrived at (1), we are sure that every transfinite

† *Op. cit.* p. 368, Whitehead remarked that (15) does not follow from (12).

‡ See 'Grundlagen,' pp. 35-36; *Math. Ann.* xlix. pp. 227-228, 222.

§ Cantor has hitherto only treated in detail the ordinal number of the first two classes and the cardinal numbers of these classes.

cardinal number occurs in it; and, further, we shall, by this investigation, obtain a complete solution to the problems of determining:

- (1) The result of adding any (finite or transfinite) number of any cardinal numbers;
- (2) The result of multiplying any finite number of any cardinal numbers.

There will only then remain the consideration of those cardinal numbers of the form

$$a^b$$

where **b** is transfinite. Some results as to this class of numbers, together with the detailed investigation of Cantor's "number-classes" in general mentioned above, I will give in a continuation of this paper.

Little Close, Yateley, Hants.
December 2nd, 1903.

VIII. *Note on Borgnet's Method of Dividing an Angle in an Arbitrary Ratio.* By Prof. J. D. EVERETT, F.R.S.*

I HAVE recently come across an old paper (Borgnet, in *Rouen Acad. Travaux*, 1839, pp. 113-143) containing a beautiful theorem which seems to have fallen into oblivion. The paper is devoted to what the author calls *barycentrides*, a barycentride being defined as the locus of the centroid of an arc (of any curve) measured from a definite initial point. The theorem to which I refer solves, by means of the barycentride of a circle, the general problem to divide a given angle in the ratio of any two given straight lines.

In fig. 1 let P be the centroid of the circular arc AQ, and let the curve AP be the barycentride of the circle AQ described about O. Bisect the chord OP at right angles by MH, meeting in H the perpendicular at O to the initial radius OA. Let θ denote any one of the three equal angles AOP, OHM, MHP; then we have

$$OP = 2OH \sin \theta.$$

But by the rule for the centroid of a circular arc

$$OP = OA \frac{\sin \theta}{\theta}.$$

These equations give

$$OH \cdot \theta = \frac{1}{2} OA,$$

a constant quantity. θ therefore varies inversely as OH.

* Communicated by the Author.

The application of this theorem to the division of an angle is obvious, and is illustrated by fig. 2, in which a portion of fig. 1 is reproduced with additions. The points O, 1, 2, 3, 4, 5

Fig. 1.

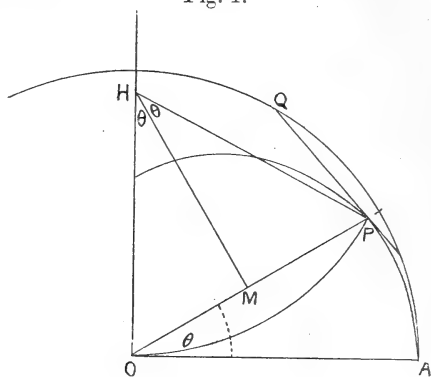
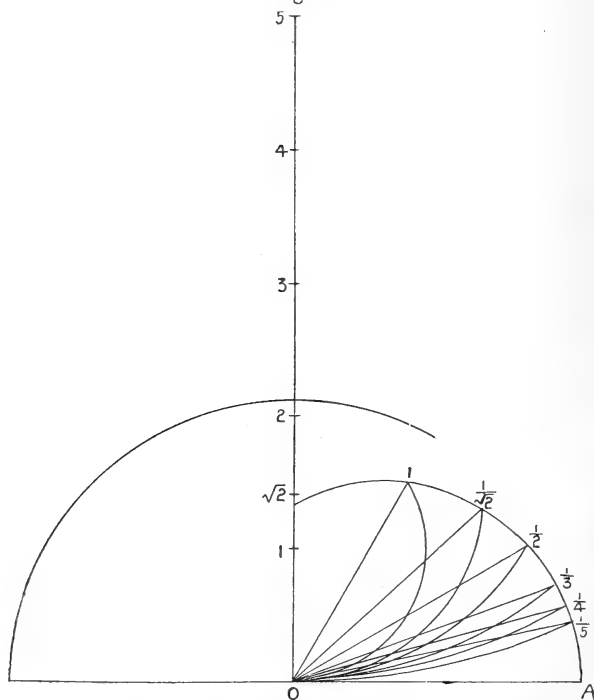

Fig. 2.



are taken at equal distances along the perpendicular to OA ; and the point $\sqrt{2}$ at a distance from O equal to the diagonal of a square whose side is the common distance. About each of these points a circular arc is described passing through O

and meeting the barycentride. Lines are drawn from O to the points of intersection, and the angles which they make with OA are inversely as the distances laid off from O along the perpendicular.

Suppose the largest of these angles (marked AO1) to be given. The corresponding point 1 on the perpendicular to OA can be found by bisecting the radius vector O1 of the curve at right angles, and the figure can be completed in accordance with the above description. We thus obtain not only the $\frac{1}{3}$ and $\frac{1}{5}$ of the given angle, but also an angle which is to the given angle as 1 to $\sqrt{2}$. The construction is extremely well conditioned.

The following values of $\sin \theta/\theta$ are useful for plotting the curve,

| | | | | | |
|----|------|-----|------|-----|------|
| 0° | 1 | 45° | .900 | 85° | .671 |
| 15 | .989 | 60 | .827 | 90 | .637 |
| 30 | .955 | 75 | .738 | | |

and a check is furnished by the fact that the tangent to the curve at P (fig. 1) must pass through Q the extremity of the arc AQ, of which P is the centroid.

When the tangent at P is parallel to AO we have $OA \sin 2\theta = OP \sin \theta$, $OA \cos \theta = \frac{1}{2} OP$; hence OP is bisected at right angles by AH, and P and O are equidistant from A. The complete curve consists of an infinite series of convolutions, all touching OA at O; and in each convolution the point furthest from OA lies on the circle described round A with radius AO.

IX. Notices respecting New Books.

CHARLES NORDMANN. *Thèses présentées à la Faculté des Sciences de Paris.* 1^{re} Thèse: *Essai sur le rôle des ondes Hertziennes en Astronomie Physique et sur diverses questions qui s'y rattachent.* Paris: Gauthier Villars. 1903.

THIS thesis for the Paris Doctorate of Science was sustained on June 13th, 1903, the examiners being Profs. H. Poincaré, Pellat, and Moissan. It is well worth the attention of all interested in astrophysical speculations, if only for the wealth of references it contains. It treats of such varied subjects as the Solar Corona, Nebulæ, Nova Persei, Aurora, and Terrestrial Magnetism. The work is mainly devoted to the exposition of the author's theories as to the causes of the several phenomena discussed, and to destructive criticism of other theories. Older views, such as Faraday's on Terrestrial Magnetism, are not neglected, and a large number of recent writers (*e. g.* Arrhenius, Bigelow, Birke-land, Deslandres, Goldstein, Lockyer, and Schuster) will find something to interest them. Before passing to theory, the author deals slightly with two positive contributions to our stock of scientific facts. He tried but failed to detect Hertzian waves proceeding from the sun, the experiment being carried out on

Mont Blanc. He also made an investigation into the connexion between sun-spot frequency and mean annual temperature, employing records from a considerable number of *tropical* stations, extending over at least one sun-spot period. Only mean results from all the stations combined are given, so that the reader cannot judge fully the part played by chance. The author appears to confirm the result reached by Koppen in 1873, that in the Tropics mean temperature *diminishes* as sun-spots increase. Between years of absolute maximum and minimum of sun-spots Nordmann (p. 18) finds an average difference of $0^{\circ}26$ C. Even supposing this small difference to be true for the whole surface of the earth, it would not *necessarily* follow, as the author seems to conclude, that the sun's thermal radiation diminishes as sun-spots increase. It may also be noted in passing that it is open to doubt whether attention should not rather be given in this connexion to the mean diurnal range of temperature.

The future alone can show the real value of the theoretical part of the Thesis. The author displays a nimble mind, and his reading seems catholic and remarkably up to date. An English reference is as recent as March 1903, and one would infer a close study of the recent papers of Huggins, Ramsay, and others, especially of J. J. Thomson and his school. The free use of very recent results has its risks, even when guided by critical insight; and an intimate knowledge of all the subjects to which Nordmann applies his theories is perhaps rather too much to expect of any one man. As exemplifying the dangers to which too rapid speculation leads, reference may be made to p. 64. Values are there quoted for diurnal ranges of declination at Batavia in 1895. The figures given actually appear in the Batavia 'Observations' (Table 26), but they have a totally different meaning from what the author supposes. The true ranges (obtainable from Table 18, *l. c.*) are much smaller, being *less* than the values the author quotes for Nice. The mistake may mean undue haste in a single instance, but no expert in Terrestrial Magnetism is likely to retain undiminished confidence in a writer who follows this up by laying it down as a general law ("loi générale") that the amplitude of the diurnal variation of magnetic declination *diminishes* as one retires from the equator! The eminent triumvirate to which the Thesis was submitted must surely have overlooked this statement. If the mathematical work on p. 115—in connexion with an estimate of auroral frequency—satisfied Prof. Poincaré, it presumably is correct, but the reviewer must confess to an inability to reconcile it with the physical problem proposed. The author is unusually successful in his spelling of English names, but he follows an American and erroneous authority when he talks—as he does repeatedly—of the "Addie" magnetograph; and when he locates this instrument at Greenwich, and describes Prof. Turner as "chef du service magnétique," he adds a little to the confusion. As the author is described as "Astronome a l'Observatoire de Nice," he is presumably more thoroughly at home with the astronomical subjects treated, and his discussions of the Corona, Nebulæ, and Nova Persei if slight are certainly suggestive.

The chief ingredients, so to speak, in Nordmann's theories are Hertzian waves (mainly from the sun), cathode rays excited by these waves (Ebert and Wiedemann), and gaseous layers of critical density for maximum illumination (J. J. Thomson). There is also occasional use of the "Maxwell-Bartoli" pressure of light as opposing gravitation. Abstracts of theories are seldom satisfactory—at least to the propounder; and the reader who wishes particulars must be referred to the original Thesis. C. C.

X. *Proceedings of Learned Societies.*

GEOLOGICAL SOCIETY.

[Continued from vol. vi. p. 723.]

November 18th, 1903.—Sir Archibald Geikie, D.Sc., F.R.S.,
Vice-President, in the Chair.

THE following communications were read:—

1. 'Notes on some Upper Jurassic Ammonites, with Special reference to Specimens in the University Museum, Oxford.' By Miss Maud Healey.

2. 'On the Occurrence of *Edestus* in the Coal-Measures of Britain.' By Edwin Tulley Newton, Esq., F.R.S., V.P.G.S.

December 2nd.—Sir Archibald Geikie, D.C.L., D.Sc., Sec.R.S.,
Vice-President, in the Chair.

The following communications were read:—

1. 'Notes on the Garnet-bearing and Associated Rocks of the Borrowdale Volcanic Series.' By the late Edward Eaton Walker, Esq., B.A., B.Sc.

The first portion of the paper is occupied with an account of various intrusive rocks. A detailed description of sills and dykes of garnet-bearing rocks in the Langstrath Valley is given; and similar rocks are described, occurring as dykes and sills around the Eskdale granite and the Buttermere granophyre, and also in the Armboth-Helvellyn area. These rocks vary in degree of acidity. They consist of diabase, porphyrite, and granophyre. Evidence of their characters being dependent upon differentiation accompanied by some absorption is offered. They appear to be related to the Eskdale and Buttermere masses of intrusive rocks.

The volcanic rocks are next considered. Garnets are found in the Falcon-Crag Group, in a group of rocks below the great banded ashes and breccias of the Scawfell Group, and in the rocks of the Scawfell Group itself; but do not seem to occur, except as the result of contact-metamorphism, in the Eycott Group. The most interesting garnetiferous volcanic rocks are those which occur below the Scawfell ashes and breccias. These rocks often have a streaky structure which exhibits four distinct types: resulting from (a) infiltration along planes of weakness, (b) lamination of ash, (c) flow of igneous material, and (d) dynamic action on included fragments. The rocks are not intrusive, but consist of lavas and ashes, often exhibiting alternating bands of rhyolite and andesite.

The banded ashes of the Scawfell Group also contain garnets.

In the Haweswater district there is an intercalation of rocks of the Eycott type with rocks possessing the 'streaky' structure. This intercalation appears to be original, and not the result of subsequent earth-movements.

The garnets are of the almandine-type. They often have a ring of felspar around them, which, when the intrusive rocks are studied, suggests that the mineral is original; but similar rings occur around garnets in the ashes, showing that the felspars may be formed in solid rock. In certain ashes of the Haweswater district, the existence of cavities in the garnets suggests a metamorphic origin for the mineral, but it is difficult to understand how the metamorphism has been produced.

The paper closes with a description of certain undoubted metamorphic changes.

2. 'A Contribution to the Glacial Geology of Tasmania.' By Prof. J. Walter Gregory, D.Sc., F.R.S., F.G.S.

On reading the literature on the glaciation of Tasmania, the author came to the conclusion that, except for such traces of high-level glacial action as those of Mount Sedgwick recorded by E. J. Dunn and T. B. Moore, and those near the summit of Mount Ida recorded by Officer, Balfour, and Hogg, the evidence consisted of material that was either not of glacial origin, or was due to glacial action at some Upper Palæozoic date. After giving a detailed analysis of the previous contributions to this subject, the author describes the evidence obtained by himself personally in the northern portion of the Island. The town of Gormanston stands on a glacial moraine of recent geological age, formed later than the excavation of the Linda Valley, and occurring as a bank projecting from the southern side of the valley, and nearly damming it across. The moraine is composed of typical boulder-clay, and behind it are bedded clays which probably accumulated in a glacier-lake above the moraine-dam. An erratic of fossiliferous limestone, $4\frac{1}{2}$ by $3\frac{1}{2}$ by $2\frac{1}{2}$ feet, scratched all over and partly polished, is mentioned, while the North Lyell Railway has cut through an enormous boulder of black Carboniferous Limestone at least 16 feet in length. The northern face of Mount Owen appears to be ice-worn to the height of about 1900 feet, while the base of the glacial deposits is not more than 700 feet above the sea. The general evidence suggests that the Eldon Range and the Central Plateau formed the gathering-ground of the ice which flowed westward and south-westward. A map is given to show the range of Pleistocene glaciation so far as it has been recorded, and also to indicate localities of the glacial deposition which probably dates from the Carboniferous Period. The lowest level at which evidence of Pleistocene glaciation has been found is 400 feet on the Pieman River. This latest glaciation is later than the formation of the peneplain of North-Western Tasmania, and occurred after the dissection of this peneplain had begun. Many of the deposits are little more altered than those of Northern England, despite the heavy rainfall; and the aspect of some of the rock-scoring is very recent.

FIG. 6.

Dattenberg bars No. 1 (2nd & 3rd heatings); No. 2 (1st heating.)

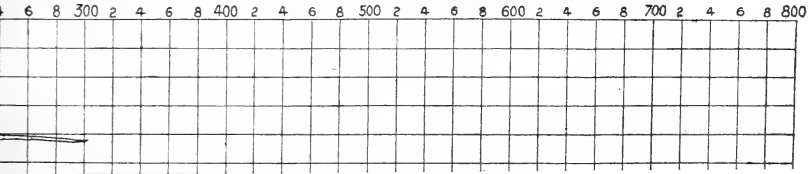



FIG. 3.
Curves I., II., and III.—Hysteresis in Rowley Blue No. 2,
Rowley Dolerite No. 2, and Dattenberg No. 1.

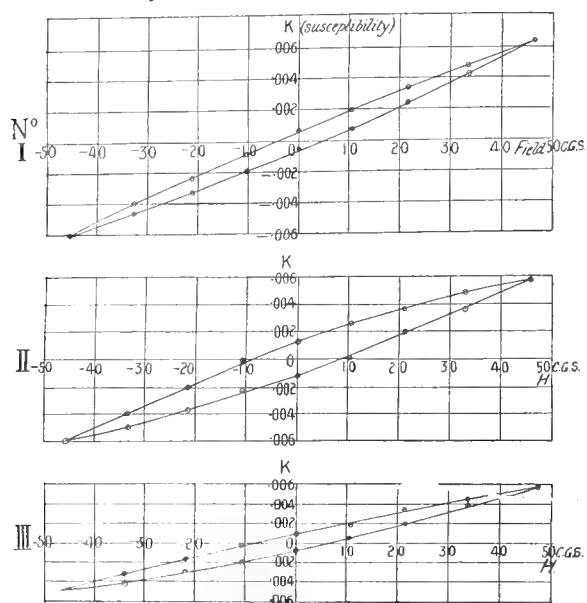

FIG. 4.
Curve IV.—Rowley Blue No. 1. Tenth heating.

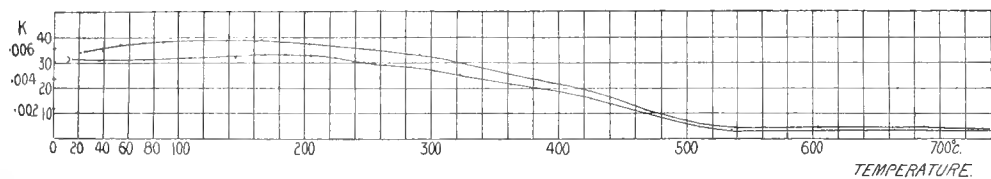

FIG. 5.
Curves V., VI., VII., VIII.—Rowley Blue No. 2, 1st, 3rd, 5th, & 6th heatings.

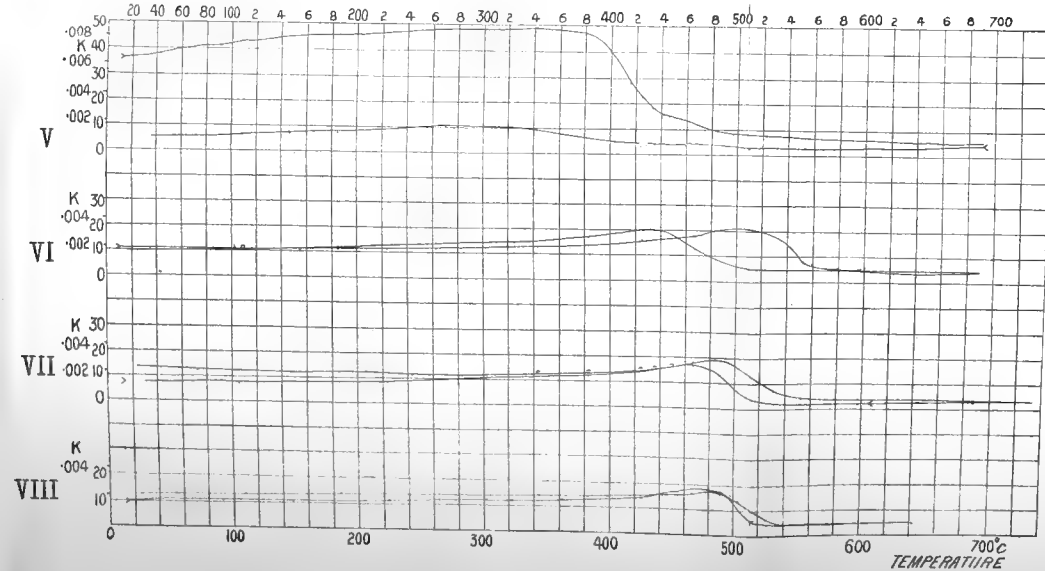

FIG. 6.
Curves IX., X., and XI.—Dattenberg bars No. 1 (2nd & 3rd heatings); No. 2 (1st heating.)

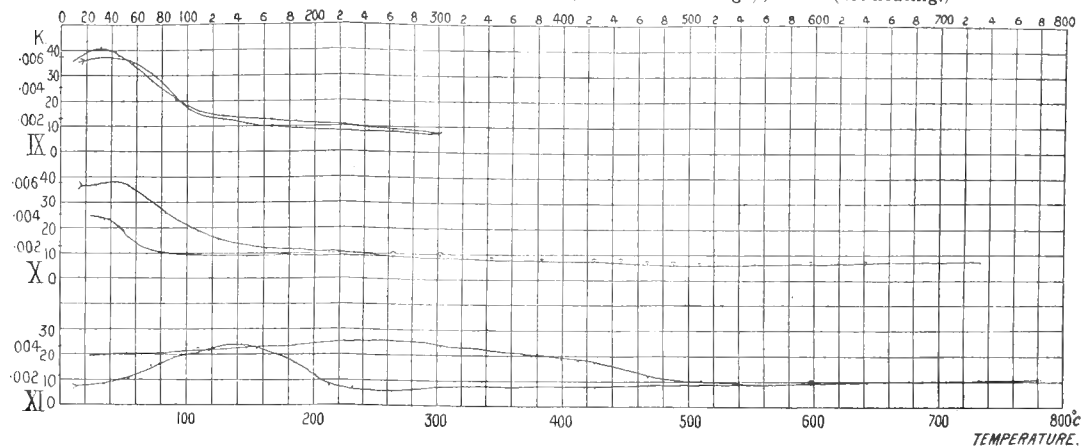

FIG. 7.
Curves XII.—Dattenberg, Nos. 3, 4, & 5. Curves with rising temperature only.

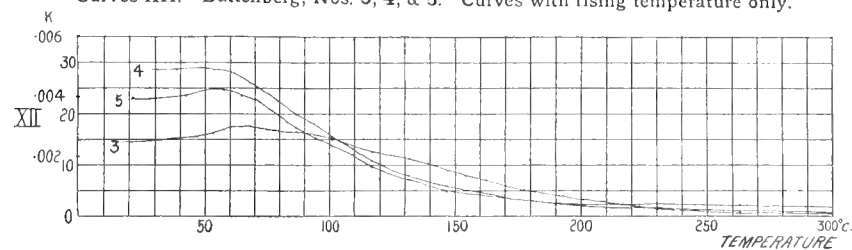

FIG. 8.
Curves XIII. and XIV.—Rowley Dolerite No. 1 (1st heating) and No. 2 (2nd heating).

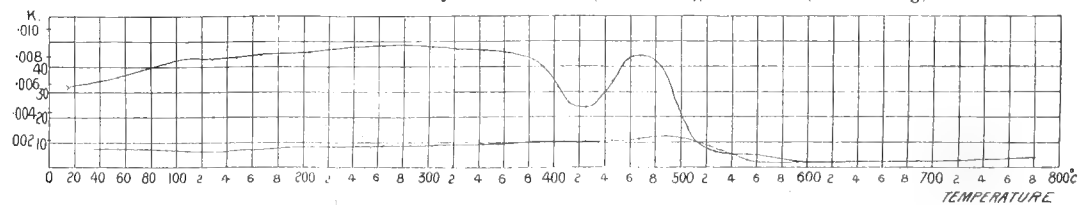

FIG. 9.
Curve XV.—Magnetite No. 1 (1st heating).

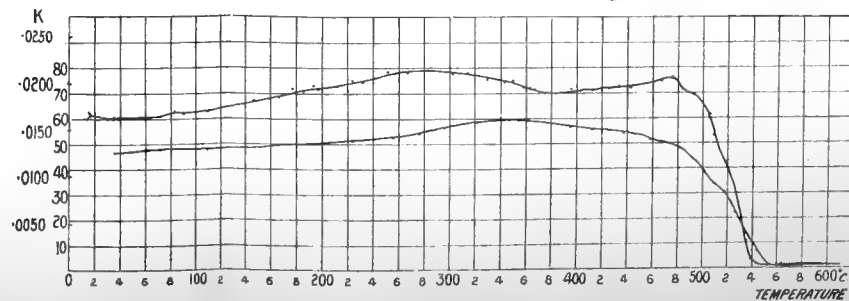



FIG. 14.

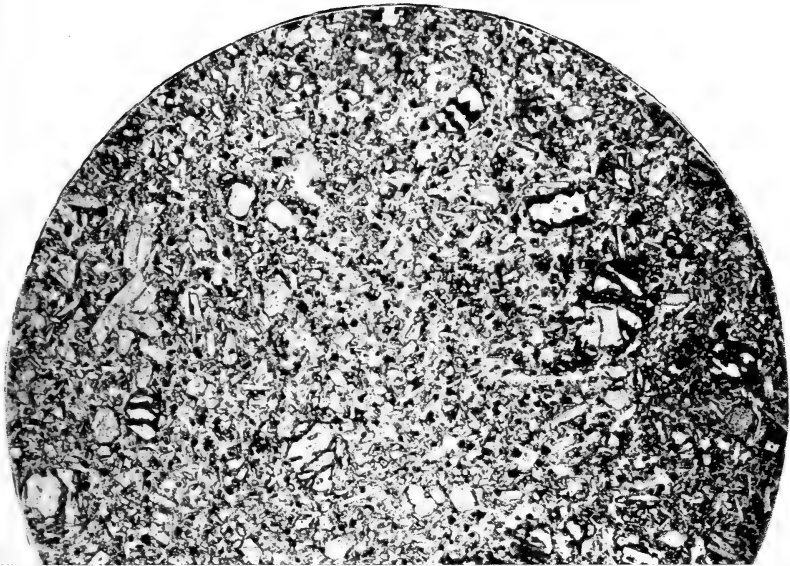
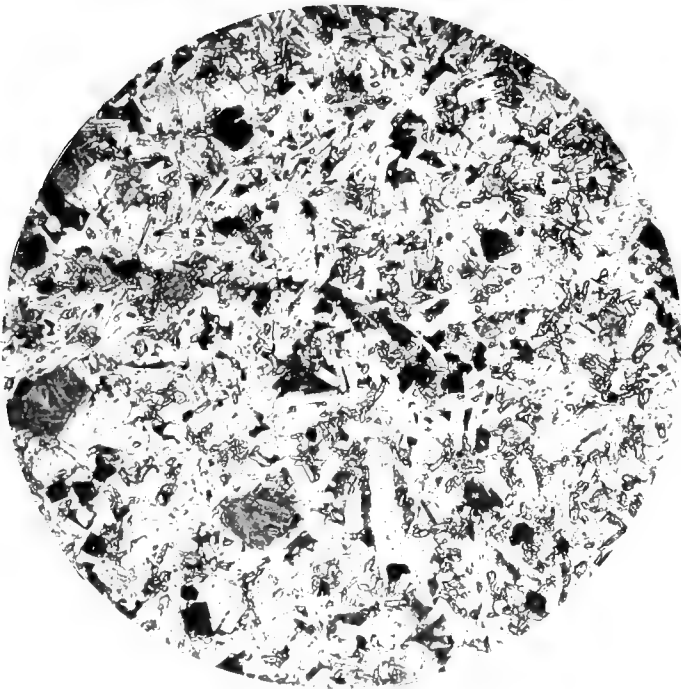

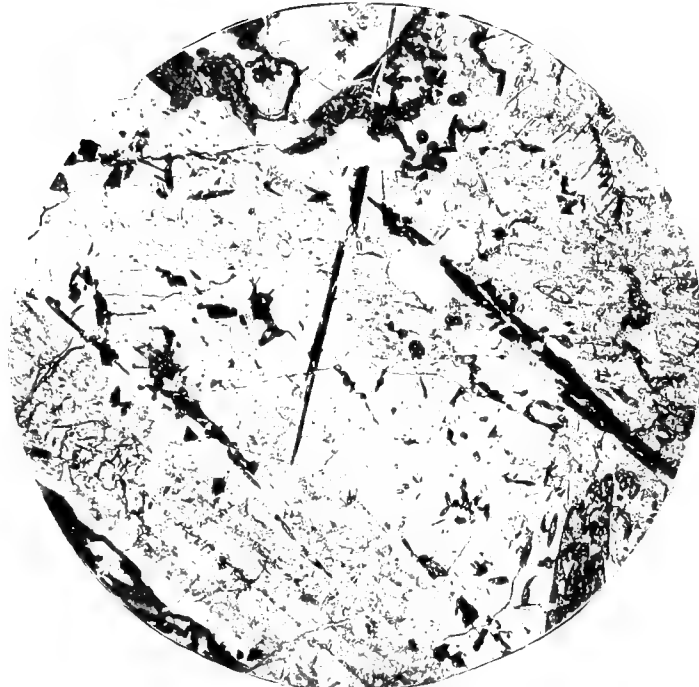

FIG. 10.



Rowley Blue, unheated.

FIG. 12.



Rowley Dolerite, unheated.

FIG. 14.

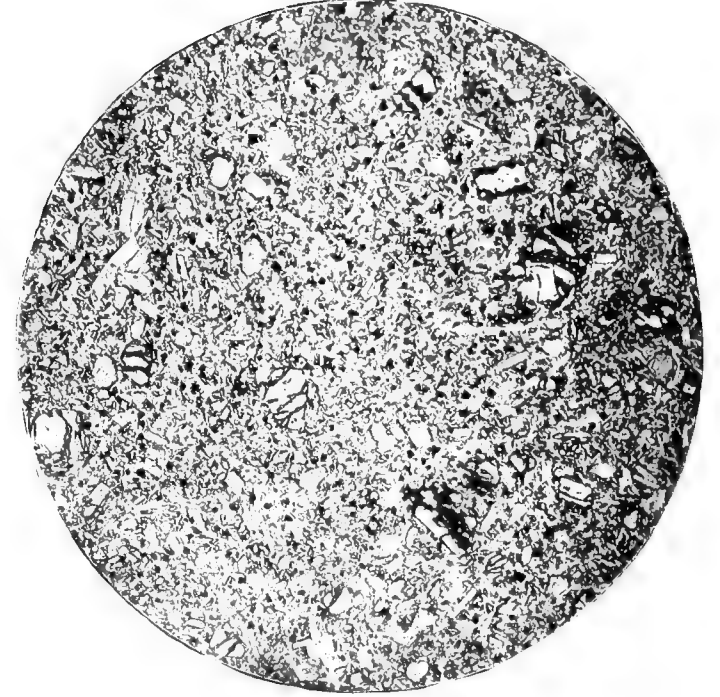

Dattenberg Basalt, unheated.

FIG. 11.

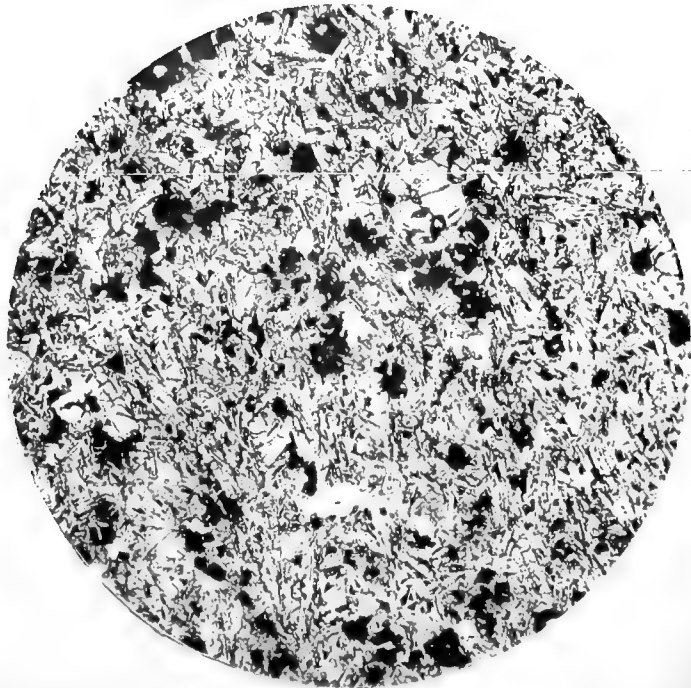

Rowley Blue, after heating.

FIG. 13.

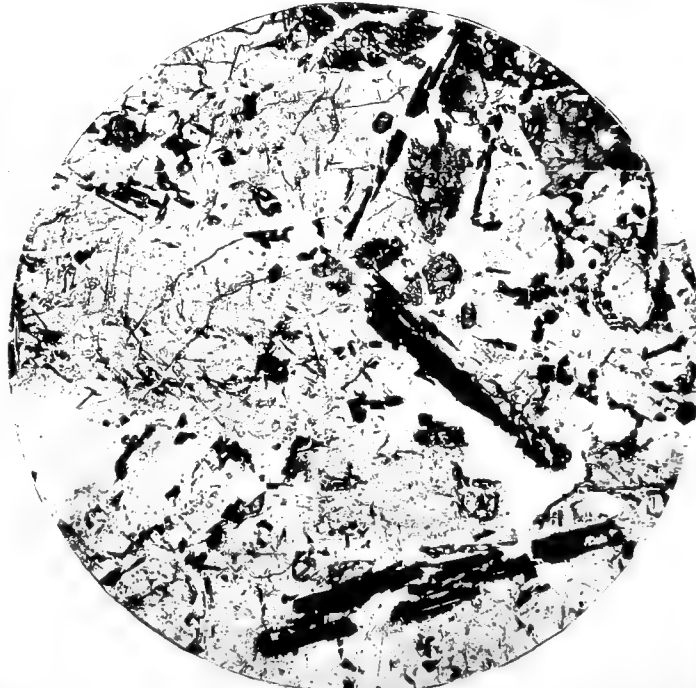

Rowley Dolerite, after heating.

FIG. 15.

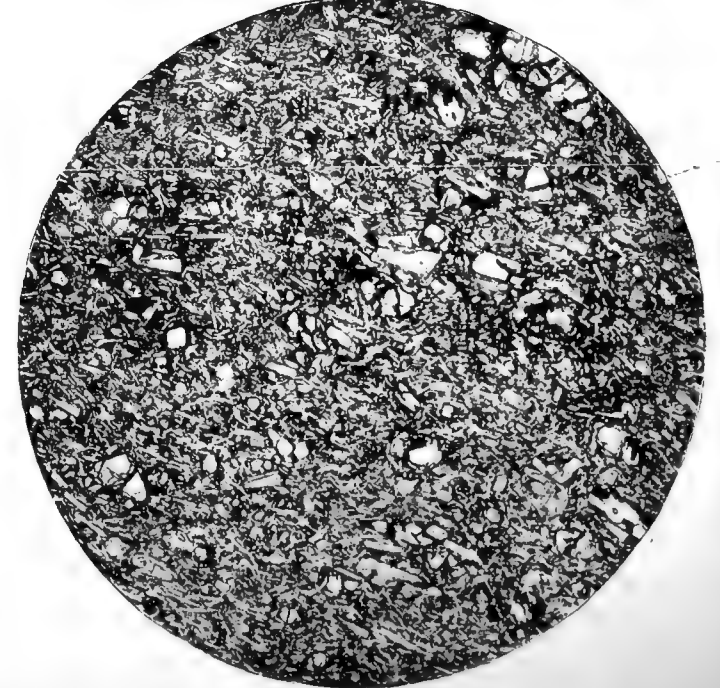

Dattenberg Basalt, after heating.

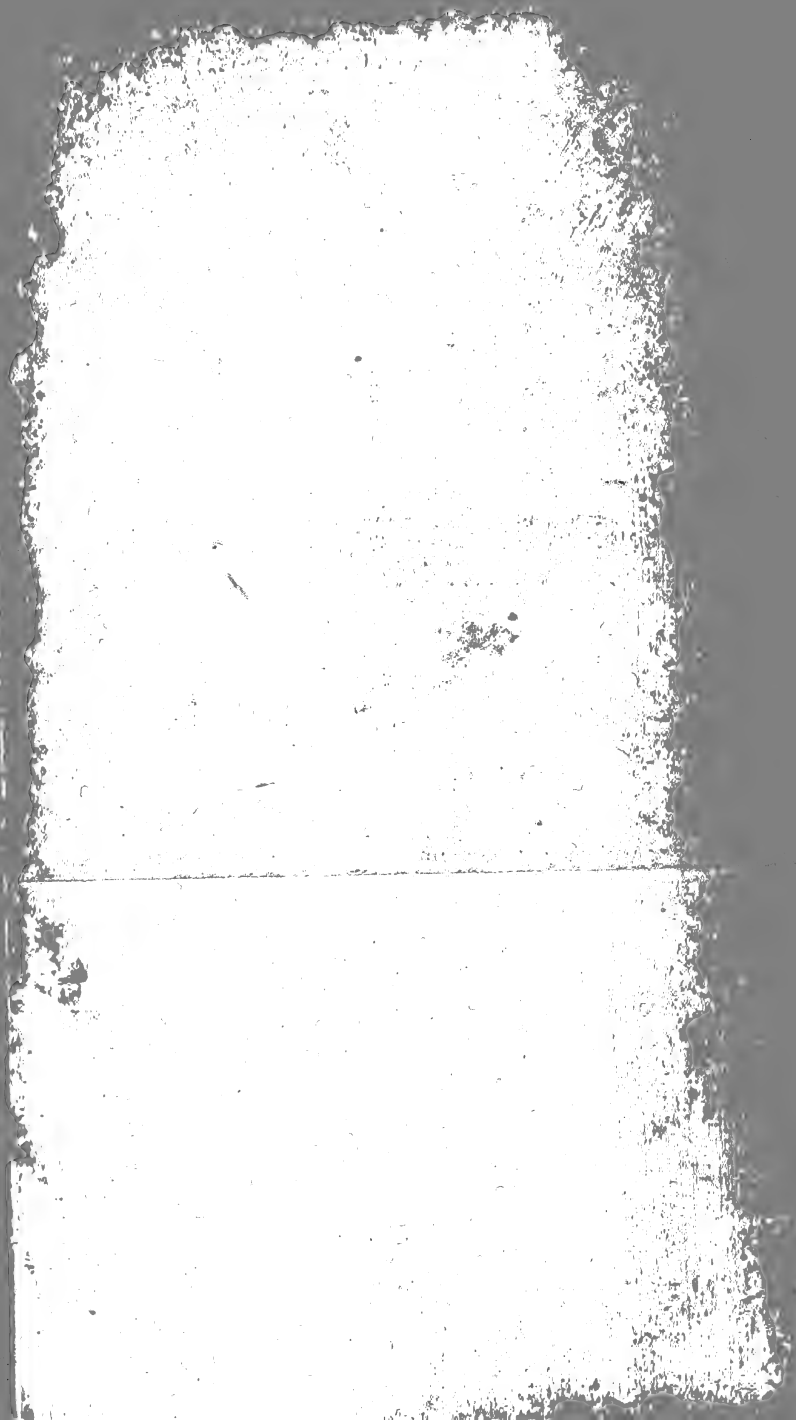

INDEXED.

THE

LONDON, EDINBURGH, AND DUBLIN

PHILOSOPHICAL MAGAZINE

AND

JOURNAL OF SCIENCE.

[SIXTH SERIES.]

FEBRUARY 1904.

XI. *The Effect of Temperature on the Ionization produced in Gases by the Action of Röntgen Rays**. By R. K. McCLUNG, M.A. (McGill), B.A. (Cantab.), Trinity College, Cambridge, "1851 Exhibition Science Scholar" †.

Introduction.

DURING the course of an investigation on the effect of temperature on the rate of recombination of gaseous ions, the results of which appeared in a previous paper ‡, some preliminary experiments were made to see what effect the temperature of the gas had upon the amount of ionization produced in it. These preliminary experiments gave results which were at variance with some experiments of Prof. Perrin § published in 1897. It was therefore considered advisable to make a fresh investigation of this subject. The results of this investigation are given in the present paper.

These experiments were carried out in order to ascertain whether a change in the temperature of a gas has any effect upon the amount of ionization produced per unit volume by the action of Röntgen rays of a given intensity, and if so to determine in what way the ionization is affected by the temperature. This was tested by the method usually employed in testing ionization under different conditions, namely, by

* A preliminary account of some of these experiments was published in the Proceedings of the Cambridge Phil. Soc. vol. xii. pt. 3, May 1903.

† Communicated by Prof. J. J. Thomson.

‡ Phil. Mag. Dec. 1903.

§ *Annales de Chimie et de Physique*, xi. p. 496 (1897).

measuring the rate of leak between two metal electrodes, or sets of electrodes, when the gas between them has been ionized. For the purposes of the present experiments this had to be done at various temperatures. The gas to be experimented upon had therefore to be inclosed in a vessel which could be heated to a fairly high temperature.

When investigating air the experiments may be made in either of two ways. The first way is to inclose the air in a vessel which is not air-tight, and which will allow the air to expand freely when heated, so that the measurements may be taken in air at a constant pressure but in which the density changes as the temperature is varied. The second way is to inclose the air in an air-tight vessel so that the volume and density of the air experimented upon are kept constant at the various temperatures. In the present investigation both of these methods have been employed. A description of each, with the results obtained, will be given in turn.

Experiments on Air at Constant Pressure.

As already mentioned these experiments arose out of the investigation on the rate of recombination of ions, and the apparatus used was originally designed for the experiments on the recombination. As it was suitable for the present experiments it was therefore employed, although it was a little more elaborate than would have been really necessary for the present instance. In fact, in the course of investigating the rate of recombination one of the quantities measured was the amount of ionization, and therefore some of the results given in this paper were obtained concurrently with those on recombination.

A full description of this apparatus has already been given in the paper on recombination of ions, and diagrams showing its general arrangement and construction also appeared in that paper. It will therefore not be necessary to give a full description of the apparatus here, but a less detailed diagram may be given for reference to show the general arrangement of the apparatus. This is shown in fig. 1.

The Röntgen-ray bulb and induction-coil were as usual inclosed in a lead-covered box, and the rays emerged through a well-defined circular orifice, A, in the lead, and passed into the brass cylinder BC, where they ionized the air. The bulb used was one with an automatic vacuum regulator attached. The brass cylinder BC was surrounded by a sheet-iron cylinder, as shown in the diagram, so that there was a uniform air-space of about 10 cms. between the two cylinders. The inclosed air was heated by means of a long Bunsen

burner placed underneath the outside cylinder, and which ran almost the whole length of the iron cylinder. The air in the brass cylinder was thus surrounded by a jacket of heated air, and by regulating the supply of gas to the burner the

Fig. 1.

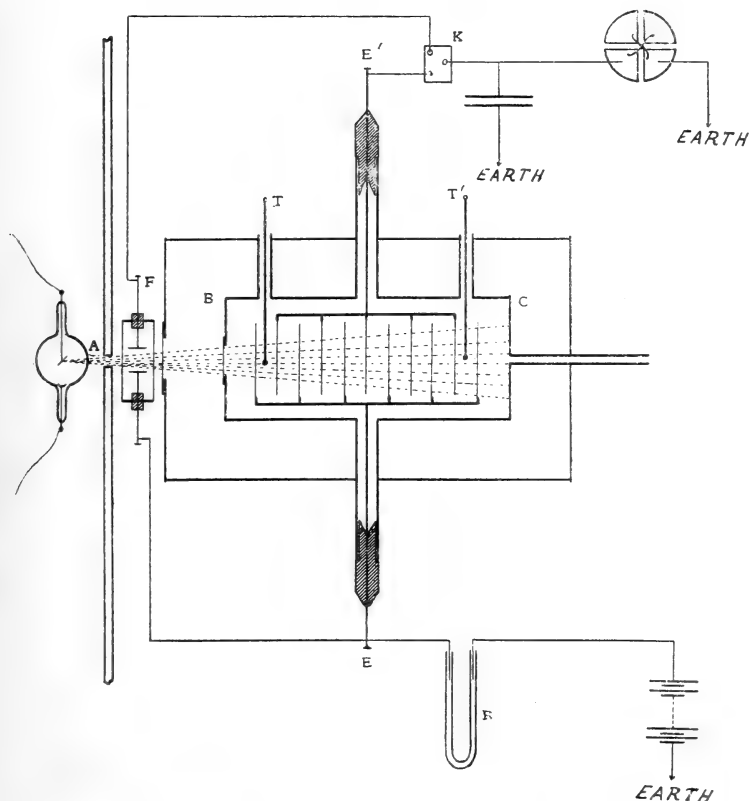

temperature of the air in the cylinder BC could be kept fairly constant for a considerable time. The temperature of the air was measured by the two mercury thermometers T and T' shown in the diagram, and the mean of the temperatures indicated by these thermometers was taken as the average temperature of the air under investigation.

The electrode E' was connected in parallel with a condenser to one pair of quadrants of an electrometer, while the other pair was to earth. The electrometer used throughout the experiments was one of the Dolezalek type which gave about 2000 scale-divisions for a difference of potential

of one volt between the quadrants when the needle was charged to 120 volts. The other electrode E was connected through a large liquid resistance R to one pole of a battery of accumulators, while the other pole was to earth.

Now if the gas between two insulated electrodes be ionized by a constant source of ionization, and if to one of these electrodes a steady voltage be applied sufficiently large to extract all the ions from the gas before they have time to recombine, the other electrode will charge up at a rate proportional to the number of ions produced in the gas per second. The rate at which this electrode charges up will therefore be a measure of the amount of ionization produced in the given volume of gas per second. The deflexion of the electrometer-needle per second, which is proportional to the rate at which E' charges up, will be proportional to the amount of ionization produced in the gas, and will therefore be a measure of the amount of ionization.

To measure the ionization at different temperatures of the gas the following method was adopted. The rays were started and allowed to pass into the cylinder for an interval of five or ten seconds, so that the ionization might reach a steady state. During this interval the electrode E' and the quadrants of the electrometer were connected to earth. At the end of this time the quadrants connected to E' were insulated, by a key worked at a distance by means of a cord, and were allowed to charge up for a given number of seconds, and at the end of the given time the rays were stopped and the deflexion of the electrometer-needle observed. Several readings like this were observed at the ordinary temperature of the room and the mean of these readings taken. The cylinder and inclosed air were then heated up to a given temperature, and when the temperature became steady the deflexions were observed as before. This having been done the air was once again heated to a still higher temperature and the deflexions again observed. This was done for several temperatures up to the highest one investigated. The amount of ionization at the different temperatures could thus be compared by comparing the deflexions obtained at these temperatures.

Instead of starting the series of readings at the lower temperature and gradually heating the air up to the higher temperatures, the order of procedure was in some cases reversed, and the air was heated up to the highest temperature to start with, and the deflexion corresponding to the ionization observed. The gas was then gradually cooled down from point to point, observations being taken at each temperature. Similar results were obtained in both cases.

In making this comparison it was very essential that the source of ionization should remain constant in intensity throughout the series of observations, otherwise no comparison could be made unless the amount of variation in the intensity was known. Even when using an automatic regulating bulb it is almost impossible to obtain perfect regularity in the intensity of the rays. When taking the observations the bulb was run as far as possible at regular intervals so as to keep it steady, and also several readings were taken in each case and the mean taken. However, even with these precautions, one cannot be certain as to whether the rays remain constant in intensity throughout the experiment unless some independent check is employed in order to test their constancy. For the purpose therefore of testing the constancy of the rays a small standard apparatus was introduced between the source of the rays and the large cylinder as shown in fig. 1. It is shown in detail in fig. 2. It consisted simply of a rectangular cylinder

Fig. 2.

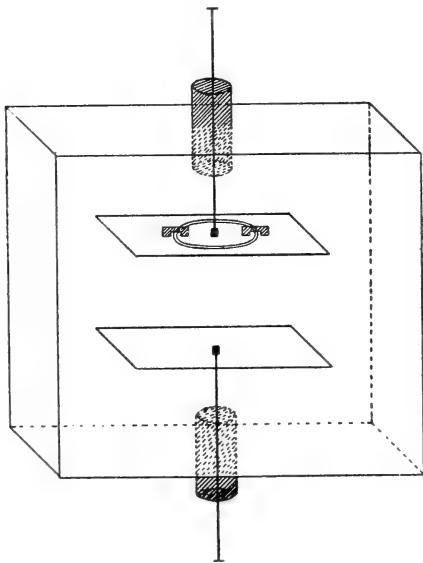

made of sheet-lead about 12.5 cms. square and 10.4 cms. in length, and the ends were covered with paper. It contained two parallel zinc plates, about 9 cms. square, acting as electrodes. One of these plates was connected to the same pole of the battery as E. From the central part of the other plate was cut a circular disk 3.5 cms. in diameter, and this was

insulated from the other part of the plate. The outer part of the plate acted as a guard-ring and was connected to earth, while the central disk could be connected to the electrometer by the key K when desired. The rays passed between these plates on the way to the brass cylinder, and ionized the air between them. If the intensity of the rays remained constant the saturation-current between these plates should be constant, and any variation in the intensity of the rays should be shown by a corresponding variation in the current. After the readings had been taken on the air in the cylinder BC, the connexion at K was transferred to the electrode F, and the rate of leak in the standard apparatus measured. By this means it could be determined whether any variation, which might occur in the rate of leak between the electrodes in the cylinder BC, was due to a variation in the intensity of the rays or to some other cause. This therefore served as a test of the rays.

In observing the amount of ionization, as indicated by the deflexion of the electrometer-needle, it was found that as the temperature of the air increased the deflexions decreased, and that they varied in the inverse ratio to the absolute temperature. Now we must take into account here the fact that as the temperature of the air is increased its density decreases in the inverse ratio, since the gas is quite free to expand into the outside air. It was shown by Perrin* that the amount of ionization produced in a gas is proportional to the pressure of the gas, and this result was later confirmed by Rutherford and McClung†. Therefore, in the present instance, when the density of the gas decreases, there would be a corresponding decrease in the amount of ionization produced, due entirely to the change in density. To determine the effect on the ionization due to a change of temperature alone, a correction must be made for the change of density of the gas. In making these experiments then it was found that the decrease in the amount of ionization which took place as the temperature rose was just the amount of decrease which would occur on account of the decrease in the density of the gas, and when the necessary correction was made for the change of density no alteration in the amount of ionization was produced by the variation of the temperature itself. In other words, if the density of the gas were kept constant the amount of ionization produced by rays of given intensity would be independent of the temperature of the gas. A series of readings is given in Table I. as a sample of the results which were obtained.

* *Annales de Chimie et de Physique*, xi. p. 496 (1897).

† *Phil. Trans.* cxevi. (1901).

TABLE I.—Air.

| Amount of Ionization as represented by Deflexions of Electrometer Needle. | | Temperature of Air. |
|---|---|---------------------|
| Observed Deflexion in Scale-Divisions. | Corrected for Change in Density of Air. | |
| 267 | 267 | 15° C. |
| 232 | 279 | 74° |
| 199 | 272 | 120° |
| 179 | 266 | 155° |
| 157 | 258 | 201° |
| 131 | 248 | 272° |

The correction for the change in density of the air is made so that the deflexions at the higher temperatures are all reduced to the same standard as that at the lowest temperature observed.

Although the numbers in the second column are not perfectly constant yet the variation is quite within the limits of experimental error, especially when we consider the difficulty of keeping the intensity of the source of ionization constant. The maximum variation in these numbers from the mean is only about 6·5 per cent., which is really very good when working with Röntgen rays. The agreement is quite close enough to show that the apparent variation in the ionization when the temperature is raised is due entirely to the change of density of the air and not to the change in the temperature directly.

Experiments on Air at Constant Density.

After concluding the experiments just described I attacked the question by the second method mentioned at the beginning of this paper, measuring the amount of ionization produced in a volume of gas inclosed in an air-tight vessel and kept at a constant density. This method is much more definite than the first one. If the air is inclosed in an air-tight vessel then the only thing that can affect the ionization in it when the air is heated is the change of temperature itself. The question is consequently simplified by getting rid of the change of density.

Although this method simplified matters in one respect it complicated them in another, for at the very outset the difficulty arose of constructing a suitable vessel which would

remain air-tight at the higher temperatures. There must of necessity be in the vessel some joints between different materials, and the problem of how to make these joints air-tight presented considerable difficulty. Several methods of making the vessel air-tight were tried, none of which proved satisfactory until the following apparatus was evolved, which is shown in detail in fig. 3.

Fig. 3.

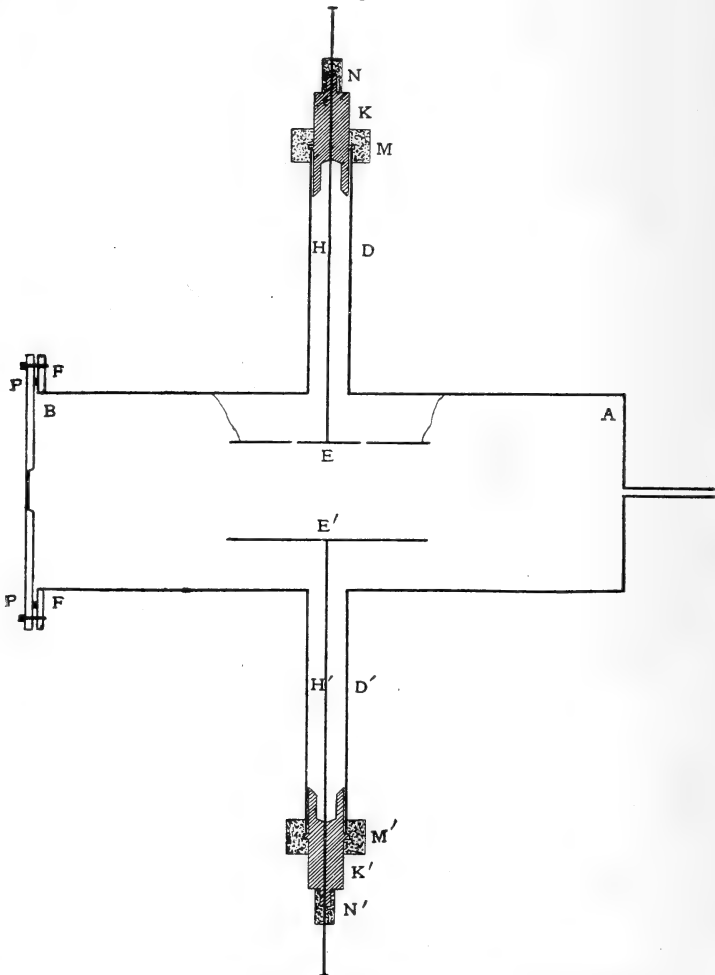

AB was a circular brass cylinder 24 cms. long and 7.6 cms. in diameter. The end A was joined on to the cylinder by brazing. All the brass joints were made by brazing wherever

it was possible to do so, for solder joints were of no use, as some of the temperatures reached in the experiments were above the melting-point of solder. On the end B there was brazed a heavy brass flange, as shown at FF. PP was a thick aluminium plate 6 mms. in thickness, made so as to fit flat upon the flange. The central part of this plate was recessed to a depth of 5 mms., as shown in the diagram, so as to allow the rays to pass easily into the cylinder. To make the junction between this plate and the flange air-tight a lead wire, drawn down to a thickness of between one and two millimetres, was laid flat upon the flange, having one end neatly overlapping the other, and then the plate PP was placed flat upon this wire and tightly screwed down to the flange, by means of strong iron screws, until the lead wire became flattened down to half its thickness or less. This joint proved very satisfactory, and was capable of withstanding any of the temperatures employed in the experiments.

E and E' were two parallel brass plates between which the rate of leak was measured, the rays passing between them after entering at the end B. The plate E was surrounded by a guard-ring connected to earth. These plates were supported by the heavy brass rods H and H' which passed out through the large insulating ebonite plugs K and K'. These ebonite plugs fit into the ends of the brass tubes D and D', and these tubes were made of considerable length so that the insulation might be removed as far as was convenient from the cylinder which was to be heated. To make the junctions between the ebonite plugs and the brass tubes air-tight large rubber corks M and M' were bored to fit tightly over them, and then they were bound round tightly with heavy wire. A similar joint was made at N and N' by means of heavy rubber compression-tubing. These junctions also proved very satisfactory.

The cylinder and the inclosed gas were heated by means of an electric current passing through a coil of german-silver wire wound tightly round the outside of the cylinder, and insulated from the cylinder by means of sheet-asbestos. By this means the gas in the cylinder could be heated up fairly quickly, and by regulating the current the temperature of the gas could be kept quite steady. The temperature of the gas was measured by means of a mercury pressure-gauge R connected to the tube T, as shown in the diagram in fig. 4, where the general arrangement of the apparatus is shown. The increase in temperature, as indicated by the expansion of the gas, was measured by the height to which the mercury in the arm L rose above a fixed point Q. The mercury in

the arm Q could always be brought back to the same point by adjusting the height of the mercury reservoir S, and the gas in the cylinder could thus be kept at a constant volume

Fig. 4.

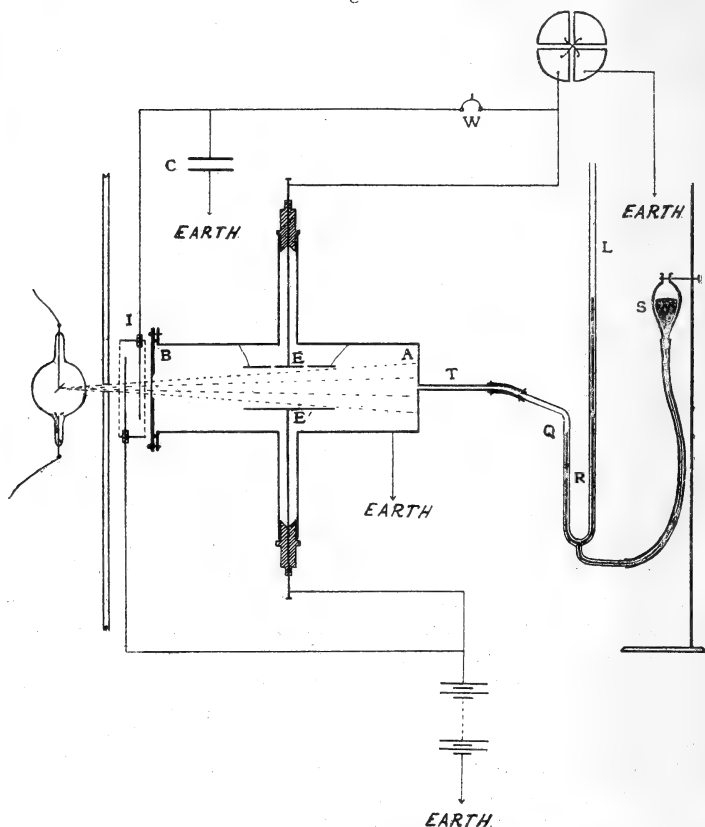

and density. Measuring the temperature by this method obviated the necessity of inserting a mercury thermometer into the vessel, and thereby the number of air-tight junctions to be made was lessened.

The manner of taking observations was somewhat similar to that already described in the first method. In some cases the ionization was measured at the ordinary temperature of the room, and then the gas was gradually heated up from point to point. In other cases the reverse order was followed and the ionization was measured at the highest temperature first and the gas then gradually cooled down, and measurements taken at the various temperatures.

A slightly different form of standard apparatus for testing the intensity of the rays was used in this case also. A diagram of it is shown in fig. 5. The electrodes in this

Fig. 5.

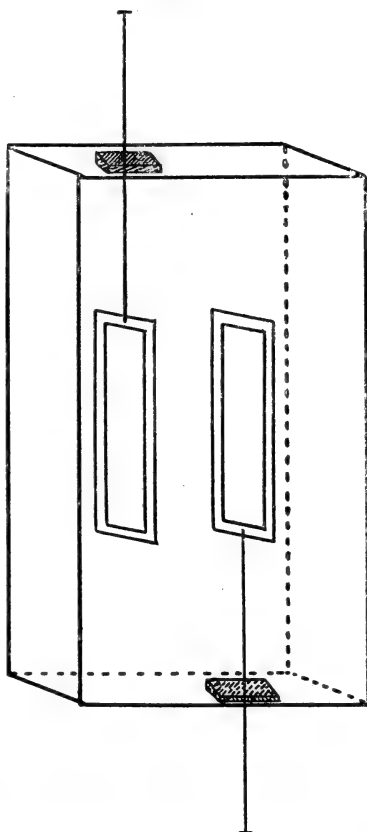

case consisted of extremely thin aluminium foil stretched on copper frames, and the rays passed through at right-angles to the plane of the foil. This form was adopted in order that the standard apparatus might be made to occupy less space, so that the cylinder might be placed as close up to the source of rays as possible. This standard apparatus was arranged as shown in fig. 4. One electrode was connected to the same pole of the battery as the electrode E' . The other electrode was connected in parallel with a condenser C through a key W to the electrometer. This key was worked at a distance by means of a cord, and could be opened at the same instant as the key by which E was insulated.

In taking the observations the rays were started and allowed to run for a definite number of seconds, so that the ionization might reach a steady state, both the electrodes E and I being to earth during this time. At the end of this interval the electrode E was insulated and the key W opened simultaneously, and the rays were allowed to run for a given time. The electrodes E and I were thus allowed to charge up for exactly the same time, and under the influence of the same cone of rays. The reading of the electrometer corresponding to the charge on E was observed, and then the quadrants of the electrometer were discharged and again insulated, and the key W was then closed and the deflexion corresponding to the charge on I observed. This served therefore as a very close check on the constancy of the rays during exactly the same time as the measurements were being made in the cylinder AB.

The first gas tested with this apparatus was of course air, in order to see if the results would be in agreement with the previous experiments. Observations were taken over a range of temperature of nearly 200° C., and the results obtained exactly confirmed the previous results which I had obtained. In this case when the density of the air was kept constant, the amount of ionization also remained constant. The change of temperature of the air had no effect whatever upon the amount of ionization produced in it. A set of results obtained is shown in Table II. as a specimen.

TABLE II.—Air.

| Ionization as represented by Scale-Divisions for the Cylinder AB. | Ionization as represented by Scale-Divisions for Standard Apparatus. | Temperature of Air in Cylinder AB. |
|---|--|------------------------------------|
| 83·7 | 27·0 | 201° C. |
| 86·5 | 30·3 | 152° |
| 82·8 | 27·7 | 118° |
| 85·8 | 31·5 | 87° |
| 80·4 | 28·5 | 45° |
| 83·2 | 28·5 | 14° |

From the results obtained therefore by the two methods there appears to be no doubt whatever that, when the density of a given volume of air is kept constant, the amount of ionization produced in it per second by rays of a given intensity is quite independent of the temperature of the air.

Measurements on Carbon Dioxide and Hydrogen.

The next gas experimented upon was carbon dioxide. It was treated in exactly the same manner as air had been. It was prepared in the ordinary way by the action of pure hydrochloric acid on marble, and was dried by passing it over pumice-stone moistened with strong sulphuric acid before it entered the cylinder. The results obtained with this gas were quite in accordance with those obtained for air. Observations were taken over an even greater range of temperatures than in the case of air, and the same law was found to hold with the carbon dioxide as was shown to hold in air. A series of results for this gas is shown in Table III.

TABLE III.—Carbon Dioxide.

| Ionization as represented by Scale-Divisions for the Cylinder AB filled with CO ₂ . | Ionization as represented by Scale-Divisions for Standard Apparatus. | Temperature of CO ₂ in Cylinder AB. |
|--|--|--|
| 80.1 | 24.9 | 222° C. |
| 84.4 | 25.1 | 182° |
| 82.0 | 25.2 | 146° |
| 79.1 | 24.6 | 108° |
| 83.8 | 26.2 | 69° |
| 87.1 | 25.3 | 17° |

A considerable number of experiments were also made on hydrogen. It was found very difficult to obtain really satisfactory results with hydrogen on account of the great difficulty experienced in making the cylinder perfectly gas-tight for this gas. The joints which proved so satisfactory in the case of air and carbon dioxide gas did not serve the purpose so well in the case of hydrogen, on account of the greater ease with which it diffuses, and I was consequently never able to make the vessel perfectly gas-tight for hydrogen. The difficulty was also increased by the fact that the amount of ionization produced in hydrogen is so much smaller than in the other gas, and therefore the effect to be measured was much smaller. Consequently the results obtained for hydrogen were not so accurate as those obtained in the case of air and carbon dioxide. However, taking the results as a whole, I think we may conclude that the same law holds for hydrogen as holds in other cases. Table IV. contains a set of results obtained for hydrogen.

TABLE IV.—Hydrogen.

| Ionization as represented by Scale-Divisions for the Cylinder AB filled with H ₂ . | Ionization as represented by Scale-Divisions for Standard Apparatus. | Temperature of H ₂ in Cylinder AB. |
|---|--|---|
| 89 | 299 | 226° C. (approx.) |
| 96 | 295 | 187° " |
| 88 | 302 | 148° " |
| 78·9 | 304 | 112° " |
| 79·9 | 295 | 78° " |
| 66·7 | 284 | 14° " |

Although there is considerable variation in the above numbers, still I think this want of constancy can be accounted for chiefly by the leakage in the vessel. However, from all the results obtained, I think we may safely conclude that hydrogen follows the same law for the effect of temperature on the ionization as has been established for air and carbon dioxide.

Discussion of Results.

The experiments described in this paper have proved conclusively that in a given volume of gas, kept at a constant density, the amount of ionization produced by Röntgen rays of a given intensity is independent of the temperature of the gas. Prof. Perrin, in the paper to which reference has already been made at the beginning of this paper, described some experiments which he made on this same question. The results which he obtained are, however, not in agreement with those which I have just given in this paper. The method which he employed was a differential one. He made the rays to pass simultaneously between two sets of parallel plates. He then balanced the effect produced on one set of electrodes against that produced on the other set, so that the resultant effect produced on the electrometer was zero. This balance was adjusted at a certain temperature, and then the temperature of the gas in the vessel containing one set of plates was varied and the balance then tested. For the range of temperature from -12° to 148° C. he found no appreciable alteration in the balance. He concludes therefore that, since no change in the balance occurred and the density of the air varied inversely as the absolute temperature, the total ionization would be proportional to the absolute temperature in air maintained at a constant density. I cannot account with

certainly for the discrepancy between his results and those which I obtained, but I think it probable that the apparatus which he used may not have been sensitive enough to detect the alteration in the ionization. He mentions that at the higher temperatures the "heated vessel appeared less active," but attributed this to some other cause. It looks extremely probable that this was a genuine effect, but that the detecting instrument was not sensitive enough to show the effect to a sufficiently great extent. In the experiments which I did the electrometer used was a very sensitive one, giving a deflexion of about two thousand scale-divisions for a difference of potential of one volt between the quadrants. There was therefore no difficulty in detecting any alteration that might take place in the ionization.

In conclusion I desire to express my thanks to Prof. Thomson for the kindly interest shown and advice given throughout the course of this investigation.

Cavendish Laboratory,
Cambridge, Nov. 5th, 1903.

XII. *Investigation of the Arc in Metallic Vapours in an Exhausted Space.* (Contribution from the Research Laboratory of General Electric Co., Schenectady, N.Y.) By E. WEINTRAUB, Ph.D.*

[Plates III.-XI.]

Introduction.

WHILE the carbon arc has been the object of a great number of investigations, the arc between mercury electrodes, which offers much simpler relations from a theoretical point of view, has so far been investigated but very little. We may distinguish between two distinct periods. In the first one the investigation was limited to the mercury arc in air. Thomas Way (1857), (1861)† was probably the first to publish observations on a mercury arc in air. One of his electrodes consisted of a stream of mercury, the second one of a mass of mercury or a piece of carbon, upon which the stream was caused to flow.

Beginning at that time, a number of inventors occupied themselves with the arc, and a great number of patents were taken out on this subject. They were all founded on the same principle as the lamp of Way, and did not contribute anything essentially new to the art or science.

* Communicated by the Author.

† Dingler's Polytechn. Journ. vol. clvii. p. 399 (1860); vol. clix. p. 46 (1861); also U.S. Pat. 3345, Oct. 8 (1861); Eng. Pat. 2841 (1857).

A certain advance is represented by the patent of Rapiëff*, who used a closed vessel with two mercury electrodes, and started the arc by bringing the electrodes into contact and separating them. He used a cooling chamber to condense the vaporized mercury, and speaks of the advisability of exhausting the tube in which the arc is to play.

The study of the mercury arc in an evacuated space begins, however, with Arons, who published his observations in *Annalen der Physik*, vol. lviii. p. 73 (1896), also in *Verh. Phys. Ges. Berlin*, p. 55 (1892), and *Zeitschr. für Beleuchtungs-wesen*, Aug. 15, 1895. From these articles we may date the second period in the development of the mercury arc. Arons described the general properties of the mercury arc, of the electrodes, and even constructed a small mercury-lamp which can be used as a source of light, especially for laboratory experiments. Arons also investigated, to a certain extent, the behaviour of amalgams in the tube. The work of Arons will be mentioned many times in the course of this article.

Gumlich published a few observations on the use of cadmium amalgam as an electrode in *Wied. Ann.* vol. lxi. p. 401, (1897). Further work on the mercury-lamp, especially the method of starting the lamp by an inductive high-voltage shock, has been done by Peter Cooper Hewitt.

This publication contains some results of the work carried out in the Research Laboratory of the General Electric Company. Only those results are mentioned which are of interest from a theoretical point of view, while the practical side of the question is not considered.

§ 1.

Starting of an Arc in Metallic Vapours. Properties of the Cathode.

Metallic vapours, such as vapours of mercury, alkali metals, and some of the heavy metals, which have been investigated, have, even when overheated to a considerable degree, only a very slight conductivity, which in the case of mercury, according to J. J. Thomson (*Phil. Mag.* [5] vol. xxix. pp. 358 & 441, 1890; see also Strutt, *Phil. Mag.* [6] vol. iv. p. 596, 1902), is of the same magnitude as that of air. The starting of an arc between two mercury electrodes in a well-exhausted tube, by means of moderate voltage, presents, therefore, difficulties which have been overcome by previous investigators in two different ways, both of which were used by Arons.

* Eng. Pat. 211 (1879).

One of the methods consists in bringing the two mercury surfaces, which have to serve as electrodes, into contact, then separating them and lengthening slowly the arc by moving one of the mercury electrodes away.

The other method is founded on the principle of breaking down the initial resistance (dielectric strength) of an evacuated space to passage of current by a high-voltage discharge. This method was further developed with a view to commercial application of the arc as a source of light by Peter Cooper Hewitt (*Electrical World and Engineer*, p. 641, April 20, 1901).

From a practical point of view the two methods are inconvenient. The first one requires a large mass of mercury, and the starting, especially of long arcs, is slow and uncertain. The second one needs rather complicated arrangements for the production of the high-voltage shock, and has other disadvantages which need not be discussed here.

The new way of starting the passage of a current of low voltage through metallic vapours that is to be described in this paragraph solves, from a practical standpoint, the problem of starting long arcs in a convenient way and instantaneously, without the help of any higher voltage than that necessary for maintaining the arc; while from a theoretical point of view it throws some light on the mechanism of the conductivity of the arc in general. The results obtained can be conveniently expressed by using the modern terminology of the theory of ionization in gases, and the principle discovered can be considered as the first application, to my knowledge, of that theory to a practical problem.

The following series of experiments will serve to lead up by degrees to the recognition of that principle.

Experiment 1.—Fig. 1 (Pl. III.) represents a glass tube ABCD, which has four cups A, B, C, D, filled with mercury. The tube is exhausted by means of a mercury-pump of the Sprengel type to as high a degree of vacuum as possible. The dimensions of the tube are not very essential for the success of the experiment, so long as the distance between C and A does not greatly exceed 10 inches. By means which will be described later, an arc is established between the electrodes B and D, the current being derived from a direct-current source of moderate voltage g (for the sake of simplicity one can assume that arc BD is being started by means of a high-voltage discharge). A source of direct current, g' , of moderate voltage (100–200 volts), independent of the first one, is connected to the two cups A and C. r and r_1 are two variable resistances. Under ordinary conditions, in absence

of the arc BD, the arc does not start between C and A, nor is heating of the mercury by a Bunsen burner, so as to fill the space with mercury vapour, any help. In presence of the arc BD a luminous vapour spreads out from the path of the arc in all directions, and fills the space between C and A. A direct-current ammeter in the circuit AC shows, under these conditions, a slight current, which varies according to the circumstances from .01 to .1 ampere. Under these conditions, the arc between C and A will eventually start, the current increasing, quite suddenly, up to 4–10 amperes, according to the resistance in series with the arc. Under apparently the same conditions the starting of the arc usually, however, does not take place at all. If all shaking of the tube is carefully avoided, this condition can be kept up indefinitely. The impression one receives from this experiment is that to allow the passage of a large current in the form of an arc, something must happen on the surface of the electrodes. This conclusion is made almost a certainty by the following experiment.

Experiment 2.—Let us suppose that in fig. 1 the cup A is connected to the negative pole of the direct-current source, and while the arc is running between B and D, as previously, let us bring in contact for one moment the mercury surfaces A and B, B being one of the electrodes of the arc BD. Immediately on bringing these two surfaces into contact the arc starts up between the two electrodes C and A. No starting takes place if the electrode A is electrically connected to the positive pole of the direct-current source g' .

From this fundamental experiment one derives the conclusion that in order that an arc should start between two mercury electrodes, placed inside a highly evacuated space, and connected to a source of moderate voltage (magnitude of a few hundred volts), the *cathode must first be rendered active*, and we will interpret this in the light of the ionic theory by assuming that an *ionization process must be started at the surface of the cathode in order to allow the passage of an arc through metallic vapours*. The anode behaves differently and receives the arc, the ionization process being once started at the cathode, without any difficulty. It is, however, irrelevant whether the active electrode B with which the others are brought into contact is anode or cathode of the arc BD.

The fact that the cathode of the new arc becomes active by contact with the anode of the running arc is due to a secondary effect. On connecting the two mercury surfaces of opposite signs, the current of one machine goes through the other, in the direction $CDgBAg'C$ (CD-arc, D being

the cathode, BA-mercury surface); on disconnecting B and A an arc is formed which has A for a cathode, so that A is rendered active.

The same results are obtained if in the same tube arc AC is allowed to run, and the starting of BD attempted. The fact that the mercury arc plays above the mercury in B does not make any essential difference.

Instead of bringing the cathode C in contact with B, let us proceed as follows:—

Experiment 3.—The connexions to BD remaining the same, let us apply the second source of current to the terminals C and B of the tube, so that B is connected to the negative poles of the two circuits. By some means, which will be clear from what follows later, the arc BD is started; if the switch s in the circuit of g' is closed, the arc BC starts up instantaneously. The explanation of this experiment on the basis of experiment 2 is evident.

Experiment 4.—Finally, let us dispense with the different circuits, and make the connexions in the way shown in fig. 2. In the tube ABD, A and B are two mercury electrodes and D is an electrode of mercury, graphite, or a metal like iron. (In the form shown by the figure the electrode D is supposed to be a piece of solid material, such as graphite or iron.) The negative pole of a source of moderate voltage, such as 125 volts, is connected to B; the positive is connected in parallel to A and D. The length of the tube BD is limited only by the available voltage. AB is a short tube, about 1 inch long. Two resistances are placed in the circuit: one, r , in the positive line going to D, to limit the current in the arc; the other, r_1 (75–150 ohms, with 125 volts impressed), in the branch leading to A. If the surfaces of the two mercury electrodes, B and A, are brought into contact and separated again, a small arc is established between A and B, and the ionization process, being thus established on the cathode B, the ions propagate along the tube BD and an arc starts between B and D. *If the tube is well exhausted, the starting of the little arc AB and that of the main arc in the tube BD are simultaneous, and the whole process is nearly instantaneous.* The arc AB can then be interrupted by opening a switch in the branch leading to A. A is called the “auxiliary anode,” the tube AB the “side branch,” or “starter.” The operations described can be easily performed automatically by the current itself, and one of the many arrangements used is illustrated by figure 3.

Experiment 5.—The mercury fills the cups B and A (fig. 3) up to the level ef . KL is a rod of iron, and S is

a solenoid. On closing the switch P the current goes through the solenoid and the mass of mercury filling the cups AB. The energized solenoid pulls the iron rod out of the mercury, thus separating the mercury surfaces A and B, and a spark is formed which starts up the arc in the main tube BD. By providing a magnetic cut-out energized by the current flowing in OD, the current in the side branch AB can be cut out automatically as soon as the arc BD starts up. The current in the side branch need not be large, and a small part of an ampere is sufficient to start the ionization process on the cathode B and the flow of ions in the tube BD. The length of this latter tube is regulated only by the voltage impressed on it, and with 120 volts tubes 55 ins. long can be readily started. The instantaneous starting up of such a long arc is one of the most beautiful and effective experiments for the purposes of demonstration.

The arrangements arrived at in figs. 2 and 3 represent a convenient way of starting a mercury arc, or an arc discharge through any other metallic vapour, instantaneously, by means of a source of the same voltage as that on which the arc runs stable.

The initial spark can also be produced by means of a Holtz machine or induction-coil, the two poles being connected to the electrodes A, B of the starting branch in the same way as was the source of moderate voltage. This spark is, however, somewhat less efficient in consequence of the very small flow of current produced by it.

The experiments 4 and 5, illustrated by figs. 2, 3, do not succeed if B is made the anode and A and D the two cathodes of the arc. The arc AB starts, of course, in the same way as before. The main arc BD does not start, however, even after the ionized vapour propagating from the arc AB has filled the space BD, whether D is a mercury or graphite anode.

The difference in the behaviour of the two electrodes in respect to the starting of the arc is shown by all these experiments. In the ordinary way of starting an arc between two electrodes, such as two carbons, or two metals, by bringing them into contact and separating them, the process is entirely symmetrical, and no conclusion as to the difference between the two electrodes can be drawn.

By the experiments described above, especially experiment 2, this process has, so to speak, been divided into two, and the predominating rôle of the cathode shown. This does not prove that no ionization at all takes place at the anode, but only that the *primary* one takes place at the cathode, and

that in order that an arc should be started, this *primary ionization* must be excited on the cathode.

We are now able to complete the description of the experiments 1 and 2 by giving the most convenient way, before alluded to, for starting the arc BD in those experiments. It consists in making the tube AB a side-branch, making the connexions as shown in fig. 2, and then disconnecting A and applying the second source g' .

The different methods by means of which a mercury arc can be started in an exhausted tube may be now summarized.

1. Bringing the cathode into contact with the anode and separating the two electrodes. This is the ordinary method used in all arcs.

2. Application of high voltage to the two electrodes.

3. The new method described in experiments 1 and 2, that is, bringing a cathode in contact with an already active electrode.

4. Mere mechanical agitation of the mercury.

Experiment 6.—If, in fig. 2, the tube BD is short, the tube well exhausted, the connexion to the electrode A can be taken off, and the arc BD started by violent shaking of the tube. This is accounted for by the fact that the shaking of the mercury in an exhausted tube is accompanied by production of light, that is, of luminous ionized vapour, starting from the surface of mercury.

5. Contact of the cathode with ionized vapour. Returning to experiment 1, we found a small current flowing between the electrodes A and C. This was carried by the ionized vapour supplied by the arc BD. This current differs in magnitude according to the amount of ionized mercury vapour in the space between the electrodes. The eventual starting of the arc AC can be explained by assuming that the presence of ionized vapour facilitates, under certain conditions, the starting of the ionization process on the cathode. Shaking of the mercury surface or the impact of the condensing mercury running back seems to be the more effective the larger the amount of ionized vapour present above the surface. In this connexion the following experiment is interesting.

Experiment 7.—The glass tube ABCD (fig. 4) has three mercury cups, A, B, C, and one graphite electrode, D. B and C are connected to a direct-current source g ; A and D to another direct-current source g' . The circuit AD being open, the arc BC is started; in this arrangement the arc surrounds the electrodes A and D of the other current. Closing the switch s in the circuit of AD usually establishes an arc between A and D. It is, however, possible, although not very easy, to realize such conditions that on

closing the switch *s* a few minutes pass before an arc is established between A and D. It seems, therefore, that the presence of ionized vapour in itself is not sufficient to start the ionization at the cathode, but that it facilitates the action of the other causes.

§ 2.

Rôle of Vacuum. Function of the Carbon Filament.

The phenomena described in the first section, especially that of the instantaneous starting of a long arc, take place only when the vacuum in the lamp is as high as can be reached by careful exhaustion with a good mercury pump. Measurements by means of a McLeod gauge have shown that when the pressure of foreign gases (air, hydrogen, &c.) exceeds about .01 mm., the starting of the main arc in the arrangement shown by fig. 2 is not instantaneous, but takes some time; and the ionized vapour, coming from the cathode of the auxiliary arc, is seen to creep up slowly in the tube until it reaches the anode, and then eventually causes the starting of the arc. If the vacuum becomes lower than the limit given above, the arc starts with difficulty, or not at all. As the vacuum becomes poorer and poorer the phenomena become more complicated, and the regularities observed in a high vacuum become obscured. In order, therefore, that the experiments described in Section 1 should succeed, the vacuum must be high and the gases from the walls and from the electrodes must have been driven off. In repeating the experiments of Section 1 it would therefore be advisable to begin with short tubes (5-6 ins.), as the reproducing of the phenomena in long tubes requires some experience and skill, which can be gained only by actual work on the subject.

The experiment relating to the starting of an arc by means of a side-branch may therefore be described in detail. After the tube has been exhausted on a good Sprengel pump, the mercury that is to serve as electrode is poured in, or better distilled in, from an attached glass vessel connected to the main tube by means of a narrow glass tube that allows the vessel to be sealed off subsequently. When enough mercury is collected in the cups A and B (letters refer to fig. 2), so that by slight shaking the two mercury surfaces can be easily brought into contact, the connexions to the current source are made and the arc in the side-branch is started. At this stage it is best to have in the side-branch about 4 amperes. If the vacuum is high enough, the main arc in the tube BD will probably flash up, but will immediately go out in consequence of the large amount of gases given off from the

walls of the tube and from the anode (this being supposed to be made of a solid conductor such as graphite, iron, silicon, &c.). The ionized vapour emitted by the cathode (the arc still running in AB) begins to propagate slowly along the tube; and when it reaches the anode and the vacuum is improved by the continued action of the pump, the arc will start up, go out again, and repeat this many times, until the greater part of the gases has been liberated from the anode. The arc is then allowed to run for some time (it is best to open the side-branch arc when the main arc has become stable), the tube being constantly connected to the pump; and when the mercury in the pump, by its hammering sound, indicates that only traces of gas are given off, the tube is ready for the experiment. It is difficult, if not impossible, to get rid of all the gases occluded in the anode and on the walls of the vessel. With a little experience it is, however, easy to recognize the moment when it is safe to seal the lamp off the pump, and have a lamp which will run for many hundred hours without a serious impairment of vacuum.

Another factor must be taken into consideration while carrying out the experiments. The presence of inert, non-conductive mercury vapour acts in much the same way as the presence of foreign gases, so that the starting is easier when the tube is cold than when it is hot. If, after the arc had been running for some time, the current is interrupted and the starting attempted again, three intervals can be distinguished. In the first one, which lasts a few minutes, the starting is easy. In the second one, which may last from a few minutes up to a few hours, the starting is not instantaneous. In the third one, when the lamp is more or less cooled down, the arc starts again instantaneously. The length of the first and second intervals depends upon the length of the tube, the magnitude of the impressed voltage, and the care with which exhaustion has been carried out before sealing off the lamp; the longer the lamp, the smaller the impressed voltage, and the lower the vacuum the shorter is the first and the longer the second interval. With very long tubes of 50–60 ins., and an applied voltage of only 120 volts, it is often necessary to let the tube cool down for two or three hours before the starting becomes instantaneous. It is possible that this behaviour of the tube is not so much due to the presence of mercury vapour as to the presence of traces of foreign gases driven out by the heat of the arc and reabsorbed by the walls of the tube after they had become cooled down. Still, the phenomenon is to be observed with long tubes even after very careful exhaustion and while the tube is connected with the

pump, and in view of the influence of the non-conductive mercury vapour on the stability of the arc recorded later, I consider it highly probable that the presence of mercury vapour in itself is sufficient to prevent the starting of the lamp. The behaviour is, of course, quite different when the impressed voltage is high enough to split up the mercury molecules. In that case the heating of the tube and the mercury facilitates the starting. The same is, however, the case with the presence, in small quantities, of foreign gases; so that the analogy between the behaviour of inert mercury vapour and other non-conductive gases toward high, as well as low, voltages is complete.

Starting from the idea that the presence of slight traces of foreign gases or mercury vapour affects only the rate of propagation of the ionization, I was looking for means to accelerate the latter, and so make the starting of the arc sure at any time, with cold and warm tubes. This means has been found in a thin carbon filament of high resistance, suspended to the anode and reaching within a short distance (3-6 ins.) of the mercury cathode. Such a lamp, if well exhausted and if care has been taken to drive out by heating the gases of the filament and anode, starts up at any time instantaneously.

Experiment 8.—The lamp is represented in fig. 5. After the tube has been well exhausted and the mercury introduced into the cups, the arc is started in the side-branch, the tube being connected to the pump. The arc in the main tube starts up first between the mercury cathode and the lower end of the filament. The filament is in this way heated up by the current which flows through that arc and the gases set free are carried away by the pump. When most of the gases occluded in the filament have been driven off, the arc fills out the whole tube and goes to the piece of graphite D, which serves as anode. By the heat generated at the anode the gases occluded in it are expelled. When most of the gases have been driven out and the tube shows a behaviour like that described above (instantaneous starting at any time with a small current in the side-branch), the lamp can be sealed off and the experiments repeated with it at any time. Care has to be taken, however, never to have an arc in the tube with higher current than that at which it was exhausted.

The rôle of the carbon filament is not perfectly clear. It certainly helps the starting by shortening the distance between the cathode and anode, since when the ionization reaches the end of the filament a small current is already established

which may assist the propagation along the tube. This explanation is, however, not sufficient to account for the peculiar action of the carbon filament. The following experiment is instructive in this respect.

Experiment 9.—The arrangement is the same as in fig. 5, with the exception that the carbon filament is surrounded by a narrow glass tube open at both ends. When the arc starts up it first fills the inside of the narrow tube, gliding along the filament, although the mercury arc has in general the tendency to avoid narrow tubes, in view of the high resistance of the path. After a while the arc, of course, spreads out and fills the whole section of the tube.

The action of the carbon filament cannot be ascribed to the well-known ionizing-power of incandescent filaments, since the whole process of starting in a well-exhausted tube is nearly instantaneous, and the filament has not the time to get hot at all. After the arc is started the filament does not play any rôle at all. In consequence of its high resistance in comparison with that of the arc, the current flowing through it is insignificant. The carbon filament is about the only conductor that can be used for this purpose, other filaments, such as iron, platinum, &c., being too good conductors and melting off the moment the arc strikes their lower end.

§ 3.

Properties of the Mercury Arc and of the two Electrodes.

In so far as the discharge through mercury vapours is characterized by a relatively low voltage across the terminals, by a high current, and by a higher temperature of the anode in comparison with the cathode, this discharge must be classified in the same group with the arc between two pieces of carbon, or between two metals in air. In consequence, however, of the high vacuum and the volatility of mercury, the arc can be made of any desired length, and offers the best opportunity for an exhaustive study of the subject. The arc, as such, has been investigated in some respects by Arons; and, so far as his results go, I can in most cases confirm them.

In common with all the arcs, the voltage across the mercury arc varies only little with the current. If, for instance, the current increases four times, the voltage will vary by only 5 to 6 per cent. In the first approximation, therefore, the *resistance of the arc can be considered as inversely proportional to the current* (Arons). In contradistinction to the ordinary carbon arc, however, the voltage varies in the same sense as the current. This difference is probably explained by the

fact that the cross-section of the mercury arc is constant, while in the carbon arc the section increases with the current. The independence of the voltage from the current is a property which all arcs have in common with the positive column of a Geissler discharge; and this suggests the idea that in the continuous passage of the phenomena observed in Geissler tubes to those classified under the name arcs, the development of the positive column and the disappearance of the cathode space and negative column are the most pronounced factors. There is a potential drop at each of the electrodes which for two mercury electrodes gives a sum of $13\frac{1}{2}$ volts, and for a mercury cathode and an iron or graphite anode a sum of about $7\frac{1}{2}$ volts. By inserting two platinum wires in the arc and measuring the potential drop between each of the electrodes and the platinum wire, as well as that between the platinum wires themselves, one finds that the drop at the cathode amounts to about 5 volts, at the iron or graphite anode $2\frac{1}{2}$ volts, and at the mercury anode 8 volts. These values differ a little from those given by Arons. The voltage drop in the arc outside of that of the electrodes themselves is exactly proportional to the length of the arc, and is smaller the larger the diameter. A simple relation between the potential drop per unit length and the section of the tube does not seem to exist. The outside temperature being 15° to 20° , the potential drop in tubes of $\frac{3}{4}$ -inch diameter is about 1.8 volt per inch.

If the vacuum is perfect and the starting of the arc made by means of an auxiliary arc, as described in § 1, the arc presents from the very first moment a uniform appearance throughout all its length, except for a dark space above the cathode which afterwards disappears almost completely, and shows no striations whatever.

Schuster found a similar result in case of a Geissler discharge through mercury vapour. In absence of air no striations could be obtained*.

The arc is at the first moment rather dim, and reaches its full brilliancy only after about 10 to 15 seconds (if the tube was cold to begin with). If, however, the vacuum is not perfect (especially in absence of the carbon filament) so that the starting is slow, and the ionized vapour is seen to move slowly from the cathode to the anode, the arc is usually preceded by the appearance of striations, starting from the anode and propagating toward the cathode. The difference in appearance is intimately connected with a number of essential differences in regard to the voltage across the

* Proc. Roy. Soc. vol. xxxvii. p. 318 (1884).

lamp, the current, &c.; and in what follows it will always be supposed that the vacuum is perfect, the starting instantaneous, and the appearance of the arc from the very beginning uniform and deprived of any visible striations. Under these conditions the resistance of the arc is lowest at the beginning, and increases rapidly during the first half minute, when it reaches its normal value, the arc having fully developed. If, the tube being perfectly cold, the arc is started and the instruments carefully watched, the voltage is seen to begin with a low value and to increase, while the ammeter shows first a high value which rapidly decreases. In one case, for instance, the indications at the beginning were 46 volts, 7 amperes (resistance $6\frac{1}{2}$ ohms); and after a few seconds, when the normal condition had been established, 62 volts, 5.5 amperes (resistance 11.3 ohms). The resistance, therefore, has nearly doubled; and we have the, at first sight, paradoxical result that the *conductivity of the mercury arc is the larger the less vapour there is in it*, the conductivity being highest in the first moment when the pressure of mercury is but .001 mm.

The following experiment leads to the same conclusion.

Experiment 10.—The lamp is provided with a jacket through which cold water can be kept in constant circulation. The temperature of the arc is hereby lowered, the amount of mercury vapour in the tube diminished correspondingly, and this is accompanied by a diminution of the resistance of the arc. In a lamp which consumed, when surrounded by air, 42 volts, the potential drop across the arc went down to 34, when surrounded by constantly renewed water, the current being kept up to the same value ($4\frac{1}{2}$ amperes) by increasing the resistance in series with the lamp. The explanation of this phenomenon on the basis of the ionic theory is simple. In the arc-stream we must distinguish between two different kinds of mercury vapour, the ionized conductive one and the ordinary mercury vapour produced by superfluous vaporization of mercury. This latter part of the mercury vapour hinders the motion of the ionized particles, and, by doing this, increases the resistance of the arc-path.

The amount of light sent out by the arc, under the conditions of experiment 10, is perfectly insignificant; whereby it is shown that the light-emission is not intimately connected with the electric conductivity, but is a function of the temperature of the arc.

Thus the conductivity and the luminosity of the arc do not go parallel, the *maximum conductivity nearly coinciding with the minimum light-emission*. With the increase of pressure of the mercury vapour the conductivity steadily diminishes, while the amount of light emitted increases up to a certain

value, and then remains stationary, or even slightly diminishes. To be perfectly correct we ought, therefore, to distinguish between three kinds of mercury vapour in the arc-stream: one ionized and conductive, the other non-conductive but light emitting, and third, non-conductive and non-luminous ordinary mercury vapour.

In the construction of the tube which contains the arc care must be taken to avoid the presence of that third kind of mercury vapour as much as possible. For this purpose the tube is provided with a condensing-chamber, lying outside of the path of the arc, in which most of the superfluous mercury vapour condenses before it gets into the arc. A good form of a vertical tube is shown in fig. 2, where the cylindrical tube AC, placed above the auxiliary anode A, and parallel to the main tube BD, serves as a condensing-chamber. (See also fig. 3.) If such a condensing-chamber is not provided, the potential drop across the lamp is much higher than under ordinary conditions; and if this voltage approaches too closely the impressed one the arc goes out.

In § 2 the influence of non-conducting mercury vapour in the arc has been compared, as to its influence on the starting of the arc, with the influence of any other non-conducting foreign gas. The analogy goes further, since the presence of non-conductive mercury vapour in the arc has the same influence on the resistance and stability of the arc as the presence of a foreign gas. Again, from a quantitative point of view, the action is much weaker in the case of mercury vapour. The presence of even small traces of air or hydrogen in the tube increases the resistance of the arc-path enormously, and renders the arc unstable. In view of the influence of foreign gases and of superfluous mercury vapour on the resistance of the mercury arc, the approximate constancy of the potential drop across the lamp is strictly valid, and the numerical data given as to the voltage drop in the lamps, &c., are correct only when the vacuum is perfect, and care has been taken to provide the tube with a condensing-chamber.

This being always presupposed, the conditions of stability of the mercury arc are still rather complicated. First, as in any other arc, there must always be a certain amount of steadying resistance in series with the lamp. Second, again in common with all other arcs, for any given impressed voltage there is a certain lower limit of current below which the arc is not stable. With 100 volts applied to a tube consuming about 80 this low limit is in the neighbourhood of 3 amperes. If, however, 250 volts are impressed, the lamp will run steadily with a much lower current. The voltage

across the lamp is, however, the same in both cases. It is not possible to account for the existence of this lower limit by the low temperature of the arc at the low current, since we saw that cooling the arc increases the stability.

The explanation is rather to be looked for in the properties of the cathode. The supply of ions coming from the cathode, one must assume that the ionization process to be stable requires at each voltage a certain current, and dies out when the current is lowered below a certain limit. The behaviour of the tube can be considered as being in favour of that explanation. When the current in the arc is reduced below that critical value, the lamp suddenly goes out after a certain interval of time, no gradual change in the potential drop across the lamp being observed. This phenomenon points to the existence of a cause which ceases to act in a discontinuous way. Still, this explanation is probably only a partial one, since it does not explain the influence of the magnitude of the diameter of the tube on this lower limit. This influence, although not very pronounced, certainly exists, the critical value of current being lower the smaller the diameter of the tube.

The phenomena described above, referring to the conductivity of the arc, being in accordance with the ionic conception, the question remains to be answered whether the flow of ions in the arc takes place in both directions or only in one; and if the latter be true, what that direction is. The total difference in appearance of the two electrodes speaks against the existence of a symmetrical process in the arc. The arc around the anode is quiet and steady, while on the surface of the cathode there is a small bright spot which is constantly wandering about upon that surface. The fundamental importance of the cathode in the process of starting of the arc, described in section 1, leads one naturally to the conclusion that the *production of ions takes place at the cathode surface*. This is further strengthened by the following facts.

The properties of the arc are independent of the nature of the anode, whether this be made of iron, graphite, silicon, or of mercury itself. In the case of iron and graphite a slight disintegration of the anode takes place; but this is exceedingly small, so that it takes days to notice any black deposit on the glass; and is obviously a secondary phenomenon, due to volatilization of the material of the anode in vacuum in consequence of the high temperature of the anode. Replacing these substances by a hard substance, such as titanium carbide, does away with the disintegration altogether. The material of the anode is therefore irrelevant, and its choice is deter-

mined by practical considerations. Thus, the anode must have a relatively high melting-point, must not enter into combination with mercury, must have in its normal condition as little gas occluded as possible, &c. The material of it does not seem, however, to affect the nature of the arc in the least. In the case of a mercury anode, to be sure, vaporization of the mercury takes place, and this affects somewhat the stability of the arc in accordance with the principle expounded above. But this is obviously unimportant in this connexion.

Another property which is characteristic of the cathode is that it is difficult, if not altogether impossible, to realize such conditions that more than one cathode in multiple should be present in the same arc. Attempts to produce more than one cathode invariably fail. One of the experiments may be described here.

Experiment 11.—In the tube ABC (fig. 6) there are three cups filled with mercury, of which C and B are connected to the negative, A to the positive pole of the source of current. B and A are close to each other, so that by shaking, the arc BA can be started. There is enough mercury in the tube to cover the surface of the glass between C and B when the tube is a little inclined. When the mercury-surfaces in C and B are thus connected, and the wandering bright spot (from our point of view the centre of ionization) happens to move away from B towards C, the mercury-surfaces are separated at a point near to B, the bright spot remaining now on the surface C. In this way the cathode is transferred from B to C, and B rendered inactive. The arc goes exclusively to C, although the arc CB represents an additional resistance.

If B and C are made anodes, and A the cathode, and the same experiment as before performed, the arc sticks to B, and by placing resistance in the branch leading to B, so as to more or less compensate the resistance of the additional length of arc, the current can be distributed between the two anodes.

This impossibility of having more than one cathode is intimately connected with the necessity, from our point of view, of creating a centre for production of ions on the cathode.

If the cathode is the seat of the ionization process, a mercury arc, having the mercury as anode, and a piece of solid material, such as graphite or iron, as *cathode*, must produce some peculiar phenomenon on that solid cathode. If, in fig. 2, connexions are reversed, B made the anode, D and A cathodes, on starting the side-branch arc AB the

main arc BD does not start, even after the ionized vapour has filled the whole space BD. This has already been mentioned. It would, however, be too hasty a conclusion to say that graphite or iron is incapable of being the cathode in a mercury arc, since we have seen that the cathode of an arc must be rendered active, which was not the case with the graphite cathode D. The simplest way to make a cathode active is that used in all arcs, *i. e.* separating the two electrodes after having brought them into contact. This is realized in the following experiment.

In a vertical carefully-exhausted glass tube there is a mass of mercury at the bottom and a rod of graphite suspended from a platinum wire, and reaching within a short distance from the mass of mercury at the bottom of the tube. The graphite rod is connected to the negative, the mass of mercury to the positive terminal of the source. By shaking the tube it is easy to bring the mercury and the graphite rod into contact and separate them again, whereupon the arc starts up with a graphite cathode. In this case the following phenomena are observed :—There is a wide hot spot, wandering about the surface of the rod, just as there was a bright spot on the surface of the mercury cathode. Rapid disintegration of the cathode takes place from the very beginning, and a deposit of carbon forms all over the walls of the tube and the surface of mercury. This disintegration goes on as long as the arc lasts, and takes place whatever the the material of the cathode (graphite, iron, &c.).

The cathode is, therefore, the electrode which disintegrates in the arc. This mechanical disintegration is probably intimately connected with the ionization which takes place on the surface, and the most probable assumption is that the current leaves the graphite cathode in form of carbon ions, and is transported through the arc by means of mercury ions. Whether these latter are generated exclusively at the surface of the graphite cathode or whether they come in part from the mercury anode cannot be decided. If a piece of graphite and a mass of mercury are both connected to the negative terminal, the arc will go almost exclusively to the mercury cathode. A small current of about $\cdot 01$ ampere flows to the graphite, but even this small current is accompanied by a slight disintegration.

To summarize what has been said above, *there is strong evidence in favour of the assumption that the cathode is the electrode at which the primary generation of ions takes place*, while the question whether the flow of ions in the arc is unidirectional—negative ions going from the cathode to the

anode—or whether the ions, after having reached the positive electrode, become positively charged, and move back toward the cathode, must be left undecided. It was, however, interesting to see what results could be obtained if, starting with the assumption of unidirectional flow, one attempted to solve the second fundamental question in connexion with the conductivity of an arc, namely, that referring to the amount of matter carrying the current. The mercury arc, being inclosed, and taking place in a vacuum, presents a better opportunity for the study of this question than the arcs burning in air. Still, the difficulties are such that reliable quantitative data could not thus far be obtained.

Assuming a unidirectional flow of ions, one might think that by arranging a vertical tube, having at the bottom a mercury cathode, and at the top a graphite anode, providing this tube with a well-cooled condensing-chamber around the anode, one could get some data by determining the amount of vapour collected during a certain time in that chamber, the current being kept constant. This procedure would, however, be faulty in view of the fact that only a small part of that mercury has participated in the actual transport of the current. A condensing-chamber at the bottom of the lamp in the way shown in fig. 2 does away with a large part of the mercury that simply evaporates from the cathode, and if a part of the tube is surrounded with a jacket with circulating water, large amounts of mercury condense there which otherwise would have reached the condensing-chamber at the top of the lamp; the current in the lamp is, if anything, increased by this condensation taking place. The following arrangement is somewhat more satisfactory without, however, enabling one to get quantitative results.

Experiment 12.—The lamp has the form shown in fig. 7 (Pl. III.), and is submerged in a large vessel through which cold water constantly circulates. It can be supposed that the mercury ions, after having given off their charges at the anode, will diffuse and condense in the condensing-chamber C, which, being outside of the arc, is the coolest spot in the tube. The cooling with water not being sufficient to perfectly do away with superfluous vaporization of mercury, experiments conducted in this way can only give maximum values, above which the quantity looked for cannot lie.

From the experimental data thus obtained, one thing seems to be surely established, namely, that the amount of matter carrying the current is a very small part of that required by Faraday's law.

Some experiments have been performed on the loss in

weight of a carbon cathode in a mercury arc ; the mechanical disintegration of the cathode, however, interferes with securing easily interpretable results.

These experiments and the qualitative results in respect to Faraday's law, are founded on the assumption that the ions move in only one direction, and would be entirely invalidated if the ions obtained positive charges at the anode and carried them back to the cathode. On the other hand, by following out closely the experiments and comparing the data obtained, I may be able to either confirm or else disprove the theory of unidirectional flow.

In connexion with this, and with the theory of the arc in general, the investigation of the nature of the luminous vapour which spreads out from the cathode into the parts of the tube lying outside the arc-path is of exceeding importance. A number of experiments have been carried out with the idea of ascertaining whether this luminous vapour carries electrical charges, or whether it represents a conductive state of mercury vapour, capable of taking up electric charges. I expect to publish in a continuation of this article the results of these experiments.

The action of the magnetic field on the arc has also been investigated. It is very peculiar and not easily accounted for. The observed phenomena can be briefly described as follows : the field and arc being both horizontal and perpendicular to each other, the arc is deflected up or downward, according to the common rule of the action of a magnetic field on a current. The deflexion downward is accompanied by a motion of the bright cathode-spot along the surface of the cathode in the direction of the current ; the arc is thus lengthened, and when it reaches the wall of the tube it digs into the mercury where the latter is in contact with the walls of the tube. If the direction of the current in the arc is reversed, the arc is pushed upward and tries to become as short as it possibly can, so that the spot on the cathode moves in the same direction as before (as is easily seen by making a sketch). Changing the direction of the field changes of course the direction in which the arc is deflected, as well as that in which the cathode-spot moves. It is very strange, however, that when the arc contracts, the digging of the spot into the mercury also takes place. The behaviour of the arc in a magnetic field can be partly explained by assuming it to be a flexible conductor capable of changing its length, both ends being capable of sliding along two surfaces, and that on the anode being much less mobile than that on the cathode. It is difficult to imagine a mechanical model

which would have similar properties, and the action of the magnetic field on the arc presents, therefore, features which are at first sight paradoxical. If the arc is vertical and the field horizontal, the deflexion of the arc and that of the spot are in opposite directions. The best way to carry out this experiment is to have a bulb about $2\frac{1}{2}$ in. in diameter, provided with two mercury cups at the bottom and a graphite anode suspended from the top. The vertical arc is started between the graphite anode and one of the cups. The spot on the cathode is usually wandering about the surface. To give it a fixed position it is best to have an iron wire protruding a little above the surface of the mercury. The bright cathode-spot is then centred on the mercury surface around the iron wire. Under these conditions the arc is first deflected one way, and after a while the bright spot is seen to move away from the iron wire in the opposite direction.

The action of the field on the mercury arc is complicated by the fact that the conductivity of the mercury-vapour changes with its temperature, so that the observed effects change in their appearance when the amount of mercury-vapour present in the arc is changed.

It is interesting to note that the action of the field on the cathode-spot can be in most cases formally accounted for by assuming that positive current elements leave the cathode surface in a direction perpendicular to that surface.

§ 4.

Arcs in Vapours of Alkali Metals. Behaviour of Amalgams.

The most volatile metals, after mercury, are those of the alkali group, the boiling-points of the most common of them, sodium and potassium, lying between 600° and 700° . On the subject of the arcs of these metals in an exhausted space, there are in the literature only a few preliminary experiments, published by Arons in the article mentioned. The difficulties one encounters in this work are many, and it was only after many failures that I succeeded in making the simple form of a tube in which the arc could be started and maintained for a time long enough to make observations. The tube had the form shown in the figure.

Experiment 13 (Pl. III. fig. 8).—CD is a wire connected to the negative pole of the source. The part OD of this wire is best made of platinum or platiniridium. E is a piece of iron about $\frac{3}{4}$ in. long and $\frac{1}{4}$ in. diameter. It swings around the pivot P, and is to serve as the auxiliary anode; FP is a platinum wire; the two seals F and C are purposely placed

outside of the alkali metal which fills the bottom of the tube, since otherwise the action of the hot molten metal on the platinum wire and the glass causes the seal to crack. A is an iron or graphite anode. The length of the tube AB is from 5 to 10 inches. By shaking, the swinging anode E and the platinum wire CD come into contact, and on separation a small spark is produced, which ionizes the vapour in the tube, and in consequence of the proximity of the alkali metal cathode the ionization process is started at the latter. An arc is thus established between E and the alkali metal; the small arc EB acts then as a side-branch, and causes the main tube BA to start up. This may take place instantaneously, or require a few seconds, according to the care with which the tube was exhausted. A direct contact of the auxiliary iron anode and the alkali metal would of course produce the same effect. Since, however, the alkali metal is introduced in solid form, and afterwards in melting contracts in volume, and since the arc causes evaporation of the alkali metal, the distance between E and the surface of the alkali metal changes, and arrangements would have to be made which would allow the iron to be brought in contact with the cathode at all these different distances. I found all such arrangements more complicated and less reliable in their action than the one shown above. A small tube T (not shown in the fig.) is provided at the lower part of the tube, through which the pieces of the alkali metal can be introduced, while, to prevent oxidation, hydrogen gas is allowed to pass through the tube. A stopcock on the pump-connection is for this purpose to be connected with a hydrogen generator. After the alkali metal is introduced the tube T is closed on a sharp blast flame, and the exhaustion begun. When the vacuum is good the arc EB is started, and when the large amounts of gas evolved from the alkali metal have been carried away by the pump, the tube behaves exactly like a mercury tube and starts up almost as easily. The exhaustion being made by means of a mercury pump, the discharge goes at the first moment through the mercury vapour that is present in the tube, but is soon replaced by a pure arc of sodium or potassium vapours. I succeeded in having arcs through potassium vapours 10 in. long and lasting for a few hours. The attack on the glass, in consequence of chemical action combined with a relatively high temperature, sooner or later puts an end to the experiment.

The characteristics of the arc, except the spectrum, are essentially the same as those of the mercury arc. The electrodes possess the same properties. The potential drop

across the arc is of the same magnitude as in the mercury arc, the sum of polarization voltages at the anode and cathode being here about 8 volts, independent of what the material of the anode may be. In this there is a difference from the mercury arc, as between a mercury anode and graphite anode there existed a difference of $7\frac{1}{2}$ volts. This additional voltage is probably connected with the low boiling-point of mercury. The potential drop per inch arc length is nearly the same, about 2 volts, as in the mercury arc, varying under the influence of the same conditions, as in the case of the arc through mercury vapours.

The amount of light given off is very slight. The lamp has the appearance of a very dim, reddish-yellow flame, filling a glass tube. The difference in the efficiency as to light emission between a mercury arc and an arc in alkali metal vapours is partly to be explained by the known fact that much more energy is stored up in red light than in green, for the production of the same physiological impression; partly by the fact that much less vapour is present in the arc than in the case of a mercury arc. The condition of a potassium or sodium arc surrounded by air is nearly the same as that of a mercury arc cooled by a water-jacket. I believe, however, from a series of experiments the descriptions of which would lead us too far, that these two causes are not sufficient to explain the enormous difference in the efficiency of the alkali metal vapour arc and the mercury arc. In addition to the two causes mentioned, one must assume that different vapours have a different power for light emission when submitted to electrical excitation.

The long arc through the vapours of alkali metals that can be easily realized by following the description given above, will certainly prove useful for the spectral analysis of the light emitted by these vapours, as the arc takes place in vacuum in absence of any material that could introduce lines of its own into that spectrum.

A large number of experiments have been carried out on the behaviour of amalgams, beginning with very dilute ones and going up to such containing only a few per cent. of mercury. In case of dilute amalgams (up to about 10 per cent. potassium or sodium) the arc is at low current practically that of mercury, while at higher currents the light of the alkali metal appears. Results of especial theoretical interest have not been obtained, and the very large number of experiments made may, therefore, be only very briefly summarized. With, for instance, a 10 per cent. potassium amalgam, at $2\frac{1}{2}$ amperes, the arc is that of mercury, while at

4 amperes the light of potassium becomes visible to the naked eye. This influence of current-density has already been noticed by Arons. The 20 per cent. amalgam has the peculiarity that it remains solid while the arc is running, so that a mercury arc takes place between two solid electrodes, and the tube can be given any position whatever. The more alkali metal is present in the amalgam the lower is the current limit at which the light of the alkali metal appears, until, beginning with the amalgam containing about 40 per cent. potassium or sodium, the behaviour is nearly the same as that of the pure alkali metals.

Magnesium and lithium amalgams have also been investigated. Even relatively dilute amalgams are solid, and the tension of mercury vapour, and correspondingly (see § 3) the amount of light given off, are greatly reduced by the presence of small quantities of those two metals. The tension of mercury vapour being greatly diminished by addition of those and similar metals, these amalgams may be useful in connexion with the investigation of the amount of matter carrying the current in the arc.

§ 5.

Alternating Current Phenomena in the Mercury Arc.

From experiments of Zuchristan (1893), Wirz (1893), Sahulka (1894), Arons (1896), and others, it is known that the establishment of an alternating current arc of any considerable length between two metallic electrodes presents difficulties. This is at least true for moderate voltages, and Arons has shown that this general rule holds for an arc between two mercury surfaces in a vacuum. Jamin and Manœuvrier found (1882, *Comptes Rendus*, vol. xciv. p. 1615) that in using two electrodes, one of carbon and the other of metal, the alternating current passes in form of an arc between the two electrodes much more readily than between two metal electrodes, and that at the same time partial rectification of the alternating current takes place, the current in the direction carbon-metal predominating over that in the opposite direction. Jamin and Manœuvrier used as a metallic electrode lead, iron, or mercury, and found the rectification best in the case of the last-named material.

Blondel, *Comptes Rendus*, vol. cxxviii. p. 727 (1899), investigated the arc between one carbon and one metal electrode by means of his oscillograph, and showed that under certain conditions one half-wave of the alternating current is entirely suppressed. Duddell and Marchant performed similar experiments.

A report on the rectification of a three-phase current by means of a mercury arc in vacuum, from the experiments of Peter Cooper Hewitt, appeared in the 'Electrical World and Engineer,' January 17, 1903.

The line of thought I followed out was as follows:—The experiments described in section 1 have shown the important role of the cathode in the process of starting an arc between two electrodes, one of which is a metal, and this observation immediately gave me an answer to the question, why is it difficult with moderate voltages to run an arc between two metallic electrodes? According to the experiments described at that place the passage of the arc is only possible when the ionization process is established at the cathode. In the case of an alternating current this peculiar condition of the cathode must be produced at each reversal of direction of current at a different electrode. The electrodes being separated the ionization process at the cathode soon dies out, and since the other electrode, which is now to be the cathode, is not excited the arc cannot but go out.

Experiments have been accordingly carried out in order to see whether an alternating current arc through mercury vapours shows a behaviour in accordance with the theory expounded above. The experiments were arranged in a way similar to those in section 1.

Experiment 14.—The tube ABCD (Pl. III. fig. 9) has four cups filled with mercury. A and B are connected to a source of direct current, C and D to a source of alternating current of moderate voltage (100–200 volts). The direct current arc AB is started by bringing the mercury surfaces in contact and separating them, and then the ionized vapour fills the whole length of the tube. The arc between C and D does not start up precisely as was the case with the direct current in section 1. As soon, however, as the electrode C is brought into contact with B an arc is established between C and B *in such a direction that C is cathode*. If the contact between C and B lasts only a moment a direct current ammeter shows by its deflexion the passage of a rectified current. The arc ceases immediately after C and B are disconnected.

If now, the direct current remaining between A and B, the alternating current is applied to B and C, so that the two arcs have a common electrode, the alternating current will pass continually in the form of an arc between B and C, since B is constantly kept active by the direct current. The arc BC is, however, intermittent and the alternating current perfectly rectified, so that only that *half wave passes which*

has the common electrode as cathode, the other one being perfectly suppressed. The electrode C, the anode of the rectified current (in the case of a common cathode), can be made of graphite, iron, or any other suitable material, just as in the case of a direct current arc. The wave shape of the current and electromotive force has been taken by means of a wave-form indicator, founded on the principle of charging a condenser to the potential-difference to be measured, and discharging it through a galvanometer. A full description of the apparatus can be found in the 'Electrical World and Engineer,' 1901, p. 688.

Plate IV. shows the wave shape of the current through the alternating current arc, together with that of the electromotive force across the arc. It shows first how complete the suppression of one half wave is, and second, if compared with the potential curve of the alternator, that the form of the potential wave has not changed at all during the time when no current is passing.

The reason of the rectification lies in the dissymmetry of the arrangement, only one electrode of the alternating arc being made active. If both half waves are to pass the arrangement must be made symmetrical by providing two direct currents, one on each side of the alternating arc.

Experiment 15.—In the glass tube ABCD (fig. 9) the cups A and B are connected to one, C and D to another source of direct current. B and C are connected to the alternator. B and C are the cathodes of the two direct current arcs. (The connexions are not shown in the fig.) Under these conditions, since both electrodes of the alternating arc are kept active, both waves of the alternating current pass through the arc, as is shown by Plate V.

Returning to the simpler case described in Experiment 14 it will be noticed from Plate IV. that the current is suppressed for exactly $\frac{1}{2}$ period. This is, however, true only for short arcs. As soon as the length of the alternating arc exceeds a certain value (about 6 ins.) a peculiar kind of "lag" appears between the electromotive force and the current, so that the current lasts less than one half period. Plate VI. illustrates the case of a tube in which the length of the alternating arc was $15\frac{1}{2}$ ins., and the anode of the rectified current a piece of iron. It is seen that the current started in the arc very abruptly and only after the electromotive force had reached a certain value. The rise in current is simultaneous with a sudden drop of the potential across the arc. Plate VII. refers to an alternating arc 36 ins. long. The cause of this lag is now the subject of investigation. It

has, however, been ascertained that it is influenced by the magnitude of the alternating voltage and by the frequency of the alternating current. *It increases in a very marked way with the length of tube.* The most probable explanation of the phenomenon would consist in the assumption that the electromotive force must attain a certain value before it can bridge over the space. Another assumption would be that the "lag" measures the time necessary for the ions to cross the distance between the two electrodes of the alternating arc. Probably each one of the two assumptions has a part of truth in it. The experiments are being continued, and will, I hope, throw some light on this, in my opinion, very interesting phenomenon. The necessity for having a certain value of the electromotive force before the current can assume an appreciable value places this phenomenon in analogy with the well-known fact of the existence of a lower limit of electromotive force necessary to break the resistance of a gap between two electrodes placed in a gaseous medium. In the case before us the medium separating the two electrodes is an already, to a certain extent, ionized vapour, and this limit of electromotive force, which is low, can be readily measured, and the phenomenon therefore studied very thoroughly.

Blondel has already observed a similar phenomenon in carbon-metal arcs in air, but in this case the cause was in the self-induction placed in series with the arc, while here, in all the experiments, a practically non-inductive resistance was used to limit the alternating current. The influence of a self-induction in series will also be studied.

Considered as a practical rectifier, the arrangement described in Experiment 14 has two great disadvantages. The first is the use of a direct current. The second is the suppression of one half of each wave, so that only pulsating currents are derived, instead of a continuous one. The first improvement made is illustrated by fig. 10 (Pl. III.).

Experiment 16.—In the tube ABC (fig. 10) the two mercury cups A and B are connected to a source of direct current, the cup B and the graphite terminal C to a source of alternating current. In shunt to the lamp a reactive coil is placed. The half-wave of the direction CB goes through the arc; that of the direction BC, being unable to pass through the arc, chooses the path of the reactance, which, in discharging itself afterward in the proper direction CB through the arc, causes at least a part of the half-wave of the wrong direction to become rectified. A somewhat similar arrangement, in which a transformer is used, is shown in fig. 11.

Experiment 17.—The tube differs from the previous one in that there are two anodes in the main lamp. T (fig. 11) represents a transformer whose ratio of transformation can be supposed to be 1:1. The primary of the transformer is connected to the source; the two ends of the secondary are connected to the two anodes A and D, and a neutral wire, taken out from the middle of the transformer, is connected to the cathode B. By following out the arrows indicating the direction of the current, it is easily seen that each half-wave is in *one* of the two windings of the secondary, in the proper direction, and can pass through the arc, and that all the current that goes through the arc is rectified and collected in the neutral wire of the transformer. The currents that actually flow in the two windings of the secondary, being of opposite directions, the saturation of iron which would take place with pulsating unidirectional current is prevented.

Since current is constantly flowing through the arc, the direct-current arc in the side-branch fulfils only the function of keeping the cathode active during the short interval of time around the zero of the current in the main arc.

I have used many other forms, especially in connexion with polyphased currents; but these experiments may be omitted here, as they introduce no new principle.

Although in experiment 17 the direct current in the side-branch could, even in case of single-phase alternating current, be reduced to only a small part of the rectified one, still the necessity for using a direct-current source is a disadvantage.

Experiment 18 contains, however, the germ of an idea which, developed further, allows one to dispense with the use of the direct current altogether.

Experiment 18.—The glass tube ABC (fig. 12) has three cups. The alternator is connected to A and C. A and B are connected outside by a reactance (of the magnitude of 40 ohms). If A, B, and C are brought into contact and separated, the arc runs steadily between A and B, and C and B, in such a way as to have B for a common cathode, and A, C for two anodes. The explanation of the action of the reactance placed between A and C is as follows:—Let us assume that the alternating current at a certain moment has the direction CB. It can then go through the tube in that direction, making B cathode, and passing through the reactance which is in series with CB. When this half-wave begins to decrease, the reactance restores the energy stored up in it by discharging itself through AB, this discharge having B again for the cathode. Before that

discharge ends the alternating current assumes anew the direction CB, in which it can discharge itself through the tube, and the same process is repeated. The essential point of the arrangement is the existence of one common cathode to the alternating-current wave which has the proper direction and to the discharge of the reactance placed in shunt with AB and in series with CB.

The currents in AB, CB, as well as in the main line, are pulsating, while in the reactance the current is unidirectional and diminishes to zero for only a very short interval of time. Plate VIII. is the most interesting in this connexion. It shows the currents through CB and AB in their proper relation to the time, and confirms completely the above given explanation for the action of the reactance.

The use of direct current is done away with by this arrangement, but only one half-wave of the alternating current is utilized, and the resulting rectified current is far from being steady. In order to utilize both halves of the alternating wave two reactances must be used in a perfectly symmetrical manner.

Experiment 19.—The connexions, as shown in Pl. III. fig. 13, require no explanation. One half of the alternating wave goes in the direction CBA, the other in the direction EBD. The zero-point of the alternating current, as well as the period during which the value of the alternating current is small, is bridged over by the discharge of the reactances L and L₁ through those parts of the arc to which they are in shunt respectively. All four currents have the same common cathode K. Plate IX. shows that the current in the line N, where all the currents are superposed in the same direction, is a direct current nearly constant in its intensity. In the supply-line there flows, as is shown in Plate X. a regular alternating current. The unidirectional current in one of the reactances is shown by Plate XI. This arrangement represents, therefore, an almost ideal rectifier. The efficiency is, with 100 volts applied, counting in the losses in the arc, as well as in the reactances (copper-loss, hysteresis, &c.), very high, and goes up as the voltage is increased. The power factor can, by proper adjustment of the reactances, be made very near to unity.

The two electrodes C and E can be made of graphite, iron, or similar material, so as to avoid the superfluous mercury vapour which comes from the mercury anodes and disturbs the stability of the arc (see § 3). A condensing-chamber must, of course, be provided in all of the tubes, in order to keep down the pressure of the mercury vapour. The very

interesting point is that under normal conditions no current flows between the two anodes E and C, even when they are only $\frac{1}{64}$ inch apart.

If the tube is to work as a rectifier, the distances EB and BC are made small. If the arc is to be used as a source of light, the lamp must be long enough to consume all the voltage applied; and in that case the tube has the form similar to that of a direct-current lamp. First the lower part of the lamp is started, and as the ionized vapour fills the main vertical tube the arc is partly transferred to the two anodes at the top of the lamp; and this transfer can be made complete by opening the switches leading to the auxiliary anodes at the bottom of the lamp. As in the case of the direct-current arc, a carbon filament helps the propagation of the arc. The details, however, must be omitted, as they would lead too far into the practical side of the subject.

In case of a three-phase alternating current a similar rectifier can be used. Three anodes, connected to the three wires of the system, are used. The three anodes are connected by reactances to the mass of mercury at the bottom of the lamp, which is to serve as the common cathode. In the wire leading from the common cathode to the three reactances both half-waves of all three phases are rectified and superposed.

The practical importance of the rectifier for alternating current is so self-evident that it need not be emphasized. It would, however, lead too far to enter into a description of the most practical form of such rectifiers, their use for large currents and for high voltages, the operating of many of them in multiple and in series, &c. The description given above was only intended to make known the main principle, and to point out those parts which are of scientific interest.

Summary of Main Results.

The main results of this investigation may be summarized as follows :—

1. By a series of experiments it was shown that in the process of starting an arc the cathode plays an important rôle, so that a certain change must take place on its surface before the arc can start. The anode receives the current without any previous excitation.

2. Starting from the recognition of this rôle of the cathode, a new method has been devised for an instantaneous starting of the passage of a moderate voltage-current through the space separating the electrodes, and this no matter how long that space is.

3. The properties of the mercury arc have been studied,

and a number of differences in the behaviour of the cathode and anode, besides the one mentioned above, stated.

4. The behaviour of amalgams, as well as pure alkali metals, has been investigated, and the complete analogy between the behaviour of the arc in their vapours and that of the mercury-arc shown.

5. Different ways have been found to cause an alternating current to pass through mercury vapour in form of an arc.

6. On the basis of this a theoretically almost perfect rectifier for conversion of alternating current into steady direct current was developed.

In conclusion, I wish to acknowledge the great help I have obtained from Dr. Kruh, who assisted me in carrying out the work on the alternating current, and take pleasure in expressing my thanks to Dr. C. P. Steinmetz and to Dr. W. R. Whitney, Director of this Laboratory, for their interest in this work and many valuable suggestions.

Schenectady, N.Y., July 17th, 1903.

XIII. *The Variation of Potential along the Transmitting Antenna in Wireless Telegraphy.* By C. A. CHANT*.

[Plates XII. & XIII.]

I. *Introduction.*

IN a former paper † illustrations were given of the manner in which standing waves are formed on a free-ending wire when the electrical disturbance is produced by electrostatic induction from a Hertzian oscillator at the other end of the wire. The present communication contains a somewhat detailed account of an examination of the aerial wire used to radiate the waves in wireless telegraphy; and, in a section at the end, a brief account of a continuation of the former experiments.

The problem of the electrical oscillations about a free-ending wire has been treated from a rigid theoretical basis by Abraham ‡, who determined the electric and magnetic forces at any point in the field by directly integrating the Maxwellian equations. For the purposes of analysis the wire was considered to have the form of a very elongated paraboloid of

* Communicated by Prof. Trowbridge.

† C. A. Chant, "The Variation of Potential along a Wire Transmitting Electric Waves." *Am. Jour. Sci.* xv. p. 54 (1903); *Phil. Mag.* ser. 6, v. p. 331 (1903).

‡ M. Abraham, *Ann. der Physik*, ii. p. 32 (1900).

revolution, and the field to vary in such a way that the electric lines of force ended perpendicular to its surface. Sarasin and de la Rive* and others had compared the oscillations about a wire to those in an open pipe; but, as Abraham remarks, though the relations are essentially similar, the analogy must not be pushed too far. In the pipe the radiation is from within outwards, and is greatest in the direction of the axis; while in the electromagnetic case the radiation is from without inwards, being limited by the surface of the wire, and on account of the transversality of the vibrations there is no radiation along the axis. Moreover, in the air-vibrations there is a displacement of the entire system of nodes and loops towards the open end, while, with the electrical oscillations, to a first approximation, there is no such displacement. On a closer examination, however, there is found to be a displacement of this kind, variable with the frequency. The phase of the advancing waves alters in a discontinuous manner, somewhat as in the vibrations of a plucked string †.

When two wires are used, as in Lecher's arrangement, the radiation in the direction of the axis does not vanish, and the analogy to the open pipe is more marked. There is then a decided displacement of the nodes and loops, well exhibited in an investigation by de Forest ‡.

The best acoustical analogy to a wire connected at one end to earth or to a large capacity and free at the other, seems to be a closed pipe, gas-pressure in the pipe corresponding to potential or charge in the case of the wire. Here there is a displacement of the nodes and loops, but it is very small, and only the odd harmonics are present in the two cases. Of course a rod clamped at one end is similar to the closed pipe.

Birkeland and Sarasin § in their investigation of the field about a free-ending wire explored with a circular resonator and found the first node distant from the end by one-half the circumference of the resonator (a result similar to that obtained by Sarasin and de la Rive in their investigation on two parallel wires, and ascribed by them to the geometrical form of the resonator), and other nodes regularly spaced along the wire at intervals equal to twice the diameter of the resonator. The form of the nodal surfaces in the space

* E. Sarasin and L. de la Rive, *Archives des Sciences Physiques et Naturelles, Genève*, xxiii. p. 113 (1890).

† Helmholtz, 'Sensations of Tone', p. 54; Rayleigh, 'Theory of Sound,' art. 146.

‡ L. de Forest, *Am. Jour. Sci.* viii. p. 58 (1899).

§ K. Birkeland and E. Sarasin, *Comptes Rendus*, cxvii. p. 618 (1893).

about the wire obtained by them agrees with that deduced by Abraham.

Slaby's theoretical treatment* of the problem is much simpler than Abraham's, and from his results he was led to his method of syntonic telegraphy. He takes the so-called "telegraphic equation,"

$$R_1 \frac{\partial i}{\partial t} + L_1 \frac{\partial^2 i}{\partial t^2} = \frac{1}{C_1} \frac{\partial^2 i}{\partial x^2},$$

where i is the current strength at any time at a place x on the antenna, and R_1, L_1, C_1 , are the resistance, self-induction, and capacity per unit length of the wire. A solution † is

$$i = Ae^{-\frac{R}{2L}t} \cos \frac{2\pi}{T} t \sin \frac{\pi}{2l} x,$$

where $T = 4\sqrt{LC}$, l is the length of wire, A is a constant, and R, L, C relate to the whole length of the wire. The frequency is $1/T$ and $\lambda = 4l$. From this solution it should follow that the disturbance varies according to the simple harmonic law, and that the free end of the wire is a potential loop, the lower end a potential node.

II. Experimental Arrangements and Results.

In the present investigation all the wires explored were of bare copper and were stretched horizontally on the tops of wooden poles, about 1.5 m. high and 1.6 m. from the wall of the room in which the experiments were made. This room was a large hall on the first flat, about 22 ms. long, 12 ms. wide, and with a ceiling 13 ms. high. The manner of examining the wire at various points in its length was precisely similar to that in the former research. The induction-coil and interrupter, the magnetometer, and the method of taking readings were identical with those used earlier and need not be described again here.

In most of the work the detector was the one used before, but during the course of the experiments it was broken, and another, similar to it and indistinguishable from it in its behaviour, was constructed.

The manner of applying the detector to the wire was slightly different. Before, the detector was laid on the top of a carriage moving on ways along the wires, with the little wing (w , fig. 1) in a little pocket by the wire; now, a

* A. Slaby, Lond. Electrician, vol. xlvi. Jan. 18, 1901; also vol. xlix. April 25, 1902.

† See Webster, Electricity and Magnetism, arts. 255, 256.

small piece (c) of cylindrical hard-rubber rod, in which a groove was made down to the axis, along a plane through

Fig. 1.

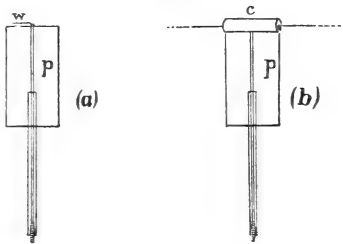

the axis, was fastened to the hard-rubber plate (p) by wax, and the detector was then hung on the stretched wire at any place desired.

The curves are plotted from the mean of at least three sets of readings.

The published accounts of the exploration of wires about which electrical disturbances are produced as in wireless telegraphy, are not numerous, and, as far as I can learn, in no case has the exploration been at all minute.

In the present investigation three methods, well-known in practice, have been used to excite the oscillations.

Marconi's Simple Method.

This arrangement is illustrated in fig. 2. The "oscillator" in this case consisted of two cylindrical brass rods, AB, CD, 9.5 mms. in diameter and 12.5 cms. long, ending in spherical knobs B, C, 3.8 cms. in diameter. One half of the doublet is shown on a larger scale at the left-hand of fig. 2. From

Fig. 2.

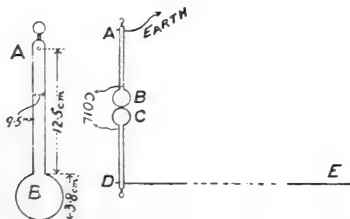

D led off the antenna DE. In some experiments A was connected to earth, in others a wire similar to DE was attached to A, while in one series this end of the doublet was left entirely free.

The knobs B, C were not kept polished, and the spark was about 1.9 mm. long.

For earth. in the case of wires of lengths 500, 1500, and 2000 cms., A was joined immediately to a large sheet of tin which, along with about two square metres more of sheet metal, was firmly connected to a steam-heating radiator near by. For the wire 1000 cms. in length the connexion from A to the sheet of tin was about 75 cms. long.

The wire joined to A in place of the earth connexion was precisely the same as that acting as antenna and attached to D; and in order to prevent inductive effects between these two wires the former was drawn up in a vertical direction by a cord over a pulley in the ceiling.

The readings were taken at points, usually 20 cms. apart, from one end of the antenna to the other, the readings in some cases beginning at the free end, in the rest ending at it.

A general view of the results obtained is given in Table I. and fig. 3. In the table the distances of the minima from the free end are given in centimetres, and the less-marked minima are inclosed in brackets. In all the curves ordinates denote magnetometer-deflexions, abscissæ distances from free end of wire.

TABLE I.

| Length of antenna, cms. | Distance, in centimetres, of minima from free end of antenna. | | |
|-------------------------|---|-----------------------|------------------------|
| | A. | B. | C. |
| | With earth connexion. | With equal long wire. | No earth connexion. |
| 500 | (175). None. | 260. None. | |
| 1000 | (120), (375), (500). None. | (150), (660). None. | 130, 425, 715, (1000?) |
| 1500 | (320?). None. | | |
| 2000 | None. | | |

It is seen from the curves, that joining to earth one pole of the oscillator is equivalent to adding to that pole a wire similar to the antenna; or, in other words, the earth acts like a plane mirror in optics. This view has been put forward by several writers, especially by Slaby*, when offering an explanation of his system of syntonic telegraphy.

* A. Slaby, *Funkentelegraphie*, 2nd ed. p. 86, and fol. Berlin, 1901.

In the curve obtained with the antenna of 1000 cms. connected to earth (see fig. 3), there is a deep minimum at

Fig. 3.

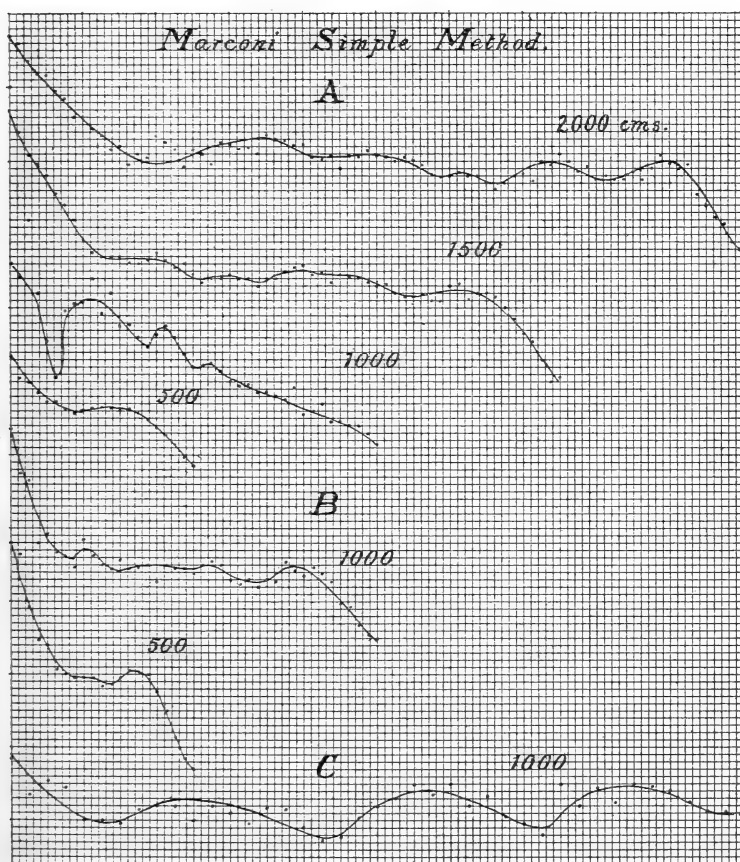

approximately 123 cms. from the free end, and a second one at 375 cms. This would give

$$\begin{aligned} \lambda/2 &= 2 \times 123 = 246 \text{ cms.} \\ &= 375 - 123 = 252 \text{ ,,} \\ &\text{Mean } \underline{249} \text{ ,,} \end{aligned}$$

In the curve obtained with no earth or other connexion the natural oscillation of the wire as a whole is practically absent, but there are minima at distances

130, 425, 725 (1000?) cms.

That at 1000 cms. is not decisive from the curve, and so it is omitted in the following calculation (though including it would make no difference in the result) :—

$$\begin{aligned}\lambda/2 &= 2 \times 130 = 260 \text{ cms.} \\ &= 425 - 130 = 295 \text{ ,,} \\ &= 715 - 425 = 290 \text{ ,,} \\ &\text{Mean } 282 \text{ ,,}\end{aligned}$$

These, I believe, are half wave-lengths of overtones. In the first case the wire was grounded and so only odd overtones would be possible, the one present being probably the ninth, counting the fundamental the first. If such was the case, the entire length of the oscillating wire from free end to earth should be

$$9 \times \frac{249}{2} = 1120 \text{ cms.},$$

a result requiring the oscillator to be equivalent to

$$1120 - (1000 + 75), \text{ or } 45 \text{ cms.}$$

of the wire. This explanation seems to me the most probable.

I may remark that the curves obtained with the wire 1000 cms. long, connected to earth, were the most irregular of all secured during the investigation, especially in the space between 100 and 300 cms. from the free end. A possible cause contributing to this may have been that the electrical disturbance was not produced immediately at the earth end.

In the second case the oscillating wire was free at each end, and so the entire system of overtones was possible. The one present, with half wave-length of 282 cms., seems to be the fourth, in this case the oscillator adding to the wire one-fourth of a wave-length.

It may be questioned why these particular overtones were present, and the others not noticeable. I think it was because the natural period of the oscillator alone was in approximate accord with them, being about one-half that of those exhibited. This would agree with the results of Lindemann*, who found that the waves proper to the oscillator as well as those of the entire system of oscillator and wires should be present.

I have not been able to identify the other ripples of the curves.

Slaby † and Braun ‡ have both studied the simple Marconi

* A. Lindemann, *Ann. der Physik*, ii. p. 376 (1900).

† A. Slaby, *Elektrotechnische Zeitschrift*, 1902, p. 168; extended abstract in *Lond. Electrician*, vol. xlix. p. 6 (1902).

‡ F. Braun, *Phys. Zeitschrift*, iii. p. 143 (1900).

system. The former used a wire about 10 metres long, and explored it with a spark micrometer in which a blunt metal cone was opposed to a flat face of arc carbon. According to the curve he obtained (fig. 1 of his article), there was a standing wave, with potential loops at the ends and a relative node in the middle. In my experiments there is a node at the end of the wire attached to the coil. Slaby concluded that the overtones present were very trifling and that the oscillation emitted was almost a pure fundamental. The fundamental is certainly present in great intensity, but the readings giving it are sometimes scattering, as mentioned above, and the curve is not very smooth. In some cases, too, as already seen, overtones show in considerable strength. Slaby also found that when the pole of the induction-coil was joined, not to an end of the antenna, but to some other point, the oscillation produced showed considerable distortion. This effect is similar to that noted above in the case of the 1000 cms. earthed wire.

Braun used a wire 15 metres long stretched horizontally, and from it suspended five small Geissler tubes, each with a wire 50 cms. long hanging below it. When the coil was in action the tubes lighted up, but there was no trace of a node or a ventral segment.

Inductive Method of Excitation (Braun, Marconi).

The experimental disposition used for inductively exciting the oscillations about the antenna is illustrated in fig. 4.

Fig. 4.

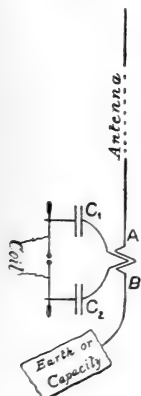

C_1 , C_2 are two condensers. From the inner coatings conductors lead off and end in knobs, between which sparks are made to pass by an induction-coil. The outer coatings are joined by a thick wire bent into a single turn which acts as the primary of a transformer. The secondary of this transformer (AB) consists of a few turns. To one end of it (A) the antenna is joined, and to the other end (B) the earth, any desired capacity, or a wire similar to the antenna.

The apparatus actually used in the investigation was the transmitter of the experimental set supplied by the Gesellschaft für drahtlose Telegraphie, Berlin, Germany, of the system Prof. Braun and Siemens & Halske. Each condenser consisted of four small tubular jars, 17.5 mms. in diam., 2 mms. thick, and with coatings approximately 7.5 cms. high. The spark-gap was from 1 to 2 mms.

long, and no attention was paid to polishing the knobs. That portion of the condenser circuit forming the primary of the transformer was a single turn of copper wire 6 mms. in diameter, bent into a circle of mean diameter 6.8 cms. (D, D, fig. 5). The secondary, which was within the primary, consisted of $5\frac{1}{2}$ turns of heavily insulated wire of a total length of 99 cms. The diameter of the wire and its insulation was 2.5 mms., and the turns lay close together. A vertical section, one-half of full size, is shown in fig. 5.

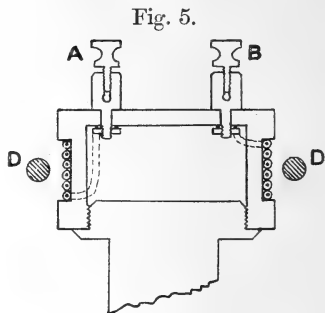

As is known, in this system earth connexion is usually not made*, but in place of it an earth plate is used, intended to balance the antenna and thus give symmetry to the oscillating system. The earth plate supplied with the apparatus was a hollow metal cylinder, 20 cms. long and 8 cms. in diameter. It was joined to a binding post (B) of the transformer secondary by a wire 40 cms. long. When it was desired to join B to earth the cylinder was securely bound to a large metal plate, which, along with other metal sheets, was connected to the heating-radiator. When employing a wire similar to the antenna to balance it, this wire was joined to B and, as in the experiments described above, was drawn up towards the ceiling.

In supplying the apparatus the makers stated that it was designed to emit waves of length 10 metres. It was very constant in its action and easy to handle.

An extended series of observations was made with antennæ varying from 200 to 1000 cms., and with four different attachments to the end B of the transmitter transformer, as follows:—

- A. With cylinder joined by a wire 40 cms. long.
- B. With earth joined to this cylinder.
- C. With a wire similar to the antenna joined to B.
- D. With the end B free.

A view of the results obtained is given in Table II. and Pl. XII. figs. 6, 7, 8, 9.

On examination it will be seen that the curves obtained by the three methods, A, B, C, are hardly distinguishable from each other. Those with method D differ from these somewhat.

* See discussion on a paper by M. Wien, read before the 74 Versammlung deutscher Naturforscher und Ärzte at Carlsbad, Sept. 1902. *Phys. Zeit.* Oct. 1902.

TABLE II.
Inductive Method.

| Length of antenna, cms. | Distance, in cms., of minima from free end of wire. | | | |
|--|---|-----------------------------|------------------------|----------------------|
| | A. With cylinder capacity. | B. With earth connexion. | C. With equal wire. | D. With end free. |
| 200 | | | | 140 |
| 225 | 184 | 190 | (70), (190). None. | |
| 250 | 200 | 180 | (90). None. | |
| 300 | [238] | 187 | [225] | 148 |
| 400 | 187, (265) | 185 | 185 | 160, (280?) |
| 500 | 180 | 180 | 180 | 183 |
| 600 | 186, (375), (520) | 200, (520) | 182 | 167, (415) |
| 700 | 188, (637) | 200 | 180 | 148, 617 |
| 800 | 191, (745) | 200 | 189 | |
| 900 | 200, (790) | 200, (380), (790) | 193, (790) | |
| 1000 | 180, (320) | 208, (800), (920) | 180, (860) | |
| Mean ... | 188.4 | 193 | 184.1 | |
| Mean of 188.4, 193, 184.1 = 188.5 cms. | | | | |

In A, B, C there is a gradual fall from the free end to the other, which gives the fundamental of the wire itself; but superposed on this and more prominent than it is another oscillation very definitely formed as far as the first minimum. This is unquestionably due to the oscillation of the condenser circuit, and the distance from the free end to the minimum is a quarter wave-length of it.

With wires of lengths 225 and 250 cms., in disposition C, there is to be seen only the fundamental of the wire, while with length 300 cms., in dispositions A and C, the minimum appears abnormally displaced. The curves in these last two cases are not so smoothly formed and are not considered in the calculation of the means given in Table II. The mean of the three means given in the table is 188.5 cms., which I take to be the quarter wave-length of the condenser-circuit oscillation.

The curves obtained with disposition D, shown in fig. 9, differ somewhat from the others. Here the variation of potential at the end joined to the transformer is almost as great as that at the free end. This is due, without doubt, to the fact that the antenna and transformer secondary together compose a single conductor, and the fundamental

oscillation would have a potential loop at each end. But the chief minimum shows a rather remarkable variation. As the length of the antenna is increased the distance of the minimum from the free end increases until it reaches its greatest value with a wire 500 cms. long, and then it decreases. The reason for this is not very evident, but it seems that in this disposition the reaction of the secondary of the transformer upon the primary varies with the length of the antenna joined to it, thus altering its frequency, the greatest change being when the wire is 500 cms. long. With an antenna of this length the readings were the highest of the series, and the quarter wave-length deduced from the curve approximately the same as that obtained in the dispositions A, B, C.

As has been already remarked, the curves are very clearly defined. The successive sets of readings agreed remarkably well, but yet it was impossible to get a second minimum at a distance of three-quarters of a wave-length from the end. This is not what was looked for with this transmitter. One would expect the condenser circuit, with its persistent oscillations, to keep up perfect standing waves in a wire in resonance with it, but with no length used was this satisfactorily exhibited.

The waves radiated from the wire, no matter what its length, have the frequency of the condenser circuit, and also, to a smaller degree, that of the fundamental of the wire. Overtones are scarcely noticeable.

From my experiments it must be concluded that the earth-connexion does not injuriously affect the *form* of the oscillation about the antenna; indeed the curves obtained with disposition B are rather more uniform than those with the others. The earth-connexion, however, assuredly has influence in other ways. I believe all systems of wireless telegraphy, except the Braun and the Lodge-Muirhead*, join both transmitter and receiver to earth; and, according to Jackson †, severing the earth-connexion reduced the signalling distance by 85 per cent. The action of the earth must be that of *guiding* the waves, thus allowing them to pass over obstacles such as the bulging-out of the earth's surface. The explanation given by Taylor ‡ seems the most satisfactory.

* See Nature, vol. lxxviii. p. 247, July 16, 1903; N.Y. Electrical World and Engineer, vol. xlii. p. 173, Aug. 1, 1903.

† H. B. Jackson, Proc. R. S., lxx. p. 254 (1902).

‡ J. E. Taylor, Lond. Electrical Review, May 1899. See also L. de Forest, N.Y. Electrical World and Engineer, May 17, 1902; Prash, *Die drahtlose Telegraphie* (Stuttgart, 1900), p. 65.

This explanation is very similar to that suggested by Lecher *, and to that by Heaviside †. More recently Köpsel ‡ has put forward the view that in Marconi's long-distance transmission the earthing wire and earth capacity form a system in partial, if not in entire, resonance with the antenna. There may have been some such effect in the transatlantic experiments, but such can hardly be the case in the numerous experiments by other workers who find ground connexion necessary to success.

Method of Direct Excitation (Slaby-Arco).

Fig. 10.

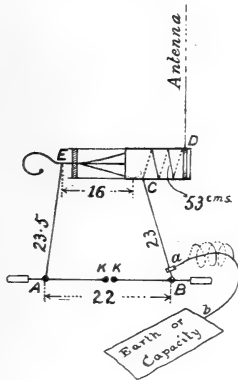

In the method of *directly exciting* the oscillations, one point of the condenser circuit is joined to the antenna, another point to earth.

A diagram of the connexions is shown in fig. 10 §. A and B are the terminal binding-posts of the secondary of the induction-coil, the distance between them being 22 cms. The spark-knobs, K, K, were 16.5 mms. in diameter, and the spark length was from 1 to 2 mms. The leyden-jar had a mean diameter of 5.7 cms., with walls about 4 mms. thick. The coatings were 10 cms. in height and of area about 180 square cms. The lengths of the various parts

of the circuit are indicated on the figure, the entire condenser circuit having a length of approximately

$$53 + 23 + 22 + 23.5 + 16 = 137.5 \text{ cms.}$$

The wire CD wrapped about the jar was heavily insulated and consisted of $2\frac{1}{2}$ turns. This corresponds to Slaby's "syntonizing coil," though, of course, it was not used for syntonization in my experiments. The turns were about 2 cms. apart, so that its self-induction was practically the

* E. Lecher, *Phys. Zeitschrift*, iii. p. 13 (1902); iv. p. 320 (1903).

† Heaviside, *Electromagnetic Theory*, vol. i. § 60; vol. ii. § 393. See preface to vol. ii.

‡ A. Köpsel, *Dingler's Polytechnisches Journal*, June 1903; abstracted in *N.Y. Electrical World and Engineer*, Aug. 29, 1903. See also a letter by R. A. Fessenden on "Theories in Wireless Telegraphy" in *N.Y. Electrical World and Engineer*, Oct. 31, 1903.

§ The arrangement was taken from that described by the *Allgemeine Elektrizitäts Gesellschaft* in their circular regarding the Slaby-Arco system, 1902. See also Boulanger et Ferrière, *Télégraphie sans Fil*, p. 156, 4th ed., 1902.

same as that of an equal length of straight wire. It was put in this form, however, through a desire to have the arrangement as nearly as possible like that used in actual practice*.

It will be seen that 75 cms. of the closed condenser circuit are a part of the open antenna circuit. According to Braun† the larger this portion of the condenser-circuit included in the antenna is, the better will be the effect, and it performs a rôle other than simply as a portion of the antenna.

Four different arrangements were employed to balance the antenna wire:—

- A. The cylinder capacity used in the experiments with the Braun transmitter was connected to the condenser circuit at *a*, the length of the wire *ab* being 40 cms. Thus the length from this capacity to the end D of the antenna was $40 + 75 = 115$ cms.
- B. The point *a* was joined to earth (the same as above), the wire *ab* being 25 cms. long. In this case the length of the conductor between earth and D was $75 + 25 = 100$ cms.
- C. To *a* was attached a wire precisely similar to that used as antenna. Here the two wires were joined by 75 cms. of the condenser circuit. As before, the balancing wire was drawn up in a vertical direction towards the ceiling.
- D. The same as B, except that between *a* and *b* an inductance-coil was inserted. This coil was of heavily-insulated wire, the conductor having a diameter of 2 mms., the diameter over all being 7 mms. There were 4 turns lying close together, with a total length of 82 cms. The object was, of course, to see if there would be any evidence obtained of the wave-length being increased by inserting this inductance-coil at the base of the antenna. In this case the length of the conductor from D to earth was $75 + 82 + 25 = 182$ cms., though the inductance-coil itself would probably be equivalent to 200 cms. of straight wire.

A view of the results obtained on using wires varying in length from 200 to 1000 cms. and the four experimental dispositions just described is given in Table III. and the curves of figs. 11, 12, 13, 14 (Pl. XIII.).

* Several good illustrations of the latest apparatus are given in C. Arldt, *Die Funkentelegraphie*, pp. 48–51 (Leipzig, 1903).

† F. Braun, *Ann. der Physik*, viii. p. 199 (1902).

TABLE III.
Method of Direct Excitation.

| Length of antenna, cms. | Distance, in cms., of minima from free end of wire. | | | |
|-------------------------|---|-----------------------------|------------------------|-------------------------------------|
| | A. With cylinder capacity. | B. With earth connexion. | C. With equal wire. | D. Inductance spool and earth. |
| 200 | (60), 153. | None. | None. | (60), 160. |
| 300 | 100. | None. | None. | (90). None. |
| 400 | 120, 360. | (120), (205), None. | 105. None. | 80, 230, 380. |
| 500 | 106, 280, 455. | (120), 215. | (125), 198. | (120), (200), (320). |
| 600 | 100, 290, (435), (545). | None. | None. | None. |
| 700 | 110, 300, (580). | 100, 300, 500. None. | (120). None. | (58), (170), (280), (420). None. |
| 800 | 100, (300), (518), (650). | (120). None. | None. | None. |
| 900 | 90, 310, 495. | (200). None. | None. | (140), (320), (740). None. |
| 1000 | (160). None. | (100), (220), (700?). | (100). None. | (100), (220). None. |

It is seen that the curves obtained with disposition A (fig. 11), are of a different type from those with the three other dispositions. In these latter there is always a gradual but decided drop of potential-variation from the free end of the wire, that is, the fundamental of the wire is very intense, though the curves show other oscillations superposed. With disposition A this strong fundamental is absent, and the minima present are undoubtedly due to the oscillations impressed on the wire by the condenser circuit. All through this series will be seen a minimum occurring at approximately 100 cms. from the free end of the wire, and in many cases one or two other minima spaced at approximately 200 cms. apart. The same minima appear in disposition B with wire 700 cms. long, and C with wire 400 cms.

The mean value of the wave-length is 404 cms., calculated as follows:—

| Wire. | $\frac{\lambda}{2}$ |
|--------|---------------------------|
| A. 300 | $2 \times 100 = 200$ cms. |
| 400 | $2 \times 120 = 240$ „ |
| | $360 - 120 = 240$ „ |
| 500 | $2 \times 106 = 212$ „ |
| | $280 - 106 = 174$ „ |
| | $455 - 280 = 175$ „ |
| 600 | $2 \times 100 = 200$ „ |
| | $290 - 100 = 190$ „ |
| 700 | $2 \times 110 = 220$ „ |
| | $300 - 110 = 190$ „ |
| 800 | $2 \times 100 = 200$ „ |
| 900 | $2 \times 90 = 180$ „ |
| | $310 - 90 = 220$ „ |
| | $495 - 310 = 185$ „ |
| B. 700 | $2 \times 100 = 200$ „ |
| | $300 - 100 = 200$ „ |
| | $500 - 300 = 200$ „ |
| C. 400 | $2 \times 105 = 210$ „ |
| | Mean 202 „ |

The curves in B and C (figs. 11, 12), are very similar, from which it is to be concluded that the simple earth-connexion is equivalent to a wire similar to the antenna, or, as already indicated in previous experiments, the earth acts as a mirror.

The curves in D (fig. 14) are not so regular in their form as those in B and C. There is a gradual fall of potential, but the fundamental is not so intense as in the others, and there is a superposition of other oscillations. This agrees with the statement of de Forest * that with this arrangement there is liability to overtones. It is to be observed, too, that here again the disturbance is produced at some distance from the earth end.

It is to be noted that none of the curves in A is similar to any in C. From this it follows that though as far as the *frequency* of the oscillations in an open circuit is concerned, a capacity may replace an inductance, still the *form* of the oscillations is quite different in the two cases.

Thus the direct method is, generally speaking, similar to the simple system, but it is more regular and more powerful. According to Wien † the radiation is thirteen times as intense as that of the simple radiator.

* L. de Forest, N.Y. *Electrical World and Engineer*, May 17, 1902.

† M. Wien, *Ann. der Physik*, viii. p. 686 (1902).

III. *Conclusions.*

The following conclusions seem to follow from my experiments:—

1. In the simple Marconi method and the method of direct excitation, when the antenna is joined to earth, the effect is similar to using a wire the same as the antenna to balance it; that is, considered from an optical point of view, the earth acts as a plane mirror.

2. In these conditions the chief oscillation is the fundamental of the antenna, with wave-length four times its length. The condenser circuit in the method of direct excitation impresses its wave-length on the antenna, but its oscillations are not nearly so intense as those proper to the antenna itself. Thus the manner of oscillation is essentially the same in the two methods, but the latter is more regular and powerful than the former.

3. In the inductive method of excitation, on the other hand, the prominent feature of the oscillations is that one due to the condenser circuit. With antennæ of different lengths there is little change in this oscillation, the curve indicating it being decided and definite; but only one-quarter of its wave-length is shown. This may be due to the great losses from radiation by the wire. The fundamental proper to the antenna is also present, but it is not nearly so intense as in either of the other two systems.

4. The effective length of the antenna for proper resonance, therefore, is *one* quarter wave-length, not a higher multiple.

5. When inductance is inserted between the condenser circuit and the earth the fundamental oscillation is not so regular or intense, other oscillations (overtones) being superposed.

6. For the production of oscillations by the direct method a small capacity cannot satisfactorily balance the antenna; in the inductive method, however, a capacity acts like an earth-connexion or a similar wire.

IV. *Continuation of Former Investigation.*

In the previous experiments with Hertzian plate oscillators of various sizes and with wires ranging in length from 300 to 860 cms., there was usually one "chief" minimum of potential-variation between 100 and 200 cms. from the free end, and always a marked one about 10 or 15 cms. from the other end of the wire. It was hoped that by employing longer wires the phenomena of standing waves would be much better exhibited, and that several "chief" minima

would be shown. Such, however, has not proved to be the case. Wires 2050 and 4090 cms. long were carefully explored, the action on the wire being produced by means of an oscillator having plates 40 cms. square and the straight connexion between 60 cms. long, but the only unmistakable minimum was approximately 150 cms. from the free end, the same as was perfectly formed with wires from 300 cms. upwards.

Some evidence was obtained as to the cause of the marked minimum near the other end of the wire. It was due to the direct action of the oscillator on the detector. As described in the other paper, an attempt had been made to allow for this direct action by taking the reading when the wire was in place and also when it was removed, and then subtracting the latter from the former. This assumes that the two effects are quite independent, but such seems hardly to be the case. In the former experiments the detector lay in a horizontal plane on the top of a carriage which was moved along the wire. Thus the detector's length was parallel to that of the oscillator, though the little *wing* was perpendicular to it. As described in Section II. of the present paper, the detector was now hung in a vertical plane from the wire, so that its length was perpendicular to the axis of the oscillator. With this arrangement the minimum disappeared, thus showing that it had been produced by the direct action of the oscillator on the detector.

University of Toronto,
Toronto, Canada.

XIV. *Radioactivity of the Atmosphere.* By S. J. ALLAN,
M.Sc., Demonstrator in Physics, McGill University *.

[Plate XIV.]

IN a previous paper † some experiments were described dealing with the rate of decay and penetrating power of the excited radioactivity obtained from the atmosphere on a negatively-charged wire. It was found that the activity decayed according to an exponential law with the time, falling to half its value in 45 minutes. Its penetrating power was slightly greater than that of the excited activity from radium or thorium. Its absorption by solids followed an exponential law with the thickness, and the radiation was cut down to half its value by .001 cm. of aluminium.

The amount of excited activity that could be obtained from

* Communicated by Prof. E. Rutherford, F.R.S.

† Rutherford and Allan, *Phil. Mag.* Dec. 1902.

the air at any time was found to be strongly influenced by weather conditions. A cold, clear, windy day gave the largest amount and a warm dull day the least.

In the experiments described in the present paper the radioactivity was obtained from a closed room which gave a constant amount from day to day.

The electrical method of measuring the radiations has been used throughout the experiments. The electrometer employed was of the ordinary Thomson quadrant type, fitted with a needle of light construction, which was kept connected to one pole of a battery of 300 volts. A reflecting mirror and a millimetre-scale indicated the movement of the needle. Each scale-division corresponded to $\frac{1}{500}$ of a volt P.D. of the quadrants. A small quantity of uranium served to standardize the readings of the instrument.

Increase of Excited Activity with Time.

It has been shown in a previous paper * that the excited activity derived from the air decays according to an exponential law, the rate of decay being given by the equation

$$I = I_0 e^{-\lambda t},$$

where I is the excited activity at any time t , I_0 the maximum value, and λ a constant. If the excited activity produced on a negatively-charged wire is due to a constant supply of positive radioactive carriers whose activity decays according to the above equation, then the intensity of the activity I_t after an exposure for a time t will be given by

$$I_t = I_0 (1 - e^{-\lambda t}),$$

where I_0 is the maximum value and λ the same constant as before.

The following experiment was made to verify this view:— About 60 feet of copper wire was suspended in a large attic and kept charged to a constant negative potential of about 20,000 volts, by means of a Wimshurst machine driven by an electric motor. In parallel with the charged wire was arranged an adjustable spark-gap to regulate the constancy of the potential of the wire. After a certain time of exposure the wire was taken down and wound lengthwise on an iron frame. This frame was placed inside a cylindrical vessel of zinc and connected to one pair of quadrants of the electrometer, the other pair being earthed.

The zinc cylinder was connected to one pole of the battery and the other pole was to earth. Between the iron frame

* Rutherford and Allan, *loc. cit.*

and the cylinder was arranged a guard-ring, to prevent any leak around the ends of the electrodes. The rate of movement of the electrometer-needle was taken as a measure of the amount of excited activity present. The wires were always tested five minutes after removal from the attic.

The results obtained from these experiments are given in the following Table, the second column giving the amount of excited activity on the wire five minutes after it was taken down.

TABLE I.

| Time of exposure. | Excited activity produced. |
|-------------------|----------------------------|
| 22 minutes. | 6 divisions per sec. |
| 60 " | 12 " " |
| 90 " | 16 " " |
| 120 " | 23 " " |
| 135 " | 24 " " |
| 200 " | 26 " " |

The results are shown graphically in fig. 1 (Pl. XIV.).

From an examination of these results it will be seen that the excited activity increases with time according to the equation given above, rising to half value in about 60 minutes. It has been shown that the excited activity on a charged wire decays to half value in 45 to 48 minutes. The results are thus only approximately in agreement with theory, since it is difficult under the experimental conditions to obtain more than rough results.

Rates of Decay under various Conditions.

In the previous paper it was shown that the excited activity on a charged copper wire always had the same rate of decay, wherever and whenever produced. It was, however, deemed advisable to examine the rate of decay of the excited activity produced under as many different conditions as possible.

Iron and lead wires were tried and each gave the same rate of decay as the copper wire. Experiments were then made to see if by transferring the excited activity from the copper wire to such substances as leather and felt, by means of ammonia, any difference could be observed in the rate of decay. For this purpose about 150 feet of copper wire was suspended in the attic and kept charged for about three hours a constant negative potential of 20,000 volts. A piece of leather, about 7 cms. square, moistened with ammonia, was then rubbed over the wire, and by taking care to rub a fresh

part of the leather over the wire every five feet, a large quantity of excited activity could be transferred from the copper wire to the leather. This radioactive leather was then tested in the following apparatus:—Two parallel zinc plates were placed horizontally over one another, and insulated. The upper plate was connected to one pair of quadrants of the electrometer, the lower plate being connected to one pole of the battery, the other pole of which was earthed. The radioactive leather was placed on the lower plate, and the rate of movement of the needle taken as a measure of the quantity of radioactivity present. About 100 volts P.D. between the plates was sufficient for saturation. The apparatus was inclosed in a metal box connected to earth, which acted as a guard-ring.

It was found that with thin close-grained leather the excited activity decayed to half value in about 45 minutes, whilst with a thicker and more absorbent leather it took 48 to 52 minutes.

A piece of felt, moistened with ammonia, was also rubbed over the wire, and tested in the same way. Only a small quantity of excited activity could be observed in this, but it was found to decay much more slowly, falling only to half value in 60 minutes. Another thick spongy piece of felt gave a rate of decay even slower. If, however, the felt was reduced to ashes and the residue tested, much more radioactivity was observed than the felt itself showed. The reason for this seems to be that the ammonia dissolves off the matter which causes the radioactivity and carries it into the interior of the felt. Some of the radiation is thus absorbed in the felt before it can reach the surface.

The rate of decay of the activity of the ashes from the felt is about the same as for the copper wire. In Pl. XIV. fig. 2, curve I. shows the decay of the activity of the unburnt felt, and curve II. that of the ashes from the felt. The difference in the rate of decay in the two cases is probably due to the fact that the penetrating part of the radiation which passes through the felt has a rate of decay different from that of the whole radiation.

A piece of cotton wool, moistened with ammonia and rubbed over an active copper wire, then reduced to ashes and tested, gave a very large amount of radioactivity. The rate of decay is the same as for the excited activity on copper. This is a good method of obtaining a large quantity of excited activity in a concentrated form. It produces more ionization than uranium bulk for bulk.

When a piece of copper wire which has been made radio-

active was partly dissolved in ammonia and the solution evaporated, the residue gave the same rate of decay as the excited activity on the solid copper. The activity excited on a piece of rubber also gave the same rate of decay.

It has been shown by C. T. R. Wilson,* and independently by the author †, that freshly fallen snow, when evaporated down to dryness, leaves behind a residue which is temporarily radioactive. The rate of decay of this radioactive residue was examined. Snow was gathered from a thin sheet on the surface during a snow storm, evaporated down to dryness in a shallow dish, and placed in the parallel plate apparatus described above. A litre of snow, when evaporated, produces about the same effect as one-fifth of a gramme of uranium. The rate of decay was found to follow an exponential law, and the activity fell to half value in from 30 to 32 minutes. Thus there is a distinct difference between the rate of decay of the radioactivity on snow and that obtained from the air. The penetrating power, however, was found to be about the same for both. In fig. 3 are two curves showing the rate of decay of the radioactivity from snow.

C. T. R. Wilson has shown that freshly fallen rain, when evaporated, leaves a radioactive residue. This residue was tested in the same way as that obtained from snow, and it was found that the rate of decay was the same, the activity fell to half value in about 32 minutes. Wilson states that the activity of the rain-water he examined fell to one-quarter value in one hour. In fig. 4 are shown two curves for the decay of the radioactivity from rain-water, taken on different days.

Fig. 5 shows the curves of decay of the radioactivity from snow and of the activity excited on a lead wire and of the excited radioactivity from a copper wire transferred to felt, all plotted to the same scale for the sake of comparison.

Absorption of the Excited Activity by Solids.

A number of experiments were made with various solids to see if the absorption-density law held for the excited activity. The excited activity on a copper wire was transferred to a thin piece of leather moistened with ammonia, and the leather was placed between the parallel plates of the testing apparatus. Readings were taken when the leather was bare and when covered with thin layers of various solids. From the curve of decay and these readings the percentage absorption could

* Proc. Camb. Phil. Soc. 1902, No. 11, p. 428.

† American Physical Society, *JAN.* 1903; *Phys. Rev.* May 1903.

be calculated. The results for aluminium foil of average thickness $\cdot 00038$ cm. are shown in fig. 6. The lower one is for the excited activity transferred to leather and the upper one for that on a lead wire. The ordinates give the percentage of rays unabsorbed, and the abscissæ the number of layers traversed. It will be seen that there is a small difference in the penetrating power of the two.

In fig. 7 are plotted two curves, showing the penetrating power of the excited activity from (1) a thick piece of felt, and (2) a thin piece of leather? Curve II. follows closely a G.P. with the thickness up to about 10 layers, the radiation falling to half value after passing through about 2 layers of aluminium. After 10 layers there is a marked difference in the curve, 5 additional layers having only a small effect. With 25 layers $\cdot 8$ per cent. of the rays was still unabsorbed. The portion of the curve between 10 and 25 layers follows roughly a G.P.

These results show the presence of a more penetrating kind of radiation. Curve I. for the felt shows the same effect, except that there is a greater percentage of penetrating rays than in the case of the leather.

This difference can be explained on the assumption that there are two kinds of radiation given off—one, the α radiation, being practically all absorbed in about 10 layers of the aluminium foil, and a more penetrating β radiation. Now, the greater part of the excited activity on the felt would be carried into the interior by the ammonia, and hence the radiation would have to penetrate through a considerable thickness of felt before reaching the surface. The α rays will thus be largely absorbed, and the radiation at the surface consist of a greater percentage of β rays, which pass through more easily. This also explains why such a small amount of energy is given off from the felt compared with that given off from the leather, since in the former case the α rays are mostly absorbed. The α rays represent about 99 per cent. of the total energy radiated; the β rays are half absorbed in about 15 to 18 layers of the aluminium.

The excited activity from the ashes from radioactive cotton was tested in the same way, and showed the presence of β rays, though not in so large a percentage as the leather and felt. The three cases are compared in the following table.

If the radiation consists of rays of a homogeneous character, then the intensity I , after passing through a distance d of the

TABLE II.

| No. of layers of Aluminium. | Percentage of unabsorbed rays. | | |
|--------------------------------|--------------------------------|----------|-------|
| | Cotton ashes. | Leather. | Felt. |
| 0 | 100 | 100 | 100 |
| 1 | 66 | 66 | 66 |
| 2 | 44 | 45 | 54 |
| 3 | 31 | 33 | 38 |
| 4 | 19 | 22 | 30 |
| 5 | 12 | 14 | 22 |
| 7 | 4 | 5.8 | 15 |
| 10 | 1.5 | 1.8 | 11 |
| 15 | 1.3 | 1.5 | 8 |
| 20 | 1.04 | 1.33 | ... |
| 25 | .8 | 1.01 | 5 |

absorbing material, will be given by the equation

$$I = I_0 e^{-\lambda d}$$

I_0 is the intensity at the surface before any absorbing layer is laid on, λ being the coefficient of absorption of the material considered. If the absorption is proportional to the density,

then the ratio $\frac{\lambda}{\text{density}}$ should be a constant.

A number of substances were tried to test this point. It was difficult to get the solids in sufficiently thin layers to give enough ionization to work with. The β rays produced too little ionization for accurate measurement. The experiments were performed in the same way as already described, the solids tested being mica, celluloid, paper, aluminium, brass, tinfoil, silver, and Dutch-metal. The value of λ for each substance could be easily calculated from the curves of absorption. The results are shown in the following table.

TABLE III.

| Substance. | λ . | Density. | $\frac{\lambda}{\text{Density}}$ |
|-------------------|-------------|----------|----------------------------------|
| Mica | 1080 | 2.78 | 390 |
| Celluloid | 490 | 1.2 | 409 |
| Paper | 280 | 0.7 | 400 |
| Aluminium | 1050 | 2.6 | 403 |
| Brass | 1195 | 8.6 | 140 |
| Tinfoil | 1500 | 7.3 | 205 |
| Silver | 7100 | 10.5 | 680 |
| Dutch-metal | 3000 | 9.0 | 330 |

From an examination of these results it will be seen that

for the light substances and for aluminium the absorption is nearly proportional to density, but for the heavier metals there is a wide divergence.

These results are similar in character to those of Rutherford and Miss Brooks*, who examined the β radiation from uranium, and found that the ratio $\frac{\lambda}{\text{density}}$ was the same for such materials as mica, ebonite, glass, and aluminium, but differed greatly for the substances of high density.

Absorption in Gases.

A series of experiments were also made on the absorption of the excited activity by air, coal-gas, carbonic-acid gas, and hydrogen. For this purpose a special apparatus was constructed, the general arrangement of which is shown in fig. 8 (Pl. XIV.), and is similar in principle to that used by Rutherford in his experiments on uranium radiation †. It consists of a cylindrical brass vessel, closed at the top by an air-tight cover, and at the bottom by a mercury trap. It is divided on the inside into two chambers by means of a horizontal partition, which has a circular hole cut in it, covered with a sheet of aluminium .00038 cm. thick. The partition was insulated from the sides of the cylinder, and connected to one pole of the battery, the other pole being earthed. Immediately below the partition was a circular table, which could be moved up and down by means of a screw passing through the bottom of the cylinder. At the top of the upper chamber was suspended an insulated disk, connected to the electrometer.

The radioactive leather was placed on top of the table immediately underneath the aluminium foil. The radiation given off by this leather penetrated through a certain layer of air or any gas with which the cylinder might be filled, and thence through the aluminium foil into the upper chamber, where it could ionize the gas and produce a movement of the needle of the electrometer. The brass cylinder was earthed and acted as a guard-ring, preventing any leak along the sides. The radiation in passing through the layer of gas before reaching the upper chamber, would be absorbed to an extent depending on the thickness of layer traversed. This thickness could be regulated by means of the screw. The volume of gas in the upper chamber remaining constant the ionization produced there would always be a measure of the strength of the radiation unabsorbed after passing through

* Phil. Mag. July 1902.

† Phil. Mag. Jan. 1899.

a given thickness of gas. A fixed distance, about 6 mms., between the leather and the aluminium, was always taken as a basis from which to calculate the percentage of unabsorbed rays.

If the radius of the active surface is large compared with its distance from the aluminium foil, it can be readily shown from the ionization theory that the following equation holds :

$$I = I_0 e^{-\lambda x}.$$

I_0 is the intensity of the radiation after passing through a distance x of the gas, and λ the coefficient of absorption of the gas considered. The percentage of the radiation unabsorbed is calculated in the same way as for solids. The results of the experiments are shown plotted in fig. 9 (Pl. XIV.), the ordinates giving the percentage of rays unabsorbed after passing through a certain distance, and the abscissæ the turns of the screw-head, each turn corresponding to 1.27 mm. These results are compared with those of aluminium in the following table.

TABLE IV.

| Substance. | Radiation reduced to half its value in | λ . | Density. | $\frac{\lambda}{\text{Density}}$. |
|-----------------------|--|-------------|----------|------------------------------------|
| Aluminium | .00076 cm. | 1050 | 2.6 | 400 |
| Air..... | 1.28 " | .54 | .0012 | 450 |
| Carbonic Acid Gas ... | .76 " | .91 | .0018 | 500 |
| Coal Gas | 1.71 " | .41 | .00048 | 840 |
| Hydrogen..... | 3.56 " | .19 | .000083 | 2300 |

It will be seen that the absorption by gases follows the order of their densities, and is almost proportional to density for air and carbonic-acid gas.

Increased Conductivity of Air mixed with Water Spray.

J. J. Thomson * describes some experiments in which the conductivity of air was increased by passing it through a water-pump into a large vessel, where it was tested. He also found that when a brass rod was suspended in this vessel and kept charged for a number of hours to a high negative potential, it had acquired a certain amount of excited activity †.

* Phil. Mag. Sept. 1902.

† Note.—The effects observed by J. J. Thomson have since been shown by him to be due to a radioactive emanation present in the tap-water of Cambridge.

In view of the importance of these results, experiments were undertaken to see if the Montreal tap-water derived from the River St. Lawrence showed similar properties. For this purpose a large cylindrical zinc tank, diameter 102 cms. and height 150 cms., was used. In the centre of this was suspended a brass cylinder 5 cms. in diameter, which passed through an ebonite plate at the top of the tank, and was connected to the electrometer. The outer cylinder was connected to a battery of 300 volts. Between the two cylinders was arranged a guard-ring connected to earth. A rubber tube passed from the bottom of the tank to an ordinary water pump, from which a return tube entered the top of the tank. The natural leak of the tank filled with ordinary air was first observed, and found to vary from 4 to 5 divs. per sec. The water pump was then started, and the moist air circulated through the tank, while readings of the conductivity were taken every minute. The conductivity of the air in the tank immediately began to increase, and reached a maximum in about five minutes, reaching in one test 25 divs. per sec., or nearly six times the natural leak. When the water pump was stopped this increased conductivity at once began to decrease, and reached the natural leak in about six to eight minutes. The maximum varied from time to time, but was always from four to six times the natural leak. This modified air, when passed through pumice-stone saturated with sulphuric acid before reaching the tank, only gave 8 divs. per sec. as the maximum, but as soon as the pumice-stone was removed gave 20 divs. per sec. It was found that the quicker the air was drawn through the tank the greater was the conductivity produced. Passing the air through a cotton-wool plug destroyed a large portion of the conductivity. It was also found that when the moist air was passed through a spiral tube immersed in liquid air, or a tube heated to redness, the increase of conductivity previously observed was completely absent. The experiment was tried of allowing a quantity of liquid air to evaporate inside the tank, but no increase of conductivity could be observed.

A brass rod was suspended in the tank, and kept charged to a high negative potential for several hours, whilst the air charged with water-spray was circulating through. It was then removed and tested in another vessel, but no signs of any excited activity could be detected.

I think we may conclude from these experiments that the increased conductivity is not caused by an emanation in the water-spray, since it will not stand the tests to which an emanation may be subjected. Neither is there any

appreciable excited activity produced on a rod suspended in it. It takes a far greater volume of air than the tank held to produce any measurable amount of excited activity from the air, unless some radioactive substance, such as thorium or radium, is present. There is certainly an increase of conductivity produced, which dies away quickly, and which is undoubtedly caused by the mixture of the water-spray with the air. The water from the tap, when evaporated down to dryness and tested, gave no signs of any radioactivity.

Conclusion.

From these results we may conclude that the excited activity from the atmosphere behaves in many respects like the radioactivity from thorium and radium. It contains, as they do, an easily-absorbed α radiation, and a more penetrating β radiation. The α radiation is probably responsible for the greater part of the total energy radiated, and it is completely absorbed in about $\cdot 004$ cm. of aluminium and 10 cms. of air. The β rays are cut down to half value in $\cdot 007$ cm. of aluminium, and completely absorbed by $\cdot 06$ cm. The β rays probably consist of negatively-charged particles, similar to cathode rays, and projected with great velocity. The ionization produced by them is too small to test whether they are deviable in a magnetic field.

The difference in the rates of decay of the excited activity obtained under different conditions seems to point to the fact that the radioactivity of the atmosphere is of a very complex nature.

The radioactivity of snow and rain must be derived from some radioactive matter in the air which adheres to the surface of the snow-flake or rain-drop, and is brought down with it in its descent. A possible explanation of the difference observed in the rate of decay of the radioactivity from snow and rain, and that of the excited activity on a wire, may be based on the view that the radioactive matter in the air is of different kinds, having different rates of decay. Snow and rain may owe their activity to one kind while the negatively-charged wire removes all the active carriers to its surface. The rate of decay of the charged wire might thus be the resultant of several different rates.

In conclusion, I wish to thank Prof. Rutherford for his kindly interest in the work.

McDonald Physics Building,
McGill University,
Aug. 1903.

XV. *On the Number of Electrons conveying the Conduction Currents in Metals.* By ARTHUR SCHÜSTER, F.R.S.*

THE number of free electrons in a metal is equal to the number of metallic atoms in the same volume, or exceeds that number not more than three times.

This law may be deduced with considerable confidence from optical considerations. Drude has supplied us both with the equations regulating the transmission of light through metals, and with the necessary observations. He has also shown that the number of ions conveying this charge may be calculated, and has given an example in the case of nickel without noticing, however, apparently the coincidence of that number with the one indicating the number of atoms per unit volume. I think the matter may be put somewhat more convincingly than was done by Drude, inasmuch as the uncertainty arising from want of knowledge as regards one important factor may be to some extent dealt with by assigning an *upper* limit to the number obtained.

As there are several matters of principle involved, and it is desirable to be clear as to the data and assumptions on which the above conclusion depends, we may shortly summarize the whole line of argument. In the ordinary electromagnetic theory the inertia is calculated from the known magnetic field external to the conductor, and from an *assumed* magnetic field inside the conductor. The latter is calculated on the hypothesis that the current flows like an incompressible fluid which continuously fills the whole space. But if we take the now, I believe, universally adopted view, that the current is conveyed by definite charges each concentrated within a small volume on the electron, the actual magnetic field in the immediate neighbourhood of the electron is considerable in comparison with that determined by the former assumption. I have discussed this question in a previous paper†, and calculated the additional terms which have to be added to the coefficients of self-induction. If the distance between the electrons is great compared with their size the additional energy is practically the whole energy of motion of the electron. That part of the field which overlaps the field of other electrons is effective in increasing the energy of self-induction calculated in the usual way, and this, though large, is already provided for. As regards our present purpose, we may conclude that the whole electromagnetic energy is equal to that taken account of in the usual formulæ with

* Communicated by the Author.

† Phil. Mag. Feb. 1901.

the addition of the total energy of the moving electrons disregarding their mutual influences. If the apparent mass of the electron is m , so that its energy is $\frac{1}{2}mu^2$, then if N be the total number of electrons per unit volume, and i the current density, which is Nue , the required energy per unit volume is $\frac{1}{2}\sigma i^2$, where

$$\begin{aligned} Nmu^2 &= \sigma i^2 \\ &= \sigma N^2 u^2 e^2 \\ \therefore \sigma &= \frac{m}{Ne^2} \dots \dots \dots (1) \end{aligned}$$

Let us consider what data we have for the calculation of σ . Let N_1 be the number of atoms per unit volume, and put $N = pN_1$. Let further h be the weight of a hydrogen atom, a the atomic weight of an element, and d its density. Then $N_1ah = d$, or writing for the atomic volume a/d , we have

$$\sigma = \frac{m}{e} \cdot \frac{h}{e} \cdot \frac{A}{p} \dots \dots \dots (2)$$

Of the quantities involved h/e is known with considerable accuracy from electrolysis, and e/m is known with fair accuracy from recent experiments on the deflexion of cathode rays. Hence everything is known except p . Simon's value for e/m , which is 1.86×10^7 in electromagnetic units, is now generally considered the most accurate, though giving somewhat higher results than that of other observers. Adopting this value we find

$$\sigma = \frac{1.04 \times 10^{-4}}{1.86 \times 10^7} \cdot \frac{A}{p} = 5.6 \times 10^{-12} \frac{A}{p} \dots \dots (3)$$

The atomic volumes of the metals range from 6.6 (iron) to 56.3 (rubidium), but of the metals for which the optical constants are known the highest atomic volume is 21 (bismuth), so that if $p=1$ the values of σ vary from 3.7×10^{-11} to 11.8×10^{-11} , which fixes the order of magnitude. Let us now turn to the optical portion of the argument. For the conduction current w' we must write, if R be the electric force

$$w' = CR + C\sigma \frac{dw'}{dt}, \dots \dots \dots (4)$$

where C is the conductivity. To this we must add the current $N_2e\xi$ formed by electrons on molecules which are capable of vibration, but not of leaving these molecules. Their number n must be at least equal to N , the number of molecules present. ξ is the displacement, or if it is desired to consider the vibration of a doublet, we may consider ξ to

be the relative displacement of the positive and negative charges. If the electric force is periodic and contains the time factor $e^{-i\omega t}$, the displacement ξ is also periodic, but must be capable of expression in two terms, one in phase with R and the other in phase with $\frac{dR}{dt}$.

I write therefore

$$4\pi\xi = AR - \frac{B}{\omega} \frac{dR}{dt},$$

$$4\pi\ddot{\xi} = -\omega^2(A + iB)R.$$

The polarization current is $4\pi K \frac{dR}{dt}$.

I have, in the paper quoted, written down the complete equations of flow in conductors, taking account of σ , but the term involving that quantity was found to be insensible, except in the case of rapid changes like those of light. We may therefore here confine ourselves to periodic motion entirely, so that the differentiation with respect to the time may be replaced by the factor $-i\omega$. Under these circumstances (4) becomes

$$(1 - iC\sigma\omega)w' = CR \quad \dots \dots (5)$$

$$\therefore \frac{dw}{dt} = \frac{\sigma C^2 \omega^2 - i\omega CR}{1 + \sigma^2 C^2 \omega^2}.$$

For the total current variation we have now

$$4\pi \frac{dw'}{dt} = -\theta^2 R;$$

where

$$\theta^2 = \left\{ N_2 e A + K - \frac{4\pi C^2 \sigma}{1 + \sigma^2 C^2 \omega^2} \right\} \omega^2 + i \left\{ \frac{4\pi \omega C}{1 + \sigma^2 C^2 \omega^2} + N_2 e B \omega^2 \right\}, (6)$$

and the differential equation for R is

$$\nabla^2 R + \theta^2 R = 0. \quad \dots \dots (7)$$

Assuming plane waves in which the surfaces of equal amplitude coincide with the surfaces of equal phase, the solution may be written

$$R = R_0 e^{-\frac{2\pi}{\lambda} \kappa x} e^{i \left(\frac{2\pi}{\lambda} \nu x - \omega t \right)}. \quad \dots \dots (8)$$

In this equation λ denotes the wave-length *in vacuo*. The velocity of wave propagation is $\frac{\lambda \omega}{2\pi \nu}$, so that λ/ν is the wave-length in the medium, and ν denotes a quantity which corresponds to the refractive index in transparent bodies. It is

convenient to have a name for that quantity, and I call it the coefficient of optical length, the name of refractive index being reserved for another complex quantity occurring in investigations concerning the transmission of light through opaque bodies. The coefficient of optical length depends in general on the angle between the planes of equal phase and of equal amplitude, but here we have assumed this angle to be zero. By substituting (8) into (7) we find that

$$\theta^2 = \frac{4\pi^2}{\lambda^2} (\nu + i\kappa)^2.$$

Hence, comparing with (6), and separating real and imaginary quantities, and noting that $\frac{\omega^2 \lambda^2}{4\pi^2} = V^2$, where V is the velocity of light *in vacuo*, we find

$$\nu^2 - \kappa^2 = 1 + \left(N_2 A e - \frac{4\pi C^2 \sigma}{1 + \sigma^2 C^2 \omega^2} \right) V^2 \dots (9)$$

$$2\nu\kappa = \frac{2CV\lambda}{1 + \sigma^2 C^2 \omega^2} + N_2 B e V^2 \dots (10)$$

These are Drude's equations providing for a change in the notation. If we neglect the absorption due to the sympathetic vibration of the molecule, as is done in Sellmeyer's equation, we may put B=0. The ordinary method of introducing frictional forces to account for the absorption is in my opinion faulty, and I shall take another opportunity of discussing this question. It is sufficient for the present to note that the principle of the conservation of energy leads to the conclusion that there must be absorption, and hence that B has a positive value. Hence by neglecting it and putting

$$\nu\kappa = \frac{CV\lambda}{1 + \sigma^2 C^2 \omega^2} \dots (11)$$

we shall undervalue σ and overestimate p in (3).

If $\nu\kappa$ is obtained by observation of the reflecting properties of metals, equation (11) allows us to calculate σ . It is found that the square of $\sigma C\omega$ is sufficiently great to allow us to neglect unity in comparison with it, at any rate in the case of those metals which have a conductivity greater than that of lead. Even in the case of mercury, the error committed by omitting the first term of the denominator of (11) is only 6 per cent. The equation thus simplifies to

$$\begin{aligned} \nu\kappa &= \frac{V\lambda}{\sigma^2 C^2 \omega^2} \\ &= \frac{\lambda^3}{4\pi^2 \sigma^2 C V}. \end{aligned}$$

By introducing the value of σ from (3) we find

$$p^2 = 31.4 \times 10^{-24} A^2 \frac{4\pi^2 CV}{\lambda^3} \nu\kappa.$$

As Drude's measurements of $\nu\kappa$ refer to sodium light we put $\lambda = 5.89 \times 10^{-5}$, and substituting for V its value 3×10^{10} , we ultimately obtain

$$p^2 = 45.6 A^2 C \nu\kappa.$$

The following Table gives the value of p calculated in this way for all metals having a conductivity greater than lead; for mercury, bismuth, antimony, and lead the complete equation (11) was used.

| | A. | C. | $\nu\kappa$. | p . |
|-----------------|------|-----------------------|---------------|-------|
| Nickel | 6.7 | 8.03×10^{-5} | 5.94 | .99 |
| Mercury | 14.8 | 1.06 | 8.58 | 1.01 |
| Bismuth..... | 21 | .76 | 6.96 | 1.11 |
| Cobalt | 6.7 | 9.92 | 8.54 | 1.31 |
| Silver | 10.3 | 66.5 | 1.66 | 1.46 |
| Copper | 7.1 | 62.6 | 1.60 | 1.54 |
| Gold | 10.2 | 48.6 | 2.06 | 1.55 |
| Magnesium | 13.3 | 23.7 | 1.64 | 1.77 |
| Platinum | 9.1 | 11.0 | 8.78 | 1.91 |
| Lead | 18.2 | 5.1 | 7.00 | 2.34 |
| Cadmium | 13.0 | 14.6 | 5.66 | 2.53 |
| Antimony | 17.9 | 2.8 | 15.02 | 2.58 |
| Tin | 16.2 | 7.6 | 7.71 | 2.65 |
| Zinc | 9.5 | 17.8 | 11.62 | 2.92 |
| Aluminium | 10.1 | 34.3 | 7.53 | 3.47 |

The second and third columns give the atomic volumes and electric conductivities. The third column is Drude's value of $\nu\kappa$ for sodium light and the last column gives the factor p , indicating the ratio of the number of electrons to the total number of atoms. It should be noticed that although the extreme electric conductivities differ in the ratio of 63:1, and the values of $\nu\kappa$ in the ratio of 23:1, the extremes of p are only in the ratio of 3.5 to 1, so that the product $A^2 C \nu\kappa$, though not absolutely constant, is more so than two of its factors, the variability of the third (A) being about the same as that of p . For the first three metals on the list the number of electrons is practically that of the number of atoms, and p for all metals is less than three except in the case of aluminium, which in comparison with other metals is very opaque compared with its conductivity. It is always to be remembered that we have neglected all opacity due to selective molecular absorption so that our values of p are upper limits. Nevertheless, the fact that the

list contains no value of p sensibly less than one must have its significance. I have not included sodium in the list, though Drude has investigated to some extent its optical properties, and found the remarkable fact that light having a wave-length equal to that of sodium light is propagated in it with a velocity 220 times greater than in empty space. If these results are confirmed we should have to conclude that for sodium $p = \cdot 22$, or that there is only one conducting electron in it for every four or five atoms. But Drude admits the possibility of a large error possibly diminishing the velocity of propagation twelve times, and this would raise the value of p to $\cdot 76$. There is also some uncertainty as to the electric conductivity of metallic sodium, so that for the present we may leave this metal out of account.

If we once more ask ourselves to what extent these numbers may be trusted we may put down the assumptions made as follows:—

(1) The constancy of e/m in all metals and its value as determined by experiments on cathode rays; (2) the absence of opacity due to selective absorption.

As regards the first point, assuming the constancy of e/m , an error in the actual value would increase or diminish p in the same ratio for all metals. It is not altogether satisfactory that a quantity the constancy of which is asserted with considerable confidence is not known with greater accuracy, different methods disagreeing in their result by more than 100 per cent. We know in fact more about the charge e carried by the electron than about the more easily measured value of e/m . Those experiments in which the method first devised by myself is used, and e/m calculated from the magnetic deflexion and potential-difference, give, in the hands of later observers working under more favourable conditions, the higher values which I have adopted above. The combination of electrostatic and magnetic deflexions devised by J. J. Thomson gives a number about half as large. A great deal is to be said for Wiechert's method, in which the velocities are observed directly, and which gives as a mean about $1\cdot3 \times 10^7$, a result intermediate between Simon's value of 1·86 and the lower values in which electrostatic deflexions are used. If Wiechert's number be adopted the above values of p ought all to be multiplied by 1·4.

Experiments with electric discharges and radioactivity have made us familiar with ions carrying positive electricity and possessing a mass much greater than that of the negative electron. But if the mass of the electron were increased say five times, its effect upon $\nu\kappa$ would be diminished 25 times,

and would then become inappreciable, or at any rate so small that it could not be discharged from the probable effects of selective absorption. The effect of these greater masses is not denied, but their existence would not sensibly affect our present results, which apply only to the electron of small mass carrying a negative charge. Drude, in his discussion of optical constants in connexion with his electron theory of metals, assumed the existence of two kinds of conducting electrons, and could by means of them account separately for the observed values for ν and for κ .

My purpose is a more limited one, but the results obtained seem to me to be more definite on account of the small number of assumptions which are made.

Looking at the results of these calculations, the simplest explanation of metallic conduction would appear to be that each atom has one, or possibly two or three, negative electrons which are easily detached, and follow freely the electric force, even for such rapid oscillations as those of light. Drude assumes that they are always detached from the atom and behave very much as the ions in electrolytes are supposed to behave. He has worked out his idea in two important papers*, and given it substantial support in a variety of directions.

XVI. *On some Relations between the Optical and the Electrical Qualities of Metals.* By Prof. E. HAGEN and Prof. H. RUBENS †.

MAXWELL'S electromagnetic theory of light—which in its original form does not consider the molecules and their vibratory periods, but simply expresses the optical property of a single wave-length—demands the existence of analogous relations between the transparencies of metals and their electric conductivities. These relations have often been examined, without being confirmed in any way ‡. The theory did not seem to hold good, either with regard to the absolute amount of transparency, or with regard to the order in which the metals can be arranged according to their transparency, and which ought to be the order of their electrical resistances.

* Wied. Ann. xxxix. p. 537, xlii. p. 189.

† Cf. *Sitzungsberichte der K. Akademie der Wissensch. in Berlin*, p. 269 & p. 410 (1903), and *Ann. d. Physik*, xi. p. 873 (1903). Authors' translation communicated by Prof. C. Vernon Boys, F.R.S.

‡ Cf. W. Wien, *Wied. Ann.* xxxv. p. 48 (1888); and E. Cohn, *Wied. Ann.* xlv. p. 55 (1892), and others.

In a former paper* we have shown that some of these contradictions begin to disappear if, instead of examining the ultra-violet or the visible spectrum, we advance to longer wave-lengths. We found that platinum, which, in the visible and ultra-violet spectrum, is much more opaque than gold and silver, becomes more transparent than these metals in the infra-red. We have lately stated that the same is true in a higher degree with respect to bismuth. A thin layer of bismuth of about $90 \mu\mu$ thickness, which scarcely transmits 1/1000 part in the red, possesses a transparency of 10 per cent. at a wave-length not longer than $\lambda = 4 \mu$. Consequently it did not seem improbable that, passing to still greater wave-lengths, values in accordance with Maxwell's theory would be obtained for the diathermancy of metals. Supposing Maxwell's theory to be correct, this would mean that the influence of the molecular periods of the different metals vanishes gradually in the infra-red region, with increasing wave-lengths.

Relations quite similar to those that Maxwell's theory demands for the transparency of metals, can be foreseen for the intensity of the radiation penetrating into the metals, and for the power of emission. But these values are much easier to determine than the transparencies. In the first place, investigations of the transparency require considerably greater intensities of radiation. Secondly, no substances exist which—in that part of the spectrum—are sufficiently transparent for heat-rays, and can at the same time serve as supporters of such thin layers of metal †. Lastly, the number of metals suited to the examination of transparencies is much more limited than that suited to measurements of the emission or reflecting-power. This is owing to the fact that the construction of good reflecting-mirrors is much easier than that of metallic layers of equal thickness and perceptible transparency.

The intensity of radiation entering into the metals can be measured in different ways. The simplest method is by determining the reflecting-power, or by measuring the power of emission.

If R represents the reflecting-power of a metal for normal incidence expressed in percents of the incident radiation, the intensity of the radiation entering the metal is $I = (100 - R)$. In those parts of the spectrum in which the

* E. Hagen & H. Rubens, *Ann. d. Phys.* viii. p. 432 (1902).

† Rocksalt, sylvine, and silver chloride, which possess a sufficing transparency, cannot be used in consequence of their unfavourable chemical qualities.

energy suffices for exact measurements, and R is sufficiently different from 100, the determination of I can be successfully performed by measuring the reflecting-power. But it is just for the greatest attainable wave-lengths that these conditions are not sufficiently fulfilled. Therefore, in these regions it is preferable to determine I by measurements of the power of emission. If E be the emission of an opaque polished metal surface, and e that of "a black body" of the same temperature—both for the same wave-length—we obtain $I = E/e$ according to Kirchhoff's law.

Consequently our experimental research consists of two parts. In the first I is determined with the aid of the reflecting-power, in the second by measurement of the power of emission.

I.

The Reflecting-Power of Metals in the Infra-Red.

The reflecting-power of metals has often been the object of experimental research. In a paper published in 1889 by one of us*, the reflecting-power of a series of metals has been examined. From the results the conclusion was drawn that the better conductors of heat and electricity (silver, copper, gold) show a higher reflecting-power for infra-red rays than do the other metals. In addition to this paper, and that of A. Trowbridge†, our own recent research must be mentioned. But owing to the imperfection of the material and the surface of the mirrors employed, the results of the older researches do not permit any definite comparison with the electromagnetic theory. On the other hand, our own measurements‡ did not pass beyond the limit of 1.5μ , a wave-length not sufficing for this purpose.

Method of Observation.

The arrangement of our apparatus is given in fig. 1. H designates the slit of a spectrometer, furnished with silver mirrors (K and L) instead of lenses, in such way that $H K$ represents the collimator, and $L T$ the observing telescope. T is a linear thermopile, described in an earlier paper by one of us§. The prism P was of fluorite for the wave-lengths

* H. Rubens, Wied. *Ann.* xxxvii. p. 249 (1889).

† A. Trowbridge, Wied. *Ann.* lxxv. p. 595 (1898). The papers of S. P. Langley, Phil. Mag. xxvii. p. 10 (1889), E. F. Nichols, Wied. *Ann.* lx. p. 401 (1897), and F. Paschen, *Ann. d. Phys.* iv. p. 304 (1901) contain only measurements of the reflecting-power of silver in the infra-red.

‡ E. Hagen & H. Rubens, *Ann. d. Phys.* viii. p. 1 (1902).

§ H. Rubens, *Zeitschrift für Instrumentenkunde*, xviii. p. 65 (1898).

between 1 and 8μ , and of sylvine for the interval between 8 and 14μ . The galvanometer used with the thermopile was an iron-clad instrument of du Bois-Rubens' construction*, well protected against magnetic disturbances. The observer at the galvanometer could, by aid of a special arrangement, lift or drop the screen G, placed in front of the slit H.

In addition to this, the figure shows two supplementary mirrors, E and F, the source of light A, and the concave mirror S the reflecting-power of which was to be examined.

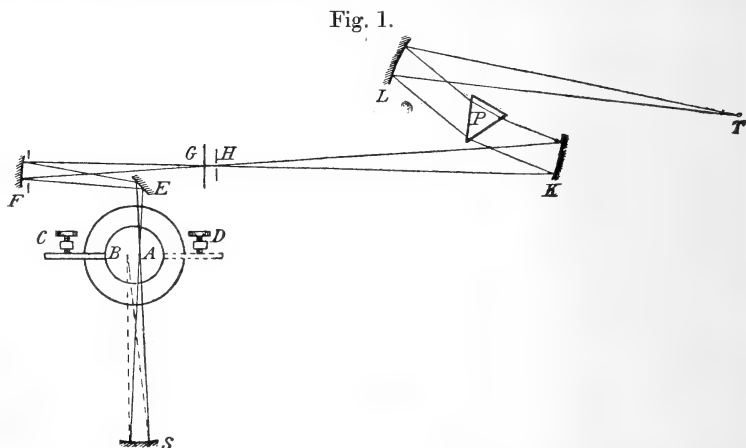

Our source of light was a Nernst incandescent lamp, the fibre of which (1 mm. thick and 2 mms. wide) was attached to a small turning-table in such a way as to permit a kind of excentric rotation. This table, as shown in the figure, was placed between the mirrors S and E. It was furnished with an arm which could be brought into contact with either of the two fixed screws C and D, thus permitting the transference of the Nernst fibre from position A into position B (dotted in fig. 1), and *vice versa*. Immediately in front of the fibre was adjusted a small slit (2 mms. wide), containing two crosses of very thin platinum wire 8 mms. above each other. The excentricity of the Nernst fibre and the position of the slit in front of it were adjusted by two different micrometric screws.

After undergoing reflexions from the plane mirror E and the concave mirror F, the rays coming from A were united on the slit H to an image of exactly the same dimensions as that produced directly by the source of light. The mirror S

* H. du Bois & H. Rubens, *Zeitschrift für Instrumentenkunde*, xx. p. 65 (1900).

was so adjusted that its centre of curvature lay on the axis of the turning-table. By this means an image of equal size also appears on the slit H when the lamp is at B. A proof for the correctness of our adjustment is given by the fact that the images of the two wire crosses on H are equally exact in both positions of the lamp.

We need simply to add that the slit H was 6 mms. high and 1 mm. wide, and that a diaphragm of 24×24 mms. was placed in front of the mirror F, in order to prevent any but the central part of the cone of rays from entering the slit. Thus it is evident that the rays follow the same path in both cases, the only difference being the additional distance B S A when the lamp is at B. On dividing the deflexion obtained in this position by that observed in the first case, the reflecting-power of the mirror S is at once obtained.

We undertook measurements for about 15 wave-lengths of the spectrum. While the Nernst fibre was in the position A, the total distance traversed by the rays was 210 cms., in the position B it amounted to 270 cms. Thus it became necessary to limit the observations to wave-lengths for which the absorption produced by the water-vapour and the carbon dioxide* of the atmosphere is not considerable. For our purpose the absorption is small enough, in most parts of the spectrum, to prevent perceptible errors. An additional distance, small compared with the whole path of the rays, scarcely increases the absorption already produced. Of all the wave-lengths concerning which measurements were made, $\lambda = 7 \mu$ is the only one forming an exception to this rule. Here a correction of about 3.1 per cent. was necessary, owing to the absorption produced by the water-vapour.

The Mirrors.

All the metals were used as concave mirrors of 30 cms. radius and 4 cms. aperture. They were made of very pure material. Three different modifications of silver, gold, and platinum, and two of nickel were examined. All these mirrors, except that of cast bismuth, possessed perfect surfaces and gave excellent images.

Results of the Observations.

Table I. (p. 162) contains the results of our measurements for seven pure metals and for six alloys. The curves of fig. 2 (p. 163) show the reflecting-power of ten of our mirrors for different wave-lengths. In the red, as well as in the neighbouring regions of the infra-red, our observations agree

* Cf. F. Paschen, *Wied. Ann.* li. p. 51, lii. p. 209, and liii. p. 335 (1894); also H. Rubens & E. Aschkinass, *Wied. Ann.* lxiv. p. 598 (1898).

TABLE I.—Reflecting-power R of Metals.

| Wave-length λ in μ . | Silver. | | | Copper. | | Gold. | | | Platinum. | | Nickel. | | Steel. | Bismuth. | Constantan, 60 Cu + 40 Ni. | Patent Nickel. | | Brades and Schneemann's Alloy 98 [32 Cu + 34 Sn + 29 Ni + 5 Fe.] | Rose's Alloy, 68.2 Cu + 31.8 Sn. | Magnesium, 69 Al + 31 Mg. |
|-------------------------------------|----------------|-------------------|-------------|----------------|---------------|-------------------|---------------|-------------|---------------|-------------|----------------|---------------|-----------|----------|-------------------------------|----------------------|----------------------|---|-------------------------------------|------------------------------|
| | Massive, pure. | Pre-precipitated. | Dissipated. | Massive, pure. | Electrolytic. | Pre-precipitated. | Electrolytic. | Dissipated. | Electrolytic. | Dissipated. | Massive, pure. | Electrolytic. | Unhilled. | Cast. | | 75 Cu + 25 Ni. M. | 80 Cu + 20 Ni. P. | | | |
| 0.65* | 95.9 | 95.9 | 94.9 | ... | 88.9 | 89.6 | 89.1 | 66.8 | 63.8 | 67.2 | 49.3 | 59.8 | ... | ... | 70.0 | 71.0 | 73.0 | 51.2 | 65.3 | 83.2 |
| 0.70 | 96.1 | 96.2 | ... | 82.9 | 92.3 | 91.3 | ... | ... | ... | ... | ... | ... | ... | ... | 71.2 | 71.4 | 73.8 | 51.2 | 65.3 | 83.2 |
| 1.0 | 96.4 | 97.5 | 95.5 | 90.1 | 94.7 | 93.6 | 93.6 | 72.9 | 70.4 | 73.0 | 72.0 | 63.1 | ... | ... | 72.4 | 72.6 | 75.0 | 69.8 | 70.5 | 84.1 |
| 1.5 | 97.3 | 97.9 | ... | 93.8 | 97.3 | 96.7 | 94.8 | 77.7 | 75.3 | 79.9 | 78.6 | 70.8 | ... | ... | 77.8 | 79.3 | 79.9 | 79.1 | 75.0 | 85.5 |
| 2.0 | 97.3 | 97.8 | 96.8 | 95.5 | 96.8 | 96.5 | 94.9 | 80.6 | 79.8 | 83.5 | 83.5 | 76.7 | ... | ... | 82.3 | 83.5 | 84.1 | 82.3 | 80.4 | 86.7 |
| 3.0 | 97.3 | 98.1 | 97.4 | 97.1 | ... | 96.7 | 95.6 | 88.8 | 88.5 | 88.1 | 88.7 | 83.0 | 71.7 | ... | 85.6 | 89.1 | 89.8 | 85.8 | 86.2 | 87.4 |
| 4.0 | 97.7 | 98.5 | 97.6 | 97.3 | 96.0 | 97.2 | 96.0 | 91.5 | 91.6 | 92.5 | 91.1 | 87.8 | 75.2 | ... | 88.3 | 91.4 | 92.1 | 87.1 | 88.5 | 88.7 |
| 5.0 | 97.3 | 98.1 | 97.3 | 97.9 | 97.0 | 96.9 | 95.7 | 93.5 | 90.8 | 94.7 | 94.4 | 89.0 | 77.2 | ... | 89.5 | 92.2 | 92.2 | 87.3 | 89.1 | 89.0 |
| 7.0 | 98.5 | 98.5 | 98.3 | 98.3 | 98.3 | 97.3 | 95.7 | 95.5 | 93.0 | 94.8 | 94.3 | 92.9 | 79.5 | ... | 92.7 | 92.3 | 92.1 | 88.6 | 90.1 | 90.0 |
| 8.0 | 99.0 | 98.5 | 98.1 | 98.6 | 97.8 | 96.8 | 96.1 | 95.1 | 92.5 | 95.0 | 95.7 | 93.0 | 81.5 | ... | 92.7 | 93.5 | 92.5 | 89.8 | 91.0 | 90.9 |
| 9.0 | 98.9 | 98.7 | 98.1 | 98.4 | 98.0 | 96.7 | 96.1 | 95.4 | 92.5 | 95.6 | 95.6 | 92.9 | 81.4 | ... | 93.0 | 93.7 | 92.2 | 90.3 | 92.2 | 90.6 |
| 10.0 | 99.0 | 98.7 | 98.5 | 98.5 | 97.8 | 97.7 | 96.1 | 95.9 | 93.1 | 95.4 | 95.6 | 93.5 | 82.3 | ... | 94.0 | 93.0 | 92.6 | 90.6 | 92.9 | 91.8 |
| 11.0 | 99.0 | 98.8 | 98.8 | 98.4 | 98.3 | 97.7 | 96.5 | 95.6 | 92.7 | 95.9 | 95.9 | 94.0 | 83.2 | ... | 93.4 | 93.0 | 93.8 | 90.2 | 92.9 | 90.7 |
| 12.0 | 98.9 | 98.8 | 98.1 | 98.4 | 97.8 | 97.9 | 97.2 | 96.5 | 94.9 | 95.7 | 96.1 | 95.1 | 82.2 | ... | 94.0 | 93.0 | 94.3 | 90.9 | 92.9 | 92.5 |
| 14.0 | 98.8 | 98.3 | ... | 97.9 | 97.9 | 98.7 | 96.7 | 96.4 | 94.7 | 95.6 | 97.2 | 96.0 | 81.6 | ... | 94.2 | 92.6 | 93.4 | 90.3 | 93.6 | 92.2 |

* As $\lambda = 0.65$ and $\lambda = 0.7 \mu$, a water-cell was introduced into the path of rays in order to exclude the influence of diffused infra-red radiation.

very satisfactorily with the results obtained in our previous researches.

It is well known that the reflecting-power of metals is subject to very rapid changes in the ultra-violet and visible spectrum. That is not the case in the infra-red; for this spectral region the curves of fig. 2 show a very regular form

Fig. 2.

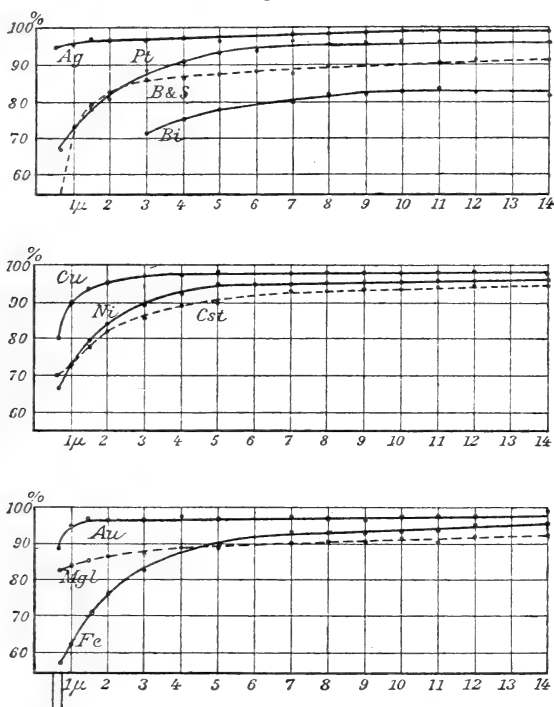

Cst. stands for Constantan, *Mgl.* for Magnalium, *B. & S.* for Brandes and Schünemann's alloy. The curves for Patent Nickel M and P lie very close to that of Constantan. The visible spectrum (from $\lambda=0.45 \mu$ to $\lambda=0.7 \mu$) is marked by the two small vertical lines at the left-hand corner of the curves.

for all the metals and alloys. In every case the curve rises asymptotically to $R=100$ per cent. On comparing the reflecting-powers of different metals with each other in the region of greater wave-lengths, we find that—relative to their reflecting-power—the metals always take the same order of succession. This law is still more obvious when we consider the intensity entering the metals ($100-R$) instead of the reflecting-power (R). Although $(100-R)$ diminishes continually with the increasing wave-length, it does so in the same

proportion for all the metals, so that it is of no consequence at what part of this spectral region the comparison is made.

Table II. contains the values of $100 - R$ at $\lambda = 4 \mu$, 8μ , and 12μ for all the pure metals examined and for five alloys, the electric conductivity of which was accurately known. The numbers given for $(100 - R)$ are always the average values obtained for the different modifications of the same material. The only results we have herefrom excluded are those obtained by aid of the mirrors produced by cathodic dissipation. Their reflecting-power was found to be a little smaller than that of the other mirrors. For silver, this difference is scarcely perceptible; for gold it amounts to 1 per cent., for platinum to 2-3 per cent. We cannot decide whether these differences are due to a deviating molecular structure of the dissipated layers, or whether they are caused by a very slight oxidation of the metals.

In addition to the value $(100 - R)$, Table II.* contains the electric conductivity κ †, its square root, and finally the product $(100 - R) \cdot \sqrt{\kappa}$ for $\lambda = 4, 8$, and 12μ . It is evident that this product has approximately the same value with all the metals for $\lambda = 12 \mu$; *i. e.* the intensities entering the metals are—in the region of long waves—in inverse proportion to the square root of the electrical conductivity,

$$(100 - R)\sqrt{\kappa} = \text{const.} \quad (1)$$

But also for $\lambda = 8 \mu$, and even for $\lambda = 4 \mu$, this equation is approximately verified. At $\lambda = 4 \mu$ the products $(100 - R) \cdot \sqrt{\kappa}$ vary with an average deviation of 21 per cent. from the number $C_4 = 19.4$. At $\lambda = 8 \mu$ the average value of the products is $C_8 = 13.0$; the average deviation is 14.5 per cent. At $\lambda = 12 \mu$, lastly, the mean value is $C_{12} = 11.0$, and the mean deviation is not more than 9.6 per cent.

The values registered in Table II. for bismuth are bracketed, and not considered in the calculation of the average values of C . The first reason is, because they do not possess the exactness of the other numbers. This is accounted for by the deficiency of the curvature and polish of our bismuth mirrors. The cutting and polishing of cast bismuth is very difficult, because of the crystalline structure of this material and the irregular consistency of its surface. The mirror of cast bismuth could therefore only serve for the investigation of the change of the reflecting-power with increasing wavelength; the absolute values had to be determined with the aid of mirrors made by cathodic dissipation. Although these

* R is given in per cents. of the incident radiation.

† W. Jäger and H. Diesselhorst, *Wissenschaftliche Abhandlungen der Physikal. Techn. Reichanstalt*, iii. p. 269 (1900).

TABLE II.

| Metals. | Conductivity, κ_{18} . | $\sqrt{\kappa_{18}}$. | $\lambda = 4\mu.$ | | $\lambda = 8\mu.$ | | $\lambda = 12\mu.$ | |
|---|-------------------------------|------------------------|-------------------|--|-------------------|--|--------------------|---|
| | | | (100-R). | $C_1 = \frac{100-R}{\sqrt{\kappa_{18}}}$ | (100-R). | $C_2 = \frac{100-R}{\sqrt{\kappa_{18}}}$ | (100-R). | $C_{12} = \frac{100-R}{\sqrt{\kappa_{18}}}$ |
| Silver | 61.4 | 7.85 | 1.9 | 14.9 | 1.25 | 9.8 | 1.15 | 9.0 |
| Copper | 57.2 | 7.56 | 2.7 | 20.6 | 1.4 | 10.6 | 1.6 | 12.1 |
| Gold | 41.3 | 6.43 | 3.4 | 21.9 | 2.7 | 17.4 | 2.15 | 13.8 |
| Platinum | 9.24 | 3.04 | 8.5 | 25.8 | 4.6 | 14.0 | 3.5 | 10.6 |
| Nickel | 8.5 | 2.92 | 8.2 | 23.9 | 4.65 | 13.6 | 4.1 | 12.0 |
| Steel | 5.02 | 2.24 | 12.2 | 27.3 | 7.0 | 15.7 | 4.9 | 11.0 |
| Bismuth..... | 0.84 | 0.916 | (24.8) | (22.7) | (18.5) | (16.9) | (17.8) | (16.3) |
| Patent Nickel P | 3.81 | 1.95 | 7.9 | 15.4 | 7.5 | 14.6 | 5.7 | 11.1 |
| Patent Nickel M | 2.94 | 1.71 | 8.6 | 14.8 | 6.5 | 11.1 | 7.0 | 12.0 |
| Constantan | 2.04 | 1.43 | 11.7 | 16.7 | 7.3 | 10.6 | 6.0 | 8.6 |
| Rosse's Alloy | 2.07 | 1.44 | 11.5 | 16.6 | 9.0 | 13.0 | 7.1 | 10.2 |
| Brandes and Schumann's Alloy ... | 1.48 | 1.22 | 12.9 | 15.7 | 10.2 | 12.3 | 9.1 | 11.1 |
| Mean value of C_1 for $\lambda=4, 8,$ and $12\mu,$ obs. | — | — | — | $C_1=19.4$ | — | $C_2=13.0$ | — | $C_{12}=11.0$ |
| Mean deviation δ of the single products from C_1 | — | — | — | $\delta_1=21.0\%$ | — | $\delta_2=14.5\%$ | — | $\delta_{12}=9.6\%$ |
| Theoretical value of C_1' , $C_1' = \frac{36.5}{\sqrt{\lambda}}$ | — | — | — | $C_1'=18.25$ | — | $C_2'=12.90$ | — | $C_{12}'=10.54$ |

had a good spherical shape, they were neither quite free from oxidation nor were they thick enough, so that they necessarily gave too small a reflecting-power. But the want of exactness of the values obtained for bismuth is not the only reason why we excluded them from our calculations. Bismuth follows the law given above in no respect, as will be proven by our further experiments.

Comparison with the Theory.

Maxwell's original theory, which (as has been mentioned) does not consider the molecules and their vibration, leads to this simple expression for the reflecting-power *

$$R = 100 - \frac{200}{\sqrt{\Lambda\tau}},$$

* Cf. P. Drude, 'Physik des Aethers,' p. 574, Formula (66), 1894; and E. Cohn, 'Das electromagnetische Feld,' p. 444 (1900); also M. Planck, *Sitzungsber. d. k. Akad. d. Wissensch. zu Berlin*, p. 278 (1903). Prof. Planck arrives at the equation (2) in this way:—

If a plane linear polarized light-wave propagates in a metal which does not possess any dielectric qualities and absorbs the vibrations only by ordinary galvanic conduction, this process is represented by the Maxwell-Hertz equations

$$\begin{aligned} \frac{\partial E}{\partial t} &= c \frac{\partial H}{\partial x} - 4\pi\Lambda E, \\ \frac{\partial H}{\partial t} &= c \frac{\partial E}{\partial x}. \end{aligned}$$

Herein E and H mean the intensity of the electric and magnetic field, c the velocity of light in the vacuum, and Λ the galvanic conductivity of the metal in absolute electrostatic measure. From these equations we obtain

$$\frac{\partial^2 E}{\partial t^2} = c^2 \frac{\partial^2 E}{\partial x^2} - 4\pi\Lambda \frac{\partial E}{\partial t}.$$

This equation is satisfied by the expression

$$E = A \cdot e^{n(it - \frac{v}{c}x)},$$

if the further condition is fulfilled

$$ni(1+p^2) + 4\pi\Lambda = 0;$$

wherein n means the number of vibrations in 2π seconds and

$$p = g + iv,$$

v is the ratio between the wave-length in vacuum and that in the metal; g means the coefficient of extinction, defined by the law, that the intensity of a ray proceeding in the metal is reduced to $e^{-4\pi g}$ of its initial intensity after having passed over a distance as long as one wave-length in vacuum.

By substituting the value of p , and by separating the real and imaginary terms, we obtain

$$-2gvn + 4\pi\Lambda = 0$$

and

$$1 + g^2 - v^2 = 0.$$

or for the entering intensity

$$(100 - R) = \frac{200}{\sqrt{\Lambda\tau}} \dots \dots \dots (2)$$

Herein Λ means the electric conductivity of the metal in absolute electrostatic measure and τ the period of oscillation in seconds. The formulæ are only valid for sufficiently large Λ , which make the product $\Lambda\tau$ very large compared with unity, a condition always fulfilled with sufficient approximation here. When introducing into equation (2) the wavelength λ measured in μ , in place of the period of vibration,

Besides, if we introduce τ , the period of the vibration in seconds

$$\tau = \frac{2\pi}{n},$$

we have

$$\nu^2 = \frac{1}{2}(\sqrt{4\Lambda^2\tau^2 + 1} + 1)$$

and

$$g^2 = \frac{1}{2}(\sqrt{4\Lambda^2\tau^2 + 1} - 1).$$

These two equations characterize the whole optical behaviour of the metal.

For normal incidence the reflecting-power R_1 of the metal surface bordering on the vacuum is expressed—as is well known—by the formula

$$R_1 = \frac{(\nu - 1)^2 + g^2}{(\nu + 1)^2 + g^2},$$

the intensity of the incident radiation being equal to unity; and, after substituting our values of ν and g ,

$$R_1 = \frac{\sqrt{4\Lambda^2\tau^2 + 1} + 1 - \sqrt{2(\sqrt{4\Lambda^2\tau^2 + 1} + 1)}}{\sqrt{4\Lambda^2\tau^2 + 1} + 1 + \sqrt{2(\sqrt{4\Lambda^2\tau^2 + 1} + 1)}}.$$

For sufficiently long waves, *i. e.* for sufficiently large values of τ , the unit may be neglected as compared with $4\Lambda^2\tau^2$, and we obtain, in first approximation,

$$g = \nu = \sqrt{\Lambda\tau}$$

and
$$R_1 = 1 - \frac{2}{\sqrt{\Lambda\tau}}.$$

Finally, if we express the reflecting-power in percent. of the incident radiation, as has been done in this paper, we arrive at

$$R = 100 - \frac{200}{\sqrt{\Lambda\tau}},$$

which is identical with our equation (2).

and the value κ^* of Table II. in place of the conductivity Λ given in electrostatic measure, we obtain

$$(100 - R) = \frac{36.5}{\sqrt{\kappa\lambda}} \dots \dots \dots (3)$$

or

$$(100 - R) \cdot \sqrt{\kappa} = \frac{36.5}{\sqrt{\lambda}} = C\lambda \dots \dots \dots (4)$$

Therefore the relation between the reflecting-power and the conductivity of metals, experimentally given in the region of long waves, corresponds perfectly with the demands of Maxwell's theory. The value of the constant $C_\lambda = (100 - R) \sqrt{\kappa}$ is, according to Table II.,

- 19.4 at $\lambda = 4\mu$
- 13.0 ,, $\lambda = 8\mu$
- 11.0 ,, $\lambda = 12\mu$

and the corresponding theoretical values of the constant C_λ , computed from the Maxwell equation (4), are

- 18.25 for 4μ
- 12.90 ,, 8μ
- 10.54 ,, 12μ

They show a better agreement with the values given above than might have been expected or even hoped for.

TABLE III.

| Metals. | (100 - R) for $\lambda = 12\mu$. | |
|---|-----------------------------------|-----------|
| | Observed. | Computed. |
| Silver..... | 1.15 | 1.3 |
| Copper | 1.6 | 1.4 |
| Gold | 2.1 | 1.6 |
| Platinum | 3.5 | 3.5 |
| Nickel | 4.1 | 3.6 |
| Steel | 4.9 | 4.7 |
| Bismuth | (17.8) | 11.5 |
| Patent Nickel P | 5.7 | 5.4 |
| Patent Nickel M | 7.0 | 6.2 |
| Constantan | 6.0 | 7.4 |
| Rosse's Alloy..... | 7.1 | 7.3 |
| Brandes and Schünemann's } Alloy | 9.1 | 8.6 |

* κ is the reciprocal value of the resistance of a conductor one metre long and of one square millimetre cross-section in ohms.

A similar proof for the agreement of experiment and theory results from Table III. Here the values of $(100-R)$ determined experimentally are placed beside those computed from formula (4), and solely dependent on the electric conductivity and the wave-length $\lambda=12\mu$.

Excepting the values given for bismuth, the agreement is good, particularly when we consider that the numbers calculated from formula (4) are absolute values and do not contain any arbitrary coefficient.

II.

The Emissive Power of the Metals for $\lambda=25.5\mu$.

The formula (4), found by our experiments relating to reflexion and deduced from Maxwell's theory, was now to be examined for rays of much greater wave-length; for instance, for the "residual rays"* of fluorite. For the accomplishment of this purpose, the investigation of $(100-R)$ by aid of the reflecting-power is not an advantageous method, as was mentioned above. For all metals the reflecting-power R approaches 100 per cent. asymptotically with increasing wave-lengths, and the difficulty of experimentally determining $(100-R)$ increases accordingly †.

But if—instead of the reflecting-power—the emission-power is made the object of research, the course of investigation becomes much easier. In that case the metal surfaces require merely to possess the same temperature for the comparison of their radiating-power with that of an absolutely

* By "residual rays" we mean the still surviving part of the whole radiation of a source of heat after having undergone several reflexions on surfaces of a certain substance; for instance, of rock-salt, sylvine, or fluorite. In the infra-red these substances possess rather sharply-limited bands of metallic absorption, at which the reflecting-power attains very high values (sometimes more than 90 per cent.), whilst for other wave-lengths it is small. The residual rays of sylvine attain their maximum energy at a wave-length of about 61μ , those of rock-salt at 51μ . The residual rays of fluorite are less homogeneous than those of rock-salt and sylvine. They begin at 22μ , attain a sharply-defined maximum at $\lambda=24\mu$, and decrease first rapidly, then slower towards the longer waves. On account of the unsymmetrical form of the energy-curve the mean wave-length of the assemblage of rays—after three reflexions from fluorite—amounts to 25.5μ (H. Rubens, Wied. *Ann.* lxi. p. 576, 1899). For further particulars on residual rays, *vide* H. Rubens & E. F. Nichols, Wied. *Ann.* lx. p. 418 (1897); and H. Rubens & E. Aschkinass, Wied. *Ann.* lxxv. p. 241 (1898).

† Cf. H. Rubens & E. F. Nichols, Wied. *Ann.* lx. p. 418 (1897).

black body for long waves, a process causing no difficulty when sufficient energy is at hand*.

Fig. 3 shows the arrangement of apparatus which served

Fig. 3.

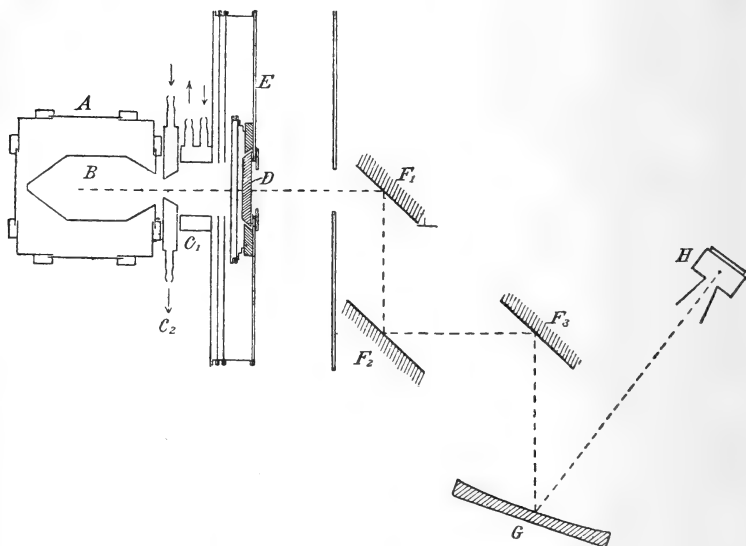

for these experiments. A is a copper box that could be turned at will: its four sides contained round openings provided with screws, into which the metal plates † (radiating

* A similar method has been tried by O. Wiedeburg (*Wied. Ann.* lxxvi. p. 92, 1898) to compare the total emission of different metals with that of silver. The results which he obtained support those already published by H. Rubens (*Wied. Ann.* xxxvii. p. 249, 1889), that the good conductors for heat and electricity show a higher reflecting-power than the other metals. But, in view of our measurements of the reflecting-power, Wiedeburg's numerical data of the emission-power seemed so improbable, that we repeated his experiments for several metals. Doubtless his experiments are influenced in a very high degree by diffused foreign radiation, a fact which is proved by the following table. Here we give the emission of four metals at 100° , silver being the unit, in the first place according to O. Wiedeburg's, and secondly according to our own observations. The latter cannot possibly be influenced by any foreign radiation.

Total emission at 100° .

| Observers. | Silver. | Platinum. | Steel. | Manganin. |
|------------------------|---------|-----------|--------|-----------|
| O. Wiedeburg | 1.00 | 1.23 | 1.31 | 1.32 |
| Hagen and Rubens. . . | 1.00 | 4.65 | 6.66 | 8.00 |

† It is a special advantage of this method that the metal plates used need only to be pure and well polished, but not plane.

surface 50 mms. diameter) or the "black body" could be introduced. The "black body" was a copper cylinder B of 47 mms. internal diameter, furnished with conic ends, and coated with lampblack on the inside. Its aperture at the outer end was 22 mms. in diameter. Boiling aniline served as heating liquid, which was in continual contact with the metal sheets to be heated. The heating was done electrically by means of a spiral of constantan ribbon inside the copper case. The temperature was generally regulated to 170°. The heating-box was put in front of a metal diaphragm C₁ or C₂, cooled by flowing water. Behind this diaphragm stood a screen D, kept at the temperature of the room. When this screen was lifted, the radiation to be measured underwent successive reflexions from three or four suitably set-up surfaces of fluorite F₁ F₂ F₃, and by means of a large concave silver mirror G were finally brought to focus on a Rubens thermopile H. By this process the "residual rays" of fluorite, corresponding to a wave-length of about 26 μ , were separated from the total emission.

A direct comparison between the radiations of the metal surfaces and that of the "black body" being impossible on account of the different sizes of the respective radiating surfaces, we had recourse to the following method. A thin copper disk, covered on one side with a very thin glass plate (5 cms. diameter) was introduced into one of the openings of the heating case. We then determined the ratio between the radiation of the "black body" and that of the glass plate by aid of the smaller diaphragm C₁ (14 mms. diameter). The value we found was 1.29. In our further experiments, the radiation of the different metal surfaces was compared with that of the glass plate. In all these cases we could make use of the large diaphragm C₁ (diameter 32 mms.). The numbers thus obtained had only to be divided by 1.29 in order to give the emission-power of the different metals, compared with that of the black body. These results are given in Table IV.

Mercury was the only metal that required another treatment. We therefore changed our arrangement in the following manner. Instead of the copper cube, a cup filled with mercury, heated to 100°, was placed opposite and a little below the diaphragm C₁. In front of the diaphragm and above the mercury surface, there was adjusted a polished plate of fluorite. By means of this fluorite mirror the heat-rays emanating from the mercury were horizontally reflected through the diaphragm. In order to compare this radiation with that of the black body, we covered the surface of the

TABLE IV.

| 1 | 2 | 3 | 4 | 5 | 6 | 7 | 8 |
|-----------------------|------------------------------------|---|--------------------------------------|-----------------------|---|-----------|--|
| Metals. | Conductivity at 18°, κ_{18} | Temperature-coefficient of resistance $10^3 \cdot \alpha$. | Conductivity at 170°, κ_{170} | $\sqrt{\kappa_{170}}$ | Emission-power for $\lambda = 25.5\mu$ and 170°. Computed by Formula (3). | Observed. | Product C $(100-R)\sqrt{\kappa_{170}}$ taken from columns 5 and 7. |
| Silver | 61.4 | 4.0 | 39.2 | 6.26 | 1.15 | 1.13 | 7.07 |
| Copper | 51.8 | 4.2 | 32.5 | 5.70 | 1.27 | 1.17 | 6.67 |
| Gold | 41.3 | 3.68 | 27.2 | 5.21 | 1.39 | 1.56 | 8.10 |
| Aluminium | 31.6 | 3.90 | 20.4 | 4.52 | 1.60 | 1.97 | 8.91 |
| Zinc | 15.83 | 3.94 | 10.2 | 3.19 | 2.27 | 2.27 | 7.24 |
| Cadmium | 13.13 | 4.25 | 8.40 | 2.86 | 2.53 | 2.55 | 7.29 |
| Platinum | 9.24 | 3.84 | 5.98 | 2.44 | 2.96 | 2.82 | Mean 7.33 |
| Nickel | 8.50 | 4.38 | 5.26 | 2.29 | 3.16 | 3.20 | 6.88 |
| Tin | 8.28 | 4.65 | 5.01 | 2.24 | 3.23 | 3.27 | 7.32 |
| Steel | 5.02 | 3.69 | 3.30 | 1.81 | 3.99 | 3.66 | 6.62 |
| Mercury | 1.044 | 0.92 | 0.916† | 0.957 | 7.55 | 7.66 | 7.33 |
| Bismuth | 0.84 | 4.54 | 0.513 | 0.716 | 10.09 | (25.6) | (18.3) |
| "Rotguss" * | 7.89 | 0.8 | 7.05 | 2.65 | 2.73 | 2.70 | 7.16 |
| Manganin | 2.38 | 0.03 | 2.37 | 1.54 | 4.69 | 4.63 | Mean 7.41 |
| Constantan | 2.04 | 0.01 | 2.04 | 1.43 | 5.05 | 5.20 | 7.43 |
| Patent Nickel P | 3.81 | 0.25 | 3.69 | 1.92 | 3.77 | 4.05 | 7.77 |
| Patent Nickel M | 2.94 | 0.20 | 2.86 | 1.69 | 4.28 | 4.45 | 7.53 |

† At 100°.

* "Rotguss" contains 85.7 Cu + 7.2 Zn + 6.1 Sn.

mercury with a very thin sheet of the same glass as had always served in our previous comparisons.

No diffuse radiation of small wave-lengths could possibly have influenced our results. This was proved by the insertion of a plate of fluorite or rock-salt, 1 cm. thick, that perfectly absorbed the whole radiation*.

Column 6 of Table IV. contains the values of $(100-R)$ computed by means of formula 3, for $\lambda=25.5\mu$, whereas column 7 shows the values of $(100-R)$ obtained by observation. The agreement between the two columns is so good as to form a sufficient proof for the correctness of the law

$$(100-R)\sqrt{\kappa}=\text{const.},$$

found by our previous experiments on shorter waves. The same is shown by column 8, containing the product $(100-R)\sqrt{\kappa}$, taken from our observations †. The average value of this constant amounts to 7.33 for the pure metals, to 7.41 for the alloys; the theoretical value, calculated by means of formula 4, is $36.5/\sqrt{25.5}=7.23$. Aluminium alone gives a rather considerable deviation, and bismuth furnishes a complete exception to our law ‡. But we can scarcely wonder at this, since bismuth forms an exception in various other ways §.

Dependence of the Emission-Power of Metals on Temperature.

The good agreement of the emission-power $(100-R)$ obtained from our experiments with that computed from Maxwell's theory, justifies the conclusion that the variation of the conductivity of metals with temperature requires a

* Cf. H. Rubens and A. Trowbridge, Wied. Ann. lx. p. 724 (1897).

† Of the numbers in column 8 those for Zn, Cd, Ni, Sn, Hg, manganin, and constantan agree particularly well with the theoretical value 7.23. This is most probably owing to the fact that for these metals the conductivity was very accurately known. It was certainly the case with the above-named three alloys and with mercury, which, in comparison with the solid metals, can easily be obtained very pure. As to gold, we must remark that the conductivity of this metal at 18° is only 41.3 if the gold is *absolutely* pure. If it contains even $\frac{1}{1000}$ of iron or copper, its conductivity is reduced to 24.7, and the temperature-coefficient sinks from 3.68 to 2.03.

‡ Both the aluminium and the bismuth surfaces could not be kept free from oxide for a considerable length of time. With aluminium we are nearly sure that the observed deviation is due to this fact. But with bismuth the greater part of the deviation is apparently due to other causes.

§ Cf. P. Lenard, Wied. Ann. xxxix. p. 626 (1890).

corresponding change of the emission-power for long waves*. Otherwise the constant $C = (100 - R)\sqrt{\kappa_{170}}$ for pure metals would have been found 25 per cent. smaller than that for the alloys with exceedingly small temperature-coefficients, and could agree only by a mere chance with the theoretical value 7.23.

Our experiments on emission therefore enable us to calculate the change of resistance with the temperature, since the emission increases with the square root of the resistance. The following experiments have been undertaken in order to obtain a still stronger proof of this relation. A hollow case † of platinum-foil, heated by an electric current, was placed in front of the diaphragm C_1 . The temperature of the case could be measured by aid of a thermo-element LeChatelier, the welded end of which was placed inside. For higher temperatures (800° – 1560°) the hollow case was replaced by a single platinum strip, cut from the same piece of platinum-foil of which the case had been made. The temperature of the incandescent platinum strip was determined by means of the optical pyrometer, lately described by Holborn and Kurlbaum ‡. The "black temperature" observed herewith was transformed into Celsius degrees, according to the table of correction given by these authors. For the experiments with higher temperatures (above 800°) we were obliged to increase the number of the reflecting fluorite surfaces from 3 to 4; otherwise the "Reststrahlen" would not have been sufficiently pure. The still remaining small impurities, caused by radiation of short wave-length, were determined by the interposition of a plate of rock-salt, and the amount deducted. For the high temperatures we used the diaphragm C_2 , only 14 mms. wide, thus permitting of direct comparison between the radiation of the hot platinum-foil and that of our "black body" at 170° Celsius. But when the intensity of radiation of the black body for "residual rays" of fluorite is known for one temperature, it is easily determined for every other §; since the intensity of the observed "residual rays"—for

* In the visible spectrum the change of the optical constants of the metals with the temperature is exceedingly small, as is shown by the observations of Messrs. R. Sissingh (*Arch. Néerland.* xx. p. 172, 1886), P. Drude (*Wied. Ann.* xxxix. p. 538, 1890), B. Zeemann (*Commun. of the Lab. of Physics at the Univers. of Leyden*, No. 20, 1895), and A. Pflüger (*Wied. Ann.* lviii. p. 493, 1896).

† A hollow case of this kind was first employed by Messrs. O. Lummer and F. Kurlbaum, *Verhandl. d. Phys. Gesellsch. zu Berlin*, xvii. p. 106 (1898).

‡ L. Holborn & F. Kurlbaum, *Ann. d. Phys.* x. p. 225 (1903).

§ H. Rubens & F. Kurlbaum, *Ann. d. Phys.* iv. p. 649 (1901).

temperatures above 20° C.—is proportional to the difference of temperature between the black body and the thermopile. (This fact has also been expressed by M. Planck's law of radiation*.) Consequently the radiation of the hot platinum-foil could always be referred to the radiation of an equally heated black body; that is tantamount to a direct determination of the value (100-R). The continuity of these experiments at *high* temperature with those at *lower* was secured by observing the galvanometer-deflexions with both arrangements of apparatus between 700° and 800° Celsius. By forming the ratio of two deflexions, corresponding to the two arrangements, the temperature of the source of radiation being the same, one obtains a reduction factor by which the deflexions observed at higher temperatures must be multiplied so that the results may become at once comparable with those observed at low temperatures. Table V. shows the results of our observations, after this calculation.

TABLE V.

| Temperature of the Platinum-foil t in Celsius degrees. | Observed Deflexion. | Remarks. |
|--|---------------------|--|
| 1556 | 200 | } Strip of platinum in front of the narrow diaphragm C ₂ . 4 surfaces of fluorite. Measurement of temperature with the optical pyrometer. The black body gave at 170° a (reduced) deflexion of 196 mms. |
| 1438 | 177 | |
| 1320 | 153 | |
| 1214 | 130 | |
| 1100 | 109.5 | |
| 976 | 89.7 | |
| 858 | 74.6 | |
| 762 | 63.6 | |
| 804 | 68.0 | |
| 695 | 53.2 | |
| 614 | 45.4 | |
| 493 | 32.2 | |
| 404 | 24.4 | |
| 323 | 18.2 | |
| 261 | 12.4 | |
| 169 | 6.5 | |

By the ordinary electrical method of measurement, the specific conductivity of our platinum-foil was determined, $\kappa_0 = 6.5$ (specific resistance = 0.154), the temperature-coefficient amounting to $\alpha = 0.0024$, between 18° and 65°. These numbers show that the platinum employed was not pure; but for our purpose this was of no importance.

A very good agreement between the computed and the

* M. Planck, *Ann. d. Phys.* iv. p. 553 (1901).

observed emission of platinum-foil is obtained by means of the equation

$$w_t = w_0(1 + \alpha t + \beta t^2), \quad \dots \quad (5)$$

in which

$$w_0 = 0.154$$

$$\alpha = 0.0024$$

$$\beta = 0.0000033.$$

This is proved in Table VI., the first column of which contains a few temperatures in Celsius degrees. The second

TABLE VI.

| 1 | 2 | 3 | 4 | 5 | 6 | 7 |
|--|---|-----------------------------------|--|--|--------------------------------|---|
| Temp. t in Celsius degrees. | Specific resist- ance $w_t = w_0(1 + \alpha t + \beta t^2)$ | Conduc- tivity κ_t . | Emission-power computed $(100 - R) = \frac{7.23}{\sqrt{\kappa_t}}$ | Emission of the black body γ_t . | Observed deflexion a . | Emission power $(100 - R)$ observed. |
| 170 | 0.233 | 4.31 | 3.49 | 196 | 6.6 | 3.36 |
| 220 | 0.260 | 3.84 | 3.68 | 261 | 9.6 | 3.68 |
| 300 | 0.312 | 3.22 | 4.04 | 366 | 15.7 | 4.29 |
| 600 | 0.559 | 1.79 | 5.40 | 758 | 42.8 | 5.65 |
| 900 | 0.900 | 1.11 | 6.86 | 1150 | 79.6 | 6.93 |
| 1200 | 1.33 | 0.751 | 8.34 | 1540 | 128.0 | 8.32 |
| 1500 | 1.85 | 0.540 | 9.84 | 1940 | 189.5 | 9.78 |

shows the respective specific resistances, computed from formula 5; the third, the corresponding conductivity κ_t , and the fourth the emission-power of the employed platinum, computed from the equation

$$100 - R = \frac{7.23}{\sqrt{\kappa_t}}.$$

The fifth column gives the radiation γ_t of the "black body," as derived, for the respective temperature, from the radiation of the black body at 170° by linear extrapolation. The sixth column contains the observed galvanometer-deflexions a for the emission of the heated platinum-foil. These numbers were derived from Table V. by interpolation. By forming the ratio of the corresponding numbers of columns 6 and 5, and by multiplying it by 100, one obtains the "observed" emission-powers, given in column 7. The agreement of these numbers with the "computed" ones of column 4 is the more

conclusive because they are absolute values, not containing any arbitrary factor.

The coefficients ν_0 and α of equation (5) are directly obtained by ordinary electrical measurement. In the region of lower temperatures (down to about 250°) where the influence of the square term βt^2 is only small, the *observed* emission values agree perfectly with those *computed* from the electrical conductivity. But in order to obtain a similar agreement between observed and computed emission values in the region of high temperatures, the adoption of a square term with the coefficient β is absolutely necessary.

The coefficient $\beta = 0.0000033$ has a positive sign in equation (5), thereby indicating a more rapid increase of the resistance at high temperatures. This is in contradiction with measurements of Messrs. Benoît*, L. Callendar†, and Holborn & Wien‡, who have all observed a slower change of resistance at high temperatures, which corresponds to a small negative value of β .

Accordingly, we must suppose that the increase of resistance at higher temperatures—as computed from our observations on emission—is only apparent, and that other facts influence the change of the emission of platinum in that region. Particularly a change (roughening) of the surfaces at high temperatures is not improbable, and that would account for a remarkable rising of the emissive power. Lastly, it is not improbable that the observed deviations are connected with perhaps the insufficient homogeneity of the “residual rays.”

Summary of the obtained Results.

1. The reflecting-power of the investigated metals from $\lambda = 0.65\mu$ to $\lambda = 14\mu$ is given in Table I.; the emission-power for $\lambda = 25.5\mu$ and 170° C. is to be found in Table IV.

2. For long waves the intensity entering into the metals (100—R) is in inverse proportion to the square root of the electrical conductivity κ , and to the square root of λ , the wave-length of the incident radiation. This law, derivable from Maxwell's theory, holds good the more strictly, the longer the waves are. This is proved in Table VII., which gives the observed and computed values of the constant

$$C_\lambda = (100 - R) \sqrt{\kappa} \quad \text{and} \quad C_\lambda = \frac{36.5}{\sqrt{\lambda}}$$

for four different wave-lengths of the infra-red spectrum

* R. Benoît, *Compt. Rend.* lxxvi. p. 342 (1873).

† L. Callendar, *Phil. Mag.* [5] xlvii. p. 191 (1899).

‡ L. Holborn & W. Wien, *Wied. Ann.* lvi. p. 360 (1895).

TABLE VII.

| λ . | $C_\lambda = (100 - R) \sqrt{\kappa}$ observed. | Mean deviation of the single pro- ducts from the average value. | $C_\lambda = \frac{36.5}{\sqrt{\lambda}}$ computed. |
|-------------|--|--|--|
| 4 μ | 19.4 | 21.0 per cent. | 18.25 |
| 8 | 13.0 | 14.5 | 12.90 |
| 12 | 11.0 | 9.6 | 10.54 |
| 25.5 | 7.36 | 4.9 | 7.23 |

Moreover, this table contains the average deviation (expressed in percents) which the single products $(100 - R) \sqrt{\kappa}$ of the different metals show, as compared with the average value given in the second column,

3. According to Maxwell's theory the quantity $100 - R$ undergoes a change corresponding to the change of resistance which the metals show with increasing temperature. This has been verified by our experiments.

These two facts (2 and 3) form a new important proof of Maxwell's theory, and that in a sphere, in which hitherto no connexion between the observed facts and the theoretically computed laws had been recognized.

4. From our observations the conclusion must be drawn, that the periods of vibration of the molecules scarcely influence the optical behaviour of metals in the region of long waves.

5. No influence of the magnetic qualities of iron and nickel* on their behaviour towards these rays could be detected. Had such influence made itself manifest relative to these metals, the value $(100 - R)$ ought to have been considerably larger than it appears when computed from the conductivity for constant electric current† by aid of formula (4).

6. In the region of long waves we are, therefore, justified in assuming the agreement of the other optical constants with the values computed from Maxwell's theory. This

* This fact can be explained by Prof. Drude's theory of magnetism (Cf. *Verhandl. d. Deutschen Physikal. Gesellsch.* v. pp. 143 & 148, 1903).

† In the experiments of Mr. V. Bjerknes (*Wied. Ann.* xlvii. p. 69, 1892) the influence of magnetism very strongly manifests itself for vibrations of about 10^8 per second. This is partly due to his method of observation, which greatly differs from ours.

theory leads—as previously shown by Mr. Drude*—to the equation †

$$g = \nu = 5.48 \sqrt{\kappa\lambda}, \quad (6)$$

where g is the coefficient of extinction, ν the index of refraction of the metals for normal incidence. This equation, which is only approximately correct, shows that the index of refraction and the extinction coefficient are numerically equal for long waves.

Besides

$$R = 100\left(1 - \frac{2}{\nu}\right) = 100\left(1 - \frac{2}{g}\right),$$

therefore

$$g = \nu = \frac{200}{100 - R}.$$

Consequently both values are definable from the emission-power alone.

7. A further consequence, resulting from the agreement of our researches with the electromagnetic theory of light, deserves special mention. Besides abstract numbers, the theoretical computation of the constant C contains only the velocity of light and the wave-length, both of which can be determined by experiments on radiation. By dividing the emission-power of a metal for the wave-length λ (the emission of the black body being rated at 100) by the constant C , and by squaring the ratio, we obtain the electrical resistance in ohms of a wire of the respective metal (1 m. length and 1 mm.² cross-section). So it is now possible to undertake absolute determinations of electrical resistances solely by the aid of measurements on radiation.

* P. Drude, *Physik des Aethers*, p. 575 formula (68), 1894; and M. Planck, *l. c.* In the footnote p. 166 of this paper we have given Planck's enunciation of formula (6).

† It follows from formula (6) that the extinction-coefficient (g) increases, for long waves, with the square-root of the wave-length. The absorption-coefficient $a_0 = \frac{4\pi g}{\lambda}$, which characterizes the real absorption of the metals, consequently diminishes proportionally to the square-root of the wave-length. Nevertheless the absorption of the metals remains very considerable, even for waves longer than one metre. A metal layer of about $\frac{1}{100}$ mm. thickness must necessarily absorb the whole infra-red spectrum. It is therefore impossible that infra-red rays of great wave-length pass through layers of aluminium half a millimetre thick, and it follows that M. Blondlot's so-called "Rayons N" cannot possibly be infra-red rays.

XVII. *On the Relation of the Electric Charges transported by Cathode and Canal Rays to the Exciting Current.* By FRANZ LEININGER*.

SINCE the time when W. Wien, in the course of his research on electric discharge in rarefied gases †, showed that a splitting off of positive and negative particles took place at both electrodes, the anode as well as the cathode, the particles being projected in opposite directions by the two electrodes, it has been a problem of outstanding interest to determine the dependence of these showers of positive and negative particles, the so-called canal and cathode rays, on the intensity of the corresponding exciting current. Stimulated by a problem propounded in this sense by the philosophical faculty of Würzburg University, I have endeavoured to offer some small contributions towards it.

The phenomena of cathode and canal rays take place most readily at perforated cathodes. Hence the main attention was to be given to the occurrences at the cathode, the anode being always earthed. I set myself the problem of determining the ratio of the electric convection-currents due to the cathode and canal rays to the exciting current. At first the currents corresponding to the rays and the main current were measured by means of galvanometers of the Kohlrausch and Wiedemann types, and later by moving-coil galvanometers of the Siemens & Halske and Hartmann & Braun patterns.

In making the arrangements, I asked myself whether it might be a matter of indifference whether the galvanometer was connected on the high- or low-potential side of the tube. In order to clear up this point, I made use of a differentially-connected Wiedemann's reflecting galvanometer for the current measurement. If, then, the currents flowing towards and leaving the tube were the same, no deflexion could be obtained on the galvanometer so connected. Now I found the following characteristic result in the case of all the tubes employed:—

1. The galvanometer gave *no deflexion* when the collecting electrode AE was in connexion with the neighbouring discharge electrode.
2. The galvanometer gave *a deflexion* when the collecting electrode AE was connected to earth.

This result I interpreted as follows:—The current supplies the electric charges for the cathode and canal rays, and that

* Communicated by the Author.

† W. Wien, *Wied. Ann.* lxx. pp. 440-452 (1899).

part of it which is used up in producing the rays falling on AE is diverted when the collecting electrode is connected to earth. The decrease of current must therefore be proportional to the quantity of diverted cathode or canal rays. This inference was confirmed by the experiments, and furnished me with a second though difficult check method, for determining the relation of the convection-currents represented by the cathode and canal rays to the exciting current. Thereby I was put in possession of two mutually independent modes of investigation.

Description of Apparatus.

Altogether five different forms of discharge-tube were used. Here I shall, however, describe only two of the most important. For one series of experiments I used the tube shown in fig. 1. This was quite symmetrical with respect to both electrodes. These latter consisted of two exactly equal brass tubes 3 cms. long, with a piece of gauze, forming a "net" electrode, soldered to each. The distance between the pieces of gauze was 6.5 cms. The three component glass portions of the tube fitted tightly into the brass tubes just mentioned, and were cemented to them by means of sealing-wax. The collecting electrode AE was provided with the following arrangement for displacing it without altering the vacuum. The collector was attached by means of two thick copper wires to a nut which moved between two guides, the latter being soldered to a springy ring of brass which pressed tightly against the glass walls of the tube. By means of a long screw passing through the nut and cemented to an easily rotating stopper, the electrode could be displaced to and fro by simply turning the stopper.

The experiments with other gases required a different form of tube, in which all bodies capable of giving off gases, such as greased stoppers, cemented joints, &c. had to be avoided. For this reason in such experiments the tube shown in fig. 2 was mostly used. It consisted of a glass tube about 35 cms. long and having an internal diameter of 3.2 cms. It was used in a vertical position, the upper end being closed and the lower one continued into a barometer-tube. The two perfectly symmetrical net-electrodes consisted of "nets of the second kind." It should be explained that in order to determine the effect of different nets, two kinds were used. The small-meshed nets, or nets of the first kind, were such that their wires covered 64.67 per cent. of the total area; the openings were square. In the wide-meshed nets, or nets of the second kind, the wires covered 48.37 per cent. of the

Fig. 1.

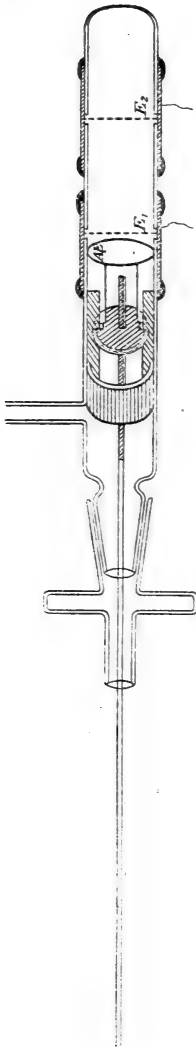

Fig. 2.



The arrangement for displacing the collecting electrode is shown in perspective, the rest in cross-section.

area. From this I concluded that nets of the first kind absorbed 35.33 per cent. of the rays, and those of the second kind 51.6 per cent. In the tube, fig. 2, the net-electrodes were soldered to springy brass rings, 8 mms. wide, which pressed firmly against the walls of the tube. The distance apart of the rings amounted to 2.9 cms. By means of these tubes, the values given in Tables I. to VIII. were obtained. The collecting electrode consisted of a disk of aluminium which fitted the tube exactly. The thick iron connecting wire passed through the mercury of the barometer. Thus the collecting electrode could be pushed up and down inside the barometer-tube, and moved up to a distance of 11 cms. away from the nearest net-electrode. The amount of this displacement could be read off on a scale running along the tube. In the case of the electrode nearest the collecting electrode, it was necessary to observe that the ring fitted the wall of the tube closely, so as to leave no open space; as otherwise with a high vacuum a secondary discharge passed to the collecting electrode, causing considerable disturbance and rendering observations impossible.

For exhausting the tubes, a Töpler mercury hand-pump was used, and in order to save labour arrangements were made for a preliminary exhaustion down to a pressure of a few millimetres by means of a water-jet pump.

For measuring the pressure inside the tube, a McLeod precision-gauge by Rich. Müller Uri of Brunswick was at first used. As, however, this gave incorrect results with high pressures, and as I wished to avoid the use of all greased stoppers in the experiments with other gases, instead of the pressures the potential-differences were noted in this case.

These were measured by a Thomson electrostatic voltmeter by Siemens & Halske, which enabled the potential-differences to be read off directly on a scale extending up to 15,000 volts.

For the measurement of the current as well as of the rate at which electric charges were picked up by the collecting electrode, a Kohlrausch galvanometer was at first employed. Later on, the current was measured with a Wiedemann's galvanometer, and the radiated electricity with the Kohlrausch instrument.

The Kohlrausch galvanometer had a resistance of 952.8 ohms, and a sensitiveness of 8.7×10^{-9} ampere per scale-division with a scale distance of 2 metres.

The front coil of the Wiedemann's galvanometer had a resistance of 3354.7 ohms, and the back coil a resistance of 2933 ohms.

When coupled differentially, the two coils of the Wiedemann galvanometer were adjusted to equality of resistance, and insulated from one another by two thick plates of glass. If only the front coil was in use, the sensitiveness of the instrument with a scale distance of 2 metres was 3.2×10^{-7} ampere per scale-division.

In order to screen the galvanometers as much as possible from the magnetic effect of the motor, they were set up as far as possible from it.

In the later experiments, moving-coil galvanometers were used, by Siemens & Halske and Hartmann & Braun, of Frankfort-on-the-Main. The last-named instrument had a resistance of 660 ohms, and to this was added a further resistance of 5000 ohms. In addition to this, a shunt of 50 ohms was used across the galvanometer. This instrument served for the current measurement, and had a sensitiveness of 9.3×10^{-10} , which was fairly constant, with a scale distance of 1.65 m.

For the measurement of the radiation, a Siemens & Halske moving-coil galvanometer was employed, having a resistance of 10,000 ohms; a shunt of at first 200, and later 100 ohms was used. The sensitiveness of this instrument was very constant, and amounted to 5.1×10^{-10} ampere with a scale distance of 1.8 m. The source of electrical energy was a self-exciting Wimshurst influence-machine having two movable ebonite plates 40 cms. in diameter, and driven by a small electro-motor supplied with current at 12 volts. It gave a spark-length of 14 cms., and when directly short-circuited through the galvanometer, a current whose average value was about 2.14×10^{-5} ampere.

The tube and the influence-machine were set up in an earth-connected zinc box. All the leads to the galvanometers and tube were of bare copper wire stretched on sealing-wax supports. Only the voltmeter wire was, on account of its high potential, embedded in a thick glass tube filled with paraffin wax.

METHOD I.

Account of Experiments.

I first determined the ratio of the convection-currents due to cathode or canal rays to the main current, by measuring in succession the current received by the collecting electrode from the charged particles of the rays, and then, by applying a shunt of 50 ohms, a fraction of the main current. In measuring this ratio, the electrode next to the collecting electrode was made an anode in the case of cathode rays, and

a cathode in the case of canal rays. Hence it was only necessary to reverse the current before it entered the tube in order to have one or other of the rays impinging on the collecting electrode. The reversal was best accomplished by the aid of a large paraffin-wax four-cup commutator.

The convection-current of the rays was measured by connecting the collecting electrode to earth through the galvanometer. The neighbouring net-electrode was also always connected to earth. In measuring the main current, the galvanometer was at first placed in front of the tube across a shunt which was connected between the influence-machine and the tube; later it was connected beyond the tube (across the earth-connexion), as with the first arrangement the leakage was excessive. The collecting electrode AE was in all the experiments at a distance of 3.8 cms. from the neighbouring net-electrode. Thus the ratio of the ray convection-current to the main current could easily be determined by the direct measurement of each. In these experiments the tube shown in fig. 1 was exclusively used. Since, however, on account of the unsteadiness of the current it is important to take the two readings almost simultaneously, I employed two galvanometers, Wiedemann's, whose front coil without any shunt was used directly for the measurement of the main current, and which in this case had a sensitiveness of 3.2×10^{-7} ampere; and Kohlrausch's, for measuring the ray current. In the following tables are given the values of the ratios of the cathode and canal ray currents to the main current, in the form of percentages of the main current, the figures being rounded off with regard to the second decimal place. It must also be mentioned that the results in the case of high potentials can lay no claim to any great degree of accuracy, as with a very high vacuum point-discharges and other disturbances occur.

METHOD II.

Determination of Ratio by Differential Method.

Before this method was actually applied, certain preliminary experiments were carried out.

By means of a secondary battery current the galvanometer was adjusted so that with equal currents no deflexion was obtained. Then by weakening the current in one branch the direction of deflexion was noted when, *e. g.*, the negative current (corresponding to cathode rays) was weakened. The experiments then confirmed my surmise that by the withdrawal of the cathode rays the negative current was weakened,

for the direction of deflexion of the galvanometer was the same as in the preliminary experiments. Similarly was confirmed the assumption regarding the weakening of the positive current by the withdrawal of the canal rays.

If the current is led through the front coil, the tube, and thence through the back coil to earth, a deflexion α is obtained, which may be regarded as proportional to the difference of the currents; thus a first equation is obtained

$$\alpha = C(J - J'),$$

in which C is a constant, J the main current, and J' the main current as weakened by the loss of the rays. If the back coil be now entirely cut out, a deflexion α' proportional to the main current is obtained, and hence a second equation

$$\alpha' = C.J.$$

Dividing, we get

$$\frac{\alpha}{\alpha'} = \frac{J - J'}{J},$$

which gives the ratio of the cathode or canal rays to the exciting current. The sensitiveness of the Wiedemann galvanometer with the front coil alone in use was 3.2×10^{-7} ampere.

In the following Tables I.-IV. are given, besides the results of Method I., those of Method II., and they show very good agreement with them. Of course, Method II. is not so convenient to use nor so general as Method I., and is mainly troublesome on account of the great length of high-potential conductor leading to the distant galvanometer. For this reason I discarded it in the later investigations; its main object was to confirm my theory regarding the formation of the cathode and canal rays as parts of the exciting current.

Absorption of Rays by the Gas.

A not inconsiderable effect on the results is produced by the absorption of the rays in the gas-filled space. Unfortunately, I found it impossible to establish a definite law of absorption. Nevertheless, I was able to represent the variation of absorption by means of curves. It may also be mentioned that the absorption experiments were never undertaken directly after exhaustion, but after some time, when the gaseous contents had to some extent reached a steady state. The experiments in question were carried out by placing the collecting electrode AE at varying distances from the neighbouring net-electrode, and observing the values for the rays at the lowest possible pressures. It was also necessary to see

TABLE I.
Cathode rays in rarefied air. First kind of net-electrodes.

| Pressure in mm. | Potential in volts. | Value of ratio $100 \times \frac{\text{cathode rays}}{\text{current}}$, by Method I. | Value of ratio $100 \times \frac{\text{cathode rays}}{\text{current}}$, by Method II. | Value of ratio $\frac{\text{rays}}{\text{current}} \times 100$, corrected for absorption by net, Method I. | Values by Method II. corrected for absorption by net. |
|-----------------------|---------------------------|---|--|--|--|
| 0.10 | 700 | 5.5-5.7 | | 15.34-16.1 | |
| | 800 | 6.9-7 | | 18.3-19.7 | |
| | 900 | 7.4 | | 20 | |
| 0.07 | 1000 | 7.8-8 | | 21.8-22.6 | |
| | 1200 | 8.7-9.1 | | 24.5-25.5 | |
| | 1400 | 9.5-9.6 | 9.63 | 26.6-27 | 26.9 |
| | 1800 | | 11-11.5 | | 30.8-32 |
| 0.06 | 2000 | 12-12.5 | 11.9-12.6 | 33.6-35 | 33.4-35.3 |
| | 2000-2400 | | 12.5-13.1 | | 35-36.7 |
| 0.05 | 2200 | 12.7-12.8 | 12.7-12.9 | 35.7-36 | 36-36.5 |
| 0.043 | 2400 | 13.1 | | 36.6 | |
| 0.04 | 2600 | 13.1-13.2 | | 36.8-37 | |
| 0.035 | 2800 | 13.3-13.7 | | 37.3-38.4 | |
| 0.03 | 3000-3400 | 13.4-14.6 | | 37.6-40.8 | |
| | 3600 | | 13.9-14.5 | | 39-40.5 |
| | 4000 | 14.3-15.3 | | 40.1-42.8 | |
| 0.02 | 5000 | 14.4 | 15.6-15.7 | 43.3 | 42.2-43.9 |
| 0.01 | 6000 | 16-16.3 | 16.4-16.6 | 44.8-45.7 | 45.8-46.6 |
| | 7000 | 15.9-16.8 | 17.14 | 44.5-47.1 | 47.9 |
| | 7000-7500 | | 18.2-18.5 | | 50.9-51.8 |

TABLE II.
Canal rays in rarefied air. First kind of net-electrodes.

| Pressure in mm. | Potential in volts. | Value of canal rays current, by Method I. | Value of canal rays current, by Method II. | Values by Method I. corrected for absorption by net. | Values by Method II. corrected for absorption by net. |
|-----------------------|---------------------------|--|---|---|--|
| 0.10 | 500 | 2.9-3.2 | | 7.3 - 8.9 | |
| | 900 | 3.6-4.9 | | 12.99-13.7 | 17.6 -19.12 |
| 0.07 | 1000 | 4.7-5.2 | | 13.3 -14.7 | 19.8 -20.5 |
| | 1400 | | 6.3 -6.8 | | |
| 0.065 | 1800 | | 7.08-7.3 | | |
| 0.06 | 1800-2000 | 7.3-8.4 | | { 20.8, 21.6 } | |
| 0.06 | 2000 | | 7.8-8.2 | | 21.8 -23.1 |
| | 2200 | | 9.1-9.4 | | 25.45-26.3 |
| 0.045 | 2000-2400 | | 8.6-9.9 | | 24 -27.7 |
| 0.04 | 2600 | 8.4-8.8 | | 23.6 -24.7 | |
| 0.03 | 3000 | 9.5-10.1 | 9.4-10.0 | 23.7 -28.2 | 26.5 -27.9 |
| | 3400 | 10.3-10.7 | 10.2-10.6 | 28.7 -30 | |
| | 3200-3400 | 10.1-10.8 | | 28.2 -30.24 | 28.5 -29.2 |
| | 3600 | 10.9-11.4 | | 30.6 -31.8 | |
| | 3800 | 11.2-11.4 | | 31.36-32.2 | |
| 0.025 | 4000 | 11.7-12.08 | | 32.87-33.8 | 34.3 -35.6 |
| 0.02 | 5200 | 12.3-12.6 | 12.3-12.7 | 34.4 -35.2 | |
| | 7200 | 13.5 | | 37.8 | |
| | 7500 | | 13 -14.5 | | 36.5 -40.6 |

that the current of the influence-machine remained constant during each series of observations. In the accompanying curves (figs. 3 to 8) the ray currents are plotted as ordinates, and the distances of the collecting electrode as abscissæ. From the curves it will be seen that the canal rays are absorbed much more strongly than the cathode rays, especially if we consider the fact that the cathode rays have really to traverse a longer path, since, as is generally accepted nowadays*, the canal rays arise in the first layer of the cathode light, while the cathode rays have to traverse the entire space between cathode and anode, and this in our

TABLE III.

Cathode rays in rarefied air. Second kind of net-electrodes.

| Potential in volts. | Value of cathode rays, $100 \times \frac{\text{cathode rays}}{\text{current}}$ | Value of cathode rays, $100 \times \frac{\text{cathode rays}}{\text{current}}$, corrected for absorption by net. | Value of cathode rays, $100 \times \frac{\text{cathode rays}}{\text{current}}$, corrected for absorption by net and reflexion. |
|---------------------|--|---|---|
| about 500 | 5.8 | 11.3 | 15.7 |
| 1000 | 12.2 | 23.6 | 32.7 |
| 1600 | 16.1—17.4 | 31.4—33.5 | 44.2—46.5 |
| 1800 | 16.6—17.9 | 32.1—34.5 | 44.6—48 |
| 2000 | 18.3—18.9 | 35.3—36.4 | 49 —50.6 |
| 2200 | 18.8—19.1 | 36.3—36.9 | 50.5—51.3 |
| 2400—2600 | 19.3—20 | 37.2—38.6 | 51.7—53.6 |
| 2800 | 20 —21 | 38.7—40.5 | 53.8—56.3 |
| 3000—3400 | 21.2—21.6 | 40.9—41.7 | 56.8—57.9 |
| 3600 | 21.6—22.4 | 41.7—43.2 | 57.9—60 |
| 4000 | 22.2—23 | 42.8—44.4 | 59.5—61.6 |
| 5000 | 23.4—25.1 | 45.1—48.4 | 62.7—67.3 |
| 5100 | 25.4 | 49.1 | 68.2 |
| 5500 | 26.6—28.2 | 51.2—54.5 | 71.1—75.7 |
| 6000 | 29 —31.05 | 56 —59.9 | 77.8—83.2 |
| 7000 | 31.6—31.8 | 60.9—61.3 | 84.7—85.2 |

case amounts to 6.5 cms. The absorption diminishes with decreasing pressure for both kinds of rays, but more rapidly for cathode than for canal rays. To this widely different degree of absorption of the rays is perhaps to be ascribed the difference in their values, especially as with low pressures, for which the absorption of the canal rays is no longer so marked, the values for the canal rays approach those for the cathode rays. On the other hand, under high pressures, when the absorption of the cathode rays becomes of more

* E. Goldstein, Wied. Ann. lxiv. p. 38 (1898).

190 F. Leininger: *Relation of Electric Charges transported*
 importance, the values for the canal rays exceed those for
 cathode rays, since then the longer path of the latter is of
 greater importance.

TABLE IV.

Canal rays in rarefied air. Second kind of net-electrodes.

| Potential in volts. | Value of $100 \times$ canal rays current. | Values corrected for absorption by net. |
|---------------------|--|---|
| 600 | 9.7—10.2 | 14.9 —19.7 |
| 1200 | 22 —22.8 | 42.4 —44 |
| 1600 | 23 —24.4 | 44.4 —47.1 |
| 1800 | 23.8—24.7 | 45.9 —47.7 |
| 2000 | 24.6—25.8 | 47.5 —49.8 |
| 2200 | 25.2—26.5 | 48.6 —51.1 |
| 2400 | 26.7—27 | 51.55—52.1 |
| 3000 | 27 —29.5 | 52.1 —56.9 |
| 4000 | 28.7—29.9 | 55.4 —57.7 |
| 4700 | 29.9—31.5 | 57.7 —60.8 |
| 5000 | 30.7—31.8 | 59.2 —61.4 |
| 6000 | 31.4—32.6 | 60.6 —62.9 |
| 7000 | 32.7—34 | 63.1 —65.6 |

Sources of Error.

A considerable source of error in carrying out the experiments arose in the gradually developing inconstancy of the vacuum; since the current, as mentioned above, in passing through it freed the occluded gases from the metal portions of the tube. A complete suppression of this evolution of gas could not be attained. It was sought to diminish its effect on the results by always sending the current through the tube for a very short time only while taking the actual observations, and for the remainder of the time keeping the influence-machine short-circuited.

With the form of tube shown in fig. 2, this evolution of occluded gases could more readily be reduced to a minimum. For this reason the tube was used in making the first measurements, strong discharges being maintained through it by means of an induction-coil for several hours while the exhaustion was going on.

Experiments with Pure Gases.

In order to arrive at some relation connecting the ratio of the rays to the current with the nature of the gaseous contents, the former experiments were repeated with tubes

which had been washed out with pure oxygen and hydrogen. In these experiments it was above all things necessary to avoid greased and cemented joints. For this reason, all the joints with the air-pump &c. were blown. A difficulty which arose in connexion with several tubes and which could no longer be overcome was the following one. When the tubes are used a good deal, a metallic deposit gradually appears on the glass wall of the tube between the two electrodes. This deposit then, on reaching a certain thickness, forms a conducting coating, which at first is of importance only with high, but subsequently also with quite low potentials. This action even went so far that the tube no longer showed any luminous discharge, although the galvanometer, which was inserted beyond the tube, showed that the full current of the influence-machine passed through it. And yet the deposit was only faintly visible. I succeeded in getting rid of this deposit in the entirely new tube (fig. 2). As electrodes only nets of the second kind were used.

It was very inconvenient to measure the current, as was done formerly, before it passed through the tube, as this necessitated a considerable length of high-potential conductor going to the distant galvanometer. The leakage was in this case so great that after a time the influence-machine was no longer capable of sending a discharge through the tube. I therefore altered the arrangement, measuring the current after it had passed through the tube, and only using a short well insulated voltmeter-lead on the other side of the tube.

According to the foregoing experiments, the current leaving the tube is diminished by the observed amount corresponding to the rays. The total discharge current is therefore obtained by adding the ray current to the measured current leaving the tube. If, therefore, E denotes the ray current and J the current leaving the tube, the ratio of the rays to the current is given by

$$\frac{E}{J + E}$$

The moving coil galvanometer by Hartmann and Braun was used for measuring the current, that by Siemens and Halske for measuring the rays.

A favourable condition for this method of observation was the possibility of carrying out in direct succession measurements at various pressures. Since, namely, for the purpose of evolving the gas &c. a fairly large system of tubes had been fused on to the air-pump, the effect of a single lift became only slowly perceptible. Thus the values of the current and

the rays could be observed with gradually decreasing pressure and increasing potential of discharge.

For the evolution of the gases—oxygen and hydrogen—in a state of purity, the arrangement employed by Prof. W. Wien, and described in his second and third memoirs on the electrical discharge in rarefied gases, was adopted*.

Observations.

The results embodied in the following Tables were all obtained by the aid of the tube shown in fig. 2 (p. 182).

The distance of the collecting from the neighbouring electrode was 4 cms. in all the experiments, partly in order to render the values comparable with former observations, partly in order to avoid the disturbances which were in general called into play by a nearer approach of the collector.

TABLE V.

Cathode rays in oxygen. Second kind of net-electrodes.

| Potential in volts. | Value of cathode rays $100 \times \frac{\text{cathode rays}}{\text{current}}$ | Value of cathode rays, $100 \times \frac{\text{cathode rays}}{\text{current}}$ corrected for absorption by net. | Value of cathode rays, $100 \times \frac{\text{cathode rays}}{\text{current}}$ corrected for absorption by net and reflexion. |
|---------------------------|---|---|--|
| 300—500 | 2.3—2.6 | 4.3—5.05 | 6.05—7 |
| 700 | 4.5 | 8.7 | 12 |
| 1000 | 6.7 | 12.9 | 17.9 |
| 1200 | 8.5 | 16.4 | 22.8 |
| 1400 | 10.5 | 20.2 | 28.14 |
| 1600 | 13 | 25.1 | 34.8 |
| 1800 | 15.2 | 29.3 | 40.7 |
| 2000 | 17.5 | 33.7 | 46.9 |
| 2400 | 20.5 | 39.5 | 54.9 |
| 2800 | 24.5 | 47.3 | 65.7 |
| 3000 | 26.7 | 51.5 | 71.6 |
| 3400 | 28.5 | 55 | 76.5 |
| 4000 | 29.4 | 56.7 | 78.8 |
| 5000 | 31 | 59.8 | 83.1 |
| 6200 | 32 | 61.7 | 85.8 |
| 7000 | 33.1 | 63.9 | 88.7 |
| 7800 | 34.6 | 66.8 | 92.7 |

The values of the canal and cathode rays in hydrogen and oxygen, corrected for the absorption by the net and the reflexion of the cathode rays by the collector (28 per cent. in the case of aluminium), are given in Tables V. to VIII. It may, however, be pointed out at once that the correction

* W. Wien, *Ann. d. Phys.* v. p. 423 (1901); viii. p. 256 (1902)?

TABLE VI.

Canal rays in oxygen. Second kind of net-electrodes.

| Potential in volts. | $100 \times \frac{\text{canal rays}}{\text{current}}$ | Value of $100 = \frac{\text{canal rays}}{\text{current}}$, corrected for absorption by net. |
|---------------------|---|--|
| 300—500 | 7.6—7.8 | 14.6—15 |
| 700 | 8.9 | 17.3 |
| 1000 | 11.2 | 21.6 |
| 1300 | 13.5 | 26 |
| 1500 | 15.2 | 29.3 |
| 1800 | 17.4 | 33.6 |
| 2000 | 18.4 | 35.5 |
| 2500 | 19.6 | 37.8 |
| 3000 | 19.8 | 38.2 |
| 3600 | 20.7 | 39.9 |
| 4000 | 27 | 52.1 |
| 4400 | 27.9 | 53.8 |
| 5000—5100 | 28.6—28.7 | 55.2—55.4 |
| 6000 | 30.1 | 58.1 |
| 7200 | 31.7 | 61.2 |
| 7800 | 33.1 | 63.9 |

TABLE VII.

Cathode rays in hydrogen. Second kind of net-electrodes.

| Potential in volts. | $100 \times \frac{\text{cathode rays}}{\text{current}}$ | Value of $100 \times \frac{\text{cathode rays}}{\text{current}}$, corrected for absorption by net. | Value of $100 \times \frac{\text{cathode rays}}{\text{current}}$, corrected for absorption by net and reflexion. |
|---------------------|---|---|---|
| 400—500 | 2.5—3.6 | 4.8—6.9 | 6.7—9.6 |
| 700 | 5.4 | 10.5 | 14.6 |
| 1000 | 7.5 | 14.5 | 20.1 |
| 1200 | 8.5 | 16.45 | 22.8 |
| 1400 | 16.6 | 29.45 | 28.4 |
| 1600 | 13.8 | 26.6 | 37 |
| 1800 | 16.1 | 31.05 | 43.16 |
| 2000 | 18.2—18.8 | 35.1—36.3 | 48.8—50.4 |
| 2400 | 23.5 | 45.3 | 63 |
| 2800 | 26.6 | 51.35 | 71.3 |
| 3000 | 28.9 | 55.8 | 77.5 |
| 3400 | 32.8 | 63.3 | 87.9 |
| 4000—4100 | 37 | 71.4 | 99.18 |
| 5000 | 39.8 | 76.8 | 106.6 |
| 6400 | 40.6 | 78.35 | 108.8 |
| 7400 | 40.7 | 78.55 | 109.1 |

194 F. Leininger: *Relation of Electric Charges transported*
 for reflexion yields impossibly large values, so that it appears
 to me unlikely that so great a proportion should undergo
 reflexion.

It is also possible that a considerable proportion of the
 reflected particles again reaches the collector by conduction.

TABLE VIII.

Canal rays in hydrogen. Second kind of net-electrodes.

| Potential in volts. | Value of $100 \times \frac{\text{canal rays}}{\text{current}}$ | Value of $100 \times \frac{\text{canal rays}}{\text{current}}$, corrected for absorption by net. |
|---------------------|---|--|
| 300—500 | 12.2—13.9 | 23.35—25.26 |
| 1000 | 16.8 | 32.4 |
| 1200 | 18.5 | 35.7 |
| 1400 | 19.2 | 37 |
| 1600 | 20.6 | 39.7 |
| 1800 | 22—22.1 | 42.4—42.6 |
| 2000 | 23.7 | 45.7 |
| 2400 | 25 | 48.25 |
| 3000 | 26.8 | 51.7 |
| 3600 | 28.4 | 54.8 |
| 4000 | 30.3 | 58.5 |
| 4800 | 32.2 | 62.1 |
| 5400 | 33.1 | 63.9 |
| 6000 | 34.3 | 66.2 |
| 7000 | 35.6 | 68.7 |

Beyond 7200—8000 volts the discharge became irregular
 and disruptive, the influence-machine being obviously no
 longer capable of producing a steady discharge. For this
 reason the last values are mostly unreliable.

On comparing the values obtained, we notice in the first
 place a somewhat striking absorption of the rays in oxygen,
 especially of the canal rays—an effect easily accounted for
 by the constitution of the particles in the latter case. It is
 further remarkable that at the higher pressures the percentage
 absorption of canal rays should be much higher than that of
 cathode rays, considering that the latter have to traverse a
 greater distance, and hence at the higher pressures their
 absorption becomes more important.

From the above experiments with different gases filling the
 tube it follows that the absorption of the rays by the gas
 plays an important part. I therefore tried to devise some

experiments bearing on this point. This was accomplished by means of the movable collecting electrode in the barometer-tube, and the quantity of the incident rays observed for

Fig. 3.

Absorption curves of canal rays in air.

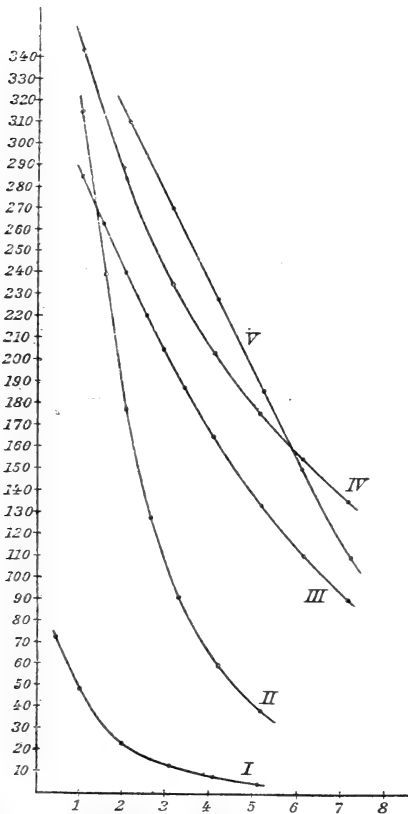

- Curve I. Pressure of 0.24 mm. of mercury.
 " II. Pressure of 0.15 mm. of mercury.
 " III. } Pressures of 0.10-0.09 mm. of mercury.
 } Potentials of 500-1000 volts.
 " IV. } Pressures of 0.06 and 0.09 mm. of mercury.
 } Potentials of 1000-2000 volts.
 " V. } Pressures of 0.01 and 0.06 mm. of mercury.
 } Potentials of 2000-5000 volts.

various distances and various pressures. In figs. 3-8 the absorption of the rays in air, oxygen, and hydrogen is

graphically represented. The curves show that the absorption is strongest in oxygen; but even in this case it is greatly reduced at low pressures. It is further evident from the curves that the canal rays are in general absorbed more strongly than the cathode rays.

Considering the tabulated results from a perfectly general point of view, one of the most striking features is the improbably large percentage value of the rays when the corrections are taken into account, as, *e. g.*, in Tables III.-VIII., at very low pressures. If my original supposition be adopted, according to which the cathode and canal rays form a portion

Fig. 4.

Absorption curves of canal rays in oxygen.

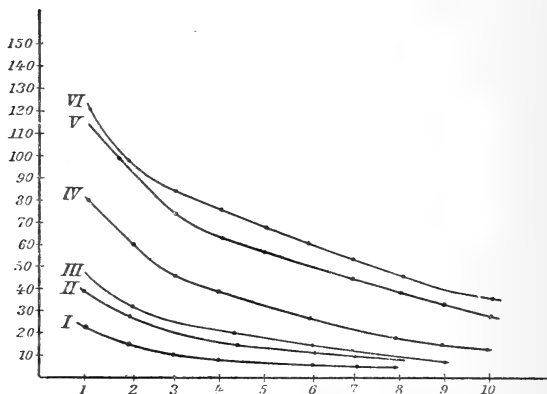

Curve I. Potentials of 600-700 volts.

| | | | |
|--------|---|-----------|---|
| " II. | " | 900-1100 | " |
| " III. | " | 1150-1300 | " |
| " IV. | " | 2000-2400 | " |
| " V. | " | 4000-4500 | " |
| " VI. | " | 5800-7000 | " |

of the current, then the value of 50 per cent. could not be exceeded. The results could only be explained by supposing that the correction-coefficients are not as large as I have assumed them. It is possible that the reflexion-coefficient of the cathode rays alters with their velocity, and that under the circumstances of my experiments other values should have been adopted. For this reason, the values corrected for absorption and those corrected for absorption and reflexion of the rays are given separately. Besides, very little can be said as to what becomes of the reflected rays. In any case I feel

justified in concluding from my experiments that it is impossible to have so large a percentage of the rays reflected. As regards absorption by the net, I believe my observations show that the absorption is not directly proportional to the smallness of the meshes, but is related to it in some other way. It is desirable to have further experiments on this point. Further, it is not inconceivable that at low pressures secondary effects develop on which the above excessive values of the rays depend.

Fig. 5.

Absorption curves of canal rays in hydrogen.

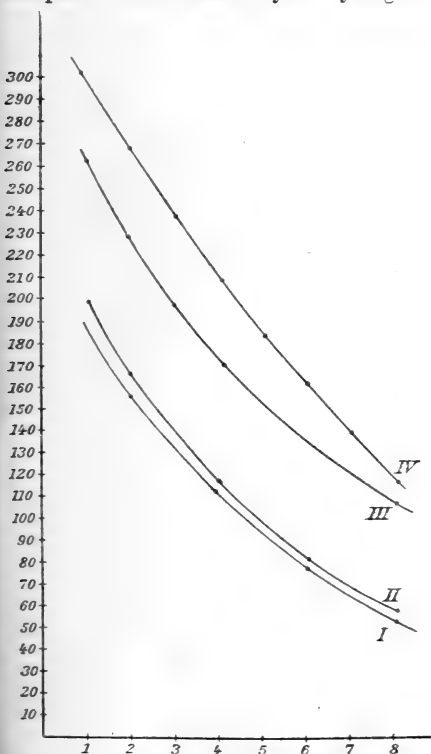

Curve I. Potentials of 1300- 1400 volts.
 " II. " 1400- 1500 "
 " III. " 3000- 4000 "
 " IV. " 6000-10000 "

Fig. 6.

Absorption curves of cathode rays in air.

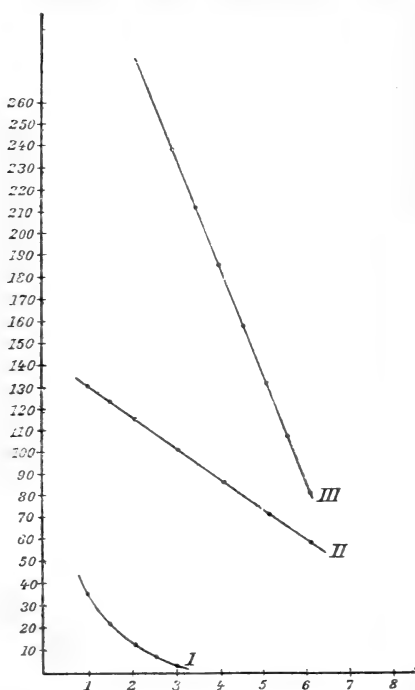

Curve I. } Pressure of 0.2 mm. Hg.
 } Potential of about 200-300 volts.
 " II. } Pressure of 0.065 mm. Hg.
 } Potential of about 2000 volts.
 " III. } Pressure of 0.03 mm. Hg.
 } Potential of about 3000-3400 volts.

Fig. 7.

Absorption curves of cathode rays in oxygen.

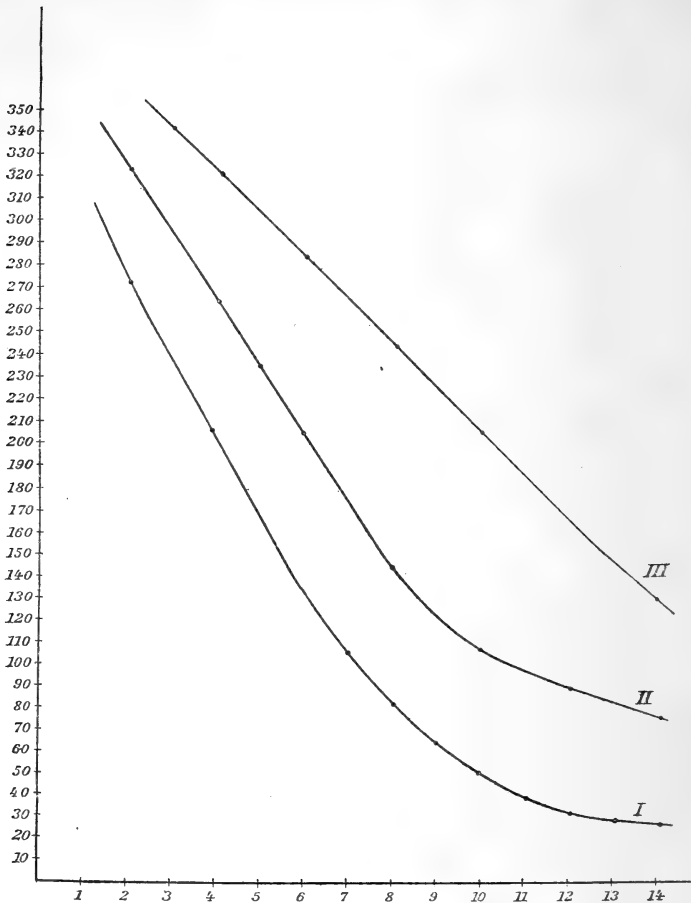
*Summary of Results.*

The determination of the ratio of the cathode and canal rays to the exciting current has in the first place shown that the electric quantities transported by the rays form a direct fraction of the exciting current. This fraction greatly increases with increasing exhaustion, and from its high value at very low pressures, when all the necessary corrections have been applied, we must conclude that at such pressures the current is used up almost entirely in the production of cathode and canal rays. Correcting the observed ray convection currents for absorption by the wire gauze leads to the improbable result that the sum of the rates of transfer of

electric quantities by the canal and cathode rays exceeds the exciting current. The net therefore appears to absorb less than corresponds to the area occupied by the meshes.

Fig. 8.

Absorption curves of cathode rays in hydrogen.

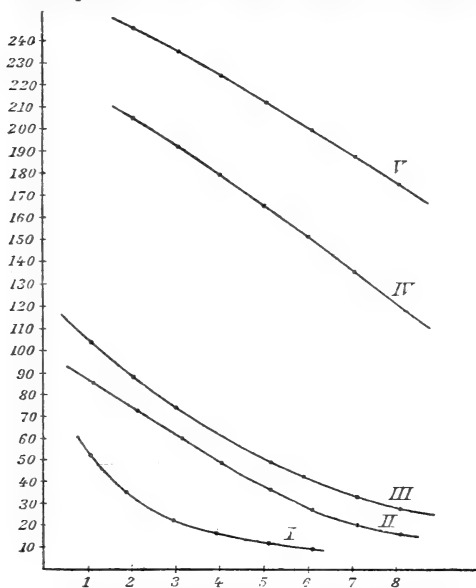

| | | |
|----------|--------------------|------------|
| Curve I. | Potentials of 250- | 500 volts. |
| " II. | " 600- | 1000 " |
| " III. | " 1300- | 1400 " |
| " IV. | " 3000- | 4000 " |
| " V. | " 6000- | 10000 " |

Moreover, it may be concluded that although apparently the values of the cathode and canal rays are somewhat different; yet it seems fairly probable that when absorption &c. are fully considered, these values become equal, so that the production of the cathode and canal rays is nothing else than a splitting up into positive and negative ions, which travel in opposite directions from the electrodes, and derive their charges from the current. The different degrees of absorption are in any case connected with the differences in the velocity and size of the particles forming the cathode and canal rays.

In conclusion, my hearty thanks are due to Prof. Dr. W. Wien for his many-sided suggestions and friendly help, as well as to Prof. Dr. Des Coudres, Privatdozent Dr. W. Sitz, and Dr. Fr. Harms, to whom I am indebted for much advice.

Würzburg, Physical Institute.
June 1903.

XVIII. *On a Novel Instrument for Drawing Parabolas.*
 By KARL PEARSON, *F.R.S., University College, London**.

[Plate XV.]

FOR a number of years I have much desired a really effective instrument for rapidly constructing parabola on the drawing-board. As far as my experience goes existing mechanisms for this purpose are occasionally ingenious, but always ineffectual. Yet in ordinary drawing-office practice the construction of parabolas in both graphical statics and graphical dynamics is an almost daily necessity. One has only to think of the solution of continuous girder problems, of speed-curves from energy-curves, of stability of dams, and a variety of other matters to realize how much energy is wasted in the drawing of these curves which ought to be done rapidly and effectively by aid of a mechanism.

The grant made by the Drapers' Company to my department has placed me in a position to carry out, in a practical form, some of the needs we have long felt for labour-saving mechanisms in our drawing-office, and the following brief description of the new "parabolograph" may be of interest to those who have felt the like want.

The principle made use of in the new mechanism is the fundamental metrical property of the parabola. Let PVP' (Pl. XV. fig. 1) be a parabola, V the vertex, and VX the axis. If P be a point on the parabola $PN^2 = c \times VN$, where PN is the perpendicular on the axis. Draw PFT parallel to the axis. Join VP and take VT perpendicular to VP to meet PFT in T. Drop VF perpendicular on TP. Then clearly $FV^2 = FT \times FP$ since the angle at V is right. It follows, therefore, that $FT = c$ the parameter of the parabola. Hence, if a bar TP slide so as always to remain parallel to the axis, with a definite point F slipping along the tangent FV at the vertex, then a bar TVP, bent at right-angles at V, round which point it pivots, and passing through a fixed point T on FT, will give points on the parabola by its intersection P with the same line.

This simple property was used by my former assistant Mr. H. Payne, now Professor of Engineering in the South African College, to design a parabolograph. This with his consent I forwarded to Herr Coradi, of Zürich, as the man most likely to make a really practical machine, the step from perfect theory to effective practice being, as I know from experience, a rather long one.

The machine as designed by Payne and executed by Coradi is represented in the accompanying fig. 2 (Pl. XV.), which almost explains the method of working. Herr Coradi has introduced

* Communicated by the Author.

a number of modifications and improvements—especially the replacement of slots by wheels running in grooves, which make the mechanism work with the ease and perfection of all that the Zürich workshop turns out. The design remains, however, essentially Payne's. Hence I propose to call it the *Payne-Coradi Parabolograph*.

In practice what we need is to construct a parabola with given vertex and axis passing through two given points symmetrically situated on either side of this axis, *i. e.* we are given V the vertex, VX the axis, and the points A, B of fig. 1. In the actual instrument the lower "east and west" bar gives the tangent at the vertex, the vertex itself is marked by the short vertical stroke seen on the bar*. The upper "east and west" bar serves to carry the vertex pivot, whence we see the rectangular bars corresponding to VT and VP of fig. 1. The point P is the pencil or pen. It is on a carriage constrained to slip both along the VP bar and the "north and south" bar TFP; in each case by three horizontal wheels running in grooves, two on one and one on the other side of the respective bars. The "north and south" bar is attached to a carriage much like that used in the Abakanowitz-Coradi integraph, which rolls along the lower "east and west" bar, *i. e.* the tangent at the vertex. The same system of three horizontal wheels on a vertical swivel clamped to the "north and south" bar fixes the point T.

The working of the instrument is very simple, the lower east and west bar being placed along the known tangent at the vertex, with the vertical stroke on the required axis, the clamp fixing the point T is released, and the pen or pencil brought to the point A. The point T is then clamped, and the required parabola struck at once, by simply pulling the pen or pencil round in the general direction of the curve by the handle provided for that purpose. The curve is traced right through the vertex at one sweep.

Slight improvements in dimensions will be made in future machines, but the present one works excellently, as may be judged from the actual curves on fig. 2. The size of the machine is about 20 × 20 ins., but the "tangent at the vertex," *i. e.* the lower east and west bar, can be brought within a couple of inches of the top of the drawing-board.

The parabola has been a known curve for at least 2000 years, and therefore some excuse may be needed for speaking of it here. I think this is to be found in the fact that, strange as it may seem, this appears to be the first instrument constructed for drawing it accurately and quickly in a manner satisfying the needs of actual drawing-office practice.

* Really this stroke is somewhat behind the true vertex on the axis to allow of the pen or pencil passing right through the vertex.

XIX. *Heating Effect of the Radium Emanation**. By
E. RUTHERFORD, F.R.S., and H. T. BARNES, D.Sc., Pro-
fessors of Physics, McGill University, Montreal †.

P. CURIE and Laborde ‡ first observed the rapid rate of heat emission of radium, and deduced that 1 gram of radium emitted heat at the rate of about 100 gram-calories per hour. In a later paper P. Curie § found that the rate of emission of heat depended upon the age of the radium preparation. The heating effect for freshly prepared radium compound was small at first, but gradually increased to a maximum after a month's interval, and remained constant over a further interval of two months.

The present experiments were undertaken with the view of seeing how the heat emission of radium is connected with its radioactivity. It has been shown by Rutherford and Soddy || that the radiation emitted from a radium compound in a state of radioactive equilibrium may be divided into three parts:—

(1) A non-separable radiation consisting entirely of α rays and constituting about 25 per cent. of the total radiation.

(2) The radiation from the emanation occluded in the radium, also consisting entirely of α rays.

(3) The excited radiation produced by the emanation in the mass of the radium, and consisting of α , β , and γ rays.

(2) and (3) together constitute about 75 per cent. of the total radiation.

Some experiments have been recently made to find how much of the activity of radium is supplied directly by the emanation occluded in it. The saturation-current, between parallel plates, due to a radium preparation spread uniformly over a platinum plate, was determined by means of an electrometer. The platinum plate was then heated rapidly to a temperature sufficient to completely drive off the emanation and the saturation-current due to the radium immediately measured. There was a decrease observed corresponding to 18 per cent. of the total. The gradual decay of the excited activity left behind in the radium after the removal of the emanation is shown graphically in fig. 5, curve A (p. 213).

We may thus conclude that the emanation supplies

* A short account of the preliminary results was published in 'Nature' (Oct. 29, p. 622, 1903). Read before the American Physical Society, St. Louis, Dec. 29, 1903.

† Communicated by the Authors.

‡ *Comptes Rendus*, cxxxvi. p. 673 (1903).

§ *Société de Physique*, 1903.

|| Phil. Mag. April 1903.

18 per cent., the non-separable activity 25 per cent., and the excited activity 57 per cent. of the total activity of radium.

The excited activity produced on bodies has been shown to be due to a deposit of radioactive matter on their surface. The term "excited activity" refers only to the radiations from this active matter. It is convenient to have a definite name for the matter itself. It is suggested that the name "emanation X" be given to it, since the matter which causes excited activity is produced directly from the emanation. This name is given from analogy to the products UrX and ThX , which are produced directly from uranium and thorium respectively. On this nomenclature, the radium produces the emanation at a constant rate, and this in turn is transformed into the emanation X. The matter of emanation X of radium itself undergoes at least three and probably four successive changes. The nature of these changes and their connexion with the radioactivity will be discussed later.

On heating or dissolving a radium compound in an open vessel, the emanation is released and can be entirely removed by a current of air. The emanation X, which is non-volatile, is left behind with the radium, and it at once commences to lose its activity. In the course of a few hours the activity due to it has practically disappeared. The β and γ rays which are produced only by emanation X disappear from the radium at the same time, and there then remains a non-separable activity of radium consisting entirely of α rays.

At the same time that the emanation X, left behind in the radium, is undergoing change, fresh emanation X is being produced by the separated emanation, and at such a rate that the activity at any time due to the emanation X left in the radium, together with that due to the emanation X formed afresh by the emanation, is equal to the original activity of the emanation X stored up in the radium.

Since fresh emanation is being continually produced by the radium and occluded in it, the activity of the radium after falling to its minimum gradually rises again, and in the course of about a month has nearly reached its original constant value.

The experiments which will now be described were undertaken to see if the heat emission of radium varied in the same way as its activity when the emanation was removed. For this purpose, the heating effect of the radium was first determined. The emanation was then removed from it and collected by condensation in a small glass tube, and the distribution of the heating effect between the emanation and emanation X and the radium was determined, and also the

variation with time of the heating effect of both the emanation and the radium from which it was separated.

Description of Apparatus.

As only about 30 milligrams of pure radium bromide were available in the experiments, special methods were devised to measure with accuracy the small heating effects involved. The maximum heat emission from 30 milligrams of radium bromide is not more than 6×10^{-4} gram-calories per second, and it was necessary to measure with certainty a heat emission of at least $\frac{1}{20}$ of this amount.

In the following experiments a simple form of differential air-calorimeter was employed. In fig. 1 is shown a simple

Fig. 1.—Differential Air-Calorimeter.

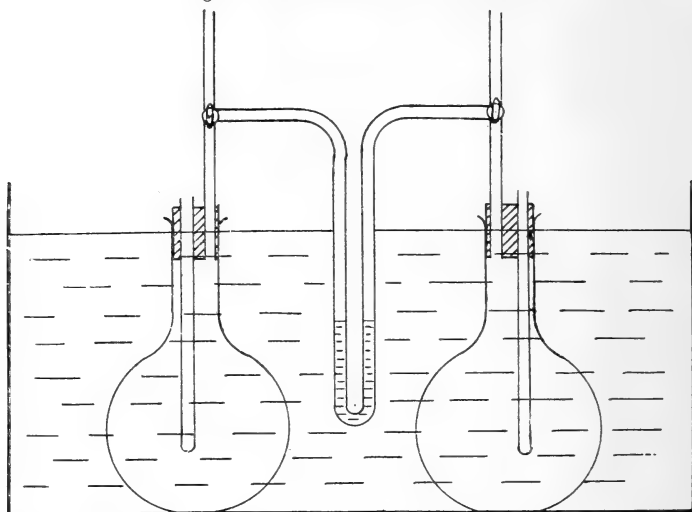

sketch of the apparatus. It consisted of two 1-litre flasks with rubber stoppers through which passed three-way glass cocks, and tubes into which the radium or the emanation-tube could be lowered. The glass cocks connected the air in the flasks either to the outside air or to a manometer-tube which registered the differences in pressure. Some little difficulty was encountered at first in selecting a suitable liquid with sufficient mobility and low vapour-pressure for the manometer-tube. We finally used xylene, which proved in every way satisfactory. The difference in level of the xylene standing in the two arms was observed with a microscope provided with a micrometer eyepiece mounted on a cathetometer-stand. The two flasks were immersed in a

constant-temperature water bath, and remained very steady throughout the work. Readings were taken of the position of the xylene in the manometer-tube with the radium or emanation-tube in one flask, and then again when transferred to the other flask, allowing in each case ample time for the attainment of steady conditions. To calibrate the readings of the micrometer-scale directly in gram-calories per hour, two coils of manganin wire were constructed of about 50 ohms each. One was made in a small compact shape of about the same volume as the 30 milligrams of radium bromide introduced, while the other was made of many turns of wire on a frame of approximately the same shape as the emanation-tube. Currents of known strength were sent through the heating-coils, and the corresponding differences of pressure observed on the manometer. Thus two calibration curves were obtained, which differed a little but represented as nearly as we could arrange the two sources of heat. Although the differential air-calorimeter did very well for the first observations over the whole range of several weeks, and was very suitable for measuring the quantity of heat emitted, on account of its large mass and the volume of air affected it did not respond quickly enough to obtain the important initial changes. Two pairs of sensitive inner-coil platinum thermometers were therefore constructed, having a lag of not more than 6 or 7 minutes. The two pairs enabled us to work with the radium and the emanation-tube at the same time, which was important for the first changes.

Each thermometer consisted of 35 cms. of fine platinum wire wound carefully on the inside of a thin glass tube 5 mms. in diameter. To secure the wire, the tube was gently warmed to a low red heat until the wire stuck fast to the glass, forming a coil about 3 cms. long. The ends of the coil were gold soldered to heavy platinum-wire leads. The tube containing the radium, as well as the tube containing the emanation, was selected so as to slide easily into the interior of the coil, the wire thus being in direct contact with the glass envelope containing the source of heat.

Each thermometer was fitted centrally in a larger glass tube, passing through a long narrow water-bath (fig. 2). A stirrer in the water-bath kept the temperature always uniform. The changes in the resistance of the thermometers when the radium or emanation-tube was transferred from one to the other were measured on a Callendar type of compensated resistance-box constructed with great care. This box has already been described by one of us* in another place.

* H. T. Barnes, *Phil. Trans.* vol. excix. p. 185 (1902).

The differences were observed on a scale-and-vernier reading to the $\frac{1}{100}$ of a millimetre. The greatest difference observed

Fig. 2.—Differential Inner-coil Platinum Thermometers in Water-bath.

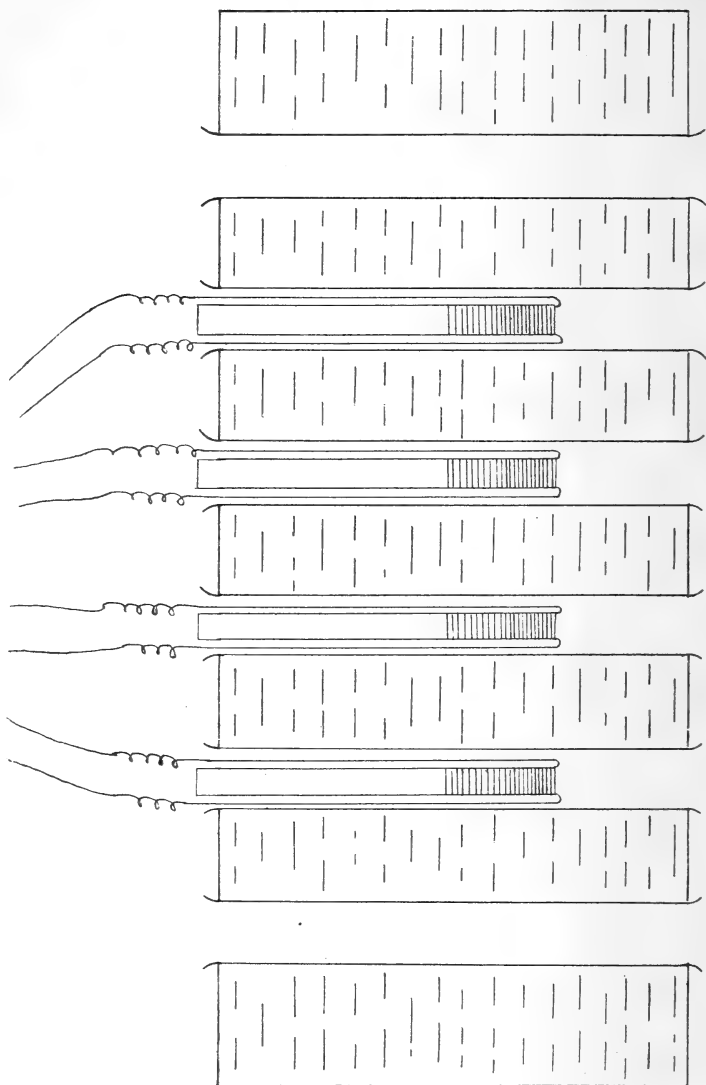

amounted to somewhat over 7 millimetres, and corresponded to a difference of temperature of about $\frac{3}{10}^{\circ}$ C., and readings could be made with certainty down to one-hundredth of this. We did not aim to obtain quantitative measurements of the

heat evolved, as we were directly concerned with the initial portions of the curves, for which relative values were all that were required. As a check, however, we calibrated one pair of the differential thermometers, and found a very close agreement for the heat emission of 30 milligrams of pure radium bromide, with the value obtained by the air-calorimeter. This amounted to a little over 100 gram-calories per hour for 1 gram of pure radium, which agrees very closely with the values given by Curie and Laborde, and later by Runge and Precht*.

Measurements of Radioactivity.

In the experiments, the emanation was driven off from the radium by heating it, and the emanation was then condensed in a small glass tube immersed in liquid air. It was important to know how much of the emanation was removed by the heating, and how much of the emanation, which was driven off from the radium, was collected in the condensing-tube. This was done in the following way.

The tube containing the radium was placed behind a lead screen 5 cms. thick, placed near a cylindrical metal electro-scope, in which the gold-leaf system was insulated by a sulphur bead, after the manner first employed by C. T. R. Wilson. The rate of movement of the charged gold-leaf was observed by means of a microscope with a micrometer eyepiece. A rapid rate of movement of the gold-leaf was observed due to the γ rays from the radium after passing through the lead screen 5 cms. thick. Preliminary experiments by one of us, showed that the γ rays always accompanied the β rays from radium and were proportional in amount to them. If the radium was completely de-emanated, after sufficient time has elapsed for the excited activity to decay, the γ rays, as well as the β rays, almost completely disappeared. If the radium, four or five hours after de-emanation, showed more than 1 or 2 per cent. of the original rate of discharge measured by the γ rays, it was concluded that a portion of the emanation had not been removed †. The proportion of the emanation left behind was in such a case directly proportional to the γ rays, since the excited activity and consequently the rays left behind, after the lapse of four or five hours, is practically

* *Sitz. Akad. Wiss. Berlin*, No. 38 (1903).

† In the first heating of the radium bromide to a temperature considerably below that of a red heat, the emanation was completely released. A second heating, after the radium had recovered its activity, only removed 75 per cent. of the occluded emanation.

proportional to the emanation present. If no emanation had been lost, the γ rays from the radium and the emanation-tube together should, at any time, be equal to that from the original radium. If this were not the case, it showed that a portion of the emanation had escaped into the pump, and the amount so lost would be calculated from the difference in the rates of discharge of the electroscope. These measurements could be made with rapidity and accuracy, and served as a guide to the amount of emanation present in a vessel. It must be borne in mind that the γ rays emitted only serve as a measure of the amount of emanation present, when sufficient time has elapsed (3 to 4 hours is enough) for the emanation and its product emanation X to reach a state of approximate radioactive equilibrium. Immediately after the introduction of the emanation into a vessel no β or γ rays are observed, but the intensity of the β rays and γ rays reaches about half their maximum value 45 minutes later.

Description of Experiments.

The heating effect of 30 milligrams of radium bromide, inclosed in a narrow glass tube, was first determined in the air-calorimeter. The radium tube R (fig. 3) was then connected through a phosphorus-pentoxide tube A to a short narrow glass tube T, about 3 cms. long, connected to a mercury pump P. The tube T passed through a small liquid-air vessel, made of ebonite, in order to condense any emanation passing through it.

Liquid air was placed in the vessel, and the tubes partially exhausted. The radium was then heated* with a spirit-lamp to drive off the emanation. The water-vapour given off was absorbed in the tube P and the emanation was condensed in the tube T, and the whole emanation given off was condensed in the tube T by slowly working the pump. The tube T and the radium tube were then sealed off, and the heating effect of each tested as soon as possible afterwards in the air-calorimeter. The results obtained are shown in fig. 4 (p. 210). The heating effect of the radium, when first tested, had fallen considerably, and continued to do so for about three hours, when it reached a minimum corresponding to about 30 per cent. of the original value. At the same time the emanation-tube, when first tested, showed considerable heating effect.

* When the radium was heated to about a red heat a very bright phosphorescence was produced in the radium compound. The luminosity was bright enough to observe in ordinary daylight and persisted for several days. Its spectrum was kindly photographed for us by Dr. Schenck and was found to be continuous.

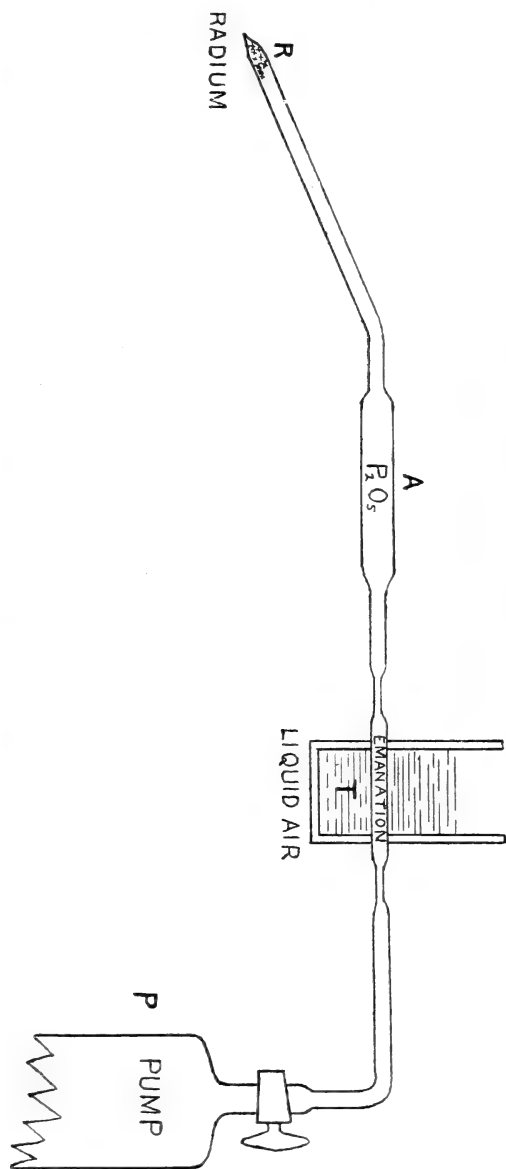

Fig. 3.—Method of Condensing the Emanation from the Radium.

This increased for about three hours, when it reached a maximum. After reaching the minimum, the radium gradually recovered its heating effect, rising to its original value,

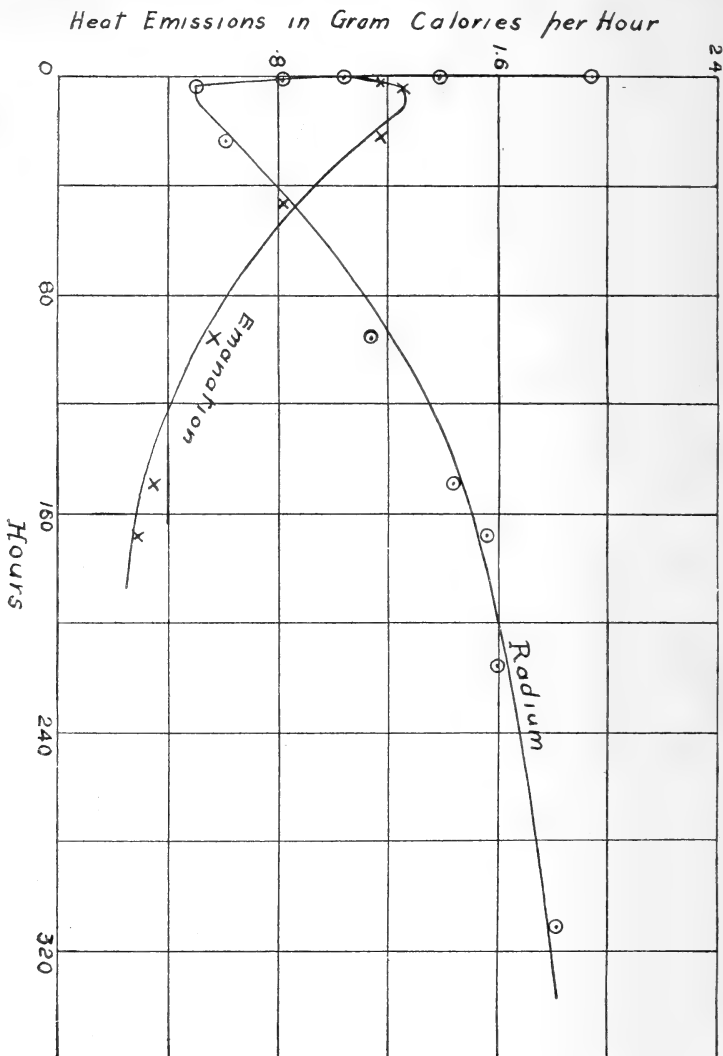

Fig. 4.

after about a month's interval. At the same time the heating effect of the emanation-tube gradually diminished according to an exponential law with the time, falling to half value in about four days.

Within the limit of experimental error the sum total of the heating effect of the radium, together with that of the emanation-tube, was, over the whole course of the experiment, always equal to that of the original radium. Measurements of radioactivity showed that about 6 per cent. of the emanation in the above experiment was not released from the radium by the heating. We may conclude from these results, that about 75 per cent. of the heating effect observed from radium is not directly due to the radium, but to the emanation and emanation X, which it produces from itself. There is a close connexion between the variation of the radioactivity of the radium and its rate of heat emission. After separation of the emanation, the activity of the radium falls to a minimum of about 25 per cent. in the course of a few hours, and then gradually increases again. At the same time, the activity due to the emanation (observed in a closed vessel) increases with the time, on account of the excited activity produced by the emanation on the walls of the vessel. The curves of recovery of the heating effect of radium, and the gradual decrease of the heating effect of the emanation, are almost exactly the same as the corresponding curves for the recovery of activity of the radium and the loss of activity with time of the separated emanation. The rate of heat emission of the emanation, like its activity, falls to about half value in about four days. Half of the lost heating effect, as well as half of the lost activity of the radium, is spontaneously recovered during the same interval. The curve of diminution of the heating effect of the emanation-tube is thus expressed by the equation

$$\frac{Q_t}{Q_0} = e^{-\lambda t},$$

where Q_t is the rate of heat emission at any time t and Q_0 the maximum rate.

The rate of heat emission Q_t of the radium, at any time t after reaching its minimum value, is expressed by the equation

$$\frac{Q_t}{Q_0} = .25 + .75(1 - e^{-\lambda t}),$$

where Q_0 is the maximum rate and λ the same constant as before. The same numerical constants as well as the same equation are obtained for the recovery curves of activity of de-emanated radium, measured by the α rays (see Rutherford and Soddy, *Phil. Mag.* April 1903).

These results, as far as they go, are in agreement with the view that the heating effect of radium is, at any time, proportional to its activity measured by the α rays; or, in other words, that the heat emission of radium is an accompaniment of the expulsion of α particles. The heat emission is not proportional to the β or γ rays; for in the experiment the amount of β and γ rays remaining in the radium, after partial de-emanation, was only 6 per cent. of the total, while the heating effect was about 30 per cent. of the total.

These experiments are not, however, sufficient to justify us in concluding that in all cases the heat emission accompanies the expulsion of α particles and is proportional to the number expelled. It will be necessary, in addition, to show that the emanation and emanation X each supplies an amount of heat proportional to its activity, measured by the α rays, and also that the heating effect of each of the succession of changes of emanation X is always proportional to its activity, measured by the α rays.

*Decrease of Heating Effect of Radium immediately after
De-emanation.*

The air-calorimeter, already described, is not suitable for rapid observations of the variation of the heat emission of the de-emanated radium or the emanation immediately after the latter has been removed. For this purpose the differential platinum thermometers, previously described, were used. The emanation was condensed in a small glass tube 3 cms. long, 3 mms. internal diameter. As the object of these experiments was to determine the initial drop of the heating effect of the radium, only a few minutes were occupied in heating the radium and condensing the emanation. In consequence of this, a small amount of the emanation was carried over into the pump and was not condensed in the tube. The radium tube was rapidly removed and placed inside the air-bath, and observations made on its heating effect, as soon as its temperature was steady. The results are shown in fig. 5, curve B. The heating effect of the radium about 10 minutes after removal of the emanation had fallen to about 45 per cent. of the original value. It then decayed more slowly to a minimum corresponding to about 25 per cent. of the original value.

The gradual decay of the heating effect to a minimum is connected with the removal of the emanation and consequent decay of activity of the emanation X left behind. The curve of decrease of the heating effect to a constant minimum should thus be the same as the curve of decrease to zero obtained

for the emanation-tube, when the emanation is removed from it. The emanation was allowed to stand four or five hours in the emanation-tube, so that the excited activity on the

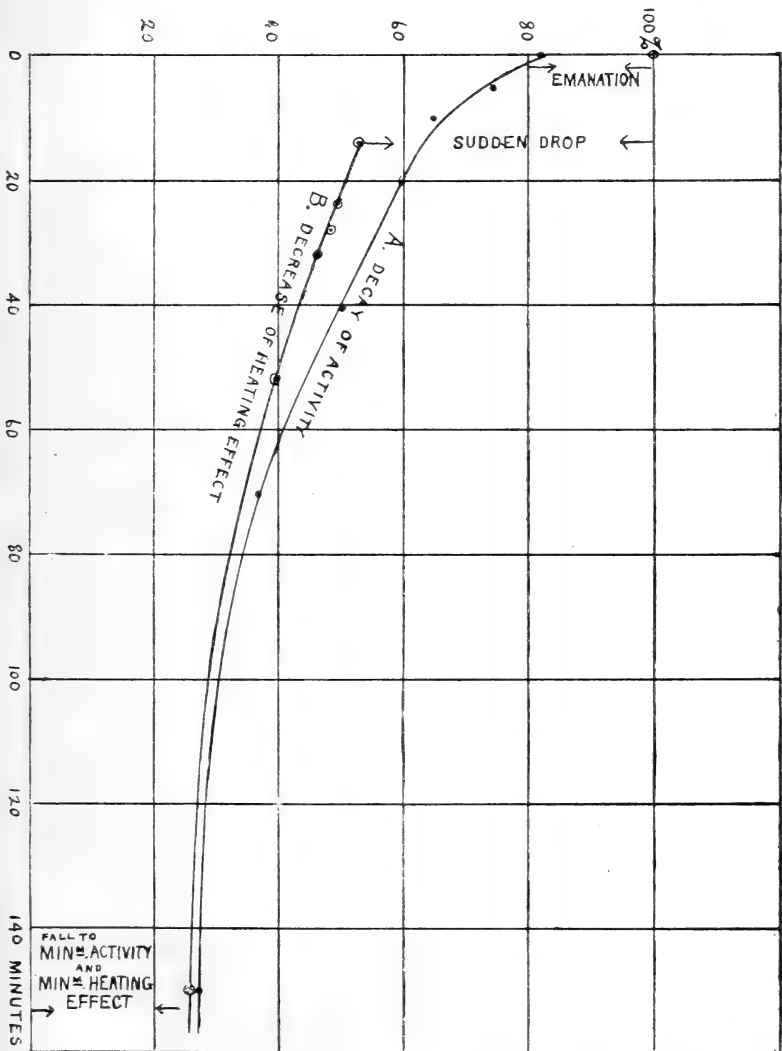
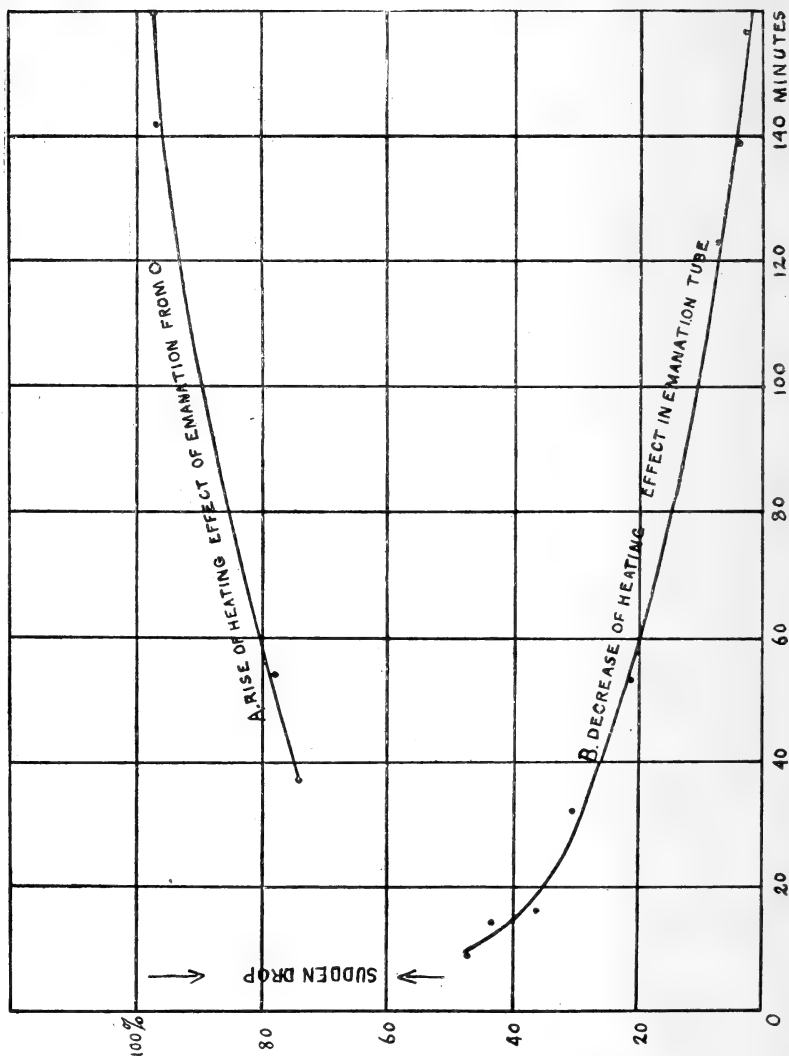

Fig. 5.

walls of the tube had reached a practical maximum. The ends of the tube were then broken, and the emanation rapidly withdrawn. The heating effect of this tube was then deter-

mined at regular intervals. The results are shown in fig. 6, curve B. The heating effect dropped rapidly during the first ten minutes after the removal of the emanation, then more

Fig. 6.



slowly, and finally diminished approximately according to an exponential law with the time, falling to half value about every 30 minutes. The curve of decrease of the heating effect to zero is about the same as the curve of decrease of the heating effect of the radium to a constant minimum.

Increase of Heat Emission after the Introduction of the Emanation into a Tube.

If the total rate of heat emission is not altered by the transfer of the emanation from the radium to the emanation-tube, the curve showing the rise of heating effect of the emanation-tube should be complementary to the curve showing the decrease to a minimum of the heating effect of the radium after the removal of the emanation. This was found to be the case. The results are shown in fig. 6, curve A*. As the emanation-tube, during the condensation, was cooled to the temperature of liquid air, it was not feasible to take observations on its heating effect after such a short interval as in the case when the emanation was withdrawn without changing its temperature. The results, however, showed that the heating effect of the emanation-tube was about 75 per cent. of its final value, after the emanation had been introduced into the tube 35 minutes. Over the range of observations, the curve of rise of the heating effect of the emanation-tube and curve of decrease of the heating effect of the emanation-tube, after withdrawal of the emanation, are complementary to one another. If the curves are plotted on the same scale the sum of the ordinates of the two curves, at any time, is constant.

Discussion of Results.

It has been shown in figs. 5 and 6 that there is a very sudden drop of the heating effect observed for both the emanation-tube and the radium after removal of the emanation. For the purpose of comparison, the decay curve of the activity of radium after removal of the emanation is plotted alongside the curve of decrease of the heating effect of radium (see fig. 5, curve A). It is seen that immediately after removal of the emanation there is a sudden drop of the activity to 82 per cent. of the maximum value. This shows that the radiation from the emanation supplies about 18 per cent. of the total activity of radium, measured by the α rays. There then follows a fairly rapid decrease for 6 to 8 minutes, and then a more gradual decay to a minimum of 25 per cent. This rapid variation of the excited activity for the first few minutes is due to the fact that the first change in emanation X takes place very rapidly. The effect of this first change is clearly shown when a rod is exposed for a very short interval in the presence of the radium emanation. On removal of the

* Three sets of curves were obtained, of the increase of the heating effect after introduction of the emanation, and of the decrease of the heating effect after removal of the emanation. The curves in all cases were in good agreement.

rod the activity decreases at first very rapidly, falling to about half value in about 3 minutes. After falling below 20 per cent. of the maximum value the activity varies very little for a space of about 25 minutes, when there follows a gradual decay to zero (see Rutherford and Miss Brook, *Phil. Mag.* July 1902).

P. Curie and Danne* have shown that the decay of activity of a body exposed for a long interval in the presence of the emanation is given by the equation

$$\frac{I_t}{I_0} = ae^{-\lambda_1 t} - (a-1)e^{-\lambda_2 t},$$

where I_t is the activity at any time t , and I_0 the activity immediately after removal; $\lambda_1 = 1/2420$, $\lambda_2 = 1/1860$ where a second is taken as the unit of time; the numerical constant $a = 4.20$. Curie and Danne state that this equation holds accurately over the whole period of decay; there is no doubt, however, that there is a rapid initial drop for about the first ten minutes after removal which is not expressed by this equation. The equation will, however, hold if the initial observations of the activity start from a period about 10 minutes after removal, as the first change is almost completed by that time. The equation will also hold, with the same limitations, for the decay of the activity of the emanation X, left behind in the radium after removal of the emanation.

An analysis of the decay curves of excited activity, produced for different intervals of exposure in the presence of the emanation, shows that there are three well-marked changes occurring in emanation X of radium. In the first change, half the matter is transformed in 3 minutes; in the second, half in 34 minutes; and in the third, half in 28 minutes. A full account of the analysis of these changes and their peculiarities will be given by one of us in a later paper. The first change is accompanied only by α rays, the second change is *not* accompanied by α rays at all, and the third change by α , β , and γ rays.

While the curves of decrease of the rate of heat emission and of the activity of radium are very similar in shape, it is not possible to deduce directly from the result how much of the comparatively sudden drop of the heating effect observed is due to the emanation and how much to the first change in emanation X, on account of the rapid first change in the latter. The activity of the first change of emanation X (half value in 3 minutes) will have been reduced to about 10 per cent. of its original value in 10 minutes. The

* *Comptes Rendus*, cxxxvi. p. 364 (1903).

first certain observation of the heating effect of the radium in the emanation-tube could not be made until about 10 minutes after removal of the emanation. It is essential to allow an interval of at least 5 minutes in order to allow the glass envelope to take up the temperature corresponding to the source of heat inside it.

On account of the rapid initial change in emanation X, we can only conclude from the experiments that about 41 per cent. of the total heating effect of radium is due to the emanation together with the first change in emanation X. The other results all indicate that the heating effects accompany the emission of α rays; for example, the minimum heating effect due to de-emanated radium is 25 per cent. of the total, and the activity is also 25 per cent. of the total activity, and consists entirely of α rays. Both the radiation from the emanation and that from the first change in emanation X consist entirely of α rays; and there can be little doubt that the emanation does give rise to a heating effect of the same order of magnitude as is observed in the other changes, which are accompanied by α rays. Further experiments are, however, in progress to separate, if possible, the heating effect of the emanation from that due to the first change in emanation X.

The decrease of the heating effect due to the excited activity after the first sudden drop is not very rapid at first, and, in this respect, closely resembles the decay of the excited activity. It thus appears probable that the second change in emanation X, which does not give rise to α rays, is also not accompanied by the same emission of heat as in the other changes. Further experiments are in progress to settle this point.

The rate of heat emission of radium, when in a state of radioactive equilibrium, is thus made up as follows:—

| Active products. | Nature of rays. | Percentage proportion of activity measured by α rays. | Percentage proportion of total heating effect. |
|---|----------------------------------|--|--|
| Radium (freed from active products). | α rays. | 25 | 25 |
| ↓ Emanation. | α rays. | 18 | } 33 41 |
| ↓ Emanation X (first change). | α rays. | 15 | |
| ↓ Second change. | No α rays. | 0 | } 42 34 |
| ↓ Third change. | $\alpha, \beta, \& \gamma$ rays. | 42 | |

Although the experimental results are not yet complete enough to settle definitely whether the heating effect of each of the products is proportional to its activity, measured by the α rays, the results, as far as they have gone, indicate that this is approximately the case. The heating effect is certainly directly connected with the radioactivity of radium, and the time-variation of the heating effect of each of the radioactive products is the same as the time-variation of the activity. This result shows that the heat emission of radium is an accompaniment of the successive changes occurring in radium.

It still remains to be shown how much of the heat emission of radium is due to the kinetic energy of the α particles, and how much to the atomic systems from which they are expelled. In a mass of radium nearly all the α rays, emitted from it, are absorbed in the radium itself. The radium is thus subjected to an intense bombardment by the α particles projected from its own mass. There is no doubt that a proportion of the heating effect of the radium is due to this self bombardment, but probably, also, a part is due to the energy emitted consequent upon the rearrangement of the components of the atoms from which the α particles are expelled. It is not to be expected that the division of heat between the two systems would be the same for each active product, and, in consequence, that the heating effect of each product should be accurately proportional to its activity measured by the α rays.

In the experiments made on the heating effect, the α rays, in all cases, were absorbed in the glass envelope, and thus added their heating effect to that given out by the systems from which they were expelled. A large proportion of the β rays and practically all the γ radiation escaped. It has, however, been shown* that, in all probability, the energy emitted in the form of β and γ rays is only a small fraction of the energy emitted in the form of α rays.

Amount of Heat from the Emanation.

It has been shown that the heating effect from the emanation, together with that of the active product to which it gives rise, is equal to about 75 per cent. of the total heat emission of radium. Since 1 gram of radium emits heat at a rate of 100 gram-calories per hour, the emanation from 1 gram of radium in a state of radioactive equilibrium, a few hours after its removal, radiates heat at the rate of 75 gram-calories per hour. Since the rate of heat emission at any

* Rutherford and Grier, Phil. Mag. Sept. 1902.

time (after it has reached a maximum value) is given by

$$\frac{Q_t}{Q_0} = e^{-\lambda t},$$

the total amount of heat given out from the emanation released from 1 gram of radium is equal to

$$\int_0^{\infty} Q_0 e^{-\lambda t} dt = \frac{Q_0}{\lambda}.$$

Since the heating effect of the emanation decays to half value in about 3.73 days $\lambda = .0077$ when an hour is taken as the unit of time. The total amount of heat derived from the emanation from 1 gram of radium is thus about 10,000 gram-calories. Now it has been shown (Rutherford, 'Nature,' Aug. 20, p. 366, 1903) that the volume of the emanation released from 1 gram of radium probably lies between 6×10^{-4} and 6×10^{-5} c.c., at standard pressure and temperature. The amount of heat liberated *per hour* from 1 c.c. of the emanation would thus lie between 1.25×10^5 and 1.25×10^6 gram-calories. This amount of heat from 1 c.c. of the emanation would probably be sufficient to raise to a red heat, if not to melt down, the glass tube containing it.

The emanation behaves as if it were a gas of heavy molecular weight. Assuming for the purpose of calculation that the molecule of the emanation is 100 times as heavy as the molecule of hydrogen, it can readily be deduced that 1 gram of the radium emanation, in its succession of changes, would radiate an amount of energy lying between 2×10^9 and 2×10^{10} gram-calories. One pound weight of the emanation would initially radiate energy at the rate of 10^4 to 10^5 horse-power and, while the heating continued, would emit an amount of energy between 6×10^4 and 6×10^5 horse-power-days.

Quite independently of any assumptions, a result of the same order of magnitude can be deduced from the observed heating effect of the emanation, and the fact that the emanation has not, so far, been detected either by its volume or its weight.

There is thus no doubt that matter under special conditions is capable of emitting an amount of energy enormous compared with that released in the most intense chemical reactions. On the disintegration hypothesis (Rutherford and Soddy, Phil. Mag. May 1903) this energy is derived from the energy latent in the radium atoms, and is released in the successive stages of their disintegration.

XX. *Contribution by Lord KELVIN to the Discussion on the Nature of the Emanations from Radium which was opened by Professor E. Rutherford at the Meeting of the British Association last September*.*

LET us first consider the mere fact, now known as a result of observation and experiment, that radium has been found to emit three types of rays:—

α . Positively electrified, and largely stopped by solid, liquid, or gaseous screens.

β . More penetrative than α , and negatively electrified.

γ . Electrically neutral, and much more penetrative than either α or β ; passing with but little loss through a lead screen 1 centimetre thick, which is an almost perfect screen against α and β rays.

A simple *prima facie* view is to regard the ‘ γ rays’ as merely vapour of radium. The ‘ β rays’ seem certainly to be atoms of resinous electricity—electrions, as I have called them (to specialise Johnstone Stoney’s ‘electron,’ which might be either a vitreous or resinous atom of electricity, or an atom of matter deprived of its natural quantum of electricity). The ‘ α rays,’ according to my proposed atomic resuscitation of Aepinus’s doctrine †, are atoms or molecules of matter, probably atoms of radium, or perhaps molecules of bromide of radium; either deprived of electrons, or having less than their neutralising quantum.

The electro-etherial hypothesis, referred to in my communication of last Thursday to Section A ‡, affords a ready explanation of the relative penetrativities of the three radiations, and of the fact that each one of them makes its existence known to us by conferring electric conductivity on air or any ordinary gas in which it is present.

Taking the γ rays first, we have to explain the free penetration of unelectrified radium molecules through dense liquid or solid matter. An easy assumption suffices: let the Boscovichian mutual forces (that is, the chemical affinities and the repulsions) between an atom of radium and the atoms of lead and other permeable substances be small enough to allow the known permeation.

Taking, next, the α radiation. The apparent great absorption of the vitreous electric emanation from radium is only apparent; it means that an atom shot from radium with less

* Communicated by the Author.

† Baltimore Lectures, Appendix C. Reprinted from the Jubilee Volume presented to Prof. Boscha of Leyden in November, 1901. *Phil. Mag.* 1902 (1st half year).

‡ *Phil. Mag.* Oct. 1903.

than its neutralising quantum of electrions cannot go far through a solid or liquid without acquiring the neutralising quantum.

The β rays are merely electrions; and their absorption may be regarded as real. Atoms of resinous electricity shot from radium cannot be expected to enter a screen of metal or glass or wood or liquid, and leave at the other side irrespectively of the insulation of the screen and of the radium. The full consideration and experimental investigation of the emission of atoms of resinous electricity from radium hermetically sealed in a glass bulb or tube is forced upon us. It has, I believe, led to surprising and interesting results. As to the γ rays, there is no difficulty in supposing that non-electrified vapour of radium passes very freely through glass or metals without any electric disturbance. It has been published, on authority so far as I know unquestioned, that loss of weight in the course of a few months has been proved. Full information on all that is known on this subject will no doubt be brought forward in the course of the discussion to be opened by Professor Rutherford. I regret much that I am not able to be present, and I shall look forward with eagerness to the earliest published reports of the discussion.

Returning to Becquerel's original discovery in respect to uranium and salts of uranium, the electric conductivity induced in air and other gases by a radio-active substance; we have a ready explanation in my atomic resuscitation of the old doctrine of Aepinus. The ordinary thermal motions within any solid, or liquid, or gas, must cause occasional shootings out of the electrions from the substance; and the motions of these electrions under the influence of electrostatic force must contribute to the electric conductivity of the gas; must, in fact, constitute all of it which is not due to transport of atoms of the gas carrying less than the neutralising quantum of electrions. Thus every substance, solid, liquid, or gas, must possess radio-activity. It is exceedingly interesting to find in Strutt's short paper "On Radio-activity of Ordinary Materials"*, that the electric conductivity of dry air contained in a cylinder of solid material differs largely for different materials (1.3 for glass coated with phosphoric acid, 1.4 aluminium, 2 to 3.3 various ordinary metals, 3.9 platinum). It is also exceedingly interesting to be told that radium is 300,000,000 times more active than the most active common material with which he experimented. How are we to explain this enormous radio-activity of radium? I venture to suggest that it may be because it is exceedingly poly-electronic; that the saturating quantum of electrions in an atom of radium

* Phil. Mag. June 1903.

may be hundreds, or thousands, or millions of times as many as those of atoms of 'ordinary material.'

But this leaves THE mystery of radium untouched: Curie's discovery that it (perpetually?) emits heat at a rate of about 90 Centigrade calories per gramme per hour. If emission of heat at this rate goes on for little more than a year, or, say, 10,000 hours ($13\frac{1}{2}$ months), we get as much heat as would raise the temperature of 900,000 grammes of water by 1° C. It seems to me utterly impossible that this can come from a store of energy lost out of the gramme of radium in the 10,000 hours. It seems to me, therefore, absolutely certain, that if emission of heat at the rate of 90 calories per gramme per hour found by Curie at ordinary temperatures, or even at the lower rate of 38 found by Dewar and Curie from a specimen of radium at the temperature of liquid oxygen, can go on month after month, energy must somehow be supplied from without to give the energy of the heat which gets into the material of the calorimetric apparatus.

I venture to suggest that somehow etherial waves may supply energy to the radium while it is giving out heat to the ponderable matter around it. Think of a piece of black cloth hermetically sealed in a glass case, and sunk in a glass vessel of water exposed to the sun; and think of another equal and similar glass case containing white cloth, submerged in an equal and similar glass vessel of water, similarly exposed to the sun. The water in the former glass vessel will be kept very sensibly warmer than the water in the latter. This is analogous to Curie's first experiment, in which he found the temperature of a thermometer, with a little tube containing radium kept beside its bulb, in a little bag of soft material, to be permanently about 2° C. higher than that of another equal and similar thermometer, similarly packed with a little glass tube not containing radium beside its bulb.

By observing the temperature of the water in our two glass vessels, a calorimetric investigation might be made, showing how much heat is given out per hour by the black cloth to the surrounding glass and water. Here we have thermal energy communicated to the black cloth by waves of sunlight, and given out as thermometric heat to the glass and water around it. Thus, we actually have energy travelling inwards through the water, in virtue of waves of light, and outwards through the same space in virtue of thermal conduction.

My suggestion respecting radium may be regarded as utterly unacceptable; but at all events it will be conceded that experiments should be made comparing the thermal emission from radium wholly surrounded with thick lead with that found with the surroundings hitherto used.

XXI. *The Effect of the Passage of Electricity through a Mixture of Oxygen and Hydrogen at Low Pressures.* By Rev. P. J. KIRKBY, *Fellow of New College, Oxford*.*

THE object of these experiments was to examine the chemical action attending the passage of electricity through a mixture of hydrogen and oxygen.

The apparatus was designed with the view of ascertaining whether chemical combination is produced by a small current unaccompanied by sparking. It was also used for larger currents attended by a spark and glow in the gas.

It was proposed to produce the small currents by the motion under an electric force of ions set free by the action of ultra-violet light on a zinc plate.

The essential part of the apparatus accordingly consisted of two parallel metallic plates, the upper, the zinc plate ZN (fig. 1), being within an air-tight bell-jar which was fastened to, and rested upon, the lower, a brass plate AB. Their distance apart was nearly 1 cm.—more precisely 9.7 mm. A circular hole was turned out of the centre of AB to allow the passage of the ultra-violet light into the apparatus, and

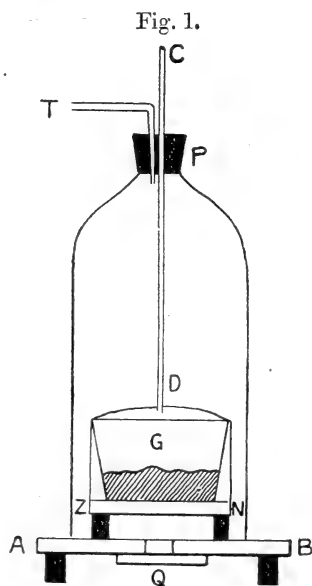

over the hole and beneath the plate was fastened the quartz plate Q. The continuity of the upper surface of AB was

* Communicated by Professor Townsend, F.R.S.

restored by a wire network which fitted tightly into the circular hole. Upon the plate ZN rested a glass vessel G containing pentoxide of phosphorus, the purpose of which was to absorb any water-vapour which might be produced. The glass vessel G was kept in its place by a rectangular strip of brass which was screwed to the zinc plate at ZN; a brass rod CD was in metallic connexion with the strip of brass, and passing through the ebonite plug P in the neck of the bell-jar could connect the plate ZN to the electrometer. Ebonite pillars coated with sulphur supported ZN and insulated it from AB. Ordinary precautions were taken to avoid the influence upon the electrometer of charges which might creep up the glass from the plate AB. The brass tube T, through which the gas was passed into the bell-jar, was fastened into the ebonite plug P. The cylindrical part of the bell-jar was about 12 cm. in height and 6.5 in diameter. The diameter of the plate ZN was about 5 cm.

All the joints were sealed by means of elastic glue, which proves remarkably air-tight.

The plate AB was supported on ebonite pillars which kept it insulated. Ultra-violet light was produced between aluminium points immediately below the quartz plate Q by means of the discharge of a leyden-jar whose electrodes were connected to the terminals of the secondary circuit of a Ruhmkorff coil.

Hydrogen and oxygen were prepared by the electrolysis of a solution of caustic potash in the equivalent proportions of two volumes to one, and after passing through drying-vessels were introduced into the bell-jar by means of the tube T. The pressure of the mixed gases was sufficiently reduced to bring it within the range of the McLeod gauge, the limit being about 7 mm. of mercury.

In order to render small falls of pressure easily measurable, a stopcock S had been introduced into the apparatus so as to cut off the bell-jar, the McLeod gauge, and the ordinary manometer from the rest of the apparatus. By this means the volume within which a fall of pressure took place was greatly diminished, and the accuracy with which such a fall could be measured was equally increased.

Fig. 2 is a diagram of this arrangement. The volume of the apparatus to the right of S, and cut off by the stopcock S, within which the falls of pressure took place, was eventually measured in the following way. The apparatus was first exhausted to a low pressure, and, the stopcock S having been closed, the glass tube R was cut and a small glass bulb fused on to it. This bulb could be filled with air at atmospheric

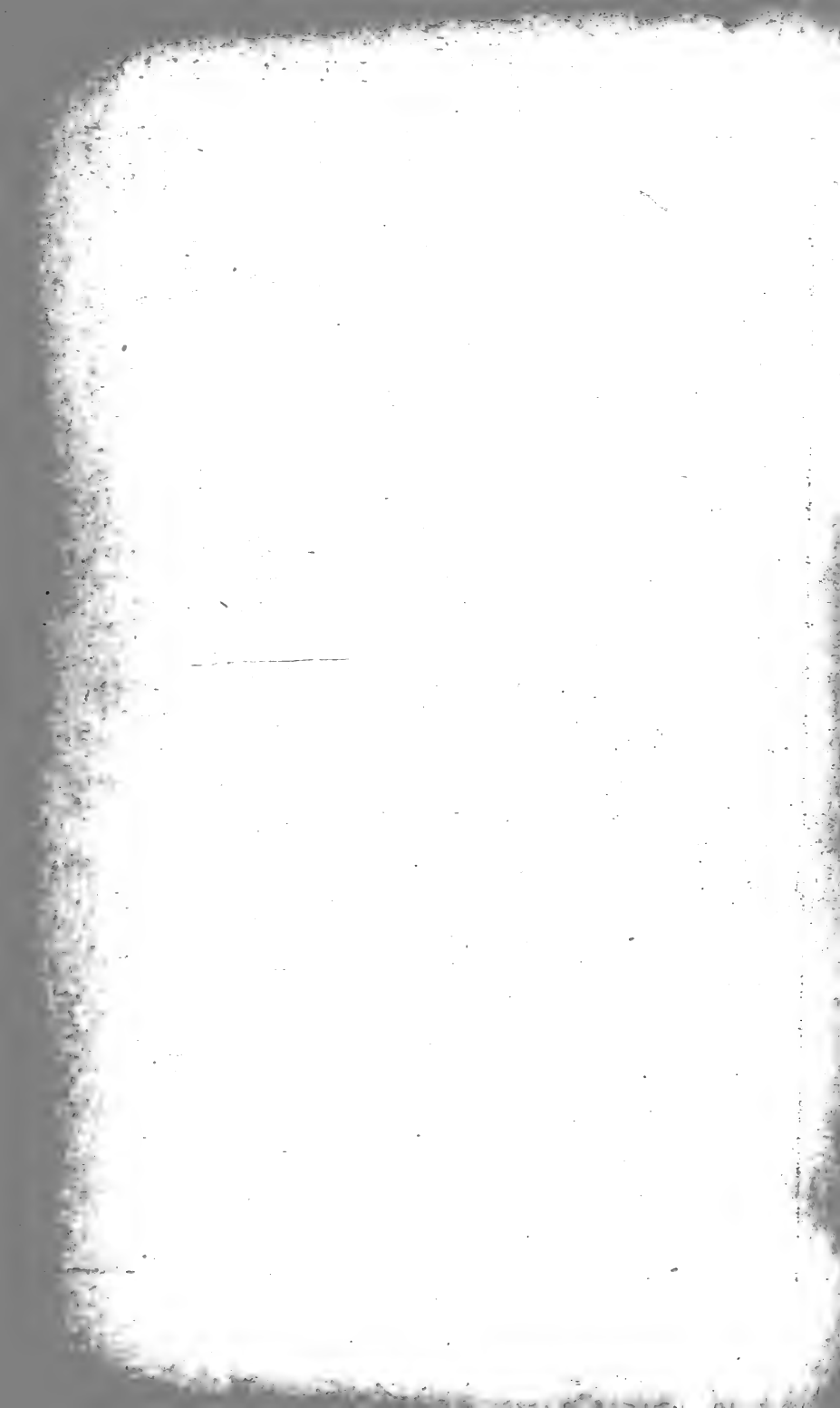

Alternating and Direct
Current Mercury Lamp
36 inches long
Potential and Current Waves
of A.C. Circuit, 100 V. 2.35 A.
17 High Mercury Electrodes $\times 1\frac{1}{2}$ - 2 - 4
Positive Inside, 400 6-5-03

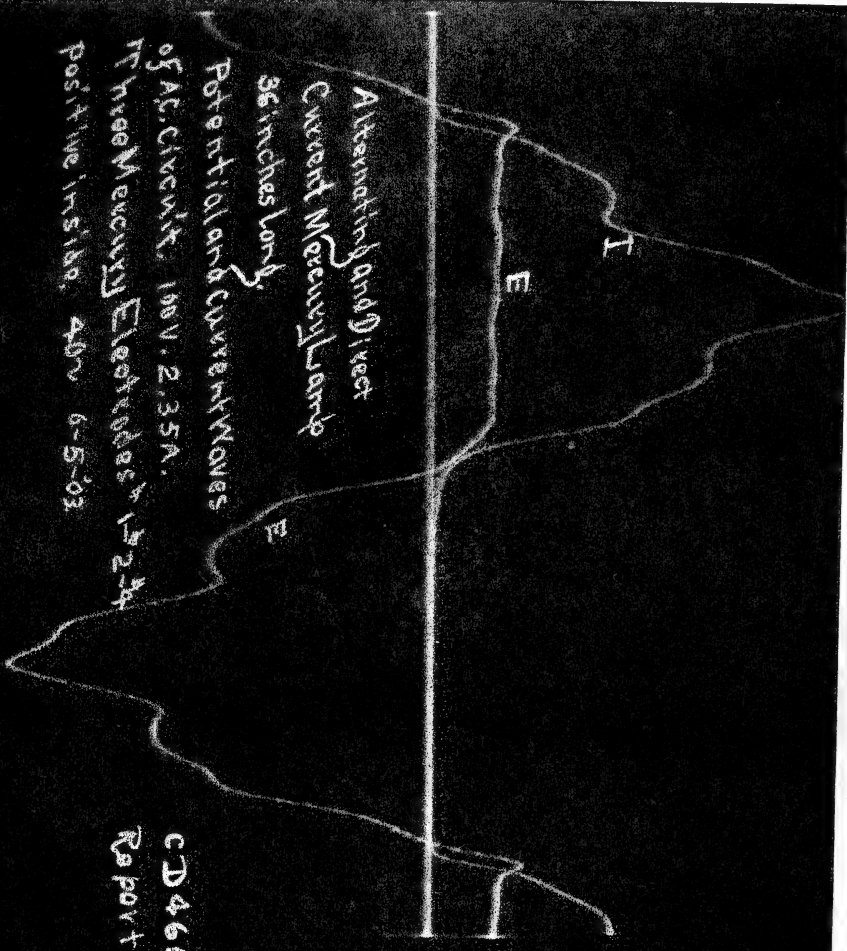

CD 465B
Report 6609

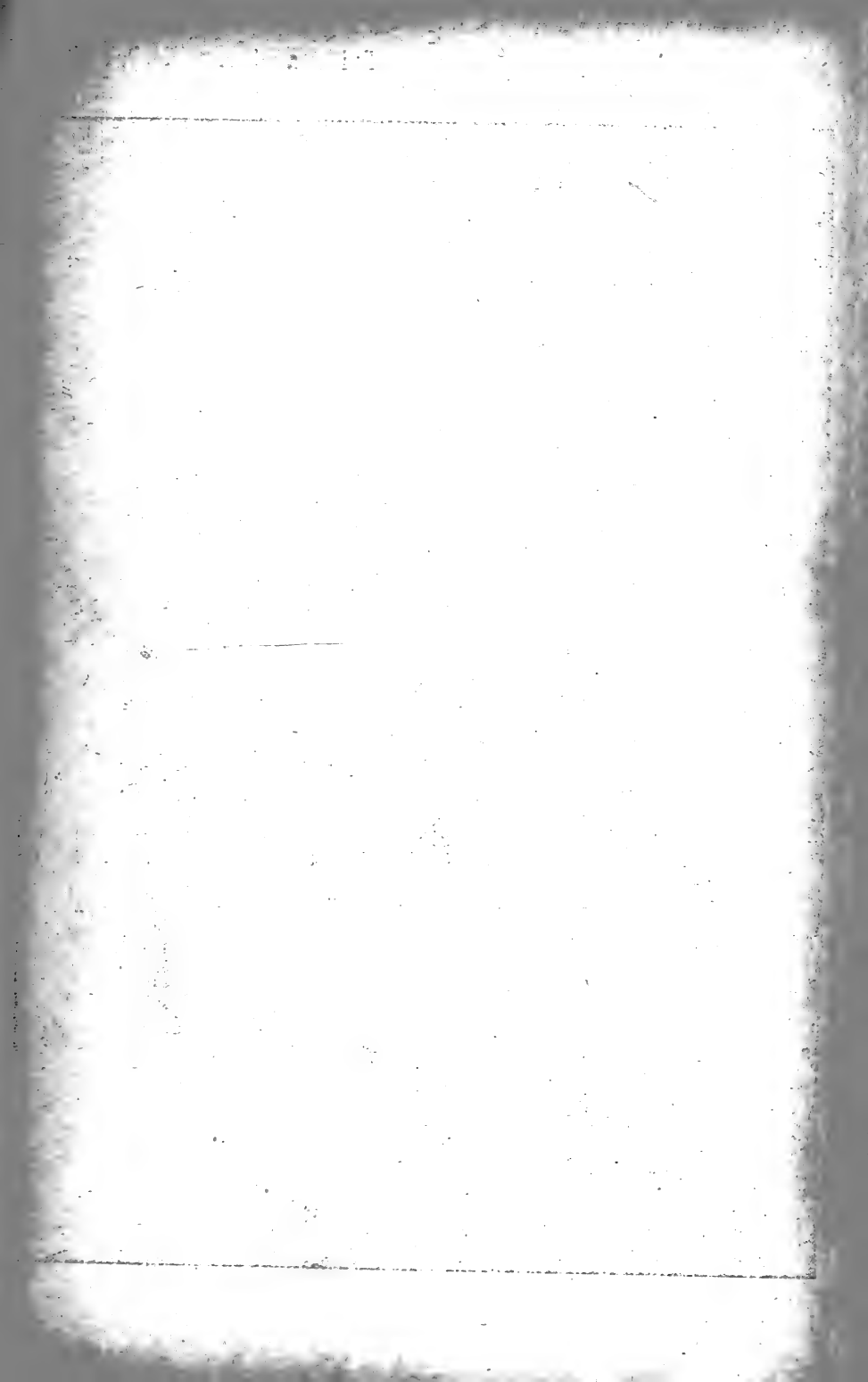

CD 2982

Symmetrical
Mercury/amp.
Mudal section
4500 AC

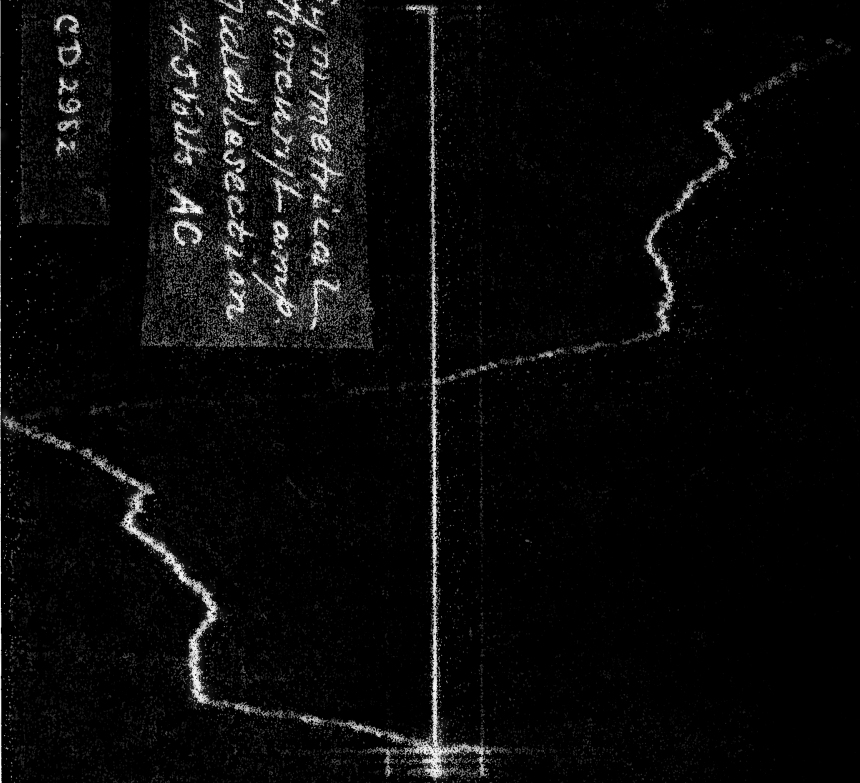

Reference

α

Alternating and
Direct Current Mercury
Lamp.

Current and Potential Waves
of A.C. Circuit.

60~

15AAC. 2.5AAC. 2 7/8 VDC. 79V.AC.

Two Mercury Electrodes
5-13-33

One Lyon Anode Longtube 19"
Oxide Position

E

Potential Readings

D.C. A.C.

1-2 = 15 16

1-3 = 43 85

2-3 = 27 1/2 79

D.C. Current 38ADC. 4AAC.

CD 4594 Report 6603



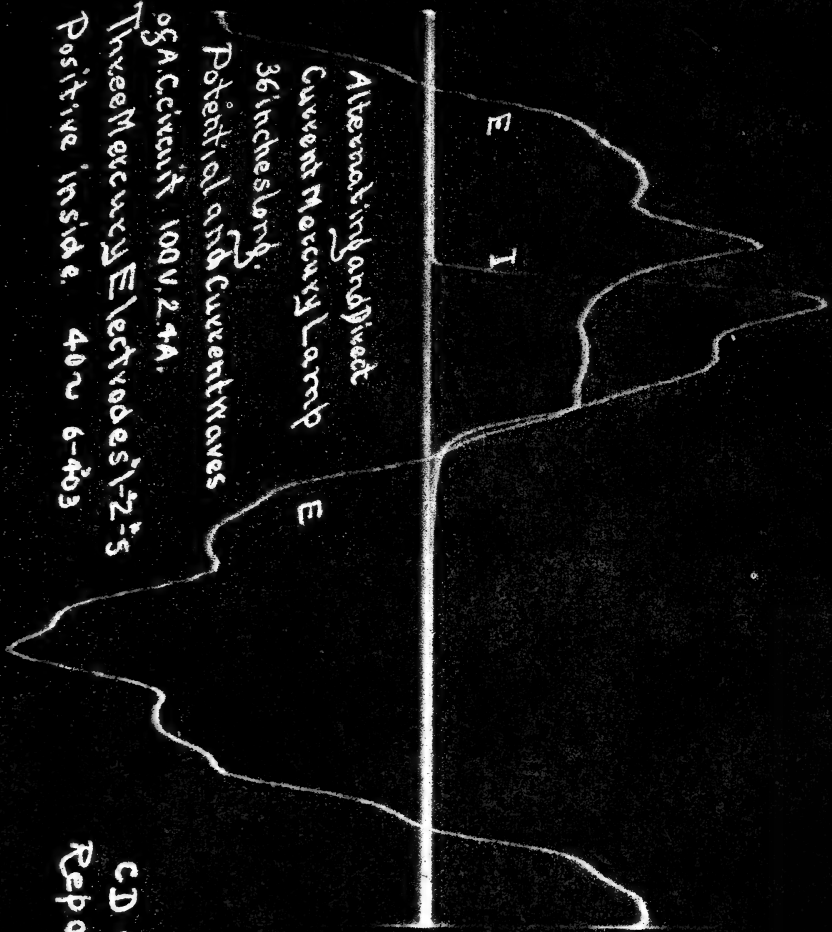

Alternating current
Current Mercury Lamp
36 inches long
Potential and Current waves
of A. Circuit 100 V, 2.4 A.
Three Mercury Electrodes 1-2-5
Positive inside 40 ~ 6-403

CD 4654
Report 6609

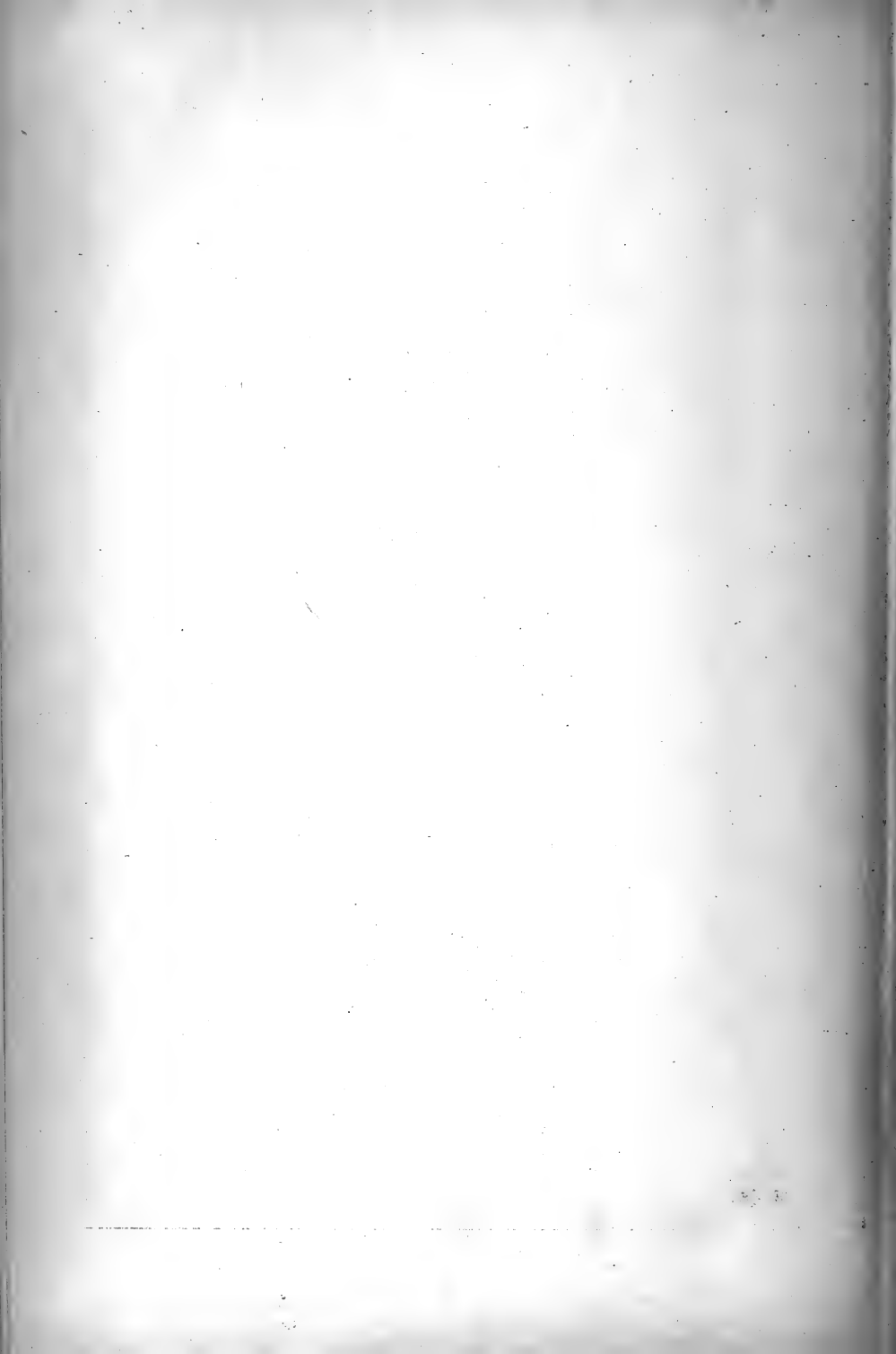

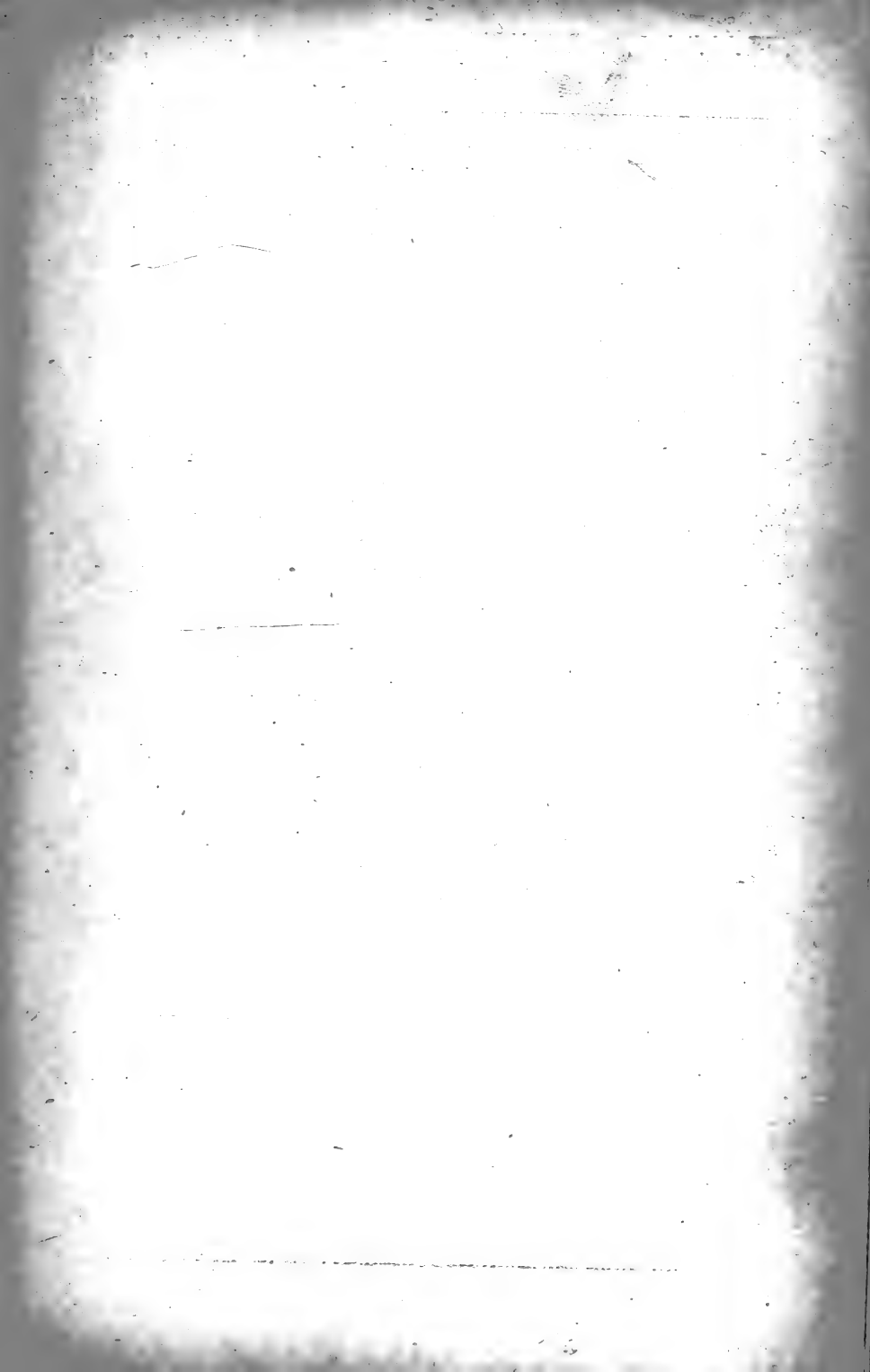

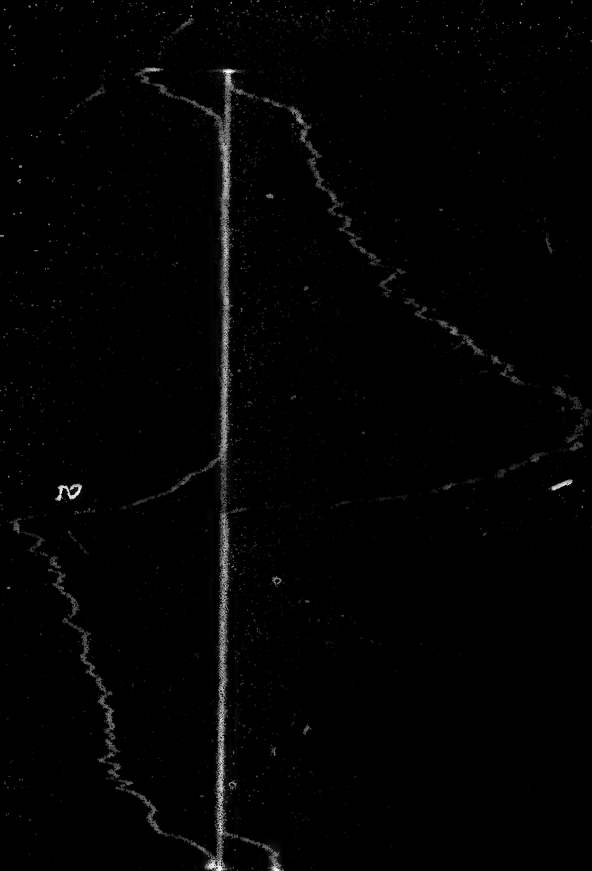

A.C. Mercury Lamp No. 1

1- Total current at R. 37Mc. 225Mc. S. closed. S open

2- Current at R. 2 24Mc. 15Mc. 2-7-03 Report 6609

Measured & from equal resistances = CD 4372



Symmetrical Mg. Mercury Lamp
Current at R5 3.6 ADC 3A4 AIC

CD4395

Report 6609

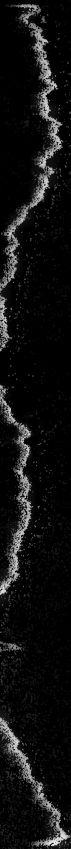



Symmetrical A.C. Mercury Lamp
Current of R 2.1 A.A.C.

Z-26-1903

CD4390

Report 6609

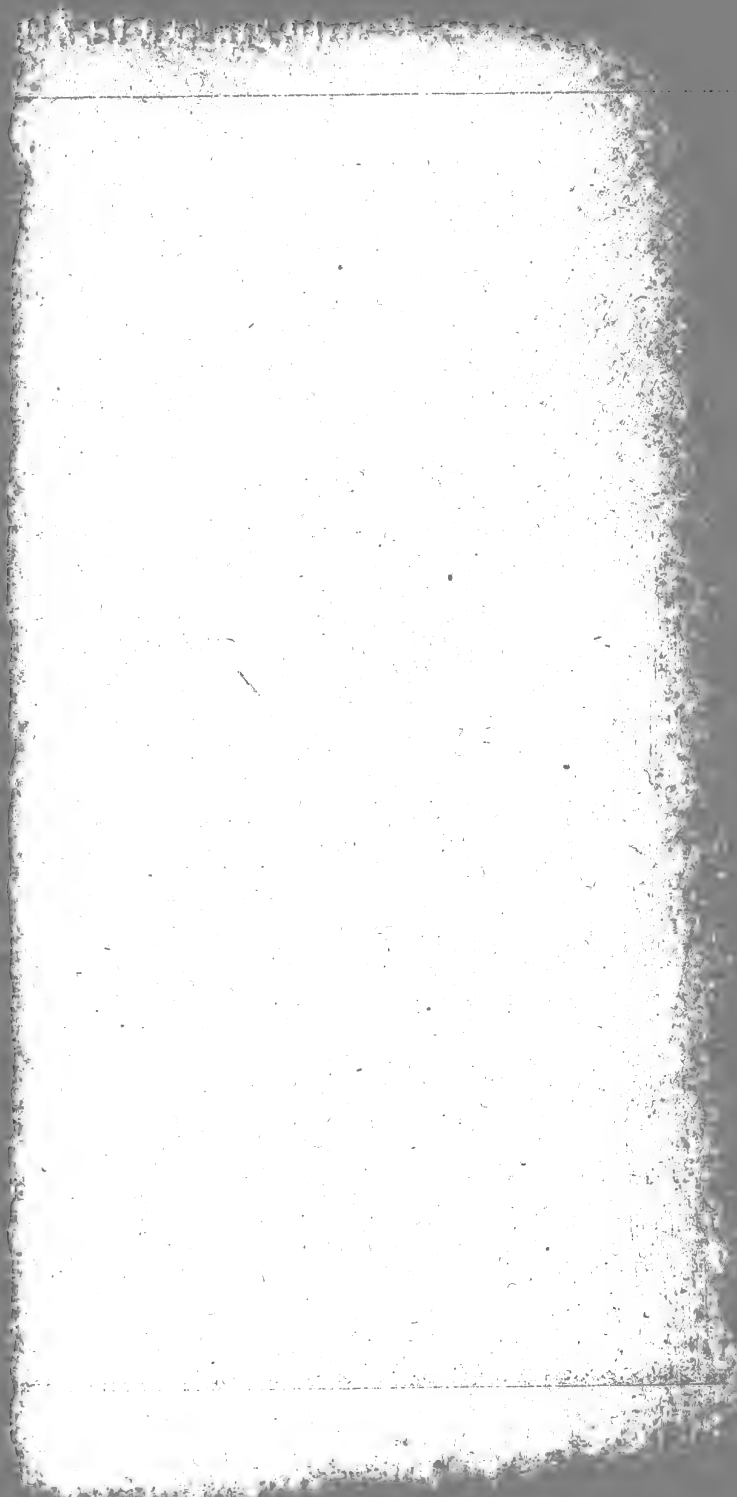



Symmetrical A.C. Mercury Lamp

Current at R₂ 1.8ADC 1.95ANC

2-26-1903

OD4392

Rephot 6609

221



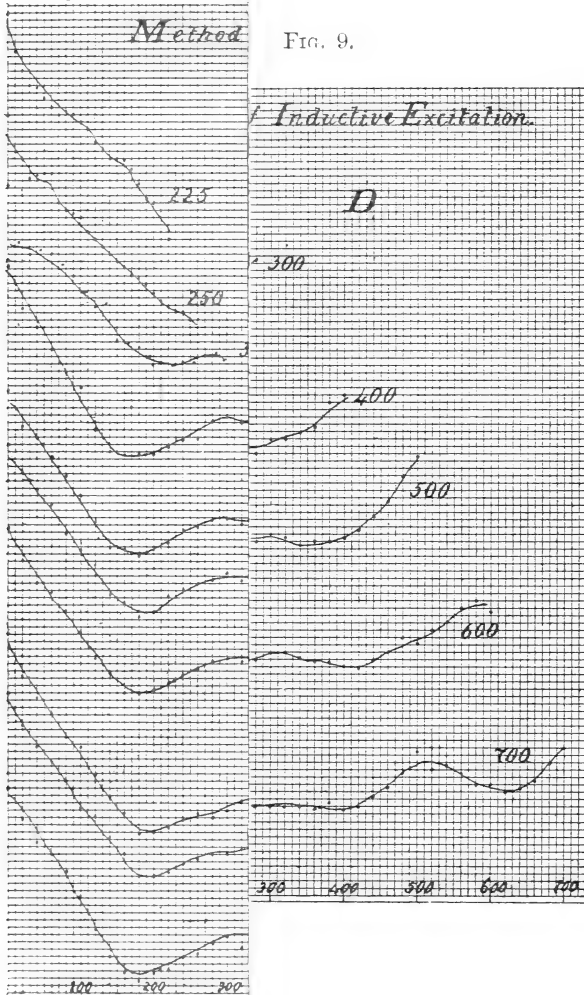



FIG. 6.

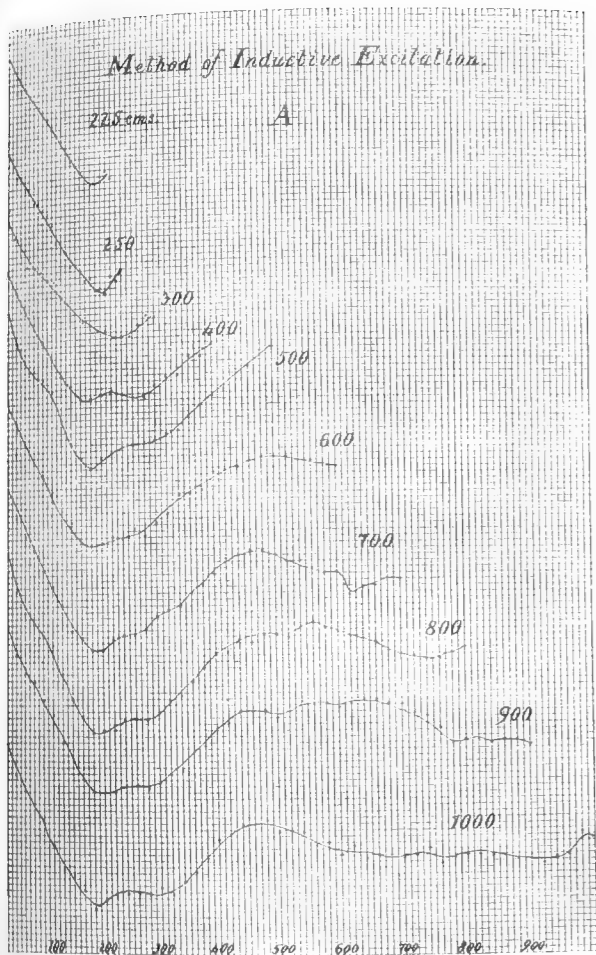

FIG. 7.

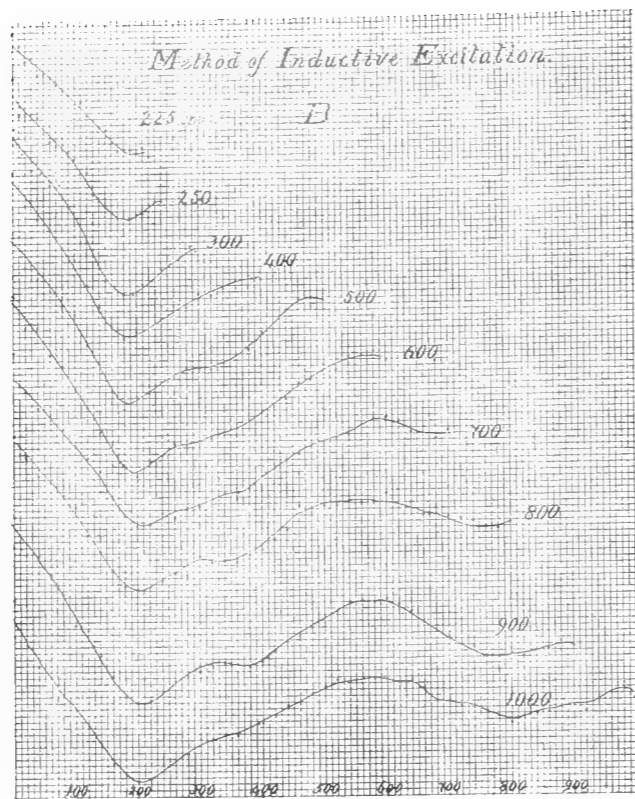

FIG. 8.

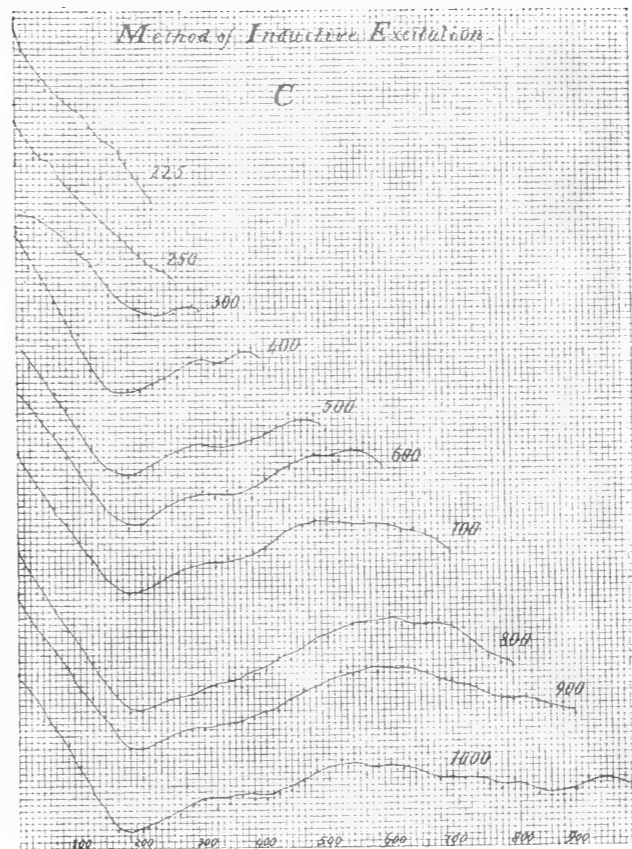

FIG. 9.

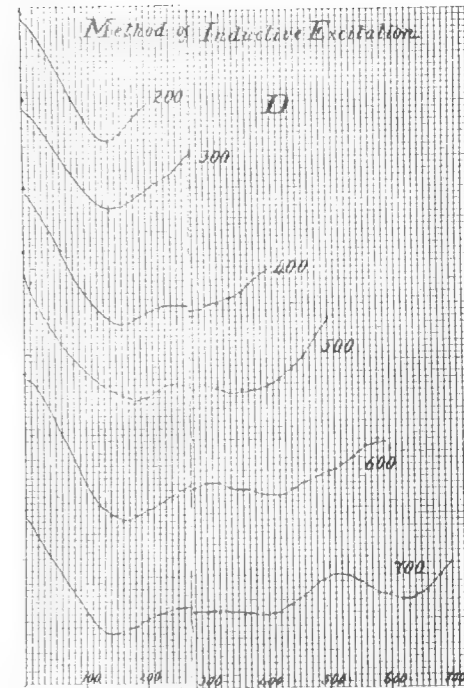



FIG. 14.

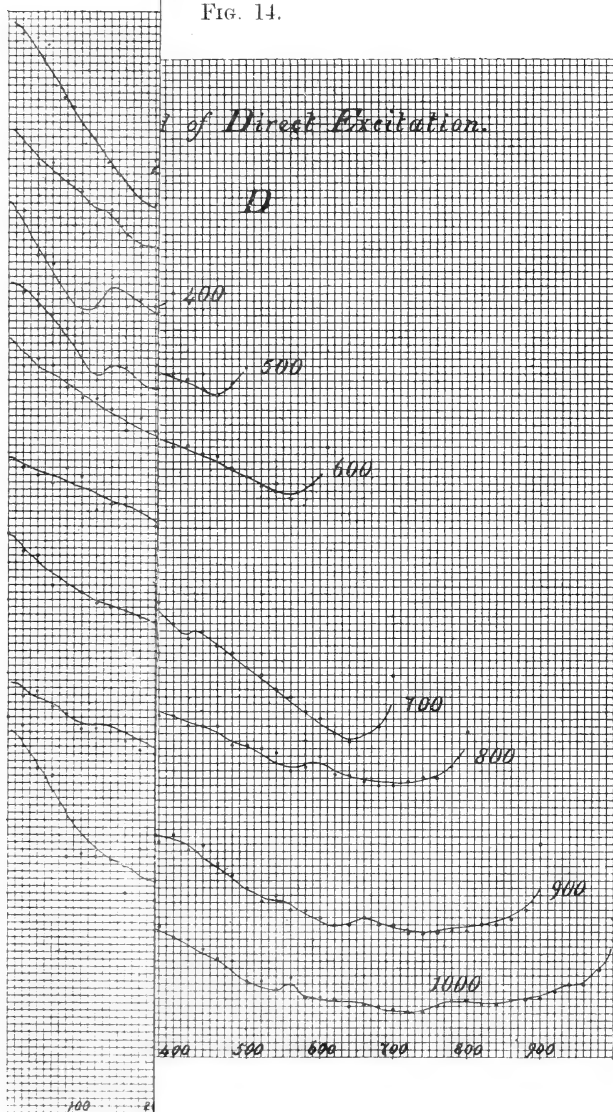



FIG. 11.

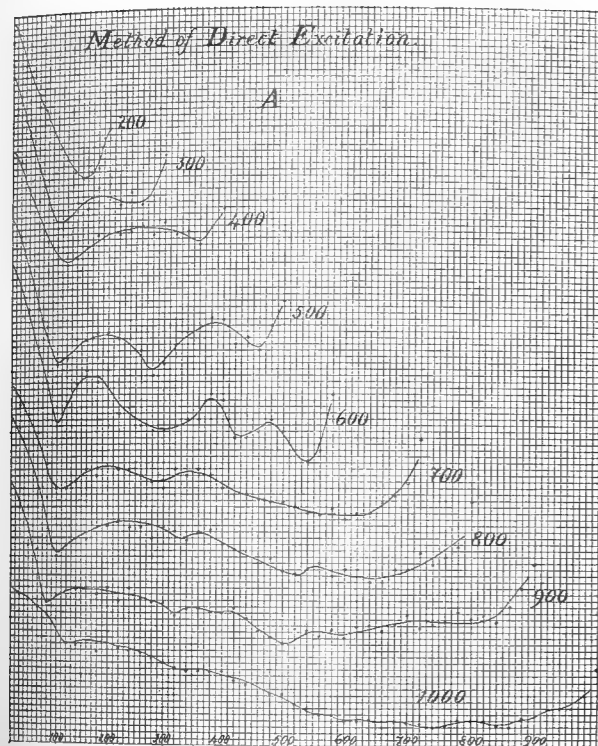

FIG. 12.

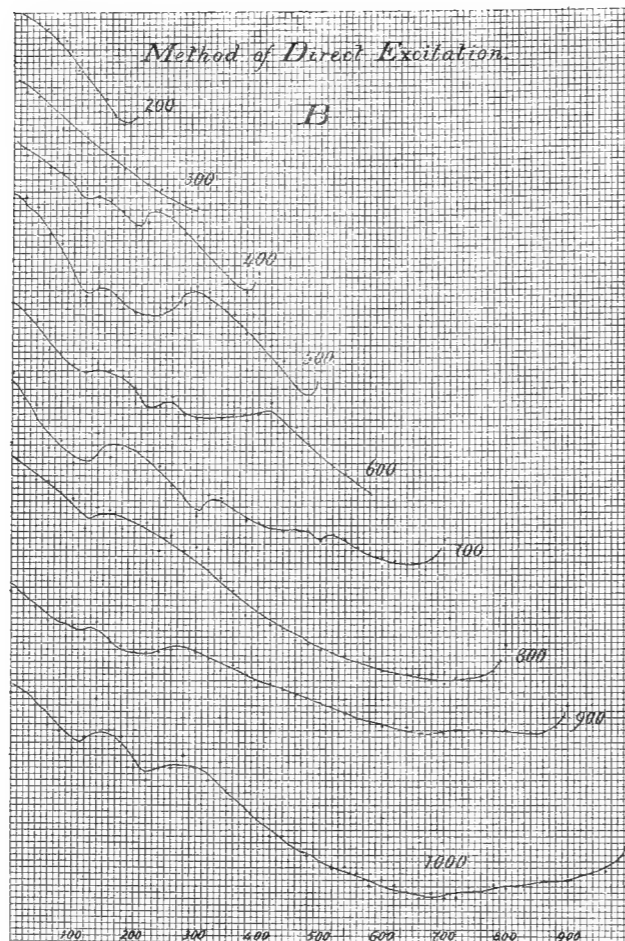

FIG. 13.

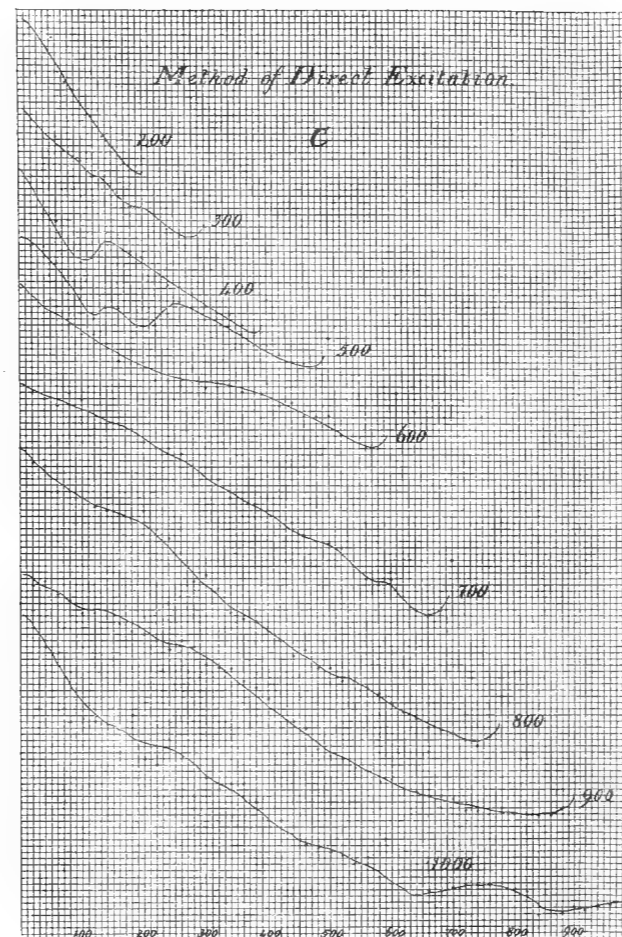

FIG. 14.

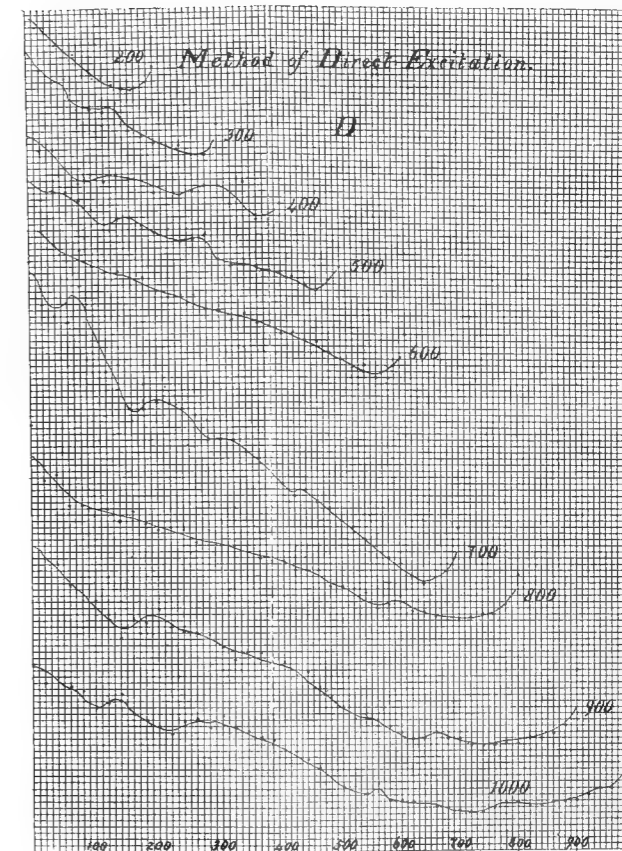
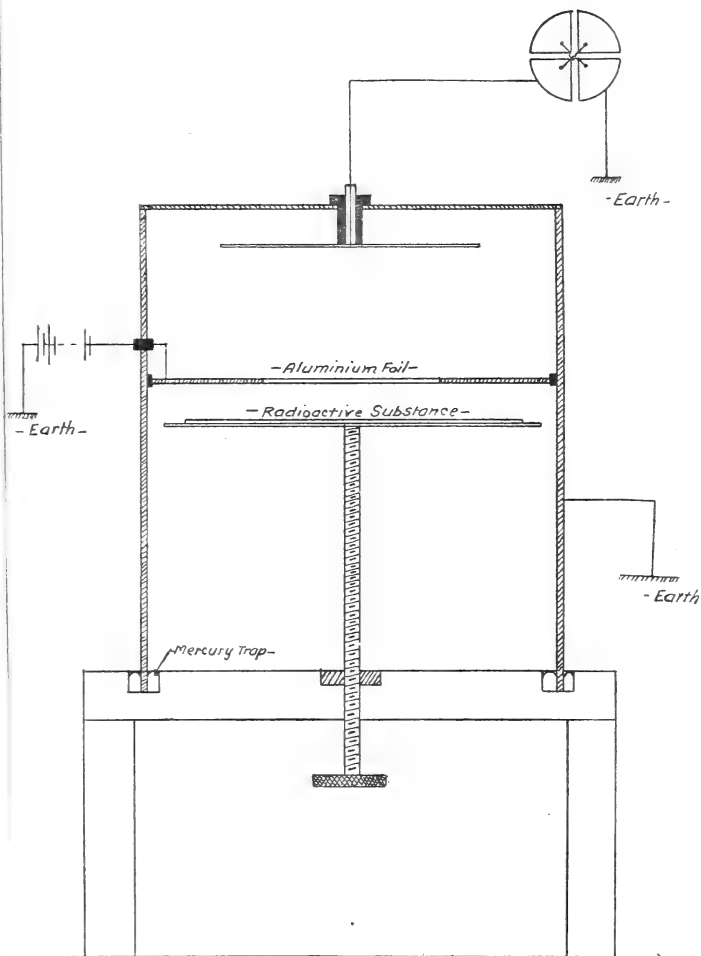



FIG. 8.



Air-absorption Apparatus.



FIG. 1.

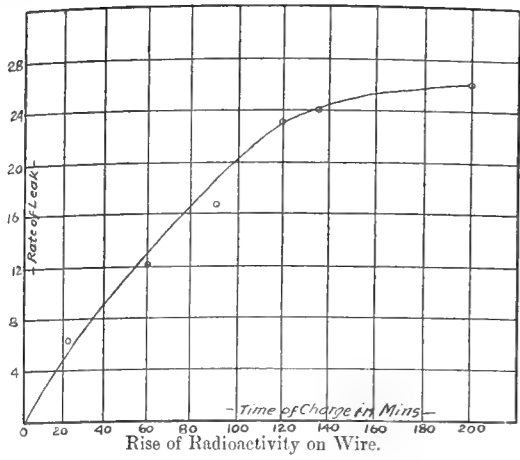

FIG. 2.

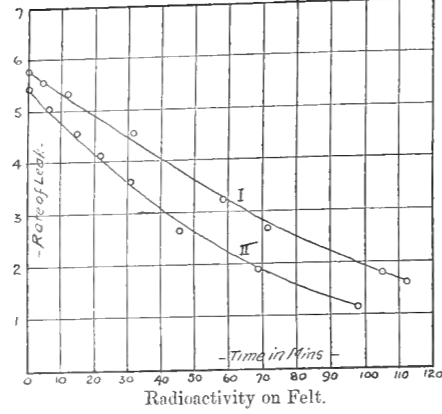

FIG. 3.

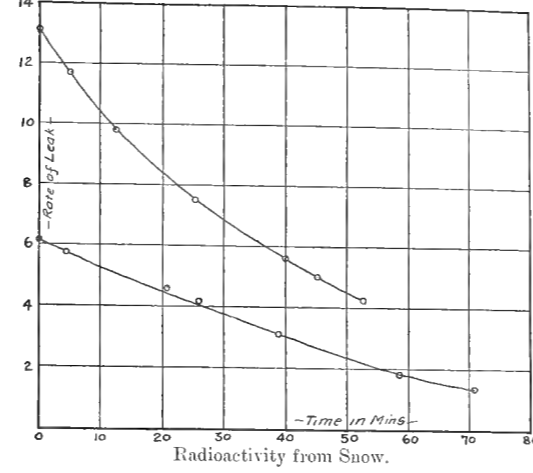

FIG. 4.

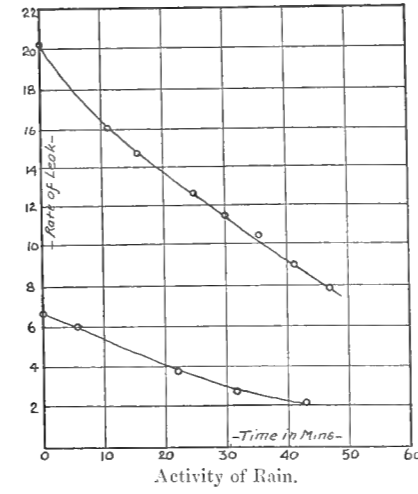
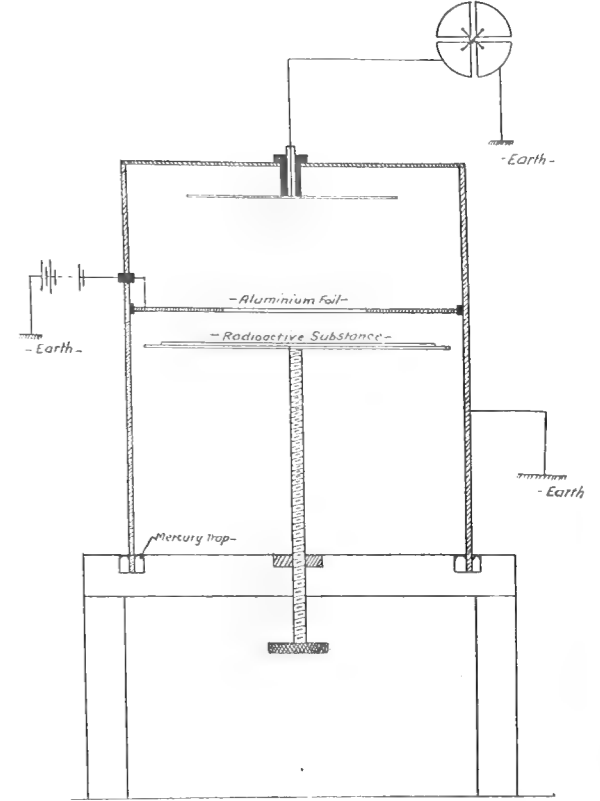

FIG. 8.



Air-absorption Apparatus.

FIG. 5.

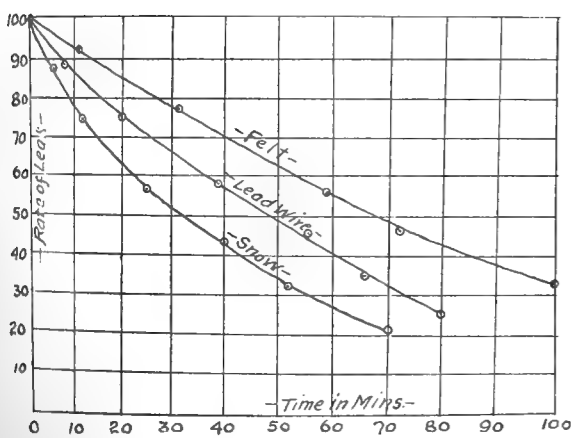

FIG. 6.

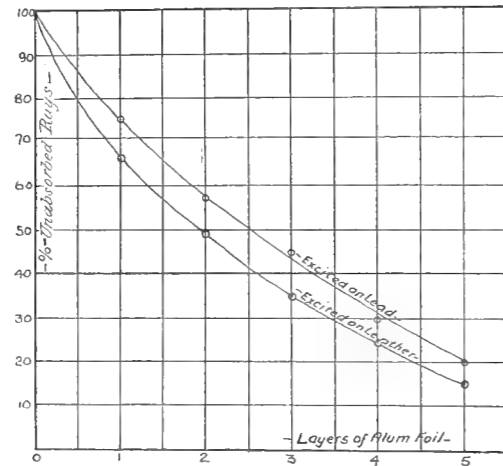

FIG. 7.

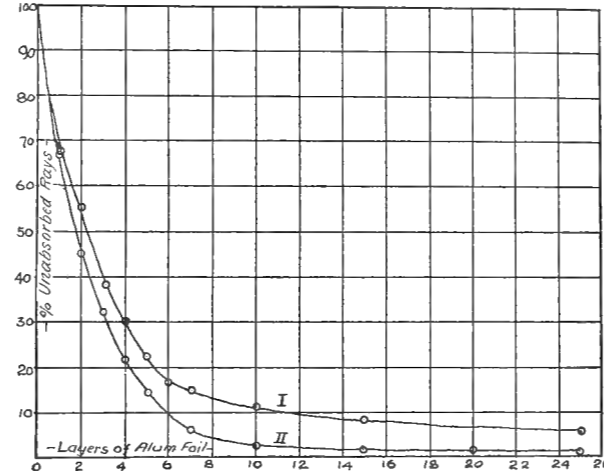

FIG. 9.

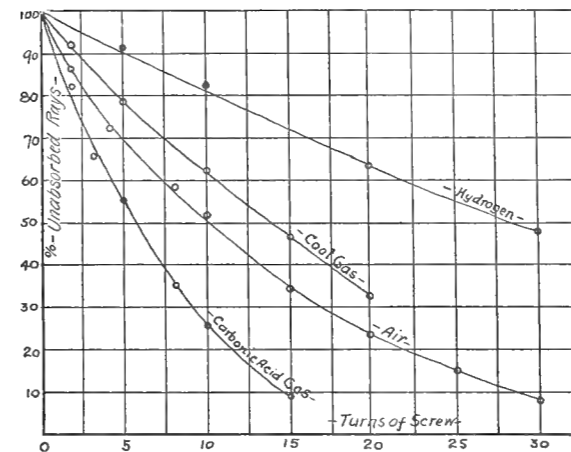



FIG. 1.

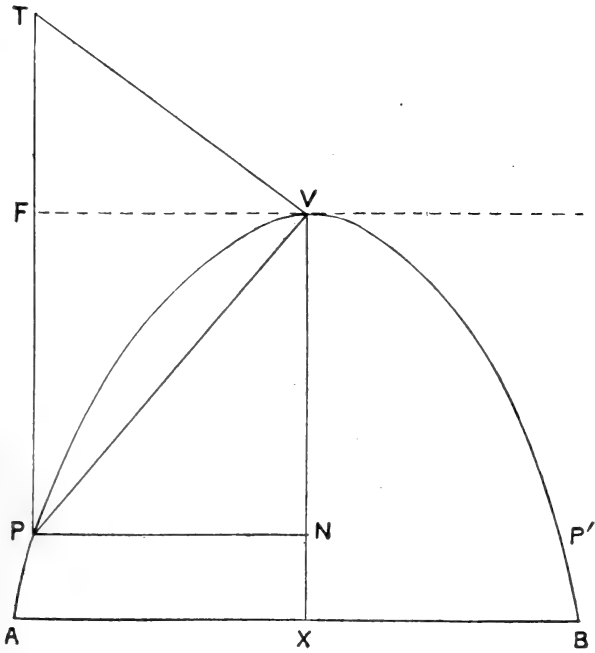
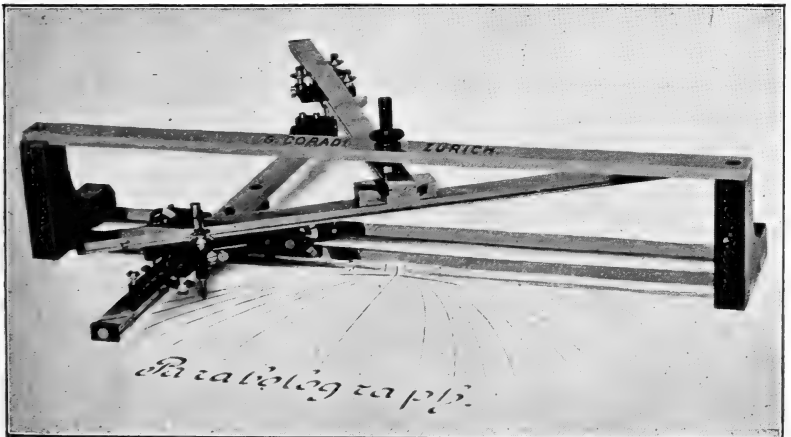
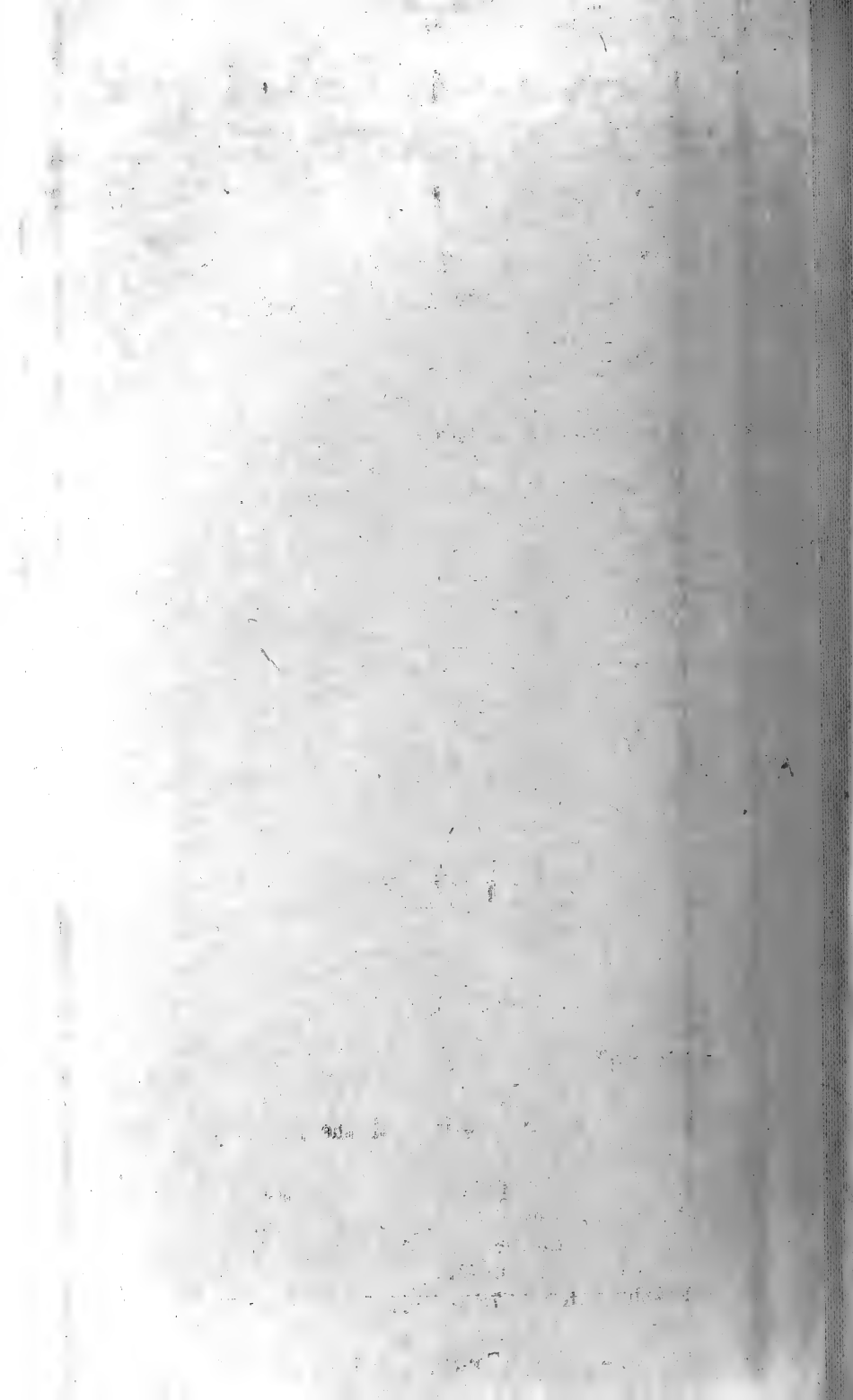

FIG. 2.





pressure by means of another stopcock K which it carried. When this was done, K was closed, and after the pressure p_0

Fig. 2.

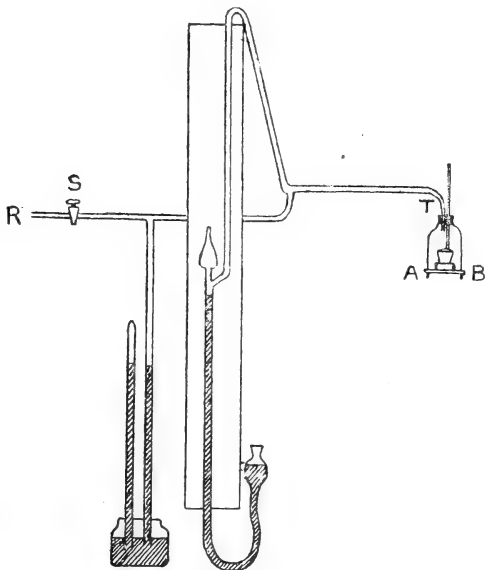

within the volume to be measured had been determined through the manometer, the stopcock S was opened. The pressure then rose, say, to p . Then the volume sought was (Π denoting atmospheric pressure) $\frac{\Pi - p}{p - p_0}$ times the volume of the bulb, by Boyle's and Avogadro's laws. The volume of the bulb was found by filling it with water and weighing the water. In this way the required volume of the apparatus cut off by the stopcocks was found with sufficient accuracy to be 570 c.c. In order to test the effect of the passage through the mixed gases of small currents unattended by sparking, the upper plate ZN was put in metallic connexion with an electrometer. AB was then charged to any required potential by connecting it to the positive end of a battery, the negative end of which was earthed. Meanwhile, of course, ZN and the electrometer were earthed. After the electric force between the plates was established, the quadrants connected to ZN were insulated, and the electrometer gave no deflexion until the ultra-violet light was turned on. When the light was started, the magnitude of the current through the gas was exhibited by the motion of the electrometer-needle. Prof. Townsend has shown (*Phil. Mag.* Feb. 1901, and subsequent papers)

how initial conductivities through rarefied gases can be multiplied by increasing the electric force, owing to the formation of ions by the collision chiefly of the negative ions with the molecules of the gases.

By an application of these methods, for any small pressure of the hydrogen and oxygen, the potential of AB could be brought as near the sparking potential as possible. Moreover the passage of small sparks could be detected by the electrometer, even when they were invisible by daylight.

The result of the first series of experiments on the effect of currents previous to sparking is a negative one.

No perceptible combination was observed to take place without the passage of a spark, however near the potential of the lower plate was to the sparking potential. Thus previous to sparking, neither electric force nor ultra-violet light, nor the currents due to their joint action when ionization by collision takes place, had any measurable effect in the way of combining hydrogen and oxygen at small pressures. But directly a spark passed, a small measurable fall of pressure occurred.

These results being established, the electrometer was discarded for the remaining experiments by which it was proposed, if possible, to determine the connexion between the fall of pressure and the current. The electrical connexions in the new arrangement are indicated by the diagram of fig. 3.

Fig. 3.

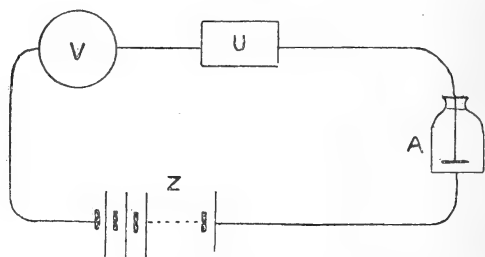

A is the bell-jar, U a resistance-box, Z a battery of about 1000 volts, and V a voltmeter. The last was made on the principle of the D'Arsonval galvanometer, and so could be used equally well as an ammeter. It was specially constructed by Messrs. Nalder & Thompson with a high resistance (38,000 ohms), and it was graduated up to 200 volts. Thus currents of the order $\frac{1}{400}$ ampere could be read accurately and quickly, for the instrument was dead-beat. Its reading was generally over 100, so that the error involved in determining the current passed through was a small one.

Preliminary experiments seemed to show that the fall of pressure is for a given pressure proportional to the quantity of electricity passed through hydrogen and oxygen, in other words that the chemical effect depends on the product of the current by the time, when the pressure is constant; but it is different for different pressures. This being so, the following methods were adopted for all the experiments the results of which are given.

Hydrogen and oxygen were prepared in the equivalent proportions of two volumes to one. This was done by passing a current through a solution of caustic potash contained in a U-tube, one end of which was exposed to atmospheric pressure, for a certain small time, and then reversing the current and passing it through the solution for the same time as before. The mixed gases were passed through drying-tubes into the apparatus, and when the pressure had been reduced to a suitable small pressure within the range of the McLeod gauge, the stopcock S (fig. 2) was turned. The pressure was then carefully read. Let this be p_0 in mm. A current attended by a glow was then passed through the gas for several seconds, usually 30 or 60. This current was nearly always remarkably steady, and so the quantity passed through was accurately known. Let this be ΔQ coulombs. The pressure was again carefully measured. Let it be p_1 mm. Let Δp represent the fall of pressure in millimetres, and let p be the mean pressure, during the passage of the electricity.

$$\begin{aligned} \text{Then} \quad \Delta p &= p_0 - p_1 \\ p &= \frac{p_0 + p_1}{2}. \end{aligned}$$

It was found that p_1 could be read immediately after the current was stopped, for only a small additional fall of pressure was observed by reading the pressure again after a long interval. In this way, corresponding to the mean pressure p , the value of $\Delta p/\Delta Q$ was obtained.

In the next experiment p_1 takes the place of p_0 in the previous one, and the same course is followed. This process could be continued until nearly all the hydrogen and oxygen had disappeared. There was therefore no doubt that the effects observed were wholly or chiefly due to the formation of water-vapour, and not to the formation of ozone or to the disappearance of oxygen at the electrodes.

When the pressure was too low to permit accurate observations, the series of experiments was completed. Another series began with the introduction of fresh gases prepared as before, and it continued as before until the gas was more or

less exhausted. In this way seven distinct series of experiments were carried out, for each of which fresh hydrogen and oxygen were prepared.

Owing to the method of preparing the gas, certain small inequalities were inevitable. It is clear that as the gas becomes exhausted these departures from the proper chemical proportion of two volumes to one will become emphasized. For example, if originally there is a deficiency of 3 per cent. in oxygen, when half the gas is gone there will be a deficiency of 6 per cent. Therefore, after a time, experiments on this plan may cease to give accurate results, and only the first few of each series can be relied on.

Of course $\frac{\Delta p}{\Delta Q}$ must be a function of Δp so long as Δp is large; and it only ceases to involve Δp when Δp is small, for then

$$\frac{\Delta p}{\Delta Q} = - \frac{dp}{dQ}.$$

For this reason it seemed necessary to have Δp as small as was consistent with its sufficiently accurate determination. The values of the mean pressures p in millimetres were taken as abscissas, and $\frac{\Delta p}{\Delta Q}$ were taken as ordinates, and the results were plotted on squared paper. It was found, however, that though the points thus determined suggested a mean curve and proved that $\frac{\Delta p}{\Delta Q}$ depends on p , they failed to give any conclusive result since the variation from the mean curve was sometimes about 10 per cent.

But when the potential-difference of the plates (which may be called X) during the passage of the current is divided by p and taken as abscissa and $\frac{1}{p} \frac{\Delta p}{\Delta Q}$ as ordinate, these discordances disappear, and the points so determined approximate to a curve within the limits of expected errors of observation.

The following seven tables give the results of the experiments.

ΔQ = the quantity of electricity passed, in coulombs.

p = the mean pressure in mm. during the passage of ΔQ .

Δp = the fall of pressure in mm.

X = the potential-difference between the parallel plates, whose distance apart was 0.97 cm., as calculated by Ohm's law.

In addition, the values of $\frac{\Delta p}{\Delta Q}$, $\frac{X}{p}$, $\frac{\Delta p}{p\Delta Q}$ are also given. Each table refers to a fresh mixture of the gases.

TABLE I.

| ΔQ . | p . | Δp . | $\Delta p/\Delta Q$. | X. | X/p . | $\Delta p/p\Delta Q$. |
|--------------|-------|--------------|-----------------------|-----|---------|------------------------|
| ·154 | 3·75 | ·53 | 3·46 | 410 | 109 | ·92 |
| ·098 | 3·32 | ·32 | 3·27 | 423 | 128 | ·99 |
| ·097 | 3·0 | ·28 | 2·88 | 425 | 141 | ·96 |

TABLE II.

| | | | | | | |
|-------|------|------|------|-----|-----|-----|
| ·058 | 6·3 | ·28 | 4·83 | 500 | 80 | ·77 |
| ·117 | 5·9 | ·525 | 4·5 | 495 | 84 | ·76 |
| ·075 | 5·47 | ·303 | 4·05 | 418 | 77 | ·74 |
| ·297 | 4·76 | ·114 | 3·75 | 422 | 89 | ·79 |
| ·145 | 3·97 | ·49 | 3·4 | 430 | 108 | ·86 |
| ·0727 | 3·59 | ·246 | 3·4 | 430 | 120 | ·95 |
| ·0727 | 3·36 | ·23 | 3·17 | 430 | 128 | ·94 |

TABLE III.

| | | | | | | |
|------|------|------|------|-----|-----|------|
| ·084 | 2·57 | ·242 | 2·88 | 412 | 160 | 1·12 |
| ·087 | 2·33 | ·232 | 2·67 | 406 | 174 | 1·14 |
| ·081 | 2·11 | ·211 | 2·62 | 416 | 197 | 1·24 |
| ·077 | 1·91 | ·18 | 2·35 | 421 | 220 | 1·23 |
| ·074 | 1·74 | ·156 | 2·1 | 425 | 244 | 1·21 |
| ·073 | 1·59 | ·156 | 2·15 | 427 | 268 | 1·35 |
| ·077 | 1·43 | ·156 | 2·01 | 420 | 294 | 1·4 |

TABLE IV.

| | | | | | | |
|------|------|------|------|-----|------|-----|
| ·118 | 4·27 | ·397 | 3·36 | 385 | 90·5 | ·71 |
| ·116 | 3·89 | ·369 | 3·16 | 392 | 101 | ·81 |
| ·114 | 3·53 | ·357 | 3·13 | 400 | 113 | ·89 |
| ·113 | 3·18 | ·332 | 2·94 | 408 | 128 | ·92 |

TABLE V.

| | | | | | | |
|------|------|------|------|-----|----|-----|
| ·12 | 6·5 | ·53 | 4·4 | 416 | 64 | ·68 |
| ·122 | 5·95 | ·49 | 4·0 | 409 | 69 | ·68 |
| ·12 | 5·5 | ·476 | 3·97 | 416 | 76 | ·73 |
| ·118 | 5·2 | ·45 | 3·8 | 426 | 82 | ·74 |
| ·118 | 4·6 | ·44 | 3·7 | 426 | 93 | ·81 |

TABLE VI.

| $\Delta Q.$ | $p.$ | $\Delta p.$ | $\Delta p/\Delta Q.$ | $X.$ | $Xp.$ | $\Delta p/p\Delta Q.$ |
|-------------|------|-------------|----------------------|------|-------|-----------------------|
| .246 | 3.25 | .74 | 3.0 | 401 | 123 | .92 |
| .12 | 2.7 | .33 | 2.76 | 416 | 154 | 1.02 |
| .118 | 2.4 | .303 | 2.6 | 424 | 176 | 1.08 |
| .238 | 1.97 | .56 | 2.34 | 420 | 214 | 1.19 |
| .236 | 1.45 | .49 | 2.08 | 414 | 288 | 1.43 |

TABLE VII.

| | | | | | | |
|------|------|-----|------|-----|-----|------|
| .129 | 2.9 | .36 | 2.76 | 376 | 129 | .95 |
| .126 | 2.53 | .35 | 2.8 | 386 | 151 | 1.09 |
| .123 | 2.24 | .31 | 2.54 | 401 | 179 | 1.13 |
| .242 | 1.8 | .53 | 2.2 | 412 | 228 | 1.22 |

The tables are illustrated by the curve (fig. 4), and the points lying near it or on it.

Fig. 4.

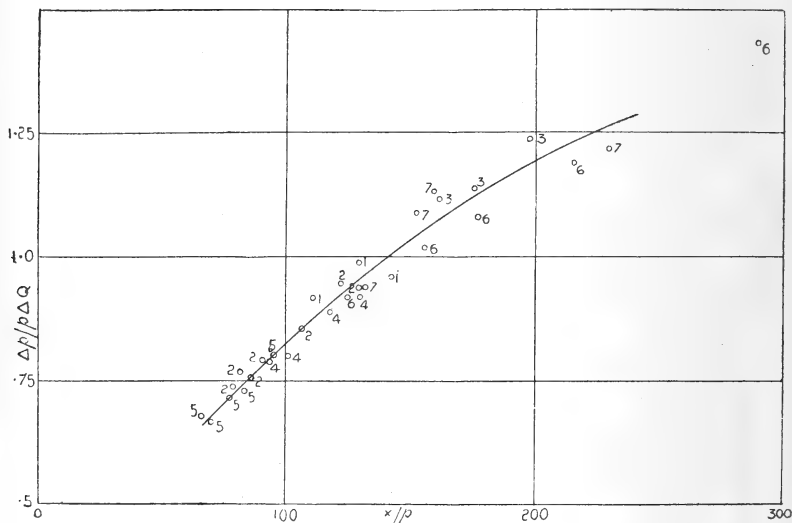

The abscissas are the values of $\frac{X}{p}$, and the ordinates the corresponding values of $\frac{1}{p} \frac{\Delta p}{\Delta Q}$. The numbers attached to the points indicate the table from which these values are taken.

These results show that $\frac{1}{p} \frac{\Delta p}{\Delta Q}$ is a function of $\frac{X}{p}$.

We conclude that, for the range of X and p indicated by

the tables,
$$-\frac{dp}{dQ} = pf\left(\frac{N}{p}\right) \dots \dots \dots (1)$$

Before proceeding, it is necessary to find an expression for the number of molecules of water, the formation of which is associated with the passage to the electrodes of each pair of ions.

Let N be the number of molecules in a c.c. of gas at 760 mm. pressure. Let $\lambda_p = -\frac{dp}{dQ}$ the fall of pressure per coulomb passed; so that λ_p is nearly equal to $\frac{\Delta p}{\Delta Q}$, varying with p .

Then the number of molecules of hydrogen and oxygen lost per coulomb is, since the capacity of the apparatus was 570 c.c.,

$$\frac{N \times 570}{760} \lambda_p, \text{ or } \frac{3N}{4} \lambda_p.$$

Let e be the charge in electrostatic units on an ion. Then from experiments on the diffusion of ions (J.S. Townsend, Phil. Trans. 1899),

$$Ne = 1.2 \times 10^{10}.$$

Now one coulomb is equal to 3×10^9 electrostatic units. Therefore when one coulomb passes round the circuit, the number of negative ions which reach the anode (or of positive ions which reach the cathode) is

$$\frac{3 \times 10^9}{e}$$

which

$$= \frac{3 \times 10^9 \times N}{Ne} = \frac{3 \times 10^9 \times N}{1.2 \times 10^{10}} = \frac{N}{4}.$$

Therefore, when the pressure is p mm. it follows that the arrival of $\frac{N}{4}$ negative ions at the anode involves the disappearance of $\frac{3N}{4} \lambda_p$ molecules of hydrogen and oxygen.

That is, the passage of each negative ion to the anode is accompanied by the formation of

$$2\lambda_p$$

molecules of water.

On referring to the Table VII., by way of illustration, it will be found that $\frac{\Delta p}{\Delta Q} = 2.2$ when $p = 1.8$, this being one of the lowest pressures recorded in the tables.

Therefore, as each pair of ions reached the electrodes at this pressure, 4.4 molecules of water were formed.

Next, on taking the highest recorded pressure 6.5 (Table V.), it will be found that 8.8 molecules of water were formed as each pair of ions reached the electrodes. And on all

occasions recorded above, more molecules of water were formed than pairs of ions.

Now let W_p denote the number of molecules of water formed for the passage of each pair of ions to the electrodes. Then

$$W_p = -2 \frac{dp}{dQ}.$$

Therefore by equation (1),

$$\frac{1}{p} W_p = 2f\left(\frac{X}{p}\right), \dots \dots \dots (2)$$

where $f\left(\frac{X}{p}\right)$ is the ordinate corresponding to the abscissa $\frac{X}{p}$ of the curve given above.

If the force were uniform between the plates, X might be taken as the force, since the plates were .97 cm. apart. And then equation (2) would strongly support the view that the formation of water is attributable to the collisions with the neutral molecules of the mixed gas of the ions as they move to the electrodes. The simplest hypothesis would be that the ions by collision separate the neutral molecules of oxygen into uncharged atoms, and that the latter then combine with the neutral molecules of hydrogen.

But one is prevented from basing these views on equation (2), by the large and uncertain departure from uniform intensity which the electric force makes near the cathode. Moreover, the range of variation of the potential X was not large enough to prove the validity of equation (2) except for a very restricted variation of X (see the tables above). But further experiments will shortly be made with the view of deciding this and other points.

During these experiments the phenomena do not appear to be complicated by the effects of the heat set free by the chemical union of hydrogen and oxygen, although this seems to play such an important part at pressures of a higher order.

The elimination of these effects at low pressure may be explained by the hypothesis that the energy set free by the formation of a molecule of water is radiated as well as conducted through the gas. For the intensity of such radiation would be proportional to the inverse square of the distance from the molecule of water, and the radiation would have no effect on the neighbouring molecules of oxygen and hydrogen unless they were within a certain distance of the molecule of water which was formed. When the pressure of the gases is reduced below some critical value, the probability of the reactions taking place would be extremely small.

I wish to express my thanks to Professor Townsend who suggested this investigation. I am greatly indebted to him for his suggestions and criticisms.

XXII. EDITORIAL NOTE.

I HAVE received from Lord Blythswood a letter of date Jan. 23, with a specimen of cambric rendered thoroughly brittle or rotten by exposure for about three days to radium bromide. He had put a little circle of cambric in place of the circular sheet of mica which is commonly used to cover the cavity containing radium bromide in the little receptacle in which it is usually sold. The cambric is quite broken away, leaving an irregularly shaped hole of about 3 mm. greatest diameter in the place which was directly exposed to the radium. This is certainly a very interesting and, I believe, important discovery. Lord Blythswood found the same result in several other trials with exposures of two or three days.

KELVIN.

Largs, Jan. 26, 1904.

XXIII. *Notices respecting New Books.*

A Handbook for the Electrical Laboratory and Testing Room.
Vol. II. By J. A. FLEMING, M.A., D.Sc., F.R.S. London:
"The Electrician" Printing and Publishing Company, Limited.
1903. Pp. viii + 622.

NOTHING could better illustrate Dr. Fleming's tremendous activity as a writer of text-books than the appearance of this second volume of his 'Handbook' within something like a year from the date of publication of Vol. I. The compilation of this second volume must have involved a very large amount of labour, and the very full references to original sources show that the author has spared no pains to make his treatise of as encyclopædic a nature as possible.

The book is divided into five chapters. In Chapter I. we have an account of the measurement of electric quantity and energy. We are heartily glad to see Dr. Fleming's strong condemnation of ballistic galvanometers of the needle type. In connexion with the damping correction of a ballistic galvanometer, attention may be drawn to the extremely clumsy form, sanctioned, no doubt, by long usage, in which this correction is applied. We are sorry to see the time-honoured treatment reproduced by Dr. Fleming. The student is told, by teachers and text-books alike, to find the "logarithmic decrement" λ of the galvanometer, and then to correct the "throws" by multiplying them by $1 + \frac{\lambda}{2}$. Now this

mysterious $1 + \frac{\lambda}{2}$ is simply an approximation to $e^{\frac{\lambda}{2}}$, being, in fact,

Phil. Mag. S. 6. Vol. 7. No. 38. Feb. 1904.

R

the first two terms in its expansion. A more correct value consists in taking $e^{\frac{\lambda}{2}}$ itself, and since

$$e^{\frac{\lambda}{2}} = e^{\frac{1}{2} \log \frac{\theta_1}{\theta_2}} = e^{\log \sqrt{\frac{\theta_1}{\theta_2}}} = \sqrt{\theta_1/\theta_2},$$

it is obvious that the correction factor is simply the *square root of the ratio of two consecutive throws*. The advantage of presenting the correction factor in this simple form is that the dullest person can readily be made to understand it; whereas even a quick-witted student frequently finds difficulty in grasping the correction in its "logarithmic decrement" form. In dealing with the methods of standardizing a ballistic galvanometer, no reference is made (in Chapter I.) to the standard solenoid method, although this is fully described, later on, in Chapter IV., where, however, the curious statement is made that when the galvanometer is used with its circuit closed, its constant cannot be found from the throw due to the discharge from a condenser of known capacity. Surely this is quite feasible, provided the proper value be given to the *damping correction for each value of the total resistance of the galvanometer circuit*. A full account of ampere-hour and watt-hour meters is given in Chapter I.; in dealing with the testing of secondary cells, the author does not appear to lay sufficient stress on the uselessness of a single charge and discharge test.

Chapter II. is devoted to the measurement of capacity and inductance, and contains a vast amount of useful information, including a number of approximate formulæ for calculating capacities and inductances in simple cases, and the results of the author's wide experience in the practical measurement of small inductances and capacities.

Chapter III. deals with Photometry. Here again, the author's eminence as an expert in this subject renders the chapter of exceptional value. It is gratifying to see Dr. Fleming's adoption of Blondel's rational system of units, and his condemnation of the use of the term "quantity of light" in the erroneous sense generally attributed to it. In connexion with Rousseau's diagram, explained on p. 321, it may be pointed out that the semi-circle GEF need not be drawn so as "just to touch" the polar curve, but that it may be drawn with any convenient radius. The account of photometers is well up to date, and includes a description of the Matthews integrating photometer.

Chapter IV. contains an account of Magnetic and Iron Testing, and in addition to the usual laboratory methods there is given a description of various commercial forms of magnetic testing apparatus, including several very recent types.

Chapter V. is devoted to the highly important subject of Dynamo, Motor and Transformer Testing. In dealing with the term "efficiency," it appears to us unnecessary to introduce "conversion efficiency," as "electrical" and "commercial" efficiencies appear to be ample for all practical requirements. The assumption under-

lying a number of methods for "separating" the losses, viz., that the frictional torque is independent of the speed, is entirely erroneous, as has been shown by Dettmar's careful investigations on this subject; hence methods based on this assumption must be more or less valueless. Further, it must be remembered that in order to arrive at the normal working value of the frictional torque, the machine must be kept running for at least two or three hours—a fact not even alluded to by Dr. Fleming. We presume that the last chapter of the book was already in the press when Mr. Behrend's important paper on the differential method of testing alternators appeared, as no reference to it is made by the author.

In concluding this brief review of an important contribution to electrical literature, we may say that the present volume bears on it the stamp of the author's exceptional gift of clear exposition, and that it forms most interesting as well as instructive reading for the electrical engineer.

Light Waves and Their Uses. By A. A. MICHELSON. (Being vol. iii. of the Second Series of the Decennial Publications of the University of Chicago.) Chicago: The University of Chicago Press. 1903. Pp. 166. Price \$2.00.

A CLEAR and simple account of the application of interference methods to various physical measurements, written by the leading authority on the subject, is sure to meet with a warm welcome from all students of physical science. There is a singular charm about this first-hand account of the subject, pervaded as it is with the glow of enthusiasm which has animated the author in his extraordinarily difficult and brilliant researches. The book, which is based on a series of eight lectures on "Light Waves and their Uses" delivered by Professor Michelson in the spring of 1899 at the Lowell Institute, is free from mathematical technicalities, and should prove quite intelligible to the general reader.

Le Point Critique des Corps Purs. Par E. MATHIAS, Professeur de Physique à la Faculté des Sciences de l'Université de Toulouse. Paris: C. Naud. 1903. Pp. viii + 255.

AT the Paris International Physical Congress of 1900, Professor Mathias presented a paper on "Methods of Determining the Critical Constants." This paper may be found in Vol. I. of the *Rapports*. The volume now before us is an expansion of the article in the *Rapports*, with important modifications and additions, and forms a most complete and useful monograph on what must be regarded as a somewhat neglected branch of science.

The book is divided into ten chapters. The first chapter gives an account of Andrews' classical theory. Chapter II. deals with what the author terms the phenomenon of Cagniard-Latour, which consists in the disappearance of the meniscus separating the gaseous from the liquid phase at a temperature below the critical temperature.

Chapters III., IV. and V. contain a very complete critical account of the experimental methods which may be employed for determining either all three, two or one critical constants. In Chapter VI. are given theoretical or indirect methods of inferring the values of the critical constants from certain other experimentally determined properties of the substance. Chapter VII. contains a complete table of the critical constants of 165 pure substances. The three concluding Chapters, VIII.-X., deal with some of the recently advanced views and theories regarding the relation of the liquid to the gaseous phase, notably those of de Heen and Traube.

The book forms a most valuable contribution to physical literature, and should become a standard work of reference.

Ausgewählte Methoden der Analytischen Chemie. Von Prof. Dr. A. CLASSEN. Zweiter Band. *Unter Mitwirkung von H. CLOEREN.* Mit 133 Abbildungen und Zwei Spectraltafeln. Braunschweig: F. Vieweg und Sohn. 1903. Pp. xvi+830.

WE had recently occasion to commend to the notice of analytical chemists the first volume of this comprehensive treatise. The second volume, which follows the first after a comparatively short interval, fully maintains the high standard of excellence set up by its predecessor. It deals with the non-metallic elements, and contains a short section devoted to elementary organic analysis. All the more modern methods are fully described, and the special forms of apparatus used are beautifully illustrated. No analytical chemist who is desirous of availing himself of the best of modern methods can afford to be without this valuable work of reference.

Annuaire pour l'an 1904, publié par le Bureau des Longitudes. Avec des Notices scientifiques. Paris: Gauthier-Villars. Pp. 732+120. Pris 1 fr., 50.

IN addition to the usual tables of constants, the *Annuaire* for the current year contains two specially contributed articles, one of which, by M. Bouquet de la Grye, deals with the results of the International Conference on Geodesy held at Copenhagen in August, 1903; while the other, by M. P. Hatte, is "An Elementary Explanation of the Tides." This latter article is specially noteworthy, and should strongly appeal to all who can appreciate the beauty of a simple and elegant treatment of a highly complicated subject.

WE regret to announce the death of Dr. WILLIAM FRANCIS, for many years one of the Editors of this Magazine, which took place on the 19th January. A short notice will appear next month.

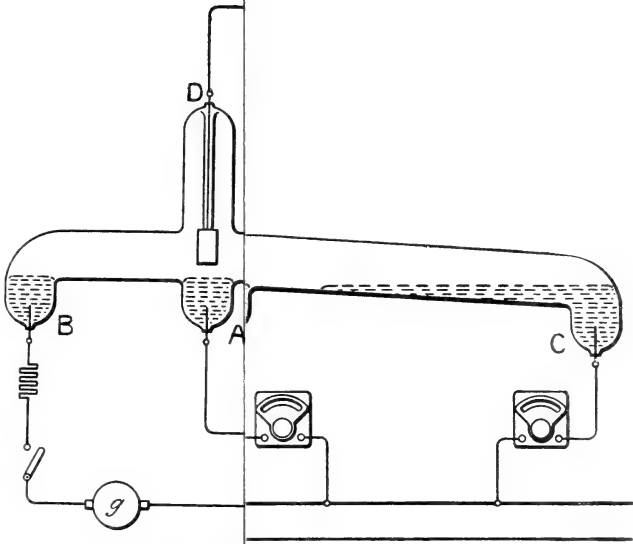

FIG. 4.

FIG. 6.



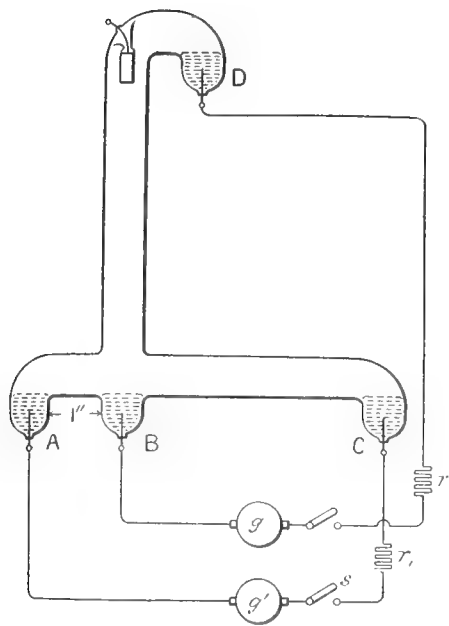

FIG. 1.

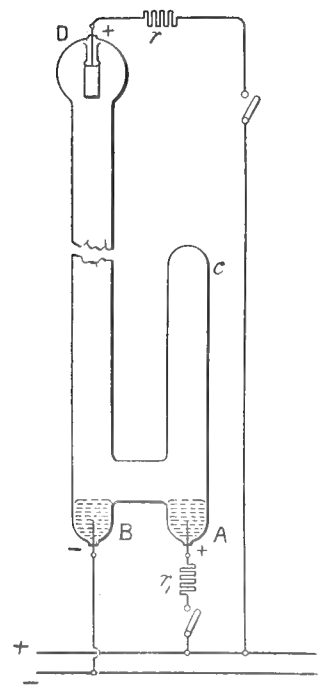

FIG. 2.

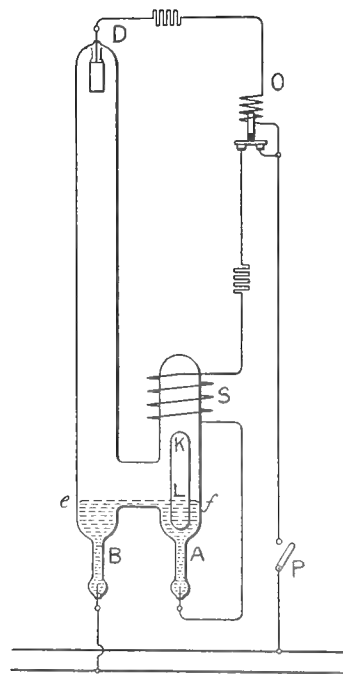

FIG. 3.

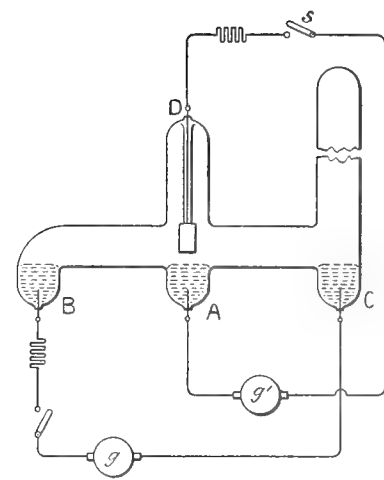

FIG. 4.

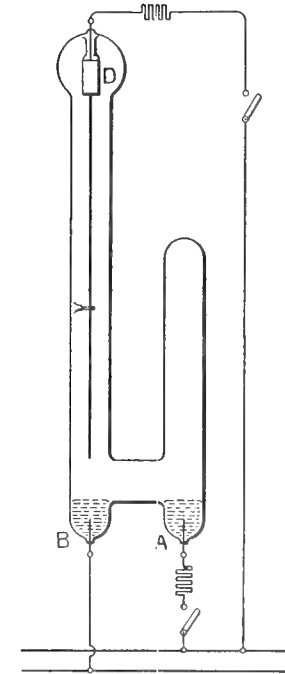

FIG. 5.

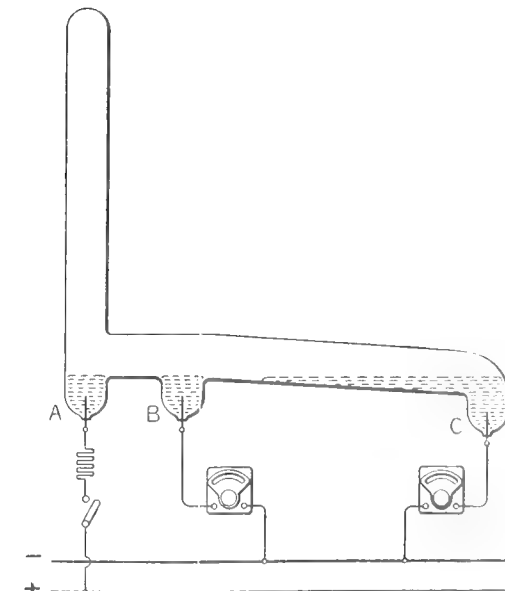

FIG. 6.

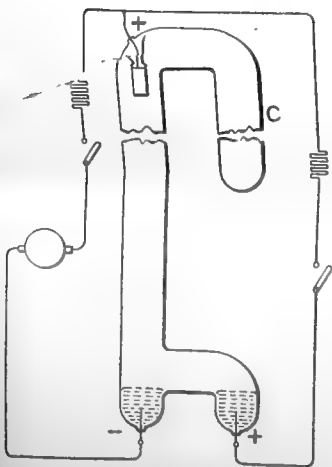

FIG. 7.



FIG. 8.

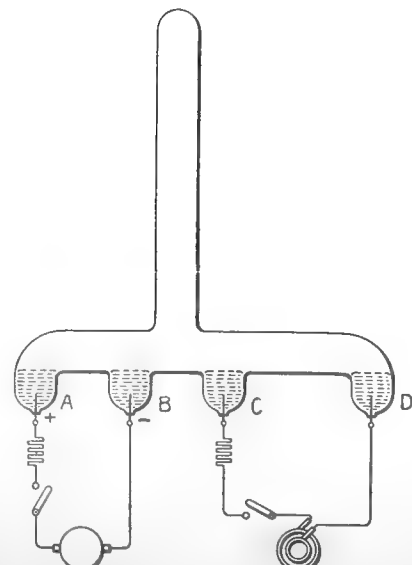

FIG. 9.

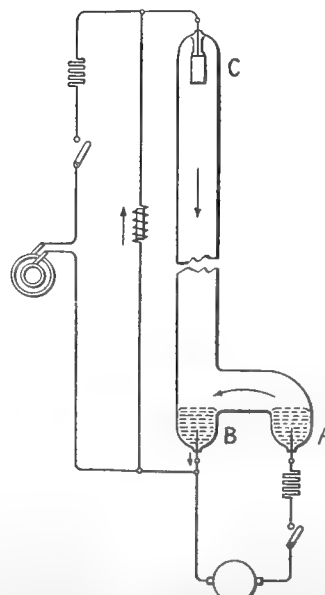

FIG. 10.

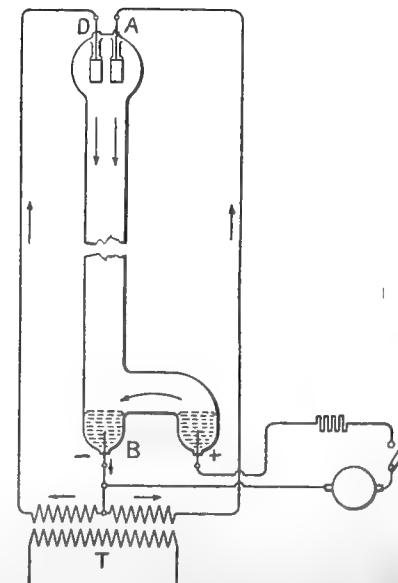

FIG. 11.

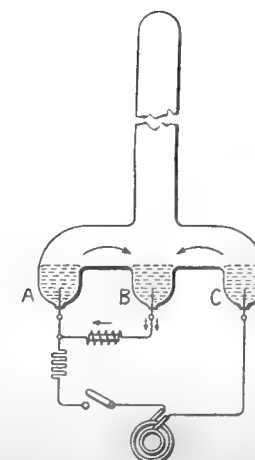

FIG. 12.

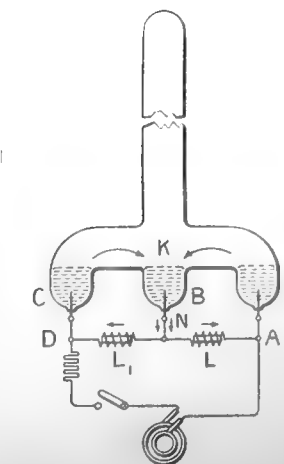
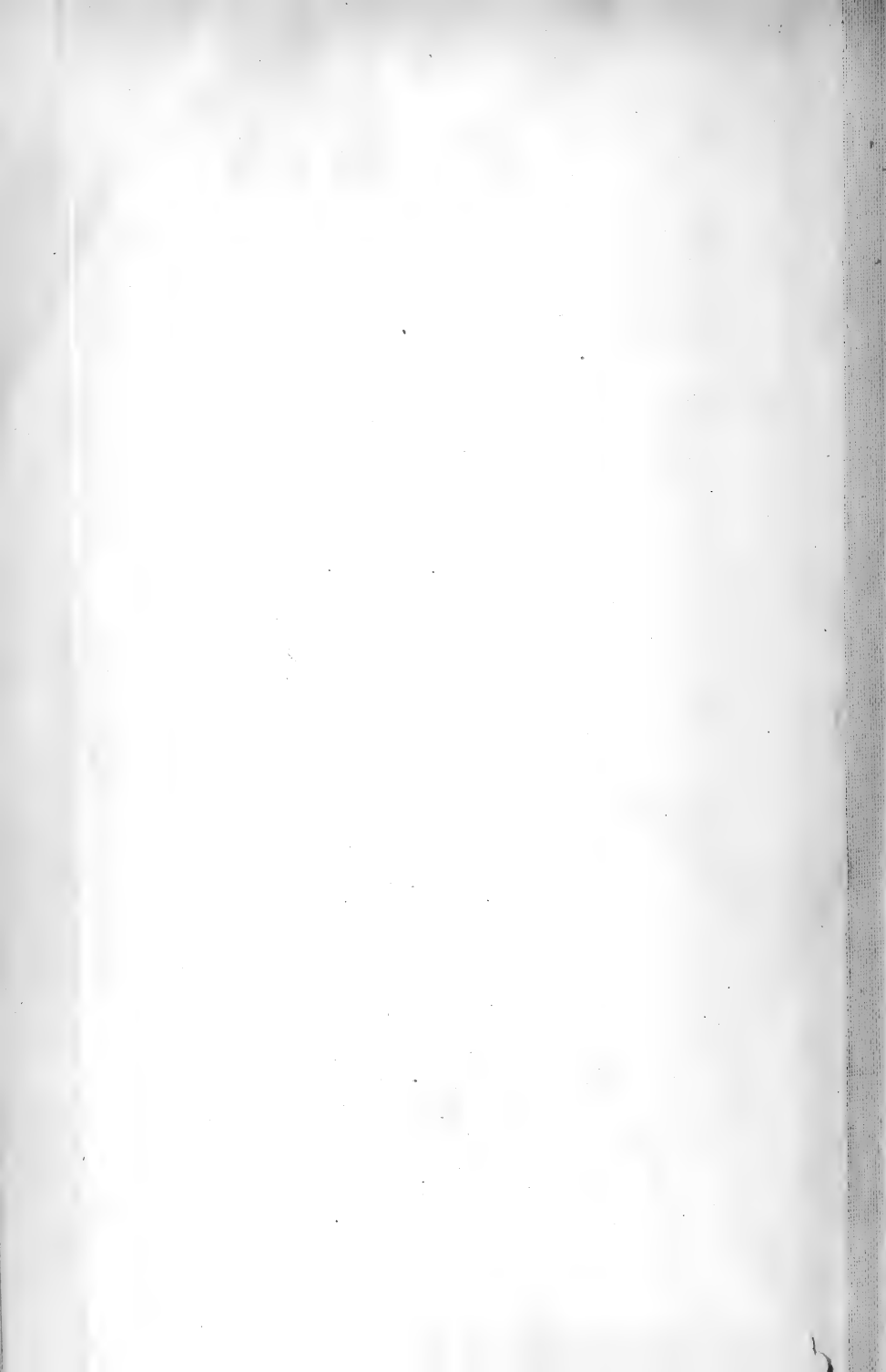

FIG. 13.



INDEXED.

THE
LONDON, EDINBURGH, AND DUBLIN
PHILOSOPHICAL MAGAZINE
AND
JOURNAL OF SCIENCE.

[SIXTH SERIES.]

MARCH 1904.

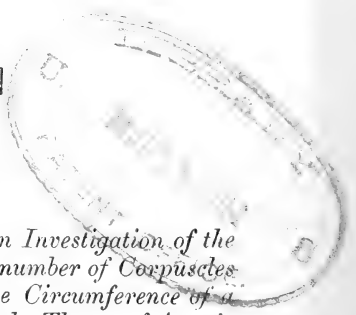

XXIV. *On the Structure of the Atom: an Investigation of the Stability and Periods of Oscillation of a number of Corpuscles arranged at equal intervals around the Circumference of a Circle; with Application of the results to the Theory of Atomic Structure.* By J. J. THOMSON, F.R.S., Cavendish Professor of Experimental Physics, Cambridge*.

THE view that the atoms of the elements consist of a number of negatively electrified corpuscles enclosed in a sphere of uniform positive electrification, suggests, among other interesting mathematical problems, the one discussed in this paper, that of the motion of a ring of n negatively electrified particles placed inside a uniformly electrified sphere. Suppose when in equilibrium the n corpuscles are arranged at equal angular intervals round the circumference of a circle of radius a , each corpuscle carrying a charge e of negative electricity. Let the charge of positive electricity contained within the sphere be ve , then if b is the radius of this sphere, the radial attraction on a corpuscle due to the positive electrification is equal to ve^2a/b^3 ; if the corpuscles are at rest this attraction must be balanced by the repulsion exerted by the other corpuscles. Now the repulsion along OA, O being the centre of the sphere, exerted on a corpuscle at A by one at B, is equal to $\frac{e^2}{AB^2} \cos OAB$, and, if $OA = OB$,

this is equal to $\frac{e^2}{4OA^2 \sin^2 \frac{1}{2}AOB}$: hence, if we have n corpuscles arranged at equal angular intervals $2\pi/n$ round the circumference of a circle, the radial repulsion on one corpuscle

* Communicated by the Author.

due to the other $(n-1)$ is equal to

$$\frac{e^2}{4a^2} \left(\operatorname{cosec} \frac{\pi}{n} + \operatorname{cosec} \frac{2\pi}{n} + \operatorname{cosec} \frac{3\pi}{n} + \dots + \operatorname{cosec} \frac{(n-1)\pi}{n} \right).$$

If the corpuscles are at rest this must be equal to the radial attraction. Hence, if

$$S_n = \operatorname{cosec} \frac{\pi}{n} + \operatorname{cosec} \frac{2\pi}{n} + \dots + \operatorname{cosec} \frac{(n-1)\pi}{n},$$

$$\frac{\nu e^2 a}{b^3} = \frac{e^2}{4a^2} S_n,$$

or
$$\frac{a^3}{\bar{b}^3} = \frac{S_n}{4\nu} \dots \dots \dots (1)$$

The following are the values of S_n from $n=2$ to $n=6$.

$$S_2=1, S_3=2.3094, S_4=3.8284, S_5=5.5056, S_6=7.3094.$$

In the important case when $\nu=n$, *i. e.* when the positive charge on the sphere is equal to the sum of all the negative charges in the ring of corpuscles, we get by (1) the following values for a/b :—

| $n.$ | $\frac{a}{\bar{b}}$ |
|------|---------------------|
| 2 | 5 |
| 3 | 5.7773 |
| 4 | 6.208 |
| 5 | 6.505 |
| 6 | 6.726 |

If the ring of corpuscles, instead of being at rest, is rotating with an angular velocity ω , the condition for steady motion is

$$\frac{\nu e^2 a}{b^3} = m a \omega^2 + \frac{e^2}{4a^2} S_n,$$

or
$$\frac{\nu a^3}{\bar{b}^3} = \frac{m}{e^2} \omega^2 + \frac{S_n}{4};$$

here m is the mass of a corpuscle.

We shall now proceed to find the forces acting on a corpuscle when the corpuscles are slightly displaced from their positions of equilibrium. Let the position of the corpuscles be fixed by the polar coordinates r and θ in the plane of the undisturbed orbit, and by the displacement z at right angles to this plane; let r_s, θ_s, z_s be the coordinates of the s th corpuscle; then, since the corpuscles are but slightly displaced from their positions of equilibrium, $r_s = a + \rho_s$, where ρ_s is small compared with a , z_s is also small compared with a , and $\theta_s - \theta_{s-1} = \frac{2\pi}{n} + \phi_s - \phi_{s-1}$, where n is the number of corpuscles and the ϕ 's are small quantities.

The radial repulsion exerted by the *s*th corpuscle on the *p*th is equal to

$$-e^2 \frac{d}{dr_p} \frac{1}{(r_p^2 + r_s^2 - 2r_p r_s \cos(\theta_s - \theta_p) + (z_p - z_s)^2)^{\frac{3}{2}}};$$

expanding this, retaining only the first powers of ρ , ϕ , and z , we find that if R_{ps} is this repulsion

$$R_{ps} = \frac{e^2}{4a^2 \sin \psi} \left\{ 1 - \frac{\rho_p}{a} \left(\frac{3}{2} - \frac{1}{2 \sin^2 \psi} \right) - \frac{\rho_s}{a} \left(\frac{1}{2} + \frac{1}{2 \sin^2 \psi} \right) - \frac{1}{2} (\phi_s - \phi_p) \cot \psi \right\},$$

where $\psi = (p-s) \frac{\pi}{n}$.

The tangential force Θ_{ps} tending to increase θ_p is equal to

$$- \frac{e^2}{r_p d\theta_p} \frac{1}{\{ r_p^2 + r_s^2 - 2r_p r_s \cos(\theta_s - \theta_p) + (z_p - z_s)^2 \}^{\frac{3}{2}}};$$

expanding this and retaining only the first powers of the small quantities, we get

$$\Theta_{ps} = - \frac{e^2 \cos \psi}{4a^2 \sin^2 \psi} \left\{ 1 - \frac{3}{2} \frac{\rho_p}{a} - \frac{1}{2} \frac{\rho_s}{a} - (\phi_s - \phi_p) (\cot \psi + \frac{1}{2} \tan \psi) \right\}.$$

Z_{ps} , the force at right angles to the undisturbed plane of the orbit, is easily seen to be given by the equation

$$Z_{ps} = \frac{e^2}{8a^3 \sin^3 \psi} (z_p - z_s).$$

The total radial force R_p exerted on the *p*th corpuscle by all the other corpuscles, is equal to

$$\frac{e^2}{4a^2} S - \rho_p A' - \sum \rho_{p+s} A_{p.p+s} - a \sum \phi_{p+s} B_{p.p+s},$$

where

$$S = \frac{1}{\sin \frac{\pi}{n}} + \frac{1}{\sin \frac{2\pi}{n}} + \dots + \frac{1}{\sin \frac{(n-1)\pi}{n}};$$

$$A' = \frac{e^2}{4a^3} \left(\frac{3}{2} \left(\frac{1}{\sin \frac{\pi}{n}} + \frac{1}{\sin \frac{2\pi}{n}} + \dots + \frac{1}{\sin \frac{(n-1)\pi}{n}} \right) - \frac{1}{2} \left(\frac{1}{\sin^3 \frac{\pi}{n}} + \frac{1}{\sin^3 \frac{2\pi}{n}} + \dots + \frac{1}{\sin^3 \frac{(n-1)\pi}{n}} \right) \right);$$

$$A_{p.p+s} = \frac{e^2}{8a^3} \left(\frac{1}{\sin \frac{s\pi}{n}} + \frac{1}{\sin^3 \frac{s\pi}{n}} \right);$$

$$B_{p.p+s} = \frac{e^3}{8a^3} \frac{\cos \frac{s\pi}{n}}{\sin^2 \frac{s\pi}{n}}.$$

The coefficient of ϕ_p in the expression for R_p vanishes, since

$$\sum \frac{\cos \frac{s\pi}{n}}{\sin^2 \frac{s\pi}{n}} = 0.$$

As $A_{p.p+s}$, $B_{p.p+s}$ do not involve p , it is more convenient to use the symbols A_s and B_s for these quantities, and to write

$$R_p = \frac{e^2}{4a^2} S - \rho_p A' - \sum \rho_{p+s} A_s - a \sum \phi_{p+s} B_s.$$

The tangential force Θ_p acting on the p 'th particle may similarly be written

$$\Theta_p = \sum \rho_{p+s} B_s - a \phi_p C + a \sum \phi_{p+s} C_s,$$

where

$$C = \frac{e^2}{4a^3} \left(\frac{\cos \frac{\pi}{n}}{\sin^2 \frac{\pi}{n}} \left(\cot \frac{\pi}{n} + \frac{1}{2} \tan \frac{\pi}{n} \right) + \frac{\cos \frac{2\pi}{n}}{\sin^2 \frac{2\pi}{n}} \left(\cot \frac{2\pi}{n} + \frac{1}{2} \tan \frac{2\pi}{n} \right) + \dots \right),$$

$$C_s = \frac{e^2}{4a^3} \frac{\cos \frac{s\pi}{n}}{\sin^2 \frac{s\pi}{n}} \left(\cot \frac{s\pi}{n} + \frac{1}{2} \tan \frac{s\pi}{n} \right);$$

while Z_p , the force at right angles to the plane of the orbit, is given by the equation

$$Z_p = z_p D - \sum z_{p+s} D_s,$$

where

$$D = \frac{e^2}{8a^3} \left(\frac{1}{\sin^3 \frac{\pi}{n}} + \frac{1}{\sin^3 \frac{2\pi}{n}} + \dots + \frac{1}{\sin^3 \frac{(n-1)\pi}{n}} \right),$$

and

$$D_s = \frac{e^2}{8a^3} \frac{1}{\sin^3 \frac{s\pi}{n}}.$$

The equations of motion of the p th corpuscle are

$$m \left(\frac{d^2 r_p}{dt^2} - r_p \left(\frac{d\theta_p}{dt} \right)^2 \right) = - \frac{ve^2 r_p}{b^3} + R_p; \dots (\alpha)$$

$$m \left(r \frac{d^2 \theta_p}{dt^2} + 2 \frac{dr}{dt} \frac{d\theta_p}{dt} \right) = \Theta_p; \dots (\beta)$$

$$m \frac{d^2 z_p}{dt^2} = - \frac{ve^2}{b^3} z_p + Z_p. \dots (\gamma)$$

Retaining only the first powers of small quantities, we get from these equations, if ω is the value of $\frac{d\theta}{dt}$ when the motion is steady,

$$\frac{ve^2 a}{l^3} = ma\omega^2 + \frac{e^2}{4a^2} S,$$

$$m \frac{d^2 \rho_p}{dt^2} - 2ma\omega \frac{d\theta_p}{dt} = \rho_p \left(m\omega^2 - \frac{ve^2}{b^3} \right) + R_p - \frac{e^2}{4a^2} S.$$

If ρ_p and θ_p vary as e^{iqt} , this equation may be written

$$(A - mq^2)\rho_p + A_1\rho_{p+1} + A_2\rho_{p+2} + \dots - 2ma\omega iq\phi_p + aB_1\phi_{p+1} + aB_2\phi_{p+2} + \dots = 0,$$

where

$$A = \frac{e^2}{4a^3} S + A' = \frac{e^2}{8a^3} \left\{ 5 \left(\frac{1}{\sin \frac{\pi}{n}} + \frac{1}{\sin \frac{2\pi}{n}} + \dots \right) - \left(\frac{1}{\sin^3 \frac{\pi}{n}} + \frac{1}{\sin^3 \frac{2\pi}{n}} + \dots \right) \right\}$$

Writing 1, 2, 3 for p we get

$$\left. \begin{aligned} (A - mq^2)\rho_1 + A_1\rho_2 + A_2\rho_3 + \dots + A_{n-1}\rho_n - 2ma\omega iq\phi_1 + aB_1\phi_2 + aB_2\phi_3 + \dots &= 0 \\ (A - mq^2)\rho_2 + A_1\rho_3 + A_2\rho_4 + \dots - 2ma\omega iq\phi_2 + aB_1\phi_3 + aB_2\phi_4 + \dots &= 0 \\ \dots &\dots \\ (A - mq^2)\rho_n + A_1\rho_1 + A_2\rho_2 + \dots - 2ma\omega iq\phi_n + aB_1\phi_1 + aB_2\phi_2 + \dots &= 0 \end{aligned} \right\}$$

By equation β we have

$$2m\omega iq \frac{\rho_p}{a} - B_1 \frac{\rho_{p+1}}{a} - B_2 \frac{\rho_{p+2}}{a} + \dots + (C - mq^2)\phi_p - C_1\phi_{p+1} - C_2\phi_{p+2} - \dots = 0.$$

Writing 1, 2, 3 in succession for p we get

$$\left. \begin{aligned} 2m\omega iq \frac{\rho_1}{a} - B_1 \frac{\rho_2}{a} - B_2 \frac{\rho_3}{a} \dots + (C - mq^2)\phi_1 - C_1\phi_2 - C_2\phi_3 - \dots &= 0 \\ 2m\omega iq \frac{\rho_2}{a} - B_1 \frac{\rho_3}{a} - B_2 \frac{\rho_4}{a} \dots + (C - mq^2)\phi_2 - C_2\phi_3 - C_2\phi_4 - \dots &= 0 \\ \dots &\dots \\ 2m\omega iq \frac{\rho_n}{a} - B_1 \frac{\rho_1}{a} - B_2 \frac{\rho_2}{a} \dots + (C - mq^2)\phi_n - C_1\phi_1 - C_2\phi_2 - \dots &= 0 \end{aligned} \right\} (B)$$

To solve equations A and B we notice that if ω be any root of the equation $x^n=1$, *i. e.* if ω be one of the n th roots of unity, equations A will be satisfied by

$$\rho_2 = \omega\rho_1, \rho_3 = \omega\rho_2, \rho_4 = \omega\rho_3 \dots \quad \phi_2 = \omega\phi_1, \phi_3 = \omega\phi_2, \phi_4 = \omega\phi_3 \dots$$

provided

$$\rho_1(A - mq^2 + \omega A_1 + \omega^2 A_2 + \dots \omega^{n-1} A_{n-1}) + \phi_1 a(-2im\omega q + \omega B_1 + \omega^2 B_2 + \omega^{n-1} B_{n-1}) = 0; \quad (1)$$

while equations B will be satisfied by the same values provided

$$\rho_1(2im\omega q - \omega B_1 - \omega^2 B_2 - \omega^{n-1} B_{n-1}) + \phi_1 a(C - mq^2 - \omega C_1 - \omega^2 C_2 - \omega^{n-1} C_{n-1}) = 0. \quad (2)$$

Hence, if both sets of equations are satisfied by these values, we have, eliminating ρ_1 and ϕ_1 from (1) and (2),

$$\begin{aligned} & ((A - mq^2) + \omega A_1 + \omega^2 A_2 + \dots \omega^{n-1} A_{n-1}) \\ & (C - mq^2 - \omega C_1 - \omega^2 C_2 - \omega^{n-1} C_{n-1}) \\ & = -(-2im\omega q + \omega B_1 + \omega^2 B_2 + \dots \omega^{n-1} B_n)^2, \quad (1) \end{aligned}$$

a biquadratic equation to determine q the frequency of the oscillations of the system. Now ω is of the form

$$\cos \frac{2k\pi}{n} + i \sin \frac{2k\pi}{n},$$

where k is an integer between 0 and $n-1$. Substituting this value for ω , we find

$$\begin{aligned} \omega A_1 + \omega^2 A_2 + \omega^{n-1} A_{n-1} &= \frac{e^2}{8a^3} \left\{ \cos \frac{2k\pi}{n} \left(\frac{1}{\sin \frac{\pi}{n}} + \frac{1}{\sin^3 \frac{\pi}{n}} \right) \right. \\ &+ \cos \frac{4k\pi}{n} \left(\frac{1}{\sin \frac{2\pi}{n}} + \frac{1}{\sin^3 \frac{2\pi}{n}} \right) + \cos \frac{6k\pi}{n} \left(\frac{1}{\sin \frac{3\pi}{n}} + \frac{1}{\sin^3 \frac{3\pi}{n}} \right) + \dots \left. \right\} \end{aligned}$$

We shall denote this by L_k ; it will be noticed that L_k contains no imaginary terms. We find also that

$$\begin{aligned} \omega C_1 + \omega^2 C_2 + \omega^3 C_3 + \omega^{n-1} C_{n-1} &= \frac{e^2}{4a^3} \left(\cos \frac{2k\pi}{n} \frac{\cos \frac{\pi}{n}}{\sin^2 \frac{\pi}{n}} \left(\cot \frac{\pi}{n} + \frac{1}{2} \tan \frac{\pi}{n} \right) \right. \\ &+ \cos \frac{4k\pi}{n} \frac{\cos \frac{2\pi}{n}}{\sin^2 \frac{2\pi}{n}} \left(\cot \frac{2\pi}{n} + \frac{1}{2} \tan \frac{2\pi}{n} \right) \\ &+ \dots \left. \right). \end{aligned}$$

We shall denote this by N_k .

Again,

$$\begin{aligned} \omega B_1 + \omega^2 B_2 + \omega^{n-1} B_{n-1} &= \frac{v \cdot e^2}{8a^3} \left(\sin \frac{2k\pi}{n} \frac{\cos \frac{\pi}{n}}{\sin^2 \frac{\pi}{n}} + \sin \frac{4k\pi}{n} \frac{\cos \frac{2\pi}{n}}{\sin^2 \frac{2\pi}{n}} \right. \\ &\quad \left. + \sin \frac{6k\pi}{n} \frac{\cos \frac{3\pi}{n}}{\sin^2 \frac{3\pi}{n}} + \dots \right) \\ &= M_k, \text{ say.} \end{aligned}$$

Substituting these values, equation (1) becomes

$$((A - mq^2) + L_k)(C - mq^2 - N_k) = (M_k - 2m\omega q)^2. \quad (2)$$

From the value of C given on p. 240 we see that C is the value of N_k when $k=0$, and so may be denoted by N_0 , and that $A = \frac{3}{4} \frac{e^2}{a^3} S - L_0$; hence equation (2) may be written

$$\left(\frac{3}{4} \frac{e^2}{a^3} S + L_k - L_0 - mq^2 \right) (N_0 - N_k - mq^2) = (M_k - 2m\omega q)^2. \quad (3)$$

k in this equation may have any value from 0 to $(n-1)$; but we see that if we write $n-k$ for k , the values of q given by the two equations differ only in sign, and so give the same frequencies;

thus all the values of q can be got by putting $k=0, 1, \dots, \frac{n-1}{2}$, if n be odd, or $k=0, 1, \frac{n}{2}$ if n be even; thus if n be odd there are $\frac{n+1}{2}$ equations of the type (3). When $k=0$, $M_k=0$, and

(3) reduces to a quadratic equation; so that the number of roots of these $\frac{n+1}{2}$ equations is $4 \times \frac{n+1}{2} - 2 = 2n$; if n be

even there are $\frac{n}{2} + 1$ equations; but as $M_k=0$ when $k=0$ and $k=\frac{n}{2}$, two of these reduce to quadratics; so that the

number of roots of these equations is $4 \left(\frac{n}{2} + 1 \right) - 4 = 2n$.

Thus in each case the number of roots is equal to $2n$, the number of degrees of freedom of the corpuscles in the plane of their undisturbed orbit.

Let us now consider the motion at right angles to this plane. By equation γ we have

$$m \frac{d^2 z_p}{dt^2} = -\frac{ve^2}{b^3} z_p + D z_p - \sum D_s z_{p+s};$$

$$T_k = \sum_1^{n-1} \cos \frac{2ks\pi}{n} \frac{1}{\sin^3 \frac{s\pi}{n}},$$

$$U_k = \sum_1^{n-1} \sin \frac{2ks\pi}{n} \frac{\cos \frac{s\pi}{n}}{\sin^2 \frac{s\pi}{n}};$$

for we have

$$L_k = (S_k + T_k) \frac{e^2}{8a^3}, \quad N_k = (2T_k - S_k) \frac{e^2}{8a^3},$$

$$M_k = U_k \frac{e^2}{8a^3}, \quad P_k = T_k \frac{e^2}{8a^3}.$$

Case of two corpuscles.

When $n=2$ we have

$$L_0 = \frac{2e^2}{8a^3}, \quad M_0 = 0, \quad N_0 = \frac{e^2}{8a^3}, \quad P_0 = \frac{e^2}{8a^3},$$

$$L_1 = -\frac{2e^2}{8a^3}, \quad M_1 = 0, \quad N_1 = -\frac{e^2}{8a^3}, \quad P_1 = -\frac{e^2}{8a^3}.$$

Hence for vibrations in the plane of the orbit we have, when $k=0$,

$$\left(\frac{3}{4} \frac{e^2}{a^3} - mq^2\right) (-mq^2) = 4m^2\omega^2q^2;$$

the roots of this equation are

$$q=0, \quad q = \sqrt{\frac{3}{4} \frac{e^2}{ma^3} + 4\omega^2} = \sqrt{\frac{3ve^2}{mb^3} + \omega^2}.$$

When $k=1$, the frequency equation is

$$\left(\frac{1}{4} \frac{e^2}{a^3} - mq^2\right)^2 = 4m^2\omega^2q^2;$$

the roots of this equation are

$$q = \omega \pm \sqrt{\frac{1}{4} \frac{e^2}{ma^3} + \omega^2} = \omega \pm \sqrt{\frac{ve^2}{mb^3}},$$

and

$$q = -\omega \pm \sqrt{\frac{1}{4} \frac{e^2}{ma^3} + \omega^2} = -\omega \pm \sqrt{\frac{ve^2}{mb^3}},$$

the second set of values only differing in sign from the first.

For the vibrations perpendicular to the plane of the orbit, we have for $k=0$,

$$q = \sqrt{\frac{ve^2}{mb^3}};$$

for $k=1$,

$$q = \sqrt{\frac{ve^2}{mb^3} - \frac{e^2}{4ma^3}} = \omega.$$

Thus the six frequencies corresponding to the six degrees of freedom of the two corpuscles are

$$0, \quad \omega, \quad \sqrt{\frac{ve}{mb^3}}, \quad \sqrt{\frac{ve^2}{mb^3}} - \omega, \quad \sqrt{\frac{ve^2}{mb^3}} + \omega, \quad \sqrt{\frac{3ve^2}{mb^3} + \omega^2}.$$

When the corpuscles are not rotating round the circle, two of these roots are zero, three equal to $\sqrt{\frac{ve^2}{mb^3}}$, and the sixth equal to $\sqrt{\frac{3ve^2}{mb^3}}$. Thus the effect of rotation on the triple frequency $\sqrt{ve^2/m^3}$ is to separate the roots, one remaining unaltered, one increasing, and the other diminishing.

Case of three corpuscles.

When $n=3$.

$$\begin{aligned} S_0 &= \frac{4}{\sqrt{3}}, & T_0 &= \frac{16}{3\sqrt{3}}, & U_0 &= 0, & L_0 &= \frac{28}{3\sqrt{3}} \frac{e^2}{8a^3}, \\ N_0 &= \frac{20}{3\sqrt{3}} \frac{e^2}{8a^3}, & M_0 &= 0, & P_0 &= \frac{16}{3\sqrt{3}} \frac{e^2}{8a^3}, \\ S_1 &= -\frac{2}{\sqrt{3}}, & T_1 &= -\frac{8}{3\sqrt{3}}, & U_1 &= \frac{2}{\sqrt{3}}, & L_1 &= -\frac{14}{3\sqrt{3}} \frac{e^2}{8a^3}, \\ N_1 &= -\frac{10}{3\sqrt{3}} \frac{e^2}{8a^3}, & M_1 &= \frac{2}{\sqrt{3}} \frac{e^2}{8a^3}, & P_1 &= -\frac{8}{3\sqrt{3}} \frac{e^2}{8a^3}, \\ S_2 &= S_1, & T_2 &= T_1, & U_2 &= -U_1, & L_2 &= L_1, & N_2 &= N_1, \\ & & M_2 &= -M_1, & P_2 &= P_1. \end{aligned}$$

For the vibrations in the plane of the orbit, when $k=0$, the frequency equation is

$$\left(\sqrt{3} \frac{e^2}{a^3} - mq^2\right)(-mq^2) = 4m^2\omega^2q^2;$$

the solution of this is

$$q=0 \text{ and } q = \left\{ \sqrt{3} \frac{e^2}{ma^3} + 4\omega^2 \right\}^{\frac{1}{2}} = \left\{ \frac{3ve^2}{mb^3} + \omega^2 \right\}^{\frac{1}{2}}.$$

When $k=1$, the frequency equation is

$$\left(\frac{5}{4\sqrt{3}} \frac{e^2}{a^3} - mq^2\right)^2 = \left(\frac{2}{\sqrt{3}} \frac{e^2}{8a^3} - 2m\omega q\right)^2.$$

The solution of this equation is

$$q = \omega \pm \sqrt{\frac{1}{\sqrt{3}} \frac{e^2}{ma^3} + \omega^2} = \omega \pm \sqrt{\frac{ve^2}{mb^3}},$$

$$q = -\omega \pm \sqrt{\frac{\sqrt{3}}{2} \frac{e^2}{ma^3} + \omega^2} = -\omega \pm \sqrt{\frac{3}{2} \frac{ve^2}{mb^3} - \frac{1}{2}\omega^2}.$$

When $k=2$ the frequencies are the same as when $k=1$; we have thus six frequencies corresponding to the six degrees of freedom of the three corpuscles in the plane of their undisturbed orbit.

For the vibration at right angles to the plane of this orbit, when $k=0$ the frequency equation is

$$\frac{ve^2}{b^3} - mq^2 = 0,$$

or

$$q = \sqrt{\frac{ve^2}{mb^3}}.$$

When $k=1$, the frequency equation is

$$\frac{ve^2}{b^3} - \frac{e^2}{\sqrt{3}a^3} - mq^2 = 0,$$

or

$$q = \pm \omega.$$

In the case of three corpuscles, as in that of two, we see that when there is no rotation three of the periods are equal; these are separated when the corpuscles are in rotation.

Case of four corpuscles.

When $n=4$,

$$S_0 = 1 + 2\sqrt{2}, \quad T_0 = 4\sqrt{2} + 1, \quad U_0 = 0, \quad L_0 = (6\sqrt{2} + 2) \frac{e^2}{8a^3},$$

$$N_0 = (6\sqrt{2} + 1) \frac{e^2}{8a^3}, \quad M_0 = 0, \quad P_0 = (4\sqrt{2} + 1) \frac{e^2}{8a^3},$$

$$S_1 = -1, \quad T_1 = -1, \quad U_1 = 2\sqrt{2}, \quad L_1 = -2 \frac{e^2}{8a^3},$$

$$N_1 = -\frac{e^2}{8a^3}, \quad M_1 = 2\sqrt{2} \frac{e^2}{8a^3}, \quad P_1 = -\frac{e^2}{8a^3},$$

$$S_2 = -2\sqrt{2} + 1, \quad T_2 = -4\sqrt{2} + 1, \quad U_2 = 0, \quad L_2 = (-6\sqrt{2} + 2) \frac{e^2}{8a^3},$$

$$N_2 = (-6\sqrt{2} + 1) \frac{e^2}{8a^3}, \quad M_2 = 0, \quad P_2 = (-4\sqrt{2} + 1) \frac{e^2}{8a^3}.$$

When $k=0$, the frequency equation is

$$\left(\frac{3}{4} \frac{e^2}{a^3} (1 + 2\sqrt{2}) - mq^2\right) (-mq^2) = 4m^2\omega^2 q^2;$$

the solution of which is

$$q=0, \quad q = \sqrt{\frac{3}{4} \frac{e^2}{a^3} (1 + 2\sqrt{2}) + 4\omega^2} = \sqrt{\frac{3ve^2}{mb^3} + \omega^2}.$$

When $k=1$, the frequency equation is

$$\left((6\sqrt{2} + 2) \frac{e^2}{8a^3} - mq^2\right)^2 = \left(2\sqrt{2} \frac{e^2}{8a^3} - 2m\omega q\right)^2;$$

the solution of this is

$$q = \omega \pm \sqrt{\frac{2\sqrt{2} + 1}{4} \frac{e^2}{ma^3} + \omega^2} = \omega \pm \sqrt{\frac{ve^2}{mb^3}},$$

$$q = -\omega \pm \sqrt{\frac{4\sqrt{2} + 1}{4} \frac{e^2}{ma^3} + \omega^2} = -\omega \pm \sqrt{\frac{4\sqrt{2} + 1}{2\sqrt{2} + 1} \frac{ve^2}{mb^3} - \frac{2\sqrt{2}\omega^2}{2\sqrt{2} + 1}}.$$

When $k=2$, the frequency equation is

$$\left(\frac{3}{4} \frac{e^2}{a^3} - mq^2\right) \left(\frac{3}{\sqrt{2}} \frac{e^2}{a^3} - mq^2\right) = 4m^2\omega^2 q^2.$$

Regarding this as a quadratic in q^2 , we see that the roots are positive, so that the values of q are real and the arrangement is stable. The roots of the equation are

$$q^2 = \frac{3}{8\sqrt{2}} (4 + \sqrt{2}) \frac{e^2}{ma^3} + 2\omega^2 \\ \pm \sqrt{9 \frac{(4 - \sqrt{2})^2}{128} \frac{e^4}{m^2 a^6} + \frac{3(\sqrt{2} + 4)}{2\sqrt{2}} \frac{e^2}{ma^3} \omega^2 + 4\omega^4}.$$

Let us now consider the motion at right angles to the plane of the orbit. When $k=0$, the frequency equation is

$$\frac{ve^2}{b^3} - mq^2 = 0,$$

or

$$q = \sqrt{\frac{ve^2}{mb^3}}.$$

When $k=1$, the frequency equation is

$$\frac{ve^2}{b^3} - (4\sqrt{2} + 2) \frac{e^2}{8a^3} - mq^2 = 0,$$

or

$$q = \pm \omega.$$

When $k=2$, the frequency equation is

$$\frac{ve^2}{b^3} - \frac{8\sqrt{2}e^2}{8a^3} - mq^2 = 0,$$

or

$$q^2 = \frac{8\sqrt{2}}{4\sqrt{2}+2}\omega^2 - \frac{(4\sqrt{2}-2)}{4\sqrt{2}+2}\frac{ve^2}{mb^3}.$$

Thus, unless

$$\omega^2 > \frac{4\sqrt{2}-2}{8\sqrt{2}}\frac{ve^2}{mb^3} > 325\frac{ve^2}{mb^3}, \quad \dots \quad (1)$$

q^2 is negative, and the equilibrium is unstable, the four corpuscles then arranging themselves at the corner of a regular tetrahedron. When, however, ω is large enough to satisfy condition (1), four corpuscles will be in equilibrium when in steady motion in one plane at the corners of a square.

Case of five corpuscles.

When $n=5$, we have

$$S_0 = 5.5056, \quad T_0 = 12.1732, \quad U_0 = 0, \quad L_0 = \frac{e^2}{8a^3}(17.6788),$$

$$N_0 = \frac{e^2}{8a^3}(18.8408), \quad M_0 = 0, \quad P_0 = \frac{e^2}{8a^3}(12.1732),$$

$$S_1 = -0.65, \quad T_1 = 1.1609, \quad U_1 = 4.856, \quad L_1 = \frac{e^2}{8a^3}(0.511),$$

$$N_1 = \frac{e^2}{8a^3}(2.9716), \quad M_1 = \frac{e^2}{8a^3}4.856, \quad P_1 = \frac{e^2}{8a^3}(1.1609),$$

$$S_2 = -2.103, \quad T_2 = -7.249, \quad U_2 = 2.103, \quad L_2 = -\frac{e^2}{8a^3}(9.352),$$

$$N_2 = -\frac{e^2}{8a^3}12.4, \quad M_2 = \frac{e^2}{8a^3}2.103, \quad P_2 = -\frac{e^2}{8a^3}7.249.$$

The frequency equation when $k=0$ is

$$\left(\frac{3}{4}5.5056\frac{e^2}{a^3} - mq^2\right)(-mq^2) = 4m^2\omega^2q^2,$$

the solution of which is

$$q=0, \quad q = \sqrt{\frac{3ve}{b^3} + \omega^2}.$$

When $k=1$, the frequency equation is

$$\left(15.87\frac{e^2}{8a^3} - mq^2\right)^2 = \left(\frac{e^2}{8a^3}4.856 - 2m\omega q\right)^2,$$

or
$$q = \omega \pm \sqrt{10 \cdot 918 \frac{e^2}{8a^3} + \omega^2} = \omega \pm \sqrt{\frac{ve^2}{mb^3}},$$

$$q = -\omega \pm \sqrt{20 \cdot 726 \frac{e^2}{8a^3} + \omega^2}.$$

When $k=2$,

$$\left(6 \frac{e^2}{8a^3} - mq^2\right) \left(31 \cdot 24 \frac{e^2}{8a^3} - m\omega^2\right) = \left(2 \cdot 103 \frac{e^3}{8a^3} - 2m\omega q\right)^2.$$

By applying the usual methods we find that all the roots of this equation are real, so that the steady motion of the five particles is stable for displacements in the plane of the orbit.

Let us now consider displacements at right angles to the plane of the orbit. When $k=0$ the frequency equation is

$$\frac{ve^2}{b^3} - mq^2 = 0,$$

the solution of which is

$$q = \sqrt{\frac{ve^2}{mb^3}}.$$

When $k=1$, the frequency equation is

$$m\omega^2 - mq^2 = 0,$$

hence

$$q = \omega.$$

When $k=2$, the frequency equation is

$$\frac{ve^2}{b^3} - 19 \cdot 42 \frac{e^2}{8a^3} - mq^2 = 0,$$

or
$$\frac{19 \cdot 42}{11} m\omega^2 + \frac{ve^2}{b^3} - \frac{19 \cdot 42}{11} \frac{ve^2}{b^3} - mq^2 = 0,$$

$$\frac{19 \cdot 42}{11} m\omega^2 - \frac{8 \cdot 42}{11} \frac{ve^2}{b^3} - mq^2 = 0.$$

Hence, in order that the equilibrium may be stable,

$$\omega^2 \text{ must be } > \frac{8 \cdot 42}{19 \cdot 42} \frac{ve^2}{b^3} > \cdot 433 \frac{ve^2}{mb^3}.$$

Thus the five corpuscles are unstable when in one plane unless the angular velocity exceeds a certain value; the arrangement is stable, however, when the angular velocity is large.

Case of six corpuscles.

When $n=6$,

$$S_0 = 5 + \frac{4}{\sqrt{3}}, \quad T_0 = 17 + \frac{16}{3\sqrt{3}}, \quad U_0 = 0, \quad L_0 = \left(22 + \frac{28}{3\sqrt{3}}\right) \frac{e^2}{8a^3},$$

$$N_0 = \left(29 + \frac{20}{3\sqrt{3}}\right) \frac{e^2}{8a^3}, \quad M_0 = 0, \quad P_0 = \left(17 + \frac{16}{3\sqrt{3}}\right) \frac{e^2}{8a^3},$$

$$S_1 = 1 - \frac{2}{\sqrt{3}}, \quad T_1 = 7 - \frac{8}{3\sqrt{3}}, \quad U_1 = 6 + \frac{2}{\sqrt{3}}, \quad L_1 = \left(8 - \frac{14}{3\sqrt{3}}\right) \frac{e^2}{8a^3},$$

$$N_1 = \left(13 - \frac{10}{3\sqrt{3}}\right) \frac{e^2}{8a^3}, \quad M_1 = \left(7 - \frac{8}{3\sqrt{3}}\right) \frac{e^2}{8a^3}, \quad P_1 = \left(7 - \frac{8}{3\sqrt{3}}\right) \frac{e^2}{8a^3},$$

$$S_2 = -1 - \frac{2}{\sqrt{3}}, \quad T_2 = -7 - \frac{8}{3\sqrt{3}}, \quad U_2 = 6 - \frac{2}{\sqrt{3}}, \quad L_2 = \left(-8 - \frac{14}{3\sqrt{3}}\right) \frac{e^2}{8a^3},$$

$$N_2 = \left(-13 - \frac{10}{3\sqrt{3}}\right) \frac{e^2}{8a^3}, \quad M_2 = \left(6 - \frac{2}{\sqrt{3}}\right) \frac{e^2}{8a^3}, \quad P_2 = \left(-7 - \frac{8}{3\sqrt{3}}\right) \frac{e^2}{8a^3},$$

$$S_3 = -5 + \frac{4}{\sqrt{3}}, \quad T_3 = -17 + \frac{16}{3\sqrt{3}}, \quad U_3 = 0, \quad L_3 = \left(-22 + \frac{28}{3\sqrt{3}}\right) \frac{e^2}{8a^3},$$

$$N_3 = \left(-29 + \frac{20}{3\sqrt{3}}\right) \frac{e^2}{8a^3}, \quad M_3 = 0, \quad P_3 = \left(-17 + \frac{16}{3\sqrt{3}}\right) \frac{e^2}{8a^3}.$$

It is not necessary to write down all the frequency equations because, as we shall show, the arrangement of six corpuscles is unstable. For when $k=3$ the frequency equation is

$$\left(\frac{6}{8} \left(5 + \frac{4}{\sqrt{3}}\right) \frac{e^2}{8a^3} - 44 \frac{e^2}{8a^3} - mq^2\right) \left(58 \frac{e^2}{8a^3} - mq^2\right) = 4m^2\omega^2q^2,$$

$$\text{or} \quad \left(-\frac{(14-8\sqrt{3})e^2}{8a^3} - mq^2\right) \left(58 \frac{e^2}{8a^3} - mq^2\right) = 4m^2\omega^2q^2. \quad (1)$$

As $14-8\sqrt{3}$ is positive, we see that one of the roots of this equation for q^2 is negative, so that q is imaginary; this shows that the steady motion of 6 corpuscles in a ring is unstable, however rapid the rotation. We can, however, make the motion stable by putting a corpuscle at the centre; if we have a negative charge equal to that of p corpuscles at the centre of the ring the radial force it exerts on the s th corpuscle is $\frac{pe^2}{(a+\rho)^2}$, or $\frac{pe^2}{a^2} - \frac{2pe^2\rho}{a^3}$. Introducing this term into the expression for the radial force we find the frequency

equation becomes

$$\left(\frac{3}{4} \frac{e^2}{a^3} S_0 + \frac{3pe^2}{a^3} + I_k - I_0 - mq^2\right)(N_0 - N_k - mq^2) = (M_k - 2m\omega q)^2.$$

Using this frequency equation, and supposing that $p=1$, *i. e.* that there is only one corpuscle at the centre of the hexagon, we get instead of (1),

$$\left(\frac{10 + 8\sqrt{3}}{8} \frac{e^2}{a^3} - mq^2\right)\left(\frac{58}{8a^3} - mq^2\right) = 4m^2\omega^2 q^2. \quad (2)$$

The roots of this equation in q^2 are both positive, so that q is real and the equilibrium is stable.

Let us now investigate the conditions for stability for displacements at right angles to the plane of the orbit.

For the motion at right angles to the plane of the ring, the frequency equation when $k=3$ is

$$\frac{ve^2}{b^3} - \frac{pe^2}{a^3} - \frac{34e^2}{8a^3} - mq^2 = 0.$$

For this to represent the displacement of a stable system q^2 must be positive, so that if $p=1$

$$\frac{ve^2}{b^3} - \frac{e^2}{a^3} - \frac{34e^2}{8a^3}$$

must be positive; we have, however,

$$\frac{ve^2}{b^3} = m\omega^2 + \frac{e^2}{a^3} + \frac{e^2}{4a^3} \left(5 + \frac{4}{\sqrt{3}}\right);$$

so that for

$$\frac{ve^2}{b^3} - \frac{e^2}{a^3} - \frac{34e^2}{8a^3}$$

to be positive

$$m\omega^2 \text{ must be greater than } \frac{12 - 4/\sqrt{3}}{21} \frac{ve^2}{b^3}, \text{ i. e. } .46 \frac{ve^2}{b^3}.$$

Let us now consider the stability of the corpuscle at the centre of the ring: if it is displaced through a distance z at right angles to the ring, the equation of motion of the corpuscles is

$$m \frac{d^2 z}{dt^2} = - \frac{ve^2}{b^3} z + \frac{6e^2}{a^3} z.$$

Thus if the motion is stable

$$\frac{ve^2}{b^3} > \frac{6e^2}{a^3},$$

or

$$m\omega^2 > \frac{15 - \frac{1}{\sqrt{3}} \frac{ve^2}{b^3}, i. e. \cdot 53 \frac{ve^2}{b^3} .$$

This value of ω^2 is greater than that required to make the equilibrium of the ring stable for displacements at right angles to its plane; if the central corpuscle, instead of being in the plane of the ring, was one side of the centre of the sphere of positive electrification while the ring was on the other side, the rotation required to make the equilibrium of the detached corpuscle stable would be less than when it was in the plane of the ring; for equilibrium the distance of the detached corpuscle from the centre of the sphere must be six times the distance of the plane of the ring from that point.

Conditions for the stability of rings containing more than six corpuscles.

I find that a single corpuscle in the centre is sufficient to make rings of 7 and 8 corpuscles stable; in the latter case, however, one of the values of q^2 though positive is exceedingly small. When the number of corpuscles exceeds 8 the number of central corpuscles required to ensure stability increases very rapidly with the number of corpuscles in the ring.

The frequency equation is

$$\left(\frac{3}{4} \frac{e^2 S_0}{a^3} + \frac{3pe^2}{a^3} - (L_0 - L_k) - mq^2 \right) (N_0 - N_k - mq^2) = (M_k - 2m\omega q)^2.$$

Now $N_0 - N_k$ is always positive and M is small compared with L and N ; hence this equation will have real roots if

$$\frac{3}{4} \frac{e^2 S_0}{a^3} + \frac{3pe^2}{a^3} - (L_0 - L_k)$$

is positive. The greatest value of $L_0 - L_k$ is got by putting $k = n/2$ when n is even, and $= (n-1)/2$ when n is odd: hence the condition that the values of q should be real, *i. e.* that the equilibrium of the ring should be stable, is

$$\frac{3pe^2}{a^3} > (L_0 - L_{\frac{n}{2}}) - \frac{3}{4} \frac{e^2 S_0}{a^3} \text{ when } n \text{ is even,}$$

and

$$\frac{3pe^2}{a^3} > (L_0 - L_{\frac{n-1}{2}}) - \frac{3}{4} \frac{e^2 S_0}{a^3} \text{ when } n \text{ is odd.}$$

From this equation we can calculate the least value of p which will make a ring of n corpuscles stable. The values of

p for a series of values of n are given in the following table:—

| | | | | | | | | | | |
|-----------|---|---|---|---|---|----|----|----|-----|-----|
| $n \dots$ | 5 | 6 | 7 | 8 | 9 | 10 | 15 | 20 | 30 | 40 |
| $p \dots$ | 0 | 1 | 1 | 1 | 2 | 3 | 15 | 39 | 101 | 232 |

For large values of n the values of p are proportional to n^3 . When p is greater than one, the internal corpuscles necessary to produce equilibrium cannot all be at the centre of the sphere, they will separate until their repulsions are balanced by the attraction of the positive electricity in the sphere. Thus when there are two internal corpuscles, as when $n=9$, these two will separate and will form a pair with the line joining them parallel to the plane of the ring. If we assume, as is approximately the case, that the pair of equal corpuscles exerts at external points the same force as a double charge placed at a point midway between them, the preceding theory will apply, and the system consisting of the ring of 9 and the pair of corpuscles will be in stable equilibrium. When $n=10$, the internal corpuscles must be three in number; these three will arrange themselves at the corners of an equilateral triangle, and the system of 13 corpuscles will consist of a ring of 10 and a triangle of 3, the planes of the ring and triangle being parallel but not coincident; the corpuscles are all supposed to be in rapid rotation round the diameter of the sphere drawn at right angles to the planes of the ring. For a ring of 12 corpuscles we require 7 inside, but 7 corpuscles, as we have seen, cannot form a single ring, but will arrange themselves as a ring of 6 with one at the centre. Thus the system of 19 corpuscles will consist of an outer ring of 12, an inner ring of 6 in a plane parallel to the outer ring, and one corpuscle along the axis of rotation.

In this way we see that when we have a large number of corpuscles in rapid rotation they will arrange themselves as follows:—The corpuscles form a series of rings, the corpuscles in one ring being approximately in a plane at right angles to the axis of rotation, the number of particles in the rings diminishing as the radius of the ring diminishes. If the corpuscles can move at right angles to the plane of their orbit, the rings will be in different planes adjusting themselves so that the repulsion between the rings is balanced by the attraction exerted by the positive electrification of the sphere in which they are placed. We have thus in the first place a sphere of uniform positive electrification, and inside this sphere a number of corpuscles arranged in a series of parallel rings, the number of corpuscles in a ring varying from ring to ring: each corpuscle is travelling at a high speed round

the circumference of the ring in which it is situated, and the rings are so arranged that those which contain a large number of corpuscles are near the surface of the sphere, while those in which there are a smaller number of corpuscles are more in the inside.

If the corpuscles, like the poles of the little magnets in Mayer's experiments with the floating magnets, are constrained to move in one plane, they would, even if not in rotation, be in equilibrium when arranged in the series of rings just described. The rotation is required to make the arrangement stable when the corpuscles can move at right angles to the plane of the ring.

Application of the preceding Results to the Theory of the Structure of the Atom.

We suppose that the atom consists of a number of corpuscles moving about in a sphere of uniform positive electrification: the problems we have to solve are (1) what would be the structure of such an atom, *i. e.* how would the corpuscles arrange themselves in the sphere; and (2) what properties would this structure confer upon the atom. The solution of (1) when the corpuscles are constrained to move in one plane is indicated by the results we have just obtained—the corpuscles will arrange themselves in a series of concentric rings. This arrangement is necessitated by the fact that a large number of corpuscles cannot be in stable equilibrium when arranged as a single ring, while this ring can be made stable by placing inside it an appropriate number of corpuscles. When the corpuscles are not constrained to one plane, but can move about in all directions, they will arrange themselves in a series of concentric shells; for we can easily see that, as in the case of the ring, a number of corpuscles distributed over the surface of a shell will not be in stable equilibrium if the number of corpuscles is large, unless there are other corpuscles inside the shell, while the equilibrium can be made stable by introducing within the shell an appropriate number of other corpuscles.

The analytical and geometrical difficulties of the problem of the distribution of the corpuscles when they are arranged in shells are much greater than when they are arranged in rings, and I have not as yet succeeded in getting a general solution. We can see, however, that the same kind of properties will be associated with the shells as with the rings; and as our solution of the latter case enables us to give definite results, I shall confine myself to this case, and endeavour to show that the properties conferred on the

atom by this ring structure are analogous in many respects to those possessed by the atoms of the chemical elements, and that in particular the properties of the atom will depend upon its atomic weight in a way very analogous to that expressed by the periodic law.

Let us suppose, then, that we have N corpuscles each carrying a charge e of negative electricity, placed in a sphere of positive electrification, the whole charge in the sphere being equal to Ne ; let us find the distribution of the corpuscles when they are arranged in what we may consider to be the simplest way, *i. e.* when the number of rings is a minimum, so that in each ring there are as nearly as possible as many corpuscles as it is possible for the corpuscles inside to hold in equilibrium. Let us suppose that the number of internal corpuscles required to make the equilibrium of a ring of n corpuscles stable is $f(n)$. The value of $f(n)$ for a series of values of n is given in the table on page 254; in that table $f(n)$ is denoted by p . The number of corpuscles in the outer ring n_1 will then be determined by the condition that $N - n_1$, the number of corpuscles inside, must be just sufficient to keep the ring of n_1 corpuscles in equilibrium, *i. e.*, n_1 will be determined by the equation.

$$N - n_1 = f(n_1). \quad . \quad . \quad . \quad . \quad . \quad (1)$$

If the value of n_1 got from this equation is not an integer we must take the integral part of the value.

To get n_2 , the number of corpuscles in the second ring, we notice that there must be $N - n_1 - n_2$ corpuscles inside; hence n_2 is given by the equation

$$N - n_1 - n_2 = f(n_2).$$

Similarly, n_3, n_4, \dots , the number of corpuscles in the 3rd, 4th, &c. rings reckoned from the outside, are given by

$$N - n_1 - n_2 - n_3 = f(n_3),$$

$$N - n_1 - n_2 - n_3 - n_4 = f(n_4).$$

These equations can be solved very rapidly by a graphical method. Draw the graph whose abscissa $= f(n)$ and whose ordinate is n . The values of $f(n)$ for a series of values of n are given on page 254; from these values the curve fig. 1 has been constructed.

To find how a number of corpuscles equal to N will arrange themselves, measure off on the axis of abscissæ a distance from O equal to N . Let OP be this distance, through P draw PQ inclined at an angle of 135° to the horizontal axis,

cutting the curve in Q, draw the ordinate QM; then the integral part of QM will be the value of n_1 , the number of

Fig. 1.

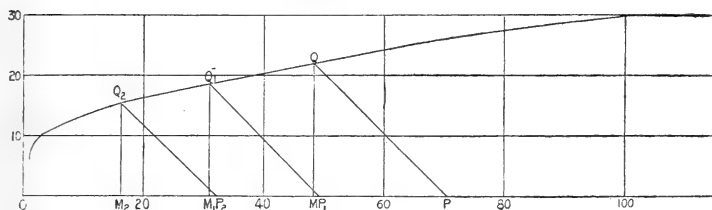

corpuscles in the first ring reckoned from the outside. For evidently

$$OM = f(QM),$$

and $OM = ON - NM$, and since PQ is inclined at 45° to the axis, $NM = OM$; hence

$$ON - QM = f(QM).$$

Comparing this with equation (1) we see that the integral part of QM is the value of n_1 .

To get the value of n_2 , the number of corpuscles in the second ring, we mark off the abscissa $OP_1 = N - n_1$ (if QM is an integer P_1 will coincide with M), then from P_1 draw P_1Q_1 parallel to PQ cutting the curve in Q_1 ; the integral part of Q_1M_1 will be the value of n_2 . To get n_3 mark off the abscissa $OP_2 = N - n_1 - n_2$, and draw P_2Q_2 parallel to PQ ; the integral part of Q_2M_2 will be the value of n_3 . In this way we can in a very short time find the configuration.

The following table, which gives the way in which various numbers of corpuscles group themselves, has been calculated in this way; the numbers range downwards from 60 at intervals of 5.

| | | | | | | |
|--------------------------------|-----|-----|-----|-----|-----|-----|
| Number of corpuscles | 60. | 55. | 50. | 45. | 40. | 35. |
| Number in successive rings ... | 20 | 19 | 18 | 17 | 16 | 16 |
| | 16 | 16 | 15 | 14 | 13 | 12 |
| | 13 | 12 | 11 | 10 | 8 | 6 |
| | 8 | 7 | 5 | 4 | 3 | 1 |
| | 3 | 1 | 1 | | | |
| Number of corpuscles | 30. | 25. | 20. | 15. | 10. | 5. |
| Number in successive rings ... | 15 | 13 | 12 | 10 | 8 | 5 |
| | 10 | 9 | 7 | 5 | 2 | |
| | 5 | 3 | 1 | | | |

We give also the entire series of arrangement of corpuscles for which the outer ring consists of 20 corpuscles.

| Number of corpuscles | 59. | 60. | 61. | 62. | 63. | 64. | 65. | 66. | 67. |
|-------------------------------|-----|-----|-----|-----|-----|-----|-----|-----|-----|
| Number in successive rings... | 20 | 20 | 20 | 20 | 20 | 20 | 20 | 20 | 20 |
| | 16 | 16 | 16 | 17 | 17 | 17 | 17 | 17 | 17 |
| | 13 | 13 | 13 | 13 | 13 | 13 | 14 | 14 | 15 |
| | 8 | 8 | 9 | 9 | 10 | 10 | 10 | 10 | 10 |
| | 2 | 3 | 3 | 3 | 3 | 4 | 4 | 5 | 5 |

59 is the smallest number of corpuscles which can have an outer ring of 20, while when the number of corpuscles is greater than 67 the outer ring will contain more than 20 corpuscles.

Let us now consider the connexion between these results and the properties possessed by the atoms of the chemical elements. We suppose that the mass of an atom is the sum of the masses of the corpuscles it contains, so that the atomic weight of an element is measured by the number of corpuscles in its atom. An inspection of the results just given will show that systems built up of rings of corpuscles in the way we have described, will possess properties analogous to some of those possessed by the atom. In the first place, we see that the various arrangements of the corpuscles can be classified in families, the grouping of the corpuscles in the various members of the family having certain features in common. Thus, for example, we see that the group of 60 corpuscles consists of the same rings of corpuscles as the group of 40 with an additional ring of 20 corpuscles round it, while the group of 40 consists of the same series of rings as the group of 24 with an additional ring outside, while 24 is the group 11 with an additional ring. To continue the series for larger numbers of corpuscles, take the curve $x=f(y)$ when $f(n)$ is the number of corpuscles that must be placed

Fig. 2.

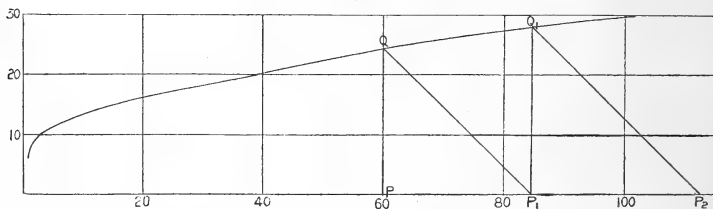

inside a ring of n corpuscles to make it stable. Let Q be the point on this curve corresponding to 60 corpuscles, *i. e.* $OP=60$, from Q draw QP_1 inclined at an angle of 135° to

the axis of x ; then the number of corpuscles represented by OP_1 will be arranged like the 60 corpuscles with an addition ring of Q_1P_1 corpuscles (fig. 2). To find the next member of the family, draw Q_1P_2 parallel to QP_1 cutting the axis of x in P_2 , then OP_2 will represent the number of corpuscles in the next member of the family; and by continuing the process we can find the successive members. Thus we see that we can divide the various groups of atoms into series such that each member of the series is derived from the preceding member (*i. e.* the member next below it in atomic weight) by adding to it another ring of corpuscles. We should expect the atoms formed by a series of corpuscles of this kind to have many points of resemblance. Take, for example, the vibrations of the corpuscles; these may be divided into two sets:—(1) Those arising from the rotation of the corpuscles around their orbits: if all the corpuscles in one atom have the same angular velocity, the frequency of the vibrations produced by the rotation of the ring of corpuscles is proportional to the number of corpuscles in the ring; and thus in the spectrum of each element in the series there would be a series of frequencies bearing the same ratio to each other, the ratio of the frequencies being the ratios of the numbers in the various rings.

The second system of vibrations are those arising from the displacement of the ring from its circular figure. If now the distance of a corpuscle in the outer ring from a corpuscle in the collection of rings inside it is great compared with the distance of the second corpuscle from its nearest neighbour on its own ring, the effect of the outer ring of corpuscles on the inner set of rings will only “disturb” the vibrations of the latter without fundamentally altering the character of their vibrations. Thus for these vibrations, as well as for those due to the rotations, the sequence of frequencies would present much the same features for the various elements in the series; there would be in the spectrum corresponding groups of associated lines. We regard a series of atoms formed in this way, *i. e.* when the atom of the p th member is formed from that of the $(p-1)$ th by the addition of a single ring of corpuscles, as belonging to elements in the same group in the arrangement of the elements according to the periodic law; *i. e.*, they form a series which, if arranged according to Mendeléef’s table, would all be in the same vertical column.

The gradual change in the properties of the elements which takes place as we travel along one of the horizontal rows in Mendeléef’s arrangement of the elements, is also illustrated by the properties possessed by these groups of corpuscles. Thus

consider the series of arrangements of the corpuscles given on p. 258, in all of which the outer ring contains 20 corpuscles. An outer row of 20 corpuscles first occurs with 59 corpuscles; in this case the number of corpuscles inside is only just sufficient to make the outer ring stable; this ring will therefore be on the verge of instability, and when the corpuscles in this ring are displaced the forces of restitution urging them back to their original position will be small. Thus when this ring is subjected to disturbances from an external source, one or more corpuscles may easily be detached from it; such an atom therefore will easily lose a negatively electrified corpuscle, and thus acquire a charge of positive electricity; such an atom would behave like the atom of a strongly electropositive element. When we pass from 59 to 60 corpuscles the outer ring is more stable, because there is an additional corpuscle inside it; the corresponding atom will thus not be so electropositive as that containing only 59 corpuscles. The addition of each successive corpuscle will make it more difficult to detach corpuscles from the outer ring, and will therefore make the atom less electropositive. When the stability of the outer ring gets very great, it may be possible for one or more corpuscles to be on the surface of the atom without breaking up the ring; in this case the atom could receive a charge of negative electricity, and would behave like the atom of an electronegative element. The increase in the stability of the ring, and consequently in the electronegative character of the atom, would go on increasing until we had as many as 67 corpuscles, when the stability of the outer ring would be at a maximum. A great change in the properties of the atom would occur with 68 corpuscles, for now the number of corpuscles in the outer ring increases to 21; these 21 corpuscles are, however, only just stable, and would, like the outer ring of 20 in the arrangement of the 59 corpuscles, readily lose a corpuscle and so make the atom strongly electropositive.

The properties of the groups of 59 and 67 corpuscles, which are respectively at the beginning and end of the series which has an outer ring of 20 corpuscles, deserve especial consideration. The arrangement of corpuscles in the group of 59, although very near the verge of instability, and therefore very liable to lose a corpuscle and thereby acquire a positive charge, would not be able to retain this charge. For when it had lost a corpuscle, the 58 corpuscles left would arrange themselves in the grouping corresponding to 58 corpuscles which is the last to have an outer ring of 19 corpuscles; this ring is therefore exceedingly stable so that no further cor-

puscles would escape from it, while the positive charge on the system due to the escape of the 59th corpuscle would attract the surrounding corpuscles. Thus this arrangement could not remain permanently charged; for as soon as one corpuscle had escaped it would be replaced by another. An atom constituted in this way would be neither electropositive nor electronegative, but one incapable of receiving permanently a charge of electricity.

The group containing 60 corpuscles would be the most electropositive of the series; but this could only lose one corpuscle; *i. e.* acquire a charge of one unit of positive electricity; for if it lost two we should have 58 corpuscles—as when the group of 59 had lost one corpuscle—and in this case the system would be even more likely than the other to attract external corpuscles, for it would have a charge of two units of positive electricity instead of one. Thus the system containing 60 corpuscles would get charged with one, but only one, unit of positive electricity: it would therefore act like the atom of a monovalent electropositive element.

The group containing 61 corpuscles would not part with its corpuscles so readily as the group of 60, but on the other hand it could afford to lose two, as it is not until it has lost three that its corpuscles are reduced to 58, when, as we have seen, it begins to acquire fresh corpuscles. Thus this system might get charged with two units of positive electricity, and would act like the atom of a divalent electropositive element. Similarly the group of 62, though less liable even than the 61 to lose its corpuscles, could, on the other hand, lose 3 without beginning to recover its corpuscles; it could thus acquire a charge of 3 units of positive electricity, and would act like the atom of a trivalent electropositive element.

Let us now go to the groups at the other end of the series and consider the properties of the last of the series, the group of 67 corpuscles. The outer ring would be very stable, but if the system acquired another corpuscle, the 68 corpuscles would arrange themselves with a ring of 21 corpuscles on the outside; as 68 is the smallest number of corpuscles with an outer ring of 21, the ring is very nearly unstable and easily loses a corpuscle. Thus the group of 67 corpuscles, as soon as it acquires a negative charge, would lose it again, and the system, like the group of 59, would be incapable of being permanently charged with electricity—it would act like the atom of an element of no valency.

The group of 66 would be the most electronegative of the series, but this would only be able to retain a charge of one unit of negative electricity; for if it acquired 2 units there

would be 68 corpuscles, an arrangement which, as we have seen, rapidly loses its corpuscles. This group of 66 would therefore act like the atom of a monovalent electronegative element.

The group of 65 would be less liable than that of 66 to acquire negative corpuscles, but, on the other hand, it would under suitable circumstances be able to retain 2 corpuscles, and thus be charged with 2 units of negative electricity, and would act like the atom of a divalent electronegative element.

Similarly, the group of 64 would act like the atom of a trivalent electronegative element, and so on.

Thus, if we consider the series of arrangements of corpuscles having on the outside a ring containing a constant number of corpuscles, we have at the beginning and end systems which behave like the atoms of an element whose atoms are incapable of retaining a charge of either positive or negative electricity; then (proceeding in the order of increasing number of corpuscles) we have first a system which behaves like the atom of a monovalent electropositive element, next one which behaves like the atom of a divalent electropositive element, while at the other end of the series we have a system which behaves like an atom with no valency, immediately preceding this, one which behaves like the atom of a monovalent electronegative element, while this again is preceded by one behaving like the atom of a divalent electronegative element.

This sequence of properties is very like that observed in the case of the atoms of the elements.

Thus we have the series of elements :

| | | | | | | | | |
|----|----|----|----|----|---|---|----|------|
| He | Li | Be | B | C | N | O | F | Ne. |
| Ne | Na | Mg | Al | Si | P | S | Cl | Arg. |

The first and last element in each of these series has no valency, the second is a monovalent electropositive element, the last but one is a monovalent electronegative element, the third is a divalent electropositive element, the last but two a divalent electronegative element, and so on.

When atoms like the electronegative ones, in which the corpuscles are very stable, are mixed with atoms like the electropositive ones, in which the corpuscles are not nearly so firmly held, the forces to which the corpuscles are subject by the action of the atoms upon each other may result in the detachment of corpuscles from the electropositive atoms and their transference to the electronegative. The electronegative atoms will thus get a charge of negative electricity, the electropositive atoms one of positive, the oppositely charged atoms will attract each other, and a chemical

compound of the electropositive and electronegative atoms will be formed.

Just as an uncharged conducting sphere will by electrostatic induction attract a corpuscle in its neighbourhood, so a corpuscle outside an atom will be attracted, even though the atom has not become positively charged by losing a corpuscle. When the outside corpuscle is dragged into the atom there will be a diminution in the potential energy, the amount of this diminution depending on the number of corpuscles in the atom. If now we have an atom A such that loss of potential energy due to the fall into the atom of a corpuscle from outside is greater than the work required to drag a corpuscle from an atom B of a different kind, then an intimate mixture of A and B atoms will result in the A atoms dragging corpuscles from the B atoms, thus the A atoms will get negatively, the B atoms positively electrified, and the oppositely electrified atoms will combine, forming a compound such as A_-B_+ ; in such a case as this chemical combination might be expected whenever the atoms were brought into contact. Even when the loss of potential energy when a corpuscle falls into A is less than the work required to drag a corpuscle right away from B, the existence of a suitable physical environment may lead to chemical combination between A and B. For when a corpuscle is dragged out of and away from an atom a considerable portion of the work is spent on the corpuscle after it has left the atom, while of the work gained when a corpuscle falls into an atom, the proportion done outside to that done inside the atom is smaller than the proportion for the corresponding quantities when the corpuscle is dragged out of an atom. Thus, though the work required to move a corpuscle from B to an infinite distance may be greater than that gained when a corpuscle moves from an infinite distance into A, yet the work gained when a corpuscle went from the surface of A into its interior might be greater than the work required to move a corpuscle from the interior to the surface of B. In this case anything which diminished the forces on the corpuscle when they got outside the atom, as, for example, the presence of a medium of great specific inductive capacity such as water, or contact with a metal such as platinum black, would greatly increase the chance of chemical combination.

*The Existence of Secondary Groups of Corpuscles
within the Atom.*

The expression given on p. 238 for the radius of a ring of corpuscles shows that it depends on $\nu e/b^3$, where νe is the

amount of positive electrification within a sphere of radius b : thus ve/b^3 is equal to $\frac{4\pi}{3}\rho$, where ρ is the density of the positive electrification in the sphere: thus, if the density of the electrification be kept constant, the radius of the ring will be independent of the size of the sphere. Now let us take a large sphere and place within it a ring of such a size that the ring would be in stable equilibrium if its centre were at the centre of the sphere. To fix our ideas, let us take the case of three corpuscles at the corners of an equilateral triangle, and place this triangle so that its centre O' is no longer at the centre of the sphere: we can easily see that the corpuscles will remain at the corners of an equilateral triangle of the same size, and that the triangle will move like a rigid body acted upon by a force proportional to the distance of its centre from O the centre of the sphere. To prove this we notice that the repulsion between the corpuscles is the same as when the centre of the triangle is at O . The attraction of the sphere on a corpuscle P is proportional to OP , and so may be resolved into two forces, one proportional to $O'P$ along PO' (O' is the centre of the triangle) and the other proportional to OO' acting along $O'O$. Now the corpuscles are by hypothesis in equilibrium under their mutual repulsions, and the attraction to the centre proportional to $O'P$: thus the relative position of the corpuscles will remain unaltered, and the system of three corpuscles will move as a rigid body under a central force acting on its centre of gravity proportional to the distance of that point from the centre of the sphere.

The three corpuscles will, at a point whose distance from their centre is large compared with a side of the triangle, produce the same effect as if the charges on the three corpuscles were condensed at the centre of the triangle; they will thus at such points act like a unit, and the results we have previously obtained for single corpuscles may be extended to the case when the single corpuscles are replaced by rings of corpuscles which would by themselves be in equilibrium. It should be noted that the atom in which these systems are placed must be large enough to allow these rings of corpuscles—sub-atoms we may call them, to be separated by distances considerably greater than the distance between the corpuscles in one of the rings.

If we regard the atoms of the heavier elements as produced by the coalescence of lighter atoms, it is reasonable to suppose that the corpuscles in the heavier atoms may be arranged in secondary groups or sub-atoms, each of these groups acting

as a unit. When the corpuscles are done up in bundles in this way, it is possible to have stability when these bundles are arranged in a ring with a smaller number of corpuscles inside than when the corpuscles in the bundles are arranged at equal intervals round the circumference of the ring. Thus, take the case of a ring of 30 corpuscles; if these were arranged at equal intervals, 101 corpuscles would be required inside the ring to make it stable. If, however, the 30 corpuscles were grouped in ten sets of three each, only $3 \times 3 = 9$ corpuscles in the interior would be required to make the arrangement stable.

Constitution of the Atom of a Radioactive Element.

Our study of the stability of systems of corpuscles has made us acquainted with systems which are stable when the corpuscles are rotating with an angular velocity greater than a certain value, but which become unstable when the velocity falls below this value. Thus, to take an instance, we saw (p. 249) that four corpuscles can be stable in one plane at the corners of a square, if they are rotating with an angular velocity greater than $.325ve^2/mc^3$, but become unstable if the velocity falls below this velocity, the corpuscles in this case tending to place themselves at the corners of a tetrahedron. Consider now the properties of an atom containing a system of corpuscles of this kind, suppose the corpuscles were originally moving with velocities far exceeding the critical velocity; in consequence of the radiation from the moving corpuscles, their velocities will slowly—very slowly—diminish; when, after a long interval, the velocity reaches the critical velocity, there will be what is equivalent to an explosion of the corpuscles, the corpuscles will move far away from their original positions, their potential energy will decrease, while their kinetic energy will increase. The kinetic energy gained in this way might be sufficient to carry the system out of the atom, and we should have, as in the case of radium, a part of the atom shot off. In consequence of the very slow dissipation of energy by radiation the life of the atom would be very long. We have taken the case of the four corpuscles as the type of a system which, like a top, requires for its stability a certain amount of rotation. Any system possessing this property would, in consequence of the gradual dissipation of energy by radiation, give to the atom containing it radioactive properties similar to those conferred by the four corpuscles.

XXV. *The Solubility and Diffusion in Solution of Dissociated Gases.* By O. W. RICHARDSON, M.A., B.Sc., Clerk Maxwell Student and Fellow of Trinity College, Cambridge*.

THE solubility of gases which act chemically on the solvent, or which dissociate in solution, is treated in Van t'Hoff's Lectures on Theoretical Chemistry, pt. ii. p. 28 *et seq.*¹ It is there pointed out, on theoretical grounds, that gases which dissolve without chemical action, or which associate with the solvent in such a way that each aggregate contains only one molecule of the dissolved gas, obey Henry's Law of proportionality between the pressure and the mass of gas dissolved. As all gases which have been examined appear to obey Henry's Law, with the exception of ammonia, sulphur dioxide, and hydrochloric acid in water, this subject has not hitherto attracted much attention. Phenomena of this kind appear, however, to characterize the absorption of hydrogen by palladium and platinum, and, probably, of other gases by other metals (for instance, carbon monoxide by iron). The recent experiments of Winkelmann on the variation of the rate of diffusion of hydrogen through hot palladium† and platinum‡, with the driving pressure, led him to the conclusion that the hydrogen was partly dissociated into atoms, and that only the atoms were capable of passing through the hot metal. A series of experiments on the rate of diffusion of hydrogen through platinum at different pressures and temperatures has just been carried out by the author in conjunction with Messrs J. Nicol and T. Parnell, and will shortly be published. This investigation, so far as the pressure relations are concerned, has yielded results similar to those of Winkelmann, and most of the phenomena appear to be capable of explanation on the view that the hydrogen dissolves in the platinum and then dissociates (partially, at any rate) into atoms. It was in seeking an explanation of these results that the author was led to examine into the theory of the solubility of a dissociating gas and to the results which are given in the present communication.

§ 1. *Solubility Relations.*

We shall confine our attention to the case of a gas in which each molecule dissociates into n similar molecules. The same methods could, of course, be applied to a more complicated case if it should occur. The reaction which we are considering is symbolized by a chemical equation of the

* Communicated by the Author.

† Drude's *Annalen*, vol. vi. p. 104.

‡ *Ibid.* vol. viii. p. 388.

type $X_n = nX$ and takes place, to a greater or less extent, both in the solution and in the surrounding gas. In the investigation given by Van t'Hoff (*loc. cit.*) certain relations are deduced by making the dissociated portion of the gas obey Henry's Law. It is evident, however, that for a steady state not only must there be equilibrium between the free and dissolved parts of the dissociated gas, but the undissociated portion must also be governed by a similar relation. It is not sufficient for equilibrium merely to postulate equality between the total amount of gas entering and leaving the solvent in a given time. It is necessary that the amount entering and leaving should be the same for each constituent. The only alternative is to suppose the gas to enter the solution in one form, to dissociate or recombine there and leave in the other form. Such processes involve a continuous transfer of heat at a rate depending on the value of the heat of dissociation. It is thus necessary that there should be a separate relation between the concentrations of the free and dissolved portions of each constituent; this reasoning is true whatever be the nature of the relation, quite apart from its assuming the special form of Henry's Law.

We have to take into account then four different equilibrium conditions. We have two equations which determine the relation between the undissociated and dissociated constituents of the dissolved, and undissolved, gas respectively, and two more equations which make the internal concentration proportional to the external concentration of each constituent. If these relations do not hold it is easy to see that perpetual motion is obtained.

Let the suffix 0 denote the gas outside, and ι inside the solution. Let C be the concentration of the undissociated, and c of the dissociated portion. The equations which determine the equilibrium between the dissociated and undissociated portions of the gas inside and outside the solution respectively are then:

$$\frac{c_0^n}{C_0} = k_0 \quad \text{and} \quad \frac{c_\iota^n}{C_\iota} = k_\iota,$$

where k_0 and k_ι are the dissociation constants of the free and dissolved gas respectively. In general k_0 will not be equal to k_ι , as for instance in the case of an acid gas like HCl where electrolytic dissociation occurs in solution. Applying Henry's Law to each of the two constituents we get two further equations, viz.:

$$C_0 = AC_\iota \quad \text{and} \quad c_0 = ac_\iota,$$

where A and a are the inverses of the solubilities of the undissociated gas and of the products of dissociation respectively.

By eliminating the concentration from these equations we obtain an interesting relation between the constants, viz. :

$$\frac{a^n}{A} = \frac{k_0}{k_i}.$$

In other words, the solubility of the products of dissociation is determined absolutely by the solubility of the undissociated substance, together with the two dissociation constants. In the simplest case, where the two dissociation constants are equal, the solubility of the dissociation products is the n th root of that of the original substance.

These results may be confirmed and extended by treating the subject thermodynamically. We can obtain a reversible cycle, at constant temperature, as follows :—Suppose we have a cylinder whose walls are perfect conductors of heat and supplied with a piston at each end. Across the middle of the cylinder is a slice of the solution we are considering. The two sides of the slice are bounded by semipermeable membranes, one end allowing only undissociated, and the other only dissociated molecules to pass. Initially the external gas is in equilibrium with that inside the solution at both ends. Since the diaphragms are only permeable to one of the two gases present, this does not necessarily imply equilibrium between the internal and external gas at any one end as regards both constituents, but only as regards one constituent. According to the result we obtained before, this would involve equality in the total pressures as well; since, as we have already seen, there is one total pressure for which the constituent gases are in equilibrium with the internal ones. We shall show that this equality follows thermodynamically; although any further proof cannot be regarded as strictly necessary, since the result is merely a particular case of Gibbs's general theorem regarding the equilibrium of mixed systems.

Let us suppose the partial pressures of the undissociated gas (X_n) and of the dissociated gas (X) on the side permeable to X_n are P_2 and p_2 respectively, the corresponding quantities on the other side being P_1 and p_1 . Then a volume V_2 of gas is forced through the X_n diaphragm, into the solution, a corresponding quantity being withdrawn through the X side so as to maintain the total internal pressure constant. Owing to the supposed difference of pressure on the two sides, the volume V_1 withdrawn will not be the same as V_2 , but is given by the modified law of Boyle and Charles for a dissociating gas, viz. :—

$$\left(P_1 + \frac{1}{n} p_1\right) V_1 = \left(P_2 + \frac{1}{n} p_2\right) V_2 = R\theta.$$

The work done by the gas in this part of the operation is evidently

$$(P_1 + p_1) V_1 - (P_2 + p_2) V_2 = \frac{n-1}{n} (p_1 V_1 - p_2 V_2).$$

The rest of the cycle consists merely in isolating a volume V_1 of the gas at pressure $P_1 + p_1$ and expanding it isothermally at θ° till its pressure and volume become $P_2 + p_2$ and V_2 respectively.

It is evident that we have now carried out a cycle at constant temperature which is perfectly reversible at every stage. We may therefore independently equate to zero the external work done, and the total heat absorbed, by the system. On account of the complicated nature of the integrals which arise in the general case, the calculation of the work done during the expansion from volume V_1 to V_2 isothermally, has only been carried out in the case where the pressure (p) of the dissociated gas is small compared with that (P) of the undissociated. The work done in this part of the cycle is evidently

$$\int_{V_1}^{V_2} (P + p) dV,$$

where the relation between P , p , and V is given by the modified gas equation above, together with the law of dissociation

$$p^n/k_0 = P + \frac{1}{n} p (= P \text{ approximately}).$$

To this approximation

$$p = (k_0 P)^{\frac{1}{n}} = \left(\frac{k_0 R\theta}{V}\right)^{\frac{1}{n}}.$$

When the above integral is evaluated on this basis we obtain

$$R\theta \log \frac{V_1}{V_2} + \frac{1}{n} (k_0 R\theta)^{\frac{1}{n}} \left(V_1^{\frac{n-1}{n}} - V_2^{\frac{n-1}{n}} \right).$$

Adding this to the work done in the previous part of the cycle and equating the sum to zero, we obtain the following equation to determine the relation between V_1 and V_2 :—

$$\frac{V_1}{V_2} = \frac{e^{\frac{1}{n} k_0^{\frac{1}{n}} (V_2 R\theta)^{\frac{n-1}{n}}} \frac{1}{n} \frac{p_2 V_2}{R\theta}}{e^{\frac{1}{n} k_0^{\frac{1}{n}} (V_1 R\theta)^{\frac{n-1}{n}}} \frac{1}{n} \frac{p_1 V_1}{R\theta}}$$

Now $\frac{1}{n} \frac{p_1 V_1}{R\theta}$ and $\frac{1}{n} \frac{p_2 V_2}{R\theta}$ are the fractional amounts of the gas which are dissociated at volumes V_1 and V_2 respectively. By hypothesis n is $\ll 1$, *i. e.* the gas does not contract in dissociating. Hence, except when $n=1$, $\frac{1}{n} \frac{p_2 V_2}{R\theta}$ is $> \frac{1}{n} \frac{p_1 V_1}{R\theta}$ if V_2 is $> V_1$. When $n=1$, the value of $\frac{1}{n} \frac{pV}{R\theta}$ is independent of V . We see therefore that in both cases the only relation between V_1 and V_2 which satisfies the above transcendental equation is $V_1=V_2$. Hence $P_1=P_2$ and $p_1=p_2$, from which we conclude that portions of a dissociating gas which are separately in equilibrium with either of the constituents of the mixture in the same solution, are in equilibrium with one another.

We now come to the equation which is obtained when we equate to zero the sum of the quantities of heat given out in the various chemical and physical actions which take place during our cycle. We have seen already that owing to the modification in the "chemical potential" of the dissociated molecules produced by the solvent, the dissociation constant is not necessarily the same in the solution as in the free gas. For precisely similar reasons the heat given out for a given amount of dissociation is not necessarily identical inside and outside the solution. Let q_0 be the heat evolved when n gram-molecules of X unite to form X_n outside the solution, and q_i the corresponding quantity inside; let Q_x be the heat evolved when 1 gram-molecule of X gas dissolves in the solvent without recombination, and Q_{x_n} the corresponding quantity for 1 gram-molecule of X_n . By following the course of the cycle we evidently get

$$q_i + nQ_x - Q_{x_n} - q_0 = 0.$$

This equation shows, as we should expect, that q_0 is only equal to q_i in the special case when the heat of solution of n gram-molecules of X is equal to that of 1 gram-molecule of X_n .

For any reversible chemical action the variation with temperature of the reaction constant is given by the equation

$$\frac{d(\log k)}{d\theta} = \frac{Q}{2\theta^2},$$

where Q is the heat of reaction together with terms depending on the volume changes occurring. Applying this we obtain

$$\frac{d}{d\theta} (\log k_0 - \log k_i) = \frac{q_0 - q_i}{2\theta^2},$$

since the volume changes are the same for both internal and external dissociation.

But we have seen that

$$A \frac{k_0}{k_t} = a^n ;$$

whence

$$\frac{d}{d\theta} (n \log a - \log A) = \frac{nQ_x - Q_{x_n}}{2\theta^2},$$

or

$$\frac{a^n}{A} \left(= \frac{k_0}{k_t} \right) = C e^{\frac{-nQ_x + Q_{x_n}}{2\theta}},$$

where C is a constant. Thus the variation with temperature of the solubilities is determined entirely by the difference of the heats of solution of the dissociated and undissociated gas.

§ 2. *Calculation of the Rate of Diffusion.*

We now come to the problem, to which the preceding discussion is to a large extent a necessary preliminary, of the distribution, in the steady state, of a dissociating gas inside an infinite slab of solution of finite thickness, when one side of the slab is in contact with the dissociating gas at a finite pressure and the other is maintained at pressure zero. Naturally the resulting equations also lead to the rate of diffusion of the gas bodily through the slab.

In order to obtain the equations which determine the distribution of the gas in the solution, let us consider the rate of increase of the concentration inside an infinitesimal cube whose angular points are given by the necessary combination of the coordinates $x, y, z, x + dx, y + dy, z + dz$. Let C be the concentration and μ the coefficient of diffusion of the undissociated gas, c and μ_n being the corresponding quantities for the dissociated portion. Then the rate of flow of the

undissociated gas in at the x face of the cube is $-\mu \frac{dC}{dx} dy dz$.

Similarly the rate of flow in of this part of the gas at the $x + dx$ face is

$$\mu \left\{ \frac{dC}{dx} + \frac{d^2C}{dx^2} dx \right\} dy dz.$$

In this way we see that the rate of increase of the concentration C in the element of volume due to diffusion is

$$\mu \left\{ \frac{d^2C}{dx^2} + \frac{d^2C}{dy^2} + \frac{d^2C}{dz^2} \right\} dx dy dz.$$

But diffusion is not the only cause tending to change the concentration at a given point; the molecules are dissociating at a rate proportional to C and recombining at a rate proportional to c^2 . Hence the total rate of increase of C is given by

$$\frac{dC}{dt} = \mu \nabla^2 C - \beta C + \alpha c^2,$$

where α is the rate of recombination and β that of dissociation, and $\beta/\alpha = k_i$. Like considerations give us a similar equation for c , viz.:

$$\frac{1}{n} \frac{dc}{dt} = \frac{\mu_n}{n} \nabla^2 c + \beta C - \alpha c^2.$$

In the steady state

$$\frac{dC}{dt} = \frac{dc}{dt} = 0.$$

Returning to the one dimensional problem we started with let the faces of the slab be perpendicular to the axis of x and its thickness be d . Addition of the above equations gives

$$\mu \frac{d^2 C}{dx^2} + \frac{\mu_n}{n} \frac{d^2 c}{dx^2} = 0 \quad (\text{in the steady state}),$$

whence

$$\frac{\mu}{\mu_n} C + \frac{1}{n} c = A_1 x + A_2.$$

When $x = d$, $C = c = 0$, so that

$$\frac{1}{n} c + \frac{\mu}{\mu_n} C = A_1 (x - d).$$

When $x = 0$, Henry's Law gives $C_0 = AC$ and $c_0 = \alpha c$. In addition to these we have the two following relations between C_0 and c_0 , viz.:

$$c_0^n = k_0 C_0 \quad \text{and} \quad P_0 = C_0 + c_0,$$

if P_0 is the total external concentration. The equation for c_0 in terms of P_0 is therefore

$$c_0^n + k_0 c_0 = k_0 P_0.$$

Let λ_0 be a real root of this, then

$$C_0 = \frac{1}{k_0} \lambda_0^n.$$

If we determine A_1 and replace a by $\left(A \frac{k_0}{k_i}\right)^{\frac{1}{n}}$, we obtain

$$\frac{1}{n} c + \frac{\mu}{\mu_n} C = \left\{ \frac{1}{n} \left(\frac{k_1}{A k_0}\right)^{\frac{1}{n}} \lambda_0 + \frac{\mu}{\mu_n k_0 A} \right\} \left(1 - \frac{x}{d}\right).$$

The rate of flow through the unit area of the slab is therefore

$$- \left\{ \mu \frac{dC}{dx} + \frac{\mu_n dc}{n dx} \right\} = \frac{\mu_n}{d} \left\{ \frac{1}{n} \left(\frac{k_t}{A k_0} \right)^{\frac{1}{n}} \lambda_0 + \frac{\mu}{\mu_n k_0 A} \right\}.$$

This expression is independent of x , and therefore satisfies the equation of continuity.

The most important case that arises is when the dissociation is small outside the solution. In this case we may take

$\lambda_0 = (k_0 P_0)^{\frac{1}{n}}$, when the equation for the distribution of the gas becomes

$$\frac{1}{n} c + \frac{\mu}{\mu_n} C = \left\{ \frac{1}{n} \left(\frac{k_t}{A} \right)^{\frac{1}{n}} P_0^{\frac{1}{n}} + \frac{\mu}{\mu_n A} P_0 \right\} \left(1 - \frac{x}{d} \right).$$

We see that the total flow consists of two terms, one of which is directly proportional to the pressure, and the other to its n th root. The relative importance of the two terms depends on the coefficients of diffusion, the solubility and the dissociation constant. It will therefore, in all probability, vary considerably with the temperature.

By substituting the value of C in terms of c and x from the above equation in the equation

$$\frac{\mu_n}{n} \frac{d^2 c}{dx^2} + \beta C - \alpha c^2 = 0,$$

and solving the resulting differential equation, we could obtain the distribution of the separate concentrations along the thickness of the slab, but this does not appear to be of any great interest, from an experimental point of view, in the present state of the subject.

There is, of course, no need to restrict ourselves to the case where the external concentration vanishes on one side of the slab. With the same notation, if the pressure be P_0 on one side of the slab and P_1 on the other, in the case where the external dissociation is small we obtain :

$$\frac{\mu}{\mu_n} (C - A P_0) + \frac{1}{n} \left(c - a P_0^{\frac{1}{n}} \right) = \left[\frac{\mu}{\mu_n} (P_1 - P_0) A + \frac{a}{n} \left(P_1^{\frac{1}{n}} - P_0^{\frac{1}{n}} \right) \right] \frac{x}{d},$$

whence we see that the rate of flow consists as before of two terms, one of which is proportional to the gradient of the pressure and the other to that of its n th root.

Case of a Gas which combines Chemically with the Solvent.

Another case may arise in which a gas is capable of diffusing through a solid partition, viz., when the gas is capable of combining in a reversible manner with the material of which the partition is composed. For instance, we might

imagine that a cylinder of hot lime, if it could be made airtight, would still be permeable to carbon dioxide. As a rule the disintegration produced by chemical action would prevent such partitions from being effective for any length of time, but still cases of this kind are possible and must therefore be considered.

The diffusion, which takes place in these cases by the gas particles being handed from one molecule to the other, follows in general the same kind of laws as those which have first been considered. There is, however, one very important difference conditioned by the fact that, the reaction being reversible, there is a definite dissociation pressure for each temperature. When the external pressure is \geq the dissociation pressure, the whole of the superficial layer is turned into the compound, so that the solid cannot transmit a pressure greater than the dissociation pressure. Hence, if we start with a very high pressure on one side of the diaphragm and zero pressure on the other side, the pressure on the low pressure side will rise until it is equal to the dissociation pressure, when no further transference will take place. On the other hand, if the pressure on one side is always kept at zero, whilst that on the other side is capable of taking all values, then the rate of flow through will be a uniform function of the pressure up to the dissociation pressure, at which there will be a discontinuity, and the rate of flow will be independent of the pressure for all higher pressures.

XXVI. *An Instrument for Drawing Conics.* By J. R. COTTER, M.A., Assistant to the Professor of Experimental Physics, Trinity College, Dublin*.

APROPOS of Prof. Karl Pearson's article in the 'Philosophical Magazine' for February, I should like to mention that in the year 1894 I designed an instrument for drawing conics which has the advantage of always keeping the drawing-pen parallel to the direction of the curve. The compasses will draw any kind of conic, given the foci and a point on the curve. The accompanying figure is drawn from the actual instrument, but as it is only a rough home-made model it is faulty in construction.

AGBF' is a rhombus formed of four equal and freely jointed flat brass rods. The corner A slides freely along the slot of the bar BC. FH is another flat brass bar pivoted

* Communicated by Prof. John Joly, F.R.S.

to the rhombus at *G*. It is slotted for a portion of its length and slides between the rhombus and *BC*. A pencil-holder *P* moves in both slots together.

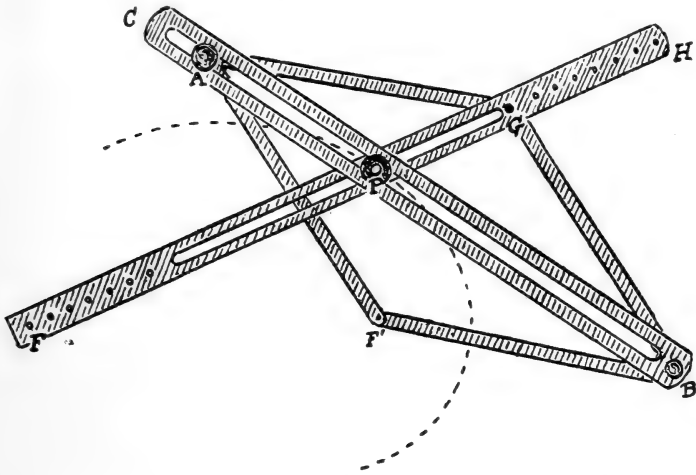

— Two pins are driven into the drawing-board at the foci of the required conic and the pencil *P* brought to a point on the curve. The corner *F'* of the rhombus is pivoted on one focus and *FH* turned round to the other focus, which can be fitted into one of the holes in *FH*. For an ellipse the second focus must be near the end *F*; for an hyperbola near the end *H*. Suppose that we wish to draw an ellipse, *F* and *F'* being the foci. By elementary geometry $PF' = PG$, therefore $FP + PF' = FG$, which is a fixed length on the rod. Thus *P* describes an ellipse. If the second focus were at *H*, we should have $HP - PF' = HG = \text{const.}$, so that *P* would describe an hyperbola with *F'* and *H* as foci.

In either case the line *AB* bisects the angle FPF' externally (or $F'PH$ internally) so that *AB* moves as a tangent to the curve. Thus if a drawing-pen were made to slide along *AB* without turning, but turning freely in the slot of *FH*, it would always keep tangential to the curve. This property is not possessed by the ingenious instrument described by Prof. Pearson. On the other hand, my instrument is open to the objection that it will only draw a little more than half an ellipse in one position. To describe the other half it must be reversed on the focal pins. Similarly, after drawing one branch of an hyperbola, it must be reversed on the pins to draw the other branch.

It is clear from the figure that perfection of design has, in the model, been sacrificed for the sake of simplicity of construction. Instead of having holes bored in FH the slot should be extended to F and another slot cut between G and H. A sliding focal pin could then be clamped in any position. Also the rhombus should have been shaped at the corners A and B so as always to leave sufficient space between the sides to allow of the pen P sliding right up to the corners, even if the rhombus is nearly closed.

To describe a parabola, F' is made the focus, and FH is moved at right angles to itself, keeping it always parallel to its original direction. Under these circumstances P describes a parabola, and G its directrix. I made no provision in my model for drawing parabolas, but I found that it would describe a very fair parabola if the flat end of F were made to slide along a fixed ruler.

I have not previously published any description of these compasses, as I hoped some time to improve the design and get a good working instrument made.

XXVII. *The Charges on Ions.* By JOHN S. TOWNSEND,
F.R.S., Wykeham Professor of Physics, Oxford*.

THE relation between the charges on ions produced in gases by various methods is a matter of some importance, as the theory of electric currents in liquids and gases which is almost universally adopted is founded on the principle that all these small subdivisions of electricity with which the ions are charged are equal to or exact multiples of some charge which is absolutely fixed. The theory is supported by the phenomena which accompany the passage of electricity through liquids, and as is well known the charges on the ions are all exact multiples of the charge on the hydrogen ion in a liquid electrolyte. The theory also holds for gases; and it can be proved that the charge on an ion produced by almost any of the known methods, in a gas, is identical with the charge on the hydrogen ion in a liquid electrolyte.

It is of interest to collect the results upon which this theory is founded, and to show to what degree of accuracy the atomic charge may be considered to be known.

If E is the charge on a hydrogen ion or atom in a liquid electrolyte, N the number of molecules per cubic centimetre

* Communicated by the Author.

of a gas at 15° C. and 760 mm. pressure, then, since a known volume of hydrogen is evolved at the negative electrode when unit quantity of electricity passes through the liquid, the formula

$$N \times E = 1.22 \times 10^{10}$$

is established, E being measured in electrostatic units.

If e is the charge on an ion in a gas, u its velocity when acted on by a force of one volt per centimetre, K the rate of diffusion of ions in the gas, it can be shown that

$$N \times e = \frac{3 \times 10^8 u}{K}.$$

This formula is derived from the kinetic theory of gases by very simple considerations, it does not involve any assumption as to the distributions of the velocities of translation of the molecules, or the law of force between molecules during a collision. It may therefore be considered very reliable from a theoretical point of view.

The values of K and u have been found experimentally in a large number of cases, so that the values of $N \times e$ may be calculated. The mean values of u for positive and negative ions produced by Röntgen rays in different gases have been found by Prof. Rutherford*. Another set of determinations of the velocities have been made by Prof. Zeleny †, using a different method in which the velocities of the positive and negative ions have been determined separately.

The values of u for ions produced by ultra-violet light have also been determined by Prof. Rutherford ‡.

The values of K have been determined by the author for ions produced by Röntgen rays, ultra-violet light, and radioactive substances §.

Taking the values of u given by Prof. Rutherford, the following values of $N \times e$ are obtained, for ions produced by Röntgen rays:—

| | |
|-------------------------|--------------------------|
| Air | 1.35 10 ⁻¹⁰ |
| Oxygen | 1.25 10 ⁻¹⁰ |
| Carbonic Acid | 1.30 10 ⁻¹⁰ |
| Hydrogen | 1.07 10 ⁻¹⁰ , |

* E. Rutherford, *Phil. Mag.* November 1897.

† J. Zeleny, *Phil. Trans.* vol. cxcv. pp. 193–234 (1900).

‡ E. Rutherford, *Cambridge Philosophical Society Proc.* vol. ix. pt. viii. (1898).

§ J. S. Townsend, *Phil. Trans.* vol. cxciii. (1899) and vol. cxcv. (1900).

the mean value of K for positive and negative ions being used.

From the values of u and K for ions in air produced by ultra-violet light

$$Ne = 1.12 \cdot 10^{-10}.$$

The following table of values of $N \times e \times 10^{10}$ may be deduced from Prof. Zeleny's determinations of the velocities:—

| | Positive ions in moist gas. | Negative ions in moist gas. | Positive ions in dry gas. | Negative ions in dry gas. |
|------------------|--------------------------------|--------------------------------|------------------------------|------------------------------|
| Air | 1.28 | 1.29 | 1.46 | 1.31 |
| Oxygen..... | 1.34 | 1.27 | 1.63 | 1.36 |
| Hydrogen | 1.24 | 1.18 | 1.63 | 1.25 |
| Carbonic Acid... | 1.01 | .87 | .99 | .93 |

The mean values of $N \times e$ for the different gases are

| | |
|-------------------------|-------------------|
| Air | 1.27 10^{-10} |
| Oxygen | 1.32 10^{-10} |
| Carbonic Acid | 1.13 10^{-10} |
| Hydrogen | 1.20 10^{-10} . |

In addition it has been shown that the values of u and K for ions in air are both inversely proportional to the pressure for pressures between 760 and 200 millimetres.

The discrepancy between the above numbers is not greater than the probable experimental errors, and they afford evidence of the equality of the charges. There is also evidence from other investigations which leads us to believe that the above values of $N \times e$ should all be equal. This may be deduced from experiments on the ionization of molecules produced by collision, which are of a much simpler kind than the experiments which are necessary for the determination either of the velocities or the rates of diffusion.

It has been shown* that the negative ions produced in gases by the action of Röntgen rays or by collisions are all exactly the same as the ions set free from a zinc plate by the action of ultra-violet light.

In order, therefore, to obtain the most probable value of $N \times e$ we are justified in taking the mean of the above

* J. S. Townsend, *Phil. Mag.* June 1902.

numbers, since there is strong evidence to show that the differences must be due to experimental errors. The value of $N \times e$ thus obtained is

$$N \times e = 1.23 \times 10^{-10},$$

e being the charge on an ion in a gas.

It has been pointed out that $N \times E = 1.22 \times 10^{10}$ where E is the charge on a hydrogen ion in a liquid electrolyte; and hence we see that the charges on ions in gases produced by various methods are equal to the charge on a hydrogen ion in a liquid electrolyte. This result depends only on the value of the product $N \times e$, and it is not necessary to rely on the determinations which have been made of these quantities separately in order to obtain a proof of the proposition.

The determinations which have been made of N and e vary over considerable ranges, and what are considered to be the most probable values of these quantities do not give the product $N \times e = 1.23 \times 10^{10}$. If one of the quantities could be determined the other would follow, since the product is known accurately; but it is difficult to decide which has been found with the greater accuracy, as in both cases there are weak points in the assumptions which are made, and in addition there is considerable experimental error in the determination of the charge e . Nevertheless, it is not unsatisfactory to find that the product only differs by a factor of about 3 from the number 1.23×10^{10} .

Lord Kelvin* has recently passed in review the various methods which have been employed to determine N †, the number of molecules in a cubic centimetre of a gas at 0° C. and standard atmospheric pressure.

From the calculations he has made it seems more probable that 10^{20} is nearer to the true value of N than 8.9×10^{19} , and it is not improbable that the true value is greater than 10^{20} . This number is deduced from the coefficient of viscosity of argon and from its densities in the liquid and gaseous states. Using the formula $NE = 1.22 \times 10^{10}$, it is seen that 1.22×10^{-10} is not improbably an upper limit to the values of the charge in electrostatic units.

The following are the values of e found experimentally by different observers:—

* Lord Kelvin, *Phil. Mag.* August & September 1902.

† This number is about 5 per cent. greater than the value of N with which we have been dealing, which refers to 15° C. and standard atmospheric pressure.

| Value of e in electrostatic units. | Method of generating the ions. | Observer. |
|--------------------------------------|---|---|
| 3.0 10^{-10} | Ions in oxygen prepared by electrolysis. | J. S. Townsend, Proc. Camb. Phil. Soc. vol. ix. pt. v., 1897. |
| 6.5 10^{-10} | Röntgen rays. | J. J. Thomson, Phil. Mag. Dec. 1898. |
| 6.8 10^{-10} | Negative ions produced by ultra-violet light. | J. J. Thomson, Phil. Mag. Dec. 1899. |
| 3.4 10^{-10} | Radium. | J. J. Thomson, Phil. Mag. March 1903. |
| 3.1 10^{-10} | Röntgen rays. | H. A. Wilson, Phil. Mag. April 1903. |

With regard to the differences between his determinations, Prof. Thomson states in his recent paper: "The mean of these values gives 3.4×10^{-10} as the charge in electrostatic units of the gaseous ion. This is about half the value 6.5×10^{-10} I found in the earlier experiments. The difference is, as I have already explained, due to the expansions in the earlier experiments practically catching only the negative ions; this made the calculated value of n little more than half the true value, while it made the value of e twice as great as it ought to have been." The number n denotes the number of drops in the cloud formed by expanding the moist gas containing the ions. It appears from Mr. C. T. R. Wilson's experiments, that condensation of moisture takes place round negative ions for a slightly smaller expansion than is required to produce condensation round positive ions*. This may be the cause of the discrepancy between the experiments with radium radiation which give the value 3.4×10^{-10} and those which were first made by Prof. Thomson with Röntgen rays. The explanation does not, however, explain the difference between the value 3.4×10^{-10} and the value 6.8×10^{-10} which was obtained for the charge on the ions produced by the action of ultra-violet light. In the latter case no positive ions were present in the gas, and the number 6.8×10^{-10} was obtained from considerations of the presence of negative ions alone.

The mean of the values, omitting the value 6.5×10^{-10} for Röntgen rays, comes to 4.1×10^{-10} .

Of the numbers in the table, that found by Dr. H. A. Wilson is probably the most reliable, and more weight ought to be given to his determination. By the method which he used he avoids the necessity of finding the number of drops in the cloud formed by the expansion of the conducting gas,

* C. T. R. Wilson, Phil. Trans. vol. exciii. p. 289.

and a very uncertain quantity is thus eliminated from his calculations. Dr. Wilson concludes from his experiments that "it may be considered established that e lies between 2×10^{-10} and 4×10^{-10} E.S. units." The lower limit is in fair agreement with the value 1.2×10^{-10} found for E by taking $N=10^{20}$. We see, therefore, that the value 2×10^{-10} does not differ by more than the factor 2 from the most probable values which can be obtained by both methods.

XXVIII. *The Conductometer.* By ROLLO APPLEYARD*.

THIS is a direct-reading instrument, intended for the comparison of electrical conductivity† of copper and other wires, for a range within, say, 5 per cent. above and 5 per cent. below 100.

In comparing two wires, either may be regarded as the standard. Suppose that balance is obtained with two samples of equal length upon a straight bridge-wire, divided into 100 parts, the position of balance being L divisions: (A) assuming the two wires to be of the same mean diameter, but of different conductivities; (B) assuming the wires to be of equal conductivity, but of unequal diameters. In case (A) it is found from the conditions of balance that a change of 1 per cent. conductivity between +5 per cent. and -5 per cent. corresponds on the average with $\frac{1}{400}$ of the total length of the bridge-wire. If therefore the middle of the bridge-wire is marked "100" and divisions are marked off from that point to right and left, each equal to $\frac{1}{400}$ of the length of the bridge-wire, these approximately correspond to successive increments of 1 per cent. conductivity. Or again, if the standard wire is not 100 per cent., move the whole scale thus graduated so that the mark on it corresponding to the conductivity of the standard is in coincidence with the electrical middle of the bridge-wire. I have proved that this arrangement is still direct-reading, and that its indications may be trusted to within a considerable degree of accuracy.

In case (B), suppose the two wires have diameters d and $(d+y)$ respectively. Then an expression for L in terms of y and d can be found. If in this expression y is given some definite value, say 1 mil, and if d is then given successive values corresponding to the whole range of diameters of wires in common use, a table or curve can be constructed showing at once the amount by which the slider must be

* Communicated by the Physical Society: read December 11, 1903.

† See "The Electrical Conductivity of Copper," *Electrical Review*, June 19, July 3 & 10, and August 14, 1903.

moved, *i. e.* the *deviation* to be applied, to compensate for 1 mil, or for any fraction of 1 mil *difference* of diameters of the two wires, for any value of d within the range. Provided that y and d are in the same unit, the expression for L is perfectly general.

These partial operations (A) and (B), when combined, represent the complete corrections to be applied within the required limits of accuracy. I have proved that the errors involved by carrying out this method for a range from 95 to 105 per cent. conductivity never exceed 0.1 per cent. In the conductometer, the two partial operations are carried out by setting two scales with reference to the electrical middle of the bridge-wire. The first scale, marked "100" at the middle, is divided into say 10 divisions, each $\frac{1}{400}$ of the length of the bridge-wire, every such division representing 1 per cent. conductivity. This scale is set to correspond with the conductivity of the standard wire, as above explained. Or the standard wire may be replaced by a resistance-coil of the same material, corresponding to the resistance of a wire of length equal to that of the test-wire of diameter d , and of say 100 per cent. conductivity, in which case the "100" mark of this scale is placed in coincidence with the middle of the bridge-wire, and is there clamped so long as that kind of wire is being tested. A second scale is divided into graduations each equal to $\frac{1}{100}$ of the total length of bridge-wire. The middle point of this scale is marked "0." A sliding contact for the bridge-wire can be set and clamped to this scale, at a point along it corresponding to the *deviation*, as above explained. This setting is to right or left of the "0," according to whether the test-wire is of greater or of less diameter than the standard wire. The *deviation* can be calculated from the mass, as well as from the diameter of the wire; the appropriate scale-setting is then given simply by "fifty times the difference of the masses, divided by the sum of the masses," for any equal lengths whatever of test-wire and standard wire, the masses being expressed in any single unit of mass whatever. For routine testing, where large quantities of copper have to be dealt with, the average time of a test for a long series of tests has by this instrument been reduced to 18 seconds, with the *diameter* method. The theory and the mechanical details of the instrument are fully described in the 'Proceedings of the Institution of Civil Engineers,' vol. cliv. Session 1902-1903, part iv. It is clear that the principle above described for compensating for differences of diameter can be applied to potentiometer work generally. If conductivity is assumed constant, the instrument can be used as a very sensitive micrometer.

XXIX. *On a Method of Mechanically Reinforcing Sounds.*
 By T. C. PORTER; M.A.*

[Plate XVI.]

IT is now about ten years since a friend, Mr. A. J. Jex-Blake, first drew my attention to the fact that if a small tuning-fork be struck and then held *in* the flame of a bunsen-burner the loudness of its note is very materially increased; at that time the explanation, though simple, did not occur to me, and although I mentioned the fact to two or three physicists, they did not suggest the cause.

That the phenomenon is not a case of ordinary resonance is proved by the fact that no increase in the loudness of the note is observed if the fork is held over the burner, either with or without the gas turned on; nor when the length of the tube of the burner is altered so that it would naturally respond, when filled with the mixture of gas and air, to the pitch of the fork employed. There is, in this case, some resonance, but it is very much fainter than the reinforcement we are considering.

Further, if the fork be held in the luminous flame from the same burner, caused by stopping up its holes, the sound is slightly louder, so that it is the action of the rarefactions and condensations of the sound-waves in the *burning* mixture of gas and air which gives rise to the increased loudness. The following experiment shows this admirably. A piece of wire gauze is supported about three-quarters of an inch above the bunsen, and the issuing mixture of gases ignited above the gauze, and the supply of gas and air so adjusted that the flame is all blue, and nearly quiet; if the fork be then held in the flame there is a very marked increase of loudness, whilst if it be held, as it easily can with a little care, between the gauze and the top of the burner, there is scarcely any augmentation of the sound.

If the various parts of a bunsen flame be explored with a sounding fork it will be found that there is the greatest effect in the hottest part of the flame, *i. e.* in that part where the most rapid chemical action is proceeding, and if experiments are made to compare the effects of the luminous and nonluminous flames of the same bunsen-burner, it appears that the latter is the more energetic, though the reinforcement caused by the former is very considerable. The effect of the sound-pulses is probably therefore to change the continuous flame of the burner into one which is more or less

* Communicated by the Physical Society: read December 11, 1903.

discontinuous, each condensation and rarefaction being attended by a corresponding increase and diminution of the rate at which the gas and air are burning, and in many cases it is easy to convince oneself that this is really the case by viewing the flame in the rotating mirror, when the appearance of the flame is similar to that of the flame in experiments such as the chemical harmonicon or Koenig's vowel flames; indeed the explanation of the effect of the sounds upon the flames in those experiments, and in those to be described, is very similar. In the well-known experiments just mentioned, however, and in Tyndall's and Rayleigh's work on sensitive flames, the flames *themselves* do not sensibly reinforce the sounds to which they are sensitive. In the chemical harmonicon, for example, in which the flame burning in an open tube may be made to give a loud note by a weak note of the same pitch sung outside the tube, it is the vibration of the *air* in the tube to which the *loudness* is due, and the note itself is chiefly determined by the dimensions of the tube. In my experiments, however, each sound-wave determines what may be called an explosion, which may give to the air a pulse of very much greater amplitude than that of the corresponding sound-pulse, and the succession of these explosions may thus reinforce the sound enormously. Three of the conditions for the maximum effect are obviously (*a*) that the mixture of gas and air shall be that for maximum force of explosion, (*b*) that each explosion shall consume as great a mass of the explosive mixture as possible, and (*c*) that the form of the flame during the explosion shall be such as to spread the disturbance through the air as advantageously as possible.

I have used for the source of the sounds an ordinary "Home" Edison-Bell phonograph, with the "reproducer" sold to be used with the instrument. In this, as every one knows, the roughnesses of the "record" make a rod vibrate up and down, and these vibrations are communicated purely mechanically to a thin disk of glass or mica, which in turn transmits them to the air on the side of the disk remote from the rod; the aerial disturbances are then conducted by means of a tube, usually to a trumpet, but in the experiments here described the reinforcement of the sounds is obtained by the combustion of coal-gas and air, and the method in which I have obtained the best results will be next described. The arrangement can most easily be understood from fig. 1. R is the "record," DD is the vibrating disk, T is the short metal tube on the upper side of the "reproducer," which is generally connected by a short piece of tubing with a trumpet.

In this case, however, it is closed with a pierced cork, into which fits a "Y" connector, one branch of which, y , is connected by tubing to the jet "a," whilst the other branch, y' , is joined to a second Y-fork, called in the diagram Z; of the two remaining branches of this one leads to an ordinary gas-supply nozzle, whilst the other is joined to a third

Fig. 1.

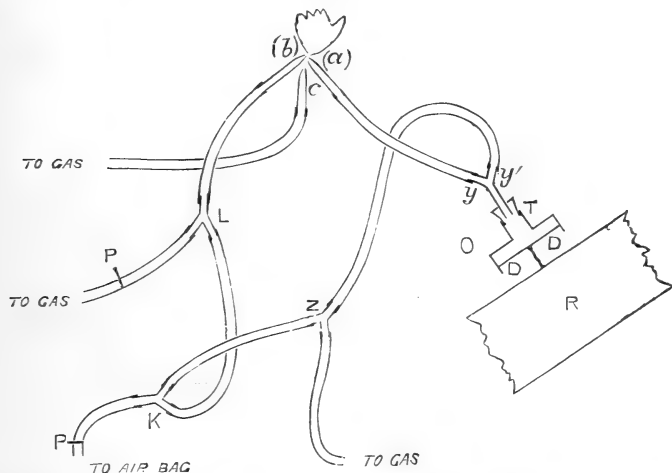

Y-piece, the stem of which is connected with a large gas-bag, containing air under very considerable pressure (generally a cwt. and a half being placed on the pressure-boards). The third arm of this Y-piece, namely K, leads to a fourth Y-piece "L," the stem of which is joined to the jet "b," whilst its other arm is connected to a second gas-supply nozzle. A small third jet c rises vertically beneath the other two, and almost touches them; this is joined by tubing to a third gas-supply nozzle. P, P, P, are screw pinch-cocks. The jets I have used have hitherto been made of glass, and in fig. 2 they are drawn life-size—in (a) a vertical section, in (b) as seen when viewed from a point immediately above them. In both these figures the relative positions and dimensions of the jets have been carefully depicted. The third jet c , fig. 1, is an ordinary glass jet, and, so far as I have seen, need not be of any special dimensions or shape, but b and a should be made as nearly as possible as drawn. Ordinary black indiarubber-tubing serves well for the connexions, and for the three-way pieces, those sold by the Edison-Bell Phonograph Co., 39 Charing Cross-road, serve very well. In using the apparatus the gas should be turned on

first, and lit at the jets (*a*) and (*b*), and these, if of glass, should be allowed a little time to grow warm before the pinch-cock admitting air from the gas-bag to the jets is unscrewed: this should be done very gradually, and the gas and air which issues at jet (*a*) adjusted until the issuing flame is quite blue.

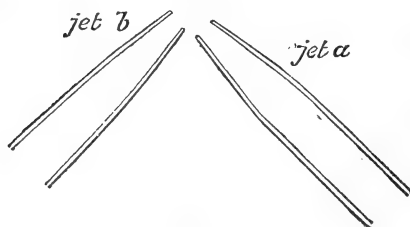
Fig. 2 (*a*).Fig. 2 (*b*).

The jet *c* should then be lighted and turned down very low. Jet *b* is then brought into the position in which it gives the loudest sound, and the final adjustment of the gas and air passing through (*b*) made by very gradually opening the pinch-cock which regulates the supply of air from the bag: if the reinforcement of the sound is still unsatisfactory, the supply of gas to (*b*) should be gradually shut off. In some instances the best results are obtained when almost pure air is issuing from *b*. If the jets hiss and roar, as they are at times wont to do, *c* may be turned up a little higher, or the position of jet *b* may be very carefully shifted further into, or away from the flame from jet *a*, or moved slightly from or towards jet *a*: in practice the adjustments are not difficult, and when all is right the reinforcement of the tones of the phonograph is very striking, being quite equivalent to the use of a small trumpet, and easily heard all over a fairly large room. Fig. 3 (Pl. XVI.) is the stereoscopic photograph of the flame, '37 times life-size, when it is in a condition to "play" well, and fig. 4 is a photograph of the general arrangement of the apparatus taken whilst the flame was "playing."

It will naturally be supposed that if pure oxygen is used instead of air the results will be better: I have made the experiment, with the expected result, but the difference is not so great as one would expect, and in practice the manipulation of the jets is made so much more difficult, to say nothing of the increased cost, that I do not recommend the experiment. Ethylene and acetylene in place of coal-gas I have not tried, but there is no reason for supposing that they would yield much better results than those already obtained.

It would be unnecessary and tedious to describe all the experiments which led me to adopt the above arrangement, but there are one or two of interest that it may be as well to mention. If jet (*a*) in fig. 1 is used alone, the branches of the three-way piece Z being put into connexion with the air-bag and the gas supply respectively, a common blowpipe-flame can easily be obtained from (*a*), and this will be found to sing, but not nearly so loudly as the flame already spoken of: the blue tip of the inner cone can be seen shooting in and out as it emits the different sounds. If now a thin sheet of platinum-foil be brought into this part of the flame, the sound is very markedly reinforced, the tones given out by the hot platinum being very "round," smooth, and pleasant to the ear, though, as I have already said, they are not loud. I attribute this reinforcement to the rapid expansion and contraction of the platinum in response to the variation in the heat of the flame caused by the sound-waves from the phonograph, and not to simple reflexion of these waves from the platinum surface. The well-known surface action of the metal may also play some part in the phenomenon, although there is no reinforcement, if, whilst the platinum is in position and sounding, the blowpipe-flame is blown out: the platinum, under these circumstances, remains at a yellow heat, from the combustion of the unignited gas and air on its surface, but there is no sound until the flame is rekindled.

Finally, the action of the flame in reinforcing sounds originally of equal loudness but of different pitch deserves notice. This can be generally stated as follows:—The smaller the flame the more rapid the current of air or of gas, or of both; or the more jet (*b*) is made to encroach on jet (*a*) in fig. 2 (*b*), the higher is the pitch to which the flame most readily responds and reinforces, and *vice versa*: but it is very remarkable how wide a range of pitch the tones may have which are reinforced at one and the same time, so that it is possible and easy in the case of a phonograph record in which the high-pitched notes have been recorded too strongly, to lessen their loudness, or, indeed, to eliminate them altogether without seriously interfering with the other notes: on the other hand, if it is the base which is too prominent, this may be reduced, whilst additional strength is added to the treble.

I do not think that it is too much to say that these facts*

* *Note*.—Since the reading of this paper, the writer has been much indebted to Mr. Chichester Bell for calling his attention to a communication of Mr. Bell's, read before the Royal Society, and published in the 'Transactions' of that Society, 1886, Part 2, and entitled "The Sympathetic Vibrations of Jets." It appears that as early as 1866 Kundt obtained musical tones by the impact of two flames, and of an air-jet

place at our disposal a method of reinforcing sounds possessing some special advantages, and may prove capable of increasing faint sounds so that many can hear them at once, to a degree beyond that attained by any other method at present known.

Eton, Oct. 1903.

XXX. *The Photographic Action of Radium Rays.* By S. SKINNER, M.A., *University Demonstrator in Experimental Physics at the Cavendish Laboratory, Cambridge* *.

IT is well known that a photographic plate by exposure to Radium rays is affected in such a way that the plate develops similarly to its development after exposure to light. The following experiments are an attempt to answer the question: Are the actions the same? As far as can be seen by eye, plates exposed to the two agents appear on development to be darkened in a similar way, and we may conclude that the final result of the actions and of the development is the same. I have attempted to obtain information of the intermediate stages, and some of the experiments described below appear to indicate that only slight differences occur in these early stages. I shall describe the experiments in the order in which they may be best understood, although this was not the order in which they were made.

A plate, inclosed in two envelopes of paper, one red and the other black, was placed under a capsule containing 10 milligrammes of radium bromide at a distance of 1 centimetre from the plate for periods of time varying from half a minute to 48 hours. A different part of the plate was

against a flame. Barrett and Tyndall were apparently the first to notice that a sensitive flame sometimes reproduces the tones by which it is affected. In 1875 Decharme found that carbon dioxide blown through a jet against a flame gave a feeble effect, and attributed this to the decomposition of the CO_2 —a chemical explanation. He also found that pure oxygen gave only a feeble effect in comparison with air, and that nitrogen gave no effect at all. Mr. Bell himself, by boring a small hole in a telephone-plate, and forcing through it, at a gentle pressure, a stream of air which impinged on a small flame, *reinforced* the otherwise inaudible sounds of the telephone till they could be distinctly heard over a small room. The explanation of the reinforcement,—founded by Mr. Bell on a long series of delicate and beautiful experiments, including the measurement of the relative pressures at different points in and near the jets,—seems to be a purely physical one. The actual experiments as described in the present paper are, however, new, so far as the author can ascertain—though Mr. Bell has experimented on the use of flames in connexion with the graphophone, and took out a patent thereon in 1886.

* Communicated by the Physical Society: read January 22, 1904.

presented to the radium for each period of time. It was then developed in alkaline hydroquinone for three minutes, and the intensities of the developed images were compared by means of a commercial densitometer. A similar experiment was also made with 50 milligrammes of radium bromide. For most of the experiments a red label rapid Ilford plate was used, and in a few a 'Lumière' plate.

The general result of these experiments showed that the intensity of the developed image increased rapidly to a maximum value, then decreased rapidly, and finally the intensity decreased very slowly until a stage was reached in which there was practically no dark image formed on development. The time of exposure required to reach the maximum depended on the mass of the radium bromide used, that with 50 mgr. being earlier than with 10 mgr. In fact, after 40 hours' exposure the effect on the plate might be compared to the complete reversal of image obtained when a plate is very much over-exposed to a bright light. The following curves refer to Ilford red label rapid plates, I. exposed respectively to 50 mgr. and II. to 10 mgr. (fig. 1). With this class of plate the maximum was reached

Fig. 1.

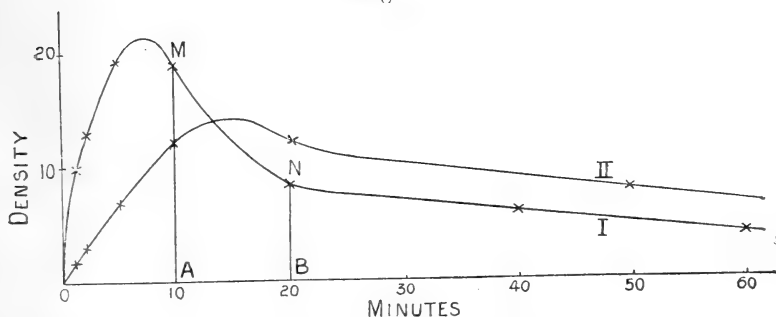

in 15 minutes with 10 mgr. of radium bromide, and in 7 or 8 minutes with the 50 mgr. With Lumière plates the maximum was reached in about 2 hours, see fig. 2 (p. 290).

To verify the result that an exposure greater than a certain critical value will produce a less dense image, the following experiment was made. A slit was cut in a thick sheet of lead and a covered photographic plate was placed below it. It was then exposed to radium rays for 10 minutes. Then the lead plate was removed, and the plate was exposed for a further period of 10 minutes. In this way the parts opposite the open slit received altogether 20 minutes'

exposure, whilst the protected parts were exposed only for half that time. On development the slit appeared as a light line crossing a dark field. This result follows at once from the diagram (fig. 1), for if OA represents the 10 minutes' exposure the density will be AM, and for a time exposure OB the density is BN, a value less than AM.

Here it will be recognized that the action on the plate is like that of light, for an overexposure produces a fainter image. The action, however, is more under control as its rate is slower.

Fig. 2.

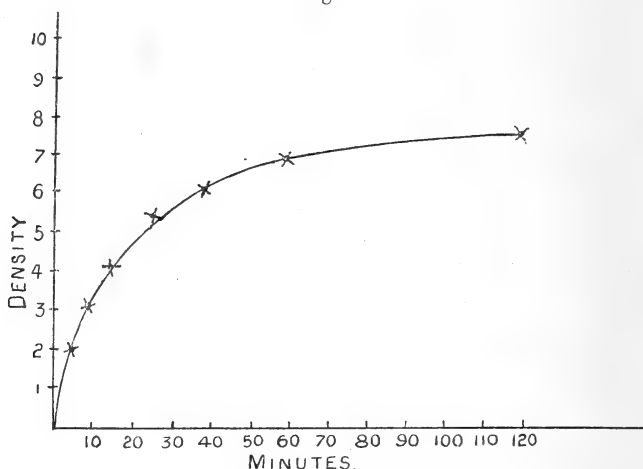

From the arrangement of the radium * I am inclined to think that the α -rays were all absorbed before reaching the plate, and that we have to consider the action as coming from the β - and γ -rays alone, these two sets of rays having much more penetrating properties than those of the α group.

The next experiments were made with the view of finding out whether a plate exposed to the light of an electric spark would undergo any reversal if it was afterwards exposed to radium rays. In fact, I tried to obtain a reversal effect similar to that got by Clayden, by exposing a plate first to electric sparks and then to faint gas-light, only I substituted radium rays for the after-exposure to faint light. Clayden showed that it was easy to reverse the images of bright sparks by exposing the plate subsequently to a gas-flame for a few seconds. In this way he explained the reversed images

* The radium bromide was contained in an ebonite capsule covered with a thin mica plate. The rays passed through the mica.

of lightning-flashes which are obtained when several images are taken on one plate, or when images are obtained of lightning-flashes with a bright cloud behind them.

In my experiments an Ilford plate (red label) was exposed in a camera to a series of Wimshurst machine sparks, the plate being shifted between each spark. Then the plate was placed in its envelopes, and a part of it was protected by a thick leaden screen. The rest of the plate was exposed to the radium. This was repeated for different periods of radium exposure. On developing these plates, it was found that in those which had been exposed to the radium for only short periods, gradually increasing in length, there was a progressive elimination of the spark image, but the density of the parts corresponding to the radium exposure was not so great as that of the parts of the plate only exposed to the spark, although the radium action had been able to obliterate completely the spark effect. On the other hand, when those plates which had been exposed longer, or had been exposed to the greater mass of radium, were developed, I found that reversed images of the sparks appeared. These images were not so wide as the spark images. In another case, with still further exposure, I observed the radium reversing its own image, and across the radium reversed part of the plate there appeared a faint dark image of the spark. This might be described as a re-reversal of the spark.

The conditions of these experiments were such that probably only the β - and γ -rays were acting. In the *Philosophical Magazine* for November, 1903, a paper appears by R. W. Wood, on the subject of photographic reversal, and in it he says that he has been unable to reverse a spark-image by Röntgen rays, which are supposed to be similar, if not identical with the γ radium rays. If this is the case we must ascribe the reversal, which I have described as produced by radium, to the action of the β -rays alone. This point, however, needs further investigation with screens capable of cutting off each class of rays.

In Wood's paper he gives what may be called a reversal order. It is :—Pressure-marks, x -rays, Light-shock, Lamplight. In this order each successive influence is able to reverse those before it. He also states that Becquerel rays will reverse pressure-marks, and that lamplight will reverse the effect of Becquerel rays. The Becquerel rays which he used were probably those from a compound of uranium. My experiments show that Light-shock (from an electric spark) may be reversed by Radium rays, and consequently

Radium rays may be inserted provisionally between Light-shock and Lamplight in the above order.

Conclusions.

1. The density of the image produced on a plate by exposure to radium rays (β and γ) increases to a critical value and then decreases, at first rapidly and afterwards very slowly, until a time is reached when the image is totally reversed.

2. Spark-images are at first obliterated by radium rays which do not cause such a great density as that of the spark-images obliterated.

3. With prolonged exposure radium rays reverse spark-images.

I am greatly indebted to Mr. Hayles, of the Cavendish Laboratory, for carrying out many of the experiments described in this paper.

XXXI. *On Deflexions of the Plumb-line in India.* By Major S. G. BURRARD, R.E., Superintendent of the Trigonometrical Surveys of India*.

IN the Philosophical Magazine for January 1904, the Rev. O. Fisher gives his reasons for thinking that the Indian pendulum results do not support my suggestion, that a chain of excessive density, many hundreds of miles long, lies hidden in the Earth's crust in Upper India. As Mr. Fisher's paper has been read by many with interest, I would ask to be allowed to explain my reasons for having omitted to refer to the pendulum results in the original paper on the subject. Those reasons may be stated as follows:—

1. The correctness of the Indian pendulum results has been questioned by the highest living authorities (*vide* Colonel Clarke's 'Geodesy,' and Professor Helmert's report to the International Geodetic Conference, 1901).

2. The supposed hidden chain of excessive density is between 1000 and 2000 miles long; one line of pendulum stations crosses this chain at right angles. We cannot get any fair idea of the mass of a chain from the results of a single traversing line.

3. The pendulum stations on this line of observation are too far apart to allow of conclusions being formed.

Mr. Fisher's conclusion that there is a marked negative variation of gravity over the whole of India, cannot be

* Communicated by the Author.

disputed, but when I suggested that a chain of excessive density underlay certain named places, I was using the word "excessive" relatively to the surrounding portions of the Earth's crust in India. It is a question therefore not so much of the negative variation over India compared with Europe, as one of internal variations in India itself.

The pendulum observations in India show, if for the moment we exclude considerations of height, that there is a greater excess of matter in the crust under the two stations of Usira and Kalianpur than under any one of the other twenty inland stations in India. Of these two stations, Kalianpur is the one and only station situated on the line of the supposed underground chain of excessive density. Now the position of this line was deduced from the results of Astronomical observations, which are affected by horizontal attractions only. I think it is a significant coincidence that the pendulum results should show a maximum value of vertical force at the one station situated on the line derived independently from astronomical observations.

Mr. Fisher thinks that the significance of this coincidence is lessened by the fact, that the same maximum value of vertical force has been observed at one other station, Usira, as well as at Kalianpur. But I do not think that the observations at Usira tell so much against the existence of a chain as the observations at Kalianpur tell in favour of it.

Pendulum observations show the excess or deficiency of matter in the crust immediately under the station, but they give no clue as to the length or breadth of the matter, in which the excess or deficiency occurs. The attraction of an infinitely extended plain of rock of 1000 feet thickness is $1^{\text{s}}.56$; if the plain of rock be limited in area to a circle of 7 miles radius, the observing station being at the centre, its attraction is still $1^{\text{s}}.56$. The distances apart of the Central Indian pendulum stations, given in Mr. Fisher's list, are as follows:—

| | |
|--------------------------------|------------|
| Badgaon to Ahmadpur | 200 miles. |
| Ahmadpur to Kalianpur | 36 " |
| Kalianpur to Pahargarh | 57 " |
| Pahargarh to Usira | 141 " |
| Usira to Datairi | 124 " |

Average distance apart . . . 112 miles.

The fact that the vertical force of gravity is the same at Usira as at Kalianpur shows that the same amount of matter underlies each; but Usira may overlies a small island of excessive density, and Kalianpur may be situated over a long

wide chain of similar density. Pendulum observations at a single station do not tell us whether it overlies an island or a chain. A gravimetric survey with pendulum stations at every 20 miles is required.

I have so far been excluding all considerations of height. Experience has shown that pendulum observations give as a rule a result more closely agreeing with the theoretical result, when the station of observation is at a low altitude than when it is at a high elevation. The higher the station, the greater is the deficiency of the observed force of gravity generally found to be. This phenomenon has been explained by the hypothesis that extra height is generally compensated by a corresponding subterranean deficiency of matter. Hence, when observations come to be reduced to sea-level, it is almost always found, that the largest negative variations occur at the highest stations. Now, when we come to compare Kalianpur and Usira, the table given by Mr. Fisher shows that Kalianpur is nearly 1000 feet higher than Usira; it is therefore a somewhat surprising fact, that the negative variation at Kalianpur should not be some two seconds greater than the negative variation at Usira. This consideration of heights would seem to show us, that the amount of matter in the Earth's crust at Kalianpur is considerably more than at Usira, notwithstanding that the force of gravity when reduced to sea-level has the same value at both places. If the values of heights are included in the discussion, we find that a greater amount of matter underlies Kalianpur than any other station in the plains of India. As I stated above, Kalianpur is the only pendulum station situated on the line of the chain. In the face of this coincidence, it cannot fairly be held that the pendulum results tell against the existence of a chain.

Seeing that the accuracy of the old pendulum results has been questioned, and that a new series of pendulum observations is about to be commenced, I would beg all those interested in the subject to suspend judgment for the present.

Dehra Dun, January 28, 1904.

XXXII. *On the Transfinite Cardinal Numbers of Number-Classes in General.* By PHILIP E. B. JOURDAIN, B.A.,
 ✓ Trinity College, Cambridge*.

IN this continuation of my paper † "On the Transfinite Cardinal Numbers of Well-ordered Aggregates," to which reference was made in § 10 of that paper, I shall begin

* Communicated by the Author. † Phil. Mag. vol. vii. p. 61 (1904).

by proving (§ 1) that the cardinal number of the third number-class (\aleph_2) is the next greater cardinal number to \aleph_1 . Cantor has already done this for \aleph_1 and \aleph_0 , and has not done this in detail for any other Alephs; though there are only the generalizations introduced by having to deal with series of the type of the second number-class instead of series of type ω . The proof depends on the fact that

$$\aleph_1 \cdot \aleph_1 = \aleph_1,$$

which is proved directly. There is no great difficulty in advancing to \aleph_ν , \aleph_ω , and to any \aleph_γ^* , so that the theorem

$$\aleph^2 = \aleph$$

is proved for any cardinal number \aleph .

This gives certain information as to the constitution of any number-class \dagger (§ 3). According as the corresponding cardinal number has or has not an immediate predecessor, the class is built up in one of two ways from the lower number-classes.

Finally, such equations as

$$\aleph^{\aleph} = 2^{\aleph}$$

are proved, by the results in the addition and multiplication of transfinite cardinal numbers which have been hitherto obtained, to hold if \aleph is any transfinite cardinal number (§ 4).

1.

If we denote by ω_1 the first number of the third number-class, the whole class is formed as follows:—First after ω_1 comes the series represented by

$$\{\omega_1 + \alpha\},$$

where α takes, in order of magnitude, the values of all the numbers of the first and second number-classes. Next after this series comes the number

$$\omega_1 + \omega_1 = \omega_1 \cdot 2,$$

which is followed by the series

$$\{\omega_1 \cdot 2 + \alpha\};$$

* A doubt as to whether Cantor's second principle of generation can lead to numbers γ beyond the second number-class, which seems to have been held by Schönflies, is, I think, settled below (§ 2).

† The notation ω_γ is used for the first ordinal number of the $(\gamma+2)$ th class. This notation (which is borrowed from Russell, *cf.* 'The Principles of Mathematics,' Cambridge, 1903, p. 322) is necessary when we deal generally with the γ th number class. Cantor has only hitherto had to use a notation for what is here called ω_1 : he wrote Ω .

and so on. It is evident that the numbers of the first and second number-classes, arranged in order of magnitude, are ordinally similar to the series

$$\{\omega_1 + \alpha\}.$$

We may then conclude, in a precisely similar way to that in which Cantor* has proved that any part of the second number-class has a cardinal number which is either finite, or \aleph_0 , or that of the second number-class, that any part of the third class has a cardinal number which is either finite, or \aleph_0 , or \aleph_1 , or that of the whole third class. Thus, we have, and have only, to prove that this last cardinal number is not \aleph_1 , in order to complete the proof that the cardinal number of the third class is the next greater one to \aleph_1 , and is thus properly denoted by \aleph_2 .

For this purpose, we must prove † that if we supposed that all numbers of the third class could be arranged in a well-ordered series of cardinal number \aleph_1 , we could define a number which belongs to the third class but not to this series. From this contradiction we must conclude that the cardinal number of the third class is not \aleph_1 ‡.

Suppose, then, that all the numbers of the third class could be arranged in a series of type ω_1 (of course, not in order of magnitude), as would be possible if the third class were of cardinal number \aleph_1 . Now any series (not necessarily arranged in order of magnitude) $\{\beta_\alpha\}$ of type ω_1 of numbers of the third class has either a greatest number or else there is a number of the third class such that it is both the upper limit and a Limes § of $\{\beta_\alpha\}$ when the latter is arranged in

* 'Grundlagen,' pp. 37-38; *Math. Ann.* xlix. pp. 228-229.

† Cf. Cantor, 'Grundlagen,' pp. 35-36; *Math. Ann.* xlix. pp. 227-228.

‡ This method, which Cantor has used to prove that

$$\aleph_1 = 2^{\aleph_0}, > \aleph_0, \aleph_1 > \aleph_0, \text{ and } 2^{\aleph_1} > \aleph_1;$$

fails if we try to prove that $\aleph_1 > \aleph_1$. Since, then, $\aleph_1 \leq \aleph_1$, we have some grounds for believing that $\aleph_1 = \aleph_1$.

§ It appears to me necessary to distinguish the two different concepts of limit by two different words such as *limit* and *Limes*. These conceptions are, as is evident from their use in the general theory of ordinal types, purely ordinal, but it is in the theory of real numbers and their functions that their application is most important. Any infinite manifold of real (or complex) numbers has at least one point of condensation (Weierstrass), and each of these points (which always exist, e. g., when the elements of the manifold are real numbers), which are the points of Cantor's "first derivative," is called a *Limes*. Especially important among the *Limite*s are the greatest and least *Limes* (which always exist,

the (in general different) order of magnitude. This is proved in the following manner :—

Let β_{x_2} be the first number in $\{\beta_\alpha\}$ (arranged, as at first, in a series of type ω_1) which is greater than β_1 , β_{x_3} the first greater than β_{x_2} , and so on ; so that there is determined in $\{\beta_\alpha\}$ a series, of type ω_1 at most,

$$\beta_1 < \beta_{x_2} < \beta_{x_3} < \dots < \beta_{x_\omega} < \beta_{x_{\omega+1}} < \dots < \beta_{x_{\omega.2}} < \dots \quad (1)$$

where also

$$1 < x_2 < x_3 < \dots < x_\omega < x_{\omega+1} < \dots < x_{\omega.2} < \dots \quad .$$

Then, either there is a number β_{x_a} in (1) such that all the numbers following it in $\{\beta_\alpha\}$ are less than it,—in which case β_{x_a} is evidently the greatest number of $\{\beta_\alpha\}$,—or we employ the following argument. By completing the series (1) by intercalating, in order of magnitude, all the numbers $\{\gamma\}$ of the first three classes such that

$$\gamma < \beta_1, \beta_{x_a} < \gamma < \beta_{x_{a+1}},$$

we get a definite part of the first three classes, which is at most of cardinal number

$$\aleph_i \cdot \aleph_1 ;$$

we can then prove the existence of an upper Limes, of the third class, of series (1), and consequently of a number of the third class not in $\{\beta_\alpha\}$, if we can prove that

$$\aleph_1 \cdot \aleph_1 = \aleph_1 ;$$

we shall, then, have proved that the cardinal number of the third class is the next greater one to \aleph_1 , when we have proved this equation.

For this purpose, we shall extend the method for proving that

$$\aleph_0 \cdot \aleph_0 = \aleph_0$$

by the diagonal enumeration of a double series to the case in which each single series is of type ω_1 instead of type ω .

since the derivatives contain all their points of condensation). The (upper) *limit*, on the other hand, may be either the upper Limes or the greatest value not a Limes, if such exists, of the manifold considered. Thus, the two concepts are not in general coincident. The importance of the notion of a continuous function arises partly from the fact that the (upper) Limes is the (upper) limit, and inversely.

In fact, consider a double series $(u_{\alpha, \beta})$, of which each line and each column is of type ω_1 :

$$\left. \begin{array}{cccccc} u_{1,1}, & u_{1,2}, & \dots & u_{1,\omega}, & u_{1,\omega+1}, & \dots & u_{1,\beta}, & \dots \\ u_{2,1}, & u_{2,2}, & \dots & u_{2,\omega}, & u_{2,\omega+1}, & \dots & u_{2,\beta}, & \dots \\ \dots & \dots & \dots & \dots & \dots & \dots & \dots & \dots \\ \dots & \dots & \dots & \dots & \dots & \dots & \dots & \dots \\ u_{\omega,1}, & u_{\omega,2}, & \dots & u_{\omega,\omega}, & u_{\omega,\omega+1}, & \dots & u_{\omega,\beta}, & \dots \\ u_{\omega+1,1}, & u_{\omega+1,2}, & \dots & u_{\omega+1,\omega}, & u_{\omega+1,\omega+1}, & \dots & u_{\omega+1,\beta}, & \dots \\ \dots & \dots & \dots & \dots & \dots & \dots & \dots & \dots \\ \dots & \dots & \dots & \dots & \dots & \dots & \dots & \dots \\ u_{\alpha,1}, & u_{\alpha,2}, & \dots & u_{\alpha,\omega}, & u_{\alpha,\omega+1}, & \dots & u_{\alpha,\beta}, & \dots \\ \dots & \dots & \dots & \dots & \dots & \dots & \dots & \dots \\ \dots & \dots & \dots & \dots & \dots & \dots & \dots & \dots \end{array} \right\} ; \quad (2)$$

we shall determine a series (a_γ) of type ω_1 such that there is a one-one correspondence between this (simple) series and the double series $(u_{\alpha, \beta})$.

The series (a_γ) is formed by diagonal enumeration of (2) ; thus to the terms

$$u_{1,1}, u_{1,2}, u_{2,1}, u_{1,3}, u_{2,2}, \dots$$

correspond respectively

$$a_1, a_2, a_3, a_4, a_5, \dots$$

and the general relation between (a_γ) and $(u_{\alpha, \beta})$, when α, β, γ are finite integers, is *

$$\gamma = \alpha + \frac{1}{2}(\alpha + \beta - 1)(\alpha + \beta - 2). \quad \dots \quad (3)$$

When α and β are such that

$$1 \leq \alpha < \omega, \quad \omega \leq \beta < \omega \cdot 2,$$

and

$$\omega \leq \alpha < \omega \cdot 2, \quad 1 \leq \beta < \omega,$$

the manifold $(u_{\alpha, \beta})$ is still of cardinal number \aleph_0 , and can consequently be made to have a one-one correspondence with the series

$$a_\omega, a_{\omega+1}, \dots, a_{\omega+\nu}, \dots,$$

* This formula was stated by Cantor, *Journ. für Math.* Bd. lxxxiv. (1878), Satz (C') of § 8; *Math. Ann.* Bd. xlvi. p. 494; and a simple proof and a generalization for multiple series was given by me ("On unique, non-repeating, integer-functions," *Mess. of Math.* May 1901).

where ν is any finite ordinal number*. Proceeding in this way, we establish a one-one correspondence between the double series $(u_{\alpha, \beta})$, where

$$\alpha + \beta < x$$

(x being some definite number of the second class), and the series (a_γ) , where

$$\gamma < x$$

For example, in the above first two stages of the enumeration, when α and β are either both finite or such that

$$1 \leq \alpha < \omega, \omega \leq \beta < \omega \cdot 2,$$

or

$$\omega \leq \alpha < \omega \cdot 2, 1 \leq \beta < \omega,$$

it is easily seen to be necessary and sufficient that ...

$$\alpha + \beta < \omega \cdot 2.$$

The general determination of the terms of $(u_{\alpha, \beta})$ which have been enumerated at any stage is, then, exactly analogous to that determination when each row and each column is of type ω . In the latter case †, at any of the stages marked by the complete enumeration of a diagonal, the terms of $(u_{\alpha, \beta})$ enumerated are those for which

$$\alpha + \beta < \nu.$$

where ν is some finite ordinal number.

Every term of the whole series $(u_{\alpha, \beta})$ is evidently such there is some number x of the first or second number-class such that

$$\alpha + \beta < x;$$

and consequently the correspondent of every term $u_{\alpha, \beta}$ is some term a_γ , where γ is a definite number of the first or second number-class.

* In the actual construction of a relation like (3), we may proceed as follows:—To $(u_{\alpha, \beta})$, where $1 \leq \alpha < \omega, \omega \leq \beta < \omega \cdot 2$, let the simple series (a'_γ) correspond, by letting the term $a'_{\omega+\lambda}$ correspond to the term $u_{\mu, \omega+\nu}$ where

$$\lambda = \mu - 1 + \frac{1}{2}(\mu + \nu)(\mu + \nu - 1),$$

λ, μ , and ν being finite ordinal numbers. Again, let $a''_{\omega+\lambda}$ correspond to $u_{\omega+\mu, \nu}$ of $(u_{\alpha, \beta})$ when $\omega \leq \alpha < \omega \cdot 2, 1 \leq \beta < \omega$, where

$$\lambda = \mu + \frac{1}{2}(\mu + \nu)(\mu + \nu - 1).$$

Finally, let $a'_{\omega+\lambda} = a_{\omega+\lambda} (\lambda = 0, 2, 4, \dots)$, $a''_{\omega+\lambda} = a_{\omega+\lambda} (\lambda = 1, 3, 5, \dots)$.

† Cf. my paper already quoted, p. 4 and note.

Hence

$$\aleph_1 \cdot \aleph_1 = \aleph_1;$$

and the process can evidently be generalized so as to prove, by complete induction, that

$$\aleph_\nu \cdot \aleph_\nu = \aleph_\nu \quad (4)$$

where ν is any finite ordinal number.

2.

We have next to show that

$$\aleph_\omega \cdot \aleph_\omega = \aleph_\omega \quad (5)$$

Now, \aleph_ω is the cardinal number of that well-ordered manifold whose type is ω_ω ; that is to say, of the series

1, 2, ..., ν , ... ω , $\omega + 1$, ... $\alpha_1 \dots \omega_1$, ... $\omega_1 + \alpha$, ... ω_2 , ... ω_ν , ...

The extension of the method of § 1, in which extension the equations (4) are used, to this case is obvious, and the equation (5) follows. But now we are certain that the equation

$$\aleph_\gamma \cdot \aleph_\gamma = \aleph_\gamma \quad (6)$$

where γ is any ordinal number, holds; for the extended method of diagonal enumeration of a double series allows us to conclude, from equations (like (4)) holding for the Alephs of a series of ordinal numbers, to an equation (like (5)) holding for the Limes-number of these ordinal numbers.

But, that the equation (6) may be seen to be really general, and not to hold merely for numbers γ of the first and second class, it is necessary to assure ourselves that Cantor's first and second principles of generation do really * lead to *all* ordinal numbers (while the third principle defines the number-classes). For Schönflies † seemed to state that the first two principles only lead to numbers of the first two classes, and that we require a *new* principle to get the numbers of the third class.

However, since this new principle is merely to postulate Limes-numbers for an increasing series of ordinal numbers also in the case that the series is of type ω_1 , and the concept of Limes-number for a well-ordered series ‡ does not presuppose that the series has necessarily for type a number of the second class, it appears that no new principle is required to get to any number of the aggregate W of all ordinal numbers arranged in order of magnitude.

* This seems to be stated in the 'Grundlagen,' pp. 3, 34.

† "Die Entwicklung . . ." p. 48 (1900).

‡ See *Math. Ann.* Bd. xlix. pp. 218-219; cf. *ibid.* Bd. xlvi. p. 509.

The equation (6) is, then, quite general; and, since every transfinite cardinal number is an Aleph, we can state generally: If \mathfrak{a} be any transfinite cardinal number, then

$$\mathfrak{a}^2 = \mathfrak{a} = \mathfrak{a}^\nu,$$

where ν is any finite cardinal number; or, if \mathfrak{b} is any cardinal number such that

$$\mathfrak{b} \leq \mathfrak{a},$$

then

$$\mathfrak{a} \cdot \mathfrak{b} = \mathfrak{a} \dots \dots \dots (7)$$

The equation (7) gives a new property of the numbers forming the \mathfrak{a} -group described in § 10 of my former paper.

3.

From the equation (7) we may also conclude that that class of type ω_γ and, consequently, of cardinal number \aleph_γ , consists, if γ has an immediate predecessor $\gamma-1$, of \aleph_γ consecutive series, each of which is of type $\omega_{\gamma-1}$ and cardinal number $\aleph_{\gamma-1}$. For the class ω_γ is, of course, built up from series of type $\omega_{\gamma-1}$ and the cardinal number of these latter series is, by (7), greater than $\aleph_{\gamma-1}$ and less than $\aleph_{\gamma+1}$.

When γ is a Limes-number, the number-class of type ω_γ is built up of series $\{\omega_\delta\}$ arranged in the order of the suffixes δ , where $\{\delta\}$ is any ascending fundamental series (when this term is extended to denote series whose type is other than ω ; say $\omega + \nu$, ω_1 , or ω_ν) such that its upper limit is a Limes, γ . We would have arrived at the same class ω_γ if any other series $\{\delta\}$ of upper limit-Limes γ had been taken.

4.

From the theorems

$$2 \cdot \mathfrak{a} = \mathfrak{a} \quad \text{and} \quad \mathfrak{a}^2 = \mathfrak{a},$$

we can obtain some other general theorems on transfinite cardinal numbers.

Since there is a part of a manifold with the cardinal number

$$\mathfrak{a}^{\mathfrak{a}}$$

which has a one-one correspondence with a manifold of cardinal number

$$2^{\mathfrak{a}},$$

we can say that

$$\mathfrak{a}^{\mathfrak{a}} \geq 2^{\mathfrak{a}}.$$

But, on the other hand,

$$\mathfrak{a}^{\mathfrak{a}} \leq (2^{\mathfrak{a}})^{\mathfrak{a}} = 2^{\mathfrak{a}},$$

since *

$$2^{\mathfrak{a}} > \mathfrak{a} \text{ and } \mathfrak{a}^2 = \mathfrak{a}.$$

Hence

$$\mathfrak{a}^{\mathfrak{a}} = 2^{\mathfrak{a}}.$$

But further, if

$$\mathfrak{b} \leq 2^{\mathfrak{a}},$$

we have also

$$\mathfrak{b}^{\mathfrak{a}} = \mathfrak{D}^{\mathfrak{a}}, \dots \dots \dots (8)$$

where \mathfrak{D} is any cardinal number such that

$$1 < \mathfrak{D} \leq \mathfrak{b}.$$

In particular, if $\mathfrak{a} = \aleph_{\gamma}$, we have

$$\aleph_{\gamma+1}^{\aleph_{\gamma}} = 2^{\aleph_{\gamma}}.$$

If \mathfrak{a} , \mathfrak{b} , and \mathfrak{D} are any transfinite cardinal numbers, then

$$(\mathfrak{b} + \mathfrak{D})^{\mathfrak{a}} = (\mathfrak{b} \cdot \mathfrak{D})^{\mathfrak{a}} = \mathfrak{b}^{\mathfrak{a}} \cdot \mathfrak{D}^{\mathfrak{a}};$$

which reduces to $\mathfrak{b}^{\mathfrak{a}}$, if we suppose $\mathfrak{b} \geq \mathfrak{D}$. This last result has been proved by Whitehead without utilizing the properties that

$$\mathfrak{b} + \mathfrak{D} = \mathfrak{b} \cdot \mathfrak{D} = \mathfrak{b}.$$

Whitehead † defined a class of cardinal numbers, which he called “exponential numbers,” as follows:—An exponential number is a cardinal number \mathfrak{a} such that there is a transfinite cardinal number \mathfrak{b} such that there is a cardinal number $\mathfrak{g} > 1$ such that

$$\mathfrak{a} = \mathfrak{g}^{\mathfrak{b}}.$$

Further, Whitehead called those exponential numbers in which also

$$\mathfrak{b} = \aleph_0 \cdot \mathfrak{b}$$

* Detailed proofs of the theorems: if \mathfrak{a} , \mathfrak{b} , \mathfrak{D} are any three cardinal numbers, and $\mathfrak{b} < \mathfrak{D}$, then

$$\mathfrak{a}^{\mathfrak{b}} \leq \mathfrak{a}^{\mathfrak{D}} \text{ and } \mathfrak{b}^{\mathfrak{a}} \leq \mathfrak{D}^{\mathfrak{a}},$$

were given by Russell (see Whitehead, *Amer. Journ. of Math.* xxiv. p. 382, propositions 4.4 and 4.41, and p. 368).

† *Amer. Journ. of Math.* vol. xxiv. (1902) p. 391, proposition 20.1. The propositions 19.7 and 21.1 to 21.4 can be at once verified by our general theorem, but it is interesting to observe that Whitehead proves them without using the properties resulting from the fact (which was proved in my first paper) that every cardinal number is an Aleph.

“ \aleph_0 -exponential numbers.” That, however, these two classes are coincident is now easily seen; and, further, all the propositions proved by Whitehead* for either class of exponential numbers hold equally for the whole class of transfinite cardinal numbers. In fact that equations (7) and (8) have been already proved, and it is also evident that, if

$$1 < \mathfrak{D} \leq 2^{\mathfrak{a}}, \mathfrak{b} \geq \mathfrak{a}, \mathfrak{e} = \mathfrak{D}^{\mathfrak{b}},$$

then

$$\mathfrak{e}^{\mathfrak{a}} = \mathfrak{e}.$$

The exponential numbers have not, then, shown a behaviour different in any respect to the other transfinite cardinal numbers; and consequently no indication is to be found in addition, multiplication, or in at least many cases of exponentiation, of a characteristic of these numbers. In particular, no contradiction has been found in supposing

$$2^{\aleph_0} = \aleph_1; \dots \dots \dots (9)$$

because

$$2 \cdot \aleph_1 = \aleph_1, \aleph_1^2 = \aleph_1, \aleph_1^{\aleph_0} = \aleph_1, \aleph_1^{\aleph_1} > \aleph_1;$$

we cannot, however, yet assert the equation (9). Some investigations on this important question will be given subsequently.

Little Close, Yateley, Hants.
December 23rd, 1903.

XXXIII. *On the Motion of Radium in the Electric Field.*
By J. JOLY, D.Sc., F.R.S.†

A LIGHT disk, delicately suspended, and coated upon the one side with a few milligrammes of radium bromide of high activity, exhibits, when an electrified body is brought near to it, motions very different from what would be observed in the case of an inactive substance. The usual sequence of attraction, electrification, and repulsion are replaced by the following effects. The electrified body, whether positive or negative in sign, *repels* the suspended body if brought up to it *on the side coated with radium*, but attracts it if presented at the naked side.

Before attempting an explanation I will describe the experiment which first gave rise to this observation.

Two thin microscope cover-glasses about 12 mms. in diameter, are attached at the extremities of a glass fibre

* *Amer. Journ. of Math.* vol. xxiv. (1902) pp. 393, 394.

† Communicated by the Author.

about 6 cms. long, their surfaces lying in the same plane. A short piece of a fine needle is fixed by cement at the middle of the fibre, perpendicularly to it and in the plane of the vanes, so that when the needle-point is poised upon a smooth surface a radiometer-like instrument with vanes in a vertical plane is provided. A drop of alcohol is placed upon a face of one of the cover-glasses and about half the contents of a 5-milligramme tube of radium bromide poured over it. The alcohol and radium are carefully spread over the surface and warmed over a lamp till the radium is alone left adherent to the glass. The second vane is treated in the same manner, but upon the alternative or opposite face—the, rotationally, similar face.

A glass receiver is turned over the little mill, some calcium chloride being placed beneath. If now an electrified body, such as a rod of ebonite rubbed on cat's skin or glass rubbed on silk, is brought up close to the receiver, there is a rotational motion imparted to the vanes, which becomes much more marked and decisive as to its direction if the pressure of the air under the receiver is reduced to about 5 or 6 centimetres; and may then become so violent as to cause the vanes to refuse to remain upon the support. It matters not what the sign of the electrification, the rotation is always in the one direction, and in such a sense that the radium-covered surface is repelled from the electrified body. A steady rotation is best obtained by placing the mill between metal plates (contained under the receiver), which can be connected with a small Wimshurst machine. A little consideration will show that this unidirectional rotation is a result of the effects described above.

The rotation persists at pressures of a couple of millimetres, but, I think, more feebly. I have not extended the observation to high vacua.

In order to examine the effect more closely a radium-coated cover-glass was attached to the beam of a Coulomb's balance, which was modified in such a way that the fixed metal sphere could be charged from without. It was then found that sharp repulsion was produced when the sphere was opposite the radium-coated surface and charged with positive or negative electricity, and that there was equally definite attraction when the sphere was upon the naked side of the glass, whatever the sign of the charge. If, however, the charge given is very intense and the radium is very close to the sphere, there may be attraction in every case.

It is possible to frame more than one explanation of this peculiar behaviour of a radium-coated body in an electric

field. Thus (a) we might ascribe it to the presence of electrified particles or ions of *both* signs in the region between the radium and the fixed electrified body. We may suppose these ions are not strongly attracted to the vane carrying the radium, and more abundant in front than at the rear of the vane. Then if a plus charge is presented opposite the radium the positive particles are repelled against it, the negative withdrawn. The first effect produces mechanical repulsion of the vanes, the second a relatively small force in the opposite sense. A minus charge acts in the same manner, the repulsive force being now caused by the negative ions. If the charged body is behind the disk, a mechanical force acting in the same sense as before is occasioned by the *attractions*, the repulsions being now ineffective.

(b) The presence of the charged body induces a charge of opposite sign upon the radium, and repels a charge of like sign to the remote side of the disk. The first (attractive) charge rapidly dissipates in virtue, chiefly, of the ionizing influence of the α -rays, the second (repellent) charge remains to exert a mechanical effect upon the vane. Too intense a charge may cause the attractive effect to predominate.

Some experiments were made to decide among these possible sources of unidirectional motion. Five milligrammes of radium bromide were divided between two thin metal disks, 12 mms. in diameter, which were then attached in a vertical plane at the extremities of the beam of the Coulomb's balance and in the plane of the beam. Fine aluminium wires were brought from the vanes nearly to the centre of the beam. The beam was a drawn glass tube, and the suspension was a fine quartz fibre. A U-shaped rider with two hooks, suspended from the beam at its centre, served to place the disks in metallic connexion. Removal of the rider disconnected them. A second fixed metal sphere was added to the balance diametrically opposite the usual one, and all was adjusted so that when the torsion-head was turned the disks could be brought up to the spheres, each presenting its radium-coated surface to one of the spheres. The spheres could be charged from without either singly or connected together. Drying material was placed in the balance.

If explanation (a) is correct, *i. e.* that the effect is due to the pressure of electrified particles, then whether the vanes are electrically connected one with another or not should make no difference in the repulsion of the vanes. It was found, however, that when one of the spheres is electrified and the vanes are connected there was no repulsion, but, on the contrary, a brisk attraction, whatever the sign of the

charge. Breaking the connexion restores the repulsive effect. If the spheres are connected with each other and the vanes are also connected one with another, then when a charge is given to the spheres there is repulsion.

Now evidently this behaviour is in favour of assuming that the repulsive effect is due to the preponderating influence of a charge given to the vane by induction, for such a charge would, when the vanes are connected, be repelled to the remote end of the beam. When the charged body is presented at both ends of the beam and the vanes are connected, the repulsive charge must remain in the vanes, and accordingly there is repulsion.

Rather unintentionally a further experiment was made supporting these results. Vanes of very thin mica had been mounted radiometer-fashion at the extremities of an aluminium wire beam. The wire was stitched through the mica, and was therefore in good contact with both sides of the vane. When those vanes were coated on alternate faces with radium bromide the mill refused to rotate decisively in any one direction, but showed, if anything, a tendency to rotate in the "attractive" direction. I at first ascribed this to the use of vanes too thin in substance, but subsequently, in accordance with the view that electrical connexion between the vanes must destroy the rotation, I substituted a glass fibre for the wire. The mill now rotated freely and in the "repulsive" direction in the electric field. The experiment suggests that the mica itself must have acted as a conductor under the influence of the radium.

On the question as to how far it is an induced or a conducted charge which leads to the repulsion of the radium-coated vane when the radium is presented towards the charged body, it is to be observed that not only some of the preceding experiments but also the rapidity with which the repulsion succeeds the charging of the sphere are in favour of ascribing the effect to induction. Quantitative measurements would be required to fully elucidate the matter. Possibly there is some direct ionic conduction of the charge as well as the inductive effect, and, of course, the experiments do not exclude the existence also of some mechanical effect from the transport of electrified particles, but they serve to show that the latter effect must, at best, constitute but a small part of the force acting upon the vanes.

Another source of rotation is to be sought for in the reactionary force attending the discharge of α -radiation. It is improbable that any intensification of this discharge in the electric field, sufficient to give rise to the effects observed,

could hitherto have passed unnoticed. Normally the effect is too small to be considered. This force might, however, be successfully looked for with larger quantities of radium. According to Rutherford (Phil. Mag. May 1903, p. 588) the kinetic energy of each α -ray is 10^{-5} ergs and their velocity 2.5×10^9 cms.; hence $MV = 8 \times 10^{-15}$ dynes, and this is the force for one ray projected. If 2×10^6 rays per second are projected from each milligramme of radium having an activity one million times that of uranium, the reactionary force of 100 milligrammes is 1.6×10^{-6} dynes. This should be observable, but complications would arise from motions due to thermal convection-currents in the surrounding gas arising from the spontaneous evolution of heat in the radium. The latter source of energy would, indeed, probably be sufficient to alone determine a rotation with suitably disposed vanes.

XXXIV. *Notices respecting New Books.*

Traité de Chimie Physique. Les Principes. Par JEAN PERRIN, Chargé du Cours de Chimie Physique à la Faculté des Sciences de Paris. Paris: Gauthier-Villars. 1903. Pp. xxvi+299.

ONE of the indications of the rapid strides which are being made in physical chemistry, and of the increasing interest which is being taken in this highly important but difficult branch of science, is the appearance within recent times of several important text-books on the subject. Of these, the book now under review must be regarded as one of the most important.

Modern theories of chemical equilibrium are based on thermodynamical methods; and in the whole range of science there is probably no subject which presents greater difficulties to the beginner or is more full of pitfalls than thermodynamics. That such is the case has been abundantly proved by the somewhat heated controversy regarding entropy carried on recently in a number of leading technical journals. Students of this subject will therefore feel grateful to M. Perrin for the fearless manner in which he handles real difficulties, and for the searching criticism which he brings to bear on slovenly or superficial methods of exposition. He may, at times, be hypercritical and somewhat too fastidious, but the reader can only be the gainer by such scrupulous care in the handling of a difficult subject.

The present volume is the introductory one of a comprehensive treatise, and a brief outline of its contents will give some idea of its scope. Chapter I. deals with the notion of generalized forces, Chapter II. with the factors of energy, Chapter III. with the principle of equivalence of the various forms of energy, Chapter IV. with the part played by the various factors of energy in producing changes in a system, Chapter V. with the principle of evolution, according to which the physical universe never returns to a previous state of existence, Chapter VI. with the characteristics of

stable equilibrium, Chapter VII. with pure bodies and the laws of combination, Chapter VIII. with chemical potential, and Chapter IX. with the phase rule.

The writing of this volume must have cost the author an immense amount of thought and trouble, but it is also amply evident that it has been a labour of love, and the style in which the book is written cannot fail to communicate to the reader some of the author's own enthusiasm and passionate devotion to truth.

Treatise on Thermodynamics. By DR. MAX PLANCK, *Professor of Theoretical Physics in the University of Berlin.* Translated, with the Author's sanction, by Alexander Ogg, M.A., B.Sc., Ph.D. Longmans, Green & Co. 1903. Pp. xii + 272.

THERMODYNAMIC literature will be considerably enriched by the addition to it of Professor Planck's profound and original treatise. There are few subjects in the whole range of physical science which require more careful handling than thermodynamics, nor is there any in which slipshod and careless methods are more productive of mischief or more conducive to the formation of habits of mental dishonesty. Any treatise, therefore, which helps the earnest student towards a clearer understanding of this difficult subject by a thorough discussion of all its difficulties—many of which would probably escape his notice unless specially pointed out—is to be warmly welcomed. The present treatise is intended not for the beginner, but for the advanced student who has already mastered the foundations of thermodynamics, and who is in a position to take a step upwards by giving his attention to that wider and more general mode of treatment which is so characteristic of thermodynamics.

To the average mind the study of concrete physical problems is always much easier than that of broad general principles applicable to a wide range of physical phenomena. As the generality of the treatment increases, so does the mental effort required to follow it. Few students, for example, acquire a really clear notion of the full significance of the conservation of energy until they have given careful study to a large number of problems which furnish illustrations of it. Similarly, few students are capable of grasping the full generality and far-reaching importance of the second law of thermodynamics until their minds have to some extent become familiarised with thermodynamical ideas by an elementary study of the thermodynamics of a perfect gas, based on the notions of the kinetic theory. Such a study probably forms the best introduction to the subject, and for this reason has become established as the standard method of dealing with it. But unless the student subsequently enlarges his ideas by a more careful study of general thermodynamical principles, his conception of thermodynamics will be very limited indeed. It is not unusual, for example, to find that many students who have passed through an elementary course acquire the notion that the second law is something which applies to gaseous bodies only—nay, in some cases that it only applies to a *perfect* gas—and that therefore its range is extremely limited.

Realizing, no doubt, the difficulties which are connected with the more general mode of treatment, Professor Planck has, in the treatise before us, adhered to the standard method, in which the perfect gas is used as a convenient mental peg on which to hang the wider generalizations of the science. But the perfect gas, having performed its function, is soon abandoned in favour of those more general principles which have revolutionized the study of chemical reactions, and a large portion of the book deals with the applications of thermodynamics to problems of chemical equilibrium. The general plan of the book may be here briefly outlined. Part I. deals with Fundamental Facts and Definitions; Part II. with the First, and Part III. with the Second, Law of Thermodynamics: while the concluding Part IV., which forms rather more than one-half of the book, contains applications to special states of equilibrium.

A careful study of this work, and especially of Part III., which contains a most careful discussion of the validity of the Second Law, will well repay the trouble spent upon it. The translation is well done, and there appear to be very few slips or misprints. On p. 40, line 13 from the top, "definite" should be substituted for "different," and there is a somewhat remarkable slip at the beginning of § 86, p. 58, where we read the surprising statement that "only the specific heat at constant pressure, c_p , is capable of direct experimental determination, because a quantity of gas inclosed in a vessel of constant volume has far too small a heat capacity to produce sufficient thermal effects on the surrounding bodies." This statement would seem to show that neither the author nor the translator is aware of Dr. Joly's brilliant researches and his complete success in determining c_v experimentally by means of his steam calorimeter.

Die Schule der Chemie. Erste Einführung in die Chemie für Jedermann. Von W. OSTWALD, O. Professor der Chemie an der Universität Leipzig. Erster Teil. Allgemeines. Mit 46 in den Text eingedruckten Abbildungen. Braunschweig: F. Vieweg und Sohn. 1903. Pp. viii + 186.

It is not often that a great man of science condescends to write a *very* elementary text-book—one, that is to say, which will be intelligible to "the man in the street." The temptation to assume for granted or self-evident many results which to the non-scientific mind present considerable difficulties is one not easy to resist. The book under review is a striking testimony to the remarkable educational ability of its distinguished author, and after perusing it one cannot help wishing that all one's teachers had possessed Professor Ostwald's gift of adapting himself to the exact mental level of his pupil. The instruction is conveyed in the form of a dialogue between teacher and pupil, and the method followed will prove full of interest to elementary teachers. The book affords as delightful reading as Tyndall's 'Forms of Water,' and the "teacher's" statement that "Chemie zu lernen ist ebenso lustig, wie im Walde zu spazieren" is fully justified. The present volume deals with

general physical and chemical properties, elementary thermometry and other processes of measurement, and contains a somewhat more detailed study of oxygen, hydrogen, nitrogen, carbon, and their simpler compounds. We shall look forward with interest to the appearance of the second volume.

Allerlei Methoden, das Wetter zu prophezeien. Von J. M. PERNTNER.
Mit 8 Abbildungen im Texte. Wien, 1903: Selbstverlag des Vereines zur Verbreitung naturwissenschaftlicher Kenntnisse.
Pp. 36.

THIS pamphlet gives an interesting account of the various theories and methods relating to weather forecasts, including the method followed by meteorological offices. It is the substance of a lecture on the subject recently delivered by the author.

La Science et l'Hypothèse. Par H. POINCARÉ, Membre de l'Institut, Professeur à la Faculté des Sciences de l'Université de Paris.
Paris: Ernest Flammarion. Pp. 284.

To those who are fond of examining critically the foundations of science, and probing things as deeply as the limitations of the human intellect will allow, this suggestive book by the celebrated French mathematician will be full of interest. The logic of the mathematical and physical sciences is here subjected to a searching and minute criticism, and the author shows that in connexion with the so-called definitions of the fundamental notions of dynamics as well as other branches of science, the vicious circle is of much more frequent occurrence than is generally supposed to be the case. Difficulties are frequently raised and discussed, and the shortcomings of the classical mode of treatment pointed out, without any attempt at substituting a more perfect treatment—perhaps because of the impossibility of doing so. The book is extremely suggestive and stimulating. The value and limitations of hypothesis as an instrument of research are specially insisted on. The author's views are illustrated by a detailed application to the history of optics, electrodynamics, and Maxwell's theory.

XXXV. *Proceedings of Learned Societies.*

GEOLOGICAL SOCIETY.

[Continued from p. 80.]

December 16th, 1903.—Sir Archibald Geikie, D.C.L., D.Sc., Sec.R.S.,
Vice-President, in the Chair.

THE following communications were read:—

1. 'The Igneous Rocks associated with the Carboniferous Limestone of the Bristol District.' By Prof. Conwy Lloyd Morgan, LL.D., F.R.S., F.G.S., and Prof. Sidney Hugh Reynolds, M.A., F.G.S.

Evidence for the contemporaneous origin of the igneous rocks is given for the following localities:—Middle Hope, or Woodspring;

Spring Cove, near Weston-super-Mare; above Kew Stoke, Milton Hill; Uphill; Goblin Combe; and near Cadbury Camp. At Middle Hope the ejectamenta thin to the east, and lava is only found to the west; at Spring Cove small lapilli were found in the limestone 8 feet above the basalt. At Goblin Combe there is the most characteristic and convincing section of ashy beds in the district: the lenticular bands of coarse greenish tuff, the limestone-intercalations, the close admixture of lapilli, limestone-fragments, and oolitic grains are stamped with the hall-mark of submarine volcanic action; lava closely underlies these breccias and tuffs. There is evidence of only one volcanic episode, which occurred in all cases after the *Zaphrentis*-beds had been laid down, and before the strata characterized by *Chonetes* and *Streptorhynchus* were deposited. (A table of certain broadly-marked horizons in the Carboniferous Limestone, by Mr. A. Vaughan, F.G.S., is given for reference.) The lavas are olivine-dolerites or basalts; with phenocrysts of olivine or augite. They are frequently amygdaloidal, sometimes variolitic; and in the variolites highly-altered felspar-phenocrysts occur. The rocks vary in grain, the coarsest being those from Uphill and near Cadbury Camp, of the contemporaneous character of which there is no direct evidence. The tuffs are all highly calcareous, and most of them are best described as 'ashy limestones.' The bulk of the lapilli varies from one-hundredth part of the rock to about one-third, and their composition is closely related to that of the basaltic lavas of the district. Quartz-grains are abundant in the Goblin-Combe rocks, and these rocks are frequently oolitic.

2. 'The Rhætic Beds of England.' By A. Rendle Short, Esq., M.B., B.Sc.]

The paper opens with a description of four new exposures of these rocks: one at Redland rests upon Carboniferous Limestone, and is interesting because the 'Bone-Bed' is very ill-developed on receding from the old shore; a second is at Stoke Gifford, with a continuous, well-developed landscape-marble, the Insect-Bed, and no bone-bed; a third at Cotham Road (Bristol) yields baryta, celestine, and *Naiadita* at special horizons containing no other fossils; and the fourth, at Aust, has given measurements of the uppermost 13 feet, which are inaccessible from below. Next an account is given of the constituent beds, with special reference to the conditions of deposition. The Bone-Bed is of wide distribution; it frequently occurs in pockets on a flat surface, or spread out over that surface; it contains fragments of rolled marl, rounded pebbles of Carboniferous Limestone, and pebbles of quartzite and well-rounded quartz. The author concludes that it was formed during a stormy period, after the sea had made its first irruption into the dried-up or silted-up level surface of the Keuper Lake. The *Naiadita*-beds appear to have been formed in very shallow, and perhaps only slightly saline, water, and the calcareous matter associated with them may have been mud washed from the Carboniferous Limestone. Only after the White-Lias period did the water finally become moderately deep. The area of deposit appears to have been a gigantic shallow lagoon

connected with the open sea to the south, and the fauna was derived from the direction of Germany. A short account is given of some of the Continental Rhætic formations, followed by a list of Rhætic fossils recorded in England, with the range of each. A consideration of this list enables the author to suggest that the lower limit of the formation should be drawn at the first evidence of Rhætic life after the deposition of the gypsiferous and red or green marls, which (at any rate in their lower part) are certainly of Keuper age. The upper limit may, for convenience, be drawn at an indefinite level where *Modiola minima* and *Pleuromya crowcombeiana* become very rare, and the ammonitic and Liassic fauna begins. Further discussion of the lithological, physical, and palæontological evidence leads the author to recognize that the affinities of the Rhætic, thus defined, are rather with the Jurassic rocks than with the Trias. The following zones are suggested, in descending order:—

- Zone of *Pleuromya crowcombeiana* = White Lias.
- „ *Monotis decussata* = Cotham Marble and just above.
- „ *Estheria minuta* var. *Brodieana*, and *Naiadita*.
- „ *Pecten valoniensis*.
- „ *Avicula contorta* = Black Shales and a limestone-bed.
- „ Bone-Bed.

These zones seem to be fairly constant throughout England, and harmonize well with those of Germany, although they cannot be expected to fit in with the oceanic type of the Alps and the Mediterranean. Further consideration shows that the fossils give evidence of migration, but very little of evolution. The paper closes with the description of a new species of *Anomia* and a bibliography.

January 6th, 1904.—Sir Archibald Geikie, D.C.L., D.Sc., Sec.R.S.,
Vice-President, in the Chair.

The following communications were read:—

1. ‘On a Palæolithic Floor at Prah Sands, in Cornwall.’ By Clement Reid, Esq., F.R.S., F.L.S., F.G.S., and Eleanor M. Reid, B.Sc.

Prah Sands lie about 7 miles east of Penzance, and have long been known as exhibiting a good section of ‘head’ or rubble-drift, over raised beach, which rests on a wave-worn rocky platform. Recent storms have cleared away the talus at the foot of the cliff, and have exposed, between the ‘head’ and the raised beach, a Palæolithic land-surface, consisting of loamy soil penetrated by small roots. In and above this occur black seams full of small fragments of charcoal and bone: these are particularly abundant round groups of large flat stones, which seem to have formed ancient hearths. The black seams contain implements made of vein-quartz. For a few feet above this land-surface the angular ‘head’ consists mainly of loam with fragments of vein-quartz, some of which are worked. This seems to be the first record of Palæolithic man in Cornwall.

2. ‘Implementiferous Sections at Wolvercote (Oxfordshire).’ By Alexander Montgomerie Bell, Esq., M.A., F.G.S.

January 20th.—Sir Archibald Geikie, D.C.L., D.Sc., Sec.R.S.,
Vice-President, in the Chair.

The following communications were read:—

1. 'On the Jaws of *Ptychodus* from the Chalk.' By Arthur Smith Woodward, LL.D., F.R.S., F.L.S., F.G.S.

2. 'On the Igneous Rocks at Spring Cove, near Weston-super-Mare.' By William S. Boulton, Esq., B.Sc., A.R.C.S., F.G.S.

A traverse from end to end of the exposure at the locality shows that the 'basalt-mass' varies in structure and appearance, and that it is by no means a simple lava-flow. It may be roughly divided into three portions. Beginning at the cliff-end to the north, the rock for the first 30 yards is a pillowy basalt, with tuff and limestone often occupying irregular spaces between the spheroids of amygdaloidal basalt; then, for about 20 yards, the rock is mainly a coarse 'agglomerate,' with lapilli and bombs of basalt and limestone; while the remaining 100 yards or so is an ordinary basalt-coulée, with very few and always small lumps of burnt limestone. The limestone below is reddened and altered, and although tuffey-looking, does not contain indubitable lapilli; the limestone above contains lapilli. The pillowy basalt probably represents a river of agglomeratic material carrying finer lapilli, larger and plastic masses of scoriaceous basalt, and lumps of limestone, possibly ejected from a vent. The intervening tuff may present an analogy with the 'volcanic sand' of the West Indian eruptions. There is no evidence of the quiet deposition of ashy material, but rather of the tumultuous aggregation of a fluxion-tuff taking place under some depth of sea-water. The large and irregular fragments of limestone, oolitic and fossiliferous, found mainly in the lower part of the basalt-mass, have not come in from above through cracks in the lava, but seem to have been picked up while in a soft and powdery state from the sea-bed in which it had been accumulating, and to have been involved with and altered by the volcanic material. The conditions existing in submarine flows appear to be very like those in a sill or intrusive sheet.

February 3rd.—Sir Archibald Geikie, D.C.L., D.Sc., Sec.R.S.,
Vice-President, in the Chair.

The following communications were read:—

1. 'On a Deep-Sea Deposit from an Artesian Boring at Kilacheri, near Madras.' By Prof. H. Narayana Rau, M.A., F.G.S.

The village of Kilacheri is about 6 miles due south of the railway-station of Kadambattur. Here permeable beds of sandstone and felspathic grits dip at low angles seaward, and are overlain by impervious clays and shales. The boring, after penetrating the upper clays and sandstones, passed through carbonaceous shales, and at a depth of about 400 feet reached a blue homogeneous rock, effervescing with acid and showing radiolarian tests under the microscope. Most of the latter display the inner

reticulate structure in thin sections, and some of them, when isolated, show radiating spines as well; they are, however, not capable of specific determination. One or two specimens of foraminifera have also been seen. The deposit underlies beds of the Upper Gondwana Stage. The bed also contains palagonite, volcanic glass, pumice, mineral-fragments (such as plagioclase, quartz, augite, and possibly hornblende), and black metallic spherules of iron and manganese. The last sometimes partly fill the radiolarian tests, and sometimes encrust the pumice and palagonite; they give the manganese-reaction with a borax-bead. The author concludes that the deposit is of truly abysmal origin, similar to those described in the *Challenger* Reports; and he points out the remarkable interest of such an occurrence in Peninsular India, a region which appears to have been a land-area since Palæozoic times.

2. 'The Rhætic Beds of the South-Wales Direct Line.' By Prof. Sidney Hugh Reynolds, M.A., F.G.S., and Arthur Vaughan, Esq., B.A., B.Sc., F.G.S.

After a reference to the literature of the subject the following exposures are described: the Stoke-Gifford and the Lilliput or Chipping-Sodbury sections. From the first section the Bone-Bed is completely absent. The beds here rest upon tea-green marl, and are covered by the Cotham Marble. A section to the east of Lilliput Bridge shows two large rounded hummocks of Palæozoic rock projecting into the Rhætic, and in both cases the Black Shale is deposited on it in an arched manner, forming an anticline of deposition. There is also a very rich Bone-Bed at the base, which is not uniformly distributed. The upper beds correspond with those of Stoke Gifford. In correlating these rocks with those of neighbouring areas, a table of general sequence is given, in which the Lower Rhætic is divided into three and the Upper into two stages, which are correlated with the notation of Richardson and Wilson. This is followed by a range-table of the typical Rhætic mollusca: *Cardium rhæticum* and *C. cloacinum*, *Schizodus Ewaldi*, *Pecten valoniensis*, and *Avicula contorta*. Palæontological notes on the invertebrata and vertebrata follow. New species of *Anomia*, *Plicatula*, *Modiola*, and *Cardinia* are described; notice is given of other Rhætic mollusca; and a range-table is appended of the commonest mollusca that occur at Sodbury and Stoke Gifford. The reptiles, amphibia, and fishes referred to are all known species. A general account is given of the distribution of the Bone-Bed in the Bristol district. In Somerset, except at Emborough and Watchet, no true Bone-Bed has been recorded; in the district immediately north of Bristol there is a single, well-marked Bone-Bed at the base of the Black-Shale Series, or very slightly above it; while in the Gloucester district the principal Bone-Bed tends to lie at a greater distance from the base of the Black Shales. For these reasons, the authors think that the principal Bone-Beds in the various sections cannot be regarded as homotaxial equivalents.

XXXVI. *Intelligence and Miscellaneous Articles.*

NOTE ON "π." BY R. CHARTRES.

IT could be easily shown that if two numbers are written down at random the probability that they will be prime to each other = $\frac{6}{\pi^2}$.

This affords a simple and interesting method of obtaining an approximate value of π.

Having asked three friends to write down at random five pairs of numbers, I found in each case three pairs out of the five were prime to each other, giving $\frac{6}{\pi^2} = \frac{3}{5}$, or $\pi^2 = 10$.

I did the same with fifty students with the following result:—

| | |
|--|------|
| 6 sets of five pairs had only one pair prime to each other | = 6 |
| 9 " " " two pairs " " " | = 18 |
| 16 " " " three " " " | = 48 |
| 13 " " " four " " " | = 52 |
| 6 " " " five " " " | = 30 |
| Total 50 | 154 |

thus $\frac{6}{\pi^2} = \frac{154}{250}$, or $\pi^2 = 9.74$, or $\pi = 3.12$.

De Morgan obtained a very fair approximation by using Buffon's Problem, that if a needle be allowed to fall on a plane ruled surface, the probability of the needle cutting one of the lines twice the length of the needle
 = $\frac{2 \times \text{length of needle}}{\pi \times \text{distance between the lines}}$.

OBITUARY NOTICE: DR. WILLIAM FRANCIS.

DR. WILLIAM FRANCIS was born in London on the 16th of February, 1817. He was educated at University College School and St. Omer. He left St. Omer in 1834 and proceeded to Crefelt, but in the autumn of the same year went to Gera, where he remained for about two years. In 1836 he returned to England and spent a year at the London University (University College), afterwards devoting some time to learning the printing business under Mr. Richard Taylor, to whom he had been apprenticed some time previously. He then went to Berlin, and thence to Giessen, where he studied under Liebig, and did much original work, chiefly on the salts of molybdenum. He took his degree of Doctor of Philosophy at Giessen in 1842.

He early developed a taste for Natural History, and during his stay at Gera he devoted much of his time to entomological study and pursuits. While in England, in 1837, "fresh from the teachings of Ehrenberg, and profoundly influenced by the spirit of scientific research which then, as now, prevailed in Germany," he "suggested to Mr. Richard Taylor the establishment of a journal

in which, while its pages were freely open to the original contributions of English naturalists, special attention should be paid to the researches of Continental observers; and the result was the starting of the 'Annals of Natural History,' with which, subsequently, the well-known 'Magazine of Natural History' of Loudon and Charlesworth was amalgamated." His name first appears on the wrapper as co-editor in 1859. As Editor of the 'Annals' he became acquainted with most of the leading naturalists, and made many life-long friends, his indebtedness to whom he warmly acknowledges in the Preface to the Sixth Series.

While in Berlin and Giessen, Dr. Francis, in conjunction with his friend and fellow-student Henry Croft, forwarded every month a series of reports to the 'Philosophical Magazine' on the progress of chemical science on the Continent; but the space available in that Journal being limited, they, on their return to England, started the 'Chemical Gazette' in 1842. Croft was compelled to relinquish the editorship before the fourth number appeared, being appointed Professor of Chemistry at King's College, Toronto; and the 'Gazette' was carried on by Dr. Francis alone until 1859, when the pressure of other work compelled him to relinquish the task, and the 'Gazette' was incorporated with the then newly founded 'Chemical News.'

In addition to furnishing translations of foreign scientific papers to the 'Philosophical Magazine,' he also translated many papers for Taylor's 'Scientific Memoirs,' in the conducting of which, moreover, he had a very large share, although his name did not appear on the titlepage. He also translated Beckmann's 'History of Inventions' for Bohn's Scientific Series.

In 1851 his services to the 'Philosophical Magazine' over many years, both in furnishing translations and in conducting the Journal, were acknowledged by the appearance of his name on the wrapper as co-editor, where it remained until his death. During the whole period of fifty-three years he took an active part in the management of the Magazine. His acquaintance and, in many cases, warm personal friendship with scientific men both in Great Britain and on the Continent, his sound judgment, and tact made his services in this capacity invaluable.

In 1841 he was elected Associate of the Chemical Society, becoming a Fellow in the following year. He was also a Fellow of the Linnean Society (1844), of the Royal Astronomical (1851), of the Geological (1859), and of the Physical (1876).

In 1852 he joined Mr. Richard Taylor as partner in the firm of Taylor and Francis, printers and publishers. He was one of the oldest members of the Stationers' Company, having taken the Livery in 1841.

In 1862 he married Isabella Gray, daughter of Mr. Taunton, M.R.C.S., of Hatton Garden, but became a widower in 1899. For some few years previous to his marriage Dr. Francis had lived at Richmond, and for the rest of his life continued to reside there—for the last thirty-one years at the Manor House, where he died on the 19th of January last.

FIG. 3.

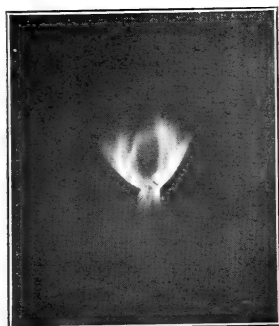
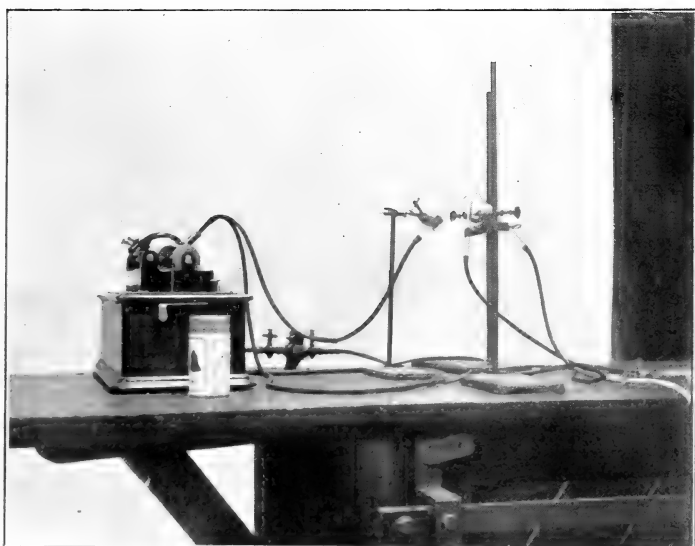
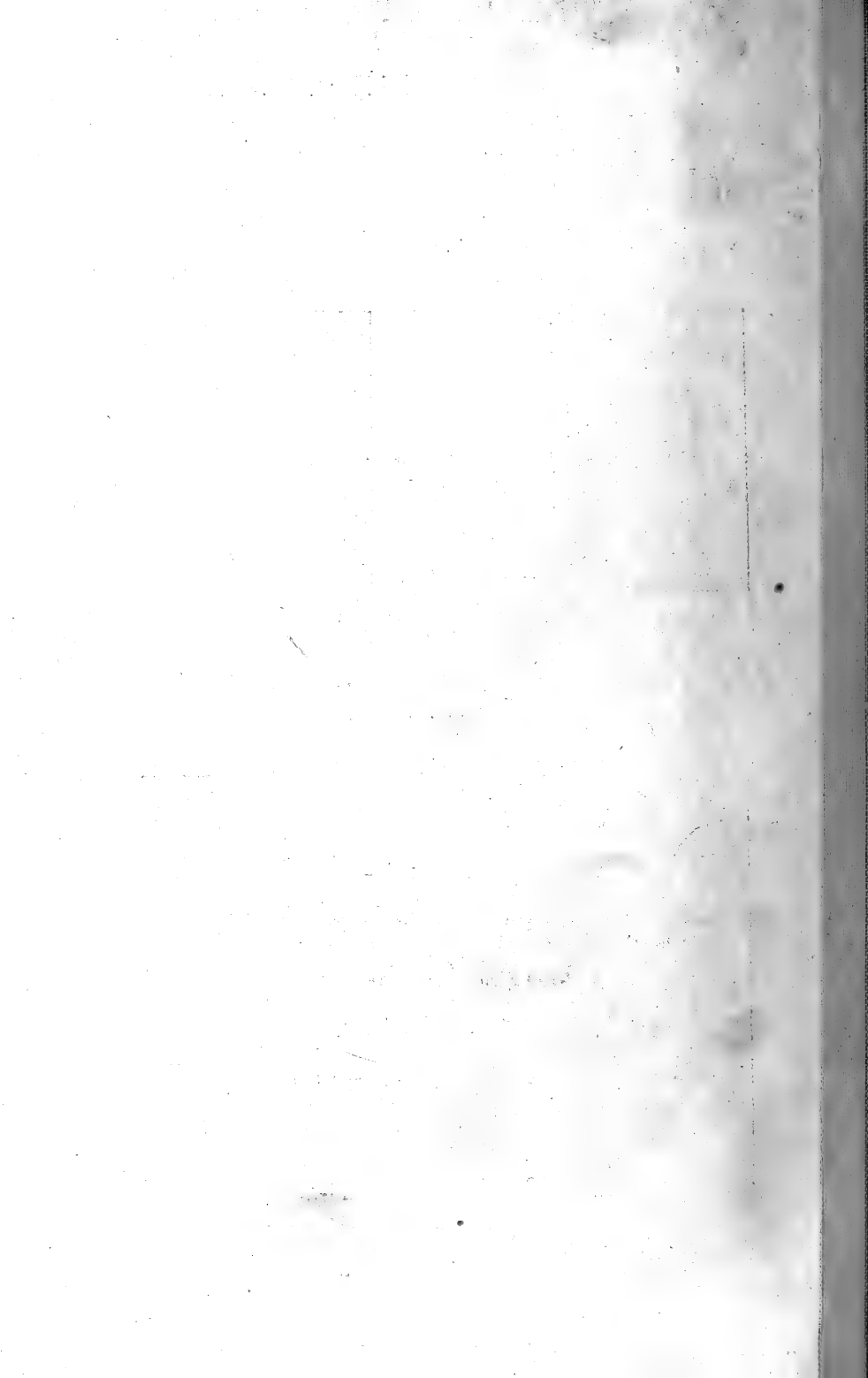

FIG. 4.





INDEXED

THE

LONDON, EDINBURGH, AND DUBLIN

PHILOSOPHICAL MAGAZINE

AND

JOURNAL OF SCIENCE.

[SIXTH SERIES.]

APRIL 1904.

APR 16 1904

XXXVII. *On Double Refraction in Matter moving through the Æther.* By D. B. BRACE*.

THE FitzGerald-Lorentz † “Contraction” Hypothesis to explain the negative results of the Michelson-Morley ‡ experiment of interference between two rays, at right angles and parallel to the earth’s motion, has been tested by Rayleigh § in his experiments on the double refraction of liquids and of glass. He assumes the contraction to be $(10^{-4})^2$, and also the excess of the index above unity to be proportional to the density. The first assumption is apparently in error by a half and should be 0.5×10^{-8} . The second assumption does not seem to be entirely valid for glass, at least, when compared with the double refraction produced by a given strain. The first correction reduces his margin down to 50 times for a liquid and 1.5 times for glass. The second will reduce the margin to considerably less than unity for glass, which would thus leave us only the observations on liquids upon which to base our conclusion.

While the method of Rayleigh cannot be regarded by any means as a conclusive test of the hypothesis, it is the only experimental one attempted and can be extended so as to give a safe margin for a solid like glass.

This suggestion of the “contraction” hypothesis by Lorentz, from considerations in regard to intermolecular forces analogous to the interaction, through the mediation

* Communicated by the Author.

† *Versuch einer theorie*, Leiden, 1895.

‡ Amer. Journ. of Sci. (3) xxxiv. p. 333 (1887).

§ Phil. Mag. Dec. 1902.

317

of the æther, of electric and magnetic forces, is certainly plausible enough to warrant further examinations and extension experimentally. That the intermolecular forces are not altered by factors many times less than those obtained by Rayleigh, is found to be the case in the media used.

Experiments with Water.

Two arrangements suggest themselves: the one, a system rotating about a vertical axis, the other a similar system rotating about a horizontal axis so as to shift the plane of polarization from a position at 45° to the earth's orbital motion through an angle of 90° . In the matter of simplicity, sensibility, and stability the latter method would be preferable. However, the first arrangement was selected for the purpose of utilizing the same mounting for other experiments. A heavy beam was pivoted between the floor and ceiling so as to carry a trough with its horizontal axis intersecting the pivotal axis. This system could be rotated continuously so as to bring it into any desired position. This trough was 413 cms. long, 15 cms. wide, and 27 cms. deep on the inside, and built up of 5 cms. planking in order to give sufficient stability to the polarizing and mirror systems which it carried.

In order to obtain sufficient intensity through the total column, the 2856 cms. of water used, sunlight was so thrown into the trough as to keep its path the same whatever its position. The lens 1 (fig. 1) of about 2 m. focus converged the sun's rays, from a carefully adjusted heliostat, within the nicol 4, after reflexion from 2 and 3. The diverging beam was then successively reflected from mirrors 5, 6, and 7 upon the concave mirror 8. The radius of curvature of this latter was about 15 m., and it was mounted, as were the other mirrors, upon brass plates containing adjusting-screws fastened to the ends of the trough. The axis of the reflected cone was displaced in a horizontal plane, so that the return ray passed through the analysing system 9-11 placed to one side of the polarizer. The lens 12 converged the light, which would otherwise have come to a focus at a distance of about 2 m. beyond, to the eye 15 at a distance of 25 cms. from 9. Thus the eye could observe 9 directly or by means of the telescope 14. Both the heliostat-mirror and the lens 1 were diaphragmed down so that the aperture of the cone of rays was slightly less than that of the mirror 8 whose aperture was about 15 cms. This prevented diffused light from the mirror and the water reaching the nicol 11 to any serious extent, and also aided in the adjustments of the mirrors so as to keep the rays fixed when the trough was rotated.

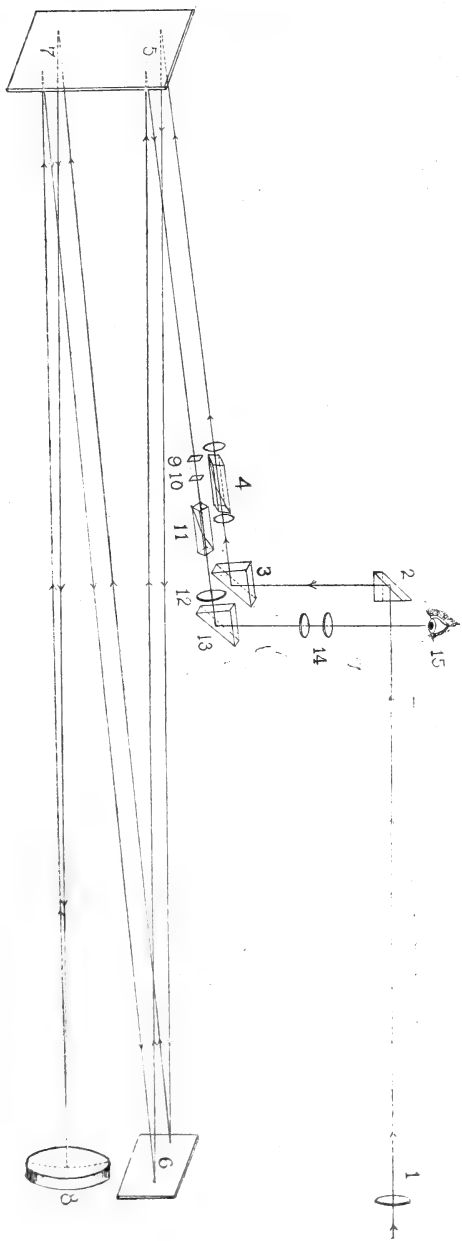

Fig. 1.

The total-reflecting prism 2 was carried by a universal mounting passing through a rod forming the prolongation of the axis about which the system rotated. By properly shifting 1 and 2 the ray 2-3 could be brought exactly in the axis of rotation, so that when the trough was rotated the return ray at 9 remained at a definite point in the field of view. 3 and 4 were then shifted until the ray passed through them symmetrically. Any change in the direction of the incident ray at 1 would of course cause a shift, but by properly regulating the heliostat this could be avoided. However, with such a long optical lever slight irregularities might occur after a rotation, but these were always compensated for before observing the field of view by adjusting 2 until the beam of light occupied the exact position it did previous to rotation.

The polarizing nicol was either one with ends normal to the ray, or, if of the ordinary type, mounted in a cell with thin cover-glass ends so as not to affect the ray when the system was under water. The analysing nicol was a Glan-Thompson of 15 mms. aperture. The analysing and polarizing systems together with the prisms and lens were mounted within tubes to prevent access of the water and upon a common cross-piece fastened to the trough. By adjusting 8 the cone of rays could be sent into the analyser symmetrically so as to fill completely the field of view. The principal planes of the nicols were crossed and at 45° to the vertical plane. A metal diaphragm was placed lengthwise between the entering and the emerging rays and between the mirror 5 and the polarizing system so as to prevent scattered light reaching the analyser.

The following delicate method, a detailed description of which I give elsewhere*, was used for observing the slightest trace of double refraction. 9 was a thin strip of mica which I will designate as the "sensitive strip" of order $\frac{1}{100}$ or 0.0012 mm. thick, cemented with Canada balsam between two thin cover-glasses without double refraction, the latter being cemented to a brass ring carried by an arm extending from a collar slipping over the brass containing-tube of the nicol. This collar carried an arm with the scale divided into some 60 divisions representing half degrees. 10 was a similar thin section of mica of order $\frac{1}{75}$ approx., cemented similarly and covering nearly the entire aperture of the nicol 11. This system, which I will designate as the "compensator," was mounted on a collar slipping over the nicol between the collar and the strip of the first system. This

* Phys. Rev. Feb. 1904.

had an arm for rotating and also a pointer passing over the scale referred to.

In the adjustments 2 was moved until, when the trough was turned completely round, the ray as seen on a white mark did not shift. Water which had been heated to drive out air and prevent minute bubbles forming in it and upon the mirrors and thus causing diffused light was then flowed into the trough until it covered the analysing and polarizing systems. This usually caused a shift of the rays, and 2 was again adjusted until the spot of light remained fixed when the trough was rotated. 8 was then adjusted until the return rays passed through the analyser so as to give a uniform field of view when examined directly with the eye through a small circular aperture or by means of the telescope 14. The light after its passage through this 30 metres of water appeared of a beautiful light-green tint. With the mica sections removed the nicols were adjusted for extinction, which was fairly complete. The sensitive strip 9 was then thrown in and rotated to extinction, and then turned through 45° so as to bring its principal axes at 45° to the principal plane of the analyser. 10 was then placed in position and turned until the field on each side was of the same intensity as that of the sensitive strip. The eye thus saw the field of view illuminated uniformly with green light in the neighbourhood of this strip. The slightest trace of double refraction in the direction desired would at once make itself evident in the relative increase or diminution of the light from the strip.

The conditions of maximum sensibility in photometric comparisons, namely a vanishing line and a uniform field, were thus attained. A small piece of glass compressed vertically to the slightest degree with the fingers placed after the polarizer 4 showed a sharp change of intensity at this bounding line. A match could be immediately obtained by rotating the compensator 10. By noting the position of the pointer for a match and then shifting the same until such a change could just be detected, a measure of the sensibility of the system could be obtained. This angle was found to be $0^\circ.2$ under favourable conditions. At each observation the sensibility was determined. A match was obtained with, say, the trough in the meridian at noon, this was then turned through 90° into the direction of the earth's orbital motion. The position of the return image at the polarizer was noted, and if it had shifted in any way it was brought back by the adjustment of 2 into its initial position and then the field of view examined. In no case could a change be observed, *i. e.*

there was still a match indicating no double refraction. Various positions were taken in and at right angles to the meridian with the same result. Hence, we may conclude that to this order of sensibility there is no double refraction in the water due to its motion through the æther. These observations were taken during the latter part of July 1903. It is evident that a rotation of the plane of polarization due to the earth's field of force would not affect this match, as both portions of the field would vary in intensity by the same amount. To make sure of this the trough was rotated through 180° into the meridian so as to reverse the direction; but no effect could be observed. It is evident that since the rotation due to a magnetic field is always in a definite direction and independent of the direction of the ray, such a rotation of the plane of polarization would be reversed with respect to an observer moving with the trough. Hence this could not mask any effect due to double refraction.

A second check was made with a cell of turpentine 1.6 mm. thick, whose ends were made with thin cover-glasses without double refraction, which would give a rotation of about $0^\circ.5$, while if we take $0^\circ.015$ as Verdet's constant for water and 0.2 as the earth's field and a length of 30 m. we find about $0^\circ.15$ for the rotation. On inserting this cell after the polarizer, no effect could be detected.

In order to determine the relative retardation which corresponds to a given rotation of the compensator, the polarizing and analysing systems were dismantled and placed on a support with their optic axes in line. The system was illuminated by an acetylene flame, the light from which passed through green glass or celluloid of about the same tint as that obtained after passage through the water. The sensitive strip, compensator, a quarter-wave plate mounted on a vertical circle, and a vertical strip of glass capable of carrying a weight, and, in addition, a micrometer-screw carrying two horizontal cross-wires in front of a horizontal strip of glass held within a clamp so as to produce a flexure, were arranged to be placed in the path of the light. The order of the mica quarter-wave plate was found to be approximately $\frac{1}{4}$ for green light, $\lambda = 0.00005$ cm., by comparison in the usual way with a quartz or selenite wedge. With the nicols crossed and the plane of polarization at 45° to the vertical, the circle carrying the quarter-wave plate was adjusted until the light was extinguished and the mean of its positions for a number of settings noted. The sensitive strip was then thrown in with its axes at 45° to the plane of polarization, and after that the compensator which was set for a match. By rotating

the quarter-wave plate this match was destroyed, but by rotating the compensator this could again be obtained. In this way the retardation of the compensator could be at once determined in terms of that of the quarter-wave plate. Thus, a rotation of 5° of the compensator corresponds to $16'$ of that of the quarter-wave plate. It was found that the rotation of the compensator was proportional to that of the quarter-wave plate approximately for these small angles.

A further comparison was made with the vertical crown-glass strip. This was 13 mms. wide and 2 mms. thick. The quarter-wave plate was removed and this strip inserted instead and a setting made with the compensator. On adding 200 gms. a match was obtained on rotating the compensator through $2^\circ.5$. From this can be calculated the relative retardation produced in glass per unit weight and unit width. Another comparison was made with white light from the acetylene flame direct by removing both strip and compensator and inserting the micrometer and horizontal glass strip in addition to the vertical glass strip. When the clamp for producing flexure was screwed up a horizontal black band appeared between the two cross-wires. For one flexure, where the band was quite distinct, 500 gms. on the vertical glass strip gave a reading of 36 on the micrometer-screw and 200 gms. gave 14, thus showing the proportionality. A movement of the cross-wires, just sufficient to observe a shift, gave a reading of 12, which was the sensibility of the system for that flexure. On releasing the screw until the flexure was so far reduced that the band was barely visible, 200 gms. gave a shift of 23 divisions and 100 gms. gave 11 divisions as near as could be observed, and this was the smallest weight which could be observed to produce any double refraction. A direct shift of the cross-wires gave 13 divisions as the sensibility. Using direct white light and the sensitive strip and compensator $0^\circ.1$ rotation of the latter could be detected, thus giving it a sensibility of $\frac{200}{2.5} \times 0.1 = 8$ gms., or 12.5 times that of the band under similar conditions of light intensity and adjustment*. With greater intensity and more careful adjustment higher sensibility could be obtained by both methods. In fact, Rayleigh, using lime-light and a black band, has been able to detect a weight of 25 gms. on a vertical glass strip 15 mms. wide, or a sensibility over four times as great as that obtained above with the acetylene flame and a black band.

* A comparison with a Bravais sensitive-tint biplate gave 200 times the sensibility for the sensitive strip.

From the above data we may calculate the least change in the index which could be observed if the water had become doubly refracting. If θ is the angle which the plane of polarization makes with one of the principal axes of the mica then the component vibrations or the principal axes of the resultant ellipse in the quarter-wave plate are in the ratio of $\tan \theta$ to 1. For small angles then the ratio of the change of phase to the total or $\frac{\lambda}{4}$ is proportional to the angle θ . Thus 1° rotation of the mica gives

$$\frac{1}{45} \times \frac{\lambda}{4} = \frac{\lambda}{180},$$

but $16'$ of the quarter-wave plate was equivalent to 5° of the compensator, and as $0^\circ.2$ rotation of the latter could be detected, this reduces to

$$\frac{16}{60} \div 5 \times 0.2 \times \frac{\lambda}{180} = \frac{\lambda}{17,000} = 6 \times 10^{-5} \lambda$$

approx. for green. The total path of the light in the water was 2856 cms. Taking its index as 1.33, the number of waves is

$$\frac{2856 \times 1\frac{1}{3}}{.00005} = 7.6 \times 10^7.$$

As 6×10^{-5} of a single wave could be detected, the fraction of the total would be

$$6 \times 10^{-5} \times \frac{1}{7.6} \times 10^{-7} = 7.8 \times 10^{-13}.$$

This represents the greatest difference in velocity or in index between the two components which could exist referred to that of water * for green light, $\lambda = .00005$ cm.

Mascart † has shown that in the case of water under compression the increment in the excess of the index above unity is nearly proportional to the increment of its density. If in the movement of matter through æther an increase in density in this direction took place, producing a change in the natural frequency of the molecular systems similar to that which occurs in glass, say, then, to determine how great it might be from these results, it is necessary to measure the

* For carbon bisulphide Rayleigh obtained the corresponding limit of 4×10^{-11} for yellow light. His retardation was calculated from Wertheim's results. This checks with the data obtained above as 200 gms. gave $2^\circ.5$, hence 25 gms. would give $0^\circ.31$ or $\frac{\lambda_D}{13000}$ instead of $\frac{\lambda_D}{12000}$ which he gives.

† *Optique*, t. iii. p. 613.

increment in phase which represents the sensibility of the experiment in terms of the excess of the index above unity. This excess of index is $\frac{1}{3}$ while the index is $\frac{4}{3}$, hence our limit should be four times larger or $3 \cdot 1 \times 10^{-12}$. The greatest change which could be expected is the difference between unity and $\sqrt{1 - \frac{v^2}{V^2}}$ where v is orbital velocity and V light-velocity or

$$\frac{1}{2} \frac{v^2}{V^2} = \frac{1}{2} (10^{-4})^2 = 5 \times 10^{-9},$$

or about 1600 times greater than the smallest effect which could be observed.

The effect of a change in the frequency of the order $\frac{v^2}{2V^2}$ on the index of the moving molecular vibrations relatively to the *æther* impulses in the direction of motion, is far too small to be observed. Thus the index of water for frequency $5 \cdot 1 \times 10^{14}$ is 1.334 and for $6 \cdot 9 \times 10^{14}$ is 1.341. This gives for a fractional increase in frequency of $\frac{4}{3}$ a fractional increase in index of $0 \cdot 007 \times \frac{4}{3}$. Hence the fractional increase in index due to a change of frequency of order $0 \cdot 5 \times 10^{-8}$ is

$$\frac{0 \cdot 5 \times 10^{-8}}{\frac{4}{3} \times 10^{14}} \times 9 \times 10^{-3} = 3 \cdot 5 \times 10^{-25},$$

while the smallest observable change was $7 \cdot 8 \times 10^{-13}$.

Experiments with Glass.

Two different arrangements were tried with glass. In the first a large slab of "optical" glass (crown) was cut lengthwise and the edges of the two halves ground square. These were then cemented together side by side so as to give approximately square end-surfaces for grinding and polishing. These end-surfaces were "built up" in the usual way so as to ensure a "flat" surface. These two prisms were then cemented end to end, giving a prism 42 cms. long with polished ends 10 cms. by 3.8 cms. These end-surfaces were silvered and a strip at the bottom and top of each removed. The system was then mounted on a support within the trough so that light from the polarizer could pass in and be reflected backwards and forwards until it passed out through the unsilvered space at the other end, where it was again reflected back into the prism by a concave mirror 3 m. radius of curvature, approximately. After the same number of reflexions it passed out to one side of the entering ray and was received by the half-shade analysing system already

described. It was found impossible to obtain a satisfactory match with the half-shade system alone without some other compensation. On examining with the analyser, vertical bands (they appeared horizontal of course) were seen which were quite regular and symmetrical on each side of a central black band. The distance apart of these bands and their distinctness were less as the number of internal reflexions were increased. The total number of passages through the prism varied from ten to eighteen, or a total distance in the glass of from 420 cms. to 756 cms. An attempt was made to compensate by means of the horizontal strip of glass with the clamp for producing flexure. This system was mounted on a universal system so as to bring the black band in the glass strip vertically in front of the analyser. In one position, under flexure, the resulting bands became narrower. On reversing it, so as to interchange the compressed and dilated portions of the strip, the bands became wider and finally disappeared as the flexure was increased up to a certain point. They then reappeared and became narrower with increasing flexure. This compensation increased the sensibility so that a moderate pinch of the prism by the fingers gave a marked shift of the central band which could be observed by means of the two cross-wires already referred to. However, the compensation was not sufficiently satisfactory to obtain good matches with the half-shade. Furthermore, the slightest flexure of the trough or deviation of the beam of sunlight caused the "match" to change in the one case or the band to shift in the other, owing to the narrowness of the beam. Observations with this arrangement would thus be likely to prove unreliable, and the system was finally given up for another which could be rendered more stable, optically, and in which artificial light could be used.

Two cylinders of flint-glass, each 22.3 cms. long and 2.4 cms. in diameter, and of mean index $n_D = 1.77$, were mounted on adjustable supports between the polarizing and analysing systems. The former consisted of the nicol and half-shade system used previously as the analysing system. This was observed through the analysing nicol by a low-power telescope. The source of light was an acetylene flame into which was injected, broadsides, a flat stream of oxygen through a fish-tail burner. This increased the brightness of the field of view several times, and extended the sensibility of the settings by a corresponding amount. The entire system was mounted on a common base, so that once a match was obtained it could be moved without disturbing it. These cylinders were especially well annealed Jena glass used a

number of years ago in experiments on the double refraction of light propagated at right angles to the lines of force in a magnetic field*. Each showed the black cross in certain azimuths between crossed nicols. In order to use this portion of the glass only, diaphragms 3 mms. to 4 mms. in aperture were placed at each of the ends of the cylinders along the optic axis of the system. One cylinder was then inserted and adjusted so as to give the most satisfactory match of the half-shade. The aperture was sufficient for obtaining a close setting, and the field could be made of nearly uniform intensity so that a vanishing-line was approximately realized. The slightest contact of the fingers, however, usually disturbed the match, in consequence of temperature changes. This match could be seen slowly to recover itself on removal of the fingers. Also the slightest flexure in the process of adjustment made itself at once manifest. This entire system was placed upon the large trough, and observations, with the polarizer at 45° to the vertical, made when the same was rotated. At first irregular changes in the match were observed, but these were found to be due to a shift of the eye and head of the observer. To eliminate this a seat was mounted so that the observer could move undisturbed with the trough, the head being steadied by means of a clamp. In this way no change in the field could be observed except in a very few instances. These were attributed to an accidental shift of the eye or to slight temperature changes. Observations were made at noon and at 6 P.M. in the early part of December. At this latter time occasional change could be detected similar to those which had been noted several times in the noon observations. The difficulty in maintaining the conditions for so high a sensibility as was attained, rendered the fictitious effects quite possible. When the greatest care was exercised no change could be detected. Under the most favourable conditions a rotation of the compensator of $0^\circ.2$ approximately could be detected. This corresponds, as shown above, to a change in the relative retardation of $6.5 \times 10^{-5} \lambda$ for the mean portion of the spectrum, $\lambda = .000055$ cm. The total path in the glass was 44.5 cms., and hence the total number of waves is

$$\frac{44.5 \times 1.77}{.000055} = 1.43 \times 10^6.$$

Thus the fraction of the total becomes

$$6.5 \times 10^{-5} \div (1.43 \times 10^6) = 4.5 \times 10^{-11},$$

which is the greatest difference in velocity or in index

* Phil. Mag. p. 342, Oct. 1897.

between the two components which could exist in this kind of glass.

If we estimate the contraction from the change in density by means of the excess of the index above unity, as was done in the case of water and as assumed by Rayleigh, the above fraction would become

$$\frac{1.77}{.77} \times 4.5 \times 10^{-11} \quad \text{or} \quad 10^{-10},$$

approximately. This is 50 times smaller than $0.5 \times (10^{-4})^2$, the change to be expected on the "contraction" hypothesis, and is 30 times less than the sensibility obtained with water.

If, on the other hand, we take Wertheim's * results for glass, we have approximately for Faraday's flint, 5×10^{11} as Young's Modulus and 2.4×10^7 dynes on a millimetre cube to give a relative retardation of one λ . From above we have

$$\frac{6.5 \times 10^{-5} \lambda}{445} = 1.46 \times 10^{-7} \lambda$$

as the relative retardation for 1 mm.

Thus, the force to produce the least observable effect is

$$2.4 \times 10^7 \times 1.46 \times 10^{-7} = 3.4 \text{ dynes per 1 mm.}$$

Young's Modulus for 1 mm. square becomes 5×10^9 and the contraction becomes

$$\frac{3.4}{5 \times 10^9} = 6.8 \times 10^{-10},$$

which is seven times smaller than that expected on the "contraction" hypothesis. If we correct by $\frac{1}{4}$ for Poisson's ratio, as we should if the interference problem were done on a glass support, the calculated contraction becomes

$$0.5 \times (10^{-4})^2 \times \frac{4}{5} = 4 \times 10^{-9}$$

or six times larger than our margin for glass.

Hence, if the test is a valid one, the "contraction" hypothesis cannot explain the negative results of the interference experiments; and, with the same reasoning, we also conclude either that the æther moves with the embedded matter, or that the effect of the relative motion on the intermolecular forces and the possible consequent relative change in dimensions are very small.

Physical Laboratory,
University of Nebraska, Lincoln.

* *Ann. de Chim. et de Phys.* (3) t. xl. p. 202.

[*Note*.—These experiments were repeated during the early part of February, 1904, when the earth's orbital velocity conspires approximately with that of the solar system in space. The conditions for observation were quite as favourable as before; but no effect could be detected. With glass, the optical system was rotated through several quadrants consecutively so as to observe any possible trace of an effect. Observations were made at noon and at 6 P.M.

Hicks*, in a more rigorous discussion than that of Lorentz, of the effect to be expected in the Michelson-Morley experiment, shows that instead of a contraction of $\frac{v^2}{2V^2}$ in the direction of drift, there should be an elongation of $\frac{v^2}{2V^2}$, to account for the negative results of the observations. The experiment itself should thus disprove the FitzGerald-Lorentz hypothesis. Either, on any of the suppositions possible from Lorentz's point of view, viz. contraction along the drift and zero change at right angles, no contraction but extension at right angles to the drift or elongation along and at right angles to the drift, such that the difference is $-\frac{v^2}{2V^2}$, or, on the conclusion of Hicks, the effect to be observed by means of double refraction in the preceding experiments would be the same.—D. B. B.]

XXXVIII. *On the Occurrence of Cavitation in Lubrication.*

By S. SKINNER, M.A., *University Demonstrator of Experimental Physics, Cambridge* †.

[Plates XVII.-XIX.]

§ 1. **T**HE following experiments ‡ arose from an observation made when determining the refractive index of a liquid by means of Newton's rings. As Newton showed, the rings can be obtained when a liquid is run into the space between the lenses (*Opticks*, Obs. 10); and by comparing the radii of the rings with those obtained with the same lenses and air we have a means of measuring the refractive index between air and the liquid. The only difficulty is to arrange the illumination suitably as the rings are far fainter with the liquid than with air.

* *Phil. Mag.* Jan. 1902.

† Communicated by the Physical Society; read November 27, 1903.

‡ These experiments formed the subject of a Demonstration before the Cambridge Philosophical Society, November 10, 1902.

If when the liquid has been introduced the upper lens be rolled on the lower the observer sees following the central dark spot, viewed by reflected light, a crescent-shaped space, very bright provided the illumination be sufficiently oblique. This is a vacuous or vapour-filled space, for when the motion of rolling ceases the liquid flows into the space and completely fills it. Starting the rolling in the opposite direction the same appearances are seen in the reverse order. It was the observation of this space which led me to make the following experiments, and at the time I was unaware that Newton had observed its formation, for the paragraph in which he mentions it is omitted from the quotations which have found a place in modern text-books. In Observation 11 Newton writes:—"When the Water was between the Glasses, if I pressed the upper Glass variously at its edges to make the Rings move nimbly from one place to another, a little white Spot would immediately follow the center of them, which upon creeping in of the ambient Water into that place would presently vanish. Its appearance was such as inter-jacent Air would have caused, and it exhibited the same Colours. But it was not Air, for where any bubbles of Air were in the Water they would not vanish. The Reflexion must have been caused by a subtler Medium, which could recede through the Glasses at the creeping in of the Water."

§ 2. The inflow of the liquid to fill the vacuous space must depend in some way on its viscosity. When a more viscous liquid is used all the effects are more pronounced, and with glycerine or lubricating oil quite large vacuous spaces, frequently broken up into a number of small bubbles, are obtained. The method of observation with oblique light takes advantage of total internal reflexion, and consequently necessitates a certain angle, depending on the refractive index of the glass, and it may be inconvenient. Another mode of observing the space is to use sodium light, when the relatively bright Newtonian rings in the space show up well in contrast with the faint rings in the liquid.

§ 3. A third mode of observation, which is much the most convenient, is to use a deeply coloured liquid and to look at the space by transmitted light. I have found that a very convenient liquid is a strong solution of fuchsin in glycerine. This red solution is so deeply coloured that even up to the point where the lenses are nearest some colour shows, and that light is only brightly transmitted at the place where there is a break in the liquid. Placing this liquid between the lenses, and using daylight reflected from a sheet of white

paper and transmitted through the system, all the appearances which are here described may be seen. It is also very convenient for photographing effects.

§ 4. When the rolling ceases it has been remarked that the cavity fills up quickly with mobile, and slowly with viscous liquids, and this filling of the cavity is quite complete unless some gas or air has found its way in. The liquid is forced back to fill the vacuous space by the atmospheric pressure, and the rate of filling is decided by the viscosity of the liquid. That it is so is seen by the slowness with which oil or glycerine fills the cavity made in it, and is also evident from the relatively large size of the cavity formed in these liquids. The cavity which is formed must be produced either by splitting the liquid itself or by tearing the liquid from the glass surface. The effect may be described as a case of "cavitation." This word has been used by the Hon. C. A. Parsons ('Nature,' May 1898) to describe the production of a cavity in water by a very rapidly rotating screw-propeller. In his experiment the atmospheric pressure was removed from the surface of the water by an air-pump.

§ 5. Before describing the actual effects some account of the stresses in the liquid will help to make the conditions of the cavitation more clear; and in this we shall follow the graphical method used by Osborne Reynolds in his paper on the "Theory of Lubrication" (Phil. Trans. A. 1886). In this paper the origin of the force resisting the motion of two surfaces separated by a continuous and copious supply of lubricant is discussed, and it is shown that it is wholly accounted for by the viscosity in the lubricant.

Let AB and CD represent the sections of two parallel solid surfaces, extended infinitely at right-angles to the

Fig. 1.

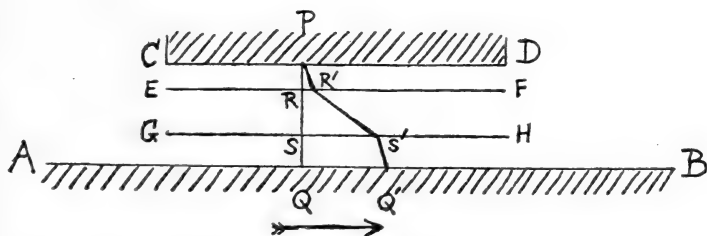

paper, and between them let us suppose three fluid layers lie, bounded by the lines EF and GH. Let us suppose the viscosity of the layers in contact with the solid walls is the

same, and that the viscosity of the central layer is very much less. Let PQ represent a line in the layers when AB and CD are at rest. If now AB moves with a velocity QQ' , then the relative velocities of the particles in parallel layers will be represented by the displacement of $PRSQ$ to $PR'S'Q'$, RR' and SS' representing the velocities at the boundaries of the central layer. If, as we have supposed, the viscosity of the central layer is very small compared with that of the other layers, the inclination of $R'S'$ will be great, whilst PR' and $S'Q'$ will be nearly parallel to RQ . In words, the tangential force opposing the motion of AB will be almost entirely due to the thin central layer of very slightly viscous fluid.

Next we consider the case where CD makes an angle with AB , and EF and GH represent as before the boundaries of the three liquid layers. It is shown by O. Reynolds (*loc. cit.*),

Fig. 2.

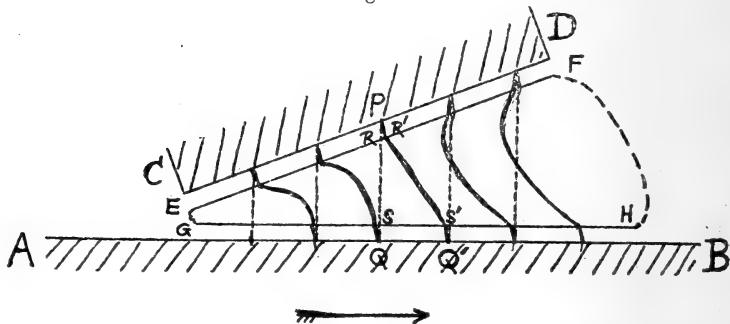

that when one of two plates, at an angle with one another, and having viscous liquid between them, AB is moved in the direction AB a tension is produced tending to draw the plates together. The line $PRSQ$ becomes $PR'S'Q'$. If AB moves in the direction BA this tension becomes a pressure. Let us suppose that the ends of the lines EF and GH are joined, and then we shall have a cavity filled with less viscous fluid in a mass of viscous fluid between the two plates. Cases similar to this are treated in this paper.

§ 6. In figs. 3 and 4 (Pl. XVII.) is represented a cylindrical lens lying on a plane surface with some fuchsin-glycerine solution between them. In fig. 3 everything is at rest, and the line of nearest approach of the surfaces is shown by the absence of colour, *i. e.* the bright band down the centre. In fig. 4 the cylindrical surface is being rolled by the fingers from left to right, and the transparent line of nearest approach is

seen to have moved slightly to the right hand. Following it is seen a dark line behind which is a broader light space traversed horizontally by small streaks of dark liquid. This broader light space is filled only with the vapour of the liquid, for, as we have already stated, it is completely filled with dark liquid as soon as the motion ceases. This cavity has been formed by the splitting of the liquid, and it is of special interest to notice that it is formed not immediately at the line of nearest approach but some short distance behind this line. That the greatest tension in a lubricating liquid is not at the point of nearest approach of the surfaces was shown theoretically by Reynolds, who calculated the pressures and tensions in a layer such as this. Fig. 5 is

Fig. 5.

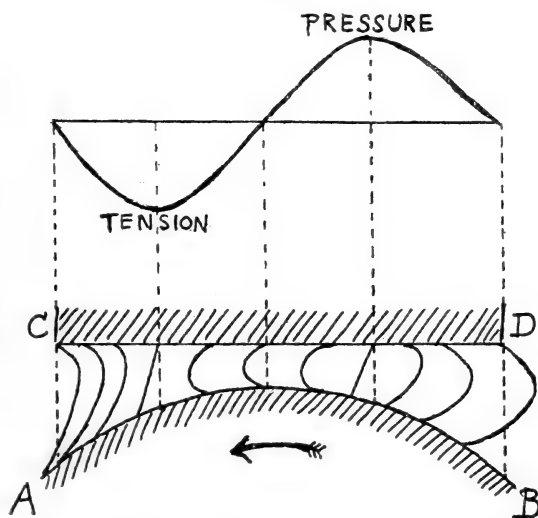

taken from Reynolds' paper, and from it we see that the point of maximum tension is behind the point of nearest approach.

§ 7. In figs. 6 and 7 (Pl. XVIII.) is represented a lens lying on a plane surface. In fig. 6 everything is at rest, and the light spot at the centre shows the point of nearest approach of the lens to the plane. In fig. 7 the lens is being rolled from left to right by the fingers and a collection of cavities has been formed behind the point of nearest approach. As with the cylindrical surface, on stopping the motion the cavities fill completely.

§ 8. In fig. 8 (Pl. XIX.) a lens is being drawn along a plane, and the cavity is visible following the motion, which is from left to right. In fig. 9 (Pl. XIX.) a biprism is being pushed from left to right, and a large cavity is visible behind the edge of the prism which almost touches the plane. The biprism was held so that the angle between the left-hand face and the plane was greater than that between the right-hand face and the plane.

§ 9. Some experiments were made to imitate the actual case of a fully lubricated axle rotating under a bearing. For this purpose a thick disk with its edge worked to a spherical surface of curvature equal to the radius of the disk, mounted on an axle, was arranged so that the lower part of the disk dipped into an oil-bath whilst a flat plate of glass rested on the upper edge of the disk. As the disk rotated oil was carried round so that the point of contact of the disk and plate was maintained copiously lubricated. The disk represented the axle and the plate the bearing on it. What happened on rotation could be observed by looking through the glass plate with a magnifying-glass. It was seen that during motion a cavity was formed on the side where the edge of the disk was moving away from the plate. The size of the cavity depended on the rate of rotation. When the rotation was rapid the cavity grew large and ultimately opened to the air, so that the cavity became an air-space. It was also noticed that small drops of the lubricant were carried across the cavity. These probably had their origin in the thin layer of liquid which separated the disk from the plate at their nearest approach. That there was a pressure on the one side and a tension on the other was shown by drilling a hole through the glass plate and attaching a tube to this hole. When the hole was on the approaching side of the point of nearest approach oil was forced up the tube, whilst when it was on the side where the disk's edge receded air was sucked in through the tube. In fact the latter arrangement formed a small suction-pump. The high pressure in a thoroughly well lubricated bearing was observed by Tower in his experiments on friction (Proc. Inst. Mechanical Eng. 1883-1884).

§ 10. It has been shown by Berthelot*, by O. Reynolds†, by Worthington‡ that a liquid can sustain a large tension or negative pressure. The ascent of sap § in tall trees has

* *Ann. de Chimie et Phys.* vol. xxx. p. 232 (1850).

† Reynolds, 'Collected Papers,' vol. i.

‡ *Phil. Trans.* 1892, A. p. 355.

§ Dixon & Joly, *Phil. Trans.* 1895, B.; Askenasy, *Verhandl. d. naturh. med. Vereins Heidelberg*, N. F. v. (1895).

been explained by a theory in which the liquid sap is under tension. In general the effect has been studied in liquids at rest. It may be supposed that if the movement of the cylinder on the plane in the experiment described in § 6 were sufficiently slow, the negative tension would not be great enough to break the liquid but would help in drawing the liquid forward to fill the space left behind the moving surface. Experiments in which the motion is slow do not show the formation of a cavity, and may be regarded as supporting this view of the action of the tensional strength of the liquid.

§ 11. The slipperiness of ice * has been attributed to the presence of a layer of lubricating water under the body pressing on the ice. The water is produced by the lowering of the freezing-point where the pressure is experienced. On this view the object glides on a liquid layer and consequently viscous friction in water takes the place of the rubbing friction between the solids. Joly shows by calculation that the weight of a man concentrated on the blade of a skate is sufficient to lower the freezing-point very considerably. Reynolds, arguing from the difficulty of slipping on very cold ice, comes to a similar conclusion. I wish to point out that sliding on a liquid layer is a condition under which cavitation will occur in the liquid, and that this will aid the slipping. I find that a cavity can be seen when a convex lens is pressed strongly on ice and pushed along. A cavity of this kind may be formed behind the sliding contact of a hog-back skate, and behind that of a curling-stone.

§ 12. We may now point out the influence which the formation of a cavity has on lubrication. In ball-bearings completely immersed in oil the experiments show that there must be a small cavity near the point of nearest approach of each ball to its neighbours and also to the surface on which it is running. As the friction of the bearing is the viscous friction of the oil, from the considerations in § 5 it follows that it must be reduced by the formation of these cavities which are filled with relatively non-viscous vapour. In fact, if a steel ball thoroughly oiled be rolled against an oiled glass plate the cavity may be directly observed. The high lubricating property of oils owes its origin not only to their superior viscosity but also possibly to the facility with which cavities may be formed in them.

* Joly, Proc. Roy. Dublin Soc. p. 453 (1886); O. Reynolds, Mem. and Proc. of the Lit. and Phil. Soc. of Manchester, xliii. (1899).

XXXIX. *Note on the Radiation from an Alternating Circular Electric Current.* By Prof. W. McF. ORR, M.A.*

1. **I**N this Journal of December 1903, p. 670, formulæ are given for the magnetic force at a great distance from a perfect conductor in the form of a very thin circular ring which carries an alternating current. I did not then notice that these formulæ can be expressed very simply in terms of Bessel's functions: I understand that the connexion had been noticed, though not definitely stated, by Dr. Pocklington (see 'Nature,' Mar. 26, 1903): it may, however, be worth while investigating more fully the expression which can thus be obtained for the rate of radiation of energy.

2. In the notation of the former paper, in case of a current of the type $C_1 \cos(\kappa s + \kappa Vt) + C_2 \cos(-\kappa s + \kappa Vt)$, where s denotes distance measured along the ring from a fixed point, we have for the components of magnetic force at a point which is at a large distance R from the centre of the ring, and whose colatitude and longitude measured from the point $s=0$ are θ, ϕ , respectively, the equations

$$\begin{aligned} \alpha &\doteq -\sigma R^{-1} \cos \theta \left\{ C_1 \sin \kappa(a\phi + Vt - R) \right. \\ &\quad \left. - (-)^\sigma C_2 \sin \kappa(-a\phi + Vt - R) \right\} F_1(\theta) \dagger, \\ \beta &\doteq -\sigma R^{-1} \cos \theta \left\{ C_1 \cos \kappa(a\phi + Vt - R) \right. \\ &\quad \left. + (-)^\sigma C_2 \cos \kappa(-a\phi + Vt - R) \right\} f_1(\theta), \\ \gamma &\doteq \sigma R^{-1} \sin \theta \left\{ C_1 \cos \kappa(a\phi + Vt - R) \right. \\ &\quad \left. + (-)^\sigma C_2 \cos \kappa(-a\phi + Vt - R) \right\} f_1(\theta), \end{aligned}$$

where

$$F_1(\theta) = \int_{-\pi}^{+\pi} \cos \psi \cos \sigma(\psi + \sin \theta \sin \psi) d\psi,$$

$$f_1(\theta) = \int_{-\pi}^{+\pi} \sin \psi \sin \sigma(\psi + \sin \theta \sin \psi) d\psi,$$

and $\kappa a = \sigma =$ any integer, a being the radius of the ring.

3. The relation $\kappa a = \sigma =$ an integer holds, approximately, for some of the free periods ‡, which were more immediately referred to in the previous paper; if, however, the current is of the type $C_1 \cos(\sigma\phi' + \kappa Vt) + C_2 \cos(-\sigma\phi' + \kappa Vt)$,

* Communicated by the Author.

† The accidental omission of a factor κ from the expressions $\kappa(\pm a\phi + Vt - R)$ is here corrected.

‡ The equation determining the free period appears, however, for every value of σ to have an infinite number of roots; and there appear to be modes of free motion corresponding to the case $\sigma=0$, one of the corresponding values of κ being a pure imaginary.

ϕ' denoting the longitude, where σ is still an integer but κ is unrestricted, it is readily seen that we obtain

$$\alpha \doteq -\kappa a R^{-1} \cos \theta \{ C_1 \sin (\sigma \phi + \kappa V t - \kappa R) - (-)^{\sigma} C_2 \sin (-\sigma \phi + \kappa V t - \kappa R) \} \\ \int_{-\pi}^{+\pi} \cos \psi \cos (\sigma \psi + \kappa a \sin \theta \sin \psi) d\psi,$$

with corresponding changes in the formulæ for β and γ .

Now

$$\cos (x \sin \psi) = J_0(x) + 2J_2(x) \cos 2\psi + 2J_4(x) \cos 4\psi + \dots$$

and

$$\sin (x \sin \psi) = 2J_1(x) \sin \psi + 2J_3(x) \sin 3\psi + \dots$$

hence

$$\cos (\sigma \psi + x \sin \psi) = \cos \sigma \psi \{ J_0(x) + 2J_2(x) \cos 2\psi + 2J_4(x) \cos 4\psi + \dots \} \\ - \sin \sigma \psi \{ 2J_1(x) \sin \psi + 2J_3(x) \sin 3\psi + \dots \}.$$

Multiplying by $\cos \psi$ and integrating, we obtain

$$\int_{-\pi}^{+\pi} \cos \psi \cos (\sigma \psi + x \sin \psi) d\psi = (-)^{\sigma+1} \pi \{ J_{\sigma-1}(x) + J_{\sigma+1}(x) \} \\ = (-)^{\sigma+1} 2\pi \frac{\sigma J_{\sigma}(x)}{x}.$$

Also

$$\int_{-\pi}^{+\pi} \sin \psi \sin (\sigma \psi + x \sin \psi) d\psi = -\frac{d}{dx} \int_{-\pi}^{+\pi} \cos (\sigma \psi + x \sin \psi) d\psi,$$

and from the same equations this is readily seen to be

$$(-)^{\sigma+1} 2\pi J'_{\sigma}(x).$$

If now in the expression for the current we write $C_1 = C_2 = C/2$, we see that the magnetic force due to the current $C \cos \sigma \phi' \cos \kappa V t$ is given by the equations

$$\alpha \doteq 2C\pi\kappa a R^{-1} \cos \theta \sin \sigma \phi \cos \kappa(Vt - R) \cdot \sigma J_{\sigma}(\kappa a \sin \theta) / \kappa a \sin \theta,$$

if σ even ;

$$\text{or } \doteq -2C\pi\kappa a R^{-1} \cos \theta \cos \sigma \phi \sin \kappa(Vt - R) \cdot \sigma J_{\sigma}(\kappa a \sin \theta) / \kappa a \sin \theta,$$

if σ odd ;

$$\beta \doteq 2C\pi\kappa a R^{-1} \cos \theta \cos \sigma \phi \cos \kappa(Vt - R) \cdot J'_{\sigma}(\kappa a \sin \theta), \text{ if } \sigma \text{ even ;}$$

$$\text{or } \doteq 2C\pi\kappa a R^{-1} \cos \theta \sin \sigma \phi \sin \kappa(Vt - R) \cdot J'_{\sigma}(\kappa a \sin \theta), \text{ if } \sigma \text{ odd ;}$$

γ being obtainable from β by changing the factor $\cos \theta$ into $-\sin \theta$.

Hence the time-mean value of $\alpha^2 + \beta^2 + \gamma^2$ is

$$\doteq 2\pi^2 C^2 \kappa^2 a^2 R^{-2} \{ \cos^2 \theta \sin^2 \sigma \phi \cdot \sigma^2 J_\sigma^2(\kappa a \sin \theta) / \kappa^2 a^2 \sin^2 \theta \\ + \cos^2 \sigma \phi \cdot J_\sigma^2(\kappa a \sin \theta) \},$$

if σ is even, and an expression obtainable from this by interchanging $\sin \sigma \phi$, $\cos \sigma \phi$, if σ is odd. And the mean rate of radiation across the sphere of radius R , being the mean value of $(4\pi)^{-1} \int (\alpha^2 + \beta^2 + \gamma^2) dS$, accordingly becomes

$$\pi^2 C^2 \kappa^2 a^2 V \int_0^{\pi/2} \sin \theta \{ \sigma^2 J_\sigma^2(\kappa a \sin \theta) \cos^2 \theta / \kappa^2 a^2 \sin^2 \theta + J_\sigma^2(\kappa a \sin \theta) \} d\theta,$$

except that if $\sigma=0$ the above must be doubled, since in that case the mean value of $\cos^2 \sigma \phi$ is 1 instead of $\frac{1}{2}$. By means of the relations

$$\sigma x^{-1} J_\sigma(x) = \frac{1}{2} \{ J_{\sigma-1}(x) + J_{\sigma+1}(x) \}$$

$$J'_\sigma(x) = \frac{1}{2} \{ J_{\sigma-1}(x) - J_{\sigma+1}(x) \}$$

this may be written in the form

$$\frac{1}{2} \pi^2 C^2 \kappa^2 a^2 V \int_0^{\pi/2} \sin \theta \{ J_{\sigma-1}^2(\kappa a \sin \theta) + J_{\sigma+1}^2(\kappa a \sin \theta) \\ - 2\sigma^2 \kappa^{-2} a^{-2} J_\sigma^2(\kappa a \sin \theta) \} d\theta.$$

Using the relation

$$J_\sigma^2(x) = \overline{\Pi(\sigma)} |^{-2} 2^{-2\sigma} x^{2\sigma} F \{ \sigma + \frac{1}{2}; \sigma + 1, 2\sigma + 1; -x^2 \}^*,$$

where $F(\alpha; \rho_1, \rho_2; y)$ denotes the hypergeometric series

$$1 + \frac{\alpha}{\rho_1 \rho_2} y + \frac{\alpha(\alpha+1)}{\rho_1(\rho_1+1)\rho_2(\rho_2+1)} \frac{y^2}{1 \cdot 2} + \dots$$

and integrating each term separately, we see that

$$\int_0^{\pi/2} \sin \theta \cdot J_\sigma^2(x \sin \theta) d\theta = \frac{x^{2\sigma}}{\overline{\Pi(2\sigma+1)}} F(\sigma + \frac{1}{2}; \sigma + \frac{3}{2}, 2\sigma + 1; -x^2) \\ = x^{-1} \int_0^x J_{2\sigma}(2u) du.$$

The expression for the rate of radiation may thus be written in the form

$$\frac{1}{2} \pi^2 C^2 \kappa^2 a^2 V \left\{ \frac{(\kappa a)^{2\sigma-2}}{\overline{\Pi(2\sigma-1)}} F(\sigma - \frac{1}{2}; \sigma + \frac{1}{2}, 2\sigma - 1; -\kappa^2 a^2), \right. \\ + \frac{(\kappa a)^{2\sigma+2}}{\overline{\Pi(2\sigma+3)}} F(\sigma + \frac{3}{2}; \sigma + \frac{5}{2}, 2\sigma + 3; -\kappa^2 a^2), \\ \left. - \frac{2\sigma^2 (\kappa a)^{2\sigma-2}}{\overline{\Pi(2\sigma+1)}} F(\sigma + \frac{1}{2}; \sigma + \frac{3}{2}, 2\sigma + 1; -\kappa^2 a^2) \right\},$$

* Proc. Camb. Phil. Soc. May 1899.

or in the equivalent form

$$\frac{1}{2}\pi^2 C^2 \kappa a V \int_0^{\kappa a} \{J_{2\sigma-2}(2x) + J_{2\sigma+2}(2x) - 2\sigma^2 \kappa^{-2} a^{-2} J_{2\sigma}(2x)\} dx,$$

the latter of which can be expressed also as

$$\pi^2 C^2 \kappa a V \{J'_{2\sigma}(2\kappa a) + (1 - \sigma^2 \kappa^{-2} a^{-2}) \int_0^{\kappa a} J_{2\sigma}(2x) dx\}.$$

This expression agrees with that obtainable from Pocklington's paper * by using the relation there obtained between the current and the electric force at the surface of the wire. (The solution there taken appears, however, to correspond to divergent, not convergent, waves.)

4. In case $\kappa a = \sigma$ the rate of radiation thus assumes the simple form

$$\pi^2 C^2 \sigma V J'_{2\sigma}(2\sigma).$$

5. When $\sigma = 0$ the expression obtained for the general case in § 3 has, as previously stated, to be doubled, and the result may thus be written

$$2\pi^2 C^2 \kappa a V \int_0^{\kappa} J_2(2x) dx.$$

In case κa is small this becomes $\pi^2 C^2 \kappa^4 a^4 V / 3$. The radiation in this case was investigated by FitzGerald †; his result is one-half of the above; he has, however, taken the mean value of \sin^2 (colatitude) over a sphere as $\frac{1}{3}$ instead of $\frac{2}{3}$.

6. If κa is very great we may use approximate forms of the hypergeometric series for large values of the variable, or may proceed more simply as follows:—Except for small values of θ , the α component of the magnetic force at a great distance is now very small compared with the resultant of β, γ , and the first formula for the mean rate of radiation assumes the approximate form

$$\pi^2 C^2 \kappa^2 a^2 V \int_0^{\pi/2} \sin \theta J_{\sigma}^2(\kappa a \sin \theta) d\theta.$$

Evidently in this integral we may use the approximate formula for $J'_{\sigma}(x)$ when x is large, viz.:

$$(2/\pi x)^{\frac{1}{2}} \sin \{(2\sigma + 1)\pi/4 - x\},$$

* "Electrical Oscillations in Wires," Proc. Camb. Phil. Soc. 1897.

† 'Scientific Writings,' p. 125; Trans. R. D. S. Nov. 18, 1883.

and by doing so it becomes

$$(\pi\kappa a)^{-1} \int_0^{\frac{\pi}{2}} \{1 - (-)^{\sigma} \sin(2\kappa a \sin \theta)\} d\theta \\ \doteq (2\kappa a)^{-1}.$$

Thus the rate of radiation becomes $\pi^2 C^2 \kappa a V/2$, but, as before, this expression is to be doubled in case $\sigma=0$.

7. Any periodically alternating current can be resolved into a number (in general doubly infinite) of elementary currents each of the simple harmonic type discussed above, and it is evident that the mean rate of radiation is the sum of the mean rates of radiation due to each of such constituents separately.

It appears from this and from the result of § 6 that if the current is a simple harmonic function of the time, and if the wave-length in free space is small compared with the radius, the radiation approximately depends only on the mean value of the square of the current averaged round the circle, and is otherwise independent of the law of variation from point to point.

8. Lord Rayleigh, in an investigation of the work done by given forces applied at given points of an elastic solid, has referred * to the case when the forces act tangentially along a circle, in connexion with the subject of the present note. He states that "it would seem that (33) must lead to a more complicated expression for the energy radiated than that in Dr. Pocklington's investigation." As I understand it he considers in his expression (33) the applied forces F, F' , to be the analogues of electromotive forces and proposes to replace them therein by expressions in terms of the conduction current obtained from Pocklington's results. The parallelism between the electromagnetic and the elastic-solid theories does not appear, however, to extend so far. A current of conduction presents itself in the electromagnetic equations as a discontinuity in the time-rate of change of the electric force †. The force F applied to the elastic solid is the analogue, not of an applied electromotive force, but of $-du/dt$, where u is an impressed conduction current; accordingly in Lord Rayleigh's expressions for the displacement of the medium at a point P due to a force F applied at another point O , F is to be regarded as the equivalent of $-du/dt$. Yet again, in obtaining the rate of radiation we do not multiply F' , or $-du'/dt$, by the velocity of displacement

* Phil. Mag. Oct. 1903.

† Compare Macdonald, 'Electric Waves,' p. 16.

thus found; instead, we multiply $-u'$ (in motion harmonically periodic) by the electric force corresponding to the displacement thus found, that is by $4\pi V^2$ times the displacement, or by $-4\pi iV/\kappa$ times the velocity ($e^{i\kappa Vt}$ being the time factor). Thus in applying (33) to an electric problem F' is to be replaced by $-u'$, and F by $-4\pi iV/\kappa \cdot (-du/dt)$ or $-4\pi V^2 u$; when this is done in the present case all the results agree.

9. I would take this opportunity of correcting the following error in my former paper * :—p. 671, line 4 from foot, delete "slowest constituent" and for "small" read "large."

XL. The Simmance-Abady "Flicker" Photometer.

By MESSRS. SIMMANCE & ABADY †.

[Plate XX.]

JUM

THIS photometer is of the alternating-light type, recently called in France "scintillation-photometer," but more generally known in America and England as "flicker."

A very long experience with all the known variations of "flicker" photometers, and the construction of many others of different patterns, resulted in the design of the present instrument, and enabled actual rules to be laid down, which when adhered to produce a photometer which is most sensitive to degrees of lights of the same colour, and also enable the intensities of the most violently contrasted tints to be compared and balanced.

These rules are as follows:—The light effects must be in juxtaposition without any apparent division line, and must move, oscillate, or rotate so that the point of juncture of the rays of the two lights passes and returns entirely across the vision-field. Any hiatus, or longer exhibition of one light than the other, biases the result. The observation surface or surfaces upon which the light rays fall, must be at exactly the same distance from the eye, at exactly the same angle in relation to the line of sight, and must be of pure white such as is afforded, for example, by a clean chalk, plaster of Paris, magnesium carbonate, or barium sulphate; any tint affects the accuracy of the result. The observation surfaces must also themselves in turn occupy the field of vision; an apparent movement or optical illusion does not afford accurate results.

Sir W. Abney, whose work in colour photometry is so well known, has placed on record his opinion that in using the

* *Phil. Mag.* Dec. 1903.

† Communicated by the Physical Society: read December 11, 1903.

“flicker” photometer, the operator was in some way testing acuteness of sight, and not relative intensities. Acuteness of sight naturally does come into play in this, as in all other matters in which sight is used at all, but when we remember that with lights of the same tint we apparently see in the photometer a white surface which is alternately illuminated by the two lights, we must conclude that when this alternation is invisible (that is to say, when we can see no change) the reason is because both lights are of the same power. Naturally, abnormally acute vision would perceive more minute changes of intensity, but this is a factor always present in any investigation of the sort.

It appears quite certain that the relative intensities of two lights, whether of the same colour or different, *can* be accurately and easily gauged by the method. An interesting experiment has recently been conducted by Mr. Roxburgh and Mr. Young, of the Ophthalmic Hospital. Readings upon this photometer were made independently by, firstly, Mr. Jacques Abady, who is an experienced photometrist, but suffering from astigmatism; secondly, a gentleman with a pupil dilated by treatment with atropin; thirdly, a patient from the hospital, absolutely colour-blind; and, fourthly, by the writer, whose sight is considerably impaired, but who has some experience with photometer reading. All the results coincided, and this not only when the lights were of the same white tint, but with red against white, green against white, and green against red. A test of very dark blue against red showed slight discrepancies, owing, probably, to the great obscuration of the light by the blue, almost black, glass, but even these were no more in importance than would probably have occurred when using a Lummer-Brodhun or Bunsen disk with lights of the same colour.

The method of reading with this photometer resolves itself into the simple question as to whether the disk of light seen through the sighting tube is moving or is motionless. An observer who makes a reading for the first time, when he fully understands that he is required to do no more than this, can read with as great facility and accuracy as an experienced operator, and it is this facility which gives value to an apparatus intended for testing the high intensity lights in vogue at the present time, and also colour effects.

As to the causes of the phenomenon, they, no doubt, are simple on the surface, but may be more complex when closely considered. The pupil of the eye cannot adjust itself to the rapidly changing intensities, and when the balance is struck, the light, being unchanging and motionless, permits of pupil

adjustment. The colours then blend by persistence of the impression, but should the intensities again change, this retentive sense is dulled by the anxiety of the nerves controlling the pupil orifice to perform their work, an endeavour, however, frustrated by the rapid changing. It appears certain that an abnormal excitation of the nerves controlling the diaphragm has the effect of lessening the susceptibility of the retina to retention of impressions, whether this excitation is caused by glancing at a bright light or by gazing too long at the changing disk of the photometer. When the nerves are over-strained in this way the "flicker" does not disappear at all in many cases, although the point of equality of intensity is always unmistakable. Thus in using the photometer it is suggested that the instrument shall be moved along the bar rather rapidly, the while observing the disk through the sighting-glass. The "motionless" point will then be apparent at once, and by a little practice (which in this, like everything else, generates confidence) an operator will swing the disk-box into its balance of intensity without an effort and without giving the sensitiveness of his retina time to suffer from the numbing effect of the flickerings or throbbing. These conditions point to the possibility of the eyes becoming under other circumstances of stress unable to appreciate the disappearance of the flicker. Obviously, if fatigue can produce such effects as described, certain conditions of health will act similarly. It may be that a bad liver will produce a constant flicker effect; it is quite certain, however, that no circumstances short of partial or absolute blindness can prevent the point of equality of intensity being appreciated, although it may evidence itself in different appearances of the disk according to the varying conditions of the retina as mentioned above.

The writer would submit, with all deference to the expressed opinions of many of the world's greatest scientists, that the Purkinje phenomenon does not affect the accurate working of the form of Flicker photometer shown, if indeed it affects any form of alternating photometer. This Purkinje effect may be briefly described in this way:—A right-angled wedge receives upon one face the reddish light from a pentane standard, and on the other the bluish light from an arc-lamp—we then adjust the relative positions of the arc-lamp, the pentane standard, and the wedge until we obtain what we consider is an equal illumination on the two adjacent sides of the wedge. If we then move in both these lights to half their distance from the wedge, we find that the retinal stimulation or apparent brightness of the two surfaces is no

longer the same. It is quite clear from this (and also we may gather the cause from Fechner's law and Von Helmholtz) that the retinal sensation of brightness does not increase according to the same law for all colours. It is obvious, therefore, that no unaided eye can judge accurately in photometrical comparisons so long as the disturbing effect of colour is present, unless the distances between the receiving surfaces and the lights are arranged according to some rule which must take the place of that of inverse squares. To put this in another way, it follows that even though an expert photometrist can with a Bunsen or Lummer-Brodhun apparatus arrive at what he is certain is (and what is no doubt) a fair balance of the two tints he is comparing, yet grave doubts must exist as to whether the relative candle-powers of the two sources can be taken as being indicated by this balance. The Purkinje effect is purely a colour effect and colour does not enter into consideration in this "Flicker" photometer.

No one would dream of considering a colour-blind person to be affected by the Purkinje law, and yet, as has been shown, such a person can read accurately with this photometer. The experiments made to prove the Purkinje phenomenon have all been carried out with coloured surfaces, never, so far as is generally known, with a scintillation photometer, but conclusive trials have shown that with this instrument as now shown, no alterations in distance disturb the true readings. A red light compared with a green at 3 metres gives the same comparative intensities to each as at 2 metres, and an arc-light tested against a 10-candle pentane lamp at 40 feet indicates the same candle-power as when the distances are reduced to 15 feet. Thus the question of colour does not interfere with the results.

The accuracy of the photometer for coloured lights is confirmed by the following experiments.

Two standard lamps of exactly the same power were used, one at each end of the photometer-bar. A coloured glass screen was interposed, to intercept the rays from one light, which was then measured against the unscreened light. This gave value for one coloured screen. A second colour was then substituted for the first and its value measured against the same unscreened light. Thus the following values were obtained:—

- (a) Unscreened lights.
- (b) Candle-power of one light screened with one colour.
- (c) Candle-power of one light screened with the other colour.

It is obvious, therefore, that one obtained the theoretical ratios of the one light screened with the first colour in terms of the other light screened with the second colour. Then the one colour was compared against the other, and the results show how nearly this ratio agrees with the theoretical ratios. Various initial powers of lights and various lengths of bars were used for these experiments. All the readings on the bar were computed according to the law of inverse squares; and it was therefore assumed that the absence of "flicker" or point of equality indicated by the Simmance-Abady photometer is *candle-power* of intensity of light.

The following tests are the mean of three persons' readings, and the three individual readings all made independently showed practically no variations.

| | Power in Candles. | Theoretical Ratio. $\left(\frac{\delta}{\theta}\right)$. | Actual Reading on Photometer. |
|-----------------------------|----------------------|--|----------------------------------|
| Signal Green δ | 21.8 | 1.4 nearly | 1.39 |
| Signal Red..... θ | 15.6 | | |
| Yellow δ | 9.75 | 4.67 | 4.75 |
| Blue θ | 2.088 | | |
| Yellow δ | 10.01 | 6.9 | 6.86 |
| Red..... θ | 1.45 | | |
| Green..... δ | 2.16 | 1.08 | 1.08 |
| Blue... θ | 2.0 | | |
| Purple δ | 2.0 | 1.29 | 1.275 |
| Red..... θ | 1.55 | | |
| Purple δ | 3.81 | 1.95 | 1.9 |
| Signal Green..... θ | 2.0 | | |

To detail briefly the construction of this Simmance-Abady photometer:—It consists of a wheel of a white material (Pl. XX. fig. 1) with a specially shaped periphery, which wheel is caused to revolve before an eyepiece by means of a suitable motor. At right angles to the line of sight and parallel with the axis of the revolving wheel are the two lights undergoing examination, the rays of which fall upon the shaped periphery of the wheel, enabling the effect of each light to be seen in turn through the eyepiece.

Pl. XX. fig. 2 shows the four cardinal positions of the wheel in sequence, illuminated by two unequal lights. It will be seen how the light effects travel across the line of vision and alternate as the wheel revolves.

The revolving wheel has its periphery formed by two equal conical surfaces or other surfaces of revolution. The axes of the two conical surfaces are each parallel to the axis of the revolving wheel, at exactly equal distances therefrom, and the three axes lie in the same plane. The vertices of the conical surfaces are at equal distances on opposite sides of the line of sight. In manufacturing, the wheel is first made as a disk of uniform thickness. It is then chucked in a lathe eccentrically, and a straight line motion being given to the cutting or grinding tool, the conical surfaces are generated. The wheel is then rechucked eccentrically on the opposite side, and the other conical surface is generated by the cutting or grinding tool, having the same straight line motion as before. The result is that the periphery of the wheel has its two sides uniformly sloping at equal opposite angles, while the ridge of intersection of the two surfaces crosses and re-crosses the axis of vision during each revolution. This wheel is driven with a motion communicated from a suitable motor, either spring, electric, or any form which will produce absolutely regular motion—and at the same time afford means for easily adjusting the speed. In the instrument shown an expansion governor is utilized driven at a carefully arranged ratio speed, but the connexion between the spindle carrying the governor and that carrying the reflecting wheel is not rigid, but effected by means of a coiled spring. The most perfect accuracy of centring is essential. Outside the box are the remontoir, stopping, and starting lever, and speed adjustment, a spring motor being used.

The peculiar shape of the reflecting-wheel affords means for using it in manners quite impossible in any other form of colour photometer, that is to say, it may, at will, test lights at various angles from the horizontal. Having found the careful cutting of the angles of the wheel so vital it necessarily follows that when lights out of the horizontal are being tested, the box containing the wheel must be just as carefully turned on its axis for preserving the arranged conditions. A double quadrant scale (one scale being numbered at double the actual angle) and a small sighting or view-finding attachment enable the angle formed by the horizontal of the one light and the altitude of the other to be accurately ascertained, and the box to be placed at the correct angle of bisection.

The photometer is made to suit any bar or scale. The standards of dimensions are those of the Lummer-Brodhun apparatus and the ordinary Bunsen disk-box.

XLI. *On the Viscosity of Pitch-like Substances.* By Prof. F. T. TROUTON, F.R.S., and Mr. E. S. ANDREWS, B.Sc.*

THE various methods which have been proposed for measuring viscosity meet with difficulties when it is attempted to apply them to the measurement of the viscosity of bodies such as pitch. The girder method has been applied to examine the viscosity of ice as well as methods depending on direct extension and compression; but these apparently did not lead readily to a numerical determination of the coefficient of viscosity. The application of Stokes' method, depending on the rate at which a spherical body—say a lead bullet—sinks through the material, seems apparently to have been prevented by the difficulty of knowing exactly its velocity in the middle of the substance, the terminal effects leaving considerable uncertainty. As described later, this particular difficulty was surmounted by the use of Röntgen rays in some experiments made to compare the coefficient obtained by this method and that by the method described in this paper.

To obviate some of the difficulties, a method was proposed involving the torsion of a cylindrical bar. In this method a constant torque was applied to a cylinder of the substance, and the relative motion of the ends observed. From these and the dimensions of the body the viscosity was calculated.

From symmetry we may assume that any two planes in the body, lying at right angles to the axis of the cylinder, move over each other, about the common axis, remaining plane all the while.

Let δx be the distance apart of the two planes. Then, if μ is the coefficient of viscosity of the material of the cylinder (supposed independent of the velocity), and $\delta\omega$ the relative angular velocity of the planes, we have

$$T = 2\pi\mu \frac{\delta\omega}{\delta x} \int_0^R r^3 dr,$$

where T is the torque applied.

Thus we have

$$\mu = \frac{2T}{\pi UR^4},$$

where U is the relative angular velocity per centimetre of length of the cylinder, and R is its radius.

The form finally adopted for applying the method consisted in a shaft turning freely on anti-friction wheels with a pulley attached, from which hung a weight for the purpose of

* Communicated by the Physical Society: read June 12, 1903.

applying the constant torque (see fig. 1). The shaft carried a square socket for the purpose of gripping the squared end of the cylinder of the substance, which was made to fit exactly. A similar but fixed socket prevented the other end from turning. The rate of rotation was observed by means of a divided circular disk carried on the shaft. With this apparatus the experiments described below were undertaken

Fig. 1.

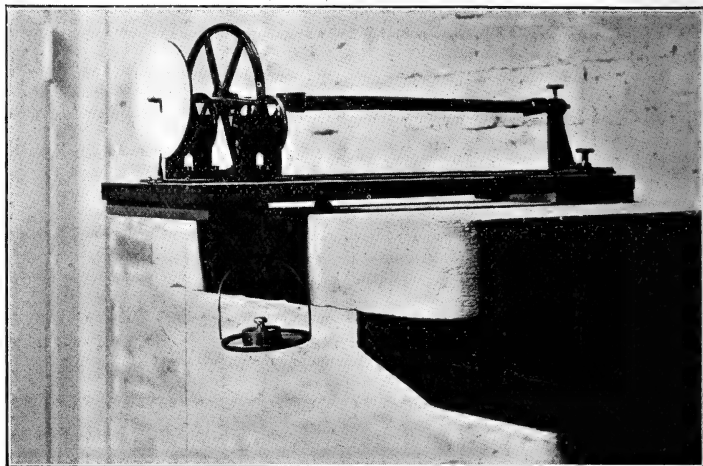

to test whether (1) the rate of rotation was proportional to the torque; (2) the rate of rotation of cylinders of the same material was inversely as the fourth power of the radius.

Incidentally two unsuspected effects were at once disclosed by the use of this apparatus. One is that the coefficient of viscosity of bodies such as pitch is a function of the time, observations showing that the velocity of flow for a given stress diminishes with time from its initial value down to a constant quantity. The second is that on removing the stress there is a flow back in the opposite direction, which gradually diminishes to zero with time.

The method lends itself also to the determination of the coefficient of viscosity at different temperatures, as the cylinder can be conveniently surrounded by a jacket and kept at any required temperature. This mainly arises from its not being necessary to have access to the bar while under observation.

In this way the coefficient for soda-glass was determined at temperatures ranging between 500°C. and 700°C. , and that of pitch from 0°C. to 15°C.

Experiments with Pitch.

The greatest difficulty experienced here was the finding of a convenient method of preparing suitable cylinders. After trying various methods, the most successful was the simple one of rolling the pitch between boards while still soft and warm after recent heating. This was done on a square wooden board by means of a narrower board with end guides—hanging down over the side of the square board—which enabled it to be drawn parallel to itself backwards and forwards over the square board. Two thin strips of desired thickness acted as distance-pieces to regulate the final diameter of the cylinder. With a little practice very perfect cylinders can be rolled in this way. The next stage was to put squared ends to the rods. This was done by softening the pitch and thickening and squaring the ends as shown in fig. 2. The ends were slightly tapered to fill the sockets

Fig. 2.



on the apparatus which were also tapered. It is desirable to have the thickness of the squared ends larger than that of the cylinder, in order that as little as possible of the observed flow may take place at the squared ends: otherwise the rate

Fig. 3. Torsional Force removed.

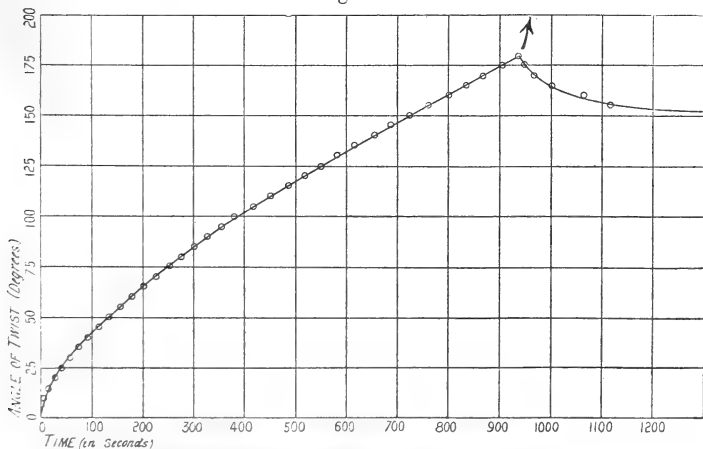

The Viscosity of Pitch. March 16th, 1903.

of rotation would have to be observed between two marked points on the bar.

The results obtained with a specimen of pitch sold under *Phil. Mag. S. 6. Vol. 7. No. 40. April 1904.* 2 B

the name of "British Pitch" are plotted in fig. 3, and show the two effects mentioned above.

On first applying the torque there is a rapid flow or movement, which gradually diminishes and finally reaches a steady state. This steady state of rotation would apparently go on indefinitely but for the bending produced in the cylinder by its own weight, which finally introduces complications. Indeed, by judiciously keeping the cylinder horizontal by slight upward pressure occasionally applied, it is possible to twist the cylinder for hours together.

If a white line be painted along the specimen before twisting, a beautiful spiral line of many twists is ultimately obtained. Probably with arrangements to make the experiments under a fluid of the same density as pitch so as to remove the vertical component of force on the pitch, the rotation could be kept going as long as one pleased.

Elastic Viscous Recovery.—This second effect is shown at the end of the curve, where on removing the turning couple the cylinder of itself turns back some little distance, at first rapidly, then slowing down gradually to rest.

Evidently, to do this, energy must have been stored in the substance in the form of elastic strain. The effect may perhaps be looked upon as complementary to the initial state when the rate of displacement is abnormally great in comparison to the final or steady rate of rotation. In this initial stage a store of elastic energy is gradually accumulated, which is preserved intact during the state of steady rotation, and is given out on removal of the stress to produce the return flow.

Different Torques applied to the same-sized Cylinders.—Experiments were made to ascertain if the connexion between the torque and the rate of rotation was that deduced from the simple theory given above. These experiments show that though for practical purposes the theory is sufficient, yet in reality the phenomenon is more complicated than therein assumed. The results are shown in fig. 4, where the final or steady angular velocity is plotted against the weight producing it. It will be seen that for small torques the rate of rotation is proportionally less than that for larger ones, but that finally above a certain value the curve develops into a straight line. For all values of the torque above this value, on subtracting a small constant quantity we get proportionality. This is probably partially due to the purely elastic strain, and will be better understood from later consideration in this paper.

Determinations with different-sized Cylinders.—Determinations made with different-sized cylinders were in satisfactory

agreement with the inverse-fourth-power law. As an example, the values obtained with two cylinders of the same kind of pitch and determined at the same temperature are given here:—

| R. | T. | l. | U. | μ . |
|--------|------------------------|--------|---------------------------|---------------------------|
| (cm.). | (dyne cm.). | (cm.). | (steady value). | |
| ·36 | $9\cdot65 \times 10^4$ | 21·5 | $7\cdot87 \times 10^{-4}$ | $9\cdot9 \times 10^{10}$ |
| ·67 | $1\cdot04 \times 10^5$ | 24·5 | $7\cdot96 \times 10^{-4}$ | $10\cdot1 \times 10^{10}$ |

Fig. 4.

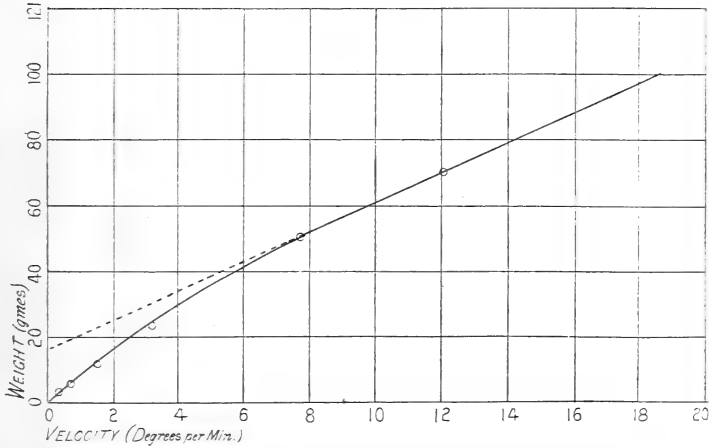

Curve showing relation between Weight and Viscosity.

The Rate of Dissipation of Strain Energy.—The apparatus enables us to show that the strain energy, which we have seen to exist in a viscous substance when flowing, will disappear in course of time without there being any movement of the substance as a whole.

The rate of dissipation of the strain energy, which becomes stored in the cylinder of pitch when rotating, was determined by the simple device of gradually removing the weights, producing torque, at such a rate as just to prevent rotation taking place in either direction.

If the weights are wholly removed, the cylinder turns backwards; if left on it continues in its forward rotation. Some intermediate weight will just suffice to hold it at rest at any moment. This weight must be continuously diminished, and finally reaches zero. To admit of this gradual removal, the weight of course must not be in one piece but must be made up of a large number of small pieces. The rate at which the weight must be diminished can afford a measure of the rate at which the strain energy in the substance

is dissipated and converted into heat, provided there is a linear relation between stress and strain.

Fig. 5 gives the curve of dissipation obtained from a cylinder of pitch. The experiment was not carried to completion, and at the end of one hour, on removal of the whole

Fig. 5.

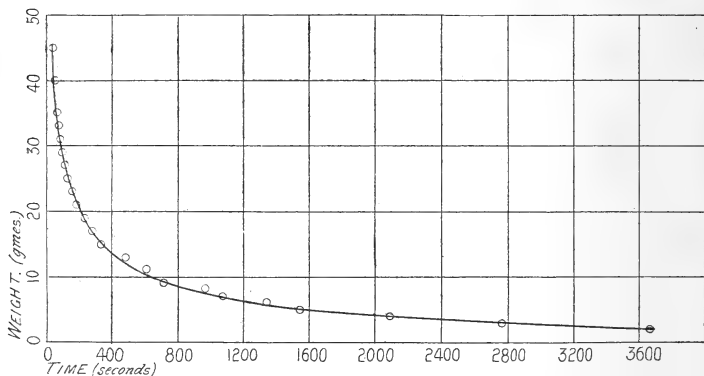

Dissipation Curve for Pitch.

weight still on the apparatus, the pitch was found to be able to recover several degrees. The curve is not a logarithmic one as might have been very well expected; the lower part indeed fits well with a rectangular hyperbola.

This gradual dissipation of strain energy bears an analogy to the dissipation of the energy which takes place in an electrically strained dielectric which is partly conducting.

We may look upon the steady state of flow as one in which there is a continuous transformation of the elastic strain energy into heat, and an equal continuous replenishment of the strain energy from the work done by external forces—a kind of dynamic equilibrium.

This point of view is suggestive as giving an insight into processes going on in substances in the viscous flow; namely, that the sequence of events is primarily a production of elastic strain which is rapidly dissipated by the breaking down, so to speak, of the strained material. The fact that the strain energy can disappear without any deformation occurring, enables us to draw a distinction between plastic and viscous substances. In a plastic substance, when held under constant deformation beyond its elastic limit, the strain energy it then contains does not sensibly lower with time; whereas we have seen that the contrary is the case with viscous substances.

The rate at which the dissipation of strain energy takes place may be different in different substances. We have thus to consider a new property of the substance: the rate at which the strain energy is dissipated under specified conditions.

The Viscosity of Soda-Glass at different Temperatures.

A tube of glass was used in these experiments which admitted the insertion down it of a thermoelectric junction, thus obtaining a ready means of measuring temperature. The whole was surrounded by a thick-walled iron tube which could be raised in temperature by a row of small gas-jets placed beneath. The bore of the iron tube was a little larger than the glass in order to allow the latter to turn freely.

In the case of a tube the formula for the viscosity becomes

$$\mu = \frac{2T}{\pi U(R_1^4 - R_2^4)},$$

where R_1 and R_2 are the external and internal radii respectively.

Fig. 6.

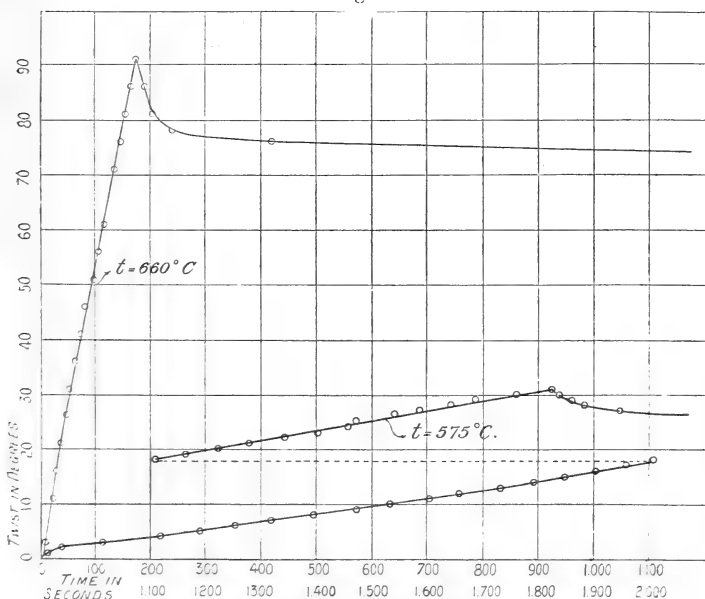

The Viscosity of Glass.

(Different values of the torque were used in the two cases.)

The results are given in a table at the end, and in fig. 6 are plotted the results for two experiments.

The authors entertained at one time the idea that the elastic viscous recovery might only be found to occur with substances which were mixtures; one constituent of which might be elastic and the other viscous. With the object of testing the matter some cylinders of sodium stearate were prepared. It was found that elastic viscous recovery occurred in this substance similar in every respect to that observed with such mixtures as glass or pitch. The viscosity of the substance is given in the general table.

Shoemaker's Wax.

It was desirable that determinations of the viscosity of the same substance should be made by the method here described and also some other. It was found that shoemaker's wax was, on the one hand, just sufficiently viscous to allow cylinders to be made from it for determination with the torsion method, and just sufficiently fluid to admit of its viscosity being determined by allowing a spherical body to drop through it.

The mean value obtained by the torsional method working with two different-sized cylinders was $\mu = 4.7 \times 10^6$. This value is open to considerable doubt, for cylinders of shoemaker's wax sag in the centre rather too quickly to give really reliable results, and would have to be supported by a fluid of the same density in the manner explained earlier in the paper.

The Stokes method adopted for comparison gave very variable results. A steel bicycle-ball answered as the spherical body, the measurements of which showed it to be wonderfully true; nevertheless it did not fall vertically, but irregularly from side to side in its descent. This may have been due to the ball rotating owing to lack of uniformity. The wax itself should have been fairly homogeneous, for it had been poured when liquid into the containing cardboard cylinder.

The position of the sphere was found from time to time by means of the X-rays. It took a fortnight to travel 1.8 cm. The value for the coefficient of viscosity obtained varied from 6×10^6 to 23×10^6 , the mean value being about 10×10^6 . This is of the same order of magnitude as that obtained by the torsion method. This latter is probably too small because the sagging of the rod in the torsion experiment was so great that the torque could not be applied long enough to reach the "steady" state.

Observations were made with paraffin-wax and modelling-clay to ascertain the character of their behaviour. Paraffin-

wax exhibited a behaviour in every way similar to the substances already mentioned, but the modelling-clay acted quite differently. When subjected to a given torque it moved slowly up to a given position and stopped there. On removing the stress, it made an immediate partial recovery to a point where it permanently remained.

The following list contains the results obtained with the several substances experimented with.

| Substance. | Temperature. | Coefficient of Viscosity. |
|-----------------------|--------------|---------------------------|
| | ° C. | |
| Pitch | 0 | 5.1×10^{11} |
| " | 8 | 9.9×10^{10} |
| " | 15 | 1.3×10^{10} |
| Glass (Soda) | 575 | 1.1×10^{13} |
| " | 660 | 2.3×10^{11} |
| " | 710 | 4.5×10^{10} |
| Sodium stearate | 8 | 5.0×10^{11} |
| Shoemaker's wax | 8 | 4.7×10^6 |

XLII. *On the Emanation given off by Radium.* By J. A. McCLELLAND, M.A., Professor of Experimental Physics, University College, Dublin*.

THE α rays of radium have been proved to consist of positively charged particles moving with great velocity, the mass of the particle being comparable with that of the hydrogen atom. The β rays have also been shown to consist of charged particles moving with great velocity, the charge in this case being negative, and the mass of the particles very small compared with that of even the hydrogen atom.

Little is known as yet about the γ rays, except that they have very great penetrating power.

The emanation produced by radium has been much studied, and many of its properties are known; but it does not appear to have been definitely settled whether or not the emanation particles are charged; and it is important to be certain on this point when framing a conception of the manner in which the radium atom disintegrates. The object in this paper is to test as accurately as possible whether or not the emanation carries an electric charge. Rutherford's work indicates that it is not charged; but I have thought it advisable to make a

* From an advance proof of the 'Transactions of the Royal Dublin Society,' n. s., vol. viii. part vi. pp. 89-94, communicated by the Author.

direct test of the matter, as Rutherford's work is not conclusive on this point.

Rutherford has had emanation for long periods in closed vessels, and under the action of an electric field, in which case we should expect the emanation, if charged, to be driven to one or other of the terminals; and as this does not happen, the indication is that it is not charged. But if the mass travelling with the electric charge were great in comparison with the charge, the motion under electric force would be very slow, and the emanation would not move to the terminals.

Description of Apparatus.

Five milligrammes of radium bromide were dissolved in water contained in a small vessel R covered with a slip of thin paper through which the emanation readily passes. The vessel R is placed under a large air-tight bell-jar A. A second large air-tight bell-jar B is joined up as shown in the figure. C is a vessel filled with glass-wool; and D is a metal

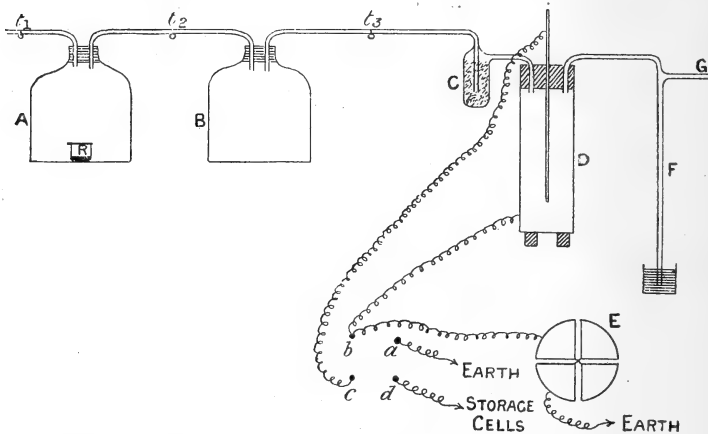

cylindrical vessel resting on blocks of paraffin, and fitted with a paraffin stopper, in which is fixed the metal rod T. The glass tube F dips into mercury, and acts as a gauge to show the pressure when D is partially exhausted, the exhaustion being produced by applying a pump at G. The letters t_1 , t_2 , and t_3 denote taps by which the tubes can be closed at the points indicated. E is a quadrant electrometer, one pair of quadrants being permanently to earth, and the other pair joined to a mercury cup b in a block of paraffin. The cup b is kept connected to an earthed cup a , except when an observation is to be taken, and then the connecting piece

is removed by a string from a distance, so as not to disturb the electrometer by induction effects. The mercury cups *b* and *c* in the same block of paraffin are joined to D and T; while a fourth cup *d* is joined to one pole of a battery of small storage-cells, the other pole of which is to earth. The vessel D is screened from outside electrical disturbances by a surrounding earthed conductor not shown in the diagram.

Method of Working.

The radium emanation passes readily through the slip of thin paper covering the vessel R; and thus, after A has remained closed for a short time, it contains a large quantity of emanation. The tap t_2 being closed, the vessels B, C, and D are partially exhausted to any desired pressure; t_3 is then closed, and t_1 and t_2 opened; and thus the vessel B is filled with air containing radium emanation, t_1 and t_2 being then closed again. The mercury cups *b* and *c* being joined together, the piece connecting *a* to *b* is removed, and the emanation allowed to rush into D by opening the tap t_3 . If this emanation carries a charge, it will be shown by a deflexion of the electrometer spot of light. The glass-wool in the vessel C stops dust particles which might get electrified by friction and produce a deflexion. The glass-wool also stops the ions which have been produced by the radiation from the radium emanation. As the ionized gas has been for some time in B and the tube leading to C, there would be a tendency for more negative than positive ions to be lost by diffusion to the walls; and the excess of positive would produce a deflexion when admitted into the vessel D.

To test whether or not the air thus admitted into D has carried emanation with it, and how much, the ionization current between T and D is measured immediately after the gas is admitted to D. To do this *c* is disconnected from *b* and joined to *d*. The terminal T is thus kept at a high potential, and the air in D being kept ionized by radiation from the emanation, the vessel D will gradually be charged; and the rate of charging is measured by the rate of movement of the spot of light when the connexion between *a* and *b* is broken.

Before the emanation is admitted there is only a very small current to D, when T is connected to the storage-battery, this small current being due to the weak ionization which is always present in atmospheric air.

We thus, by one experiment, measure the charge (if any) carried by the emanation, and by a second experiment we measure the ionizing power of this emanation.

The Observations.

We shall now give the numbers obtained in an experiment similar to a great number of others carried out.

The capacity of the electrometer and the necessary connexions, including the vessel D, was 131 electrostatic units, or $\cdot 000145$ microfarad, and the electrometer gave a deflexion of 60 scale-divisions for 1 volt difference of potential between its quadrants.

The admission of the radium emanation produced a deflexion of only 4 scale-divisions.

The ionization current to D was then measured as described above immediately after the admission of the emanation. To sufficiently reduce the rate of movement of the spot of light a capacity of $\cdot 1$ microfarad was joined to the electrometer, and the deflexion was then 100 scale-divisions in 47 seconds.

The admission of the air containing emanation into the vessel D produced, as stated, a small deflexion of 4 scale-divisions. Preliminary observations had been made to see if any deflexion would be produced when an equal quantity of air free from emanation was admitted in the same way. It was found that a small deflexion was produced probably by some friction effect, the deflexion varying in different experiments between 0 and 5 scale-divisions, and being always in the same direction. The direction of the deflexion of 4 divisions obtained when the air contained emanation was the same as that obtained without emanation.

Judging not only from this particular experiment, but from several others, we are safe in saying that the emanation did not carry a charge sufficient to produce a deflexion of more than 1 scale-division.

The experiment did not, therefore, detect any charge on the emanation; but it is important to calculate whether or not the emanation might be charged, and the charge be less than what could have been detected in the above experiment.

Let us suppose that each emanation particle has a charge equal to that carried by the gaseous ion; we have no case of a charge less than this, so that if the emanation is charged its charge is probably at least equal to that of the gaseous ion, and may be greater. Denote this charge by e in electromagnetic units.

The capacity of the electrometer and connexions was $\cdot 000145$ microfarad, and 1 scale-division corresponds to a potential-difference between the quadrants of $\frac{1}{60}$ of a volt. A deflexion of 1 scale-division would therefore be produced

by putting into the vessel D a charge of

$$\frac{10^8}{60} \times 0.000145 \times 10^{-15} = 24 \times 10^{-14} \text{ electromagnetic units.}$$

or by admitting into D

$$\frac{24 \times 10^{-14}}{e} \text{ emanation particles.}$$

Again, the radiation from the emanation admitted into D in the above experiment produced such an ionization that, when T was kept at a high potential, D got a charge corresponding to 100 scale-divisions in 47 seconds, with a capacity of .1 microfarad joined to the electrometer.

This charge is produced by ions giving up their charge to D, the charge of each ion being e .

The charge given to D per second is

$$\frac{100}{47} \times \frac{10^8}{60} \times \frac{10^{-15}}{10} = 35 \times 10^{-11} \text{ electromagnetic units.}$$

The number of ions of either sign produced in D by the radiation from the emanation is therefore

$$\frac{35 \times 10^{-11}}{e} \text{ per second.}$$

Each particle of emanation is therefore producing ions in the surrounding gas at the rate of

$$\frac{35 \times 10^{-11}}{24 \times 10^{-14}} = 1.4 \times 10^3 \text{ per second.}$$

We see, therefore, that as the emanation, when admitted into D, did not produce a deflexion of more than 1 scale-division, it must either be uncharged, or, if charged, each particle of the emanation must give out radiation sufficient to produce at least 1400 ions per second. If the radiation from each particle were less than this, then the number required to give the observed ionization would be greater than what would produce 1 scale-division of a deflexion. This number is calculated on the assumption that the charge on the emanation is the same as the charge on the gaseous ion; it is not probable that it is less than this, if charged at all; and if it is greater, the number 1400 would be correspondingly greater.

It is, however, quite likely that each emanation particle may be capable of producing ions in the vessel D at the rate of 1400 per second. For this reason the test was pushed a step further.

A more sensitive electrometer was used, and the quantity of emanation was also somewhat increased. An electrometer of the Dolezalek type was employed giving a deflexion equal to 4500 scale-divisions per volt difference of potential between its quadrants. With this sensitiveness the capacity of the electrometer and connexions was 900 electrostatic units, or $\cdot 001$ microfarad.

This electrometer was used to detect the charge on the emanation, and the ionization in the vessel D, after the emanation is admitted, was measured by the electrometer previously used. The small deflexion produced when air free from emanation was admitted into D was made as small as possible before the sensitive electrometer was used, and it was finally got rid of to such an extent that the deflexion was never greater than 10 divisions, varying in different experiments between 2 or 3 and 10 divisions, and being always in the same direction.

We shall give numbers observed in one experiment, using the sensitive apparatus.

The deflexion on the Dolezalek was 10 divisions when the emanation was admitted. The other electrometer was then used to measure the ionization, and gave 100 divisions in 77 seconds, with a capacity of $\cdot 5$ microfarad joined to it, the sensitiveness being the same as before, 60 divisions for 1 volt difference between its quadrants.

From this experiment and several similar ones we are safe in saying that in this case not more than 4 divisions of a deflexion are produced by the emanation. It is difficult to be certain of a smaller deflexion, the spot of light not being so steady as with a less sensitive instrument.

If we make a calculation of the same nature as before, we find that either the emanation is uncharged or else each emanation particle must be producing by its radiation at least 12,000 ions per second.

Even this radiation might be looked upon as quite possible, so that the question whether the emanation is charged or not would not be settled. We have, however, good reasons for believing that only a small fraction of the total emanation particles are at any instant acting as centres of radiation and ionization. The ionizing power of emanation contained in a closed vessel falls off with time in a geometrical progression, showing that the rate of decay of the ionizing power is proportional to the ionizing power at every instant, a result which readily admits of the interpretation that the radiation arises from the emanation particles undergoing some change,

and that the number changing at any instant is proportional to the total number present.

The ionizing power I may, from experiment (Rutherford, Phil. Mag. April 1903), be represented by

$$I = I_0 E^{-\lambda t},$$

where λ is a constant and t the time measured from the instant when $I = I_0$.

Since

$$-\frac{dI}{dt} = \lambda I,$$

we see that λ is the fraction of the total emanation that undergoes change or emits radiation in one second. And we know (Rutherford, Phil. Mag. April 1903) that I falls to half its value in about four days, so that λ is approximately equal to

$$2 \times 10^{-6}.$$

If, therefore, we accept the theory that the emanation undergoes a further change and that each particle acts as a centre of radiation and ionization only when undergoing change,—and this is the only theory that seems to fit in with experiment,—we see that the number calculated above, giving the minimum ionization that must be produced by each emanation particle in one second, assuming it to be charged, would have to be multiplied by the factor $\frac{1}{2} \cdot 10^6$.

Multiplying 12000 by $\frac{1}{2} \cdot 10^6$, we get 6×10^9 as the minimum number of ions produced in one second by each emanation particle when its turn comes to disintegrate, assuming that it is charged. This number is not a possible one for several reasons. Rutherford (Phil. Mag. May 1903) gives 10^5 as the probable number of ions produced by each α ray before it is absorbed by the gas. The ionization is chiefly due to α rays, so that to produce the above ionization each emanation particle would require to emit

$$\frac{6 \times 10^9}{10^5}, \quad \text{or } 6 \times 10^4 \alpha \text{ rays.}$$

The mass of the α particle being of the same order as that of the hydrogen atom, and the emanation having been produced by a disintegration of the radium atom, each emanation particle could not possibly emit more than about 200 α rays.

We can, therefore, finally conclude that the emanation not charged.

This fact—that the emanation is uncharged—has an important bearing on our conception of the manner in which

the radium atom breaks up. The radium atom certainly gives off positively charged particles—the α rays. The emanation particles cannot be what remains of the atom after the emission of one or more α rays, because, in that case, it would be negatively charged. The atom must have parted with an equal negative charge, either by the emission of negative particles or in some other way.

XLIII. *The Comparison of Capacities in Electrical Work; an Application of Radioactive Substances.* By J. A. McCLELLAND, M.A., Professor of Experimental Physics, University College, Dublin*.

THERE are many methods by which two capacities may be compared, and which are fully described in text-books of Physics.

When only approximate results are required, we have several methods to choose from, any of which will give a fair result; but the problem is by no means so simple when an accurate determination is required, especially if we are dealing with a very small capacity. That better methods of dealing with the determination of capacities, especially small capacities, are still required, may be judged from the fact that two papers have recently appeared on the subject, one by Professor Fleming and Mr. Clinton in the *Phil. Mag.*, May 1903, and the other by Professor Stroud and Mr. Oates in the *Phil. Mag.*, December 1903.

Those two papers may be taken as affording examples of the difficulty of obtaining accurate results in this work, both methods necessitating somewhat elaborate apparatus, and involving considerable experimental difficulties.

My object in this paper is to describe a method at once simple and accurate, and suitable for the determination of capacities of any magnitude down to a few micro-microfarads, or even less. The method is based on the fact that the ionization current that can be obtained by the use of a radioactive substance like uranium is *extremely constant*, and can be made so small that the time taken to charge a condenser by it can be accurately measured. This small constant current is used first to charge one condenser to a given potential; and then a second condenser is charged to the same potential, and the time taken in the two cases observed, so that we get

* From an advance proof of the Proceedings of the Royal Dublin Society, vol. x. part ii. p. 167, communicated by the Author.

the ratio of two capacities by simply observing two intervals of time.

The method will probably have occurred to any one who has been using radioactive substances ; but as many workers have occasion to compare capacities accurately who are not using radioactive substances, I have thought it advisable to make a few experiments showing the accuracy of the method, and showing also how small a capacity can be detected and measured by it.

To use the method it is not necessary to have a supply of radium, as the title of the paper might suggest ; uranium is even better in some respects, and uranium is to be found in every laboratory.

Description of Apparatus and Method of Working.

A and B are two insulated metal plates, one of which, B, can be joined to one terminal of a battery of small storage-cells, the other terminal of which is to earth. The battery may consist of 100 or more small test-tube cells, so that B can be kept at 200 volts or higher.

Fig. 1.

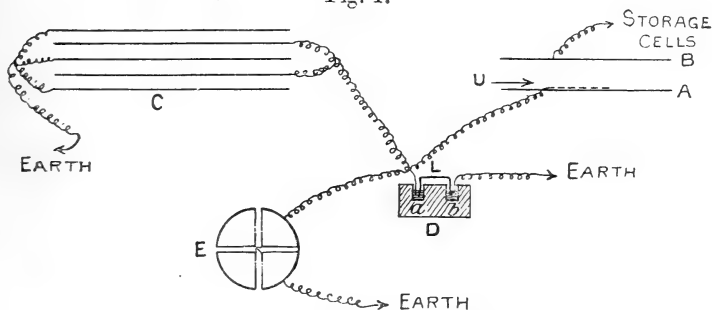

A few grammes of, say, uranium nitrate are spread on a sheet of paper, and placed on the plate A. The radiation from the uranium ionizes the air between A and B ; and so A gradually rises in potential if insulated, supposing B to be positive. As is well known, the ionization current thus obtained between two plates increases at first as the potential-difference between the plates increases ; but when this potential-difference is made sufficiently great, the current attains a maximum, and does not further increase for further increase of potential-difference between the plates. If then B is kept at a sufficiently high potential, small changes in this potential, due to the potential of the battery falling, will produce no effect ; and, again, in making an observation, the potential of

A need never change by more than one volt, so that there is no trouble in keeping a constant current to the plate A. The constancy of the current in the above arrangement only depends on the constancy of the radiation from the uranium; and numbers will be given to show how very constant this radiation is. The potential-difference required to produce the maximum current to A will depend on the distance between A and B; but it is well to have 200 volts available.

C represents one of the condensers being compared; and E is a quadrant-electrometer. D is an insulating block of paraffin, containing two mercury cups, *a* and *b*, one of which is connected to earth. A connecting piece L is shown, joining the mercury cups, and by means of a string arrangement L can be lifted out of the mercury cups and lowered again as desired, from a distance, so as to avoid induction effects produced by movements of the observer.

As soon as L is lifted out of the mercury cups, the plate A, the condenser C, and the electrometer begin to charge up; and the time is observed during which the spot of light moves over, say, 100 scale-divisions. An exactly similar experiment is done with a second condenser C' in the place of C. If the intervals of time are respectively *t* and *t'*, we have

$$\frac{C+c}{C'+c} = \frac{t}{t'}$$

where *c* is the capacity of the electrometer, the condenser AB, and the connecting wires. The capacity *c* can be determined in the terms of, say, C, by taking an observation with C joined up as shown, and then an observation with C disconnected, so that only *c* is charged; or the capacity *c* may be determined once for all by comparing it in this way with a known capacity. We thus get the ratio C/C'.

Accuracy of the Method.

The accuracy of the method obviously depends simply on the constancy of the ionization current, and on the accuracy with which the time-intervals are measured. Numbers are given below to show how very constant the ionization current is. In practice it is well to screen the space between the plates A and B from air-currents, as such currents, if strong, may blow away the ionized air, and diminish the ionization-current. As regards the radioactive substances used, uranium is preferable to thorium or radium, as it gives off no emanation. If radium or thorium is used, it should be in a closed vessel to prevent the emanation from escaping, otherwise the ionization-current will not be steady.

The method involves the use of a quadrant-electrometer, which to some may appear an objection to the method. The writer's experience, however, is that no sensitive scientific instrument gives less trouble in working than a quadrant-electrometer, when it has once been put in good order. When the capacities being compared are small, no great sensitiveness of the electrometer will be required—say 60 millimetre scale-divisions for one volt with scale one metre from electrometer. When large capacities are being compared greater sensitiveness will be necessary, unless a very large quantity of uranium is used; but there is no trouble in having an instrument one hundred times as sensitive as above.

Some Experiments with this Method.

(a) We shall first give some numbers to show the constancy of the ionization-current in the above arrangement, and the accuracy with which the time required to charge any system through a given range of potential can be measured. The system charged consisted of the electrometer, a capacity marked .001 microfarad, and the condenser formed of the plates between which the uranium is placed.

The time taken for the spot of light to move over fifty scale-divisions was taken with a stop-watch reading to fifths of a second. A series of seven observations was made, giving the following numbers, no observation being rejected.

Time taken to move over 50 scale-divisions :—

| | |
|------|----------|
| 99.2 | seconds. |
| 99.5 | „ |
| 99.0 | „ |
| 99.4 | „ |
| 99.2 | „ |
| 99.2 | „ |
| 99.1 | „ |

Mean... 99.23 seconds.

The agreement between these numbers is no better than that usually observed in other experiments; in fact, not as good as in many other cases.

(b) We shall now give the numbers observed in a comparison of a condenser with a standard condenser, marked .001 microfarad. We shall denote the capacity of the condenser to be measured by C , and the capacity of the electrometer and other parts of the system by c .

The electrometer in this experiment gave a deflexion of
Phil. Mag. S. 6. Vol. 7. No. 40. April 1904. 2 C

about 60 scale-divisions for 1 volt, and about 30 grams of uranium nitrate were placed on the central part of the plate A; observations were taken alternately with the capacity C joined up to c , and with the capacity $\cdot 001$ microfarad joined up to c , giving results as follows:—

| $\cdot 001 + c$. | $C + c$. |
|----------------------------------|----------------------------------|
| 50 divisions in 52·6 seconds | 50 divisions in 89·5 seconds |
| 50 divisions in 52·5 " " | 50 divisions in 88·7 " " |
| 50 divisions in 52·2 " " | |
| Mean... 52·43 " " | Mean... 89·1 " " |

Therefore
$$\frac{C + c}{\cdot 001 + c} = \frac{8910}{5243}.$$

A smaller quantity of uranium was then used to determine the ratio between c and $\cdot 001$ microfarad, as with the quantity used above the movement of the spot of light would have been too rapid when only the capacity c was in use. The following are the numbers in this determination:—

| $c + \cdot 001$. | c . |
|----------------------------------|-----------------------------------|
| 50 divisions in 75·8 seconds | 100 divisions in 21·9 seconds |
| 50 divisions in 75·7 " " | 100 divisions in 21·8 " " |
| | 100 divisions in 22·2 " " |
| Mean... 75·75 " " | Mean... 21·97 " " |

Therefore
$$\frac{c + \cdot 001}{c} = \frac{15150}{2197}.$$

These equations give

$$c = \cdot 000169 \text{ microfarad};$$

$$C = \cdot 001817 \text{ microfarad}.$$

To give somewhat of a test of the reliability of the method, the same capacity was determined on another occasion, taking no care to use the same quantity of uranium, and, in fact, having very different ionization-currents from those used in the first case. The following numbers were obtained, only one observation being taken in each case:—

| $C + c$. | $\cdot 001 + c$. |
|----------------------------------|-----------------------------------|
| 50 divisions in 48·2 seconds | 50 divisions in 28·6 seconds |
| | |
| $c + \cdot 001$. | c . |
| 50 divisions in 56·5 " " | 100 divisions in 16·5 " " |

Calculating as before, we get

$$c = \cdot 000170 \text{ microfarad,}$$

$$C = \cdot 001802 \text{ microfarad.}$$

The agreement with the preceding numbers is very good, especially when we consider that only one observation was taken in each case.

(c) To show that this method is suitable for much larger capacities than those used in the preceding examples, we shall give an example in which a capacity known to be about $\cdot 5$ microfarad was determined by comparing it with a standard capacity of $\cdot 1$ microfarad. For this purpose, an electrometer of the Dolezalek type was used, giving a deflexion equal to 5300 scale-divisions for 1 volt.

Observations were taken as before, first with the unknown capacity C joined up to the electrometer and the plate A , and then with the capacity $\cdot 1$ microfarad joined up.

About 100 grams of uranium nitrate were placed on A (fig. 1), and the following numbers noted; c denotes the capacity of the Dolezalek electrometer, and some apparatus that was in connexion with it:—

| $C+c.$ | $\cdot 1+c.$ |
|-------------------------------|-------------------------------|
| 50 divisions in 104.5 seconds | 100 divisions in 41.8 seconds |
| 50 divisions in 104.4 ,, | 100 divisions in 41.8 ,, |
| Mean... 104.45 ,, | Mean... 41.8 ,, |

Therefore
$$\frac{C+c}{\cdot 1+c} = \frac{208.9}{41.8}$$

Less than 1 gram of uranium nitrate was now used to determine the ratio of c to a known capacity of $\cdot 001$ microfarad, giving as follows:—

| $c.$ | $c+\cdot 001.$ |
|-------------------------------|-------------------------------|
| 100 divisions in 21.0 seconds | 100 divisions in 30.5 seconds |
| 100 divisions in 21.2 ,, | 100 divisions in 30.0 ,, |

Therefore
$$\frac{c+\cdot 001}{c} = \frac{605}{422}$$

These equations give—

$$c = \cdot 0023 \text{ microfarad,}$$

$$C = \cdot 5089 \text{ microfarad.}$$

A repetition of this determination gave as before, with smaller capacities, an equally consistent result.

(d) A careful experiment was now made to find how small a capacity could be detected and measured by this method.

To do this a condenser of the following type (fig. 2) was arranged.

Fig. 2.

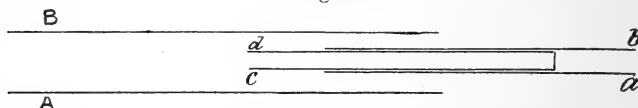

AB is a long wide tube, 7.90 cms. internal diameter; *ab* is another tube fixed, as shown, to be coaxial with AB. In *ab* a third cylinder *cd* slides, fitting closely into *ab*, the external diameter of *cd* being 1.94 cm. AB is joined to earth, and *ab* (and *cd*) connected to the Kelvin electrometer. The capacity of the electrometer, the condenser as arranged (fig. 2), and joining wires is determined by comparing it with a standard capacity of .001 microfarad.

A careful series of observations is then taken, with *cd* in its above position, using a suitable quantity of uranium nitrate. Then the tube *cd* is moved 8.01 cms. further into AB, care being taken not to displace AB or *ab*. A vernier was attached to *cd* working in a slot in *ab*, so that the distance through which *cd* was displaced could be accurately measured. A second series of observations was then made with *cd* in the new position, keeping the same uranium as before. We have thus the data for deducing from the experiments the increase of capacity produced by the movement of *cd*. This increase of capacity can also be accurately calculated from the formula

$$\frac{l}{2 \log \frac{r_1}{r_2}}$$

since the effects of the ends are eliminated by the arrangement used, *l* being the distance *cd* is moved, and *r*₁ and *r*₂ the radii of AB and *cd* respectively. We can thus estimate the value of the method for measuring very small capacities.

The numbers observed were as follows:—

(1) Finding the capacity C made up of the condenser described (fig. 2), the electrometer, and connexions.

| C. | .001+C. |
|-------------------------------|-------------------------------|
| 100 divisions in 39.7 seconds | 50 divisions in 117.8 seconds |
| 100 divisions in 39.6 ,, | 50 divisions in 118.1 ,, |
| 100 divisions in 39.5 ,, | 50 divisions in 117.8 ,, |
| Mean... 39.6 ,, | Mean... 117.9 ,, |

Therefore
$$\frac{C + \cdot 001}{C} = \frac{235 \cdot 8}{39 \cdot 6};$$

or $C = \cdot 000201$ microfarad;

or $C = 201$ micro-microfarads.

(2) To find the small change in the capacity α when cd has been moved into its second position.

In first position :—

100 divisions in 59·0 seconds,

100 divisions in 59·5 „

100 divisions in 59·1 „

Mean... 59·20 „

In second position :—

100 divisions in 60·5 seconds,

100 divisions in 59·8 „

100 divisions in 60·0 „

Mean... 60·10 „

Therefore
$$\frac{C + \alpha}{C} = \frac{60 \cdot 1}{59 \cdot 2},$$

and $C = 201$ micro-microfarads ;

$\therefore \alpha = 3 \cdot 05$ micro-microfarads.

Calculating α from the formula

$$\alpha = \frac{l}{2 \log \frac{r_1}{r_2}},$$

where $l = 8 \cdot 01$ cms.,

$r_1 = 3 \cdot 95$ cms.,

$r_2 = \cdot 97$ cm.,

we get $\alpha = 2 \cdot 85$ electrostatic units
 $= 3 \cdot 16$ micro-microfarads.

We get, therefore, 3·16 by calculation,
 and 3·05 by experiment.

The method is therefore quite capable of detecting and measuring with considerable accuracy a capacity of 1 micro-microfarad or even less.

Discussion of the Advantages of the Method.

It is not necessary to compare this method in detail with the many other methods used in comparing capacities ; it will be sufficient to point out a few leading facts.

Capacities may, of course, be compared by the electrometer without any use of radioactive substances by charging the unknown capacity to a potential which is measured by the electrometer, and then sharing the charge with a known capacity, and again measuring the potential. The method of working is not, however, as accurate as that described above, especially when the capacities are small.

Capacities are often compared by charging them to the same potential, and discharging them through a ballistic galvanometer. The galvanometer-deflexion must be accurately read, and a correction applied for damping, observations which cannot be made with the accuracy with which we can compare two intervals of time. Again, when the capacities are small, they must be charged or discharged through the galvanometer a great number of times per second, which requires carefully constructed apparatus to enable the number of charges to be accurately known. In addition it is somewhat difficult to be certain that the apparatus is working properly; for example, an error might arise through faulty insulation, and escape detection.

The method of De Sauty is free from many of the objections mentioned above ; but others might be urged against it, and especially that it can be of little use when the capacities are very small.

One of the chief advantages of the method described in this paper is that, from the nature of the apparatus used, it is scarcely possible for any serious source of error to come in without detection ; a faulty insulation, for example, can easily be guarded against. The only quantity requiring to be measured is an interval of time, which can be done with great accuracy. The ionization produced by the uranium keeps very constant throughout the time required to make a determination, and there is no other quantity that requires to be kept very constant. The potential of the battery joined to one of the plates between which the uranium is placed may vary considerably between the observations and produce no effect, provided the potential is sufficiently great.

The only objection that seems likely to be made to the method is the fact that it employs a quadrant-electrometer, the use of which in ordinary laboratory work has hitherto been discouraged. As stated above, the writer sees no reason for the reluctance to use electrometers when their use can be

avoided by means of galvanometers and other, sometimes complicated, apparatus. Some of the lines of research in recent years have necessitated an extensive use of quadrant electrometers, with the natural result that they have been greatly improved; and whatever reasons there may formerly have been for avoiding the use of electrometers, these reasons have now entirely disappeared.

XLIV. On a New Form of Sensitive Hot-Wire Voltmeter.

By R. THRELFALL, *F.R.S.**

THE practical need for a sensitive alternate-current voltmeter arises in connexion with the measurement of large alternating currents. The instruments at present employed for the purpose of measuring alternating currents are substantially of two types,—the ampere gauge of Lord Kelvin forming the standard and almost only representative of one class; and instruments based on transformers forming the other. Both classes of instruments require calibration in manufacture, and from time to time, and it is then that the want of a sensitive voltmeter is felt; for the obviously most direct method is to measure the potential drop across a standard resistance traversed by the whole current in question. It may seem curious that the larger the current to be measured, the more sensitive must be the voltmeter employed; but a little consideration will show that this is the case because it is not practicable to go on increasing the weight of a standard resistance without limit. In the other alternative the heating becomes excessive, and there is a risk of damaging the standard. For instance, suppose that it is a question of measuring 2000 amperes by means of a resistance of $\cdot 0002$ ohm, the P.D. drop is $\cdot 4$ volt, and the power expended in heat is $\cdot 8$ kilowatt—quite a consideration. The practical standard alternating-current voltmeter must therefore be sensitive and adjusted to work across an external resistance which may be considered negligible in comparison with its own resistance. If the hot-wire form be adopted, it is seen that the electrical considerations point to the wire being as short as possible, and also as fine as possible; for it has often been shown that the rise of temperature for a given current-density increases as the diameter of the wire decreases.

Taking everything into account, the most suitable material appears to be pure silver. As this can be obtained commercially nicely gilded and of such a thickness that two miles

* Communicated by the Physical Society; read November 27, 1903.

go to the troy ounce, it was not worth while trying to improve upon it in the laboratory, though no doubt finer stuff could be produced by special artifice. For instance, by making a silver wire or strip the anode in a dilute solution of potassium iodide, it can be very materially reduced in thickness, but the mechanical properties are impaired to some extent in spite of the equalizing action of the coating of silver iodide which is formed.

In order to make use of the gilt silver wire as a hot-wire voltmeter, it is necessary to be certain that the wire is always stretched by the same force, and then the small changes in length consequent on the passing of a current can be measured.

The chief peculiarity of the instrument in question is in regard to the means adopted for securing uniformity of tension of the fine wire.

Referring to fig. 1. The fine wire is seen stretched between two supports, and pulled downwards at the centre by a microscopic hook and spiral spring insulated from the base; a small

Fig. 1.

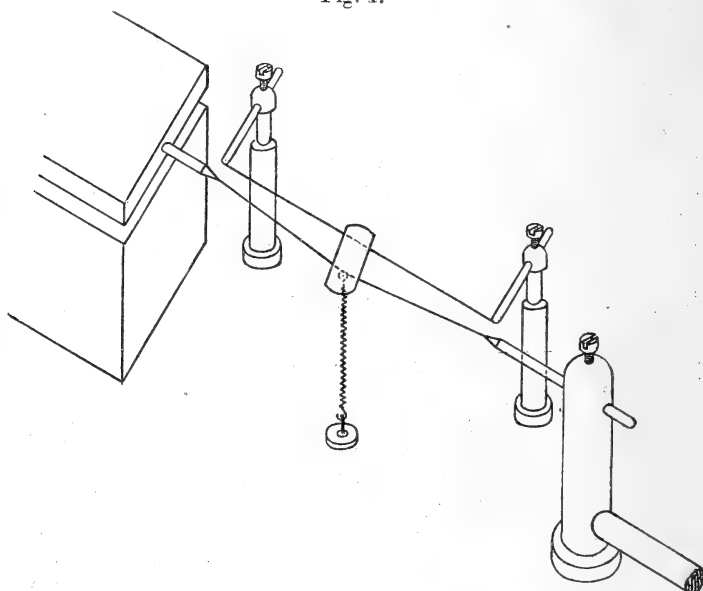

mirror hinged on a wire stretched alongside rests on the head of the hook. The deflexion of the wire is exaggerated in the diagram, in reality the interior angle is about 175° , or from that to 178° .

In order to get an idea of the relation of the sag of the wire to its increment of length, suppose that it is stretched quite straight to begin with; that its length is $2l$, and that we require to find x the contraction of the spiral spring for a given increment of length a in the wire. This is seen to be given by $x^2=la$, when a is small.

To form an idea of the multiplication obtainable in practice, suppose that the distance between supports = 5 cms., and that the wire is heated through 1° C., the initial interior angle being 175° , and the coefficient of expansion of the wire per degree .00002. Calculation shows that in this case the magnification is about 22; and of course it increases rapidly the more nearly the initial angle approaches 180° . The condition as to the length of wire which it is best to employ, is easily obtained from the following considerations.

The resistance of the instrument-circuit is practically the same as the resistance of the fine wire. The diameter of this being fixed at the minimum available, the resistance is simply proportional to the length. The rate of heat evolution is therefore inversely as the length at constant P.D. If the length of wire be increased n -fold, the rate at which heat is supplied is $\frac{1}{n}$ of its former value, and the cooling surface is increased n -fold; therefore, for small rises of temperature the rise of temperature of the wire is $\frac{1}{n^2}$ of its former value.

The total increase of length of the wire which is the subject of measurement is proportional both to the length of the wire and to the temperature difference; so that it finally becomes $\frac{1}{n}$ of the original value.

The sensitiveness of the instrument, in so far as the limit is set by the difficulty of measuring small changes of length, is therefore inversely as the length of the wire. If the sensitiveness be regarded as limited by the least amount of sag that can be perceived due to heating, we have to consider what further condition is imposed. The practical condition is that enough sag must be allowed initially to prevent the wire getting broken if the current is accidentally taken off while the measuring apparatus is in the position necessary to make the sag constant in spite of the heating. In this case the magnification is constant, and x depends only on the length—giving the same condition for sensitiveness as obtains when we consider the measuring apparatus as imposing the limit.

The above principles are put into practice in the following manner. The active wire is carried between two adjustable supports, one of which must be insulated from the rest of the apparatus. The other support can be moved to and fro in the direction of the wire by means of a micrometer-screw, and the motion may be further reduced by means of a lever, if so desired. The mirror may be a centimetre long and 4 mms. wide, and the hinge-wire may be about 2 mms. from the vertical plane of the active wire. The mirror is backed by a scrap of mica, and is supported by the head of the hook which pulls the active wire down. As the active wire heats up, the hook descends and the mirror is tilted downwards. There is a small incandescent lamp in the lid of the box enclosing the instrument, and a ground-glass or celluloid scale opposite a slot in the front of the case. By means of a prism and lens an image of the filament is thrown on the screen by the mirror, and by turning the micrometer-screw this image can be brought to any desired point. The mirror is not affected as to position by swinging the box from the end of a rope; but it is sensitive to vibrations of short period, and it is best to observe when the instrument is suspended rather than when it is resting on a table—especially in an engine-house. Small voltages can be read off at once on the scale, but larger ones are compensated by working the screw. The whole apparatus is enclosed in an aluminium box measuring 1 foot \times 1 foot \times 8 inches high; and these dimensions can be reduced if desirable.

The following data refer to an instrument designed to work with potential-differences up to about 0.5 volt:—

| | |
|---------------------------------|----------|
| Distance between supports | 6.5 cms. |
| Initial sag of wire..... | .127 „ |
| Interior angle | 175° 30' |

Resistance cold with leads about 1.2 ohms.

Effective distance, mirror to screen in cover of instrument, 28 cms.

With this instrument .03 volt gave a deflexion which could just be easily seen without the assistance of a lens, and required $\frac{1}{25}$ turn of the micrometer-head to compensate it.

As it was intended to employ the instrument in measuring large alternating currents, it was thought well to calibrate it by sending a unidirectional current through the standard manganin resistance of .0002 ohm which it was proposed to employ; and at the same time measuring the P.D. across this by a potentiometer and cadmium-cell.

Four settings of the micrometer-head were made for each

observation, and the mean taken. It was found that the zero reading varied by two or three twenty-fifths of a turn as the temperature changed; also it required about half a minute for the wire to reach its steady state after the voltage was applied. In all cases the micrometer-screw was brought to near its zero reading before the current was interrupted, though a special experiment had shown that no damage appeared to result from the neglect of this precaution.

Curve of Calibration of Hot-Wire Instrument.

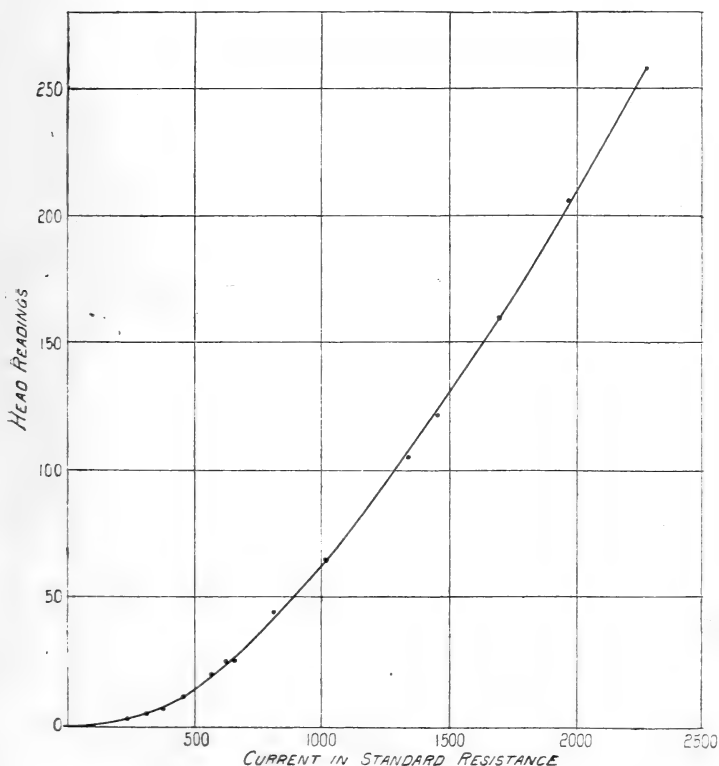

The micrometer-head was divided into 25 large divisions, and each large division was subdivided into ten small divisions. The unit in the column "Head Readings" is one large division of the head.

The source of light was a 4-volt $\frac{1}{2}$ C.P. lamp in the top of the case fed by two pocket storage-cells.

Table of Calibration of Instrument.

| Head Readings. | Volts on Instrument. | Current in Standard Resistance. |
|----------------|----------------------|---------------------------------|
| | | Amperes. |
| 2.57 | .04767 | 238 |
| 4.38 | .0628 | 314 |
| 6.48 | .07710 | 384 |
| 11.5 | .09326 | 466 |
| 20.2 | .1143 | 571 |
| 25.3 | .1264 | 632 |
| 25.9 | .1320 | 660 |
| 45.0 | .1630 | 815 |
| 65.82 | .2030 | 1015 |
| 106.1 | .2662 | 1331 |
| 122.7 | .2890 | 1445 |
| 160.2 | .3384 | 1692 |
| 206.3 | .3936 | 1968 |
| 258.1 | .4545 | 2272 |

XLV. *Some New Cases of Interference and Diffraction.* By
 R. W. WOOD, *Professor of Experimental Physics, Johns
 Hopkins University**.

[Plate XXI.]

IN the following paper I propose to discuss certain types of the interference of light which have been known for many years, as well as some cases which, so far as I know, are quite new; the colours of mixed plates and the phenomena of interference in transparent films deposited on metallic reflectors being the cases chiefly considered. Several years ago it occurred to me that it would be worth while to try to devise some permanent film which would show Newton's colours under the most favourable conditions, and the cases cited in the present paper are, for the most part, the outgrowth of experiments made in this direction. The facts which have been brought out may be summed up as follows.

The colours of mixed plates are due to diffraction, and should not be classed with interferences in thin films. The explanation originally given by Young, and the treatments given by Verdet and others, are unsatisfactory, in that they do not indicate what becomes of the energy.

In the cases of films deposited on perfectly reflecting surfaces which, according to the elementary theory, should exhibit no interference-colours, we may, under certain conditions, have colours far more brilliant and quite as saturated as any shown by the soap-bubble. In other cases, where at first

* Communicated by the Physical Society: read January 22, 1904.

sight no interference appears to have taken place, we may, by employing polarized monochromatic light, obtain fringes of a very curious nature, which are the result of the interference between the elliptical vibration coming from the metal surface and the plane-polarized vibration reflected from the surface of the transparent film. We will go back now to the earlier experiments.

Preparation of Films for the exhibition of Newton's Colours.

In the case of a thin transparent lamina, such as a soap-film, the amplitudes of the disturbances reflected from the two surfaces are equal, and consequently completely destroy each other when the phase-difference is 180° . Inasmuch, however, as only a small percentage of light is reflected from each surface, the colours, though saturated, are not as intense as is desirable. In the course of some experiments with selenium I found, if a plate of mica is pressed against a pool of the molten substance on a glass plate, and the whole allowed to cool under pressure, that on stripping off the mica, films of mica of variable thickness were left upon the surface of the selenium, which showed Newton's colours of great beauty, arranged in mosaics. The patches of equal thickness being sharply bounded by straight lines, present an appearance similar to that of selenite-films under the polariscope. The selenium has a much higher refractive index than the mica, consequently the reflexion at each surface is the reflexion of rays incident from a rare to a denser medium, and the difference of phase is given by the difference of path alone; *i. e.*, we do not have the loss of half a wave-length due to reflexion under opposite conditions, as would be the case if the mica films were in air.

If the mica is cemented to the plate with sealing-wax or any of the common resinous cements, very little trace of the colours is to be seen, owing to the fact that the refractive indices of the two media being so nearly the same, practically no energy is reflected from the boundary. The use of selenium can be avoided by very lightly silvering the surface of the mica, which may then be cemented to the glass with any good laboratory cement, the metallic layer taking the place of the medium of high refractive index. This latter method is the best for the preparation of large mosaics suitable for lantern-projection. In the patches which show no colour by reflected light, the interference may be detected with a small spectroscope, the spectrum appearing crossed by black bands, corresponding in position to the wave-lengths absent in the reflected light. Still more brilliant films can

be prepared by first thickly silvering the mica, cementing the silvered side to the glass plate, and then stripping the mica off. The colours are scarcely visible, owing to the disproportionality between the amplitudes of the two interfering streams of light, but appear as soon as the upper surface of the mica is half-silvered, which can be done by immersing the plate in a silvering solution until the colours reach their maximum brilliancy. To obtain films which show the maximum brilliancy, it is clear that the amplitude of the stream reflected from the first surface must have the largest possible value consistent with the fulfilling of the condition that it be completely destroyed by the disturbance coming from the second surface when the phase-difference is 180° .

In the case of transparent films, the wave-lengths absent in the reflected light appear in excess in the transmitted light, there being no destruction of energy. If the second surface is a perfect reflector, the energy thrown down upon it by interference at the first surface will all be returned. If we consider the upper metallic surface as nonabsorbing, and work out the case by the method of multiple reflexions, we find that no colour will be produced, light of all wave-lengths being reflected with equal facility. The fact that brilliant colours appear, means that light is absorbed at one or both of the silvered surfaces, since this is the only way in which the energy of the absent wave-lengths can disappear. If we assume a certain percentage reflected and a certain percentage absorbed by the thin silver film, we find that the waves for which the phase-difference is 180° are compelled to make more transits through the film than those for which the phase-difference is 360° . It is possible to obtain experimentally a condition in which the former are almost completely absent in the reflected light, while the latter are reflected with scarcely any loss of intensity. To calculate the most favourable conditions, we should require data regarding the percentages reflected and transmitted by films of various thicknesses.

It next occurred to me to substitute a thin film of collodion for the mica, half-silvering the film as before.

A sheet of glass can be silvered chemically, or procured by removing the varnish from the back of a piece of modern mirror-glass with alcohol. The silver film is then flowed with collodion diluted with three or four parts of ether. As soon as the film dries colours appear, contrary to theory. These colours may be quite brilliant, and are due to diffraction, as I shall show presently. If the plate be now immersed in Brashear's silvering-bath, the colours will instantly disappear,

owing to the fact that the collodion-film and the solution have nearly the same refractive index. As soon as the silver begins to deposit, the colours reappear and increase rapidly in intensity. The bath should be rocked, the process being similar to the development of a negative. A little experience will enable the moment of maximum brilliancy to be correctly judged, when the plate should be immediately removed from the solution, washed, and dried. It is well to provide the plate with a cover of glass mounted over it at an angle of 20° , the whole forming a prismatic box. The object of inclining the cover is to get rid of the light reflected from it, which would otherwise dilute the interference colours. Plates prepared in this way show a wonderful blaze of colour and make excellent preparations for the lantern.

The Colours of Mixed Plates.

Interference colours of this type were discovered by Young, and described in the 'Philosophical Transactions' for 1802. They were subsequently studied by Sir David Brewster. Verdet and other writers on Optics have classified them with Newton's thin-film colours, and have given treatments which are not very rigorous and fail to show where the energy goes to.

The colours are very easily obtained by pressing a little white of egg between two pieces of plate-glass, separating the plates and squeezing them together a number of times so as to form a froth. The plates are to be pressed firmly together with a rotary sliding motion just before the froth becomes sticky, enclosing a film made up of air and albumen in the form of a mosaic. The colours are best seen by holding the plate towards a window or other bright source of light on a dark field. Certain wave-lengths will be found to be absent in the directly transmitted light. Young's explanation was that the path-difference between a ray passing through an air-space and one passing through the albumen was an odd number of half wave-lengths for such colours as failed to appear in the transmitted light. Neither Young nor subsequent writers, so far as I have been able to find, show what becomes of these absent colours, though both Young and Brewster observed the coloured fringes which appeared in the dark background to one side of the source of light. Brewster published a paper in the 'Philosophical Transactions' for 1837 in which he referred the colours to diffraction, though his treatment was not very complete, and concerned chiefly the case of diffraction by a transparent lamina bounded by a straight edge. Verdet objected to this

explanation on the ground that the colours are independent of the size and arrangement of the air-bubbles, depending only on the thickness of the albumen-film and the angle of incidence. The interference phenomena of mixed plates are easily explained by the elementary theory of diffraction, and they should be classed with laminary diffraction effects, and not with thin film interferences, as is usually the case.

The following treatment may not be new, but I do not remember to have seen it anywhere:—In fig. 1 (Pl. XXI.) let AA represent the glass plates with the albumen and air elements between them. We will assume the thickness of the albumen

such that green light suffers a retardation of $\frac{\lambda}{2}$ in traversing it.

If B is the lens of the eye, and parallel rays traverse the plate, the secondary disturbances represented by the dotted lines (normally diffracted rays) will be brought to a focus at E; that is, the reduced paths of all these rays are equal and the disturbances arrive at E in the same phase, if there be no retardation. The disturbances coming from the albumen elements are retarded, however, and reach E half a wave-length behind the disturbances coming from the air elements. The two sets destroy each other at this point, and green light will not be represented here. In general, light will be absent at this point if the retardation of a ray passing through albumen with respect to one passing through the adjacent air-space is $(2n+1)\frac{\lambda}{2}$. If the film is fairly

thick, this condition may hold for a number of colours in the spectrum, which will consequently be absent in the image of any source of light seen through the plate. The question now is: What becomes of this energy? In the case of thin film interferences, the wave-lengths absent in the transmitted light appear in the reflected. This is not the case with mixed plates, which show no colour by reflexion. If we refer to fig. 1, it is clear that if we take parallel rays diffracted in an oblique direction, the phase-difference introduced by the retardations in the mosaic may be compensated by the obliquity, the agreement of phase being more or less complete for green light in the point F. The case is analogous to a laminary grating, which yields coloured central images, the absent wave-lengths appearing in the spectra. Mixed plates throw the light absent in the direct image into a halo or ring, which is seen to surround the source of light. Laminary diffraction phenomena produced by straight edges, two parallel slits, and gratings are very fully treated in Verdet's 'Optics.'

Mixed plates belong to the same class, the case being best defined as laminary diffraction by a great number of irregularly distributed transparent disks. If the patches of the mosaic were of uniform size, the halo would be fairly sharply defined and separated from the direct image by a dark space, which would become wider as the size of the elements of the mosaic decreased. Though I have succeeded in obtaining very perfect halos in some cases, separated by a dark area of considerable size, the variation in the size of the elements usually causes the halo to take the form of a disk, the centre of which is occupied by the direct image.

If the plates are held close to the eye and a distant lamp-flame viewed through them, the flame will, for example, appear purple and the surrounding halo green. If a small sodium flame is employed, parts of the mosaic will show it much blurred, and surrounded by a halo, while other parts, where the retardation is a whole number of half-waves, show it perfectly sharp and distinct. The distribution of the light in the halo depends on the form of the elements of the mosaic. By pressing the plates firmly together and sliding one over the other, the circular air-bubbles can be deformed into ellipses. The light in the ring will be more or less concentrated on opposite sides of the halo. If the ellipses were drawn out indefinitely, we should pass over to the grating, and the points of concentration would become first-order spectra, the rest of the halo disappearing.

I observed a very curious and interesting example of this concentration of light in a halo a number of years ago, while copying some diffraction-gratings on bichromatized albumen. The original grating was ruled on glass, 14,400 lines to the inch, a spacing so fine that copies were only obtained with considerable difficulty.

Some of the films were found to have frilled in the process of washing, the buckling of the film following the grooves of the grating to a certain extent. The albumen surface was seen by the microscope to have frilled into oval patches of varying length, but of fairly constant width, the width being equal to three lines of the original grating. In fig. 2 we have a diagram illustrating this condition. This plate when held before the eye showed a ring of wide aperture surrounding a brilliant source of light, with four distinct concentrations, two very bright and two quite faint. The appearance reminded one most forcibly of a solar halo with parhelia or mock suns. A photograph of this curious diffraction pattern was made by directing a camera towards a brilliant point

source of light, and placing one of the frilled plates before the lens. This photograph is reproduced in fig. 3 (Pl. XXI.).

The arrangement of the colours in the "mock-suns" produced in this way is, however, exactly the opposite of the arrangement in the real ones, which makes it appear doubtful if there is any connexion between the two. It is possible, however, that the usual treatment of parhelia could be improved by considering diffraction as well as refraction, as has been done in the case of the rainbow.

On the Polarized Fringes produced by the interference of two streams of light polarized at right angles.

In the case of ordinary thin-film interferences the planes of vibration of the disturbances reflected from the two surfaces of the film are parallel.

It is possible, however, to prepare a film which shall fulfil the requirement that the vibrations reflected from its upper surface make any desired angle with those coming from the lower surface. The path-difference between the two streams will vary with the thickness of the film; and if the amplitudes be equal we shall have the vibrations compounding into circular elliptic or plane ones, according to their phase-difference.

A thin glass or gelatine film, backed by a metallic reflecting surface, is all that is necessary. The incident sodium light should be polarized at an angle of 45° with the plane of incidence by passage through a nicol, and the reflected light examined with an analysing nicol. The fringes obtained in this way present a most curious appearance, reminding one forcibly of a spectrum line with a fainter component seen in the Fabry and Perot interferometer. Their general appearance is shown in fig. 4, which represents the fringes obtained by flowing a plate of speculum metal with a rather dilute solution of gelatine, and allowing it to dry in a slightly inclined position.

The easiest way to get them, however, is to blow out the end of a rather large glass tube into a large thin balloon of tissue glass, picking out a portion, by the light of a sodium flame, which shows fairly straight interference-fringes two or three millimetres apart. A small piece of the thin glass is laid, with its slightly convex side down, upon a clean mercury surface, and sodium light, polarized in azimuth 45° , reflected from the surface at an angle of about 60° . On

viewing the reflected light through a nicol, the curious double fringes can be found easily by slowly turning the nicol. The light will be found to be plane-polarized along the lines 1, 3, 5, 7, &c. of fig. 4, though in general the planes of polarization along one set of lines is inclined to the plane of polarization along the alternate lines, as is indicated below the figure, the arrows representing the direction of the vibration (electric vector). Between the lines of plane-polarized light, which appear as dark fringes when the nicol is so oriented as to extinguish the light, we have either elliptically or circularly polarized light, as can at once be shown by the introduction of a quarter-wave plate, which enables us to extinguish the light along the lines 2, 4, 6, and 8 by suitable adjustment of the mica plate and analyser. The direction of revolution of the vibration along lines 2 and 4 is opposite to that along lines 6 and 8.

I at first attempted to work out the problem by compounding a plane-polarized vibration, coming from the air-glass surface, with a nearly circular vibration coming from the metal. This was a failure, but it at once occurred to me that owing to the refraction by the glass or gelatine, the incidence-angle of the light falling upon the metal would be too small to produce circular polarization.

It seemed best, upon the whole, to determine experimentally the exact nature of the vibration coming from each surface, and then to try whether, by compounding them with various phase-differences, the observed results could be accounted for.

The incident light vibrated in a plane indicated by the arrow at the top of fig. 4. The light reflected from the glass surface is of course plane-polarized, vibrating parallel to the surface when the angle of incidence is equal to the polarizing angle. For larger angles of incidence, the plane of the reflected vibration makes an angle with the surface, depending on the magnitude of the reflected component, which lies in the plane of incidence. To determine the nature of the vibration coming from the glass-metal surface, it was necessary to get rid of the light reflected from the upper surface of the glass. This was done by laying a small piece of rather thick plate-glass on a plate of speculum metal with a film of benzole between, and allowing a narrow beam of light to fall upon the surface of the glass. The images reflected from the two surfaces appeared separated, and could be independently examined with a nicol. The benzole film practically brought the metal surface into optical

contact with the glass. The reflected beams were found to be plane-polarized, the vibrations being in the directions shown in fig. 5 *a*, for an angle of incidence near the polarizing angle. As the angle of incidence increased, the planes of the two vibrations both turned towards the vertical, and finally made an angle of 90° with each other, *i. e.* 60° and 30° with the reflecting surface.

If we compound the two components shown in fig. 5 *a* with varying phase-differences, we can account easily for the polarized fringes. In fig. 5 *b* let BC be the vibration from the glass and BA that from the metal. When the path is zero or a whole number of waves, we have the plane-polarized resultant BE. If the path-difference is an odd number of half-waves, we have the plane-polarized resultant BF. These two states occur along the lines 1, 5 and 3, 7 respectively. The angles which the planes of vibration make with the reflecting surface should be respectively greater and less than the angle made by the component coming from the metal, as was found to be the case. As we increase the angle of incidence the component BC (from glass) increases in magnitude and turns up towards the vertical, the inclinations of the planes of polarization of the two sets of fringes to each other becoming greater.

Between the lines along which the light reflected from the film is plane-polarized, we have lines of elliptically (or in some cases circularly) polarized light. The directions of revolution were determined with the quarter wave-plate, and are as shown in fig. 4. Geometrical computations of the elliptic vibrations, resulting from two components such as are shown in fig. 5 *b*, agreed perfectly with the experimentally determined orbits, both in respect to the directions of the major axes and the directions of rotation. The method used was similar to the one given in Müller-Pouillet's textbook (vol. ii. 1. p. 1135), the only modification necessary being the rotation of one of the sets of parallel lines, which represent displacements, through a certain angle, since, in the case with which we are dealing, the two components are not at right angles. By sufficiently increasing the incidence-angle the components AB and BC can, however, be brought to very nearly a right angle. At the same time the intensity of the component from the glass surface has increased to such a degree as to be about equal to the one from the metal, and we have practically circular polarization along certain lines.

A careful study of these fringes makes a most excellent exercise for advanced students in Optics. The conditions

under which they are obtained are very simple, and I consider their study far more instructive than the mere inspection of a collection of crystal sections in a polariscope arranged for convergent light.

*Colours of Frilled Transparent Films on
Metallic Surfaces.*

We will now consider a remarkable case of interference which appears to be essentially different from any of the cases which have been previously studied. The theory of thin films shows, as Lord Rayleigh points out in his article on "Wave-theory of Light," that a transparent film on a perfectly reflecting surface shows no interference-colours. As I have already pointed out, a thin film of collodion deposited on a bright surface of silver shows brilliant colours in reflected light. It moreover *scatters* light of a colour complementary to the colour of the directly reflected light. This I find is due to the fact that the collodion film "frills," the mesh, however, being so small that it can only be detected with the highest powers of the microscope. Commercial ether and collodion should be used. If chemically pure ether obtained by distillation is used, the film does not frill, and no trace of colour is exhibited.

In the cases of the transparent films with the first surface lightly silvered, the second heavily coated, the waves absent in the reflected light are absorbed by the metal, as I have already shown. In the present case these waves are scattered by the granular surface. If a spot on the film which appears purple by reflected light is illuminated with sunlight, it will be found that green light is scattered, not in all directions, but through a range corresponding to the size of the granulation, as in the case of mixed plates.

If the light is incident normally, the scattered light comes off through an angular range included between ten and thirty degrees, and again at an angle of nearly 90° , the latter being strongly polarized. Conversely, if the sunlight be incident at nearly 90° , strongly polarized light is scattered normally. Considerable difficulty has been found in explaining these colours satisfactorily. They appear to be saturated, *i. e.* certain wave-lengths are completely absent in the reflected light, and until the granulation was detected with the microscope it was impossible to make even a satisfactory hypothesis. Even now the polarization effects are difficult to account for.

At first sight it may seem as if the colours could

be classed with the phenomena of mixed plates, their brilliancy and saturation reminding one of the appearances produced by laminary retardation. The films, however, show no colour by transmitted light when deposited on glass, and the effective doubling of the retardation, by the reflexion back through the film by the metal surface, can hardly account for the observed effects. Moreover, the energy stream reflected from the surface of the collodion appears to be essential, for if we employ light polarized perpendicular to the plane of incidence, and set the plate at the polarizing angle of collodion, so that no reflexion occurs except at the metal surface, all trace of colour disappears. If the angle of incidence is larger than the polarizing angle, the colour of the reflected light changes to its complementary tint when the plane of polarization is made parallel to the plane of incidence. As I have shown in the preceding part of this paper, the effects at large angles of incidence involve the interference of two streams of light polarized in planes inclined at 90° to each other, which are complicated enough with monochromatic light and structureless films. For the present only normal incidence will be considered. Though I know of no direct way of proving that, in this case, the light reflected from the collodion surface is an essential factor, there is strong indirect evidence.

If the film is wedge-shaped and sodium light is employed, the dark fringes seen at normal incidence move towards the thick edge of the wedge as the angle of incidence is increased, exactly as they do with thin films of the ordinary type. If the incident light is polarized perpendicularly to the plane of incidence, the fringes gradually fade out, disappearing at the polarizing angle. This indicates that they are produced in the same way at normal incidence as at the polarizing angle, namely, through the agency of light reflected from the surface of the collodion.

If we consider some value of λ , for which the path-difference between the rays reflected from the collodion and metal surfaces amounts to an odd number of half-waves, the colour corresponding to this wave-length will be weakened in the reflected beam owing to interference. In the case of transparent thin films the absent colour appears in excess in the transmitted light, while in the present case it is thrown back through the film by the metal surface. It is thus clear that the colours which are weakened in the reflected light are made to traverse the frilled film a greater number of times than the colours for which the path-difference is an even number of half-waves.

This accounts for the fact that these colours are more strongly scattered by the granulations of the films.

A collodion surface only reflects about 5 per cent. of the incident energy; and it was found impossible to account for the strong colours seen in the reflected light, by compounding the feeble stream of light from the collodion with the powerful stream coming from the metal.

It appeared, however, that the observed effects could be accounted for, if the somewhat arbitrary assumption were made that the granulated surface reflected more strongly than a smooth surface. As I have already said, the granulations are too small to interfere with the regular reflexion of light, the scattering being selective, so to speak, *i. e.* confined to the waves which, owing to interference, are compelled to traverse the film a number of times.

The assumption above referred to appeared to be too arbitrary to make without some experimental evidence, and experiments were therefore made to determine the effect of the "frilling" of the film on its reflecting power. One of the faces of a 60° prism of crown glass was flowed with collodion of the same dilution as that used in the preparation of the coloured films. It showed in reflected light interference-colours, which, however, were very much diluted with white light, owing to the small difference between the refractive indices of the two media. In working with the film on silver it was found that, if the colours did not appear at once, as soon as the film dried, they could be brought out by breathing on the film, the deposit of moisture being advantageous to the formation of the granulations. It was always possible to intensify the colours in this way. The film deposited on the surface of the prism was treated in this way, one half of it being screened from the deposit of moisture by a plate of glass. As soon as the moisture had evaporated, it was found that the reflecting power of the surface had been greatly increased, the film appearing almost as bright as a half-silvered surface.

The increase in the brilliancy of the reflected light was about three-fold, as was shown by covering the unfrilled portion with a sheet of thin glass, which about equalized the intensities. In other words, the frilled collodion-surface regularly reflects white light, of an intensity very nearly equal to that of light reflected from thin glass surfaces.

On examining the granular surface with polarized light, it was found that the angle of maximum polarization was in the neighbourhood of 63° , which would make its refractive index about 1.96. The polarizing angle of the smooth collodion

was about 56° , the corresponding refractive index being 1.48.

An attempt was made to determine whether the granulation gave rise to elliptical polarization, the abnormal value of the refractive index suggesting the properties of the surface-films, which play such an important part in the theory of elliptical polarization. No decisive results were obtained, for though the phenomenon was found, it seemed impossible to eliminate the component reflected from the collodion-glass surface, which, as I have shown, may, by interference with the component reflected from the air-collodion surface, give rise to an elliptical vibration.

The interferometer failed to show any change in the refractive index as the result of frilling, which indicates that the effect is confined to the surface. A film deposited on glass of such thickness as to produce a shift of half a fringe width (sodium light) was frilled by moisture, one half being protected by a glass plate. No shift was found at the line of demarcation, as would have been the case if the refractive index of the film had been raised from 1.48 to 1.96 throughout its entire thickness.

It is my plan to make a further study of the apparent effect of the granulation on the refractive index of the surface, by the method of total reflexion.

XLVI. *Disintegration of the Platinum Metals in Different Gases**. By L. HOLBORN and L. W. AUSTIN†.

THE disintegration of the platinum metals at high temperatures appears to be primarily due to their high melting-points. The phenomenon which has been observed in many connexions in the case of platinum also occurs with rhodium, palladium, and in a still greater degree with iridium. Observations on the disintegration of these metals in air have been carried out by one of the authors‡. The metals were used in the form of strips 3 mm. wide which were heated electrically. The "black temperature," S , was measured by means of the optical pyrometer §, the temperature Celsius, t ,

* This article in somewhat different form was presented to the Berlin Academy. *Sitz. Ber. der Berl. Akad.* p. 245 (1903).

† Communicated by the Authors.

‡ L. Holborn and F. Henning, *Sitz. Ber.* p. 938 (1902).

§ L. Holborn and F. Kurlbaum, *Sitz. Ber.* p. 712 (1901).

being calculated from the empirical formula

$$t = 1.157 S - 67.2.$$

It was found that the disintegration increased very rapidly with increasing temperature, iridium showing a loss of weight of 11.8 mg. in an hour at 1210° C., 72 mg. at 1670°, and 277 mg. at 2130°. At 1670° platinum and rhodium showed about the same loss in weight, while iridium lost approximately ten times as much. The pure metals showed no decrease in disintegration during the longest heating (3 hours), the loss appearing to be proportional to the time. Changes were observed, however, in the cases of the platinum-iridium alloys, undoubtedly due to the changes in the composition at the surface on account of the more rapid disintegration of the iridium. Silver and gold heated to 100° below their melting-points showed no certain loss in weight. We have now extended this work to cover the disintegration in different gases.

Observations on the disintegration of glowing metals in different gases thus far have been confined to platinum and palladium. Elster and Geitel*, and Nahrwold † found, contrary to Berliner ‡, that platinum showed very little disintegration in hydrogen. Stewart § investigated platinum and palladium, and observed that both metals showed little or no disintegration in nitrogen; that in hydrogen, platinum showed no loss in weight and palladium much less than in air. He made no observations with oxygen, but cites an observation by Kaufmann to the effect that in oxygen the disintegration of platinum is six times as great as in air. According to Stewart, the disintegration of platinum in air decreases with decreasing pressure, while in the case of palladium it increases. Emich || has studied the action of hot platinum in air and in nitric oxide, and has shown that oxygen is taken up by the platinum from the air and from the decomposed nitric oxide.

In the present work the same methods were followed as in the former, except that now it was necessary to decrease the width of the metal strips in order to bring them to the required temperature with a smaller current. These narrower strips, especially in the cases of the very hard rhodium and iridium, were very difficult to produce of uniform width and

* J. Elster and H. Geitel, *Wied. Ann.* xxxi. p. 126 (1887).

† R. Nahrwold, *ib.* xxxv. p. 116 (1888).

‡ A. Berliner, *ib.* xxxiii. p. 291 (1888).

§ W. Stewart, *ib.* lxxvi. p. 88 (1898); *Phil. Mag.* [5] xlviii. p. 481 (1899).

|| F. Emich, *Sitz.-Ber. der Wiener Akademie*, ci. [2 b], p. 88 (1892).

without irregularities. The different strips could not therefore be properly compared with one another, but this was not of great moment as the chief object of the work was the comparison of the disintegration of the same strip under different conditions.

The 75 mm. long strips were clamped to 6 mm. thick copper wires and the whole introduced into a glass tube (fig. 1) 12 cm. in diameter, by means of a ground-glass connexion. The copper wires were cemented into the glass with sealing-wax. All the other external connexions of the tube were rendered tight with mercury. The tube was also provided with a side tube containing P_2O_5 to be used at low gas pressures. The current was introduced through mercury cups in which the ends of the copper wires rested.

The metal strips were too narrow for direct comparison with the optical pyrometer, therefore a 3 mm. wide, electrically heated platinum band was brought to the required temperature. Against this the metal strip in the tube was projected, and heated until it attained the same degree of brightness.

Contrary to the observations on the broad metal strips, a diminution of the disintegration with the time was often observed. This was due to the fact that the narrow strips, on account of the disintegration, soon became thinner in the central hottest zone; and if this was kept at a constant temperature by reducing the current, the length over which the disintegration took place became constantly shorter. In the cases where the disintegration was most rapid, we have therefore not used the highest possible temperatures and have also reduced the usual 30 minutes time of heating, in order to prolong the uniformity of the strips and to enable a greater number of comparisons to be made. Another reason for reducing the amount of the disintegration was that the transparency of the tube was rapidly destroyed by the metallic deposits which had to be frequently removed between the observations.

The weighings were made on a balance having a sensibility of about three divisions for 0.1 mg., and are certain to 0.01 mg.

Fig. 1.

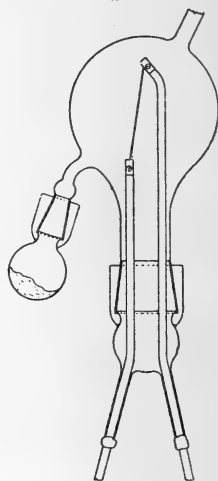

TABLE.

| | Temperature. | | Gas. | Pressure. mm. Hg. | Time. Min. | Loss in 30 Min. mg. |
|--------------------|----------------|------------------|------|----------------------|---------------|---------------------------|
| | S. (Black). | t. (Celsius). | | | | |
| Platinum | 1500° | 1670° | Air | 760 | 30 | 0.68 |
| Width 1.0 mm. | " | " | " | 25 | " | 0.32 |
| Thickness 0.1 mm. | " | " | O | 760 | " | 3.41 |
| | " | " | N | " | " | 0.05 |
| | " | " | H | 25 | 15 | 0.03 |
| | " | " | " | 0.2 | " | 0.00 |
| | 1150 | 1260 | Air | 760 | 30 | 0.03 |
| | 1050 | 1150 | " | " | " | 0.01 |
| | " | " | O | " | " | 0.04 |
| Rhodium. | 1500 | 1670 | Air | 760 | 30 | 0.29 |
| Width 0.8 mm. | " | " | " | 25 | " | 0.14 |
| Thickness 0.3 mm. | " | " | O | 760 | " | 1.60 |
| | " | " | N | " | " | 0.05 |
| Iridium. | 1500 | 1670 | Air | 760 | 15 | 12.57 |
| Width 0.7 mm. | " | " | " | 25 | 30 | 1.61 |
| Thickness 0.35 mm. | " | " | O | 760 | 10 | 134.5 |
| | " | " | N | " | 30 | 0.46 |
| Iridium. | 1500 | 1670 | H | 0.3 | 15 | 0.04 |
| Width 0.8 mm. | 1150 | 1260 | Air | 760 | 10 | 0.78 |
| Thickness 0.1 mm. | | | | | | |
| 90 Pt., 10 Ir. | 1500 | 1670 | Air | 760 | 30 | 1.47 |
| Width 0.5 mm. | " | " | O | " | " | 3.72 |
| Thickness 0.2 mm. | " | " | N | " | " | 0.16 |
| Palladium. | 1350 | 1500 | Air | 760 | 30 | 1.00 |
| Width 1.0 mm. | " | " | " | 25 | 10 | 7.29 |
| Thickness 0.1 mm. | " | " | O | 760 | 30 | 0.74 |
| | " | " | N | " | " | 1.12 |
| | 1300 | 1440 | Air | 25 | 10 | 1.09 |
| | " | " | H | 30 | 15 | 1.06 |
| | " | " | " | 0.2 | 15 | 10.85 |
| | 1250 | 1380 | Air | 760 | 30 | 0.06 |
| | 1150 | 1260 | " | " | " | 0.01 |

The observations on each metal were made in the following order :—

1. At atmospheric pressure, the tube being left open at top and bottom to allow a free circulation of air.
2. With the tube pumped out to a water vacuum.
3. With a slow stream of commercial oxygen or nitrogen passing slowly through the tube.
4. With the tube filled with hydrogen at different pressures.

The loss of weight which is given in the last column of the table is in most cases the mean of several observations. The values are calculated for 30 minutes heating, the actual time being given in the last column but one.

As the table shows, the behaviour of platinum and rhodium is very similar. The disintegration at atmospheric pressure in oxygen is about five times as great as in air, in air at 25 mm. about half as much as at 760 mm., and in nitrogen it becomes very small. That it does not disappear entirely, is probably due to the 1.7 per cent. of oxygen that was mixed with the nitrogen. In the work with the broad strips it was found that the loss of weight of platinum and rhodium under the same circumstances was the same. The differences here shown in the two metals are due to the fact that on account of its irregular width the rhodium strip reached the disintegration temperature in only a comparatively narrow zone. Iridium, which disintegrates about ten times as rapidly in the air as platinum, behaves in a similar way except that the differences are much greater. At 25 mm. pressure its loss in weight is only $\frac{1}{8}$ that at 760 mm., while in oxygen the loss is eleven times as great.

In palladium the phenomena were entirely different. The disintegration in air increased with decreasing pressure, while the nature of the surrounding gas seemed to be without influence, the results being the same in air, oxygen, and nitrogen. According to Stewart, palladium, like platinum, should show little disintegration in nitrogen.

For the experiments in hydrogen the gas was prepared electrolytically, and freed from oxygen by passing through several wash-bottles containing alkaline pyrogallol solution, and dried by passing through tubes of calcium chloride and phosphorus pentoxide. The whole apparatus was several times pumped out and filled with hydrogen before the final filling.

The experiments with palladium in hydrogen were difficult on account of the absorption of the gas by the metal. It was not found possible at atmospheric pressure to keep the metal for any length of time above the temperature where the disintegration begins. In most cases it melted before reaching this temperature, and also showed an increase in weight due to the absorbed gas, which made any attempt at measuring the disintegration impossible. At lower pressures the experiments were more successful. During the preliminary fillings and pumpings, the palladium was kept at a dull red heat. Finally, when hydrogen was admitted until the pressure reached 30 mm. Hg, and the temperature was

increased to $S=1300^\circ$ and there kept constant, the loss in weight was practically the same as in air at the same pressure. The disintegration increased rapidly as the pressure was reduced, until at 0.2 mm. Hg it was more than ten times as great as at 30 mm. The disintegrated particles in this case formed a brilliant metallic deposit on the copper wires in the tube, whereas when oxygen was present the deposits were always black.

Platinum and iridium were also heated in the high hydrogen vacuum, but showed no disintegration. A few observations were made at lower temperatures where the disintegration first begins to appear. Iridium showed a loss of weight at the lowest temperature, but the results were irregular since the metal was oxidized at this temperature. Experiments with gold in oxygen were also attempted, but no traces of disintegration were observed.

This investigation has a practical bearing on high-temperature work in general. Platinum heating-coils when brought too near the melting-point of the metal are rapidly destroyed, and the case is still worse with iridium, which otherwise on account of its high melting-point would be particularly suited for use in producing high temperatures. Our results indicate means by which the platinum metals may be protected from disintegration.

Physikalisch-Technische Reichsanstalt,
Charlottenburg, Feb. 1904.

XLVII. *A Quartz-Thread Vertical Force Magnetograph.* By
W. WATSON, A.R.C.S., D.Sc., F.R.S., Assistant Professor
of Physics at the Royal College of Science, London*.

[Plates XXII. & XXIII.]

THE late Dr. Eschenhagen was the first to show that when the moment of inertia of the suspended system in a horizontal-force magnetograph is made very much smaller than that employed in the ordinary form, it is possible to detect variations in the earth's field of quick period. Since the study of these short-period variations promises to be of considerable interest, the design of self-recording instruments capable of giving satisfactory records becomes of importance. Both Dr. Eschenhagen† and the author‡ have described

* Communicated by the Physical Society: read February 26, 1904.

† 'Terrestrial Magnetism,' v. p. 59 (1900).

‡ Ibid. vi. p. 187 (1901).

forms of apparatus suitable for recording the variations of the declination and horizontal component. The design of a satisfactory form of instrument to record the rapid variations of the vertical component presents, however, some very considerable difficulties. Thus, if the attempt is made to reduce to any great extent the moment of inertia, and hence the mass, of the balanced magnet in the ordinary form of Lloyd's balance, it is found that irregularities are immediately introduced owing to imperfections or dirt interfering with the free movements of the knife-edge. Further, the slight tremors to which the base of the instrument is almost always subject causes the knife-edge to slip about on the plane, and thus the azimuth of the magnet varies, and there is difficulty in obtaining a satisfactory record.

The above considerations led the writer, about two years ago, to try various other forms of Lloyd's balance; and the following paper contains a description of the instrument finally arrived at, and which has been actually run for some considerable time.

In principle the instrument resembles the quartz-thread gravity-balance designed by Prof. Threlfall*. In addition to the advantages to be expected from this form of balance due to the suppression of the knife-edge, it promised to allow of a very simple method of compensating for the effects of changes of temperature. This is of considerable importance, for many vertical-force magnetographs might almost be used more efficiently as thermographs than as instruments for recording changes in the vertical component.

The principle of the instrument is to have a magnet NS (fig. 5, Pl. XXII.) suspended on a horizontal quartz fibre AB, the fibre being kept stretched by means of a spring. The centre of gravity of the magnet and the torsion of the fibre are so adjusted that the axis of the magnet is horizontal. In order to see how the temperature compensation can be effected, let us suppose that the axis of the supporting fibre passes through the centre of gravity of the magnet, so that in the northern hemisphere the fibre has to be twisted, say by turning the end B, in the clockwise direction as seen when looking along the fibre from B towards A. If now the temperature rises two effects will be produced. In the first place, the magnetic moment of the magnet will decrease, and hence the couple acting on the magnet, due to the vertical component of the earth's magnetic field, will decrease. The result will be that the north end of the magnet will rise. Secondly, owing to the fact that the torsional rigidity of fused silica

* Trans. Royal Society, cxcii. p. 215 (1899).

increases with rise of temperature, the couple due to the torsion of the fibre will increase. On this account also the north end of the magnet will rise. Next let us adjust the balance of the magnet so that the centre of gravity lies on the same side of the axis of the fibre as the south pole, the displacement being such that to make the magnet lie with its axis horizontal, the fibre has to be twisted in the anti-clockwise direction. In this case, when the temperature rises the north end of the magnet will tend to rise owing to the decrease in magnetic moment, but will tend to fall owing to the increase in the stiffness of the fibre. Thus, by suitably adjusting the horizontal displacement of the centre of gravity of the magnet, that is the initial torsion of the fibre, we can so arrange matters that the decrease in the couple due to the one effect is exactly equal to the increase due to the other; and so changes of temperature do not affect the position of the magnet. In the instrument described, the horizontal displacement of the centre of gravity is effected by moving a small weight along the magnet; and the possibility of obtaining complete compensation depends on the fact that the coefficient of increase of the rigidity of the fibre is much greater than the coefficient of linear expansion of steel*.

The construction of the instrument will be evident from figs. 1, 2, 3, 4 (Pl. XXII.). The base of the instrument consists of a strong metal casting having uprights at the ends which carry the attachments for the ends of the fibre. Two uprights screwed to the middle of the base serve to support a circular plate U which carries the plano-convex lens L, used to form an image of the slit on the recording-drum. The circular disk V can turn through a small angle, its position being determined by two adjusting screws, and it carries the right-angled reflecting prism P. One end of the quartz fibre is fused to a quartz spring G, while the other end is fused to a small rod of quartz which is soldered into a small metal rod, and this rod is clamped by means of a screw to the screw H. Both the screws H and I have a key-way cut along them, so that by means of the nuts O they can be moved parallel to their axis but without rotation. These screws pass through holes in the two collars *m* and M, which themselves fit in the uprights carried by the base. The collar M carries a divided head, and is fitted with a fine adjustment Z, shown in fig. 3. Since only the portion FB of the quartz thread is twisted, the fine adjustment and divided head allow of the twist put

* The simple rigidity of fused silica in the form of fibres of moderate diameter increases by $\cdot 00013$ of its value for 1° C., while the coefficient of linear expansion of steel is $\cdot 000011$.

into the thread being accurately adjusted and read off. A knowledge of the amount of twist is of assistance when adjusting the temperature compensation.

The fixed mirror D is supported on an L-shaped piece of brass, which is held in place by three studs fixed to the base which pass through loose-fitting holes. The L-shaped piece is held up by small spiral springs against three nuts S, R, Q, which screw on these studs. By adjusting these three nuts the position of the spot of light reflected from the fixed mirror can be adjusted.

The suspended system consists of two magnets 8 cms. long and 1 mm. in diameter attached by means of small platinum straps, p (fig. 4), to two rods of fused silica which form part of the plate of fused silica C forming the mirror. These rods are bent as shown, and are fused to the ends E and F of the suspension fibre. There is also a small vertical rod of fused silica, which serves to carry a small weight q used when adjusting the sensitiveness. The reason why this gravity-bob is carried by a rod of fused silica is that, owing to the exceedingly small coefficient of expansion of silica, the centre of gravity, and hence the sensitiveness, is not appreciably altered by changes of temperature. Since the weight q cannot be moved vertically, the sensitiveness is adjusted by filing the weight till the required sensitiveness is nearly attained. The final adjustment is made by means of a very small weight r which can be screwed up and down. The upper surface of the mirror is platinized*. It will be noticed that the movable system consists of very few parts, while the mirror being attached to the fibres by fusion, we are in no way dependent on cements.

Since the tension put into the thread is such as to stretch the spring G through two or three millimetres, the variations in tension produced by changes in the length of the metal base are insignificant, and will certainly, over the comparatively small temperature-range likely to occur, be proportional to the first power of the temperature, and hence can be eliminated when making the temperature adjustment. A photograph of one of the suspensions is shown in fig. 6. The adjustment for temperature-compensation is made by means of a small weight W which is clamped on to one of the magnets. The weight of the moving system is about 3 grams.

In order to damp the vibrations of the magnet four copper plates K are placed near the poles. These plates are attached

* Watson, Phil. Mag. July 1903, p. 191; Proc. Phys. Soc. of London, xviii. p. 502 (1903).

to an arrestor J, which can be raised by a cam X worked by a handle Y. When the arrestor is raised the right-hand magnet rests in two V's, while the left-hand magnet rests on a plane surface.

The instrument is closed in with a wooden case, and a thermometer passes through the upper surface of this case, the bulb being in the neighbourhood of the magnets. A small drawer is fitted at the lower part of the base which serves to contain some desiccating agent when the instrument is used in a damp situation.

An instrument of the above pattern was, through the kindness of the Director (Dr. R. T. Glazebrook), tested at the National Physical Laboratory, and was found to work satisfactorily. Owing to disturbances produced by electrical railways it was impossible to make the temperature-compensation at South Kensington; and Mr. F. E. Smith, of the National Physical Laboratory, kindly undertook to perform the adjustment after the instrument was removed to Bushey House. He performed this adjustment with such skill, that with a change of temperature of 7° C. he was unable to detect any variation in the scale-reading ($1 \text{ mm.} = 1.6\gamma$) due to temperature change. When making these temperature adjustments, the trace obtained from a vertical-force magnetograph which was kept at a constant temperature was used to eliminate changes in V. I should like here to express my thanks to Mr. Smith for the trouble he took, and my appreciation of the skill with which he handled what is necessarily a very fragile and delicate instrument. In fig. 7 is given a reproduction of a portion of a trace obtained with the instrument when at Bushey. In the original 1 cm. corresponded to 3 minutes of time and 8γ * respectively. The recording-drum was at a distance of 170 cms. from the instrument.

The following hints as to making and adjusting the moveable system may be of assistance to any one attempting to make one of these instruments. A slab of fused silica is cut by means of a lapidaries' wheel, armed with diamond-dust, and roughly ground to size with carborundum on a metal plate †. Two small tags of silica are then attached to the sides of this slab by fusion with an oxyhydrogen flame. These tags serve to support the stirrups which carry the magnets, and to their ends the fibres will be fused afterwards. The surfaces of the slab and of the tags are ground plane and approximately parallel, and then one surface is ground and polished

* $1\gamma = .00001$ c.g.s. unit.

† The methods of working such quartz mirrors and producing the platinum reflecting surface are described in the paper referred to previously.

optically plane. The platinum stirrups for the magnets having been fitted, the small silica upright for the inertia-bob is fused to one of the tags. The surface of the mirror having been platinized, the magnets are fitted in place, a small quantity of fused shellac being used to prevent the stirrups slipping.

To prepare the fibres, a rod of fused silica having a diameter of about 2 mms. is taken and heated in a small oxyhydrogen flame, and then rapidly drawn out. Two stops must be arranged so as to limit the distance the hands can be separated, and hence the length of the fibre produced. With a little practice it is possible to obtain a fibre of a suitable length and diameter (0.008 to 0.010 cm.). The two portions of the original rod must be cut off about a centimetre from the end of the fibre. One of these ends is fused to one of the tags attached to the mirror. The other end is in one case fused to the quartz spring, and in the other is soldered by the process described by Threlfall* to a small brass rod which fits into the clamp attached to the screw H (fig. 1).

To adjust the centre of gravity, the movable system is mounted between two uprights on a wooden board, while a small U-shaped piece of brass, with slots to take the tags attached to the mirror, supports the mirror and magnets. The rods of quartz between the fibre and the mirror are then softened by heating in a very small oxyhydrogen flame, and bent so that the centre of gravity lies a little below the line of support. During this operation the uprights of the U protect the magnets and mirror from the heat of the flame. The operation is one requiring some delicacy of touch, but is really not as difficult as one would suppose.

With reference to the adjustment for temperature compensation, the side on which the weight will have to be placed depends on which side of the suspension-line the centre of gravity is situated, since it is almost impossible to get it exactly vertically below this line when adjusting the system. By, however, running the instrument in a situation where the changes of temperature are considerable, it will soon be seen whether it is over- or under-compensated. By making two sets of observations with the weight in two widely different positions, and noting the amount of twist put into the fibre, the position for compensation can be calculated. In this connexion the easiest way is to calculate the correct amount of twist for the fibre, put in this amount of twist, and then adjust the weight till the magnet is horizontal.

* 'Laboratory Arts,' p. 226 (Macmillan & Co.).

The advantages claimed for this form of vertical-force magnetograph are:—

1. The elimination of the knife-edge, and hence the absence of irregularities introduced by the presence of dust &c. on the supporting plane. Also the needle does not move in azimuth owing to tremors of the supports.

2. The number of materials and separate parts entering into the composition of the movable system is small, and, with the exception of the steel of the magnets, they are unoxidizable and unaffected by impurities in the air.

3. The method of compensating for temperature is simple, and does not involve a complicated counterpoise likely to get displaced.

4. The moment of inertia of the movable system is small although the magnetic moment is considerable.

5. The mirror cannot be distorted by its mounting, nor is there any likelihood of the position of the mirror with reference to the magnets being variable with the temperature.

A second instrument has been constructed according to this design, the cost being defrayed by the Government Grant Committee of the Royal Society; and it is proposed to set up this instrument in the new Magnetic Observatory belonging to the National Physical Laboratory.

XLVIII. *On Stresses in a Magneto-static Field.* By GEORGE W. WALKER, M.A., A.R.C.Sc., Fellow of Trinity College, Cambridge, Lecturer on Physics in the University of Glasgow*.

THE usual methods of analysis lead to a system of stress in a magneto-static field which is exactly analogous to the Maxwellian system of stress in an electrostatic field. The stresses may thus be spoken of as stresses of the electrical type.

In his work entitled 'Aberration and the Electromagnetic Field,' p. 76, Mr. G. T. Walker obtains a system of stress in a magneto-static field which differs from the stresses of electrical type in the superposition of a hydrostatic pressure $\frac{1}{8\pi} \left(\frac{\mu}{\mu_0} - 1 \right) H^2$. I am not concerned here with the analysis by which this result is obtained; but on page 79 *et seq.* Mr. Walker discusses an experiment due to Quincke, which he considers crucial between the two views.

The experiment was as follows:—A thermometer-shaped vessel with a capillary tube attached was filled with a solution

* Communicated by the Physical Society: read February 26, 1904.

of ferric chloride, so that the liquid stood at a certain height in the capillary tube. The bulb was placed between the poles of a strong electromagnet, and when the magnet was excited the level of the liquid in the capillary tube fell. The bulb was in the form of a disk, the direction of thickness being parallel to the lines of force.

Mr. Walker argues that his system of stress would produce a hydrostatic pressure throughout the liquid "under which it must contract, and the bulb slightly expand; whereas the stresses of electric type would only give a very small force at the surface of the liquid in the capillary tube which would make the column rise."

It appears to me that Mr. Walker's discussion takes no account of the surface forces due to stresses of electrical type which must exist at the surface separating the liquid in the bulb from the glass, and, moreover, involves the assumption that the expansion of the glass under an internal pressure is of less importance than the contraction of the liquid under the same pressure.

It is easy to show that the stresses of electrical type give a force per unit area directed outwards on the inner surface exactly equal to the hydrostatic pressure in the liquid on Mr. Walker's theory.

For assuming that the glass is non-magnetic and that the field is uniform in the liquid and outside, let H_1 be the magnetic force in the glass, H_2 the magnetic force in the liquid, then

$$H_1 = \frac{\mu}{\mu_0} H_2,$$

where $\frac{\mu}{\mu_0}$ is the permeability of the liquid. Then the force per unit area directed outwards is

$$\frac{1}{8\pi} \left(H_1^2 - \frac{\mu}{\mu_0} H_2^2 \right),$$

that is $\frac{1}{8\pi} \frac{\mu_0}{\mu} \left(\frac{\mu}{\mu_0} - 1 \right) H_1^2$, or $\frac{1}{8\pi} \frac{\mu}{\mu_0} \left(\frac{\mu}{\mu_0} - 1 \right) H_2^2$;

and since $\frac{\mu}{\mu_0}$ is very nearly unity this is practically

$$\frac{1}{8\pi} \left(\frac{\mu}{\mu_0} - 1 \right) H_2^2.$$

My contention is that the expansion of the glass vessel under this force (of electrical type) is more important than

the contraction of the liquid under the equal hydrostatic pressure on Mr. Walker's system.

Under this internal force per unit area which we may call p_0 , the walls will bulge outwards, and we may consider them as thin elastic plates clamped at the edge.

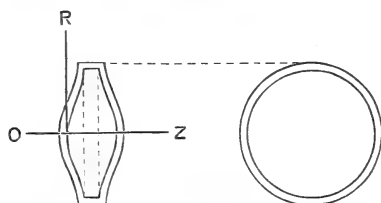

Taking O as origin, the equation for the displacement ω parallel to OZ is

$$\nabla^4 \omega = \frac{3}{2} \cdot \frac{p_0(1-\mu^2)}{qh^3} *$$

where μ is Poisson's ratio,
 q is Young's modulus,
 and h is the thickness of the plate;
 assuming symmetry about OZ.

The solution is

$$\omega = \frac{3}{2} \frac{p_0(1-\mu^2)}{qh^3} \left\{ \frac{1}{32} a^2 r^2 - \frac{1}{64} r^4 \right\},$$

where r is the distance from O and a is the radius of the disk.

Thus the increase of volume due to bulging is

$$\begin{aligned} & 4\pi \int_0^a \omega r dr \\ &= \frac{\pi}{32} a^6 p_0 \frac{(1-\mu^2)}{q \times h^3}. \end{aligned}$$

The radius of the bulb was 1.75 cm. and the length .4 cm. I do not suppose the walls were more than $\frac{1}{2}$ mm. thick, so that we have

$$a = 1.75 \text{ cm.}, \quad l = .4 \text{ cm.}, \quad 2h = .05 \text{ cm.};$$

$$\therefore a = 4.4l, \quad h = \frac{a}{70}.$$

For glass we may take $q = 6 \times 10^{11}$ and $\mu = \frac{1}{4}$.

* Rayleigh, 'Theory of Sound,' vol. i. p. 356.

Thus the increase in volume of the bulb is

$$\begin{aligned}\delta v &= \pi a^2 l p_0 \times \frac{4.4 \times (70)^3}{32 \times 6 \times 10^{11}} \\ &= \pi a^2 l p_0 \times 7800 \times 10^{-11}.\end{aligned}$$

The compressibility of water is about 4×10^{-11} , so that the diminution of volume of the fluid under a hydrostatic pressure is

$$\delta v_0 = \pi a^2 l p_0 \times 4 \times 10^{-11}.$$

The expansion of the glass vessel under the stresses of electrical type is far more important than the contraction of the fluid under the hydrostatic pressure of Mr. Walker's theory. I therefore think that, so far from being crucial, Quincke's experiment gives no support to the latter theory, and can be readily explained by the stresses of electrical type.

Physical Laboratory, Glasgow.
December 12, 1903.

XLIX. *The Dielectric Capacity of Atoms.*

By WILLIAM SUTHERLAND*.

THE electron theory imparts more interest than ever to the investigation of the properties of atoms. At the present stage of this theory the electrical properties of atoms demand investigation from every possible point of attack. The dielectric capacity of the atom being the most fundamental of such properties, it seemed to me desirable to investigate it by means of certain principles developed in a paper on "Ionization, Ionic Velocities, and Atomic Sizes" (Phil. Mag. [6] iii. Feb. 1902). In that paper it was shown that at infinite dilution the ionic velocity ${}_1\lambda_0$ of an element 1 whose atom has a radius a_1 and a dielectric capacity K_1 dissolved in a solvent whose viscosity is η and dielectric capacity K_0 is given by the equation

$${}_1\lambda_0 = \nu e^2 K_0 / 6\pi\eta a_1 K_1, \quad \dots \dots (16)$$

where ν is the valency of the ion and e is the electric charge of a monovalent ion. In seeking to verify this relation by means of published experimental data, in the absence of measured values of K_1 the dielectric capacity of the stuff of

* Communicated by the Author.

the atom, I used Maxwell's relation $K_1 = N_1^2$, where N_1 is the refractive index of the stuff of the atom. For ten metallic ions, namely those of the Li family, those of the Be family from Mg to Ba, and for Zn, and for the six negative fatty acid radicals from formic to caproic, the equation (16) was found to be verified in a broad way. But in the case of the halogens from F to I the relation seemed to break down completely, as also in the case of the ions H and OH. By means of further data I have found that Cd ranges itself with the metals mentioned, while Ag and Pb rank as further exceptions. In the case of the halogens it was suggested that, as their atoms are heptad as well as monad, we must imagine each halogen to have associated with it four negative electrons and three positive ones. Three of the negative electrons unite with the positive ones when the halogen atom acts as a monad, and so form inside the halogen atom three electric doublets. With a notation which I have proposed this idea would be expressed by writing the following as the formula for the Cl ion: $\text{bCl}((\#)_3)$. In this way we can briefly record the fact that Cl is a monad with heptad capabilities. Now, if the three electric doublets $\#$ inside the halogen ion produce an abnormal effect on the propagation of light through the halogen ion, we shall not be justified in using Maxwell's relation for finding the dielectric capacity from the refractive index. Just as water and a number of similar substances have two limiting dielectric capacities, namely 80 and 2 in the case of water, with every intermediate value for electric alternations of suitable frequency, so it seems to me that the halogen atoms have a dielectric capacity K_1 which is different from N_1^2 for the conditions under which their ionic velocities are measured. Accordingly I propose to use equation (16) for finding the dielectric capacities of the halogen atoms and of atoms in general. By means of the data given on page 175 of the paper mentioned and the assumption that $K_1 = N_1^2$ on the average for the regular ions, the equation becomes one for K_1 in the following form :

$$K_1 = 280\nu/\lambda_0 B^{\frac{1}{3}}, \quad (17)$$

where B is the volume of a gramme-atom of the ion.

The following table contains the values of the ionic velocities given by Kohlrausch except for Cd and Pb, the values of B taken from "Further Studies on Molecular Force" (Phil. Mag. [5] xxxix.), and also the values of K_1 calculated by (17), using for ν the value 1 for the monad atoms and 2

for the dyads. In the last row of the table are given the values of $10K_1B^{\frac{3}{2}}/\nu$, to be discussed immediately.

| | | | | | | | | | |
|--------------------------------|------|------|------|------|------|------|------|------|------|
| | Li. | Na. | K. | Rb. | Cs. | Mg. | Ca. | Sr. | Ba. |
| ${}_1\lambda_0$ | 35.5 | 44.4 | 65.3 | 67.3 | 67.8 | 48 | 53 | 54 | 57.3 |
| B..... | 2 | 7.4 | 18.6 | 34.4 | 56 | 5.6 | 8.6 | 10.6 | 16.6 |
| K_1 | 6.27 | 3.24 | 1.62 | 1.28 | 1.08 | 6.58 | 5.16 | 4.72 | 3.83 |
| $10K_1B^{\frac{3}{2}}/\nu$... | 89 | 88 | 70 | 75 | 81 | 78 | 76 | 77 | 78 |
| | Zn. | Cd. | Ag. | Pb. | F. | Cl. | Br. | I. | |
| ${}_1\lambda_0$ | 47.5 | 52.5 | 55.7 | 57 | 46.1 | 65.9 | 67.5 | 66.7 | |
| B..... | 10.6 | 12.5 | 6.8 | 9.8 | 9 | 19 | 26 | 36 | |
| K_1 | 5.36 | 4.60 | 2.66 | 4.59 | 2.92 | 1.59 | 1.40 | 1.27 | |
| $10K_1B^{\frac{3}{2}}/\nu$... | 87 | 82 | 70 | 72 | 88 | 70 | 71 | 76 | |

In the case of the halogens it is interesting to compare the values of the dielectric capacity thus derived with the values of N_1^2 , thus

| | | | | |
|---------------|------|------|------|------|
| | F. | Cl. | Br. | I. |
| N_1^2 | 1.34 | 2.43 | 2.72 | 3.10 |
| K_1 | 2.92 | 1.59 | 1.40 | 1.27 |

A study of those values shows that in the halogen atoms K_1 , instead of being equal to N_1^2 , varies inversely as N_1^2 .

Returning to the main table, we find that $K_1B^{\frac{3}{2}}/\nu$ is constant without a single marked exception, although the halogens have just been shown to be so exceptional in regard to Maxwell's law. We have therefore this result, that the dielectric capacity of an atom is directly proportional to the valency and inversely proportional to the square root of the volume of the atom. It is interesting to find that valency, which Faraday proved to be of fundamental importance in his electrolytic law, is of similar importance in connexion with dielectric capacity, that predominating electric property of matter which Faraday discovered. As to the physical signification of our law for K_1 , it seems that it may be sought by the following short train of speculation. I have shown that cohesion can be traced to the mutual attractions of the electric doublets in molecules acting like minute magnets. Thus cohesion is an electrical phenomenon. By following out a similar train of reasoning it can be shown that rigidity in solids is a mechanical result of the electric doublets in the molecules. At absolute zero the rigidity is equal to the electric energy of these doublets per unit volume. But to express this electric energy we must regard it as proportional

to the square of an electric quantity associated with the molecule. Thus rigidity is proportional to the square of an electric quantity. Now our law for the dielectric capacity of an atom means that the square of K_1/ν for an atom when multiplied by the volume of the atom is the same for all. It seems, then, as though a certain stock of electric energy associated with the electrons in an atom were the same for all atoms. The law for K_1 , then, seems to be of a similar nature to that of Dulong and Petit and of the fundamental law of molecular physics which makes the kinetic energy of translation of all molecules at a given temperature the same.

But to return from speculation to the immediate bearings of the formula $K_1 B^{\frac{2}{3}}/\nu = \text{constant}$; we find that in (16) it makes the ionic velocity of an atom directly proportional to the sixth root of the volume of the atom—that is to say, to the square root of its radius. This brings out neatly the old paradox about ionic velocities. Hitherto it has been assumed that the ionic velocities have all been measured with the same driving force for all ions. The result that a large ion like that of K travels faster than a small one like that of Li under the same driving force in a resisting medium is, indeed, puzzling until, in taking account of the dielectric capacity of the atom, we see that the driving forces assumed equal are in reality not so at all.

Melbourne, December 1903.

L. *The Crémieu-Pender Discovery.*

By WILLIAM SUTHERLAND*.

IN the experiments carried out by the happy collaboration of Messrs. Crémieu and Pender (Phil. Mag. Oct. 1903) practically the whole of the difficulty in reconciling the apparently contradictory results obtained by Rowland and his pupils and Röntgen, Himstedt, and others on the one hand, and by Crémieu on the other, concerning the magnetic effects of electric convection was traced to the one fact that Crémieu covered his metallic electrified surfaces with solid dielectric. The solid dielectric rotating with the revolving charged metallic disk reduces the magnetic effect considerably, so as in some experiments to make it appear to vanish. The combined experiments have brought into prominence a fundamental property of dielectrics. Now exactly the same property made itself apparent in my theoretical

* Communicated by the Author.

investigation on "Ionization, Ionic Velocities, and Atomic Sizes" (Phil. Mag. Feb. 1902). It was there shown that if a_1 and a_2 are the radii, and K_1 and K_2 the dielectric capacities of the two atoms of a binary electrolyte forming a very dilute solution in water (m gramme-equivalents per litre) of viscosity η and dielectric capacity K_0 the current per cm.² in the solution due to a rate of fall of potential dE/dx is for ionization i

$$C = 10^{-3}mie^2 \frac{K_0}{6\pi\eta} \left(\frac{1}{K_1a_1} + \frac{1}{K_2a_2} \right) \frac{dE}{dx} \dots (9)$$

This expression is derived on the usual supposition that in electrolytic conduction the atom of an ion simply carries its electron from one electrode to the other. But the same reasoning if not supplemented by a further principle would make the work done in carrying an electron e in an atom of dielectric capacity K down a step of potential $E_1 - E_2$ to be $K_0e(E_1 - E_2)/K$, whereas it is in reality $e(E_1 - E_2)$. It was therefore pointed out that the electrolytic current cannot consist solely of the waftage of electrons by atoms. The further principle necessary to make equation (9) consistent with the conservation of energy can be ascertained by considering the following very simple case. A unit charge of electricity is placed inside a very thin slab of dielectric capacity K between two plates at potentials E_1 and E_2 at distance D apart in vacuum and parallel to them. The force acting on the charge is $(E_1 - E_2)/DK$ according to usual electrostatic principles, and the work done in moving the charge inclosed by dielectric of capacity K from the one plate to the other is $(E_1 - E_2)/K$. But, on the contrary, we know that this work must be $E_1 - E_2$. Evidently, then, $(E_1 - E_2)/K$ is not a full determination of the work involved. It gives the work due to a certain displacement of the unit charge relative to the matter of the two plates. But there has been also a displacement of the æther relative to the two plates. If the displacement of the æther is written down as $D(1 - 1/K)$, and the force producing this is taken to be $(E_1 - E_2)/D$, the force anywhere between the two plates except in the dielectric slab, then the work due to æther displacement is $(E_1 - E_2)(1 - 1/K)$, which when added to the work for displacement relative to matter gives the whole work $E_1 - E_2$.

Now the expression $D(1 - 1/K)$ for the displacement of the æther is just what is required by Fresnel's theory that the velocity of the æther in a moving transparent body is

$1 - 1/\mu^2$ of that of the body, whose index of refraction is μ . By Maxwell's law $\mu^2 = K$, and so Fresnel's law makes the velocity of the æther $1 - 1/K$ of that of the transparent dielectric. This formula of Fresnel's is the one verified by Fizeau's experiment with running water, repeated by Michelson and Morley. Thus, then, the phenomenon which presented itself in "Ionization &c." and has just been discussed in a simpler form, turns out to be an electrical case of Fresnel's law. The Crémieu-Pender effect is another case. Consider the rotating charged disk in their experiments. The electricity at any point of the disk takes the velocity v of the disk at that point. The solid dielectric attached to the disk imparts to its æther at that point the velocity $v(1 - 1/K)$. Thus the velocity of the electricity on the disk relative to the æther in the rotating disk is v/K . If, then, this slip v/K of the electricity past the adjacent æther is the cause of the magnetic effect of electric convection, we see why Crémieu's use of solid dielectrics reduced the magnitude of the effects he was investigating. One gathers by implication that Crémieu and Pender are investigating the effect of the dielectric quantitatively. In one quantitative result given (*loc. cit.* p. 460) a magnetic effect measured by 140 when air was the dielectric was reduced to 15 when mica was attached to the metallic surfaces; these are in the ratio of 1 : 9, while the corresponding ratio of v/K with v the same in both cases is the ratio of the dielectric capacity of air to that of mica or 1 : 6.6. As further experimental results are to be expected soon, it will be better to await their appearance before proceeding with the theory that the magnetic effect of electric convection is due to the slip between electricity and æther, and not to the relative motion of electricity and remote æther. Crémieu and Pender have secured evidence of a phenomenon noticed by Himstedt, that beyond a certain density of charge the magnetic effect ceases to be proportional to the density of the moving charge. This will doubtless receive the experimental attention it merits. Meanwhile it may be pointed out that the results calculated from many of the recent experiments on ionic velocities in gases will need to be revised in order to take account of the dielectric capacity of the stuff of the atom, as I have attempted to do in the case of ions moving through water.

Melbourne, January 1904.

LI. *An Electric Thermostat.*
 By HORACE DARWIN, M.A., F.R.S.*

[Plate XXIV.]

THIS thermostat was designed and first constructed as an adjunct to the Spectrograph of the 24-inch Refractor of the Royal Observatory, Cape of Good Hope.

In this case the special object in view is to maintain the prisms and other parts as accurately as possible at a constant temperature, day and night, over a considerable period; the same devices have since been employed in an apparatus constructed for Lord Berkeley, by whose kind permission the thermostat and its adjuncts are now exhibited.

The description which follows relates more particularly to this latter instrument.

The general arrangement of the various parts is indicated diagrammatically in fig. 1 (Pl. XXIV.). A is an oil-bath, well lagged outside, whose temperature has to be maintained as accurately as possible constant at any desired temperature between 10° C. and 80° C. Three vertical tubes A_1 A_2 A_3 are so connected to the bath A that by means of a fan kept rotating within A_2 , a constant circulation of oil is maintained. The oil from the bath enters the tube A_1 near the top, and passes down A_1 , up A_2 , down A_3 , and back into the bath.

Two heating-coils are provided, and one of these, which is placed in the tube A_1 , has a current uninterruptedly flowing through it from the battery of accumulators Q. This may conveniently be termed the permanent heating-coil, the circuit which includes it being called the main circuit. The other heating-coil forms a shunt across the terminals of the battery; it is only traversed intermittently by a current, and is called the intermittent heating-coil, the circuit including it being referred to as the shunt-circuit. By suitably controlling the current passing through the heating-coils, the oil-bath may be maintained at a very nearly constant temperature. For the sake of simplicity we will assume henceforward that the temperature is to be maintained constant at 25° C.

There is a further set of four resistances, two of copper and two of manganin, arranged as a Wheatstone bridge B, and so adjusted that the bridge is only balanced at 25° C. This bridge may be called the controlling-bridge, since it is through its deviations from balance and the consequent deflexions of a galvanometer, that the supply of current to the heating-coils is controlled.

* Communicated by the Physical Society: read November 27, 1903.

The main circuit includes "series-coils" which are situated outside the oil-bath, and whose function is to modify the supply of current to the permanent heating-coil. Intermittently the shunt-circuit is closed, the total heating effect being thus augmented so long as the shunt-circuit is complete. There are three respects in which the operation of the heating-coils may be automatically adjusted. Thus an increase in the heating effect is produced by a more frequent closing of the shunt-circuit, by increasing the duration of each such closing, and by diminishing the resistance which the series-coils interpose in the main circuit.

Suppose now, as a particular case, that the thermostat has been running continuously for a considerable time, the temperature of the atmosphere having been fairly constant meanwhile, so that something approximating to a steady state has been reached: that is to say, though the actual rate of heat production varies abruptly, as often as the shunt-circuit is closed or opened, yet the mean heating effect of the current remains approximately constant from one half hour to another. If a fall now takes place in the temperature of the surroundings, so that there is a greater demand for heat, the necessary readjustment will be effected as follows:—

The increased demand will be immediately met by a more frequent closing of the shunt-circuit (containing the intermittent heating-coil), and the same mechanical movement which produces this more frequent closing of the shunt-circuit will cause the closing to become progressively of longer duration, and will also in time decrease the resistance of the series coils, so that by degrees the closing of the shunt-circuit ceases to be required so frequently.

The controlling-bridge B has one pair of opposite arms of copper, these two arms being immersed in the oil-bath. The remaining arms are of manganin, the connexion to battery and galvanometer being made in the usual way. It is thus evident that if the bridge is balanced at some definite temperature, a change of temperature will disturb the balance; for the product of the resistances of the two copper arms changes rapidly with change of temperature, while the corresponding product for the two manganin arms is practically constant, so that for any determinate adjustment of the bridge, equality of these two products can only obtain when the copper arms are at one particular temperature. By adding to the resistance of one of the manganin arms the temperature of balance is raised; while by adding to the resistance of one of the copper arms it is lowered.

One manganin arm consists of two coils in series, and one

of these can be cut out at will by means of a mercury key. By setting over this key, the temperature at which the bridge is balanced is lowered 40° C. By the action of a similar key cutting out a coil in one of the copper arms, the temperature of balance is raised 20° . The four combinations of the positions of these two keys give a range of 60° by steps of 20° . Intermediate settings are made by means of a compound slide-wire whose total effective range corresponds to about 22° . This compound slide-wire consists of the slide-wire proper with a range of about 7° and three coils with a range of 5° each. If these three coils are called a , b , c , respectively, while the slide-wire is called s , then we have a , b , c and s , always joined in series between the points $B_1 B_2$ in fig. 1, while a special switch, which can be set in four positions, enables the order of the resistances between these two points to be made a, b, c, s ; b, c, s, a ; c, s, a, b ; or s, a, b, c , at pleasure.

The main circuit includes in series with the permanent heating-coil, some or all of the series-coils F . The current is led to the rail N , from which it passes, by way of the slider W , to one or other of the blocks L , according to the position of W . Thus it is evident from fig. 1 that the resistance offered by the series-coils included in the main circuit may vary, and the amount it varies is from 0 to 30 ohms.

The galvanometer G is of the suspended coil type, a long boom G_1 being secured at right angles to the axis of the coil, so as to swing in a horizontal plane whenever the deflexion of the galvanometer varies. The connexions are so arranged, that when the temperature of the copper arms of the controlling-bridge B rises above its normal value (assumed as above to be 25° C.), the galvanometer-boom is deflected "upwards" in the diagram, a fall below the normal temperature causing a deflexion "downwards." The sleeve X is kept steadily rotating on a fixed shaft S by means of a small worm-gear M driven from shafting. The direction of rotation is such that points above the axis are carried towards the reader in fig. 1. The cam C performs a variety of functions; it is rigidly connected to the sleeve X , and is thus capable of displacement endwise with respect to the fixed shaft S . A helically bounded cylindrical segment D (called the shunt-circuit drum) is rigidly connected with the cam C , so that these two pieces rotate with the sleeve X , while a contact-piece W (called the slider) agrees with it in endwise displacement. The rocking-shaft R carries the hit-or-miss arm H , and the shunt-circuit brush J , both of which are made fast upon it, so that they always move together about the axis of the rocking-shaft R , while they are incapable

of endwise displacement. The hit-or-miss arm H has a comb K attached to it crosswise, the teeth of the comb being disposed downwards, and the throats between them serving to engage with the cam C , as occasion arises. The outer end of the hit-or-miss arm H carries an ebonite sector H_1 (fig. 1).

In considering the action of the cam we will confine our attention for a moment to one of its functions, that, namely, of causing the hit-or-miss arm H to rise and fall again for each revolution of the sleeve X . This action of the cam is of course due to its radius (reckoned from the axis of the shaft S) being variable (fig. 2). The sector of larger radius is called C_1 , being uppermost at the instant when our observation commences, the hit-or-miss arm H is raised to its fullest extent, and the ebonite sector H_1 is lifted clear of the galvanometer-boom; after some seconds, the rotation of the sleeve X brings the sector C_2 uppermost, so that the hit-or-miss arm H is left free to fall until its descent is arrested. The extent of the fall permitted to the arm H depends upon the position of the galvanometer-boom G_1 at the time being.

(a) If the oil immediately surrounding the copper arms of the bridge B is slightly too cold, the boom is deflected in the direction marked "cold" in the diagram, so that the ebonite sector H_1 clears the boom, and allows the arm H to come down as far as a stop-screw, thus attaining its lowest position. At the same time the shunt-circuit brush J , in virtue of its attachment to the same rocking-shaft R , as the arm H , has likewise reached its lowest position, in which it can make contact with the drum D , as soon as the latter has turned a little further. The contact thus established causes a current to flow in the intermittent heating-coil until the cylindrical sector D has passed the shunt-circuit brush J , shortly after which the sector C_1 of the cam comes under the comb K , and once more lifts the arm H and the brush J to their highest position.

(b) On the other hand, if the temperature of the oil surrounding the copper arms of the bridge B is slightly too high, the boom G_1 is deflected in the direction marked "hot," and as the cam C leaves the arm H free to descend, the ebonite sector H_1 is arrested upon the boom G_1 , so that the arm H and the shunt-circuit brush J do not reach so low a position as in the alternative case just considered; it results from this that no contact is established between the brush J and the drum D , no current being allowed to flow through the intermittent heating-coil.

The sequence of operations just described would of itself be sufficient to ensure a fairly constant temperature in the

oil-bath ; any one revolution of the sleeve X being accompanied or unaccompanied by a closing of the shunt-circuit according as the temperature of the copper arms of the bridge B was too low or too high.

In order to make the regulation less spasmodic than it would be under such conditions, two further adjustments are introduced. In the first place, the series-coils included in the main circuit are automatically * diminished in resistance as the demand for heating becomes heavier, and *vice versa* ; and in the second place, the time during which the circuit is closed is made to bear a greater or a less proportion to the period of revolution of the sleeve X, as the case may be. If diminished resistance in the series-coils and increased duration of short-circuiting are required, it is evident that both of these results may be accomplished by displacing the drum D and slider W along the spindle towards the right in fig. 1. This, of course, implies an equal displacement of the cam C, since C, D, and W are all connected axially. It is, in fact, by means of the cam C that the displacement is effected. The cam acts both radially and axially, its radial action causing the rise and fall of the comb K, and consequently of the hit-or-miss arm H ; while by its axial action, the cam itself, together with the drum D and slider W, is displaced endwise along the spindle S. The general form of the cam C is best seen in fig. 2 ; the view being that which is obtained by looking along the shaft S from right-hand side in fig. 1. In this figure the measurements indicated in millimetres are the distances of the corresponding points of the periphery from the principal plane of the cam, that distance being marked + which is towards the observer, and *vice versa*. To make the action of the cam more readily comprehensible, the distinctive features of the two sectors are here set out in parallel columns.

Sector C₁.

Has a larger radius.
Is left-handedly helical, and so traverses the cam, drum and slider towards the left in fig. 1.
Has a throw of 4 mm.
Operates at every revolution of the sleeve X.

Sector C₂.

Has a smaller radius.
Is right-handedly helical, and so traverses the cam, drum and slider towards the right in fig. 1.
Has a throw of 8 mm.
Operates only when the hit-or-miss arm has missed the boom G₁.

It should further be observed that when the sector C₁ comes under the comb K, whether the arm H is up to that moment resting at the lower level upon the stop-screw, or at

* The device for automatically varying the external resistance of the heating circuit, namely, the slider W and resistance-blocks L, was suggested by Mr. Lunt, of the Royal Observatory, Cape of Good Hope.

the higher level upon the boom G_1 , the effect of the sector C_1 will be to raise the arm H clear of the boom G_1 , leaving the latter free to take up its equilibrium position under the influence of such small current as may then be traversing the galvanometer-coil, owing to want of balance of the controlling-bridge; thus determining the greater or less descent of the arm H, after the sector C_1 has passed from under the comb K, as already explained. As regards the displacement of the cam C, together with the drum D and slider W, along the axis of the shaft S; it is apparent from the foregoing paragraph, that for *every* revolution of the spindle a displacement of 4 mm. to the left occurs, while a displacement of 8 mm. to the right occurs only for those revolutions in which the arm H misses the boom G_1 . Thus it follows that when the hit-or-miss arm H just hits the boom G_1 as often as it misses, the cam, drum and slider will only suffer small axial displacements on either side of a mean position, but on the whole will be without progressive axial motion. On the other hand, if the demand for heating current is greater than can be met by a steady average of one hit to one miss (that is to say, by one short-circuiting of the series-coils for two complete revolutions of the sleeve X), the galvanometer-boom G_1 will be more often deflected to the "cold" side than to the "hot" side, and the misses will preponderate over the hits. In consequence of this, the sector C_2 of the cam will operate more often than an average of once in every two revolutions of the sleeve X, and so the displacement of 8 mm. to the right will occur on the whole more than half as often as the displacement of 4 mm. to the left. The result will be a progressive displacement to the right, causing a wider part of the brass sector D to come under the brush J, so that each short-circuiting is of longer duration, and perhaps also causing the slider W to move from one of the blocks L to another, thus reducing the resistance interposed by the series-coils F in the main circuit. These effects will diminish the demand for such frequent short-circuiting of the series-coils; and finally, when the displacement of cam, drum and slider has been carried to such a point, that on an average the arm H hits the boom G_1 as frequently as it misses, there will be no further displacement of the cam, drum and slider, which will now execute small excursions on either side of a mean position as before. Quite similarly, a reduced demand for heating current will cause the hits to become more frequent than the misses and to remain so until a sufficient displacement of the cam, drum, and slider in the negative direction has been effected, when the hits and misses will once more occur with equal frequency on the whole.

A special feature in the design of the cam C relates to those cases in which the temperature of the controlling-bridge is from any cause persistently too high or (as in starting "all cold") persistently too low. It is essential that in such circumstances the cam should neither become jammed at the end of its run, thus stopping the whole mechanism, nor lose touch with the comb K, so as to fail in operation when the adjustment of temperature has improved. The form given to the cam, and shown in fig. 2, secures this result. It should be mentioned that the comb K on either side of the toothing is cleared away to the level of the throats between the teeth.

I wish to thank Mr. C. Young for the great help he gave me in the design of the instruments. Dr. C. V. Burton has also given me great assistance in writing this paper.

LII. *Notices respecting New Books.*

Die Dissoziierung und Umwandlung Chemischer Atome. Von Dr. JOHANNES STARK, Privatdozent an der Universität Göttingen. Braunschweig: F. Vieweg und Sohn. 1903. Pp. viii+57.

THE author of this pamphlet has performed a very useful service in rendering accessible to a wide circle of readers the main outlines and present position of a problem which must be regarded as one of the most fascinating ever presented to the man of science—a problem whose vast significance was first seriously thrust on the attention of the scientific public by the epoch-making discoveries connected with that most mysterious element—radium. After explaining the principle of electrolytic dissociation and its application to the theory of conduction in gases, electrolytes, and metals, the author gives an account of Rutherford and Soddy's investigations on the cause and nature of radioactivity, and the evidence in favour of the view that the last link in the chain of transformations going on in radium consists of helium. A most useful appendix contains, in addition to various supplementary explanations, numerous references to the literature of the subject.

LIII. *Proceedings of Learned Societies.*

GEOLOGICAL SOCIETY.

[Continued from p. 314.]

February 24th, 1904.—J. E. Marr, Sc.D., F.R.S., President, in the Chair.

THE following communications were read:—

1. 'Eocene and Later Formations surrounding the Dardanelles.' By Lieut.-Col. Thomas English, late R.E., F.G.S.

Our present knowledge of the older rocks, upon which the Tertiary beds surrounding the Dardanelles rest, only suffices to indicate the positions of the outcrops of a succession of schists, crystalline limestones, granites, and serpentines, which can be traced from the

Ægean district into the Marmora, where they formed an archipelago in the Eocene Sea.

The Eocene deposits surrounding these old rocks commence with sandstones, conglomerates, and clays, which become calcareous and nummulitic upward, and are about 2000 feet thick in the aggregate. They are succeeded by 3000 feet of lacustrine sandstones, clays, and schists, interstratified with volcanic rocks, and containing coal-seams. These beds have yielded *Anthracotherium*, plant-remains, and *Corbicula semistriata* at the coal-horizon, which is near the middle of the series. They are widely spread in Southern Thrace, and are cut off to the eastward by the falling-in of the Marmora sea-bed. The author has traced them along the Gallipoli Peninsula to Imbros Island,—Lemnos and Samothrake are partly composed of similar beds; and he considers that all these deposits represent the uppermost Eocene and the Oligocene, and that the coal-seams belong to the latter.

The folding of the Lower Tertiary strata is plainly marked, and prolongs the direction of the Greek 'flysch'-deposits into the Marmora, forming basins in which the Miocene beds accumulated.

There are three main folds, all passing east-north-eastward through the Eocene channel between the old rocks of Thrace and those of the Troad. The central fold developed farther eastward in post-Sarmatic times, rising into a ridge at Dohan Aslan, which dammed the outlet for the Marmora water to the west, and was the proximate cause of the formation of the Bosphorus in the Pontic Period, and of the Dardanelles at the end of the Pliocene. Volcanic eruptions were prolonged from Cretaceous to Miocene times in Thrace, Imbros, Lemnos, and Mitylene. Strati Island is entirely volcanic, and the greater part of Imbros also.

Marine Miocene (Helvetian to Tortonian) deposits appear north of the Gulf of Xeros and in the Marmora, and are probably vestiges of a Lower Miocene sea-connection between the Ponto-Caspian and the Mediterranean.

Sarmatic deposits, first freshwater, then marine, result from the development of a lake, with a narrow opening north-eastward to the Pontic area, which occupied a large portion of the district. The freshwater beds are still nearly horizontal in the Dardanelles, but are much dislocated along the northern shore of the Sea of Marmora, where they contain naphtha and lignite. The overlying marine (*Mastra*) limestones fringe the freshwater beds as a shore-belt for 30 miles along this coast, and extend through the Dardanelles to the Southern Troad.

Brackish and freshwater Pontic strata occur in numerous detached lake-basins which drained north-eastward. The Bosphorus was probably cut by river-action through the rim of the lowest of these basins, on the recession of the Sarmatic Sea, and the Ægean drainage then passed into the large, closed, brackish lake described by Andrussov as occupying the Black-Sea area from the Pontic to the beginning of the Diluvial Period.

The water-line of this sea-lake finally receded to nearly 200 feet below its present shore-line, when the Sea of Marmora stood about 80 feet higher. Then the water began to rise again during the

Pliocene, the Sea of Marmora regained its former westerly extension to Gallipoli, and deposited the bed of Caspian shells on which that town is built.

The lacustrine beach at Hora, 130 feet above sea-level, commemorates the last high-water mark of the Ponto-Caspian closed basin. The Ægean land, had, meanwhile settled down, forming a large depressed area, probably bounded to the south by the chain of the Northern Cyclades, and the Sarmatic beds dipped westward, reversing the drainage of the country south-west from Gallipoli. When the watershed of a river occupying the Dardanelles Valley was worn down to the level of the Marmora, in early Pleistocene times, the channel was rapidly widened and deepened to its present section by the outflow of Pontic water. The Mediterranean also passed the barrier of the Cyclades during the Pleistocene Period, and when equilibrium was restored, the water in the Sea of Marmora stood somewhere near its present level. There have been various oscillations since, of which the positive changes of level are indicated by Pleistocene Mediterranean deposits, at Samothrake up to 650 feet, and a raised beach at Hora at 400 feet, also by numerous shell-banks and terraces up to 100 feet above the present sea-level. There is, moreover, abundant evidence of a rise to 1000 feet during or after the Glacial Period, by which a red stony clay, formed at the expense of the surface-soil of a land-area, has been widely spread.

2. 'The Derby Earthquakes of March 24th and May 3rd, 1903.'
By Dr. Charles Davison, F.G.S.

The undoubted earthquakes of this series were four in number. The first and strongest occurred on March 24th, 1903, at 1.30 P.M., and was felt over an area of about 12,000 square miles, its centre coinciding with the village of Kniveton, near Ashbourne. The shock consisted of two distinct parts, separated by an interval of about 3 seconds, which coalesced, however, within a narrow rectilinear band running centrally across the disturbed area at right angles to the longer axes of the isoseismal lines. The isoseismal lines (or lines of equal sound-audibility) are very elongated curves, distorted along the rectilinear band. The earthquake, it is concluded, was caused by simultaneous slips within two detached foci situated along a fault-surface running from north 33° east to south 33° west, hading to the north-west, and passing close to the village of Hognaston. The strongest after-shock occurred on May 3rd, its focus lying along the same fault, for the most part between the two foci of the principal earthquake, but much nearer the surface.

Observations of the principal earthquake were made in many of the mines near the epicentral district. The sound, in such cases, was a much more prominent feature than the shock; it appeared to travel through the overlying strata, and in one pit in which observations were made in four seams at different depths, it was more distinctly audible in the lower than in the shallower seams.

The principal earthquake was registered by an Omori horizontal pendulum at Birmingham, by a Milne seismograph at Bidston (near Birkenhead), and by a Wiechert pendulum at Göttingen (502 miles from the epicentre). The larger waves travelled with a velocity of 2.9 kilometres per second.

FIG. 3.

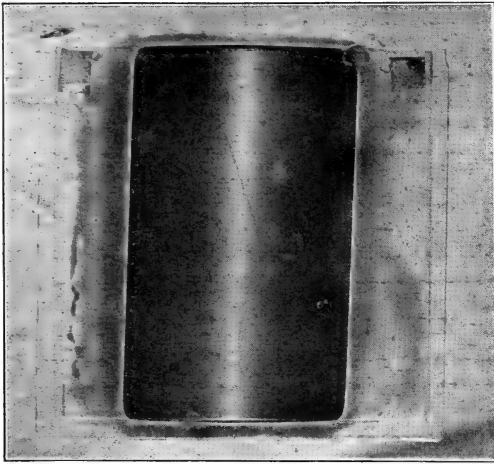

Cylindrical lens lying on a plane with fuchsin-glycerine solution between them. (Transmitted light.)

FIG. 4.

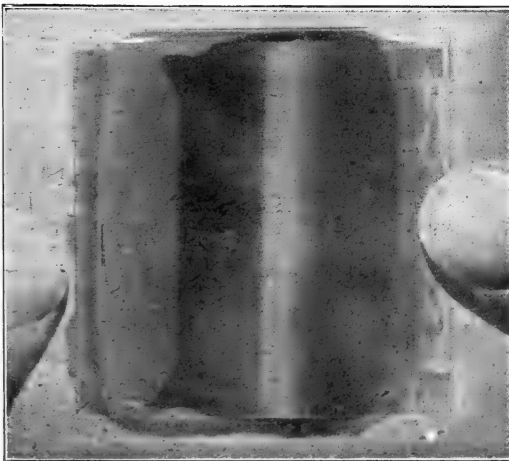

The same lens being rolled from left to right.
(Transmitted and reflected light.)

FIG. 6.

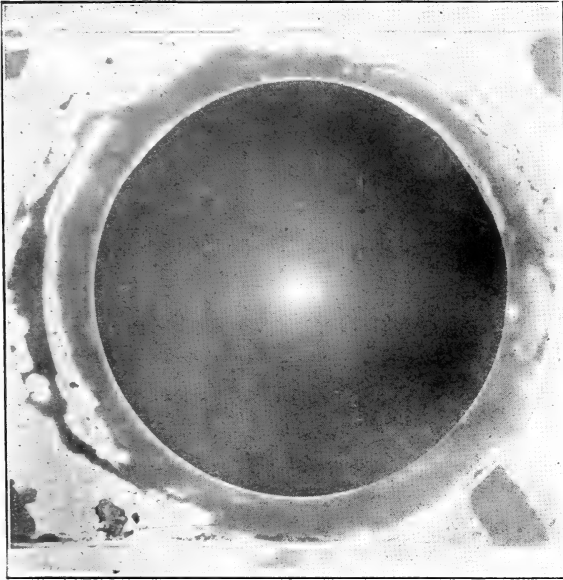

Convex lens lying on a plane with fuchsin-glycerine solution between them. (Transmitted light.)

FIG. 7.

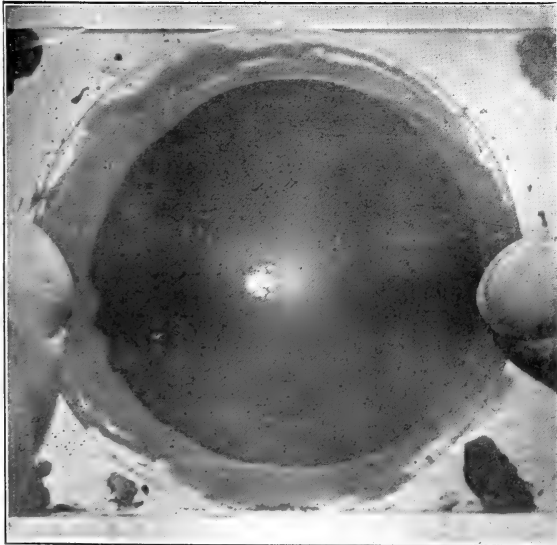

The same lens being rolled. (Transmitted and reflected light.)

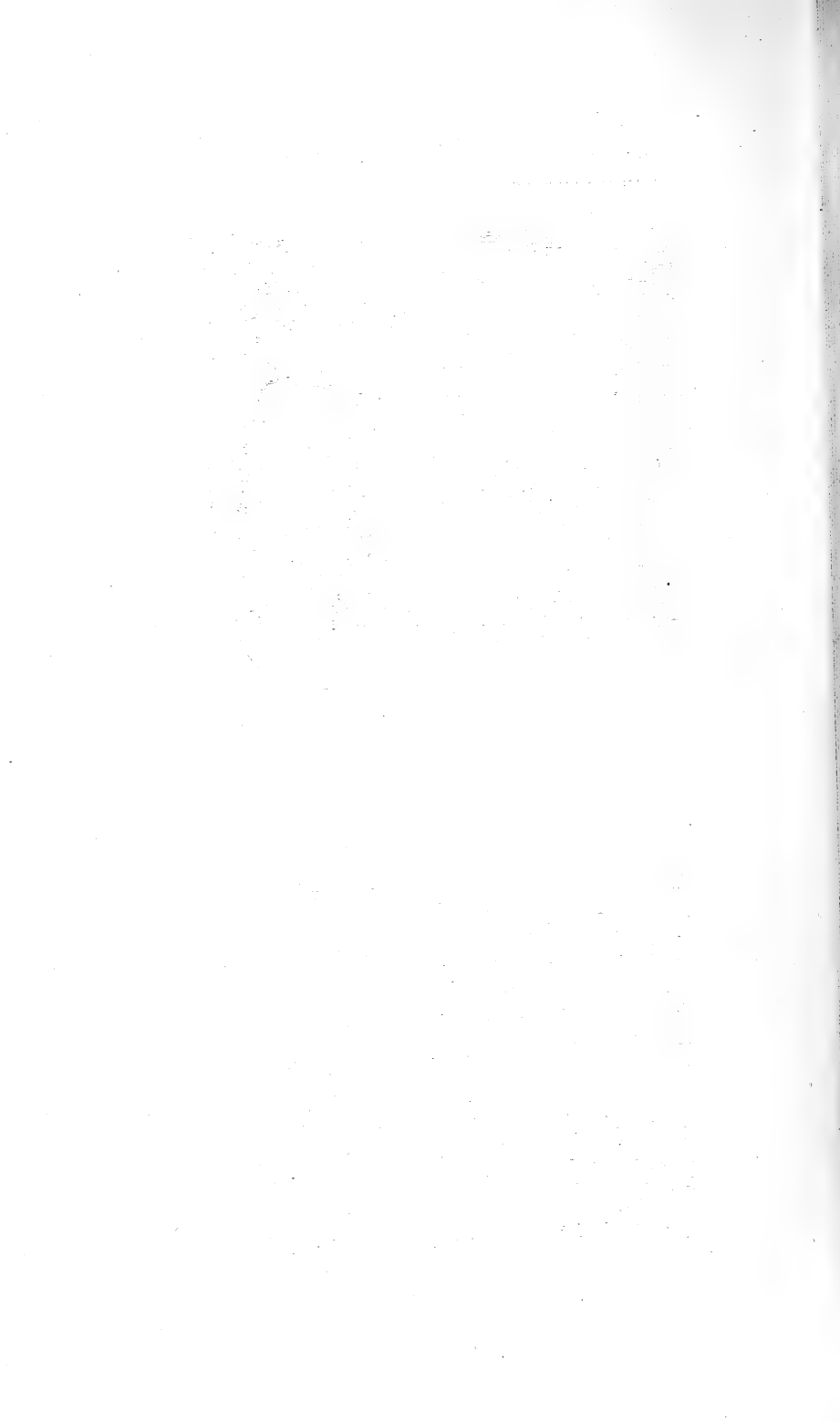
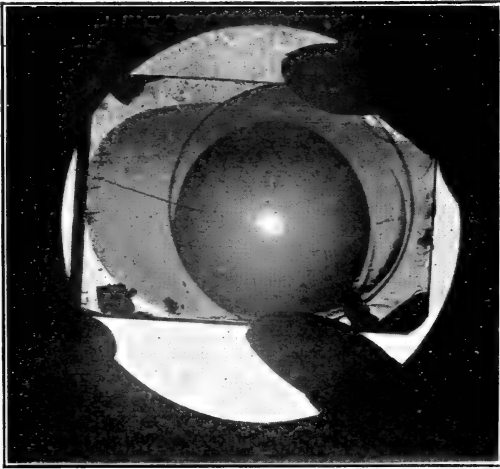
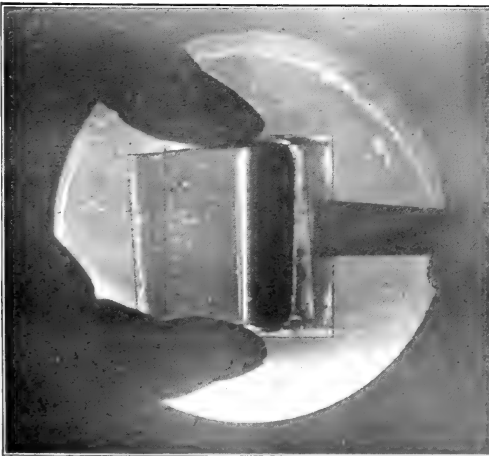

FIG. 8.



A lens being drawn along a plane from left to right.
(Transmitted light.)

FIG. 9.



Biprism lying on a plane with fuchsin-glycerine solution between them
The biprism is being pushed from left to right.
(Transmitted light.)

1870

1871

1872

1873

FIG. 1.

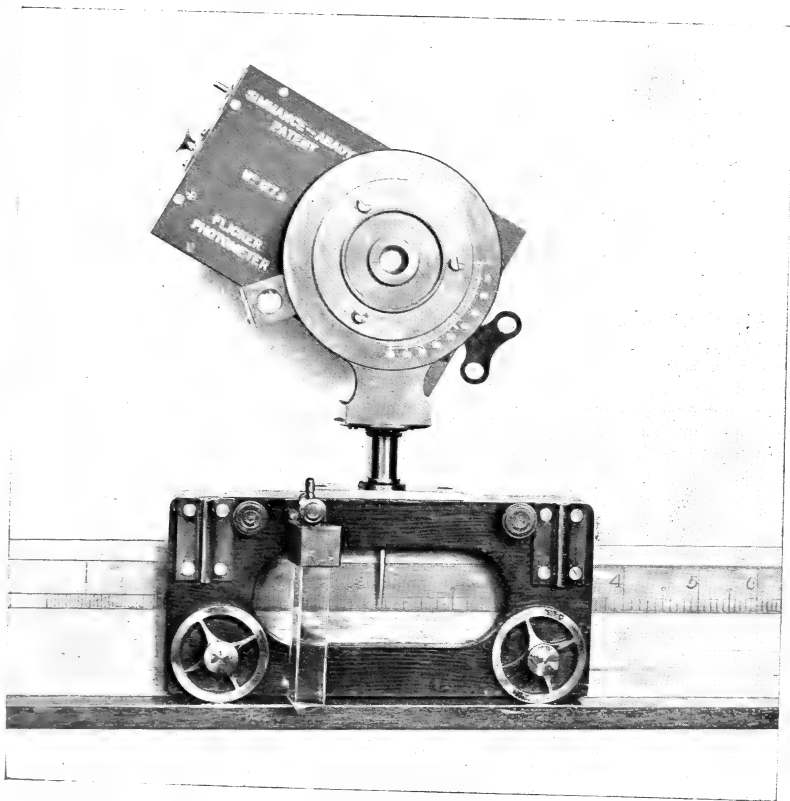

SIMMANCE-ABADY PHOTOMETER (Angle-form)

FIG. 2.

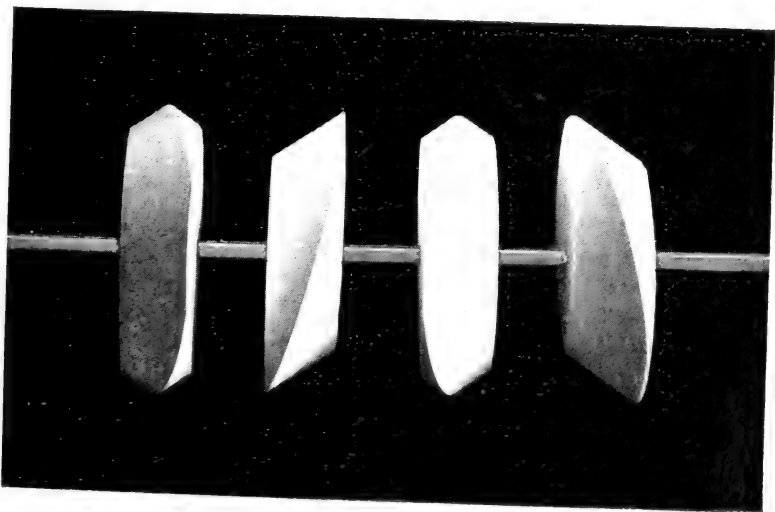

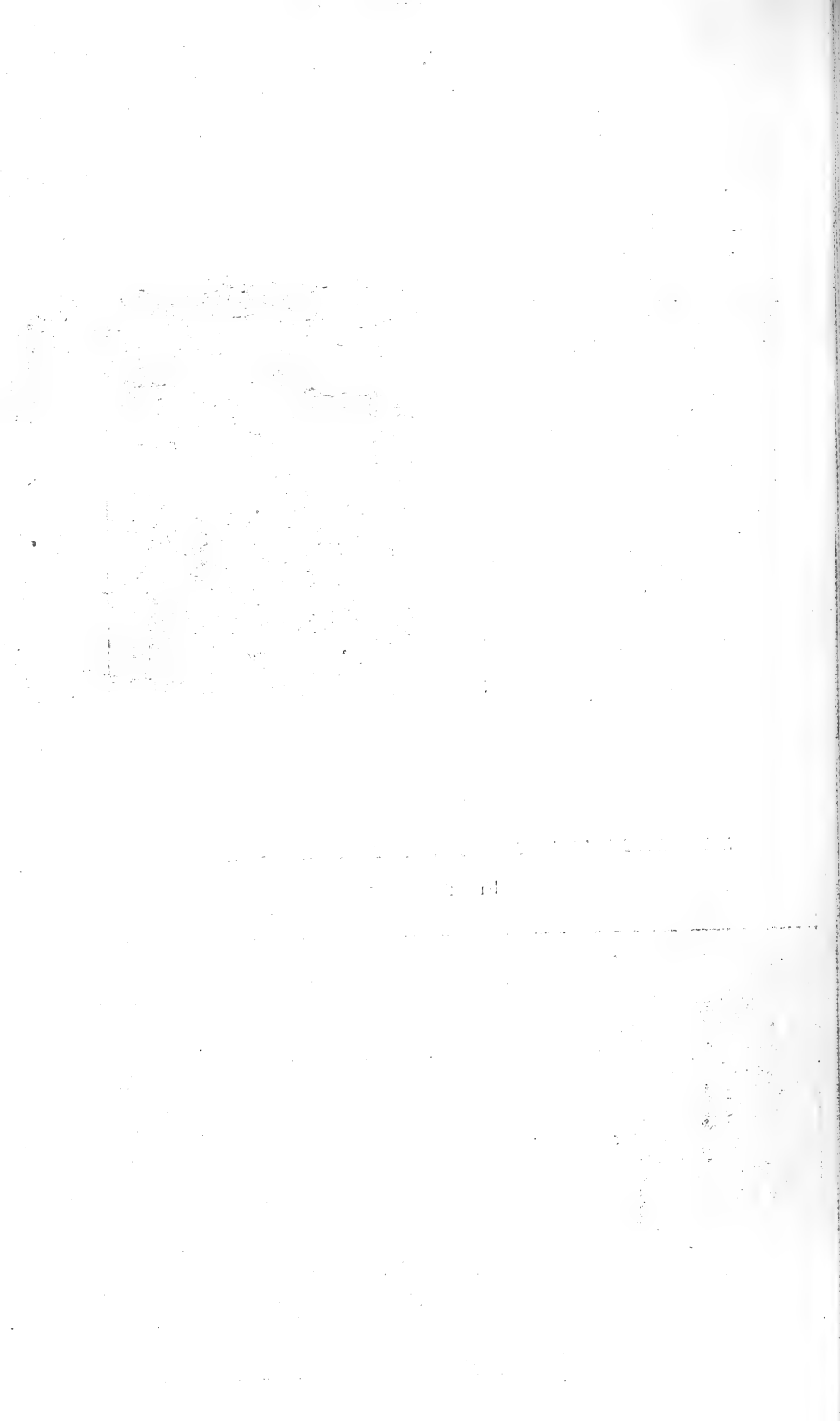

FIG. 1.

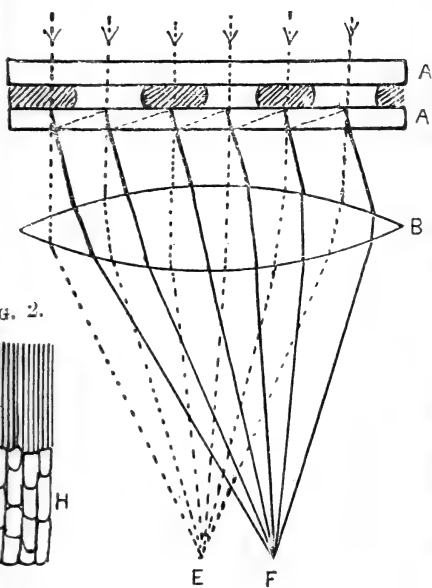
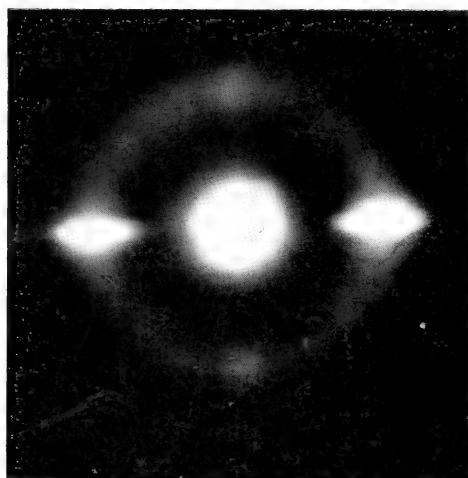
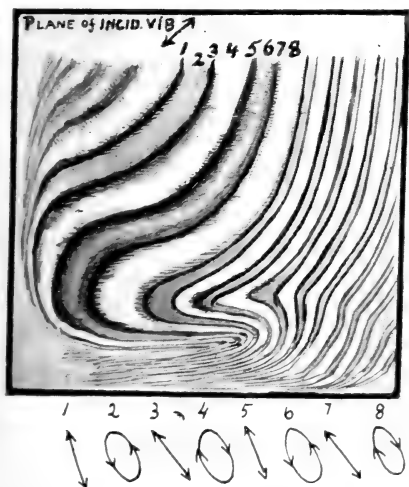

FIG. 3.



Diffraction "Parhelia."

FIG. 4.



State of Polarization along the fringes.

FIG. 5.

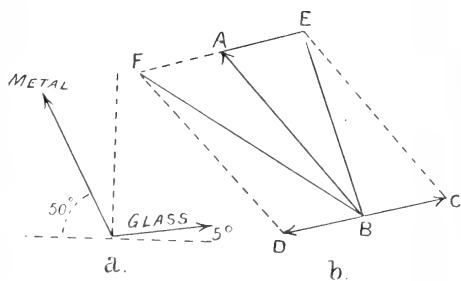

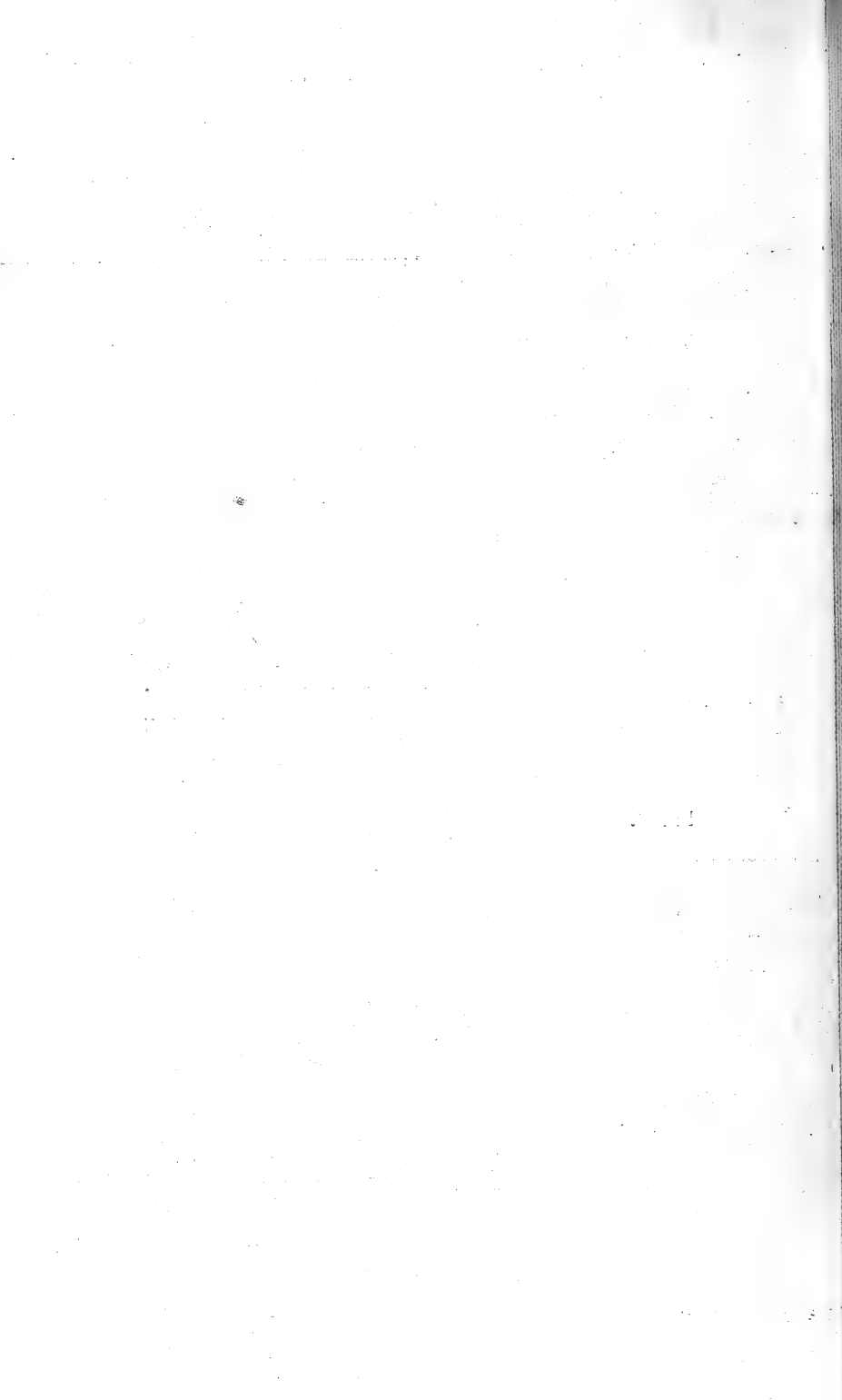

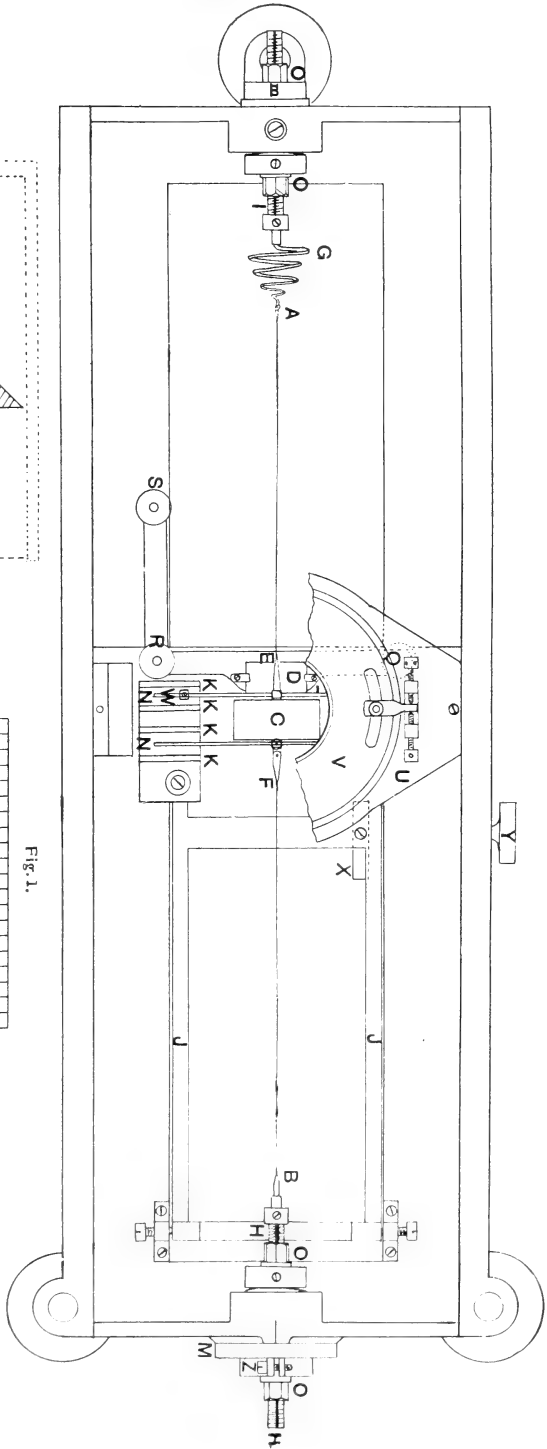

FIG. 1.
0 1 2 3 4 5 6 7 8 9 10 cm.

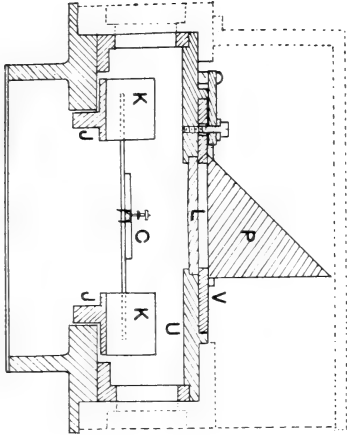

FIG. 2.

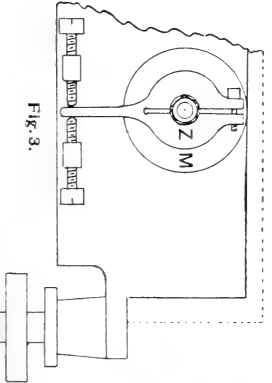

FIG. 3.

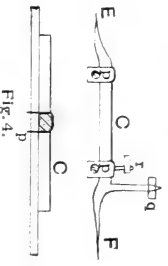

FIG. 4.



FIG. 5.

[The following text is extremely faint and largely illegible due to the quality of the scan. It appears to be a multi-column document, possibly a ledger or a list of entries. The text is organized into columns and rows, with some lines appearing to be headers or section dividers. The content is too light to transcribe accurately.]

[The right edge of the page shows a dark, textured border, likely the edge of the book or the binding of the document. There is no legible text in this area.]

FIG. 6.

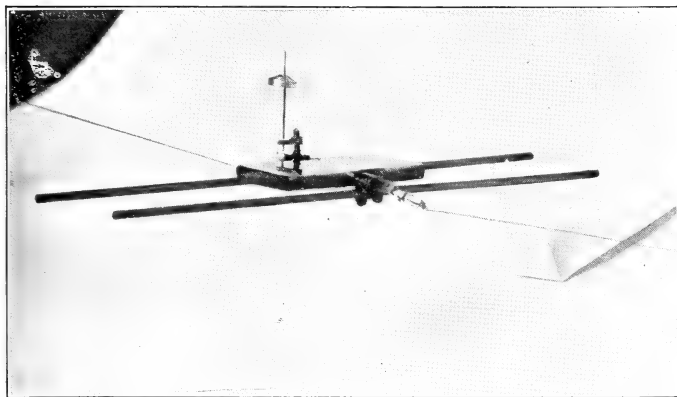
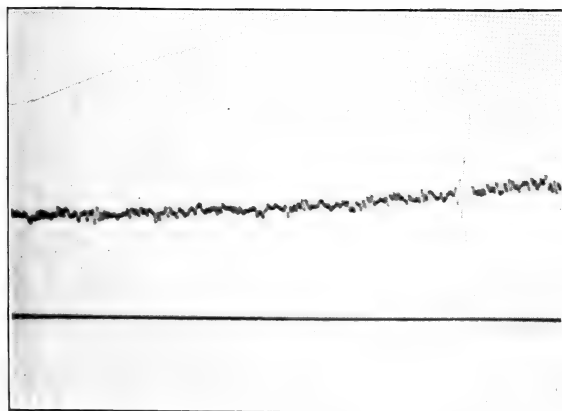

FIG. 7.



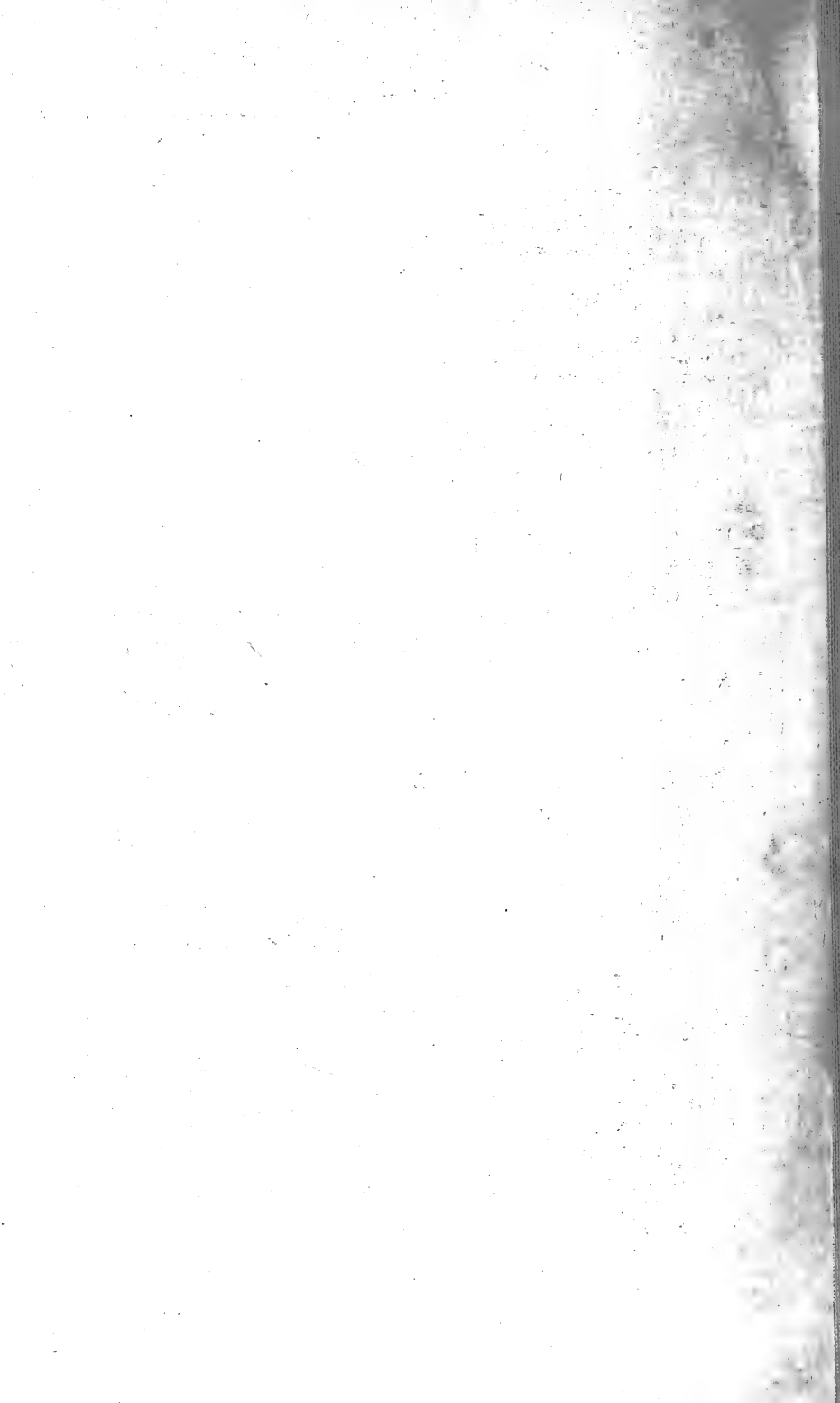

FIG. 1.

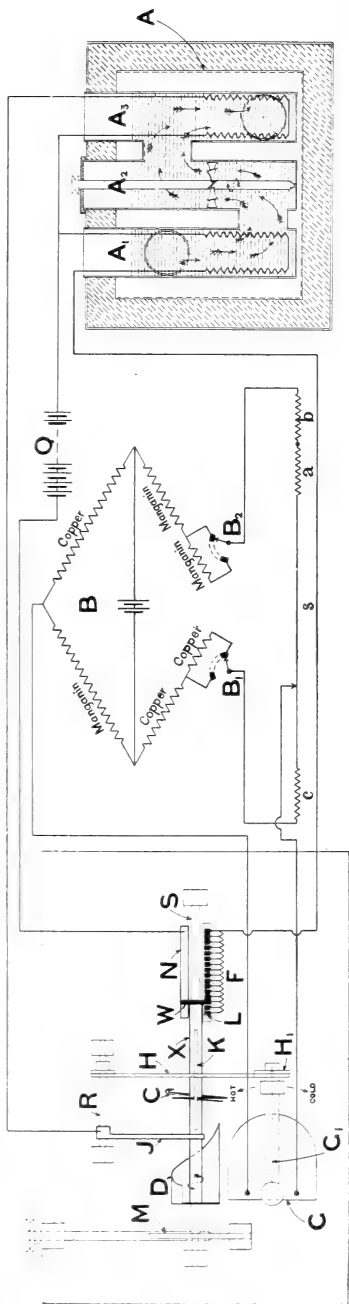
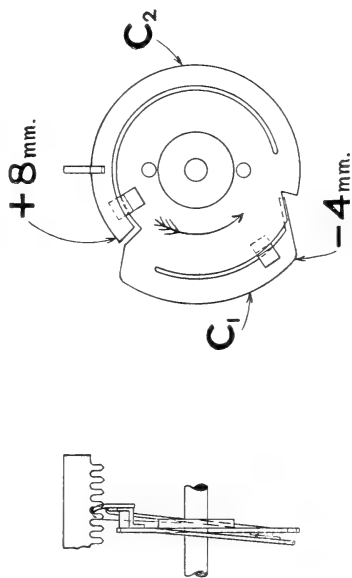

FIG. 2.





INDEXED.

THE

LONDON, EDINBURGH, AND DUBLIN

PHILOSOPHICAL MAGAZINE

AND

JOURNAL OF SCIENCE.

[SIXTH SERIES.]

MAY 1904.



LIV. *The Electric Origin of Rigidity and Consequences*
By WILLIAM SUTHERLAND*.

IN "A Kinetic Theory of Solids" (Phil. Mag. [5] xxxii.) it was stated that a certain formula almost demonstrated the kinetic origin of rigidity. This formula for the rigidity n of a metal of melting-point T at temperature θ , the rigidity at absolute zero being N , was

$$\frac{n}{N} = 1 - \left(\frac{\theta}{T}\right)^2 \dots \dots \dots (1)$$

Further inquiry on the lines of "The Electric Origin of Molecular Attraction" (Phil. Mag. [6] iv.) has led me to amend the above statement to the following form:—The variation of rigidity with temperature is a simple kinetic phenomenon. It will now be shown that rigidity at absolute zero is a purely electrostatic affair, and certain immediate consequences of this fact will be worked out according to the following table of contents:—

1. The Electric Origin of Rigidity.
2. The consequent nature of Atomic Vibration.
3. The division of Molecular Electric Energy into Electrostatic and Electrokinetic as shown by the temperature variation of rigidity in metals.
4. The Electric Gyrostatic Property in Molecules and its part in Metallic Conduction. Theory of Electric and Thermal Conductivity in Metals.

* Communicated by the Author.

5. Contact Difference of Potential, and Mechanism of the Storage of Chemical Potential Energy in the Æther.

6. The Neutron Structure of the Æther used for calculation of its Density and Rigidity, with deduction of the Velocity of Light.

1. *The Electric Origin of Rigidity.*

The simplest way of showing the electrostatic origin of rigidity is the following. Equation (16) of "A Kinetic Theory of Solids" gives us that

$$21N\delta M/JcM = 4.6, \quad \dots \quad (2)$$

where b is the coefficient of linear expansion, M the atomic mass, that of hydrogen being 1, c the specific heat, ρ the density, and J the mechanical equivalent of heat. By means of the experimental data this was shown to be approximately true for twelve metals, while Zn and Cd give a value almost double the 4.6. In my various papers on molecular force the characteristic parameter of molecular attraction for many substances is tabulated under the heading M^{2l} , in which M is the molecular mass and l is $2/3$ of the virial parameter for unit mass of the substance. With the inverse fourth power for the law of molecular attraction lp gives the potential energy of unit mass of the substance at density ρ . But as molecular attraction is not directly dependent on molecular mass, it is better to treat M^{2l} as a single parameter independent of M . Now in "Further Studies on Molecular Force" (Phil. Mag. [5] xxxix.) equation (7) is

$$M^{2l} = .61J(M/\rho)/b. \quad \dots \quad (3)$$

By the law of Dulong and Petit cM has the mean value 6.4, thus (2) and (3) give

$$N = 2.3 \frac{M^{2l}}{(M/\rho)^2} \dots \quad (4)$$

Now if m is the actual mass of a molecule it may replace M in (4). But in "The Electric Origin of Molecular Attraction" it was shown that m^{2l} stands for e^2s^2 , where e is the electron charge and s is the distance between the positive and negative electrons forming the electric doublets which cause molecular attraction. These electrons can be denoted by $\#$ and \flat .

If the dielectric capacity of the medium is K instead of 1, $m^{2l} = e^2s^2/K$. In molecules containing more than one atom $\#$ and \flat are the Helmholtz valency charges and the ionic charges of electrolytes. But in metals each monatomic

molecule must contain \sharp and \flat to form the doublet which gives cohesion. This is the most important characteristic of the molecules in metals, that each atom contains in itself both \sharp and \flat . This conception is fundamental in the present theory, especially in section 5.

Equation (4) becomes

$$N = \frac{2.3}{K} \frac{e^2 s^2}{(m/\rho)^2} \dots \dots \dots (5)$$

This shows the electric origin of rigidity, but it needs interpreting. Consider the electric doublets in a metal at absolute zero so arranged that their charges form alternate plane laminae of positive and negative electricity of surface-density σ . The average electric force between the laminae must be $4\pi\sigma/K$; and according to Maxwell's view the energy in unit volume of the dielectric is $\frac{1}{2}\sigma \cdot 4\pi\sigma/K$. To make our laminar distribution correspond with the charges of the electric doublet we must have $\sigma = e/(m/\rho)^{\frac{2}{3}}$; and, moreover, to give the properties of a homogeneous body we should use three laminar distributions at right angles to one another, such that each would give one-third of the energy due to the doublets in the actual body which they represent. Thus, then, the electrostatic energy per unit volume due to the components of the doublets in any one direction can be written

$$\frac{2\pi}{3K} \cdot \frac{e^2(m/\rho)^{\frac{2}{3}}}{(m/\rho)^2} = \frac{2.1}{K} \cdot \frac{e^2(m/\rho)^{\frac{2}{3}}}{(m/\rho)^2} \dots \dots (6)$$

This becomes identical with (5) if $s = (m/\rho)^{\frac{1}{3}}$, a result which would make it appear that in the monatomic molecules of metals the two electrons \sharp and \flat are on the surface of the atom at the ends of a diameter. With this result it is possible, by means of the values for M^2l for the metals given in Table xxix. of "Further Studies" and by the equation $m^2l = e^2s^2/K$, to obtain values of K the mean dielectric capacity of the metals, but we cannot at present follow this side track. We must now show how the rigidity at absolute zero and the electrostatic energy of the doublets resolved in any one direction are identical.

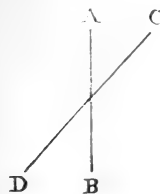

Consider two electrons \sharp and \flat of amount e at distance r apart in the positions A and B. Subject them to a small shear of amount u indicated by the displacements AC and BD each equal to $ur/2$ at right angles to AB.

The electrical work done is $d(e^2/rK) = -e^2dr/r^2K$. But $dr = u^2r/2$, and therefore the work done

is equal to half the square of the shear multiplied by the original electric energy e^2/rK . Thus the rigidity of a pair of electrons is their electrostatic energy. To obtain a simple dynamical representation of a metal we may use the fiction of three laminar distributions, and then, by the definition of rigidity and Maxwell's expression $2\pi\sigma^2/K$ for the energy in unit volume of a dielectric, we get by a similar argument to that just used for a pair of electrons the result

$$N = \frac{2\pi}{3K} \cdot \frac{e^2(m/\rho)^{\frac{2}{3}}}{(m/\rho)^2} \dots \dots \dots (7)$$

This demonstrates the electric origin of rigidity at absolute zero. At higher temperatures kinetic effects have to be taken into account as well as the static. Rigidity is of electrostatic origin, but its variation with temperature is a simple kinetic phenomenon. I find (*Physical Review*, x. 1900) that R. A. Fessenden, in America, for some time has been advocating the electric origin of cohesion and rigidity, though in spite of considerable insight and imagination he has not, to my knowledge, formulated his ideas with sufficient precision for a working physical theory.

Reinganum, who has investigated the electric origin of cohesion (*Physikalische Zeitschrift*, 1900, *Ann. der Ph.* [4] x. 1903), has, in the second of these papers, considered the tensile strength of metals in a general way without special attention to rigidity.

2. *The Consequent Nature of Atomic Vibration.*

In section 6 of "The Cause of the Structure of Spectra" (*Phil. Mag.* [6] ii.) the mechanical period of vibration of an atom of metal was calculated in the following way. N the rigidity of the metal at absolute zero must be the rigidity of its monatomic molecule. The velocity of propagation of a shearing stress through the atom must be $(N/\rho)^{\frac{1}{2}}$. But as $N = 2\pi\sigma^2/3K$, this takes the form $\sigma(2\pi/3\rho K)^{\frac{1}{2}}$. Since the linear dimension of the atom is $(m/\rho)^{\frac{1}{3}}$ or $2a$, the period of vibration of the atom is

$$2a/\sigma(2\pi/3\rho K)^{\frac{1}{2}} \dots \dots \dots (8)$$

On account of the electric origin of rigidity, the period of mechanical vibration is expressed in terms of the electric properties of the atom. Accordingly, without the intervention of the idea of rigidity, we can calculate and interpret this vibration as an electrical-mechanical analogue of the vibration of an ordinary magnet. The inertia of the atom

corresponds to the inertia of the magnet, and the electric doublet to the two magnetic poles. Consider our doublet in a spherical atom of mass m and radius a , and suppose this atom vibrating in the field of electric force due to all the other atoms, the strength of this field being $4\pi\sigma/K$. The period is

$$2\pi(\text{moment of inertia / moment of force})^{\frac{1}{2}}$$

$$= 2\pi \left(\frac{a^2 m 2/5}{e s \cdot 4\pi\sigma/K} \right)^{\frac{1}{2}} = 2\pi a / (30 \cdot \frac{4}{3} \pi \frac{a^3}{m} \sigma^2 s / K a)^{\frac{1}{2}}.$$

But as we must suppose only one-third of the energy per unit volume associated with the field of force in any one direction, we must in the last expression replace σ^2 by $\sigma^2/3$, and we get on numerical reduction with $s=2a$,

$$2a/\sigma(2/\rho K)^{\frac{1}{2}}. \quad . \quad . \quad . \quad . \quad . \quad (9)$$

The expression (8) on numerical simplification reduces to the same as (9) except that 2.1 for $2\pi/3$ replaces 2.0. Thus we see that what I called the mechanical period of vibration of an atom in my paper on Spectra, is capable of the simple electrical interpretation which it must have if rigidity at absolute zero is of electric origin. If this fundamental period is the same at all temperatures, then, as regards actions so rapid as the vibrations of the atom, the whole electric energy must act as if it retained the electrostatic form and the same value as at absolute zero. Note that we have found the electric doublet forcing the material atom to vibrate. For other actions we shall find that with rising temperature more and more of the original stock of electrostatic energy at absolute zero appears in the form of electrokinetic energy.

The double interpretation of atomic vibrations as mechanical and electrical is another instance of a certain duality which must accompany the attempt to treat the properties of matter and electricity as identical. Maxwell's electromagnetic theory has led to the current fruitful speculations on the electric constitution of matter. The older mechanical theory of light, of which Kelvin is the leading living cultivator, has as its logical goal a material theory of electricity. Both roads lead ultimately to the same junction, and duality such as that just discussed must be the rule. The connexion between the vibration of atoms here discussed and the translatory vibrations of the monatomic metal molecules at their melting-point, has been pointed out in "The Cause of the Structure of Spectra."

3. *The Division of Molecular Electric Energy into Electrostatic and Electrokinetic as shown by the Temperature Variation of Rigidity in Metals.*

The theory of rigidity leads as follows to a fundamental principle concerning the partition of electric energy. Let us denote the electrostatic energy associated with matter per unit volume in a metal at absolute zero by W^2 , and assume that n the rigidity at θ represents the electrostatic energy at that temperature, denoted by w^2 , then by (1)

$$\frac{w^2}{W^2} = 1 - \frac{\theta^2}{T^2}.$$

Now as a metal is heated up from zero to θ its atoms have an increasing amplitude of motion which at θ is proportional to $b\theta$ the expansion; and it may be assumed that, just as in harmonic motion mean velocity is proportional to mean amplitude, so the angular velocity of atoms of metal at θ is proportional to $b\theta$ or equal to $c\theta$, where c is a constant for any given metal. If, then, the difference between W^2 and w^2 exists as rotatory energy $C\theta^2$, we have the equation

$$W^2 - w^2 = C\theta^2.$$

But at the melting-point rigidity vanishes and $w^2 = 0$, so that when $\theta = T$ we find $W^2 = CT^2$, and thus

$$\frac{w^2}{W^2} = 1 - \frac{\theta^2}{T^2}.$$

The above, then, are the assumptions by which I propose to give a dynamical meaning to (1). The fraction θ^2/T^2 represents that fraction of the original electrostatic energy at absolute zero which is converted into electrokinetic energy on raising the temperature to θ . The combined existence of electrostatic and electrokinetic energies in the same pair of electrons may be conceived by imagining the electrons to travel over the surface of the atom in curves similar to screws having a small pitch so that the motion parallel to the axis of the screw is negligible in comparison with that round it. The average distance along the axis of the screw between the two electrons is the distance s which gives the pair of electrons the electric moment es . The electrokinetic energy of motion round this axis and the electrostatic energy due to separation of the charges along the axis, may both be regarded as a store of directed energy of total amount W^2 per unit volume. In this way we conceive a possible source of phenomena in which the total energy W^2 predominates, and of

others in which the parts w^2 and $W^2\theta^2/T^2$ separately predominate. Thus when a metal melts, w^2 and the rigidity n vanish, because the electric axis in each molecule changes direction so quickly that the mean electric moment vanishes. For actions more rapid, small portions of a melted metal might exhibit high rigidity, all depending on Maxwell's time of relaxation. In the next section the electrokinetic energy $W^2\theta^2/T^2$ will play an important part in accounting for the mechanism of electric and thermal conduction in metals.

4. *The Electric Gyrostatic Property in Molecules and its Part in Metallic Conduction. Theory of Electric and Thermal Conductivity in Metals.*

We owe to Riecke (*Wied. Ann.* lxvi. 1898) and to Drude (*ibid.* lxx. 1900) theories of electric and thermal conduction in metals wherein the positive and negative electrons act like the molecules of a perfect gas. Their theories are practically an application of the kinetic theory of gases to free electrons. These theories lead to some valuable results in the physics of electrons, as, for instance, when Drude finds that at a given temperature the kinetic energy of a free electron is identical with that of a molecule of a perfect gas at the same temperature. J. J. Thomson has sketched a similar theory of metallic conduction ('*Nature*,' May 1900; *Congrès International de Physique*, Paris, 1900, vol. iii.). These theories give the Wiedemann-Franz law of the approximate proportionality at ordinary temperatures between the electric and thermal conductivities of metals and the variation of their ratios inversely as the absolute temperature. In other words, the kinetic theory of electrons as gas makes the ratio of electric and thermal resistance at any temperature the same for all metals and directly proportional to the absolute temperature. But while the theory fares well with the ratio of the two conductivities, it makes no headway with an account of either conductivity taken separately. The reason is that the unfree electron pairs in the metallic atoms play a prominent part in the mechanism of conduction, which will now be investigated.

We have been led to assume in the last section that the pair of electrons in an atom of metal possesses electrokinetic energy by virtue of the rotation of the electrons round an electric axis; it must therefore have gyrostatic properties. Each atom is equipped with an electrostatic doublet and an electrical gyrostat, both having the same axis. In a metallic conductor all the gyrostats vibrate in a field of electric force

like a number of spinning tops in the field of gravity. During the vibrations it will sometimes happen that the $\#$ and the \flat of two adjacent doublets come so near one another that their attractions break up the doublets to form a new one, and liberate \flat and $\#$ at about two molecular diameters apart. These in rushing together may be regarded as free, and may upset the stability of other doublets. Thus we must allow to each electron the average free time and free path postulated by Riecke. This dissociation is characteristic of the doublets in metals and causes metallic conduction. The reason for the profound distinction between metals and insulators is that in the monatomic molecule of the metal both $\#$ and \flat are in the same atom, whereas in compounds $\#$ and \flat are generally in different atoms. For instance, in NaCl we have $\#$ attached to Na and \flat to Cl, as proved in the electrolysis of fused NaCl. Thus the $\#$ in Na, if it approaches the \flat of the Cl in another molecule, will not break away, because of the decided affinity of the $\#$ for Na and of the \flat for Cl. Unless the molecule of NaCl breaks up and allows electrolytic conduction to take place, NaCl acts as an insulator. The monatomic atom of a metal with its doublet is what I have proposed to call a stion. Metallic conduction is due then to the dissociation of stions, electrolytic conduction to the dissociation of molecules. In the case of the Helium family the stions may not dissociate, in which case these elements in the solid state would not conduct like metals. The electrons in the atoms of these elements may be inside instead of on the surface, as appears to be the case with the metals. In insulators, then, each atom confines its own electron or electrons to its own immediate neighbourhood and allows no free time.

In metallic conduction, then, we have to do with the breaking of molecular electrical gyrostats and the flying together of the broken pieces. For simplicity, we can replace the actual discontinuous process of nature by an imaginary equivalent in which each gyrostat preserves a continuous existence, while also a certain number of free electrons travel between the gyrostats, propagating momentum to the same amount as the shocks occurring in the natural process. In a metal of varying temperature the transmission of energy is greater from hot to cold than in any other direction because the free electron carries with it the kinetic energy of the temperature ruling where it gained its freedom, and so we have the conduction of heat. In metals, of course, there will be also the usual molecular conduction of heat as in insulators. On the present occasion we shall treat the conduction of heat

by purely molecular agency in metals as negligible in comparison with that due to electrons.

In the conduction of electricity the gyrostats most affected by an E.M.F. are those having their axes at right angles to the E.M.F., for the couple acting on the electrostatic doublets is greatest when their axes are perpendicular to the E.M.F.

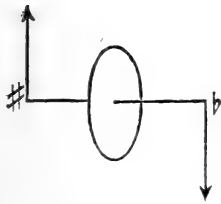

Accordingly we shall take as our typical case that represented in the diagram, where the circle in perspective may be taken to be a material flywheel having the same moment of inertia round its axis as the electric gyrostat. It is supposed to be rigidly connected with the doublet axis round which it revolves, the distance between # and b being s and their charges e . The

couple due to the E.M.F. acting on the charges is denoted by the arrows. The electrical gyrostat is similar, then, to the familiar experimental case of a flywheel revolving round a horizontal axis supported by a universal joint at one end. The couple due to gravity and supporting force at the joint corresponds to the couple on the electric doublet. The general motion of such a gyrostat is a rotation of the axis in a horizontal plane with small vertical oscillations of the axis. The period of this vibration is $2\pi A/C\omega$, where ω is the velocity of rotation, and the amplitude of the angular vertical oscillation of the axis is $2HA/C^2\omega^2$, where A is the moment of inertia of the flywheel round a horizontal axis through the centre of mass and perpendicular to the axis of rotation, and C is the moment of inertia round the axis of rotation, while H is the moment of the couple. Since for our pair of electrons $2A=C$, we prescribe the same condition for our flywheel, and find its period of vibration to be π/ω and its amplitude $H/C\omega^2$. In the case of our electric gyrostat, if X is the electric force near it, the couple esX takes the place of the couple of gravitation for the flywheel. Thus the angular amplitude of the oscillations of the axis of the gyrostat is $esX/C\omega^2$. Denote the period of vibration by τ which we have seen to be half the period of rotation of the gyrostat, then the average linear velocity of the electrons # and b at the end of the axis is $es^2X/2C\omega^2\tau$, assuming the centre of inertia to be at rest.

We have found, then, that the effect of an electric force X on our typical doublet is to give the electrons a to-and-fro motion in the direction of X . We have now to show how these reciprocating velocities produce a continuous velocity

of the $\#$ electrons with X and of the \flat electrons against X , so as to give a current proportional to X . The cases in which the $\#$ electron of one doublet is brought near to the like electron of another by the oscillations, or the \flat electron is brought near to its like, need no further consideration as there is repulsion. But when the $\#$ of one doublet approaches the \flat of another, the cases in which break up of the doublets occurs must most frequently happen when $\#$ is moving forward with X and \flat backward. While the near $\#$ and \flat of two doublets are forming a new doublet, the remote \flat and $\#$ of these two doublets are released as free electrons at the end of their vibrations when they are at rest. Therefore they begin at once to move in the field of X . Now, in the theory of Riecke and Drude and Thomson, these free electrons are supposed to travel a certain free path under the force X and thus maintain the current. This is a possible mode of genesis of the current, but it seems to me more probable that, as these free electrons will rush together to form new doublets, the passing on of $\#$ forward and of \flat backward at a favourable conjunction of circumstances is the real source of current. As the other action is dependent on this one, its effects may be merged in those of its cause. The result of the oscillatory process, then, is to send forward a certain fraction of the $\#$ electrons and backward the same fraction of the \flat electrons. Denote this fraction by ϕ and the number of each sort of electrons per unit volume by Q , then we have ϕQ electrons per unit volume moving forward with velocity v , which is the mean velocity of vibration determined above, the same number moving backwards; so the total current across unit area is

$$2\phi Qev = \phi Qe^2s^2X/C\omega^2\tau. \quad \dots \quad (10)$$

So for the electric conductivity γ we have

$$\gamma = \phi Qe^2s^2/C\omega^2\tau. \quad \dots \quad (11)$$

But $C\omega^2/2$ is the electrokinetic energy of our metallic stion or atom plus doublet. The electrokinetic energy per unit volume is by section 3,

$$N\theta^2/T^2 = (\theta/\tau)^2\{e^2s^2/K(2a)^6\}.$$

But $Q = 1/(2a)^3$, so

$$C\omega^2/2 = (\theta/T)^2\{e^2s^2/K(2a)^3\}, \quad \text{and} \quad \gamma = K\phi T^2/2\theta^2\tau. \quad (12)$$

We have still to determine ϕ and τ . We have found that τ is half the period of rotation of the doublet. We have pictured the rotation as movement on a curve like a screw

of small pitch on the surface of the atom, so that for finding τ it may be treated as though the path of each electron were a circle of radius a . The electric attraction is the centripetal force, and so $Iv^2/a = e^2/K(2a)^2$, where I is the inertia of an electron, assumed to be the same for both electrons; thus

$$\tau = \pi a/v = 2\pi a^3 I^{1/2} K^{1/2} / e. \quad \dots \quad (13)$$

Here K denotes the dielectric capacity of the stuff of the atom, not quite the same as the average for the atoms and their interspace. It is well worth noticing as another example of duality, that the period thus calculated is proportional to the period of vibration of any one doublet in the field of force due to all the others, on the supposition that the doublet moves free of constraint from the atom, just as we assumed in the above calculation of τ . The time of vibration being

$$2\pi (\text{moment of inertia} / \text{moment of couple})^{1/2}$$

is equal to

$$2\pi \left(\frac{2a^2 I}{e s \cdot 4\pi \sigma / K} \right)^{1/2} = 2\pi (3a^3 I K / e^2 \pi)^{1/2}$$

if $s = 2a$, $\sigma = e/4a^2$, and factor $1/3$ is used.

This is nearly the same as (13). The value of τ calculated in each of these ways is independent of the temperature, and therefore of the electrokinetic energy impressed on the doublet by the atom. It is the same as the period calculated on the assumption that all the electric energy of a doublet is kinetic energy; for if Ω is the velocity of rotation for this, then

$$\frac{1}{2} C \Omega^2 = N = 2\pi e^2 s^2 / 3K(2a)^3, \text{ and } C = 2a^2 I,$$

$$\therefore \tau = \frac{2\pi}{\Omega} = 2\pi (3a^3 I K / e^2 \pi)^{1/2}.$$

Substituting in (12) for τ the value given in (13), we have

$$\gamma = K^{1/2} \phi T^2 e / 4\pi \theta^2 a^{3/2} I^{1/2}. \quad \dots \quad (14)$$

To express ϕ the simplest assumption we can make is that the chance of the occurrence of conditions favourable to the breaking up of two adjacent doublets will be proportional to the ratio of the free spaces between the atoms to the volume of the atoms, this ratio being a measure of the freedom of the atoms to move. In section 3 we took the angular velocity of the atoms to be proportional to $b\theta$. Thus

with b as coefficient of linear expansion we take ϕ proportional to $b\theta$, equal to say $Gbb\theta$, and then

$$\gamma = K^{\frac{1}{2}} G b T^2 e / 4\pi \theta a^2 I^{\frac{1}{2}}. \quad . \quad . \quad . \quad (15)$$

This expression for the conductivity has been obtained by the consideration of an atom which contains only one doublet. Now there is reason for believing that the monatomic molecule of a divalent metal such as calcium or zinc contains two doublets, and generally that the number of doublets in the molecule of a metal is equal to its valency (Phil. Mag. [5] xxxix.). So far, then, we have considered only the case of a monad metal, for we put $Q=1/(2a)^3$. For a metal of valency ν we cannot treat the ν doublets like entirely separate entities, as though they were in separate atoms, nor can we simply change the e of the previous calculations into νe . We must remember that all the doublets in a polyvalent metal atom have a resultant electric moment, and that if we still denote this by $\{es\}$, e and s separately have not their former meanings. Thus in the process of calculating γ we used esX for the couple acting on a doublet. But the ν doublets in an atom having a moment $\{es\}X$, we ought for the whole electrical system of the ν -valent atom to use $\{es\}$ instead of the simple es . But in "Further Studies" there are two lines of evidence that $\{es\}^2$ has only ν times the value of e^2s^2 . Since we are now treating s as equal to the molecular diameter, it follows that if in $\{es\}$ we still treat it so, then e in $\{es\}$ has only $\nu^{\frac{1}{2}}$ times the value of e . But at each vibration of the electrical system of an atom, it is most likely that only one electron takes part in the transmission of current, and not $\nu^{\frac{1}{2}}$ electrons. Q is still equal to the number of atoms per unit volume, and ϕ remains the same. Consequently for ν doublets in an atom e^2s^2 in (10) should be replaced by $\nu^{\frac{1}{2}}e^2s^2$, while the moment of inertia for the ν doublets becomes ν times that for a single one. Hence, when e^2s^2 is eliminated as in (12) we shall get

$$\gamma = K\phi T^2 / 2\theta^2 \tau \nu^{\frac{1}{2}}. \quad . \quad . \quad . \quad (16)$$

The period of vibration τ is not affected, because couple and moment of inertia are increased ν times. So for a metal of valency ν (15) becomes

$$\gamma = K^{\frac{1}{2}} G b T^2 e / 4\pi \theta a^{\frac{3}{2}} I^{\frac{1}{2}} \nu^{\frac{1}{2}}. \quad . \quad . \quad . \quad (17)$$

Now, in "Further Studies" it was shown in Table xxix. that M^2l for the main families is proportional to $\nu(M/\rho)$ and in the subordinate families to a simple multiple of $\nu(M/\rho)$.

But M^2l is proportional to e^2s^2/K , and in the metals we have found $s=(m/\rho)^{\frac{1}{2}}$. If, then, we take $K\nu(m/\rho)^{\frac{1}{2}}$, that is $K\nu a$, to be a constant β^2 , we eliminate K from (17) thus

$$\gamma = G\beta^2 T^2 / 4\pi\theta a^2 \nu I^{\frac{1}{2}} \dots \dots \dots (18)$$

As I the inertia of an electron has been assumed constant, and $1/\gamma$ is the electrical specific resistance at θ , this can be written

$$\frac{1}{\gamma} \left(\frac{M}{\rho} \right)^{\frac{1}{2}} b T^2 / \theta \frac{M}{\rho} \nu = \text{constant} \dots \dots (18a)$$

This is the relation discovered by W. Williams (*Phil. Mag.* [6] iii. 1902). It must be noted that several metals like Ag, Cu, Tl, and Pb, which have β^2 replaced by a simple multiple of β^2 , show no appearance of the effect of the simple multiplier in the formula of Williams, while some metals are exceptions to this rule. It is possible that for these two classes of exceptional metals I cannot be assumed to be constant, but that the ratio of the simple multiplier of β^2 to I is constant or a simple number. On account of the importance of (18a) I shall reproduce the data gathered by Williams with the addition of a few, to show how nearly the left side of (18a) is the same for most of the metals. That equation makes resistance proportional to absolute temperature, which is the well-known approximate truth pointed out by Clausius. Our comparison will be restricted to the case where $\theta=273$, unless it is otherwise stated. The resistance $1/\gamma$ is given in ohms for a cm.³ For ν the highest known valency is given.

| | Na. | K. | Cu. | Ag. | Au. | Mg. | Ca. |
|---------------------|-----|-----|--------|------|------|------|--------|
| $10^7/\gamma$ | 51 | 84 | 17 | 15 | 20 | 41 | 75 |
| $10M/\rho$... | 237 | 454 | 71 | 102 | 101 | 139 | 254 |
| 10^7b | 720 | 830 | 170 | 194 | 147 | 270 | (279)* |
| T | 369 | 335 | 1333 | 1173 | 1310 | 1023 | 853? |
| ν | 1 | 1 | 2 | 1 | 3 | 2 | 2 |
| | 22 | 22 | 25 | 31 | 13 | 37 | 52 |
| | | | | | | | |
| | Zn. | Cd. | Hg. | Al. | In. | Tl. | Sn. |
| $10^7/\gamma$ | 58 | 75 | 210 | 29 | 84 | 176 | 105 |
| $10M/\rho$... | 91 | 129 | 141 | 106 | 153 | 172 | 163 |
| 10^7b | 298 | 316 | (778)* | 222 | 417 | 302 | 230 |
| T | 676 | 593 | 234 | 923 | 449 | 561 | 503 |
| ν | 2 | 2 | 2 | 3 | 3 | 3 | 4 |
| | 33 | 28 | 34 | 14 | 14 | 31 | 9 |

* Calculated by empirical formula $b/TM^{\frac{1}{2}} = .044$.

| | Pb. | As. | Sb. | Bi. | Pd. | Pt. | Fe. | Ni. |
|---------------------|-----|--------|-----|------|------|------|------|------|
| $10^7/\gamma$ | 200 | 351 | 431 | 1080 | 102 | 90 | 110 | 109 |
| $10M/\rho$... | 181 | 132 | 179 | 211 | 92 | 91 | 72 | 67 |
| 10^7b | 290 | (278)* | 116 | 137 | 110 | 91 | 118 | 128 |
| T | 605 | 773 | 710 | 538 | 1775 | 2050 | 2350 | 2140 |
| ν | 4 | 5 | 5 | 5 | 8 | 8 | 8 | 8 |
| | 28 | 76 | 25 | 41 | 37 | 36 | 83 | 77 |

* Calculated by empirical formula $\nu TM^{\frac{1}{2}} = .044$.

The last row in this table contains the values of $(10^3/\gamma)\nu T^2/\theta(M/\rho)^{\frac{2}{3}}$, and at a first glance they do not seem to be near enough to a constant to verify (18 a), but the row contains some metals having such exceptional characters as demand modification of the theory leading to (18 a). First, As is a metal with properties merging into those of a non-metal. Its molecule in the vaporous state is As_4 . On this account As ought to be excluded from a table of normal metals. Although Sb and Bi, two other members of the As family of metals, would seem to fall into line as normal metals, I am dubious about 5 being the right value of ν to use. Fe and Ni ought to be excluded from the above table on account of their magnetic properties, which indicate a special action and reaction between the revolving doublets and the atom. The magnetic metals require a special theory. The other metals giving distinctly exceptional values are Au, Al, In, and Sn. In their case the discrepancy I believe to be due to the fact that in these atoms the number of doublets is not identical with the valency of the atom. It is noteworthy that three out of the four trivalent metals should contribute values 13, 14, 14 to the row. The exceptional results for Au, Al, and In can be accounted for by a principle which I have discussed in connexion with the tetrad valency of oxygen and the constitution of water in "Ionization, &c." For example, the pentad valency of N was traced to its atom having associated with it four \flat electrons and one \sharp . If the \sharp unites with one \flat to form a doublet the N atom can act as a triad, as in ammonia. If, then, the pentad metals Sb and Bi behave similarly, we might expect their atoms in the element state to form three doublets corresponding to the triad valency in addition to the one doublet formed by the union of \sharp and \flat . Perhaps, then, for Bi and Sb in the above table, 4 should be substituted for 5 in the values of ν . Returning then to the triad atoms of Au, Al, and In, we could ascribe their valency to two \sharp and one \flat electron. For auric chloride $AuCl_3$, the graphic formula would be as shown. Its reduction to aurous chloride $AuCl$ is readily explicable by

this formula, since Cl_b and Cl_# supply everything to make Cl₂, and the b of Au unites with a # to form a doublet, and leaves Au to act as monovalent with one free #. It is possible, then, that in metallic gold the atom has two doublets. Similarly with Al and In. These three triad metals fall into line with the others if their atoms contain one or two doublets instead of the three assigned to them in the table. In the case of Sn the tetrad valency of the atom may be due to two # and two b electrons. This would give the

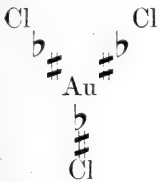

atom of metallic tin two doublets and would bring Sn into a less exceptional position. One fact is very suggestive of truth in our speculations about the valencies of Au, Al, and Sn, namely, that it is so difficult to determine their ionic velocities that even yet values are not given. The interesting chemical inquiries suggested cannot be followed up here. We have shown good cause why the four smallest values in the last row of our table should not be held to be at variance with the principles at the basis of (18 a), but should lead to a means of estimating the actual number of doublets in an atom of uncombined metal more refined than that of treating it as the same as the highest valency in all cases. These considerations throw doubt on the value for Tl and Pb. The case of Cu is also not quite clear. But in considering the table as a whole, it must be remembered that $10^7/\gamma$ ranges from 15 for Ag to 1080 for Bi, that ν ranges from 1 to 8, M/ρ from 6.7 to 45.4, 10^7b from 91 to 830, and T from 234 to 2350, T entering also as a square. The approach to constancy in these circumstances is such as to show a substantial soundness in the train of thought leading to (18 a).

In the metallic conduction of heat, we shall at present ignore that part of it which is identical with the molecular process of heat-conduction, as it takes place in electric insulators, and investigate only the chief part effected by the electric doublets. In electric conduction we regarded the electric gyrostats as forced to vibrate in a field of electric force X. But in a mass of metal free from electric force and at a uniform temperature each doublet is thrown into oscillations of a certain mean frequency because of atomic motion. These produce conjunctions favourable for the breaking of doublets and the forming of new ones. This process causes a movement of electrons through the mass of metal which is very similar to that of the molecules in a perfect gas. If there is variation of temperature in a metal, the motion of the electrons is the cause of a flow of heat from the hot parts to the cold. Riecke,

Drude, and Thomson treat the conduction of heat by electrons as practically identical with that by molecules of a perfect gas. In the present theory, although the breaking up and renewal of doublets causes a free movement of electrons in all directions, these movements go on not according to the laws of molecules in a gas, but according to the laws of electric gyrostats. Just as electric conduction is due to directed vibrations of the gyrostats in the direction of electric force, thermal conduction is due to thermal vibrations of the gyrostats maintained equally in all directions. The mean effect of a collision between two atoms is to leave each with the same kinetic energy but differently directed. The axis of rotation of each atom is also changed in direction. Thus, there must be set up couples of action and reaction between atom and electric gyrostat, just as if the gyrostat were a material one revolving round an axis with bearings in the atom. As the kinetic energy of rotation of the atom remains on the average constant and only changes the direction of its axis, the moment of each couple must on the average be proportional to the kinetic energy of rotation, and therefore to the kinetic energy of translation of the atom. Thus in place of the electric couple esX we have a thermal couple which we may write Amv^2 , A being a constant. In place of the angular amplitude $esX/C\omega^2$ of the electric vibration of the gyrostat we have $Amv^2/C\omega^2$ for the angular amplitude of the thermal vibration of the gyrostat. For the mean velocity of each electron due to the thermal vibration we have

$$Amv^2s/2C\omega^2\tau. (19)$$

Now each electron which is passed on from one molecule to another advances a distance $2a$. If there is a fall of temperature in any direction, one-third of the movements of electrons may be assumed to take place only in that direction, the rest perpendicularly to it. An electron moves from a place where it is in thermal equilibrium with an atom having kinetic energy $mv^2/2$ to another place where it comes into thermal equilibrium with an atom having energy $mv^2/2 + 2ad(mv^2/2)/dx$, x being in the direction of motion. The electron carries forward such fraction of the energy $2ad(mv^2/2)/dx$ as its own energy is of $mv^2/2$. Call this fraction f . Then the current of heat across unit area perpendicular to x is

$$\frac{2}{3}\phi Q2aA(mv^2s/C\omega^2\tau)f\frac{d(mv^2/2)}{dx}. (20)$$

Now $mv^2/2 = \alpha\theta$, where α is generally taken to be constant, but we shall see that for the metals it is not quite so.

For the thermal conductivity k we have with $s = 2a$,

$$k = \frac{2}{3} \phi Q (2a)^2 f A \alpha \theta^2 / C \omega^2 \tau, \dots \dots \dots (21)$$

\therefore from (11) $k/\gamma = 4fA\alpha\theta/3e^2$. $\dots \dots \dots (22)$

This is the central relation of the theory of Riecke and Drude. It embodies the Wiedemann-Franz law. Drude's theory makes f identical with α and $A = 1$. Then, with the values of γ and k for silver at 18° C. and J. J. Thomson's value of e as 6×10^{-10} , he finds for α the value 26.5×10^{-17} , while in the kinetic theory of gases it is 5.6×10^{-17} . As Thomson has found 3×10^{-10} to be a better estimation of e , Drude's value of α becomes 13×10^{-17} . This is near enough to the kinetic theory value to show that Drude's assumption that the kinetic energy of an electron equals that of a molecule is substantially correct. Thus the free electron of the Riecke theory at a given temperature has the same kinetic energy as a molecule of gas at that temperature. The present theory does not necessitate the literal truth of Drude's principle. All that we need to assume is that an electron in moving from one place to another carries to its molecule in the second place an amount of energy nearly equal to its excess or defect over the molecular energy at the first place. The simplest way of giving the electron this property is to treat it as a molecule of a perfect gas, but it is not the only way. By means of the data of Jaeger and Diesselhorst (*Sitz. d. k. pr. Akad. der Wiss.* Berlin, 1899) for γ and k for a number of pure metals on the same specimens at 18° and 100° , Drude shows that while according to (22) the ratio of k/γ at 18° and at 100° is $373/291 = 1.28$, the experimental values range from 1.26 for Sn to 1.35 for Pt and Pd, the mean for 13 metals being 1.30. For the exceptional metal Bi it is 1.12. But according to (22) k/γ at a given temperature ought to be the same for all metals. Here are the values given by Jaeger and Diesselhorst:—

| | | | | | | | | | | | | |
|-----|-----|-----|-----|-----|-----|-----|-----|-----|-----|-----|-----|-----|
| Al. | Cu. | Ag. | Au. | Ni. | Zn. | Cd. | Pb. | Sn. | Pt. | Pd. | Fe. | Bi. |
| 636 | 665 | 686 | 727 | 699 | 672 | 706 | 715 | 735 | 753 | 754 | 802 | 962 |

If we except Fe for its strongly magnetic properties and Bi on account of its crystalline structure, we find k/γ increase from 636 for Al to 754 for Pd. It is of interest that for these same metals the atomic heat Mc increases in about the same proportion, as the following values of $10Mc$ show when arranged for the metals in the same order as above. The values of c used are Regnault's at about 60° C. A row of

ratios $k/\gamma Mc$ is added to show the proportionality under discussion.

| | Al. | Cu. | Ag. | Au. | Ni. | Zn. | Cd. | Pb. | Sn. | Pt. | Pd. | Fe. | Bi. |
|-------------|-----|-----|-----|-----|-----|-----|-----|-----|-----|-----|-----|-----|-----|
| $10Mc\dots$ | 58 | 60 | 61 | 64 | 64 | 62 | 63 | 65 | 66 | 63 | 63 | 64 | 65 |
| | 110 | 111 | 112 | 114 | 109 | 108 | 112 | 110 | 111 | 120 | 120 | 125 | 148 |

By taking account of the molecular heat we get a decidedly more accurate relation between thermal and electrical conductivity than is given by the Wiedemann-Franz law. Now this improvement on that law is in reality contained in the theory just given of thermal conduction, for we assumed provisionally for simplicity that α is constant in the equation $mv^2/2 = \alpha\theta$. But for the metals we should take α to be proportional to Mc . Then (22) gives at once that $k/\gamma Mc$ is to be the same for all metals, as we have just found it to be to a considerable degree of approximation. Of course the atomic heat at 18° and 100° ought rightly to enter into the comparison of k/γ at these temperatures, and would perhaps improve the results of Drude's comparison.

Riecke and Drude make some enterprising and elaborate attempts to build up a theory of thermoelectricity on the perfect gas analogy for free electrons, treating of the Peltier, Thomson, Hall, and Nernst and Ettingshausen effects. I do not propose at present to apply the theory of electric gyrostats to these subjects, because Liebenow (*Zur Thermodynamik der Thermoketten*, Wied. Ann. lxxviii. 1899) has sketched a most promising thermodynamic deduction of the Peltier and Thomson effects from the electrical and thermal conductivities of metals. So a successful molecular theory of thermoelectricity presupposes a satisfactory electronic theory of the Second Law of Thermodynamics as applied to electricity. Moreau has shown (*Compt. Rend.* cxxx. 1900) that the Nernst and Ettingshausen effect can be deduced from the Thomson and Hall effects. There is reason to believe that the Hall effect is connected with the electric and magnetic relations of elasticity, and as we have shown that rigidity in its origin is electrostatic and its temperature variation is electrokinetic, it is evident that a satisfactory electronic account of the Hall effect probably involves a complete theory of the effects of electric and magnetic fields of external origin on the elastic properties of metals. This large subject, first opened up by Kelvin half a century ago, has probably to be worked up before we get a satisfactory theory of the Hall effect. It is interesting to reflect that Kelvin, in applying the laws of thermodynamics to electricity, many years ago foreshadowed the fundamental similarity between matter and electricity

which is now the source of so much fruitful research in physics. It seems to me that the magnetic properties of metals might be the most promising field in which to test further the capabilities of the electric gyrostat for explaining the relations of matter and electricity.

We can apply a partial check on the results of this section by using (12) to calculate the order of magnitude of ϕ the fraction of the doublets occupied at any time in the transmission of electric current. Take the case of silver, for which at $\theta = 273$ $1/\gamma$ is given in the Table along with T. For the silver ion K is 2.66, and if we take this as a value for metallic Ag, then from (12) we find τ to be of the order $4 \times 10^{-14} \phi$. But in "The Cause of the Structure of Spectra" I have shown that the fundamental period in the vibrations of atoms is of the order 10^{-14} , and so ϕ is of the order $1/4$. Not much weight is to be attached to this evaluation, but if ϕ had come out a large integer, say 10^3 , there would have been strong reason to doubt the cogency of the preceding calculations.

5. *Contact Difference of Potential, and Mechanism of the Storage of Potential Chemical Energy in the Æther.*

The question of the contact difference of potential in metals is one that Lodge has kept to the fore during the last twenty years. It is fundamental in electricity and chemistry. The special point emphasized by Lodge is that the contact E.M.F. of metals can be calculated from their heats of combustion in oxygen in the following way. Conceive a gramme equivalent M_1 and M_2 of each of two metals to be burnt in oxygen, giving heat h_1 and h_2 . Let q_1 and q_2 be their electrochemical equivalents, then the quantity of electricity taking part in their burning is $M_1/q_1 = M_2/q_2$. If, then, $V_1 - V_2$ is the contact difference of potential for these two metals, the electrical work done by the quantity M_1/q_1 in this change of potential would be $(V_1 - V_2)M_1/q_1 = V_1M_1/q_1 - V_2M_2/q_2$. On equating this to $h_1 - h_2$ we get Lodge's principle,

$$(V_1 - V_2)M_1/q_1 = h_1 - h_2. \quad \dots \quad (23)$$

Lodge considers that the oxygen atoms in straining at the metal atoms establish the contact E.M.F. If the oxygen could be completely got rid of, and the metals be immersed in perfectly dry chlorine, their contact E.M.F. ought according to Lodge's idea to be calculated from the heats of combination of the metals with chlorine. The evidence as a whole seems to me to be against this particular view, but the important matter is that the contact E.M.F. for a pair of

metals is of the same order of magnitude and in about the same succession for different pairs of metals, as if calculated from the heats of combination with oxygen, chlorine, or some other powerfully electronegative element. Helmholtz's electron theory of chemical valency furnishes a simple explanation of this principle, if it is suitably modified by making the doublet rather than the electron the main agent. From "The Electric Origin of Molecular Attraction" (Phil. Mag. [6] iv.), and previous papers on molecular force, it follows that the doublet of a compound inorganic molecule such as NaCl consists of two parts, one belonging to Na and the other to Cl. This means that the doublet of NaCl is made up of two doublets, just as a single bar-magnet can be made out of two. Reinganum (*Ann. d. Ph.* [4] x.) has proposed the use of doublet in place of electron. Helmholtz's original view of chemical valency can be expressed by writing the formula for NaCl in the form $\text{Na}\# \text{Cl}$. But when we assign to Na and Cl a single doublet each, in place of the single electron, the formula becomes $\# \text{Na}\# \text{Cl}\#$. The inner pair of electrons are so close to one another that their external effects are neutralized, and the total external effect is that due to the two outer electrons which act as a single doublet.

The diagram makes clear the importance of the substitution of doublets for electrons as the agents in chemical combination. The points A, B, C, D denote the positions of the four electrons whose symbols are placed over them.

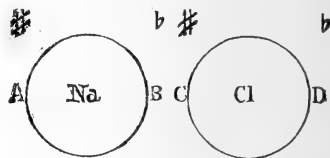

The distance BC being negligible in comparison with AB and CD, the electric moment of the whole molecule is $e \cdot AD$, to which Na contributes the moment of its own doublet $e \cdot AB$, and Cl the moment $e \cdot CD$. The investigation of the values of these parts has occupied a considerable portion of my papers on molecular attraction. Now the very smallness of BC makes it of fundamental importance in the electrical theory of thermochemistry, for the electrons b and $\#$ at B and C have their electric energy expressible as e^2/BC^2 . Thus BC, which is neglected in the study of molecular attraction, becomes the principal physical quantity in the thermochemistry of atoms. Potential chemical energy is stored by increasing the potential energy of inner doublets like BC.

The equation for the reaction between Na and Cl must now be written



The form given to Cl_2 in this equation shows that the dissociation of Cl_2 into 2Cl , or of I_2 into 2I does not involve the production of ions, but only of stions. Thus the vapour of I_2 containing free atoms I is not necessarily a conductor, nor is that of N_2O_4 , and therefore the difficulty about Richarz's application (Wied. *Ann.* lii.) of Helmholtz's theory to the dissociation of N_2O_4 and of I_2 disappears, if we replace the electron of Helmholtz by the doublet. The doublet theory greatly simplifies the constitution of all the diatomic element molecules such as H_2 and N_2 , for it makes both atoms of the molecule similarly equipped, instead of making one positive and the other negative as the electron theory does. On the other hand, it is necessary to assign some reason why no more than two doublets should unite to form these molecules, and why the metal monatomic molecules retain their individualities. However, the chief difference that the doublet theory of valency makes when substituted for the electron theory is, that for every doublet which the electron theory would require on account of the attraction of opposite electrons, the doublet introduces an inner doublet whose electrons are very close together. Thus the graphical formulæ proposed for water, NH_4Cl , and PCl_5 , in "Ionization &c.," are easily adapted to the doublet theory, which raises very nice problems of stable configurations in space of three dimensions analogous to those studied experimentally by Mayer and Wood (*Phil. Mag.* [5] xlvi.) for small magnets in a plane. In the electrical theory the molecule becomes similar to a multipolar dynamo armature.

The doublet theory gives two possible isomeric forms for NaCl , namely, $\text{hNa}\text{hCl}\text{h}$ and $\text{hNa}\text{h}\text{hCl}\text{h}$. We can express the electropositive nature of Na and the electronegative of Cl by stating that the latter of these forms is the only one that occurs. But the fact that an atom may be electropositive to a second atom and electronegative to a third can be simply expressed by formulæ like those just written. The ionization of NaCl may be described as the removal of the internal doublet from $\text{hNa}\text{h}\text{hCl}\text{h}$ by means of the solvent, and the separation of the two parts hNa and hClh to such a distance that they cannot immediately recombine. We may regard an ion like hNa as a stion hNah with an added h which coincides with the h and neutralizes it completely. The advantage of this method of regarding an ion is that it assigns to the ion the doublet which gives the power of cohesion, and the ions in solution behave as though they take part in the cohesion of the solution. According to this view of the ion, it would be better to describe the ionization of

NaCl as the introduction of a doublet in the position shown thus $\#Na\# \#Cl\#$, the two inner doublets reacting parallel to the thick line, while neutralizing one another's chemical cohering power, and so allowing the molecule to split into $\#Na\#$ and $\#Cl\#$, which are the two ions. The central problem of ionization is to discover whence the extra doublet is derived. We may of course write the formula for NaCl in the form $\#Na\#\#Cl\#$, and so equip the molecule with three doublets, which during ionization are resolved into two separate doublets, each of which has associated with it one of the electrons into which the third doublet has been broken.

To follow out this line of thought and give a logical representation of the monatomic molecule of metallic Na, we should write its symbol thus $\#Na\#\#$, indicating that there are two doublets present, one having an electric moment which is negligible in comparison with that of the other. Similarly, the symbol for Cl_2 will become $\#Cl\#\#Cl\#$. It will not be necessary to use such long formulæ continually, if we remember that $\#$ may stand for any number of associated doublets, the preferable number being the smallest that will enable all the known facts to be logically set forth.

With this notation we can now discuss the separate parts of the energy changes whose total forms the heat of the chemical reaction given in (24). The formation of $2\#Na\#\#Cl\#$ from Cl_2 and $2Na$ involves the work of splitting $\#Cl\#\#Cl\#$ into $2\#Cl\#$, which may be denoted by (S), where S means any electronegative element, that of bringing $\#Na\#$ and $\#Cl\#$ into the position $\#Na\#\#Cl\#$, involving work depending on the distance between $\#$ and $\#$ in the inner doublet; this work may be denoted by $2(RS)$, and then in accordance with Helmholtz's idea of the specific attraction between matter and electricity there is the work of bringing the $\#$ of Cl quite close up to Na and that of bringing the $\#$ of Na quite close up to Cl. Now, in the more powerfully electropositive metals the changes of volume of their atoms on combination with Cl, Br, and I are approximately the same; and this fact suggests that the work of bringing $\#$ of Cl quite close up to Na is approximately independent of the electronegative reagent, and may be written (R) with R as general symbol for a metal. The corresponding quantity for Cl may be merged in (S). The work (R) is sometimes accompanied with quite a remarkable change in the volume of the metal atom. For the gramme atom of Li the change on passing from the metallic to the combined state is $11.9-2$; for Na it

is 23.7-7.4, and so on. There is evidence (see "Ionization &c.") that a gramme atom of Li ions retain the volume 2 characteristic of the combined state, of Na ions the volume 7.4 and so on. Hence it appears that the contiguity of \sharp to Na causes a large reduction in its volume. On the other hand, any change of volume in the Cl and Br atoms on passing from Cl₂ and Br₂ into compounds is relatively small, and in the case of I the change seems to be an expansion instead of a contraction. It would appear that when \sharp and \flat attract one another in a metallic atom, the atom acquires such a volume as makes centrifugal force equal to the attraction. When the attraction is neutralized the atom collapses to a much smaller volume. The simplest assumption we can make as to the mutual potential energy of a metal atom and \sharp and \flat is that Na and \sharp have minimum potential energy in contact, Na and \flat when apart, that is Na and \sharp attract, Na and \flat repel. In metallic Na the \flat would be expelled but for the direct attraction of the \sharp . The simplest assumption we can add as to the relation between the attraction and repulsion is that they are equal, or that the mutual potential energies of Na and \sharp and of Na and \flat are equal in magnitude but of opposite sign. If there is a strong enough external electric field to counteract sufficiently the attraction between \sharp and \flat , the repulsion of the metal atom for \flat will drive it out, giving the phenomena of the cathode rays. In a similar way the Becquerel rays may originate.

Returning to the energy changes to go with (24) we get for the heat of reaction

$$2(R) + S + 2(RS) = 2h. \quad . \quad . \quad . \quad (25)$$

For two metals we have

$$(R_1) - (R_2) + (R_1S) - (R_2S) = h_1 - h_2 \quad . \quad . \quad (26)$$

Now, at a junction of these same two metals we may consider the passage of a current to be the exchange across the junction of \sharp for \flat . By the loss of \sharp the first metal gains potential energy (R_1) and by the gain of \flat it gains energy (R_1) , and so for the passage of $2e$ across the junction the gain of energy is $2(R_1) - 2(R_2)$. Consequently there must be an E.M.F. $V_1 - V_2$ across the junction such that the total energy change of the $2e$ crossing the junction is nil ;

$$\therefore e(V_1 - V_2) = R_1 - R_2 \quad . \quad . \quad . \quad (27)$$

Comparing this with (26) we see that if $(R_1S) - (R_2S)$ is of subordinate importance to $(R_1) - (R_2)$, Lodge's principle will be nearly true, namely, $e(V_1 - V_2) = h_1 - h_2$. Now, in

“The Fundamental Atomic Laws of Thermochemistry” (Phil. Mag. [5] xl.) I have shown that (RS) is of secondary importance to (R). It appears then that Lodge’s principle concerning the Volta Contact E.M.F. is the outcome of certain laws in the mutual energetics of matter and electricity. It should be noticed that although (RS) was originally defined as the work of bringing R and its attached doublet into combination with S and its attached doublet, it is possible that it may contain parts depending on R alone and on S alone, these merging into (R) and (S) and leaving a comparatively small part depending on both R and S. This part, which in the thermochemical paper is denoted by $f(\text{RS})$, is what is of secondary importance, and not the complete (RS). The further investigation of the energetics of matter and electricity would carry us too far into thermochemistry, which must be left for separate treatment. The object of this section has been mainly to show the relation of the Volta Contact E.M.F. to atomic energies.

6. *The Neutron Structure of the Æther used for Calculation of its Density and Rigidity, and Deduction of the Velocity of Light.*

The electric doublet must be the basis of the electric and magnetic properties of the æther. The doublet of the æther, which I have proposed to call the neutron, may be represented as $\#$ and \flat in contact in the form of spherical shells of electricity of radius α . The electric moment of the neutron is $2\alpha e$. The inertia of electricity, contemplated by Maxwell and first calculated by J. J. Thomson, necessitates the existence of a definite amount of inertia in each neutron, and so necessitates a definite density of the æther. Moreover, if the neutrons are packed closely enough like the molecules of solid bodies, they will confer rigidity on the æther. An æther is conceivable having its neutrons free like the molecules of a gas, but exercising strong mutual directive influences through their polarities. For rapid shears this would act like a solid, for slow displacements like a gas. Thus from the electromagnetic properties of the electron we have deduced density and rigidity as essential properties of the æther. The postulates of the elastic and of the electric theories of light are but different expressions of the same things. Now the magnitude of α was estimated in “Cathode, Lenard, and Röntgen Rays” (Phil. Mag. [5] xlvii.) as 10^{-14} cms. on the assumption that the ratio I/e of the inertia I of a cathode projectile to its charge e , determined by J. J. Thomson, was

purely the ratio of the inertia of an electron to its charge and did not involve any "mass of a particle." The experiments of Kaufmann (*Compt. Rend.* Oct. 1902) have since proved that the mass associated with the electron in cathode rays is entirely electromagnetic. Several subsequent estimations have been made of α by various authors on the assumption that the inertia of the electron is purely electric. Kaufmann gives 10^{-13} cms., while Abraham in his comprehensive paper (*Ann. d. Ph.* [4] x. 1903) writes

$$10^{-13} < \alpha < 10^{-12} (28)$$

The equation by which these values have been calculated is that of J. J. Thomson (to a constant *près*)

$$I = 2e^2/3ac^2,$$

where c is the ratio of the two units of electricity.

If this inertia belongs to a cube of æther of edge 2α the density ρ of the æther is

$$\rho = e^2/12\alpha^4c^2 (29)$$

Now for the æther rigidity will be determined exactly as for a metal at absolute zero. The rigidity $N = \sigma^2$, where σ is the surface-density of the laminar distributions of electricity equivalent to the neutrons. So, just as in section 1, we write

$$\sigma^2 = \frac{2\pi}{3} \left(\frac{e}{4\alpha^2} \right)^2, \therefore N = 2\pi e^2/48\alpha^4 . . . (30)$$

The density and rigidity of the æther being found, we get the velocity of light by the formula

$$V = (N/\rho)^{\frac{1}{2}} = c(\pi/2)^{\frac{1}{2}} = 1.25c (31)$$

With $\rho = I \div 4\pi\alpha^3/3$ we would get $V = c\pi/12^{\frac{1}{2}} = .90c$. (32)

The coefficient of c ought to be 1, but numerical difficulties occur in connexion with the arbitrary adoption of spheres and cubes as standard shapes. The important point is that by exactly the same process as was applied to matter a rigidity has been found for the æther which, along with the density, gives the velocity of light. It should be noticed that N and ρ both vary as α^{-4} , and so α disappears in V . With e of the order 3×10^{-10} and $e/I = 6 \times 10^{17}$, we have α of the order 2×10^{-13} . Hence from (29) and (30) we get the values

$$\rho = 5 \times 10^9, \quad N = 8 \times 10^{30}.$$

These huge values for the density and rigidity of the æther result from the small value of α being raised to the power -4 . They may be taken as upper limits, for an æther made of

electrons in contact. If the electrons in the æther, instead of being in contact, formed doublets at the centre of massless spheres made of æther, the density and rigidity of the whole æther due to the doublets would be reduced by a factor obtained by raising the ratio of α to the radius of the æther sphere to the power 4. We have of late, however, been familiarized again with the conception of a very dense and proportionally rigid æther (for example, Reynolds, 'Scientific Papers,' vol. iii., finds for his granular medium a density 10^4). At present we are concerned with working out the consequences of the electron theory. On being applied to the æther it leads to the above density and rigidity, which cannot be dismissed for their absurdity merely because of their magnitude. Other lines of inquiry will have to furnish the data necessary for decisive determinations.

Although the æther has been likened above to a metal at absolute zero, it is different inasmuch as it probably always contains as much electrokinetic energy as electrostatic. If the two electrons are rotating round their centre of inertia with linear velocities u , their total electrostatic energy can be immediately written down and their total electrokinetic energy obtained according to Heaviside (Phil. Mag. [5] xxvii.). First, for the electrokinetic energy of each electron due to its own translatory motion we have $e^2u^2/3V^2\alpha$. Again, if each electron has an angular velocity of rotation ω about an axis, its kinetic energy will be $\alpha^2\omega^2I/3$.

The potential energy of the electricity of an electron is $e^2/2\alpha$. Thus, then, the self-energy of the two electrons is

$$2e^2u^2/3V^2\alpha + 2\alpha^2\omega^2I/3 + e^2/\alpha \dots \dots (33)$$

For their mutual kinetic energy we have e^2u^2/V^2r ; if r is the distance between their centres, and their mutual potential energy is $-e^2/r$, so that the total mutual energy is

$$e^2u^2/V^2r - e^2/r \dots \dots \dots (34)$$

According to the investigations of Thomson, Heaviside, Searle, and Abraham the formulæ for the electrokinetic energy hold only when u/V is small. For larger values of u/V the kinetic energy is no longer given by half the product of an inertia and the square of the velocity. It seems to me, however, that there is a promising line of research in assuming that for all values of u/V kinetic energy is given by the expressions used above, and in deducing what modifications are required in the fundamental laws of electromagnetism to bring them into harmony with the principle that electric kinetic energy is always the product of the

square of the velocity and half the constant inertia. Thus in (34), when $u=V$ the total mutual energy is nil. The kinetic and potential parts of the self-energy become equal if

$$\alpha^2 \omega^2 I = u^2 e^2 / 2V^2 \alpha, \quad \text{i. e. if } \alpha^2 \omega^2 = 3u^2/4. \quad (35)$$

The velocity of light then is such, that if possessed by the electrons of a neutron it would make their mutual energy nil, and, subject to (35), would make their total energy consist of two equal parts, kinetic and potential. I have shown in "The Electric Origin of Molecular Attraction" that the energy of an electrostatic field, according to the neutron theory of the æther, is stored in the æther half as kinetic and half as potential energy. It would seem then as though the velocity of light through the æther is connected with the velocity of its electrons in much the same way as the velocity of sound through a perfect gas is related to the translatory mean velocity of its molecules, a possibility contemplated by the founders of the kinetic theory of gases, with the æther a gas.

One other point demands immediate attention. According to the electromagnetic theory the velocity of light is $(K\mu)^{-\frac{1}{2}}$, and much discussion has centred round the dimensions and the nature of K and μ . FitzGerald suggested (Phil. Mag. [5] xxvii.) that both K and μ are the inverse of a velocity. Let us express this by putting

$$\left. \begin{aligned} K &= c/U, & \mu &= 1/cU' \dots \dots \text{in electrostatic units} \\ K &= 1/cU, & \mu &= c/U' \dots \dots \text{in electromagnetic units} \end{aligned} \right\} \quad (36)$$

The ratio of the two units is c , and for the free æther we have $c=U=U'=V$. But in the æther of matter, by which we mean the æther enclosed by the smallest spheres circumscribing each atom, we cannot write $U=U'$, but if v is the velocity of light through matter, we must have $v^2=UU'$. FitzGerald considered that possibly the velocities $1/K$ and $1/\mu$ are proportional to the square root of the mean turbulence of the æther. So we shall take U to be the velocity of the electrons in the æther. In the æther of matter the velocity of light is different from that in free æther, so that for it we cannot write $c=U=V$. But for most substances μ retains nearly the same value as in æther, so that U' , even in the æther of matter, generally has a value close to that of U in free æther. We might provisionally regard U' as a velocity derived from the angular velocity of rotation of electrons round their own centres. In free æther it is equal to the translatory velocity U of the electrons, and in the æther of matter retains the same value as in free æther, because

velocities of rotation are not changed by the proximity of matter in the same way as those of translation. These stipulations then give us Maxwell's law $K=n^2$. As is now well known, many substances like water have different values of K , according to the circumstances of measurement, this phenomenon being connected with molecular structure and to be allowed for in the interpretation of Maxwell's law. In "The Dielectric Capacity of Atoms" (Austr. Assoc. Adv. Sc. Jan. 1904) I have shown that values of K for the stuff of ions can be calculated from the ionic velocities, and that for the values found for many atoms the following law holds :

$$(K/\nu)^2 B = \text{constant}, \dots \dots \dots (37)$$

where B is the volume of the atom and ν its valency.

This makes $\nu^2 U^2/B = \text{constant}.$ (38)

When $\nu=1$ we have U^2/B constant, and IU^2/IB also constant; and as we assume I to be constant, we have the kinetic energy of translation of the æther in all monad atoms the same per unit volume. For atoms of higher valency it would appear that the effective inertia of the æther of the atom for translatory motion is proportional to ν^2 . This relation would establish a connexion between the æther of an atom and its valency, that is between the special doublets which confer its valency on an atom and the neutrons of the æther. This requires further investigation. It is noteworthy that the translatory kinetic energy of the neutrons in a monad atom is the same per unit volume in all atoms, just as in all gases at the same pressure and temperature the translatory kinetic energy per unit volume is the same. FitzGerald's idea is substantially the same as Fresnel's, who took the ratio of density of æther in matter to density of free æther, or ρ/ρ_e , to be equal to the square of the index of refraction, which by Maxwell's law becomes equal to K . But if the translatory momentum of the neutrons per unit volume is the same in æther everywhere, then $U\rho = V\rho_e$ and $\rho/\rho_e = V/U = K$, which shows that FitzGerald's principle brings us back to Fresnel's important law. It should be noticed that in the foregoing we have taken account of three distinct ways in which kinetic energy can exist in the æther : first by rotation of an electron round its centre, connected with magnetic permeability of the æther ; second by rotation of neutron, which is the same as translation of electron ; and third by motion impressed on the doublets of matter by the atoms, this being the origin of radiation.

Melbourne, February 1904.

LIV. *Kinetics of a System of Particles illustrating the Line and the Band Spectrum and the Phenomena of Radioactivity.*
 By H. NAGAOKA, Professor of Physics, Imperial University, Tôkyô*.

SINCE the discovery of the regularity of spectral lines, the kinetics of a material system giving rise to spectral vibrations has been a favourite subject of discussion among physicists. The method of enquiry has been generally to find a system which will give rise to vibrations conformable to the formulæ given by Balmer, by Kayser and Runge, and by Rydberg. The characteristic difference between the line- and the band-spectrum in the magnetic field has scarcely been touched upon in these theoretical investigations. Instead of seeking to find a system whose modes of vibration are brought into complete harmony with the regularity observed in spectral lines, inasmuch as the empirical formulæ are still a matter of dispute, I propose to discuss a system whose small oscillations accord qualitatively with the regularity observed in the spectra of different elements and by which the influence of the magnetic field on band- and line-spectra is easily explicable. The system here considered is quasi-stable, and will at the same time serve to illustrate a dynamical analogy of radioactivity, showing that the singular property is markedly inherent in elements with high atomic weights. It must, however, be borne in mind that out of the manifold structure of systems that may exist enjoying the said properties, the one here presented is perhaps the most easily conceivable, although the actual arrangement in a chemical atom may present complexities which are far beyond the reach of mathematical treatment.

The system, which I am going to discuss, consists of a large number of particles of equal mass arranged in a circle at equal angular intervals and repelling each other with forces inversely proportional to the square of distance; at the centre of the circle, place a particle of large mass attracting the other particles according to the same law of force. If these repelling particles be revolving with nearly the same velocity about the attracting centre, the system will generally remain stable, for small disturbances, provided the attracting force be sufficiently great. The system differs from the Saturnian system considered by Maxwell in having repelling particles instead of attracting satellites. The present case will evidently be *approximately* realized if we replace these satellites by negative electrons and the attracting centre by a

* Read before the Physico-Mathematical Society, Tôkyô, Dec. 5th, 1903. Communicated by the Author.

positively charged particle. The investigations on cathode rays and radioactivity have shown that such a system is conceivable as an ideal atom. In his lectures on electrons, Sir Oliver Lodge calls attention to a Saturnian system which probably will be of the same arrangement as that above spoken of. The objection to such a system of electrons is that the system must ultimately come to rest, in consequence of the exhaustion of energy by radiation, if the loss be not properly compensated.

To begin with, it is necessary to show that the system is stable. Denoting the distance of particle k from the centre of mass by R_k , the total energy of the system by U , and the potential energy by V , we can easily prove that

$$\frac{d^2}{dt^2} \sum m R_k^2 = 2U - 2V, \dots \dots (1)*$$

for the law of force varying as the inverse square of distance. In order that $\sum m R_k^2$ may remain finite, it is necessary that $2U - V$ should neither be always positive nor always negative, but assume oscillating values. Let the distance between the particles k and l be r_{kl} , the repulsion between them $\frac{e^2}{r_{kl}}$, the radius vector of the disturbed circular orbit r_k , and the attraction between k and the central particle $\frac{Ee}{r_k}$, the angular velocity about the centre ω_k , then approximately

$$2U - V = \sum m \omega_k^2 r_k^2 + \frac{1}{2} \sum \sum \frac{e^2}{r_{kl}} - E \sum \frac{e}{r_k}$$

Remembering that $m \omega_k r_k^2 = \gamma_k$ represents angular momentum, which remains constant, we obtain

$$2U - V = \sum \frac{\omega_k \gamma_k}{r_k^2} + \frac{1}{2} \sum \sum \frac{e^2}{r_{kl}} - E \sum \frac{e}{r_k} \dots \dots (2)$$

Thus $2U - V$ will assume oscillating values, when r_k and r_{kl} are subject to small disturbances, provided the quantities e , E , and $\omega_k \gamma_k$ and the mean values of r_k , r_{kl} are such that $2U - V$ assumes oscillating values, sometimes exceeding and sometimes falling short of zero. We notice at once that E must be very large compared to e .

The small oscillations of a particle may be radial or normal to the plane of the orbit, and those corresponding to the disturbance of r_{kl} will give rise to condensation and rarefaction of the particles arranged in a ring. The oscillations of

* Jacobi, *Vorlesungen über Dynamik, Werke*, Supplementband, p. 29.

mutually attracting particles have already engaged the attention of Maxwell in his discussion of Saturn's rings; the equations here to be considered are nearly of the same form as those given by Maxwell, but they can be conveniently deduced by means of Lagrange's equation.

Let the radius of the undisturbed orbit be a and the position of any two particles (1) and (2) subtending an angle 2θ at the centre be given by polar coordinates r, ϕ, z , such that

$$\begin{aligned} r_1 &= a(1 + \rho_1), & r_2 &= a(1 + \rho_2), \\ \phi_1 &= s + \omega_1 t + \sigma_1, & \phi_2 &= s + \omega t + \sigma_2 + 2\theta, \\ z_1 &= a \zeta_1, & z_2 &= a \zeta_2. \end{aligned}$$

The radial and angular disturbances are given by ρ and σ respectively, and the transversal displacement by ζ .

The potential of particle (2) at point r_1, ϕ_1, z_1 is given by

$$V_{12} = -\frac{e}{r_{12}} = -\frac{e}{\sqrt{r_1^2 + r_2^2 - 2r_1 r_2 \cos(\phi_2 - \phi_1) + (z_2 - z_1)^2}}$$

Since

$$r_{12} = 2a \sin \frac{\phi}{2} \left[1 + \rho_1 + \rho_2 + \rho_1 \rho_2 + \frac{(\rho_1 - \rho_2)^2}{4 \sin^2 \theta} + \frac{\zeta^2}{4 \sin^2 \theta} \right]^{\frac{1}{2}},$$

we find by expanding ϕ

$$\begin{aligned} \frac{1}{r_{12}} &= \frac{1}{2a \sin \theta} \left\{ 1 - \frac{\rho_1 + \rho_2 + \rho_1 \rho_2}{2} + \frac{3}{8} (\rho_1 + \rho_2)^2 - \frac{(\rho_1 - \rho_2)^2}{8 \sin^2 \theta} - \frac{\zeta^2}{8 \sin^2 \theta} \right\} \\ &\times \left\{ 1 - \frac{(\sigma_2 - \sigma_1)}{2} \cot \theta + \frac{(\sigma_2 - \sigma_1)^2}{8} (1 + 2 \cot^2 \theta) \right\}. \quad (3) \end{aligned}$$

By simple differentiation,

$$\left. \begin{aligned} -\frac{\partial V_{12}}{\partial r_1} &= -\frac{\partial V_{12}}{a \partial \rho_1} = \frac{e}{4a^2 \sin^2 \theta} \left\{ 1 - \frac{\sigma_2 - \sigma_1}{2} \cot \theta \right. \\ &\quad \left. + \frac{\rho_1 - \rho_2}{2} \cot^2 \theta (\rho_1 + \rho_2) \right\} \\ -\frac{\partial V_{12}}{r_1 \partial \phi_1} &= -\frac{\partial V_{12}}{a(1 + \rho_1) \partial \sigma_1} = \frac{e \cos \theta}{4a^2 \sin^2 \theta} \left\{ 1 - \frac{3\rho_1 + \rho_2}{2} \right. \\ &\quad \left. + \frac{\sigma_1 - \sigma_2}{2} (\tan \theta + 2 \cot \theta) \right\} \\ -\frac{\partial V_{12}}{\partial z_1} &= -\frac{\partial V_{12}}{a \partial \zeta_1} = \frac{e(\zeta_2 - \zeta_1)}{8a^2 \sin^3 \theta} \end{aligned} \right\} \quad (4)$$

neglecting small quantities of second order.

Suppose that the disturbances are propagated round the ring in waves with velocity $\frac{n}{h}$ for ρ , σ , and $\frac{n'}{h}$ for ζ , and therefore given by

$$\begin{aligned} \rho_1 &= A \cos (nt + \alpha + hs) & \rho_2 &= A \cos (nt + \alpha + 2h\theta + hs) \\ \sigma_1 &= B \sin (nt + \alpha + hs) & \sigma_2 &= B \sin (nt + \alpha + 2h\theta + hs) \\ \zeta_1 &= C \cos (n't + \gamma + hs) & \zeta_2 &= C \cos (n't + \gamma + 2h\theta + hs) \end{aligned}$$

where $h=1, 2, 3, \dots$

Putting for simplicity $u=nt + \alpha + hs$, $u'=n't + \gamma + hs$, we have

$$\begin{aligned} \rho_1 - \rho_2 &= -2A \cos u \sin^2 h\theta - A \sin u \sin 2h\theta, \\ \sigma_1 - \sigma_2 &= 2B \sin u \sin^2 h\theta - B \cos u \sin 2h\theta. \end{aligned}$$

Denoting the number of particles in a ring by ν , let

$$\theta = \frac{\pi}{\nu}, \quad \frac{2\pi}{\nu}, \quad \frac{3\pi}{\nu}, \dots, \frac{(\nu-1)\pi}{\nu}$$

$$\left. \begin{aligned} L &= \sum \left(\frac{1}{2} \frac{\sin h\theta \cos \theta}{\sin^2 \theta} - \frac{\cos^2 h\theta}{\sin \theta} \right) \\ M &= \sum \frac{\sin 2h\theta \cos \theta}{4 \sin^2 \theta} \\ N &= \sum \left(\frac{\sin^2 h\theta \cos^2 \theta}{\sin^3 \theta} + \frac{1}{2} \frac{\sin^2 h\theta}{\sin \theta} \right) \\ J &= \sum \frac{\sin^2 h\theta}{3 \sin^3 \theta} \\ K &= \sum \frac{1}{2 \sin \theta} \end{aligned} \right\} \dots (6)$$

where the summation extends to all possible values of θ . Suppressing the suffix in r_1, ϕ_1, z_1 , we find

$$\left. \begin{aligned} \frac{\partial V}{\partial r} &= \sum \frac{\partial V_{12}}{\partial r_1} = \frac{e}{2a^2} \{K + (LA - MB) \cos u\} \\ \frac{\partial V}{r \partial \phi} &= \sum \frac{\partial V_{12}}{r_1 \partial \phi_1} = \frac{e}{2a} (MA + NB) \sin u \\ \frac{\partial V}{\partial z} &= \sum \frac{\partial V_{12}}{\partial z_1} = -\frac{e}{2a^2} J \cos u' \end{aligned} \right\} \dots (7)$$

The kinetic energy of the particle at point r, ϕ, z is given by

$$T = \frac{1}{2}m \left\{ \left(\frac{dr}{dt} \right)^2 + r^2 \left(\frac{d\phi}{dt} \right)^2 + \left(\frac{dz}{dt} \right)^2 \right\}.$$

By Lagrange's equation

$$\begin{aligned} \frac{d}{dt} \left(\frac{\partial T}{\partial r} \right) - \frac{\partial T}{\partial r} &= ma \frac{d^2 \rho}{dt^2} - ma(\omega^2 + \omega^2 \rho + 2\omega \frac{d\sigma}{dt}) \\ &= -\frac{eE}{r^2} - e \frac{\partial V}{\partial r}, \end{aligned}$$

with similar expressions for ϕ and z .

Thus, we obtain as the equations of motion

$$\left. \begin{aligned} \frac{d^2 \rho}{dt^2} - \omega^2 - \omega^2 \rho - 2\omega \frac{d\sigma}{dt} &= -\frac{eE}{ma^3} + \frac{2eE}{ma^3 \rho} \\ &\quad - \frac{e^2}{2ma^3} \{ K + (LA - MB) \cos u \} \\ \frac{d^2 \sigma}{dt^2} + 2\omega \frac{d\rho}{dt} &= -\frac{e^2}{2ma^3} (MA + NB) \sin u \\ \frac{d^2 \zeta}{dt^2} &= -\frac{eE\zeta}{ma^3} + \frac{e^2}{2ma^3} J \cos u' \end{aligned} \right\} \quad (8)$$

From the last of the equations of motion (8), we find that the frequency of transversal oscillation n' is given by

$$n' = \pm \sqrt{S - \mu J}, \dots \dots \dots (9)$$

where S stands for $\frac{eE}{ma^3}$, and μ for $\frac{e^2}{2ma^3}$. From the condition of stability, we suppose that E is very large compared to e . When the number of particles ν is considerable, we notice from (6) that J can be expanded in a series of the form

$$J = A_j h^2 + B_j h^4 + \dots$$

Consequently,

$$\pm n' = \omega_0' - a_j h^2 + b_j h^4 + \dots \dots \dots (10)$$

where ω_0' is the principal constant term, and $a_j > 0$ and nearly proportional to $\frac{\nu^2}{\omega}$. For small values of h , n' lie very near each

other, but as h increases, the interval gradually becomes larger and ultimately reaches a maximum. The interval between successive frequencies decreases as h is increased. Constructing the frequency lines as functions of h , we find a

close resemblance with the band-spectrum, as shown in the figure. In fact, the above equation is but an extension of Deslandres' empirical formula in a slightly altered form*. It shows that the edges may lie either in the region of high or of low frequency. We shall afterwards find that the frequency is not affected by the external magnetic force, if the particles are supposed to be negative electrons.

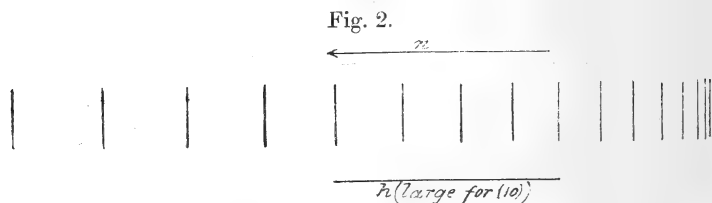
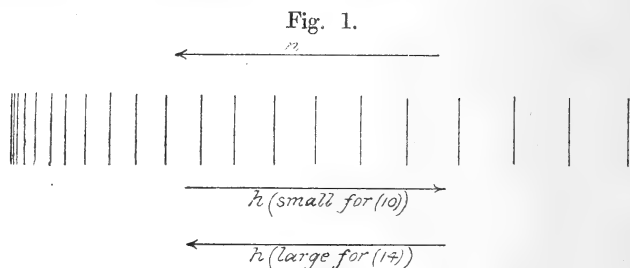

The remaining two equations of motion give the following equations for determining the frequency and the angular velocity ω about the attracting centre:—

$$\omega^2 - S - \mu K + (\omega^2 + 2S + n^2 - \mu L)A \cos u + (2\omega n + \mu M)B \cos u = 0,$$

$$2\omega n A + n^2 B - \mu(MA + NB) = 0.$$

These two equations show that

$$\omega^2 = S + \mu K, \dots \dots \dots (11)$$

$$n^4 - (3\omega^2 - 2S + \mu(L + N))n^2 - \mu N(\omega^2 + 2S - \mu L) + \mu^2 M^2 = 0. \quad (12)$$

Solving for n^2 , we find

$$n^2 = p \pm \left(p + \frac{q}{2p} - \frac{q^2}{8p^3} + \dots \right), \dots \dots (13)$$

* For large values of h , it is convenient to count the lines from the edge. For this purpose, put $h = h_0 - h'$, where h_0 gives the line at the edge; then

$$n = a + bh'^2 + ch'^3 + \dots \quad (h' = 1, 2, 3, \dots)$$

which is one of the empirical formulæ used by Kayser and Runge in the discussion of the cyanogen band (*Berlin Abh.* 1889).

where

$$\left. \begin{aligned} p &= \frac{\omega^2}{2} \left(1 + \frac{\mu(L+N+2K)}{\omega^2} \right) \\ q &= 3\omega^2 \left\{ \mu N - \frac{\mu^2[(L+2K)N+M]}{3\omega^2} \right\} \end{aligned} \right\} \dots \dots (13')$$

Remembering that L, N, and M are all expressible in a series of the form

$$a_0 + a_1 h^2 + a_2 h^4 + \dots,$$

a_0 being absent for the last two quantities, we find the value of n for + sign in (13)

$$\pm n = \omega_0 + Ah^2 + Bh^4 + \dots \dots \dots (14)$$

where $A > 0$ and $B < 0$ generally, and ω_0 is nearly equal to ω . The expression for n can also be put in the form

$$\pm n = \frac{\omega}{\sqrt{a + bh^2 + ch^4 + \dots}} \dots \dots \dots (14')$$

where a is nearly equal to unity, and $b < 0$ and nearly proportional to $\frac{v^2}{\omega^2}$.

Here we notice that waves of frequency n travel round the ring in opposite senses, so long as the particles are not acted on by extraneous forces. The frequency increases as h is increased, and the nature of the series shows that the spectral lines corresponding to these vibrations will gradually crowd together when h is large. The qualitative coincidence of the above result with the line-spectrum is at once evident, if h be not small. Diagrammatically represented, the arrangement of the lines will be as in fig. 1 already given, with h counted in the opposite sense.

An important difference between the present result and the empirical formulæ must not be forgotten. When h is very great, the difference between successive lines begins to diverge, but in the empirical formulæ given by various investigators in this field of research, the frequency ultimately tends to a limiting value. It seems doubtful if very large values of h will ever be observed.

In the present case, the particles must be very small compared to the attracting centre, in order that the ring may not collapse, when disturbances corresponding to large values of h are propagated round the ring.

Let us now compare the line- and the band-spectrum of the

present system. The frequency n for the line-spectrum is approximately given by

$$n^2 = \omega^2 + \mu(L + 4N + 2K).$$

For tolerably large values of h , $2L \doteq N \doteq 2J$; consequently

$$n^2 \doteq \omega_0^2 + 9\mu J.$$

For the frequency of the band-spectrum due to the same particles

$$n'^2 \doteq \omega_0^2 - \mu J.$$

Thus the successive difference of frequency for the same ring of particles is about nine times greater in the line than in the band-spectrum. The proximity of lines in the band-spectrum is well borne out by observation.

Observation shows that the Zeeman effect is only peculiar to the line-spectrum, while the band-spectrum is not affected by the magnetic force. If we suppose that the moving particles are electrons, then the force acting on any one of them, when the magnetic field is perpendicular to the plane of the orbit, would be radial and equal to $eHa \frac{d\phi}{dt} \doteq eHa\omega$.

The equation of motion is therefore modified by the introduction of the new term $eHa\omega$; consequently

$$\omega^2 = S + \mu K + \frac{eH}{m} \omega.$$

The waves travel round the ring with different velocities

$$\left. \begin{aligned} \omega_1 &= \sqrt{S + \mu K + \frac{eH}{2m}} \\ \omega_2 &= -\sqrt{S + \mu K + \frac{eH}{2m}} \end{aligned} \right\} \dots \dots (15)$$

All the line-spectra belonging to the same series appear as doublets, which are circularly polarized in opposite sense.

The magnetic force perpendicular to the plane of the orbit does not affect the transverse vibrations, but when the field H is parallel to the plane, the force

$$eH \cos \phi a \frac{d\phi}{dt}$$

normal to the plane of the orbit will be operative. This force is however oscillating, and its mean value is zero; it will therefore produce no sensible effect on the period of transversal oscillation which gives rise to band-spectrum of the present system.

The refined apparatus recently introduced by Michelson and Lummer in spectrum analysis have revealed a complex crowding of lines where formerly a single line was supposed to exist. In the present system, we have supposed that ν -particles are arranged in a circle, but in the actual case the particles may be at slightly different distances from the attracting centre, which was identified with a geometrical point. The hypothesis of a point centre would only be a rough approximation, and we have reason to believe that the complexity of the structure of spectral lines is a consequence most likely to be expected.

Where there are many series of spectra, we have to consider the same number of rings of particles, all of which may or may not lie in the same plane. The occurrence of doublets in elements of the alkaline group may be attributed to the separation due to magnetic force by other rings, but it is extremely improbable that the field is so great as to cause the observed separation. The mutual disturbances of the rings will again result in intricacy in the structure of the spectra. The two neighbouring rings will be so influenced as to give rise to forced waves, so that they perform oscillations which are participated in by other rings. Cases may occur where the resonance due to the oscillation of other atoms makes the amplitude extremely large and ultimately tears the ring. The most noteworthy is the influence of the amplitude of oscillation of one ring on others. It affects the period of the neighbouring ring to a slight extent and may cause the flutings of the spectrum-lines. Of course this may be looked upon as one cause of the broadening of lines, while various other causes tending towards the same effect will exist.

The admissible value of n is not confined to that already discussed in connexion with the line-spectrum; but taking the $-$ sign in (13), we obtain

$$\begin{aligned}
 n^2 &= - \left(\frac{q}{2p} - \frac{q^2}{8p^3} + \dots \right) \\
 &= -3\mu N + \frac{\mu^2 \{4N(L+2K+3N) + M^2\}}{\omega^2} \text{ nearly.} \quad (16)
 \end{aligned}$$

The principal term amounts to $-3\mu N$. The disturbance is then expressible in the form

$$\left. \begin{aligned}
 \rho &= (A\epsilon^{n_i t} + A'\epsilon^{-n_i t}) \cos u_0, \\
 \sigma &= (B\epsilon^{n_i t} + B'\epsilon^{-n_i t}) \sin u_0,
 \end{aligned} \right\} \dots \dots (17)$$

where $n_i \doteq \sqrt{3\mu N}$.

The motion of the ring will not be oscillating, but in course of time, if the disturbance be persistent, will acquire such an amplitude as to break the ring. In this case, the particles will fly away with enormous velocities, and the central particle will participate in the same motion, owing to the law of conservation of the centre of mass. If the particles be supposed to be negative electrons, they will disperse in various directions with great velocities, and the positively charged particle at the centre will also fly off. Here we have arrived at a mechanical analogy, which explains the production of α and β rays by the disintegration of the ideal atom. The results of calculation above expounded lead us to the conclusion that the phenomenon of radioactivity is remarkably exhibited in elements with high atomic weights. When

h is small, $N \doteq \frac{h^2 \nu^2}{\pi^2}$, consequently the disturbance of the ring with ν particles will be given by

$$\left. \begin{aligned} \rho &= A e^{k\nu t} \cos u_0, \\ \sigma &= B e^{k\nu t} \sin u_0, \end{aligned} \right\}, \dots \dots \dots (17')$$

after a certain time t , showing that the more massive the ring, the greater the disturbance, which is proportional to $e^{k\nu t}$. As most of the elements exhibit regular spectral lines, it appears that such rings as above described are generally to be found. It is more probable that massive rings will be found in elements with high atomic weights, and if the high atomic weight is accompanied by simple spectral lines, it needs no proving that ν in the rings must be greater than in elements with complex spectral series. In that case, the instability of the ring will immediately set in, and result in the expulsion of the particles. Radium enjoys the said property, the high atomic weight being accompanied by spectral lines which are far simpler than in iron or mercury.

If the spectra of the elements be due to the motion of electrons revolving in circular orbits, as above supposed, several rings of electrons must exist where there are different series of spectra, as in most of the elements. The resonance due to forces, whose periods coincide with those of the rings, will be most efficacious in causing the disturbance and also in placing it in an unstable state. The destruction of the rings will be easier if the innermost ring be torn asunder than if the outside one is, and, moreover, if these electrons are subject to electric forces, the dismembered electrons will fly away with accelerated velocity. The modes of vibration

which contribute to the instability of the system are those associated with the higher harmonics. This evidently lies in the region of small wave-length, and the destruction of the system will be easier for ultra-violet light to bring into effect, if the system will resonate to these oscillations. The actino-electric action may be the result of the destruction of atoms under the combined action of electric force, which places the electrons in a constrained state, and the resonance to ultra-violet rays of the period participated in by the rings. The dismemberment of the rings will result in the ionization of gas in the neighbourhood of the illuminated surface.

The same course of reasoning with regard to resonance seems to apply to the change of resistance often observed in semi-insulators. Apply electromotive force to a semi-insulator and pass the electromagnetic wave whose period coincides with that of the constituent atoms, then it will set the electrons in resonating vibration, break them from the revolving system, and thereby cause the flow of electrons and reduce the resistance of the circuit. This perhaps explains in a simple manner the change of resistance in selenium by exposure to light; that the green light is less effective than red or violet seems to give strong evidence to the resonating action.

The metals have usually a large number of spectral lines, extending from ultra-violet to the infra-red region. The exposure of metallic filings to electric waves has the same action as that of light in the case of selenium. Perhaps the same reasoning as above applies to this case, as the Hertz waves are more penetrating, and there will be a greater number of resonating atoms than when illuminated with visible light. The theory of the coherer is probably to be based on the footing that electric current consists in the stream of electrons set free by the incident electromagnetic wave.

As another example of forced oscillation I may mention the fluorescence or phosphorescence of certain substances, the vibrations of particles being excited either by light or by electromagnetic pulses. In the former phenomenon the action is apparently temporary, but remanent in the latter. In fact, the theory of luminiscence will be capable of further development on the line of reasoning here expounded.

There are various problems which will possibly be capable of being attacked on the hypothesis of a Saturnian system, such as chemical affinity and valency, electrolysis and many other subjects connected with atoms and molecules. The rough calculation and rather unpolished exposition of various phenomena above sketched may serve as a hint to a more complete solution of atomic structure.

LVI. *Some Spectroscopic Notes.* By ROBERT A. HOUSTOUN, M.A., B.Sc., *Research Student in the University of Glasgow*.*

§ 1. **I**N a communication made to the Royal Society ("On the Radiation of Helium and Mercury in a Magnetic Field," by Prof. A. Gray, F.R.S., and Walter Stewart, D.Sc., with Robert A. Houston and D. B. Macquistan, Proc. Roy. Soc. vol. lxxii. No. 477) certain measurements were given of the wave-lengths of the satellites of the green line in Hg. These measurements disagree with those of Fabry and Perot; they have since been verified, and there seems evidence to show that the satellite system of the green line varies considerably under different conditions.

According to Michelson (Phil. Mag. (5) xxxiv. p. 280, 1882) the green line of Hg is fourfold. It consists of a narrow bright line in the middle of a broader weaker one. Then follow three weaker lines towards the red (fig. 1), the values of $d\lambda$ being about +0.075, +0.100, and +0.125 Ångström units.

Fabry and Perot (*C. R.* 1898, p. 409) represent the line as having two attendant lines +.008 and +.092 (fig. 2).

Later they make it fivefold (*C. R.* 1899, cxxviii. p. 1156), one very weak component on the violet side, -0.044, and three on the red side, 0.009, 0.082, and 0.136 (fig. 3).

Finally, they make it sevenfold (P. Zeeman, *Astroph.*

Fig. 1.



Fig. 2.



Fig. 3.

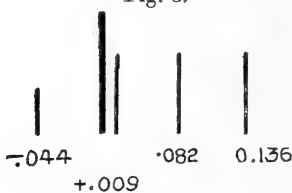
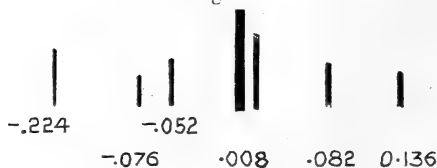

Fig. 4.



Journal, xv. p. 218), the differences being -0.224, -0.076, -0.052, 0.008, 0.082, and 0.136 (fig. 4).

* Communicated by Prof. A. Gray, F.R.S.

Our own measurements represent the line as sixfold when most highly developed, the distances of the satellites being -0.208 , -0.096 , -0.059 , $+0.032$, and $+0.067$, with the condition that these figures are right only to a multiple of $\cdot 164$ the distance between two successive orders. When a faint line is seen in the field—the echelon spectro-

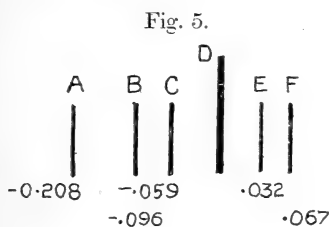

scope was the instrument with which our observations were made—the different orders of the central line D are very close together, and it is impossible to tell to what order the faint line belongs. Considerations of symmetry lead us to suppose that B C E and F are rightly placed. It is quite as probable that A is on the other side of D at a distance of $+0.256$.

These measurements were made on an ordinary Geissler tube with aluminium electrodes, and were verified on a tube the electrodes of which were little mercury cups. The tubes were fed from an induction-coil that gave a 10-inch spark. The E.M.F. in the primary was usually 6 volts.

The system did not always appear as above. B and C appeared at times as one, as so also did E and F. In that case the distance of (B C) was $\cdot 084$, and of (E F) $\cdot 069$. Then B C might be a doublet and E F a single line, or the system might reduce to two satellites corresponding to A and the unresolved doublet B C. It was usually thus when a less powerful induction-coil was used.

Although Zeeman did not measure the position of the satellites with his echelon (which is slightly less powerful than ours), he apparently obtained the same arrangement, for he says, in the article quoted above: "Using the echelon in a position in which two strong lines of equal intensity corresponding to successive orders of the radiation were visible, I could distinguish also five faint, very narrow lines between the principal ones. The distance between two pairs of these lines was very small."

The doublets (B C) and (E F) at times appeared as single lines. The single line was not the doublet badly defined; its width was not greater than that of one of the components of the doublet. Capacity and inductance in the primary and secondary had no effect on the satellites. They were usually seen best when the hammer of the induction-coil was going jerkily—when it was screwed up, so that its spring was short.

The bright yellow line of Hg 5790 was also investigated, and was found as in fig. 6, B being so close to C as sometimes not to be distinguished from it. Calculating the distance $d\lambda$ from an imaginary line between C and D from observations made at three different times, we get

Fig. 6.

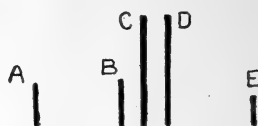

| | | | |
|---------|-------|-------|-------|
| A | -·203 | -·133 | -·180 |
| B | -·072 | -·081 | |
| C | -·032 | -·031 | -·035 |
| D | +·032 | +·035 | +·039 |
| E | +·139 | +·139 | +·157 |

On one occasion while we measured the differences, the frequency of the hammer changed and the line A was seen to move further out. This was seen only once. The satellite systems are of course exactly the same when viewed across and along the direction of discharge ; and no component is ever plane-polarized.

§ 2. These two lines were also examined in the electric arc, the soft core of the lower carbon being bored out, a rubber tube being fastened to its lower end and connected to a mercury reservoir, by raising and lowering which the supply of Hg vapour in the arc could be altered, when some extraordinary cases of reversal were observed. These remained steady for long. Figs. 7 & 8 represent what the green line reversed into. Here the light maxima were rather bands than lines. $d\lambda$ is given as if the lines were satellites, for which they were at first taken.

Fig. 7.

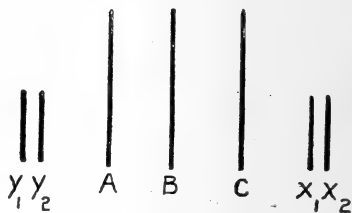

Fig. 8.

| | | | | |
|--------|--------|--------|-------|-----------|
| Y_1 | Y_2 | A | C | |
| -0·195 | -0·153 | -0·093 | 0·065 | |
| | X_1 | X_2 | | |
| | 0·140 | 0·167 | | |
| | | | | G H L M N |

The numbers represent distances from B.

Similar measurements for fig. 8, taken from a point midway between L and M, are

| | | | | |
|--------|--------|--------|-------|-------|
| G | H | L | M | N |
| -0·246 | -0·130 | -0·032 | 0·032 | 0·121 |

Finally, the satellite system was obtained as in the vacuum tube (fig. 5). The results were :—

| | | | | |
|--------|--------|--------|-------|-------|
| A | B | C | E | F |
| -0.227 | -0.106 | -0.056 | 0.046 | 0.084 |

Fig. 9.

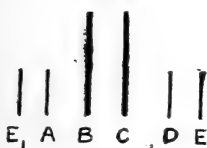

A striking reversal effect (fig. 9) was also obtained for the yellow line in the arc. E was very faint; E₁ is E in the next order. Measuring from a point midway between B and C we have

| | | | | |
|-------|-------|-------|-------|-------|
| A | B | C | D | E |
| -0.14 | -0.05 | +0.05 | +0.16 | +0.29 |

The current varied from 5 to 7 amperes during the above measurements.

Readings were also made on the lines of zinc in the electric arc. The zinc was introduced into the arc by boring the lower carbon which was the anode, and packing strips of thin zinc sheeting into the hole. Again some very striking forms of reversal were obtained. They did not maintain themselves so long as in the case of Hg, and passed out of the one form into the other frequently when I was making measurements on them. It was easier to recognize the zinc lines as being reversed. Changes took place in the reversal system when the arc began to hiss. Also the distance between the different bands varied in the different parts of the arc, being greater and better defined near the anode A; being small but well-defined at the edges B, and being as a rule ill-defined towards C.

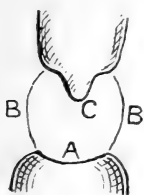

Fig. 10.

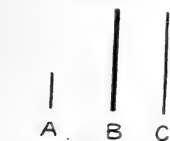
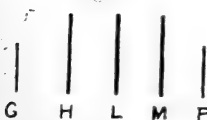

Fig. 11.



Fig. 12.



Each of the four lines, the red and the three blue (6361, 4812, 4721, and 4681) reversed roughly speaking in three types, figs. 10, 11, & 12. Let us take the measurements for the case of 4812, the bright blue line. Measuring the wave-length differences in the three cases from B, E, and L, we obtained

| | | |
|----------|------|-------|
| Fig. 10. | C... | +0.05 |
| Fig. 11. | D... | -0.06 |
| | F... | +0.06 |
| Fig. 12. | G... | -0.19 |
| | H... | -0.08 |
| | M... | +0.08 |
| | P... | +0.16 |

P may, however, be G in the next order.

Using a different arc-lamp and a smaller quantity of Zn, I was able to get the lines without reversals. The red line ($\lambda=6361$) was single. The

three blue lines (4812, 4721, 4681) are all doublets, the components being of equal intensity. For 4812 $d\lambda$ is 0.09, for 4721 0.08, and for the third line something similar.

Examining Hg vapour under the same conditions, the green line appeared with two satellites, one corresponding to A (fig. 5) and the other to the doublet (BC), while the yellow line appeared as a double line with a weak component towards the red. For the green line $d\lambda = -0.24, -0.08$, and for the yellow $-0.06, +0.12$.

The nickel line (5476) and the Na D lines were single.

The red C line of hydrogen was double, $d\lambda$ being $=0.065$, or about one-half Michelson's value. This explains why the line does not appear double in the first-order spectrum of a Rowland's grating.

It seems on the whole tolerably certain that the satellites of the green line of Hg vary in number and position with the conditions of the source. What these determinative conditions are it is difficult to say.

We can look on the multiple reversals of the lines as being made up of simple reversals of the components of the complex spectral lines. This seems more probable than alternate layers of radiating vapours at different temperatures, as it is difficult to see how these alternate layers can arise. The above measurements were made with a micrometer eyepiece and not on a photographic plate. This explains probably why such reversal effects are not more frequently seen.

§ 3. The echelon used for the above observations was made and mounted by A. Hilger. The telescope and collimator were both fixed and mounted on the one stand. The echelon rested on a platform between them ; by moving this about a vertical axis, the different images could be brought into the field of view. The rays of light from the collimator do not fall normally on the echelon. In the discussion usually given it is assumed that they do so, that the collimator and echelon remain fixed and that the telescope moves. The formulæ are the same for both cases, though the discussion is slightly different. I have derived the formulæ for the case of the fixed telescope, using the graphical method given in Preston's 'Light,' and as the echelon spectroscope illustrates this method very neatly the discussion is given here.

It will be well to describe the appearances seen in the field. First of all, if the instrument is focussed on a well-defined line we see several images of it in the field. As the echelon is rotated these images cross the field, and as each crosses the centre of the field it gets very much brighter. In fact it is only the two or three in the centre of the

field that are usually noticed. This is the interference effect.

If a bright line upon a faint background is being examined, in addition to the above images we see a broad band in the centre of the field, and on each side of it a number of bands which are narrower and very much fainter. As many as eleven of these bands may be seen on both sides. This is the diffraction effect. The two effects are seen superimposed as

Fig. 13.

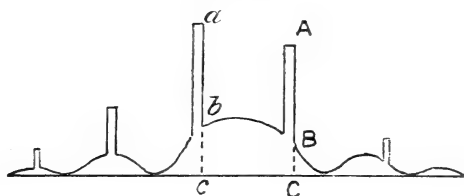

in fig. 13. If the echelon is now rotated the diffraction effect remains practically steady in the field, and the interference images move across the diffraction-bands, becoming very much brighter when they cross the centre of the chief diffraction-band. If we are examining a continuous spectrum we see only the diffraction effect. In the intensity-curve $\frac{bc}{ac}$ as $\frac{BC}{AC}$ &c.

Fig. 14.

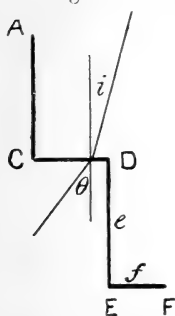

Let the figure represent two adjacent steps of an echelon. Let f be the width of a step (E F) and e the length of a step (D E). Let there be n complete steps. Let the angle of incidence of the light-rays be i , and let us consider those rays that leave the echelon in the direction θ . Let us consider all the rays which cross the face C D. They will all suffer a change of phase relative to the extreme ray through C. The path through D is longer than the path through C by

$$f(\sin \theta - \mu \sin i).$$

If we denote the relative angular phase-difference by $2F$,

$$f(\sin \theta - \mu \sin i) = \lambda \frac{2F}{2\pi}.$$

Similarly, if we denote by $2E$ the angular phase-difference that the light which travels through E suffers relative to that

which travels through D

$$e(\mu \cos i - \cos \theta) = \lambda \frac{2E}{2\pi}.$$

Now all the rays for which θ is the same will terminate in one point in the focal plane of the telescope. The amplitude and phase in that point will be obtained by compounding the amplitudes and phases due to the different paths. Then by Preston's 'Light,' § 150, the resultant amplitude due to one aperture (i. e. e , the faces f are ground) is proportional to $\frac{f \sin F}{F}$. It will depend also on the angles i and θ , but we disregard that at present. By analogy with Preston's 'Light,' p. 266, I, the resultant intensity in the direction θ , is given by

$$I = \frac{f^2 \sin^2 F \sin^2 n(E + F)}{F^2 \sin^2(E + F)} \dots \dots \dots (1)$$

The variation of the first factor with F is discussed in Preston, § 151. It gives the ordinary diffraction effect. If the intensity of the first maximum is 1, the intensities of the succeeding maxima are $\frac{1}{20}$, $\frac{1}{36}$, and $\frac{1}{110}$. The principal maximum corresponds to $F=0$, i. e.

$$\sin \theta - \mu \sin i = 0$$

This equation gives the "no deviation" position. For if we consider the ray represented in the diagram its deviation is $\theta - r$. But $\sin r = \mu \sin i$, hence its deviation is $\theta - \sin^{-1} \mu \sin i$, and this is zero when $\sin \theta - \mu \sin i = 0$. The principal diffraction maximum should always appear in the centre of the field, no matter what the angle r is, i. e. no matter how the echelon is rotated. I tested this by rotating the echelon, so that r increased from 0° to about 5° , which was all the range that the adjustment permitted.

The diffraction maximum did not, however, remain always equally bright and equally broad exactly in the same place; the intensity diminished so that the visible breadth became less, and there was a slight motion of the maximum in the direction in which θ grows smaller. The width of the maximum decreased more on the one side. This apparent motion can be explained by adding an obliquity factor, depending on i and θ , to the expression for the intensity, to represent the effect that was disregarded above. For the positions of minimum

Fig. 15.

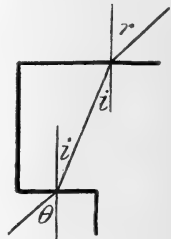

deviation i depends on θ . Suppose this factor expressed as a function of θ and plotted as a curve. Let the value of the ordinate decrease and the gradient increase with θ . Then the shape of the diffraction maximum will be obtained by

Fig. 16.

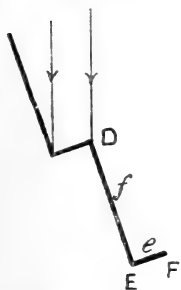

multiplying it by the appropriate portion of this curve. The apparent displacement of the diffraction maximum depends on the gradient, and the diminution of the intensity on the ordinate of this obliquity curve. The loss of the intensity has also another more important cause. f is more than ten times e . Consequently, as i or θ increases, the proportion of light that is wasted in diffuse reflexion on the opaque faces f increases very rapidly.

§ 4. The second or interference factor

$\frac{\sin^2 n(\mathbf{E} + \mathbf{F})}{\sin^2(\mathbf{E} + \mathbf{F})}$ is discussed in Preston, § 157, where it is shown that there are maxima of intensity

$$I = n^2$$

in the direction given by $\mathbf{E} + \mathbf{F} = p\pi$ or

$$e(\mu \cos i - \cos \theta) + f(\sin \theta - \mu \sin i) = p\lambda. \quad (2)$$

Fig. 17.

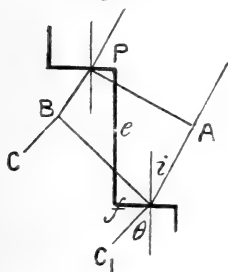

If we put $i=0$, this equation becomes the ordinary equation for the echelon spectroscope. It can be derived directly by considering two rays which leave corresponding points in two neighbouring apertures. Their path difference is

$$\mu(e \cos i - f \sin i) - (e \cos \theta - f \sin \theta),$$

And θ is the direction of an image when the path difference is equal to an integral number of wave-lengths, $i. e. = p\lambda$.

In addition to these principal maxima the interference factor has $(n-2)$ subsidiary maxima between every two adjacent principal maxima. The ratio of the intensity of one of these secondary maxima to the intensity of one of the chief maxima is

$$\frac{1}{1 + (n^2 - 1) \sin^2(\mathbf{E} + \mathbf{F})}$$

Rewrite equation (2), putting $\theta = \mu i + \Delta\theta$. Then $\Delta\theta$ is

the angular distance of an image in the focal plane of the telescope from the no deviation position, the angle being subtended at the centre of the object-glass. Therefore

$$\begin{aligned} & \mu(e \cos i - f \sin i) - (e \cos \mu i - f \sin \mu i) \\ & + (e \sin \mu i + f \cos \mu i) \Delta \theta_1 = p \lambda. \quad (3) \end{aligned}$$

Suppose now we have also light of a wave-length slightly different from λ . Then let us suppose that the echelon remains in the same position. This new radiation will produce an image given by $\Delta \theta_2$. Thus we have

$$\begin{aligned} & (\mu + d\mu)(e \cos i - f \sin i) - (e \cos \mu i - f \sin \mu i) \\ & + (e \sin \mu i + f \cos \mu i) \Delta \theta_2 = p(\lambda + d\lambda). \quad (4) \end{aligned}$$

Subtracting (3) from (4),

$$d\mu(e \cos i - f \sin i) + (e \sin \mu i + f \cos \mu i) d\theta_1 = p d\lambda, \quad (5)$$

where $d\theta_1 = \Delta \theta_2 - \Delta \theta_1$, *i. e.* is the angular distance between the two images.

Since i is small this becomes

$$d\theta_1 = \frac{p d\lambda - e d\mu}{f} \dots \dots \dots (6)$$

Let the next order image of the radiation λ be given by $\Delta \theta_3$. Then

$$\begin{aligned} & \mu(e \cos i - f \sin i) - (e \cos \mu i - f \sin \mu i) \\ & + (e \sin \mu i + f \cos \mu i) \Delta \theta_3 = (p + 1)\lambda. \quad (7) \end{aligned}$$

Subtracting (3) from (7),

$$(e \sin \mu i + f \cos \mu i) d\theta_2 = \lambda, \quad (8)$$

where $d\theta_2 = \Delta \theta_3 - \Delta \theta_1 =$ angular distance between two orders. If i be small we obtain

$$d\theta_2 = \frac{\lambda}{f}.$$

The value of p is approximately $\frac{(\mu - 1)e}{\lambda}$. Therefore

$$\begin{aligned} \frac{d\theta_1}{d\theta_2} &= \frac{\frac{(\mu - 1)e d\lambda}{\lambda} - e d\mu}{\lambda} \\ &= -e \frac{d\lambda}{\lambda^2} - e d\left(\frac{\mu}{\lambda}\right). \quad (9) \end{aligned}$$

This is the usual formula for evaluating an angular distance in Ångström units.

To find the resolving power: if we consider the interference factor $\frac{\sin^2 n(E+F)}{\sin^2(E+F)}$, it = 0 for $n(E+F) = m\pi$. If m be a multiple of n however, then $E+F$ is a multiple of π , and we obtain a chief maximum. The minimum adjacent to this maximum is then

$$E + F = \frac{m+1}{n}\pi,$$

i. e. $e(\mu \cos i - \cos \theta) + f(\sin \theta - \mu \sin i) = \frac{m+1}{n}\lambda$;

putting $\theta = \mu i + \Delta\theta_1$ for the maximum

$$\begin{aligned} \Delta\theta_1(e \sin \mu i + f \cos \mu i) &= \frac{m}{n}\lambda - \mu(e \cos i - f \sin i) \\ &+ (e \cos \mu i - f \sin \mu i), \quad \dots \quad (10) \end{aligned}$$

and for the adjacent minimum

$$\begin{aligned} \Delta\theta_2(e \sin \mu i + f \cos \mu i) &= \frac{m+1}{n}\lambda - \mu(e \cos i - f \sin i) \\ &+ (e \cos \mu i - f \sin \mu i). \quad \dots \quad (11) \end{aligned}$$

Hence $d\theta_3$, the angular separation of the maximum and minimum, is given by

$$d\theta_3(e \sin i + f \cos i) = \frac{\lambda}{n},$$

or, since i is small,

$$d\theta_3 = \frac{\lambda}{fn}. \quad \dots \quad (12)$$

By equation (6) $d\theta_1$, the angular distance corresponding to an increase of wave-length $d\lambda$, is given by

$$d\theta_1 = \frac{p d\lambda - e d\mu}{f}.$$

In order that two lines with a wave-length difference $d\lambda$ should just appear resolved, $d\theta_1 = d\theta_3$,

i. e. $\frac{\lambda}{n} = p d\lambda - e d\mu.$

Now $p \doteq (\mu - 1) \frac{e}{\lambda}$,

$$\therefore \frac{\lambda}{n} = \frac{(\mu - 1) e d\lambda}{\lambda} - e d\mu. \quad \dots \quad (13)$$

The resolving power or $\frac{\lambda}{d\lambda}$ is thus given by

$$ne\left(\frac{\mu-1}{\lambda} - \frac{d\mu}{d\lambda}\right),$$

which is the value arrived at by the other method.

Let us now consider the secondary maxima more closely. Their directions are given by $n \tan (E + F) = \tan n(E + F)$, cf. Preston. As $E + F$ increases from 0 to π , we pass from the direction of one chief maximum to that of its neighbour. If we solve

$$y = n \tan (E + F)$$

$$y = \tan n(E + F),$$

$E + F$ varying from 0 to π in each case, the values of $E + F$ thus found give the directions of the secondary maxima within the range. The result for $n = 26$ is approximately

$$E + F = \frac{3\pi}{52}, \frac{5\pi}{52}, \frac{7\pi}{52}, \dots, \frac{49\pi}{52}.$$

Applying the formula for the relative intensity, we find that if the intensity of the chief maximum be denoted by 1, that of the neighbouring maxima should be 0.05, 0.02, &c., but all greater than 0.001. There are twenty-four of these secondary maxima between two adjacent principal maxima.

Two of these secondary maxima are as a rule $\frac{\pi}{26}$ apart. Now

$$(E + F) \frac{\lambda}{\pi} = f(\sin \mu i - \mu \sin i) + e(\mu \cos i - \cos \mu i) \\ + \Delta\theta(f \cos \mu i + e \sin \mu i).$$

If the change in $(E + F)$ is approximately $\frac{\pi}{26}$, the corresponding change in $\Delta\theta$ is $\frac{\lambda}{26f}$, and this is exactly the theoretical limit of the resolving power. These secondary maxima, even if bright enough, should not be seen as lines but should form a continuous background. When using the electric arc on some occasions, however, the faint background between the orders appeared as if constructed of a great number of fine lines.

The ratio of the distance between the principal and adjacent secondary maxima to the distance between two principal maxima is $\frac{3}{26}$. The width of a principal maximum in a

typical case was found experimentally to be $\frac{46}{160}$ of the distance between two principal maxima; *i. e.* the adjacent secondary maxima are lost in the principal maxima.

The observations recorded in this paper were made in the Physical Laboratory of the University of Glasgow with Prof. A. Gray's echelon spectroscope, and I have to thank Prof. Gray both for encouragement and advice.

LVII. *Note on Mr. Jeans' Letter in Phil. Mag. for December.*

To the Editors of the Philosophical Magazine.

GENTLEMEN,—

MR. JEANS in his letter omits to take notice of the most important point which arises on his paper and my note. He claims, namely, to have proved Maxwell's law, which may be stated as follows. If $m_1 \dots m_n$ be the masses of n molecules, forming a group out of the much greater number N , $u_1 v_1 w_1$ &c. their velocities, $x_1 y_1 z_1$ &c. their space coordinates, then the chance that these velocities and coordinates respectively shall lie within assigned limits $u_1 \dots u_1 + du_1 \dots$ &c., $x_1 \dots x_1 + dx_1$ &c. is proportional to

$$e^{-h(\sum m(u^2 + v^2 + w^2) - 2\chi)} du_1 \dots dv_n dx_1 \dots dz_n,$$

where χ denotes the potential of external forces which in that configuration the n molecules have. Intermolecular forces are not considered.

But this expression may be put in the form

$$f(u_1)f(v_1)f(w_1) \dots f(u_n)f(2\chi);$$

in that form it asserts that "the chance of the velocities of any molecule, as m_1 , lying within assigned limits is independent of the positions and velocities of all the other molecules for the time being."

Maxwell's law cannot then be true unless at the same time that statement is true, and that statement I call assumption A. But Mr. Jeans has proved that this assumption is untrue in fact—namely, in paragraph 2 of his paper he points out that it is inconsistent with the continuity of the motion (and is therefore untrue because the motion is continuous), and in his letter he says "the laws of dynamics imply causation with no greater certainty than they imply the negation of assumption A." If, then, Maxwell's law cannot be true without A being true, and A is not true, it necessarily follows that Maxwell's law is not true.

That is, it is not generally true. In the particular limiting case of an infinitely rare gas Maxwell's law is true, at least to an infinitely near approximation, and in the same case the objections to A cease to be appreciable. For this reason Mr. Jeans is not open to the charge of inconsistency, because by virtue of his 37*d* he is in effect dealing in his paper only with the infinitely rare gas, at least so I understood him.

If Mr. Jeans is right in his view that assumption A, and therefore Maxwell's law, cannot be generally true in fact, then it necessarily follows that the orthodox theory of gases is a true theory only of the infinitely rare gas. Also the law of equipartition of energy, which is a corollary to Maxwell's law, is not proved to hold in any case except that of the infinitely rare gas.

S. H. BURBURY.

THROUGH the courtesy of the Editors I am able to add a note on Mr. Burbury's letter.

The issue of his letter is, I think, obscured by his not making any clear distinction between "assumption A" (an *assumption* which may, rightly or wrongly, be made) and "absence of correlation" (a *result* which may be proved).

From Mr. Burbury's point of view the latter follows from the former, but, given the latter, I do not think that it is necessarily a *consequence* of the former. The cause must produce the effect, but the effect may follow from any one of many causes. Anyhow, the two are not synonymous.

From my point of view, as I have said throughout, I cannot regard "assumption A" as a genuine assumption at all. It is, therefore, from my point of view, futile to discuss whether "assumption A" is true or untrue, although I do emphatically disclaim having assumed it. What we may logically do, is to discuss whether "assumption A"—*qua* assumption—is legitimate or illegitimate, and also whether "absence of correlation" (the closely related result) is—*qua* fact—true or untrue. This I hoped I had done in my original paper. The conclusion I reached was that the assumption was illegitimate, but that the fact was true.

Leaving aside the difference between "assumption A" and "absence of correlation," there is nothing inconsistent in holding simultaneously the view that an assumption is illegitimate as an assumption but true in fact. For instance, Maxwell's original proof of the law of distribution rested on the assumption which will be sufficiently indicated by the equation

$$\phi(u, v, w) = f(u) f(v) f(w).$$

It is generally admitted that this assumption is illegitimate as an assumption, but (at any rate in the case of an infinitely rare gas) true in fact. But is Mr. Burbury prepared to charge with inconsistency all those that hold these views?

It need hardly be said that I am very grateful to Mr. Burbury for the kind interest he has always taken in my work. Criticism, in particular, is always of special value to anyone who, like myself, has not worked at a subject for long. But in the present instance, although it is only with the greatest diffidence that I have ventured to try to maintain my position against Mr. Burbury's criticism, I cannot persuade myself that these criticisms have any true foundation.

J. H. JEANS.

LVIII. *The Electrical Conductivity and Fluidity of Solutions.*
By RICHARD HOSKING, 1851 *Exhibition Science Research Scholar* *.

THE present paper describes experiments carried out in the Cavendish Laboratory, Cambridge, during the year 1903 and the Michaelmas Term 1902; and these experiments are the continuation of work performed in the Physical Laboratory, Melbourne, and described in the *Philosophical Magazine* for May 1902 †, in a joint paper by Professor Thomas R. Lyle and myself.

One of the main results of the Melbourne work was to show that both the Specific Molecular Conductivity and the Fluidity of the solutions used became zero at the same temperature, viz., $-35^{\circ}5$ C.

This result was based on the form of the curves representing the temperature variations of both these quantities between 100° C. and 0° C.; but it is interesting to find that Kohlrausch ‡ quite independently arrived at the conclusion that in the case of dilute aqueous solutions, all conductivities would cease at practically the same temperature, viz., -39° C.

Another general result was that the fluidity-concentration isothermals and the conductivity-concentration isothermals all cut the axis of zero fluidity and conductivity respectively at the same point, representing a concentration of 10.74 normal. It was felt that these, and other conclusions arrived

* Communicated by Prof. J. J. Thomson, F.R.S.

† *Phil. Mag.* May, 1902, p. 487.

‡ *Sitz. Akad. Wiss Berlin*, Oct. 31st, 1901.

at, needed further investigation, and with that object mainly in view the experiments described in the present paper were undertaken.

As solutions with high concentrations would be necessary to test one of these points, lithium chloride was chosen as the salt to be used.

The method of experimenting was practically unaltered, but there were slight variations which will be briefly indicated, The dilatometer described in the joint paper was again used for measuring the specific gravity of my solutions at all the temperatures.

Viscosity.

The glischrometer was changed back to the original form described in an earlier paper (Phil. Mag. March 1900, p. 274), which was more likely to give accurate values for viscosity; and the viscosity of my solutions was found in the way there described.

In this new glischrometer the following constants were determined, correct at 0° C.

Corrected length of capillary tube = 5.4391 cms.

Mean radius of the capillary tube = 0.011592 cms.

Working volume of each limb = 3.8441 c.cms.

and in the formula

$$\eta_t = \alpha \times \rho \times h \times T - \beta \frac{\delta}{T} (1 + 2\gamma t)$$

the values for $\log \alpha$ and $\log \beta$ came out as $\bar{7}.521643$ and $\bar{2}.44902$.

Resistance.

The cell in which the electrical resistances were measured was similar to that described in the joint paper, and its capacity was determined by measuring in it the resistance of a standard solution of sulphuric acid (20 per cent. by weight). The value obtained for the capacity was 136.43 cm.^{-1} at 18° C.

The modified arrangement of Kohlrausch's method*, by which a double commutator and a moving coil galvanometer are used instead of the coil and telephone, was employed to determine the resistances. Our previous arrangement was very similar, the magneto-alternator being used instead of the dry cells and one set of sectors on the commutator.

The commutator was driven by a water-motor, and could

* Phil. Trans. A. exciv. p. 330 (1900).

be kept rotating at constant speed by controlling the water-supply with a long lever fixed to the tap.

The unit of resistance used throughout was the ohm, and the unit of concentration the number of gramme equivalents of salt per cubic centimetre of solution.

The conductivity of the water used for making up the solutions was found to be 4.9×10^{-6} at 18° C.

General Arrangement of Apparatus.

The bath contained the dilatometer, glischrometer, electrolytic cell, thermometer, and stirrer; and these were all held rigidly from above. It was enclosed in an iron jacket with glass windows at the front and back, and was heated from below by a large burner or small controlling flame as required.

Telescopes were used for reading the thermometer, observing the coincidence of meniscus and line in the glischrometer, reading the dilatometer as well as setting it, and for viewing the scale reflected from the mirror of the galvanometer.

The limbs of the glischrometer were connected by rubber tubing to the manometer and compressed-air cylinder through three-way taps, and each could be put in connexion with pressure or atmosphere independently.

An accuracy of 1 in 1000 was aimed at throughout, and corrections to stop-watch, manometer readings, and thermometers were carefully ascertained.

The temperature of the bath was kept constant within $\frac{1}{10}^{\circ}$ C. while the necessary readings were being taken, and the stirring was very efficient.

The lithium chloride was obtained pure. It was completely soluble in a mixture of ether and alcohol, and gave no residue when dissolved in water.

The solutions were not made up to any particular strength, but were obtained by diluting a stock solution. The densities of the solutions were measured in the dilatometer while the viscosities and resistances were being measured in the glischrometer and cell respectively.

Results.

With pure water in the dilatometer and glischrometer a set of readings was taken every 10° , from 0° C. to 100° C., and the values for the density thus obtained were correct within 0.01 per cent., and those for viscosity agreed within 0.1 per cent. with those originally obtained by me.

Eight solutions were made up, and these will be referred to in the following pages as solutions 1, 2, 3, . . . 8.

The following table will give an idea of their composition and properties at 15° C.; where density means specific gravity 15/4, concentration means $\frac{\text{gm.-equivalent}}{\text{litre}} = n$, and normal solution = 42.48 gms. per litre.

| Solution. | Density. | Concentration. | Viscosity. | Fluidity. | Resistance. | Sp. Mol. Conduct. | C/F. |
|-----------|----------|----------------|------------|-----------|--------------------|-------------------|-------|
| Water... | 0.9992 | | ·01143 | 87.5 | 27.6×10^6 | 92.5 | 1.057 |
| 1..... | 0.9992 | 0.00645 | ·01144 | 87.4 | 242700 | 87.1 | 0.997 |
| 2..... | 1.0016 | 0.1030 | ·01152 | 86.8 | 17210 | 76.9 | 0.886 |
| 3..... | 1.0115 | 0.5203 | ·01220 | 82.0 | 4000 | 65.6 | 0.800 |
| 4..... | 1.0234 | 1.0125 | ·01308 | 76.5 | 2281 | 59.1 | 0.772 |
| 5.. | 1.0665 | 2.937 | ·01718 | 58.2 | 1055 | 44.0 | 0.756 |
| 6..... | 1.1107 | 5.02 | ·02331 | 42.7 | 887 | 31.0 | 0.719 |
| 7..... | 1.1611 | 7.36 | ·03640 | 27.5 | 953 | 19.6 | 0.715 |
| 8..... | 1.2319 | 10.71 | ·00805 | 12.4 | 1440 | 8.8 | 0.710 |

Viscosity and fluidity are given in absolute measure. Resistance is given in ohms = R, and

$$\text{sp. mol. cond.} = C = \frac{x(1-gt)}{n \times 10^{-3} \times R},$$

where x is the capacity of the cell and $(1-gt)$ is the temperature correction for the expansion of the glass.

Instead of Water we may write Solution of infinite dilution. In resistances of 1 and 2, conductivity of the water is allowed for.

The temperature of the bath, while readings were being taken, was generally within one or two tenths of a degree of the even temperatures 0°, 10°, 20°, &c., &c.; so that in calculating the values of the viscosity, resistance, and density at these even temperatures from their values at the actual temperatures observed, the amount of error introduced was extremely small.

It is the smoothed values, obtained in this way, which are collected in the following tables, A, B, and C, and we may take the actual observations of solution 5 as typical of all, and reproduce them here also.

Solution 5. (Actual observations.)

Weight of solution in dilatometer (corrected) = 5.4123 gms.

| Bath. | | Glischrometer. | | | Bath. | Glischro- meter. | Dilato- meter. | Cell. |
|-------------------|-----------------|------------------|---------------------|-----------|---------------|---------------------|---------------------|-------------------|
| Temp. (Cent.). | Varia- tion. | Time (secs.). | Pressure (cms.). | Viscosity | Mean Temp. | Viscosity | Dilatr. (divs.). | Resist. (ohms) |
| { 0.15 | -0.00 | 556.0 | 143.9 | .02646 | 0.15 | .02644 | 24.0 | 1545.3 |
| { 0.15 | -0.00 | 551.0 | 144.9 | .02642 | | | | |
| { 9.70 | -0.02 | 421.0 | 142.6 | .01984 | 9.71 | .01982 | 29.2 | 1196.2 |
| { 9.72 | +0.06 | 421.4 | 142.2 | .01980 | | | | |
| { 20.00 | -0.00 | 333.1 | 139.2 | .01529 | 20.00 | .01527 | 36.9 | 948.8 |
| { 20.00 | -0.00 | 334.1 | 138.5 | .01526 | | | | |
| { 30.30 | -0.00 | 302.3 | 122.9 | .01222 | 30.35 | .01220 | 46.9 | 776.2 |
| { 30.40 | -0.00 | 301.7 | 122.7 | .01217 | | | | |
| { 40.06 | -0.00 | 250.0 | 123.4 | .01011 | 40.06 | .01009 | 58.0 | 658.5 |
| { 40.06 | -0.00 | 249.2 | 123.2 | .01006 | | | | |
| { 50.20 | -0.00 | 219.4 | 118.7 | .00850 | 50.20 | .00850 | 71.3 | 566.6 |
| { 50.19 | -0.02 | 218.6 | 119.0 | .00849 | | | | |
| { 59.68 | -0.00 | 197.2 | 114.2 | .00732 | 59.68 | .00731 | 85.3 | 499.5 |
| { 59.68 | -0.00 | 196.4 | 114.5 | .00731 | | | | |
| { 69.98 | +0.02 | 177.6 | 110.6 | .00635 | 70.02 | .00633 | 101.7 | 441.5 |
| { 70.07 | +0.06 | 177.0 | 110.3 | .00631 | | | | |
| { 79.92 | +0.04 | 157.4 | 110.4 | .00558 | 79.95 | .00558 | 119.0 | 397.2 |
| { 79.97 | -0.00 | 155.8 | 111.5 | .00558 | | | | |
| { 89.83 | -0.08 | 189.2 | 82.0 | .00499 | 89.80 | .00499 | 157.3 | 361.5 |
| { 89.77 | -0.00 | 187.4 | 82.8 | .00499 | | | | |
| { 95.10 | +0.10 | 177.6 | 82.9 | .00472 | 95.15 | .00472 | 148.4 | 343.7 |
| { 95.20 | +0.10 | 179.8 | 81.9 | .00473 | | | | |

TABLE A.—Density of LiCl Solutions.

| Temp. | Water. | LiCl Solutions. | | | | | | | |
|-------|--------|-----------------|--------|--------|--------|--------|--------|--------|--------|
| | | 1. | 2. | 3. | 4. | 5. | 6. | 7. | 8. |
| 0° C. | .9999 | 1.0003 | 1.0026 | 1.0131 | 1.0253 | 1.0694 | 1.1142 | 1.1654 | 1.2368 |
| 10 | .9997 | 0.9999 | 1.0023 | 1.0124 | 1.0243 | 1.0676 | 1.1119 | 1.1626 | 1.2334 |
| 18 | .9986 | 0.9986 | 1.0012 | 1.0110 | 1.0229 | 1.0658 | 1.1099 | 1.1601 | 1.2309 |
| 20 | .9983 | .9983 | 1.0009 | 1.0106 | 1.0225 | 1.0653 | 1.1094 | 1.1596 | 1.2301 |
| 30 | .9958 | .9958 | .9980 | 1.0083 | 1.0197 | 1.0623 | 1.1064 | 1.1565 | 1.2267 |
| 40 | .9923 | .9923 | .9947 | 1.0045 | 1.0162 | 1.0590 | 1.1032 | 1.1533 | 1.2232 |
| 50 | .9882 | .9882 | .9905 | 1.0003 | 1.0121 | 1.0552 | 1.0996 | 1.1500 | 1.2196 |
| 60 | .9834 | .9834 | .9855 | .9958 | 1.0076 | 1.0509 | 1.0957 | 1.1462 | 1.2159 |
| 70 | .9779 | .9779 | .9803 | .9905 | 1.0028 | 1.0464 | 1.0918 | 1.1422 | 1.2120 |
| 80 | .9719 | .9719 | .9747 | .9849 | .9972 | 1.0416 | 1.0876 | 1.1381 | 1.2080 |
| 90 | .9656 | .9656 | .9683 | .9790 | .9915 | 1.0366 | 1.0830 | 1.1340 | 1.2039 |
| 100 | .9586 | .9586 | .9614 | .9728 | .9856 | 1.0312 | 1.0781 | 1.1298 | 1.1998 |

TABLE B.—Viscosity of LiCl Solutions.

| Temp. | Water. | LiCl Solutions. | | | | | | | |
|-------|--------|-----------------|--------|--------|--------|--------|--------|--------|--------|
| | | 1. | 2. | 3. | 4. | 5. | 6. | 7. | 8. |
| 0° C. | ·01794 | ·01802 | ·01806 | ·01894 | ·02025 | ·02652 | ·03558 | ·05576 | ·1290 |
| 10 | ·01309 | ·01310 | ·01320 | ·01397 | ·01497 | ·01965 | ·02652 | ·04150 | ·0937 |
| 18 | ·01060 | ·01061 | ·01070 | ·01133 | ·01212 | ·01600 | ·02169 | ·03365 | ·0739 |
| 20 | ·01009 | ·01012 | ·01020 | ·01075 | ·01154 | ·01527 | ·02070 | ·03204 | ·0699 |
| 30 | ·00802 | ·00804 | ·00810 | ·00859 | ·00920 | ·01228 | ·01664 | ·02562 | ·0540 |
| 40 | ·00659 | ·00659 | ·00668 | ·00706 | ·00758 | ·01012 | ·01366 | ·02112 | ·0431 |
| 50 | ·00554 | ·00554 | ·00561 | ·00595 | ·00636 | ·00853 | ·01156 | ·01751 | ·03552 |
| 60 | ·00472 | ·00472 | ·00479 | ·00510 | ·00542 | ·00728 | ·00995 | ·01482 | ·02957 |
| 70 | ·00408 | ·00408 | ·00414 | ·00441 | ·00474 | ·00632 | ·00865 | ·01289 | ·02508 |
| 80 | ·00358 | ·00358 | ·00363 | ·00390 | ·00417 | ·00558 | ·00764 | ·01133 | ·02161 |
| 90 | ·00319 | ·00319 | ·00323 | ·00346 | ·00368 | ·00496 | ·00686 | ·01003 | ·01885 |
| 100 | ·00287 | ·00287 | ·00292 | ·00308 | ·00325 | ·00444 | ·00617 | ·00895 | ·01660 |

TABLE C.—Resistance of LiCl Solutions.

| Temp. | LiCl Solutions. | | | | | | | |
|-------|-----------------|-------|------|-------|-------|-------|-------|------|
| | 1. | 2. | 3. | 4. | 5. | 6. | 7. | 8. |
| 0° C. | 370500 | 25870 | 5974 | 3360 | 1552 | 1291 | 1398 | 2240 |
| 10 | 275200 | 19460 | 4513 | 2568 | 1186 | 995 | 1070 | 1652 |
| 18 | 227300 | 16050 | 3740 | 2131 | 990 | 830 | 891 | 1336 |
| 20 | 217700 | 15350 | 3588 | 2033 | 949 | 796·9 | 853·4 | 1274 |
| 30 | 177200 | 12520 | 2931 | 1661 | 781·1 | 655·8 | 699·5 | 1006 |
| 40 | 147600 | 10590 | 2462 | 1402 | 659·0 | 552·7 | 585·2 | 819 |
| 50 | 126100 | 8985 | 2112 | 1205 | 568·1 | 476·9 | 500·3 | 680 |
| 60 | 109200 | 7810 | 1840 | 1052 | 496·5 | 417·5 | 434·8 | 578 |
| 70 | 96500 | 6910 | 1629 | 931·3 | 441·5 | 369·4 | 384·0 | 500 |
| 80 | 86040 | 6190 | 1460 | 836·6 | 396·9 | 331·3 | 342·3 | 436 |
| 90 | 77980 | 5585 | 1323 | 759 | 360 | 301·5 | 308·9 | 386 |
| 100 | 71080 | 5080 | 1210 | 693 | 330 | 278·0 | 281·5 | 348 |

Knowing the molecular concentrations of our solutions at any one temperature, say 18° C., we can calculate them for the other temperatures from the alteration in the density as we heat or cool the solutions.

Professor Kohlrausch kindly supplied me with the figures connecting the density of lithium chloride solutions at 18° C. (18/4) with the concentration; and these were used in determining the concentration of my solutions at 18° C., and, by means of Table A, the concentration at the other temperatures as well. These concentrations, in gramme-equivalents per litre, are given in Table D.

Table E gives the fluidity values obtained by inverting the values in Table B; and Table F, by using the values for *R* in Table C, and for *n* in Table D, gives the values for the

TABLE D.—Concentration (*n*) of LiCl Solutions.

| Temp. | LiCl Solutions. | | | | | | | |
|-------|-----------------|--------|--------|--------|-------|------|------|-------|
| | 1. | 2. | 3. | 4. | 5. | 6. | 7. | 8. |
| 0° C. | ·00646 | 0·1032 | 0·5211 | 1·0144 | 2·945 | 5·04 | 7·38 | 10·75 |
| 10 | ·00646 | 0·1031 | 0·5207 | 1·0134 | 2·940 | 5·03 | 7·37 | 10·72 |
| 18 | ·00645 | 0·1030 | 0·5200 | 1·0120 | 2·935 | 5·02 | 7·35 | 10·70 |
| 20 | ·00645 | 0·1030 | 0·5198 | 1·0116 | 2·934 | 5·02 | 7·35 | 10·70 |
| 30 | ·00643 | 0·1027 | 0·5186 | 1·0088 | 2·925 | 5·00 | 7·33 | 10·67 |
| 40 | ·00641 | 0·1023 | 0·5167 | 1·0054 | 2·916 | 4·99 | 7·31 | 10·63 |
| 50 | ·00638 | 0·1019 | 0·5145 | 1·0013 | 2·906 | 4·97 | 7·29 | 10·60 |
| 60 | ·00635 | 0·1014 | 0·5122 | 0·9968 | 2·894 | 4·96 | 7·26 | 10·57 |
| 70 | ·00632 | 0·1008 | 0·5095 | 0·9921 | 2·882 | 4·94 | 7·24 | 10·53 |
| 80 | ·00628 | 0·1002 | 0·5066 | 0·9866 | 2·868 | 4·92 | 7·21 | 10·50 |
| 90 | ·00624 | 0·0996 | 0·5035 | 0·9810 | 2·854 | 4·90 | 7·19 | 10·46 |
| 100 | ·00619 | 0·0989 | 0·5004 | 0·9750 | 2·840 | 4·88 | 7·16 | 10·43 |

TABLE E —Fluidity (F) of LiCl Solutions.

| Temp. Water. | LiCl Solutions. | | | | | | | | |
|--------------|-----------------|-------|-------|-------|-------|-------|-------|--------|-------|
| | 1. | 2. | 3. | 4. | 5. | 6. | 7. | 8. | |
| 0° C. | 55·75 | 55·50 | 55·37 | 52·80 | 49·38 | 37·71 | 28·10 | 17·93 | 7·75 |
| 10 | 76·40 | 76·33 | 75·76 | 71·58 | 66·80 | 50·89 | 37·71 | 24·10 | 10·67 |
| 18 | 94·35 | 94·25 | 93·40 | 88·26 | 82·50 | 62·50 | 45·89 | 29·72 | 13·33 |
| 20 | 99·11 | 98·81 | 98·00 | 93·02 | 86·65 | 66·49 | 48·31 | 31·21 | 14·30 |
| 30 | 124·7 | 124·4 | 123·4 | 116·4 | 108·9 | 81·43 | 60·09 | 39·03 | 18·52 |
| 40 | 151·7 | 151·7 | 149·7 | 141·6 | 131·9 | 98·84 | 73·21 | 47·31 | 23·20 |
| 50 | 180·4 | 180·4 | 178·2 | 168·1 | 157·2 | 117·2 | 86·50 | 57·11 | 28·15 |
| 60 | 211·9 | 211·9 | 208·8 | 196·0 | 184·3 | 137·4 | 100·5 | 67·32 | 33·82 |
| 70 | 245·1 | 245·1 | 241·5 | 226·8 | 211·0 | 158·2 | 115·6 | 77·58 | 39·87 |
| 80 | 279·4 | 279·4 | 275·5 | 256·4 | 240·0 | 179·2 | 130·9 | 88·26 | 46·28 |
| 90 | 313·5 | 313·5 | 309·6 | 289·0 | 271·8 | 201·6 | 145·8 | 99·70 | 53·05 |
| 100 | 348·4 | 348·4 | 343·0 | 324·6 | 307·7 | 225·2 | 162·0 | 111·70 | 60·24 |

TABLE F.—Sp. Mol. Cond. (C) of LiCl Solutions.

| Temp. | Infinite Dilution. | LiCl Solutions. | | | | | | | |
|-------|--------------------|-----------------|-------|-------|-------|-------|-------|-------|-------|
| | | 1. | 2. | 3. | 4. | 5. | 6. | 7. | 8. |
| 0° C. | 60·60 | 57·0 | 51·13 | 43·82 | 40·03 | 29·85 | 21·23 | 13·22 | 5·66 |
| 10 | 81·4 | 76·8 | 67·99 | 58·05 | 52·42 | 39·12 | 27·60 | 17·31 | 7·70 |
| 18 | 98·9 | 93·1 | 82·52 | 70·14 | 63·26 | 46·95 | 33·15 | 20·84 | 9·54 |
| 20 | 103·4 | 97·2 | 86·31 | 73·15 | 66·33 | 49·00 | 34·53 | 21·77 | 10·01 |
| 30 | 127·6 | 119·8 | 106·1 | 89·75 | 81·41 | 59·70 | 42·08 | 26·61 | 12·72 |
| 40 | 153·4 | 144·2 | 125·9 | 107·2 | 96·78 | 70·98 | 50·1 | 31·9 | 15·67 |
| 50 | 180·0 | 169·5 | 149·0 | 125·5 | 113·1 | 82·64 | 58·2 | 37·5 | 18·87 |
| 60 | 209·6 | 196·6 | 172·3 | 144·7 | 130·1 | 94·9 | 66·8 | 43·3 | 22·33 |
| 70 | 239·2 | 223·6 | 195·7 | 164·4 | 147·7 | 107·3 | 75·7 | 49·2 | 25·9 |
| 80 | 269·6 | 252·6 | 219·8 | 184·5 | 165·3 | 119·8 | 84·8 | 55·3 | 29·8 |
| 90 | 299·7 | 280·4 | 245·2 | 204·8 | 183·2 | 132·7 | 93·6 | 61·5 | 33·6 |
| 100 | 330·6 | 309·8 | 271·5 | 225·3 | 201·9 | 145·6 | 100·0 | 67·7 | 37·6 |

TABLE G.—Ratio $\frac{C}{F}$ for LiCl Solutions.

| Temp. | Infinite Dilution. | LiCl Solutions. | | | | | | | |
|-------|--------------------|-----------------|------|------|------|------|------|------|------|
| | | 1. | 2. | 3. | 4. | 5. | 6. | 7. | 8. |
| 0° C. | 1·087 | 1·027 | ·923 | ·830 | ·811 | ·791 | ·756 | ·739 | ·734 |
| 10 | 1·066 | 1·006 | ·897 | ·811 | ·784 | ·768 | ·732 | ·720 | ·711 |
| 18 | 1·048 | ·988 | ·883 | ·795 | ·767 | ·751 | ·716 | ·703 | ·703 |
| 20 | 1·044 | ·983 | ·881 | ·786 | ·766 | ·748 | ·715 | ·699 | ·700 |
| 30 | 1·023 | ·962 | ·860 | ·771 | ·749 | ·733 | ·703 | ·684 | ·687 |
| 40 | 1·011 | ·950 | ·841 | ·757 | ·734 | ·718 | ·684 | ·676 | ·675 |
| 50 | ·998 | ·937 | ·831 | ·747 | ·719 | ·704 | ·673 | ·657 | ·670 |
| 60 | ·989 | ·928 | ·825 | ·738 | ·706 | ·691 | ·664 | ·642 | ·660 |
| 70 | ·976 | ·915 | ·810 | ·725 | ·700 | ·678 | ·655 | ·634 | ·650 |
| 80 | ·965 | ·904 | ·798 | ·719 | ·690 | ·669 | ·648 | ·628 | ·644 |
| 90 | ·956 | ·895 | ·792 | ·709 | ·675 | ·658 | ·646 | ·618 | ·633 |
| 100 | ·948 | ·888 | ·791 | ·695 | ·658 | ·646 | ·638 | ·608 | ·624 |

specific molecular conductivity, in units, already mentioned.

Table G gives the values for the ratio $\frac{C}{F}$.

It will be necessary to explain how the figures in the first columns of Tables F and G are obtained, and for this purpose we must examine closely the other figures in Table G. It will be seen that for each solution the decrease in the value $\frac{C}{F}$ is the same for equal rises in temperature: thus between 0° and 10° we have decreases of ·022 throughout, and between 80° and 90° decreases of ·008 as an average.

If we assume that for a solution of infinite dilution the same values apply, and if we have values of the fluidity of such a solution, and the absolute value for the conductivity at any one temperature, we can calculate the values for $\frac{C}{F}$ at all temperatures. Now Kohlrausch has determined the value for C_∞ at 18° C., namely 98·9, and the fluidities will be those of water, so that having $\frac{C}{F}$ at 18° C. equal to 1·048, we can build up the first column by adding or subtracting the proper differences or those which exist in solution 1—which amounts to practically the same thing.

We can now fill up the first column in Table F, for we have both values of $\frac{C}{F}$ and of F for a solution of infinite dilution, so that we know the values of C_∞ at all temperatures between 0° and 100° C.

Experiments were made on two solutions in which the

temperatures were carried down below 0° C., and the figures for these solutions, which we shall call numbers 9 and 10, are here given. It will be seen that the lowest temperature reached was -15°·20 C.

Solution 9.

| Temp. | Variation. | Density. | Concentration. | Viscosity | Fluidity. | Resistance. | Sp. Mol. Cond. | C/F. |
|-------|------------|----------|----------------|-----------|-----------|-------------|----------------|------|
| 15·20 | -0·00 | 1·0500 | 2·266 | ·01530 | 65·36 | 1197 | 50·30 | ·768 |
| 0·20 | -0·00 | 1·0517 | 2·270 | ·02346 | 42·62 | 1733 | 34·68 | ·811 |
| -8·00 | -0·00 | 1·0527 | 2·272 | ·03125 | 32·00 | 2217 | 27·08 | ·847 |

Solution 10.

| Temp. | Variation. | Density. | Concentration. | Viscosity | Fluidity. | Resistance. | Sp. Mol. Cond. | C/F. |
|--------|------------|----------|----------------|-----------|-----------|-------------|----------------|------|
| 15·00 | -0·00 | 1·1530 | 6·74 | ·03256 | 30·71 | 933·2 | 21·69 | ·706 |
| 0·40 | +0·04 | 1·1570 | 6·76 | ·04913 | 20·35 | 1346 | 14·99 | ·737 |
| -7·15 | -0·00 | 1·1584 | 6·76 | ·06293 | 15·89 | 1676 | 12·04 | ·758 |
| -12·00 | +0·04 | 1·1595 | 6·77 | ·07441 | 13·44 | 1964 | 10·26 | ·763 |
| -14·50 | -0·00 | 1·1599 | 6·78 | ·08125 | 12·06 | 2154 | 9·34 | ·759 |
| -15·20 | +0·20 | 1·1601 | 6·79 | ·0837 | 11·95 | | | |

In these experiments, the bath was of methylated spirits surrounded by a freezing mixture of crushed ice and salt, and the bath was kept well stirred in the ordinary way.

Discussion of the Results.

Let us consider the temperature variations of fluidity and conductivity, as represented by our ten solutions, or eleven if we include the solution of infinite dilution.

It will be seen at once that the fluidity increases more rapidly than the conductivity, the former increasing its value sixfold, and the latter fivefold, in being heated through 100° from 0° C., and this applies whether the solutions be weak or dilute.

If we represent the results algebraically, we find that both the fluidity and conductivity values can be expressed by equations of the same form, and that they are proportional to the *m*th power of the temperature measured from a fixed point below the 0° C., which is the same for all solutions.

This temperature is calculated to be $-48^{\circ}10$ C. Thus for the solutions in Table E we have the equation $F = \frac{T^m}{a}$, where m and a are different constants for the different solutions, and T is the temperature measured from $-48^{\circ}10$ C.

For the solutions in Table F, we have similar equations, as $C = \frac{T^n}{b}$; and of course in Table G, the temperature variations are represented by $\frac{C}{F} = \frac{a/b}{T^{m-n}}$.

The values for the constants a , b , m , n , a/b , $m-n$, have been calculated, and are collected in the following table.

The formula here used is that known as Slotte's, and was found by Thorpe and Rodger to represent better than any other the results of their experiments on viscosity.

Values of Constants.

| Solution. | m . | n . | $m-n$. | a . | b . | a/b . |
|----------------|--------|--------|---------|--------|--------|---------|
| 8 | 1.8631 | 1.7016 | 0.1615 | 182.00 | 130.13 | 1.3986 |
| 7 | 1.6456 | 1.4841 | 0.1615 | 33.290 | 24.050 | 1.3841 |
| 6 | 1.5853 | 1.4256 | 0.1597 | 16.650 | 11.847 | 1.4054 |
| 5 | 1.5933 | 1.4306 | 0.1627 | 12.723 | 8.555 | 1.4873 |
| 4 | 1.6325 | 1.4579 | 0.1756 | 11.392 | 7.091 | 1.6065 |
| 3 | 1.6230 | 1.4763 | 0.1467 | 10.163 | 6.950 | 1.4620 |
| 2 | 1.6357 | 1.4960 | 0.1397 | 10.165 | 6.403 | 1.5874 |
| 1 | 1.6500 | 1.5257 | 0.1243 | 10.705 | 6.442 | 1.6665 |
| Inf. Dilution. | 1.6440 | 1.5291 | 0.1149 | 10.416 | 6.145 | 1.6950 |

The following table, which gives the values for $\frac{C}{F}$ calculated

Calculated values of $\frac{C}{F}$.

| Temp. | Infinite Dilution. | LiCl Solutions. | | | | | | | |
|-------|--------------------|-----------------|------|------|------|------|------|------|------|
| | | 1. | 2. | 3. | 4. | 5. | 6. | 7. | 8. |
| 0° C. | 1.086 | 1.025 | .926 | .829 | .814 | .792 | .757 | .741 | .748 |
| 10 | 1.063 | 1.002 | .900 | .806 | .787 | .770 | .735 | .718 | .726 |
| 18 | 1.048 | .990 | .884 | .791 | .770 | .752 | .720 | .703 | .710 |
| 20 | 1.043 | .982 | .881 | .787 | .766 | .748 | .716 | .700 | .707 |
| 30 | 1.027 | .964 | .864 | .772 | .748 | .732 | .701 | .685 | .692 |
| 40 | 1.013 | .951 | .849 | .758 | .732 | .717 | .687 | .672 | .678 |
| 50 | 1.001 | .939 | .837 | .746 | .718 | .705 | .676 | .660 | .667 |
| 60 | .989 | .927 | .825 | .736 | .706 | .694 | .665 | .650 | .657 |
| 70 | .979 | .918 | .815 | .726 | .695 | .684 | .656 | .640 | .647 |
| 80 | .970 | .909 | .806 | .718 | .685 | .675 | .648 | .632 | .639 |
| 90 | .962 | .900 | .798 | .710 | .676 | .667 | .640 | .625 | .631 |
| 100 | .954 | .892 | .790 | .702 | .668 | .660 | .633 | .619 | .624 |

from the formulæ by using the above constants, may be compared with Table G, the observed values for $\frac{C}{F}$, and the calculated values for C and F represent the observed values with the same degree of accuracy.

If we treat these results graphically, as we have done in figures 1 and 2, where the ordinates represent temperatures

Fig. 1.

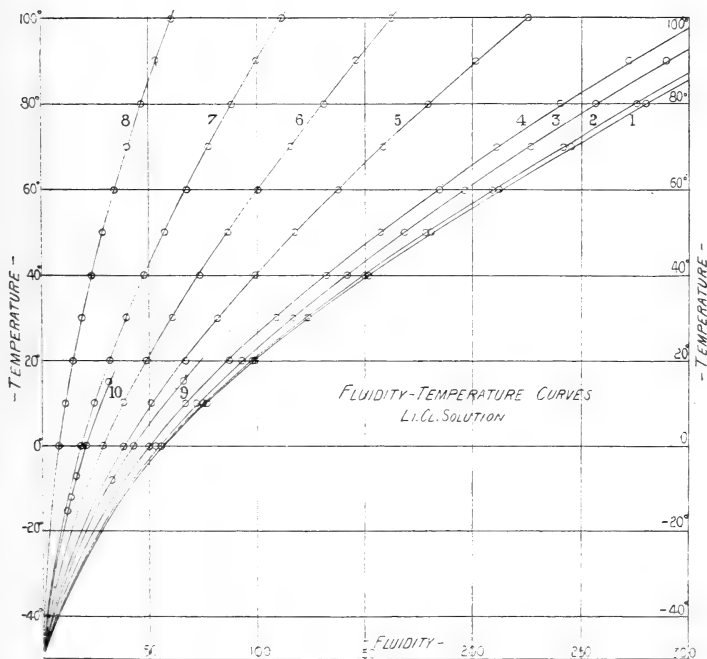

and the abscissæ the fluidity and conductivity respectively, we see that here, too, from the form of the curves above the points representing the lowest temperatures reached by experiment, the curves if continued all cut the axis representing zero fluidity and zero conductivity respectively at this same temperature of $-48^{\circ}.10$ C.

On examining the figures previously obtained for sodium-chloride solutions, it was found that they could be represented by the same form of equation, which contains this temperature $-48^{\circ}.10$ C. as the starting point, and it is very probable that low temperature experiments would lead to this temperature, and not $-35^{\circ}.5$ C., being fixed at the point at which, apart

from solidification, the fluidity and the conductivity of these solutions would have zero value.

Fig. 2.

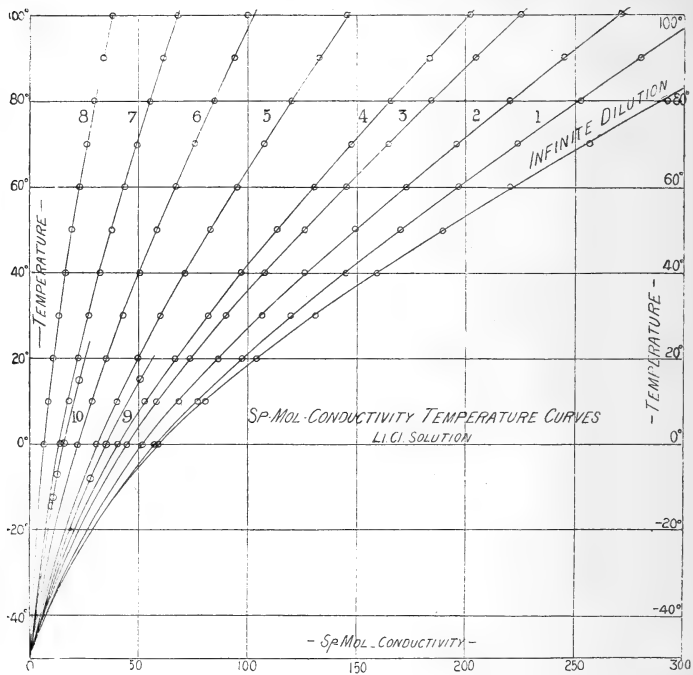

Let us calculate out the values of the ratio $\frac{C_n}{C_a}$ in Table F. For the weaker solutions the numbers will measure the ionization coefficients, and we can see how these alter with change of temperature.

Ionization Coefficients.

| Temperature. | 1. | 2. | 3. | 4. | 5. | 6. |
|--------------|------|------|------|------|------|------|
| 0° C..... | .940 | .844 | .723 | .661 | .493 | .350 |
| 10 | .943 | .835 | .713 | .644 | .481 | .339 |
| 18 | .941 | .834 | .709 | .640 | .475 | .335 |
| 20 | .940 | .835 | .708 | .641 | .474 | .334 |
| 30 | .939 | .832 | .705 | .638 | .468 | .330 |
| 40 | .940 | .821 | .699 | .631 | .463 | .327 |
| 50 | .942 | .828 | .697 | .628 | .460 | .323 |
| 60 | .938 | .822 | .690 | .621 | .453 | .319 |
| 70 | .935 | .818 | .687 | .618 | .449 | .316 |
| 80 | .937 | .815 | .684 | .613 | .444 | .314 |
| 90 | .936 | .818 | .683 | .610 | .443 | .312 |
| 100 | .937 | .821 | .682 | .611 | .440 | .302 |

In solution 1, the ionization remains constant at all temperatures, but for the other solutions there is a very marked decrease with rise of temperature, and this becomes greater the stronger the solution.

Referring back to Table E, it will be seen that for solution 1 there has been no change in fluidity by the addition of the salt to the water. It is only when the fluidity becomes smaller by the addition of the salt that there is the diminishing of the ratio $\frac{C_n}{C_a}$ with rise of temperature, so that the diminution of $\frac{C_n}{C_a}$ may be due to two causes, the re-combination of the ions and the retarding influence of the molar viscosity; and the latter influence may be felt in much weaker solutions than one has generally supposed.

I have at the beginning of this paper briefly referred to the work of Kohlrausch in connexion with the zero conductivity of dilute solutions. His conclusions were arrived at from a study of the temperature variations of conductivity of dilute solutions between 0° and 34° C. The question of a lower limit to the conductivity has since been attacked by Bousfield and Lowry*, who show that the conductivity of dilute solutions and the viscosity of water tend towards the same limiting temperature, and over the range of temperature (from 5° to 34° C.) the temperature variations can be expressed by the same kind of curve. They, however, doubt the existence of the zero at the point indicated by Professor Kohlrausch and Professor Lyle and myself.

Neither Kohlrausch nor Bousfield and Lowry used Slotte's form of equation to represent their results, and it has been shown by Thorpe and Rodger† that this is the one which gives the best values, where a wide range of temperature is involved, for viscosity; and it is probably the best form of equation to use in connexion with conductivity results.

Kunz‡ conducted some low-temperature experiments with strong sulphuric-acid solutions and solutions of other substances, and decided that in these cases no zero conductivity existed at the temperature supposed.

Kohlrausch§ has recently studied the temperature variations of ionic mobilities, and has here introduced the idea that ions in solutions are surrounded by watery atmospheres carried along with them, and the resistance the ions

* Bousfield & Lowry, Roy. Soc. Proc. p. 42, June 19, 1902.

† Thorpe & Rodger, Phil. Trans. 1894.

‡ Kunz, *Compt. Rend.* vol. cxxxv. p. 788 (1902).

§ Kohlrausch, *Sitz. Ber. d. Berlin. Akad.* p. 572 (1902).

have to overcome is mainly friction between this atmosphere and the solvent water.

In a later paper, Kohlrausch* has explained more fully his previous paper, and has sketched out the new view of the mechanics of electrolysis, according to which the moving ion carries with it a mass of adhering solvent, and the electrical resistance of an ion is a frictional resistance which increases with the dimensions of the atmosphere surrounding it.

One of the conclusions he arrives at is that the resistance of an ion expressed in mechanical units must be of the same order of magnitude as the mechanical resistance of a molecule of the solvent.

The velocity of the ions will depend on the viscosity of the medium through which they pass, and on the size of the ionic atmosphere; and the conductivity of the solution will depend on the viscosity of the medium, the size of the ionic atmosphere, and the fraction of dissociated ions in solution.

The lithium ion, which moves very slowly, may be considered as the centre of a larger atmosphere than the fastly moving chlorine ion, and probably with rise of temperature the atmospheres will approach the same size, as Kohlrausch has observed that with rise of temperature the velocity of the ions tend to become equal.

If we examine our weakest solution, we shall see that here the conductivity does not keep pace with the molar fluidity as the temperature is raised, although there is no combination of the ions. It looks as if the atmosphere around the negative ion is increasing rapidly, while that around the positive ion remains constant or diminishes slowly.

If for our solution at infinite dilution we take the value $\frac{C}{F} = 1.048$ at 18°C. , and consider the atmosphere of the Cl ion to have unit radius, that of the Li ion will have $\sqrt{2}$ times this radius at the temperature 18°C. , because the Cl ion moves twice as fast, and the retardation will depend on the square of the radius.

Now $\frac{C}{F}$ at $100^\circ = .946$. The ratio has decreased in the proportion $1.048 : .946$ or 1.11 to 1 . This decrease is due to the increase of the atmosphere of the ions, and as these atmospheres tend to become equal, if we assume that at 100° they are equal, the radius of each will be 1.29 , so that the Cl has increased its atmosphere by $.29$, and the Li has diminished its by $.12$.

* Kohlrausch, Roy. Soc. Proc. Feb. 17, 1903.

In solution 1, there is no combination of the ions as the temperature rises, so that here, too, any change in the value of $\frac{C}{F}$ will indicate a change in the ionic atmospheres. Here also the decrease is from 1.11 to 1. For this solution, F has the same values as for the solution just considered, but C has smaller values throughout because there are fewer carriers of electricity, although the atmospheres work out to have the same values as in the other solution throughout.

Solution 2 has the same increase for the radii of the atmospheres if the ionization coefficients in our table have the physical meaning which that name should imply, but here the atmospheres at any particular temperature are smaller by one per cent. If, however, the atmospheres remain of constant radius for all solutions, at any particular temperature, the figures under 2 in the table of ionization coefficients must be increased by 1 per cent. throughout to have their physical meaning.

Fig. 3.

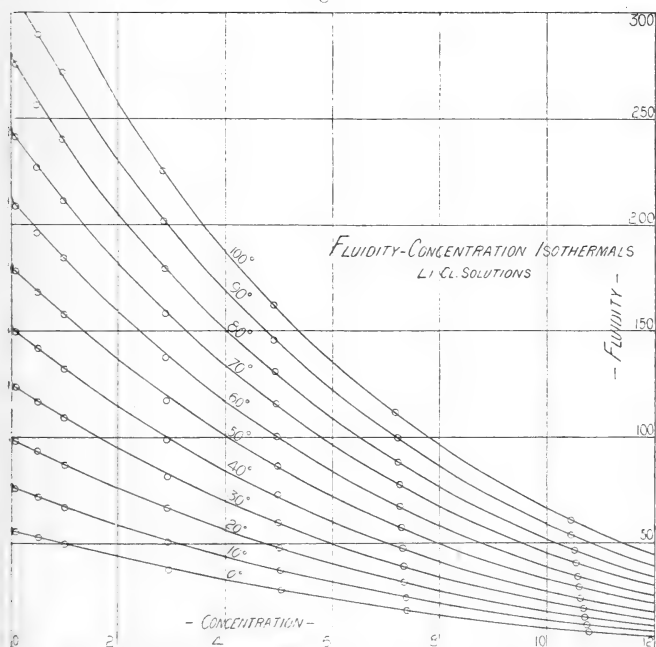

For the stronger solutions the ratio 1.11 to 1 remains throughout, but there is nothing to indicate how the ionic atmospheres vary with the concentration.

In the present paper I have confined myself to the temperature variations of fluidity and conductivity. The fluidity-concentration and conductivity-concentration isothermals are also interesting, but I shall not discuss them here. There are indications, however, that all the isothermals will cut the axis of zero conductivity and fluidity at the same point representing concentrations of about 16 normal. I intend making further experiments on strong solutions to test this point.

Fig. 4.

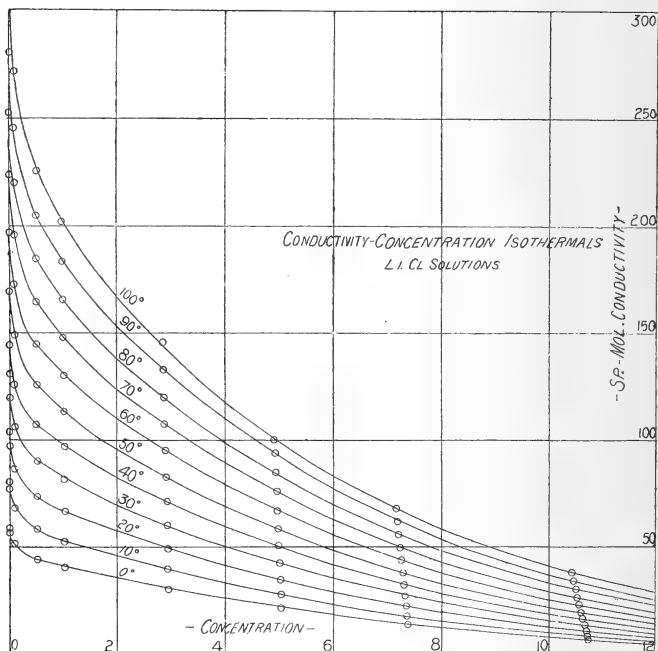

The curves connecting the variables F and n , and C and n , are given in figs. 3 and 4 respectively, each curve being the isothermal for the temperature indicated on it.

I wish, in conclusion, to thank Professor Thomson for the interest he has taken in this investigation.

Cavendish Laboratory,
March 14, 1904.

LIX. *On the Analysis of Bright Spectrum Lines.* By JAMES BARNES, M.A., 1851 Exhibition Scholar, Fellow of Johns Hopkins University*.

[Plates XXV. & XXVI.]

IT is well-known that a change is produced in the wave-length and distribution of light in the lines of the spectrum of metallic vapours and gases when different external conditions are introduced. In most cases these changes were first observed and measured by means of the Rowland grating. Recently, however, these effects have become more readily observable through interference methods, in which the interference-bands are produced with large differences in the paths of the rays.

Michelson †, by aid of his interferometer, resolved the important lines in the radiations of some vapours and gases rendered luminous in vacuum-tubes, and he has studied these radiations in a magnetic field. With his echelon spectroscope he has investigated the same subjects. Fabry and Perot ‡ with their interferometer have investigated the radiations from vapours in the electric arc and in vacuum-tubes, and have applied their method for an exact determination of the wave-length of some of the lines in the spectrum of the iron arc and of the dark lines in the sun's spectrum. Lummer §, also by an interference method, has studied the same radiations, particularly those from mercury, and has separated its prominent lines into many components.

When one compares the results of these investigations the agreement is not very satisfactory. Not only do the number and intensity of the components differ, but the distances between the components do not agree.

The work presented in this paper was undertaken at the suggestion of Professor Ames. The objects of the work were : to study interferometer methods ; to obtain, if possible, more consistent results as to the constitution of the lines ; and to determine the changes produced in the components under various conditions. Michelson remarks in one of the papers cited :—" Still, in many cases, the range of visibility due to slight variations in the conditions shows that the behaviour of each substance must be carefully studied under all possible

* Communicated by Professor J. S. Ames.

† *Phil. Mag.* [5] xxxi. p. 338 (1891) ; xxxiv. p. 280 (1892).

‡ *Ann. de Chim. et Phys.* xii. p. 459 (1897) ; xvi. pp. 115 & 289 (1899) ; *Astrophys. Journ.* ix. p. 87 (1899).

§ *Verhdlgn. d. D. Phys. Ges.* iii. p. 85 (1901) ; *Phys. Zeit.* [3] viii. p. 172 (1902).

circumstances of temperature, pressure, strength of current, size and shape of electrodes, diameter of vacuum-tube, &c."

After experimenting a few months with both the Michelson and the Fabry and Perot interferometer the author was fully convinced that the Fabry and Perot method possessed the advantage for the problems in view, since it shows directly the structure of a given radiation by the simple inspection of the system of fringes. Each fringe is in fact a true spectrum of the source and the conditions are the same as those existing in the spectra obtained by the use of a grating having a small number of lines but where the spectra employed are of a very high order. During the progress of the experiments the method proposed by Lummer appeared. While I have not been able to use this method exactly, I used, before I read his paper, one which is very similar to it. This method and results obtained will be described below.

Method.

The method involved in this production of interference-fringes will be first briefly considered as it will assist towards a clear conception of the results.

Consider a ray of monochromatic light incident at an angle θ upon two glass plates whose inside surfaces A and B (fig. 1) are slightly silvered and separated from one another

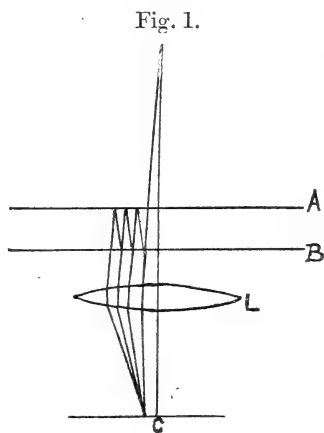

a distance D . If the silvered surfaces are parallel we have on account of the multiple reflexions a number of transmitted rays coming from the same source, whose differences of path increase in arithmetical progression. The differences of path with respect to the first are $2D \cos \theta$, $4D \cos \theta$, \dots , $2nD \cos \theta$.

By means of a lens L these rays are brought to a focus in its focal plane, producing there an interference pattern, bright and dark bands according as $2D \cos \theta$, $4D \cos \theta$, &c. are equal to an even or an odd number of half wave-lengths. If we have a symmetrical cone of rays incident upon the plates, the system of fringes obtained on a screen placed in the focal plane of the lens will be concentric circles, having as their centre the point of intersection of the normal from the source upon the plates with the screen, C in the figure. The radii of these circles are equal to $f \tan \theta$, where f is the focal length of the lens L .

The intensity of the light at different points in this interference pattern was first worked out by Airy*. His formula is

$$I = \frac{I_0(1-b^2)^2}{(1-b^2)^2 + 4b^2 \sin^2\left(\frac{\pi \Delta}{\lambda}\right)},$$

where I_0 is the intensity of the incident light transmitted by the silvered surfaces, b the coefficient of reflexion of the silvered surfaces, and Δ the difference of path of the rays. We see from this formula that for a given value of b , I will have a maximum when $\frac{2\Delta}{\lambda}$ is an even integer and a minimum when $\frac{2\Delta}{\lambda}$ is an odd integer. Hence the intensity of the bright fringes is I_0 , while that of the dark fringes is

$$I_0 \left(\frac{1-b^2}{1+b^2} \right)^2.$$

Fabry and Perot have calculated the values of I for different values of b , and have plotted curves showing the relations between I and Δ for these values of b . The greater the value of b the steeper becomes the intensity curve, so that the interference pattern consists of bright fringes which are very narrow compared with the dark ones (see Plate XXV. fig. 1). As we shall see later, the sharper and finer these bright bands are the easier are the radiations analysed and the components measured, thus, while on this account it is advantageous to have b very large by increasing the thickness of the silver film, it must not be so large that I_0 , the intensity of the light transmitted, is too small.

Let us now consider the light which is incident upon the plates not to be monochromatic, but to consist of two wave-lengths λ and $\lambda + d\lambda$, then the screen in the focal plane will

* Phil. Mag. [3] ii. p. 20 (1833).

be covered with the two systems of concentric rings. At a definite separation of the plates let these two systems be in coincidence, then we have the relation

$$\frac{\Delta}{\lambda} = \frac{\Delta}{\lambda + d\lambda} + n,$$

where n is any whole number, or

$$d\lambda = \frac{n\lambda^2}{\Delta - n\lambda}.$$

Since Δ is always large relative to $n\lambda$ we may write

$$d\lambda = \frac{n\lambda^2}{\Delta} = \frac{n\lambda^2}{2D \cos \theta}.$$

Thus by observing the first coincidence of the rings ($n=1$) near the centre of the system where θ is so small that we may consider $\cos \theta=1$, knowing the value of λ , and measuring D , the value of $d\lambda$ can be determined with a very high degree of accuracy. When $d\lambda$ is very small it is not necessary for the determination of its value to separate the plates until the first coincidence occurs, but only till the separation of the rings is clearly visible. When the separation of the two systems of rings is, say, one quarter of the distance between consecutive rings of the same radiation, the equation becomes

$$d\lambda = \frac{\lambda^2}{8D}.$$

The resolving power of this method depends upon the distance between the plates and also upon the angle of incidence of the light. The fringes near the centre have thus the largest resolving power. It is also advantageous to make observations upon the central fringes because their separation is the greatest. This can be shown if we consider the length of the radii of the rings. With the centre of the system a bright ring

$$\Delta = 2D = m\lambda$$

where m is an integer; for the first bright fringe out from the centre the difference of path is

$$2D \cos \theta = (m-1)\lambda$$

hence

$$\tan \theta = \frac{\sqrt{2m-1}}{m-1},$$

and the radius R_1 of the ring is given by the expression

$$R_1 = f \tan \theta = \frac{f\sqrt{2m-1}}{m-1}.$$

Similarly for the second bright fringe

$$2D \cos \theta = (m-2)\lambda$$

hence

$$R_2 = \frac{f\sqrt{4m-4}}{m-2}$$

and so forth for $R_3, R_4, \&c.$

The following table gives the values of $R_1/f, R_2/f, \&c.$ for different values of m :—

| $m.$ | $R_1/f.$ | $R_2/f.$ | $R_3/f.$ | $R_4/f.$ | $R_5/f.$ |
|-----------|----------|----------|----------|----------|----------|
| 1 | ∞ | — | — | — | — |
| 2 | 1.732 | ∞ | — | — | — |
| 3 | 1.118 | 2.828 | ∞ | — | — |
| 4 | .882 | 1.732 | 3.873 | ∞ | — |
| 100 | .143 | .203 | .251 | .292 | .329 |

From this table we see that when $m=1$, *i. e.*, the difference of path is one wave-length, there is only one interference-band, and its radius is infinite, thus the field would be uniformly illuminated. When the difference of path is two wave-lengths there are only two fringes, the first whose radius is $1.732f$; the radius of the second being infinite. For $m=3$ there are three fringes. The entire system of bands could only be observed by means of infinite glass plates. We also see that as m gets large, which in practice is generally the case, the lower row in the table shows us that the distance between the first and second rings is much larger than that between the second and third, and so on moving out in the system. Thus the separation of the fringes gradually diminishes as we go out from the centre, and hence the advantage of making the observations on the central fringes. This is clearly shown by the figures on the Plates, which are reproduced from photographs*.

This interference method, besides being applied for the analysis of spectrum lines, can be used in the study of the changes in the wave-length of any radiation under the different conditions as indicated above. Any small change will be shown by an increase or decrease in the diameters of these rings, and since very clear photographs can be taken, very accurate measurements on the changes produced can be obtained.

* We regret the reproduction of the photographs of the plates in half-tone does not do justice to the figures sent; in particular the "screen" used has caused "ghost" circles to appear on fig. 16 which have not been successfully got rid of.—EDS.

Apparatus.

After experimenting some time with an instrument which seemed to be particularly sensitive to vibrations, even when every precaution was taken to eliminate extraneous disturbances, a new instrument was constructed. In the construction of this instrument the essential parts sought after were, that the mountings for the plates should be rigid and placed on a massive base so that the bands should be perfectly steady, and that the movable carriage carrying one plate should be capable of a very slow uniform motion always remaining parallel to its original position, enabling one to follow clearly the change from one band to another.

In working with a Michelson interferometer as made by Gaertner & Co., the fringes obtained were very steady, even when the instrument rested on a table in the laboratory. I took this instrument, stripped it of its mirrors and plates, and using the base, carriage, and screw constructed the apparatus employed.

The apparatus consists of two plane glass plates 3.9 cms. by 2.5 cms. and about .6 cm. thick, each slightly prismatic in shape; the two faces making with one another an angle between 1'' and 2''. This prevents the interference-bands formed in the plates themselves being superimposed upon those under observation. Both plates are rigidly mounted in brass frames. One frame can be moved about a vertical axis and the other about a horizontal axis. For very small motions about these axes, so that the silvered surfaces may be made perfectly parallel, two glass tubes were bent into convenient shapes and clamped to the instrument. Their ends resting against a frame are covered with thin sheet rubber. To the other ends are attached long rubber tubes and these connected with a support. By carefully raising or lowering these tubes, which are filled with mercury, the pressure against the frame being therefore varied, very small rotations around either axis are obtained and the surfaces thereby placed in perfect adjustment. Fabry and Perot employed this method, using water in their tubes instead of mercury. The carriage containing one of the frames rests upon steel ways, very accurately ground, and is connected by means of a small carriage, placed underneath, to a screw of 1 mm. pitch. The force being thus applied to the carriage in a direction parallel to the motion produces no rocking, as is shown by the fact that the fringes always remained in adjustment during the motion.

To turn the screw two handles are on the instrument, one for rapid and the other for slow motion. A turn of the first

corresponds to one turn of the screw. The other is a tangent screw by which it is possible to give the carriage such a slow motion that the change from one fringe to the next can be easily followed. To both handles were attached graduated disks enabling the distance between the plates to be accurately known.

The whole instrument weighed over 15 kilograms and was placed on a brick pier. The greater part of the observations were taken at night. With this instrument the fringes were always perfectly steady, and very long photographic exposures could be made without the least fear of obtaining a blurred image.

Since the radiations from all the sources studied consisted of many wave-lengths it was necessary to employ some arrangement by which the wave-length under consideration could be separated from the others. The following (fig. 2) was the plan first adopted. S is the source of light. The

Fig. 2.

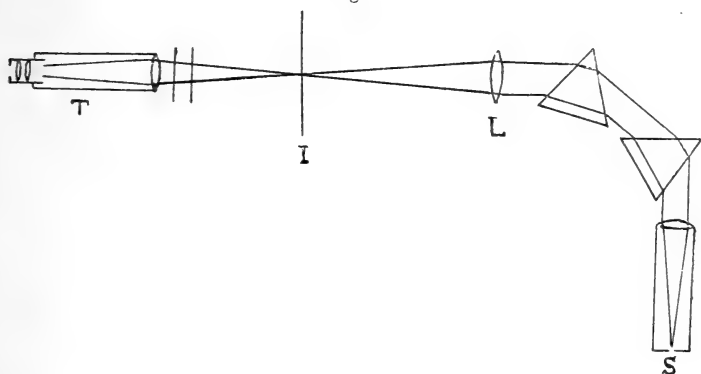

radiation undergoes an analysis by a Steinheil spectroscope consisting of two flint-glass prisms. The lens L brings the different wave-lengths to a focus on a screen I which contains a slit. Through this slit the wave-length considered is allowed to pass, and passing between the silvered plates forms the interference-bands, which are observed by a telescope T or photographed.

The photographic apparatus consisted of a long light-proof box with a circular hole cut in one side. The eyepiece of the telescope being removed, the box was so placed that the opening fitted over the end of the telescope. The photographic plate, 13 by 3 cms., was in the focus of the objective and mounted so that it could be slid past the

opening, and hence a number of exposures made upon one plate.

With the silvered plates illuminated in this way, with divergent light, the entire rings of the interference-bands are observed in the focal plane of the objective, as shown on Plate XXV. fig. 1. The following method, however, was found to be better for the analysis of the radiations. The lens L was removed and the interferometer placed directly behind the prisms so that the parallel light fell upon the silvered plates. With a broad slit in the spectroscope we have in the telescope, focussed for infinity, broad lines corresponding to the lines in the spectrum. These lines are crossed with the interference-bands produced by the plates. By this means the light has been concentrated into a few interference-bands and on this account many of the weaker components appear which cannot be seen with the light divergent as above. Fig. 2 shows this clearly. This photograph is of the bright green mercury radiation, and shows three components when the interference-plates are separated 8 mms.

This method possesses also another great advantage. Due to the number of lines in most spectra we have in the field of the telescope at the same time a number of lines containing different kinds of interference-bands depending upon the constitution of the radiation making up each line. This facilitates greatly the analysis of the radiations and we see at once any change that may take place in one or all of the lines through any change of external conditions. The dispersion of the prisms and the magnification of the telescope were such that about half of the spectrum was visible at once. Plate XXV. figs. 3, 4, and 5 each show the interference-bands due to the two yellow and the green lines of mercury vapour taken at the same time with the plates separated different distances. On account of the broad slit the yellow lines passed through the interference-plates together, and hence their interference-bands are superimposed upon one another. The other lines in this region of the spectrum of mercury being of less intensity do not show in the photographs, which were exposed only long enough to get the clearest pictures of the lines considered. The dark green line was quite visible to the eye after passing through the silvered plates. The curvature of the bands in the different lines is of course due to the amount of separation of the plates, and to the angle of incidence with which the radiations are incident upon the interferometer-plates.

For the determination of the scale-reading corresponding to the place where the silvered plates were in contact, a

sodium flame or incandescent sodium vapour in a vacuum-tube was employed. The slit of the spectroscope being wide the two D lines were superimposed so that the two radiations together entered the interferometer. The plates were separated until the first coincidence happened, and the readings taken; the operation was repeated several times. Since the difference, $d\lambda$, between the sodium lines is known with accuracy from Rowland's tables, the distance D between the plates can be calculated from the above equation and thus the zero point obtained. Readings were taken of the successive coincidences as the plates were separated and in this manner the screw was calibrated. If a more accurate calibration is required the two yellow lines of mercury can be used; since their distance apart is about three times that of the D lines, the coincidences occur three times more often in a given distance.

Remarks on Interference-Bands.

Before considering the results I will add some remarks concerning the general character of the interference-bands obtained by this interference method.

When the silvered surfaces are not parallel, but are inclined to one another at a small angle, the fringes obtained are localised in the plates and, as is well known, can be seen by the eye or with a lens focussed on the plates. These fringes, however, can only be obtained when the separation of the plates is very small.

In order to procure clear interference-bands with great differences of paths it is necessary to have the surfaces rigidly parallel. The fringes in this case are seen by the eye, or by means of a telescope focussed for infinity. One of the most important results of this work is that *the silvered faces of the plates must be perfectly parallel and the telescope must be focussed for infinity to obtain correct results.* While this has been noted by former investigators I wish to strongly emphasize the necessity for these adjustments, for if these two conditions are not fulfilled all manner of anomalous results may be expected.

On Plate XXV. are shown some photographs of some of the results obtained, if these conditions are not obeyed. Figs. 6-12 were all taken with the bright green line of incandescent mercury vapour in a vacuum-tube. None of the photographs are magnified, the focal length of the objective used was about 15 cms.

The separation of the interference-plates in figs. 1, 6, and 7 was 3 mms. 1 is where the adjustments are perfect,

6 and 7 show the effect upon the bands when the interference-plates are only a very small degree from being parallel, they being displaced from parallelism by merely raising one of the mercury adjusting tubes less than a centimetre.

In figs. 8 and 9 the plates are separated 0.5 mm., in neither case are the plates parallel, in 8 they have an angular separation of over $1''$. These photographs also show the interference-bands produced in the plates themselves superimposed upon the other.

It is to advantage in these observations to obtain all the light possible, thus a broad source is always employed. The interfering rays from the different points of the source can only produce a clear interference pattern in the focal plane of the objective; in any other plane the interference-bands will be wide and hazy. Figs. 10, 11, and 12 illustrate this point. The whole slit is covered with the exception of two points separated 4 mms. from one another in a horizontal direction. Fig. 10 shows the effect when the photographic plate is placed about 1 cm. inside the focus of the objective. Fig. 11 when the plate is placed 2 cms. beyond the focus. Fig. 12 when the plate is exactly in the focal plane; then the fringes produced by all points of the source are coincident and give clear and sharp interference-fringes. One can easily see that if the whole source were used instead of two points, the bands in 10 and 11 would be wide and hazy, so that if any of the bands due to the components of the radiation were present they would probably be entirely obliterated.

To set the telescope at infinity is easy, but the adjustments necessary to obtain the silvered surfaces parallel are more or less difficult and can only be obtained with practice. The plates are parallel when the fringes are sharp and the illumination equally distributed over the series of rings due to the components.

A Reflecting Interferometer.

In the Fabry and Perot interferometer a large amount of light is lost due to reflexion from the surface of the silvering in contact with plate A (fig. 1), so that only a small percentage is transmitted. To eliminate this defect the plates were mounted according to the following fig. 3. Plate A was heavily silvered and polished on its inside surface and mounted on the carriage of the interferometer as described above. Plate B has its inside surface almost completely silvered, its reflecting power being about .9, and is mounted in the other frame. Light is incident upon the plate A, as

shown in fig. 3, and due to multiple reflexion between the silvered plates we have transmitted a number of rays whose path differences are in arithmetical progression, and the theory of the method is exactly as that sketched above. By

Fig. 3.

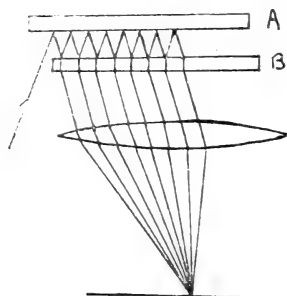

this method the bright interference-bands are much brighter than those obtained with the Fabry and Perot method, and hence the components more readily seen. On account of the larger incident angle θ of the light upon the plates, the fringes observed are quite a distance from the centre of the system, and are therefore close together, causing the necessary adjustments to make the plates parallel more difficult than with the method above where the centre of the system is used. Observations were made with these two methods and the results agreed extremely well.

As mentioned in the introduction a method proposed by Lummer appeared during these experiments. He employs only a long glass plate with parallel faces and passes light into it by means of a prism at such an angle that it emerges at almost the critical angle. The method is very similar to the method above. In Lummer's methods, however, since the thickness of a given glass plate is fixed, the positions of the components relative to one another cannot be determined, and if the faces of the plates are not perfectly parallel many anomalous results, as those indicated above, may be obtained.

Results.

On the basis of what has preceded the following results have been obtained. A number of sources of light were employed—metallic vapours in vacuum-tubes rendered luminous by the discharge from a large induction-coil, metallic vapours in a Bunsen flame and in an electric arc, and, lastly, the electric spark between electrodes of the metals. This latter source was found to be very unsatisfactory. Of the

many sources tried the bright radiation from mercury vapour was the best for obtaining observations on the changes produced in the components by external changes in the conditions. We will thus first consider the results with this source. Great pains were always taken to have perfect adjustments, chiefly with respect to the focusing of the telescope and the parallelism of the interference-plates, before any readings were taken.

The vacuum-tube discharge was obtained in a Geissler tube with mercury electrodes of the form suggested by Runge and Paschen*, the capillary of which was placed directly in front of the slit of the spectroscope. The different tubes were connected to a Geryk pump and a pressure-gauge, enabling the pressure of the vapour through which the discharge passed to be quickly changed from a few millimetres to a fraction of a millimetre.

It is rather difficult to decide what is the most advantageous way to record results, whether to take what appears to be the centre of gravity of the various components constituting the radiation as the position from which to measure wave-lengths, which is the usual way in the measurements of the lines obtained by means of the grating, or to consider the component of the greatest intensity as the standard, and record the wave-lengths of the other components with reference to this. This method is the one employed by Michelson, and Fabry and Perot. The latter method is nevertheless unsatisfactory, for I have found, even in some of the few radiations investigated, that there are two or more bright components whose intensities are equal. For want of a satisfactory standard, and also that the following results may be easily compared with those of the other investigators, their method has, however, been followed. In the cases where the brightest components are of equal intensity one of them has been selected for the standard. In what follows the plus sign indicates that the component has a longer wave-length than the standard, the minus sign the reverse.

The following results were obtained after a long series of observations with a tube whose capillary was 0.5 mm. in diameter and the vapour at a pressure of 1.5 mms. The bright green radiation, whose wave-length is 5461, consists of six components; the two brightest having about equal intensities, the one having the longer wave-length will be considered the standard. The other components have the following

* *Astrophys. Journ.* xv. p. 238 (1902).

differences in wave-length and in intensity relative to the one selected :—

| 1. Standard Component. | Intensity, 1. |
|------------------------------|---------------|
| 2. -1.1×10^{-8} mm. | 3/4. |
| 3. -0.9 „ | 1/4. |
| 4. -0.4 „ | 1 |
| 5. $+0.1$ „ | 1/8. |
| 6. $+0.4$ „ | 1/4. |

Thus there are three components on the side toward the shorter wave-lengths and two toward the larger.

The violet line, 4358, is a triple having slight components on each side of the principal.

| 1. Standard Component. | Intensity, 1. |
|-------------------------|---------------|
| 2. $-0.5 + 10^{-8}$ mm. | 1/4. |
| 3. $+0.4$ „ | 1/4. |

Both the yellow lines have numerous components, but they are of very slight intensity, so that concordant results were not obtainable.

When a small amount of air was allowed to enter the vacuum-tube till the pressure was about 5 mms. the components of small intensity completely disappeared, the fringes due to the brighter components broadened and their edges became less sharply defined, showing that the atomic vibrations were not so uniform and simple as before. The same effect was noticed with the radiation from a vacuum-tube which had been used some time without any change of pressure. In the case where the pressure is changed through the introduction of air the molecular collisions may be made more frequent, which would naturally interfere with the free vibrations of the atomic systems and so produce a broadening of the bands and cause the less intense fringes to disappear. In the case of an old tube, when the pressure has not changed, there seems to be no other explanation for the observations than that the mercury vapour had become contaminated with gases driven off from the glass by the heat developed in the discharge.

Whether the atomic vibrations in a source are changed on account of the presence of molecules of foreign matter is an open question. Michelson* thinks that the presence of other molecules does not have any appreciable effect except to diminish the visibility. In the case of mercury he obtained quite different visibility curves when the pressure was high to that obtained when the pressure was low. When

* Phil. Mag. xxxiv. p. 280 (1892).

the mercury was placed in an atmosphere of hydrogen the characteristics of the visibility curves were not changed. My results show, however, that when mercury is placed in the presence of air both in the vacuum-tube discharge and in the arc, which will be described later, the appearance of the interference-bands is clearly changed, which can only be due to a change in the oscillations of the atomic systems. Schuster, in a lecture at the Royal Institution in 1881, drew from his results the conclusion: "Placing a molecule in an atmosphere of a different kind—without change of temperature—produces the same effect as would be observed in lowering the temperature." In a note to the *Astrophysical Journal** he says "Something similar seems to take place as regards pressure for the sodium lines may be obtained wide or narrow according as the atmosphere producing the pressure consists of sodium molecules only or of molecules of a different nature." The results here obtained seem to corroborate those of Schuster.

As being of some importance in this subject I have introduced figs. 14 and 15 (Plate XXVI). showing the broad bands of the sodium lines, separated and superimposed, obtained with a sodium flame in air as the source. With sodium in a vacuum-tube these bands are as sharp as those of the mercury lines on Plate XXV. Fig. 13 was obtained by the green radiation from mercury in a tube which had been used a considerable time. The separation of the plates was 6 mms. Here not even one component is visible. A comparison of this photograph with that of Fabry and Perot reproduced in the *Astrophysical Journal*, May 1901, may interest the reader. This reproduction is of the fringes of the same line with the same separation of plates, but shows the components. Figs. 13, 14, 15 (Plate XXVI.) have been magnified about five times. Fig. 16 has not been magnified, and shows how sharp the bands are when the plates are separated 1 cm. Here also the components of the mercury green radiation are invisible.

With tubes containing capillaries whose diameters are greater than 2 mms. the light obtained with an ordinary discharge is not sufficiently intense to show the finer components. The components that can be seen have their edges quite sharp, showing that the vibrations in these tubes are probably the same as in the tubes of smaller capillaries. The finer the capillary the greater the electrical resistance to the discharge and hence a rise in temperature, causing a brighter light. Temperature is an important factor, for by heating

* *Astrophys. Journ.* iii. p. 292 (1896).

only the capillary of a tube where there is no liquid mercury present and thus producing no noticeable change in the pressure in the vacuum-tube, the kinetic energy of the atomic aggregations is increased such that many of the components of small intensity invisible before are now very readily seen.

The number and intensity of the components were the same whether the tube was placed "side on" or "end on," that is whether the discharge was perpendicular or parallel to the propagation of the light through the slit.

The introduction of capacity in parallel with the discharge circuit had an interesting effect. With three large leyden-jars, each gallon jars, the fringes were broadened and the finer components disappeared. The effect appeared in every way analogous to that when the pressure was increased.

The next step was to investigate the radiations from a mercury arc and compare the results with those above. After many trials with different kinds of arcs the following form (fig. 4) was found the most satisfactory. The arc is between

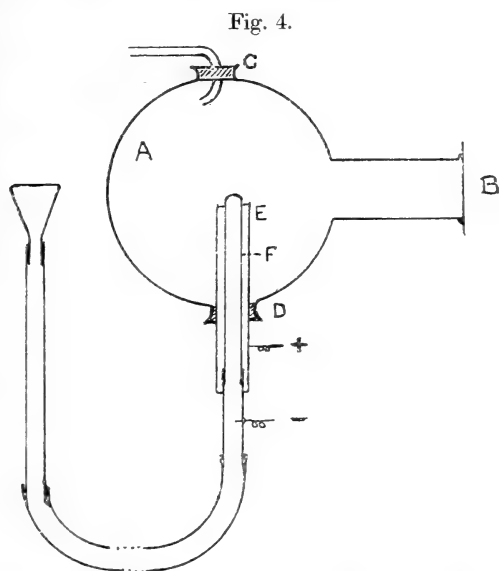

two mercury surfaces. A is an ordinary glass receiver of about 800 c.c. capacity. Over the mouth B is sealed a piece of plate-glass; through the rubber stopper C is run a glass tube which is connected to the Geryk pump. Through the stopper D is placed an iron tube E of diameter 13 mms., along the axis of this is placed a porcelain tube F of diameter 8 mms.

This porcelain tube is connected with a glass tube which in turn is connected with a large rubber tube. The mercury fills the space between the porcelain and iron tubes as well as the porcelain, glass, and rubber tubes attached. The electric poles are placed as shown in the figure. By raising the barometer column until a drop of mercury flows over into E the arc is started. Any further adjustments are easily carried out by raising or lowering the mercury column. Since all the joints were made air-tight the pressure could be varied by means of the pump. Within a few seconds after the arc is started the whole bulb of the receiver is covered with a layer of mercury thrown off from the arc, this does not penetrate into the neck so that the glass at B is always clear and the radiation from the arc passes through to the slit of the spectroscope without loss. The whole apparatus may be placed in a cold-water bath to keep the joints cool. This was found unnecessary with the apparatus used, even when the arc was steadily run as long as ten minutes. Usually 110 volts were employed, the current was varied by means of a rheostat, generally 4 amperes were used.

With the pressure under 5 mms. the results were the same as those obtained with vacuum-tubes as given above. Above this pressure it was very difficult to obtain any components, and the bands were broad and hazy. This is probably due, as above, to pressure and the presence of a number of molecules of air.

The results obtained with the other metallic vapours and gases are briefly as follows:—

Cadmium.—Small pieces of metallic cadmium were enclosed in a Geissler tube surrounded by an asbestos jacket; when heated with a Bunsen flame the metal easily vapourized.

The red line 6439 is nearly monochromatic; there is, however, a weak component towards the shorter wave-lengths.

| | |
|-------------------------------|---------------|
| 1. Standard Component. | Intensity, 1. |
| 2. — 0.1×10^{-8} mm. | „ 1/5. |

The green line 5086 is composed of four components, the three weaker being on the side towards the larger wave-lengths.

| | |
|-------------------------------|---------------|
| 1. Standard Component. | Intensity, 1. |
| 2. + 0.4×10^{-8} mm. | „ 1/4. |
| 3. + 0.25 „ | „ 1/4. |
| 4. + 0.1 „ | „ 1/8. |

The blue line 4800 has a component on each side of the principal.

| | |
|-------------------------------|---------------|
| 1. Standard Component. | Intensity, 1. |
| 2. + 0.6×10^{-8} mm. | „ 1/5. |
| 3. — 0.4 „ | „ 1/4. |

Thallium.—A piece of metallic thallium was placed on the end of a platinum wire and held in a Bunsen flame. The only bright radiation was that of the green line, 5439. A doubling of bands occurred when the plates were separated only a few millimetres. With a vacuum-tube radiation another component was found with wave-length between the principal and first component.

| | |
|-------------------------------|---------------|
| 1. Standard Component. | Intensity, 1. |
| 2. + 1.0×10^{-8} mm. | „ 3/4. |
| 3. + 0.4 „ | „ 1/4. |

Hydrogen.—By the kindness of Dr. Parsons I used one of his tubes containing hydrogen which was specially pure, the pressure being 1 mm. The red line easily breaks up into three components, one on each side of the brightest component.

| | |
|-------------------------------|---------------|
| 1. Standard Component. | Intensity, 1. |
| 2. + 0.6×10^{-8} mm. | „ 1/4 |
| 3. - 0.2 „ | „ 1/8. |

The green line is very complex, the components are so numerous that observations are very difficult.

The changes in the components, due to changes in pressure, size of capillary, capacity in circuit, which were examined principally with the mercury radiations were in some cases tried with the other radiations considered, and the results were in general the same. The above results with respect to the relative wave-length and intensity of the components under the conditions specified are collected in the following table (p. 502), together with the results of Michelson, and Fabry and Perot upon the same radiations obtained in vacuum-tubes. Michelson's values are taken from the curves given in his paper. His method does not allow the determination as to whether the components have larger or shorter wave-lengths than the standard. The second list of values for the components of the mercury line, $\lambda = 5461$, obtained by Fabry and Perot, are taken from a paper by Zeeman*.

After the many long and tedious observations, together with the study and elimination of the errors which may enter into the results due to imperfect adjustments of the apparatus, the author regrets that he is unable to present a more detailed account of the variations that occur in these component radiations or satellites as they have been called. The changes occur so suddenly on the least change of the surrounding conditions, and sometimes even when no changes apparent to the observer were introduced, that only qualitative results of a very general nature can be expressed.

During the observations upon the sharp interference-fringes

* *Astrophys. Journ.* xv. p. 218 (1902).

| Michelson. | | Fabry and Perot. | | Author. | |
|---|------------|---|------------|---|------------|
| Constitution and Separation $\times 10^8$ mm. | Intensity. | Constitution and Separation $\times 10^8$ mm. | Intensity. | Constitution and Separation $\times 10^8$ mm. | Intensity. |
| Mercury, $\lambda = 5461$. | | | | | |
| I. | | | | | |
| 1. Std. Compt. | 1 | 1. Std. Compt. | 1 | 1. Std. Compt. | 1 |
| 2. 1.2 | 1/10 | 2. + 0.9 | 1/6 | 2. - 1.1 | 3/4 |
| 3. 1.0 | 1/4 | 3. + 0.1 | 1/3 | 3. - 0.9 | 1/4 |
| 4. 0.7 | 1/10 | | | 4. - 0.4 | 1 |
| With two weak components near standard. | | II. | | 5. + 0.1 | 1/8 |
| | | 1. Std. Compt. | 1 | 6. + 0.4 | 1/4 |
| | | 2. - 2.2 | 1/2 | | |
| | | 3. - 0.7 | 1/4 | | |
| | | 4. - 0.5 | 1/3 | | |
| | | 5. + 0.1 | 1/2 | | |
| | | 6. + 0.8 | 1/3 | | |
| | | 7. + 1.3 | 1/4 | | |
| Mercury, $\lambda = 4358$. | | | | | |
| 1. Std. Compt. | 1 | | | 1. Std. Compt. | 1 |
| 2. 1.7 | 1/10 | | | 2. - 0.5 | 1/4 |
| With two weak components near standard. | | | | 3. + 0.4 | 1/4 |
| Cadmium, $\lambda = 6439$. | | | | | |
| No Components. | | No Components. | | 1. Std. Compt. | 1 |
| | | | | 2. - 0.1 | 1/5 |
| Cadmium, $\lambda = 5086$. | | | | | |
| 1. Std. Compt. | 1 | 1. Std. Compt. | 1 | 1. Std. Compt. | 1 |
| 2. 0.2 | 1/5 | 2. - 0.3 | 1/3 | 2. + 0.4 | 1/4 |
| | | | | 3. + 0.25 | 1/4 |
| | | | | 4. + 0.1 | 1/8 |
| Cadmium, $\lambda = 4800$. | | | | | |
| 1. Std. Compt. | 1 | 1. Std. Compt. | 1 | 1. Std. Compt. | 1 |
| 2. 1.0 | 1/8 | 2. + 0.8 | 1/3 | 2. + 0.6 | 1/5 |
| | | 3. - 0.8 | 1/3 | 3. - 0.4 | 1/4 |
| Thallium, $\lambda = 5439$. | | | | | |
| 1. Std. Compt. | 1 | 1. Std. Compt. | 1 | 1. Std. Compt. | 1 |
| 2. 1.2 | 1/8 | 2. + 1.1 | 1/2 | 2. + 1.0 | 3/4 |
| 3. 1.0 | 1/2 | 3. + 0.2 | 1/2 | 3. + 0.4 | 1/4 |
| 4. 0.2 | 1/8 | | | | |
| Hydrogen, $\lambda = 6563$. | | | | | |
| 1. Std. Compt. | 1 | | | 1. Std. Compt. | 1 |
| 2. 1.4 | 3/4 | | | 2. + 0.6 | 1/4 |
| | | | | 3. + 0.2 | 1/8 |

due to the mercury green radiation in the two cases, when the components were visible, as exemplified by the photograph given by Fabry and Perot, as referred to above, and when, with the same separation of the silvered plates, the components were not present, as exemplified by fig. 13, Plate XXVI., the question arose—Has the change in the conditions given birth to one or more satellites? The sharpness of the fringes in both cases, the unequal change in the intensity of the various components under variable conditions, as is shown when the capillary of a vacuum-tube is heated, and in the fact that the results, given in the above table, upon the distances between the components are in poor agreement, which is probably due to the different circumstances surrounding the radiation, all point to the possibility of the production of satellites. It, must not be forgotten, however, that at the separation of the plates necessary to show the presence of the components the interference-bands are very close to one another, so that it is impossible in this method for an interference-fringe due to the birth of a satellite to appear without overlapping some part of the interference-fringes of the other components and hence producing a new distribution of light in the interference pattern which would naturally lead to different results.

The investigations of the variations in the wave-length and intensity of radiations separated by the grating on account of variation in pressure, electrical condition of the discharge, and the chemical nature of the dielectric surrounding the luminous substance, is at present a very fruitful field. For these changes in these widely-separated lines lend themselves to measurement. It is hoped that a method will be found which will more readily show and give measurements of the many changes that occur in radiations whose wave-lengths, and hence their frequencies, do not differ greatly, so that ultimately some knowledge as to the mechanics of the systems of moving electrons constituting the atom whose periods differ by small amounts—relative to those obtainable at present—may be obtained. A step in this direction has been made by Lummer. The reproductions in the *Ann. d. Phys.* x. p. 473 (1903) show excellently the complicated structure of these bright radiations. The method proposed above, employing longer plates, is worthy of a fair trial.

My heartiest thanks are due to the professors and lecturers in physics in this University, especially Professor Ames and Professor Wood, and also to my fellow students whose kind assistance in word and deed has greatly facilitated these experiments.

Physical Laboratory,
Johns Hopkins University.

LX. *The Whirling and Transverse Vibrations of Rotating Shafts.* By C. CHREE, *Se.D., LL.D., F.R.S.**

CONTENTS.

§§ 1-5. Preliminary Discussion.
 6-11. CASE 1. Overhanging shaft, end fixed in direction.
 12-18. CASE 2. Shaft "supported" at both ends.
 19-25. CASE 3. Overhanging shaft "supported" at one end and at a second point.
 26-27. CASE 4. Shaft "supported" at one end, and with its direction fixed at the other end.
 28-32. CASE 5. Shaft "supported" at both ends and at intermediate point.
 33-35. CASE 6. Shaft fixed in direction at both ends.
 36-39. General Conclusions.
 40-46. Mathematical Appendix.

Preliminary Discussion.

§ 1. **L**ATERAL vibrations are those executed by a bar when bent to one side and then released. They are connected with the "whirling" of rotating shafts, but in a way which has not, I think, hitherto been clearly recognized. The subject of "whirling" has been treated by Professor Greenhill † in a well-known paper dealing with an unloaded shaft rotating under various terminal conditions. More recently the subject has been treated in an elaborate and important paper by Prof. Dunkerley ‡. He employed two ways of calculating the critical speeds of rotation. The first makes use of the ordinary elastic solid equations applicable to thin rods acted on by "centrifugal force"; this is the method followed by Greenhill. On attempting to apply this method to loaded shafts, Dunkerley reached results which he considered hopelessly complicated. In his second method, which is due apparently to Prof. Osborne Reynolds, Dunkerley calculated a critical speed for the loaded shaft, in which the mass of the shaft itself was neglected. Calling the frequency thus obtained N_2 , and that found for the unloaded shaft by the first method N_1 , he deduced a final value N for the frequency from the equation

$$1/N^2 = 1/N_1^2 + 1/N_2^2. \dots \dots \dots (1)$$

By speed or frequency Dunkerley means the number of revolutions per *minute*, i. e.

$$N = 30\omega/\pi, \dots \dots \dots (2)$$

where ω is the angle through which the shaft rotates in one second.

* Communicated by the Physical Society: read March 11, 1904.

† Proc. Institution of Mechanical Engineers, 1883, p. 182.

‡ Phil. Trans. A, 1894, p. 279.

When more than one load exists, Dunkerley calculated critical speeds N_2, N_3, \dots for each separately, and deduced a critical speed for the whole system from the formula

$$1/N^2 = 1/N_1^2 + 1/N_2^2 + 1/N_3^2 + \dots \quad (3)$$

He made a number of experiments with a miniature shaft, loaded with one or both of two pulleys, and in many cases the speeds at which whirling commenced agreed remarkably with those calculated. In some cases better agreement was obtained with a formula of the type

$$1/N^2 = 1/N_2^2 + a/N_1^2,$$

in which a is an experimental constant.

Dunkerley (*l. c.* p. 281) noticed that there was a connexion between the speed of whirling and the frequency of the lateral vibrations of the shaft when not rotating; but I see no indication in his paper that he had grasped the real nature of the connexion.

Dunkerley's method (*l. c.* p. 358) of arriving at his working equation (3)—which he characterizes himself as “empirical”—is not convincing mathematically. In fact, the result does not appear to be in general strictly true; and there seems nothing in Dunkerley's work which serves to bring out the limitations. As we shall see later in particular cases, the agreement between theory and observation is not by itself sufficient evidence of the general applicability of formula (1). Again, the applications by Dunkerley of the Euler-Bernoulli elastic theory are cumbrous mathematically, and the formulæ to which they lead, and which were employed by Dunkerley, often admit of great simplification, without appreciable diminution of accuracy, under his experimental conditions. Also, as already explained, the true nature of the relationship to lateral vibrations is not brought out.

For these several reasons I have thought it worth while to examine the whole question afresh from a variety of points of view, making liberal use, however, of Dunkerley's experimental results, and referring to his formulæ in the several cases, so that the present work is in many respects supplementary to his. To go fully into the mathematical investigations in each case would occupy an undue amount of space, and as the same methods are employed in the different cases, I have deemed it sufficient to give one or two illustrations in the Appendix at the end of the paper.

§ 2. It is unnecessary to describe the method employed by Greenhill and Dunkerley for the unloaded shaft, as it is simply the approximate Bernoulli-Eulerian method described in mathematical textbooks treating of “thin” rods.

Dunkerley's second method, in so far as it relates to finding the critical speed for a loaded but massless shaft, is really analogous to a method illustrated by Lord Rayleigh* in obtaining approximate frequencies of vibration. Both assume the displacement of the bar to be of a simple algebraic type; but Dunkerley applies ordinary statical equations, whilst Rayleigh applies dynamical equations deduced by means of the principle of energy. Rayleigh, however, advances in justification of his method a result based on very general reasoning, viz. that a considerable departure from the true type of vibration leads to only a small error in the estimate of the frequency.

I am not prepared to say that Rayleigh's general theory is impervious to criticism. A general theorem may pass muster even with acute critics, simply from failing to suggest points of view which decline to be left out of account in actual practice. Again, a theorem may be practically satisfactory within certain limits, and yet those limits may be so difficult to recognize that applications may be fraught with peril to any but one of the very few men who combine profound physical insight with first-rate mathematical ability. Still, taking all these things into account, I think it will be generally recognized that, in view of the empirical nature of Dunkerley's second method, the application of Rayleigh's method to the problem of whirling is, if practicable, highly desirable. Numerous applications of it will be made here, and there is an illustration of the mathematical details in the Appendix.

§ 3. Before treating individual cases, I shall describe in unmathematical language the true nature of the connexion between lateral vibrations and the phenomenon of whirling. Ordinarily, when a shaft held at one or both ends is acted on by forces tending to bend it, on the removal of these forces it tends to return to its original straight position; in doing so it overshoots the mark and vibrates to and fro laterally. The velocity of its approach to the equilibrium position, and the frequency of the vibrations subsequently executed, are greater the larger the elastic stresses produced in the bar by a given lateral displacement. When the bar is rotating round its longitudinal axis, and is displaced laterally, the elastic stresses tend as before to bring it back to the undisturbed position; but the "centrifugal forces" have exactly the opposite tendency: they thus reduce the righting forces, and so diminish the frequency of vibration. If we take the simplest case where there are no complications from the mass of the shaft itself, and where only the mass (not the moment of

* 'Theory of Sound,' vol. i. Arts. 182, 183, &c.

inertia) of the load requires to be taken into account, it may be shown that if $k/2\pi$ be the frequency of the vibrations which the shaft executes when displaced laterally at a time when it is rotating with uniform angular velocity ω , and $K/2\pi$ be the corresponding frequency in the absence of rotation, then

$$k^2 = K^2 - \omega^2. \dots \dots \dots (4)$$

As ω is increased, the frequency of vibration and so the stability of the bar diminish, until eventually when

$$\omega = K \dots \dots \dots (5)$$

the frequency becomes *nil*, i. e. the period becomes infinite, or the righting power vanishes. In fact, the position is similar to that of a ship whose C.G. has come to coincide with the metacentre. The case is not one in which forced vibrations are set up with a frequency equal to one of the natural periods. What leads to whirling is the indirect action of the rotation in reducing to zero the righting forces which naturally act on the shaft when displaced laterally. The case of a loaded but massless shaft is of course an extreme one; but all the other cases which I have examined present similar features. The case selected for mathematical treatment in the Appendix is that of a shaft supported at both ends; this admits of a variety of sub-cases, illustrative of various points.

[*March 15.*—To prevent misconception, it seems desirable to state explicitly and prove—as was done when the paper was read—that the formula of § 3,

$$k^2 + \omega^2 = K^2,$$

applies exactly to all *unloaded* shafts, to the degree of accuracy possessed by ordinary equations for thin rods. The elastic bodily equation has the following forms :

$$\begin{aligned} d^4y/dx^4 &= \Omega^2(\sigma\rho y/EI) \text{ for rotation with whirling velocity } \Omega, \\ &= K^2(\sigma\rho y/EI) \text{ for vibration without rotation,} \\ &= (k^2 + \omega^2)(\sigma\rho y/EI) \text{ for vibration when velocity of} \\ &\hspace{15em} \text{rotation is } \omega. \end{aligned}$$

The value of μ in the typical equation

$$d^4y/dx^4 = \mu^4 y$$

depends only on the terminal conditions. Thus for any, the same, system of supports we have

$$k^2 + \omega^2 = K^2 = \Omega^2.]$$

§ 4. As stated above, whirling is not really a case of coincidence of period between a vibrating system and disturbing forces. A rotating shaft may, however,—like any other shaft—be acted on by periodic forces which tend directly to set up lateral vibrations. In considering the effect of any such forces, it must be borne in view that what one has to look to is the frequency of the lateral vibrations of the shaft *as reduced by the rotation*. The possibility of forced vibrations of this kind is an additional reason for considering the effects of rotation on the period.

§ 5. In the main I shall follow Dunkerley's classification of the principal cases of whirling shafts, but shall not number separately cases where the shaft is with, and without, a load. The cases are determined by the number and nature of the supports.

If x be taken parallel, and y perpendicular, to the undisturbed position of the axis of the shaft, the bending being supposed to occur in the plane xy , clearly at any support

$$y=0.$$

If the end of a shaft simply rests on a support, then on the Euler-Bernoulli theory, as the terminal section must be free from a couple,

$$d^2y/dx^2=0.$$

At such an end the shaft is said to be "supported." If, on the other hand, the shaft be constrained to retain a fixed direction at an end, the second terminal condition is

$$dy/dx=0.$$

If a shaft is "supported" at any intermediate point, then clearly y must vanish there, while dy/dx and d^2y/dx^2 must be continuous. A sudden change of dy/dx would imply fracture, while a sudden change of d^2y/dx^2 would imply the action of a couple at the supported section.

When an end is quite free, resting on no support, both stress and couple vanish, and so

$$d^2y/dx^2=d^3y/dx^3=0.$$

Notation used.

E = Young's modulus for shaft, assumed homogeneous and isotropic.

ρ = density of material of shaft, supposed uniform.

σ = cross section (and so $\sigma\rho$ = mass per unit length).

M = mass of load, when there is one.

I = moment of inertia of σ about diameter perpendicular to plane of bending.

- I = moment of inertia of M about an axis through its C.G. perpendicular to plane of bending.
- ω = angular velocity of rotation.
- $k/2\pi$ = frequency of lateral vibration, taking rotation into account.
- T = variable part of kinetic energy of system.
- V = " " " potential " "
- $\mu = \omega^{\frac{1}{2}}(\rho\sigma/EI)^{\frac{1}{4}}$.

CASE 1 (Dunkerley's Cases I., VII., and IX.).

§ 6. Overhanging shaft fixed in direction at end A. Length $AB = l$.

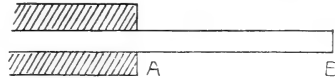

The terminal conditions are :

$$\begin{aligned} \text{At A (or } x=0), \quad y = dy/dx = 0 ; \\ \text{,, B (or } x=l), \quad d^2y/dx^2 = d^3y/dx^3 = 0. \end{aligned}$$

(a) Unloaded bar : Euler-Bernoulli solution (cf. Dunkerley, l.c. p. 288).

The displacement is of the type

$$y = \alpha \{ (\cosh \mu x - \cos \mu x) (\sinh \mu l + \sin \mu l) - (\sinh \mu x - \sin \mu x) (\cosh \mu l + \cos \mu l) \}, \dots \quad (1)$$

where α is a constant.

The equation for μ —and so for ω —(see Dunkerley's equation (A) p. 289) is

$$1 + \cosh \mu l \cos \mu l = 0. \dots \dots \dots (2)$$

The smallest root (see Rayleigh's 'Sound,' art. 174) is

$$\mu l = 1.8751.$$

But by definition of μ ,

$$\omega^2 = (EI/\sigma\rho l^4)(\mu l)^4,$$

i. e. $\omega^2 = 12.36(EI/\sigma\rho l^4), \dots \dots \dots (3)$

or $\omega = 3.516 (EI/\sigma\rho l^4)^{\frac{1}{2}}. \dots \dots \dots (4)$

Usually I shall record only the value of ω^2 , as often more convenient than that of ω . In general ω^2 will equal $(EI/\sigma\rho l^4)$ multiplied by some numerical quantity.

The above method leads to a somewhat complicated expression for the displacement, and throws no direct light on the relationship of whirling to lateral vibrations.

§ 7. (b) Supposing the bar still unloaded, replace the Euler-Bernoulli expression (1) by the much simpler one

$$y = \eta (x^4 - 4lx^3 + 6l^2x^2). \dots \dots \dots (5)$$

If for η we substitute $g\rho\sigma/24EI$, we have the displacement which the shaft would experience if bending under its own weight. For the present purpose we assume

$$\eta \propto \cos kt,$$

where $k/2\pi$ is the frequency of the lateral vibrations.

Neglecting the inertia of the motion of cross-sections relative to their centres of gravity, we find from (5)

$$\left. \begin{aligned} T &= \frac{1}{2}(\eta^2 + \omega^2\eta^2) \frac{104}{45} \sigma\rho l^3, \\ V &= \frac{1}{2}\eta^2 \frac{144}{5} EI l^5; \end{aligned} \right\} \dots \dots (6)$$

whence, by Lagrange's equation,

$$k^2 + \omega^2 = 12.46 (EI/\sigma\rho l^4). \dots \dots (7)$$

This gives the frequency of vibration for any assigned value of ω .

The critical angular velocity answering to whirling is that for which k vanishes, or the motion becomes unstable; it is thus given by

$$\omega^2 = 12.46 (EI/\sigma\rho l^4). \dots \dots (8)$$

The values given by (3) and (7) for the critical value of ω differ by less than $\frac{1}{2}$ per cent.

§ 8. (c) Mass M , inertia I' , at end of massless shaft.

Assume (*cf.* Rayleigh's 'Sound,' art. 183)

$$y = (3z - l\theta)(x/l)^2 + (l\theta - 2z)(x/l)^3, \dots \dots (9)$$

where z and θ are the values of y and dy/dx (which may be regarded as the inclination of the shaft to its undisturbed direction) at the point of attachment of the load.

By Lagrange's equations, or otherwise, we obtain for the frequency

$$\{(k^2 + \omega^2)M - 12EI/l^3\} \{(k^2 - \omega^2)I' - 4EI/l\} = 36(EI/l^2)^2. (10)$$

For any assigned value of ω , (10) gives two values of k^2 , answering to two different types of vibration. Only one of these—which answers normally to the smaller value of k^2 —is properly speaking of the lateral type.

For the critical angular velocity answering to whirling, we put $k=0$ and obtain a quadratic equation for ω^2 , identical with that obtained otherwise by Dunkerley (*l. c.* p. 304).

One of these values of ω^2 is negative, and has no application to the present problem.

If, as in Dunkerley's experiments, I' has but little effect, a first approximation to the desired value of ω^2 —obtained by omitting I' altogether—is

$$\omega^2 = 3EI/Ml^3. \dots \dots (11)$$

As a second approximation, neglecting $(I')^2$ we find

$$\omega^2 = (3EI/MI^3)(1 + 9I'/4MI^2). \quad (12)$$

§ 9. (d) If we know, to start with, that the effect of I' is small, we can simplify the work by taking in place of (9)

$$y = \eta(3lx^2 - x^3)/2l^3. \quad (13)$$

If we substituted $Mgl^3/3EI$ for η we should have the displacement produced in the shaft by a weight Mg at the end.

Assuming η in (13) proportional to $\cos kt$, and still neglecting the mass of the shaft, we have

$$\left. \begin{aligned} T &= \frac{1}{2}M(\dot{\eta}^2 + \omega^2\eta^2) + \frac{1}{2}I'(\dot{\eta}^2 - \omega^2\eta^2)(9/4l^2), \\ V &= \frac{1}{2}EI \cdot 3\eta^2/l^3 \end{aligned} \right\} \quad (14)$$

Thence we have for the frequency equation

$$(k^2 + \omega^2)M + (k^2 - \omega^2)(9I'/4l^2) = 3EI/l^3, \quad (15)$$

and for the critical angular velocity

$$\omega^2 = (3EI/MI^3)(1 - 9I'/4MI^2)^{-1}. \quad (16)$$

Omitting I' altogether we deduce (11); while retaining I' , but omitting $(I')^2$, we have (12).

§ 10. (e) Loaded shaft of appreciable mass.

Dunkerley's hypothesis (see § 1) supplies as the equation for the critical angular velocity

$$1/\omega^2 = 1/\omega_1^2 + 1/\omega_2^2, \quad (17)$$

where ω_1^2 and ω_2^2 are given by (3) and (10) respectively. Supposing I' so small that (12) is applicable, we deduce

$$\frac{1}{\omega^2} = \frac{\sigma\rho l^4}{12 \cdot 36EI} + \frac{MI^3}{3EI} - \frac{3I'l}{4EI}. \quad (18)$$

§ 11. (f) Instead of assuming the truth of (17) we may, following Rayleigh, assume (13) as the type of displacement, no longer neglecting the mass of the shaft. This adds to the value of T in (14) the term

$$\frac{1}{2}(\dot{\eta}^2 + \omega^2\eta^2) \frac{33}{140} \sigma\rho l,$$

and so leads to the frequency equation

$$(k^2 + \omega^2) \left(M + \frac{33}{140} \sigma\rho l \right) + (k^2 - \omega^2)9I'/4l^2 = 3EI/l^3. \quad (19)$$

For the critical angular velocity, noticing that $140/11 = 12 \cdot 73$, we have

$$\frac{1}{\omega^2} = \frac{\sigma\rho l^4}{12 \cdot 73EI} + \frac{MI^3}{3EI} - \frac{3I'l}{4EI}, \quad (20)$$

which is certainly in close agreement with the result (18) obtained by Dunkerley's hypothesis.

(g) If instead of (13) we assume the type (5), but regard I' as small, we obtain in place of (20)

$$\frac{1}{\omega^2} = \frac{\sigma\rho}{12.46EI} l^4 + \frac{Ml^3}{3.2EI} - \frac{5}{9} \frac{I'l}{EI} \dots \dots \dots (21)$$

CASE 2 (Dunkerley's Cases II., VIII., and X.).

Shaft supported at both ends.

§ 12. At each end we have

$$y = d^2y/dx^2 = 0.$$

(a) Unloaded shaft: Euler-Bernoulli solution.

The displacement is of the type

$$y = \alpha \sin \mu x \dots \dots \dots (1)$$

where α is a constant, and the equation for μ is

$$\mu l = \pi, \dots \dots \dots (2)$$

where l is the total length of the shaft.

From this we have

$$\omega^2 = \pi^4 (EI/\sigma\rho l^4) = 97.41 (EI/\sigma\rho l^4) \dots \dots \dots (3)$$

(b) Instead of the Euler-Bernoulli method for the unloaded shaft, we may assume

$$y = \eta x (l^3 - 2lx^2 + x^3) \dots \dots \dots (4)$$

If η were replaced by $g\sigma\rho/24EI$ this would represent the bending of the shaft under its own weight.

Assuming $\eta \propto \cos kt$, we have

$$\left. \begin{aligned} T &= \frac{1}{2}(\eta^2 + \omega^2\eta^2) \frac{31}{630} \sigma\rho l^9, \\ V &= \frac{1}{2}\eta^2(24/5)EI l^5 \end{aligned} \right\}; \dots \dots \dots (5)$$

whence we have for the frequency equation

$$k^2 + \omega^2 = (3024/31)(EI/\sigma\rho l^4), \dots \dots \dots (6)$$

and for the critical velocity

$$\omega^2 = 97.55EI/\sigma\rho l^4, \dots \dots \dots (7)$$

which presents an exceedingly close agreement with (3).

§ 13. (c) Mass (M, I') on massless shaft at a point C

(AC = a , BC = b , $a + b = l$).

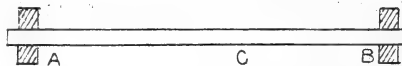

Assuming Rayleigh type formulæ, and employing Lagrange's

equations (see Appendix, § 41) we find for the frequency equation

$$\{M(k^2 + \omega^2) - 3EI(a^{-3} + b^{-3})\} \{I'(k^2 - \omega^2) - 3EI(a^{-1} + b^{-1})\} = 9(EI)^2(b^{-2} - a^{-2})^2. \quad (8)$$

From this, putting $k=0$, we obtain a quadratic equation for the critical angular velocity, identical with that found otherwise by Dunkerley (*l. c.* p. 307).

If in (8) we absolutely neglect I' , we have the simple result

$$k^2 + \omega^2 = 3EI/Ma^2b^2; \quad (9)$$

whilst, retaining I' but neglecting I'^2 , we have for the critical angular velocity

$$\omega^2 = (3EI/Ma^2b^2) \left\{ 1 + \frac{I'}{M} \left(\frac{a-b}{ab} \right)^2 \right\}. \quad (10)$$

(d) If in the last sub-case we start with the assumption that I' is small, we may take

$$\left. \begin{array}{l} \text{for AC, } y = \eta bx (l^2 - b^2 - x^2), \\ \text{for BC, } y' = \eta ax' (l^2 - a^2 - x'^2) \end{array} \right\} (11)$$

If η were replaced by $gM/6EI$ this would represent the bending of the bar under the weight of M .

Assuming $\eta \propto \cos kt$ we find by Lagrange's equations

$$(k^2 + \omega^2)Ma^2b^2 + (k^2 - \omega^2)I'(a-b)^2 = 3EI. \quad (12)$$

For the critical angular velocity, putting $k=0$, we have

$$\omega^2 = (3EI/Ma^2b^2) \{ 1 - (I'/M)(a-b)^2/a^2b^2 \}^{-1}. \quad (13)$$

When $(I'/M)^2$ is neglected this is identical with (10).

§ 14. (e) Loaded shaft of appreciable mass.

On Dunkerley's hypothesis we have for the critical velocity

$$1/\omega^2 = 1/\omega_1^2 + 1/\omega_2^2,$$

where ω_1^2 is given by (3), and ω_2^2 by (8) with k put $=0$. Thus when I' is so small that (10) is applicable, we have

$$\frac{1}{\omega^2} = \frac{\sigma \rho l^4}{97 \cdot 41 EI} + \frac{Ma^2b^2}{3EI} - \frac{I'(a-b)^2}{3EI} (14)$$

(f) If we employ the same Rayleigh formula as in (c),

but do not neglect the mass of the shaft, we replace (8) by

$$\left\{ (k^2 + \omega^2) \left(M + \frac{17}{35} \sigma \rho l \right) - 3EI(a^{-3} + b^{-3}) \right\} \times$$

$$\cdot \left\{ (k^2 - \omega^2)I' + (k^2 + \omega^2) \frac{2}{105} \sigma \rho (a^3 + b^3) - 3EI(a^{-1} + b^{-1}) \right\}$$

$$= (a^2 - b^2)^2 \left\{ 3EIa^{-2}b^{-2} + \frac{3}{35} (k^2 + \omega^2) \sigma \rho \right\}^2 \dots \dots (15)$$

This may be expected to give best results when the load is at or near the centre of the span, as the assumed type of displacement, which answers to the load only, is then nearest to that natural to a massive but unloaded shaft.

If the load is at the exact centre (15) gives

$$k^2 + \omega^2 = 48EI \div \left\{ Ml^3 + \frac{17}{35} \sigma \rho l^4 \right\} \dots \dots (16)$$

When M is neglected this gives

$$k^2 + \omega^2 = 98 \cdot 8EI / \sigma \rho l^4 \dots \dots (17)$$

Putting $k=0$ in (16) and (17) we have of course the corresponding critical angular velocities. The value obtained from (17) is a very fair approximation for the case of an unloaded shaft (*cf.* (3)).

§ 15. (*g*) When I' is small, but the load M is not near the centre of the span, and is of the same order as the mass m of the shaft, better results are obtained from the following displacement types:—

$$\left. \begin{array}{l} \text{for AC, } y = \eta x \{ m(l-x)(l^2 + lx - x^2) + 4Mb(l^2 - b^2 - x^2) \}, \\ \text{for BC, } y' = \eta x' \{ m(l-x')(l^2 + lx' - x'^2) + 4Ma(l^2 - a^2 - x'^2) \}. \end{array} \right\} (18)$$

If η were replaced by $g/24EI$ this would give the bending of the shaft under its own weight and that of the load combined. Assuming $\eta \alpha \cos kt$ we obtain the frequency equation

$$(k^2 + \omega^2)A + (k^2 - \omega^2)I'B = C, \dots \dots (19)$$

giving for the critical angular velocity

$$\omega^2 = C \div (A - I'B); \dots \dots (20)$$

where for brevity

$$\left. \begin{array}{l} A = 1 + \frac{18M}{31m} \left(\frac{ab}{l^2} \right) \left\{ 17 + 52 \frac{ab}{l^2} + 76 \left(\frac{ab}{l^2} \right)^2 + 36 \left(\frac{ab}{l^2} \right)^3 \right\} \\ + \frac{96}{31} \left(\frac{M}{m} \right)^2 \left(\frac{ab}{l^2} \right)^2 \left\{ 8 + 121 \frac{ab}{l^2} + 117 \left(\frac{ab}{l^2} \right)^2 \right\} + \frac{40320}{31} \left(\frac{M}{m} \right)^3 \left(\frac{ab}{l^2} \right)^4, \\ B = \frac{630}{31} \frac{(a-b)^2}{ml^4} \left(1 + 2 \frac{ab}{l^2} + \frac{8Mab}{m l^2} \right), \\ C = \frac{3024EI}{31 ml^3} \left\{ 1 + 10 \frac{Mab}{ml^2} \left(1 + \frac{ab}{l^2} \right) + 40 \left(\frac{M}{m} \right)^2 \left(\frac{ab}{l^2} \right)^2 \right\}, \end{array} \right\} (21)$$

§ 16. Prof. Dunkerley carried out a number of experiments under the conditions of Case 2. He employed a shaft unloaded, or loaded with one or other of two pulleys of different sizes. As a preliminary to comparing his theory with observation, he had to calculate critical speeds for the pulleys alone, neglecting the mass of the shaft. Table I. compares the number of revolutions per minute which he calculated from a formula equivalent to (8), with k omitted, with the corresponding numbers which are given by the much simpler formulæ (9) and (13). The results apply of course only to the particular shaft and pulleys employed by Dunkerley.

TABLE I.— N_2 (Number of revolutions per minute for whirling).

| Pulley. | Formula. | $b/l=$ | 1/2. | 1/3. | 1/6. | 1/11. | 1/32. |
|---------|----------|-----------------------|------|------|------|-------|---------|
| I. | { | (8) [Dunkerley's]... | 1495 | 1683 | 2705 | 4621 | 13537 |
| | | (9) | 1495 | 1682 | 2690 | 4532 | 12343 |
| | | (13) | 1495 | ... | 2710 | 4636 | (16364) |
| II. | { | (8) [Dunkerley's] ... | 997 | 1122 | 1808 | 3116 | 10355 |
| | | (9) | 997 | 1121 | 1794 | 3015 | 8231 |
| | | (13) | 997 | ... | 1808 | 3119 | (13716) |

§ 17. The results from the formula (13) for the smallest value of b/l are put in brackets because the assumption on which the formula is based—viz., that the contribution from I' is small—is then far from being satisfied, so that the result is *a priori* unsatisfactory. The closeness with which the simplest formula (9) approaches to the results from the complicated formula (8) is rather surprising.

In Dunkerley's case the value given by (3) for N_1 —the critical number of revolutions per minute for the shaft when unloaded—is 1122. Thus for the value 1/32 of b/l we have

$$\begin{aligned} \omega_2/\omega_1 = N_2/N_1 &= 13537/1122 \text{ for pulley I. (or 12 roughly),} \\ &= 10355/1122 \quad \text{,,} \quad \text{II. (or 9 roughly).} \end{aligned}$$

Thus the contribution from ω_2 , or N_2 , to the critical speed for the loaded shaft on Dunkerley's hypothesis (1) § 1 is only about one-eightieth of that from ω_1 , even for the case of the heavier pulley II. Under such circumstances an error of even 100 per cent. in the value of ω_2 , or N_2 , would exert but little influence. It is thus clear that under the conditions of Dunkerley's experiments the simple formula (9) would for all practical purposes be as satisfactory as (8).

§ 18. Table II. compares the speeds at which Dunkerley observed whirling to commence with those which he

calculated from (3) and (8) on his hypothesis (1) § 1, and with those which are given by the formulæ (15) and (20) singly.

TABLE II.—Critical revolutions per minute.

| Pulley I. | | | | | Pulley II. | | | |
|------------|-----------|-------------------------|------|------|------------|-------------------------|------|------|
| <i>bl.</i> | Observed. | (3) & (8) Dunkerley. | (15) | (20) | Observed. | (3) & (8) Dunkerley. | (15) | (20) |
| 1/2 | 921 | 897 | 901 | 899 | 769 | 745 | 747 | 769 |
| 1/3 | 952 | 933 | 951 | 940 | 803 | 793 | ... | 799 |
| 1/6 | 1044 | 1036 | 1113 | 1050 | 942 | 953 | ... | 974 |
| 1/8 | 1101 | 1069 | 1179 | 1079 | 1007 | 1013 | ... | 1031 |
| 1/11 | 1123 | 1089 | 1241 | 1100 | 1046 | 1055 | ... | 1074 |
| 1/32 | 1150 | 1117 | 1362 | 1121 | 1130 | 1115 | ... | 1121 |

Formula (15) is derived from a type of displacement which treats the shaft as massless, so its failure to agree well with experiment when the load is near one of the ends was to be anticipated. The simple formula (14) would give results in close agreement with those calculated by Dunkerley.

CASE 3 (Dunkerley's Cases III. and XI.).

§ 19. Shaft supported at end A and at a second point B,

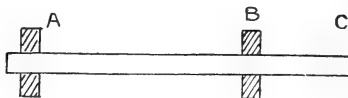

with BC overhanging ($AB=l$, $BC=c$). Taking B as origin of coordinates x , y for BC, and x' , y' for BA, we have:

$$\begin{aligned} \text{At } x=0, y=0 \text{ with continuity in } dy/dx \text{ and } d^2y/dx^2, \\ \text{,, } x=c, d^2y/dx^2=d^3y/dx^3=0 \text{ (when there is no load),} \\ \text{,, } x'=l, y'=d^2y'/dx'^2=0. \end{aligned}$$

(a) Unloaded shaft: Euler-Bernoulli solution. The displacements are cumbersome to record. The equation determining μ (cf. Dunkerley, *l.c.* equation (A) p. 291) is

$$(\cosh \mu l \sin \mu l - \sinh \mu l \cos \mu l)(\cosh \mu c \sin \mu c - \sinh \mu c \cos \mu c) - 2 \sinh \mu l \sin \mu l (1 + \cosh \mu c \cos \mu c) = 0. \quad (1)$$

Except for special values of c/l this is somewhat intractable. On his p. 292 Dunkerley specifies 3.08 as the limiting value to which μl approaches when c/l is indefinitely reduced.

This is not quite correct; the true limiting value is π , exactly as in (a) Case 2.

Treating c/l as small though not negligible, I find for the next approximation

$$\mu l = \pi(1 - \frac{1}{3}\pi^2 c^3/l^3). \quad \dots \quad (2)$$

Whence, substituting its numerical value for π , we have for the critical angular velocity

$$\omega^2 = 97.41(EI/\sigma\rho l^4)(1 - 6.6c^3/l^3). \quad \dots \quad (3)$$

This is satisfactory so long as $(c/l)^3(\pi^3/6) \coth \pi$ is small compared with unity.

A way of treating this problem by an assumed type of vibration will be found below in (f).

§ 20 (b) Mass (M, I') on overhanging part of massless shaft at distance c from the nearest support.

Formulæ of the Rayleigh type are

$$\left. \begin{aligned} \text{for BC, } y &= \frac{3z - c\theta}{c(3c + 4l)}(2lx + 3x^2) + \frac{\theta c(2l + 3c) - 2z(l + 3c)}{3c + 4l} \left(\frac{x}{c}\right)^3, \\ \text{,, BA, } y' &= \frac{c\theta - 3z}{cl(3c + 4l)}(2l^2x' - 3la'^2 + x'^3). \end{aligned} \right\} \quad (4)$$

By Lagrange's equations we find for the frequency equation

$$\left\{ M(k^2 + \omega^2) - 12EI \frac{3c + l}{c^3(3c + 4l)} \right\} \left\{ I'(k^2 - \omega^2) - 12EI \frac{c + l}{c(3c + 4l)} \right\} \\ = \frac{36(EI)^2(3c + 2l)^2}{c^4(3c + 4l)^2}. \quad \dots \quad (5)$$

Putting $k=0$ we obtain an equation for the critical angular velocity which is identical with Dunkerley's (*l. c.* p. 314).

If in (5) we neglect I' altogether, we find

$$k^2 + \omega^2 = 3EI \div Mc^2(c + l). \quad \dots \quad (6)$$

Proceeding to a second approximation, retaining only the lowest power of I' , we find for the critical angular velocity, putting $k^2=0$,

$$\omega^2 = \frac{3EI}{Mc^2(c + l)} \left\{ 1 + \frac{1}{4} \frac{I}{M} \frac{(3c + 2l)^2}{c^2(c + l)^2} \right\}. \quad \dots \quad (7)$$

This last result will not be satisfactory when c/l is very small, or the load very close to B; but under these conditions $1/\omega^2$ is very small, so that on Dunkerley's hypothesis the load has but little real influence on the critical velocity.

(c) If in the problem treated under (b) we assume the effect of I' small to start with, we may employ the simpler type

$$\left. \begin{aligned} \text{for BC, } y &= \eta(2clx + 3cx^2 - x^3), \\ \text{,, BA, } y' &= -\eta(c/l)(2l^2x' - 3lx'^2 + x'^3). \end{aligned} \right\} \dots (8)$$

If η were replaced by $gM/6EI$ this would represent the bending of the shaft under the weight of M .

Treating I' as small, we find by assuming $\eta \propto \cos kt$

$$(k^2 + \omega^2)4Mc^2(c+l)^2 + (k^2 - \omega^2)I'(3c+2l)^2 = 12EI(c+l). \quad (9)$$

When I' is wholly neglected, this agrees with (6).

For the critical angular velocity, we have from (9)

$$\omega^2 = \frac{3EI}{Mc^2(c+l)} \left\{ 1 - \frac{I'(3c+2l)^2}{M4c^2(c+l)^2} \right\}^{-1}, \dots (10)$$

which agrees with (7) when $(I')^2$ is neglected.

§ 21. (d) Loaded shaft of appreciable mass.

On Dunkerley's hypothesis the critical angular velocity is given by

$$1/\omega^2 = 1/\omega_1^2 + 1/\omega_2^2,$$

where ω_1 is given by (1) and ω_2 by (5) with k omitted. So long as the effect of I' is small, and c/l does not exceed $1/4$, the following approximation is deducible from (3) and (7)

$$\frac{1}{\omega^2} = \frac{\sigma\rho l^4}{97.41EI} \left(1 - 0.6 \frac{c^3}{l^3} \right)^{-1} + \frac{Mc^2(c+l)}{3EI} - \frac{I'(3c+2l)^2}{12EI(c+l)}. \quad (11)$$

(e) If, while assuming the displacements (8), we allow for the mass of the rod, we replace (9) by

$$\begin{aligned} (k^2 + \omega^2) \left[M \cdot 4c^2(c+l)^2 + \sigma\rho \left\{ \frac{4}{3} l^2(l^3 + c^3) + \frac{33}{35} (l^5 + c^5) \right. \right. \\ \left. \left. - \frac{11}{5} l(l^4 - c^4) \right\} \right] + (k^2 - \omega^2) I'(3c+2l)^2 = 12EI(c+l). \quad (12) \end{aligned}$$

Putting $k=0$ we have a form of the critical velocity equation in which allowance is made for the inertia of both shaft and load.

(f) As an alternative to (c) we may assume a type of displacement answering to the form taken by the shaft when bending under its own weight, viz.

$$\left. \begin{aligned} \text{for BC,} \\ y &= \eta \{ lx(4c^2 - l^2) + 6c^2x^2 - 4cx^3 + x^4 \}; \\ \text{for BA,} \\ y' &= \eta \{ -3l^3x' + 6l^2x'^2 - 4lx'^3 + x'^4 + (2/l)(l^2 - c^2)(2l^2x' - 3lx'^2 + x'^3) \} \end{aligned} \right\} \dots (13)$$

In the statical problem $\eta \equiv g\sigma\rho/24EI$. In the kinetic problem, assuming $\eta \propto \cos kt$, we find

$$\begin{aligned} & (k^2 + \omega^2) \left[9Mc^2(c+l)^2(3c^2 + cl - l^2)^2 + \sigma\rho \left\{ l^3 - \frac{33}{10}l^2(l^2 - c^2) \right. \right. \\ & \left. \left. + \frac{96}{35}l^5(l^2 - c^2)^2 + 3c^3l^2(4c^2 - l^2)^2 + \frac{78}{5}c^6l(4c^2 - l^2) + \frac{104}{5}c^9 \right\} \right] \\ & + (k^2 - \omega^2)I' \times 9\{4c^2(l+c) - l^3\}^2 = \frac{216}{5}EI(l^3 - 5l^3c^2 + 10lc^4 + 6c^5). \quad (14) \end{aligned}$$

Putting $k=0$, we have a second formula for the critical velocity, in which allowance is made for both shaft and load.

If in (14) we omit M and I' we have a result appropriate to the unloaded bar in (a). It is not, however, very satisfactory unless c/l is small. When powers of (c/l) above the fourth are neglected it gives for the critical angular velocity

$$\omega^2 = 97.55(EI/\sigma\rho l^4) \{1 - 0.06(c/l)^2 - 6.8(c/l)^3 + 3.5(c/l)^4\}, \quad (15)$$

a result very similar to (3).

(g) An assumption which appears more natural at first sight than that made in either (e) or (f) is that the type of displacement answers to the bending of the shaft under its own weight and that of the load combined. This gives

$$\left. \begin{aligned} \text{for CB, } y &= \eta \left\{ \frac{1}{6}M(\xi^3 - c^2\xi) + \frac{1}{24}\sigma\rho(\xi^4 - c^3\xi) + (c - \xi)H \right\}, \\ \text{.. AB, } y' &= \eta \left\{ \frac{1}{6}P(\xi'^3 - l^2\xi') + \frac{1}{24}\sigma\rho(\xi'^4 - l^3\xi') \right\}, \end{aligned} \right\} \quad (16)$$

$$\left. \begin{aligned} \text{where } \xi &= c - x, & Pl &= Mc - \frac{1}{2}\sigma\rho(l^2 - c^2), \\ \xi' &= l - x', & H &= \frac{1}{3}(Pl^2 + Mc^2) + \frac{1}{8}\sigma\rho(l^3 + c^3). \end{aligned} \right\} \quad (17)$$

Writing for shortness

$$\left. \begin{aligned} R &\equiv Mc^2H^2 + \sigma\rho \left\{ \frac{2}{945}(Pl^7 + M^2c^7) + \frac{11}{8640}\sigma\rho(Pl^8 + Mc^8) + \frac{(\sigma\rho)^2}{72^2}(l^9 + c^9) \right. \\ &\quad \left. + \frac{1}{3}c^3H^2 - \frac{7}{180}c^5MH - \frac{1}{90}c^6\sigma\rho H \right\}, \\ Q &\equiv (H + \frac{1}{6}c^2M + \frac{1}{24}c^3\sigma\rho)^2, \\ S &\equiv EI \left\{ \frac{1}{3}(Pl^3 + M^2c^3) + \frac{1}{4}\sigma\rho(Pl^4 + Mc^4) + \frac{1}{20}(\sigma\rho)^2(l^5 + c^5) \right\}, \end{aligned} \right\}$$

we find for the frequency equation

$$(k^2 + \omega^2)R + (k^2 - \omega^2)I'Q = S, \quad \dots \quad (19)$$

and so for the critical angular velocity

$$\omega^2 = S \div (R - QI'). \quad \dots \quad (20)$$

Obviously in general the evaluation of R and S is laborious.

§ 22. (*h*) It will be found that none of the types (*e*), (*f*), or (*g*) gives results which invariably accord well with experiment. It is clear that the most natural way of bending may be such that portions of the bar on opposite sides of the support at B have "centrifugal forces" acting on them in opposite directions. This suggests the use of a type of displacement answering to an imaginary gravitational force oppositely directed on opposite sides of B. Such a type is

$$\left. \begin{aligned} \text{for BC, } y &= \eta \{ x^4 - 4cx^3 + 6c^2x^2 + 2A(3cx^2 - x^3) - Bx \}, \\ \text{,, BA, } y' &= -\eta \{ x'^4 - 4lx'^3 + 6l^2x'^2 + 2A'(3lx'^2 - x'^3) - Bx' \}, \end{aligned} \right\} (21)$$

where

$$\left. \begin{aligned} A &= 2M/\sigma\rho, & A' &= 2P/\sigma\rho, \\ B &= (8Pl^2 + 3\sigma\rho l^3)/\sigma\rho, \\ Pl &= -Mc - \frac{1}{2}\sigma\rho(l^2 + c^2). \end{aligned} \right\} \dots \quad (22)$$

Putting for shortness

$$\left. \begin{aligned} R' &= Mc^2 \{ 3(l^3 - c^3) + 8(Pl^2 - Mc^2)/\sigma\rho \}^2 + \frac{104}{45} \sigma\rho(l^9 + c^9) \\ &+ \frac{59}{5} (Pl^8 + Mc^8) - \frac{26}{15} (8Pl^2 + 3\sigma\rho l^3)(l^6 + c^6) + \frac{52}{35} \frac{8}{\sigma\rho} (P^2l^7 + M^2c^7) \\ &+ \frac{1}{3\sigma\rho} (l^3 + c^3)(8Pl^2 + 3\sigma\rho l^3)^2 - \frac{22}{5\sigma\rho} (8Pl^2 + 3\sigma\rho l^3)(Pl^5 + Mc^5), \\ S' &= 144EI \left\{ \frac{1}{5}(l^5 + c^5) + \{ Pl^4 + Mc^4 + \frac{4}{3\sigma\rho} (P^2l^3 + M^2c^3) \} / \sigma\rho \right\}, \end{aligned} \right\} (23)$$

we find for the frequency equation

$$k^2 + \omega^2 = S'/R', \quad \dots \quad (24)$$

and for the critical angular velocity

$$\omega^2 = S'/R'. \quad \dots \quad (25)$$

§ 23. Table III. compares the results obtainable from Dunkerley's formula, corresponding to (5) with $k=0$, with those given by the simple formulæ (6) and (10) for the case when the mass of the shaft is neglected.

TABLE III.

| <i>c/l</i> | 1.00 30.66 | | 2.57 29.10 | | 3.66 28.0 | | 4.99 26.66 | | 7.66 24.00 | | 10.32 21.33 | |
|------------------|-------------------|-------|---------------|------|--------------|------|---------------|------|---------------|------|----------------|-----|
| | Pulley Formula | I. | II. | I. | II. | I. | II. | I. | II. | I. | II. | I. |
| (5) | 16390 | 13816 | 4808 | 3353 | 3318 | 2277 | 2428 | 1643 | 1572 | 1056 | 1162 | 782 |
| (6) | 12014 | 8020 | 4603 | 3157 | 3256 | 2209 | 2393 | 1617 | 1562 | 1051 | 1161 | 779 |
| (10) | 15214 | 14733 | 4747 | 3350 | 3307 | 2275 | | | | | | |

The results from (5) are taken from Dunkerley's paper. The values of *c/l* really differed slightly for the two pulleys; the values given in the headings to the Table are the means for the two cases.

It will be seen that except in the first instance, where the pulley was only an inch from a support, the simple formula (6) differs but little from (5). The difference for the larger values of *c/l* is so small that the improvement obtained when (10) is substituted for (6) is hardly worth considering.

§ 24. Table IV. gives particulars of the critical number of revolutions per minute of an unloaded shaft as observed and calculated by Dunkerley, and as calculated from several of the other equations advanced above.

TABLE IV.—Unloaded overhanging Shaft, critical speeds.

| <i>c/l</i> | Observed value. | Calculated values from | | | | |
|------------|-----------------|------------------------|------|------------|------|------------|
| | | (1) by Dunkerley. | (3) | (14)(M=0). | (15) | (25)(M=0). |
| 1/10 ... | 1309 | 1301 | 1351 | | | |
| 1/7 ... | 1435 | 1397 | 1450 | | | |
| 1/5 ... | 1472 | 1516 | 1571 | | 1574 | |
| 1/3 ... | 1606 | 1704 | | 2013 | | 1747 |
| 1/2 ... | 1558 | 1606 | | 3825 | | 1627 |
| 1 ... | 1002 | 1031 | | 1058 | | 1046 |

The values calculated by Dunkerley for small values of *c/l* are apparently affected by the error referred to in (a); if this were corrected his values should practically coincide

with those obtained from (3). The large difference between the observed values answering to the values $1/3$ and $1/2$ of c/l and those calculated from (14) is to be ascribed to the fact that the type of displacement assumed in (f) answers more nearly to a higher harmonic than to the fundamental vibration. This serves to illustrate a contingency which must never be lost sight of when applying Rayleigh's method. We know from his general theory that the value so calculated for k can never be too low—excluding of course errors of calculation—so that when results have been obtained from more than one assumed type of vibration we need never be at loss which to prefer.

§ 25. Table V. compares the results observed by Dunkerley in a shaft carrying a pulley with those variously calculated.

TABLE V.—Loaded overhanging Shaft, critical speeds.

| Pulley. | l inches. | c inches. | Observed speed. | Calculated speeds from | | | | |
|---------|----------------|----------------|--------------------|----------------------------|--------------|--------------|--------------|--------------|
| | | | | (1) & (5) by Dunkerley. | (e) (12). | (f) (14). | (g) (20). | (h) (25). |
| I. | 30.70 | 1.00 | 1223 | 1170 | | | 1215 | |
| | 29.10 | 2.61 | 1329 | 1256 | | | 1342 | |
| | 28.00 | 3.69 | 1384 | (1288) | [1678] | 1385 | | |
| | 26.66 | 5.02 | 1407 | (1286) | (1578) | 1454 | [1839] | 1394 |
| | 24.00 | 7.69 | 1224 | 1156 | 1267 | | | 1229 |
| | 21.33 | 10.35 | 968 | 941 | 971 | | 1073 | |
| II. | 30.63 | 1.00 | 1227 | 1173 | | | 1220 | |
| | 29.10 | 2.54 | 1276 | 1213 | | | (1416) | |
| | 28.00 | 3.63 | 1281 | (1191) | [1473] | 1311 | [1927] | |
| | 26.66 | 4.96 | 1215 | (1114) | 1280 | (1326) | | 1200 |
| | 24.00 | 7.63 | 928 | 898 | 947 | | | 944 |
| | 21.33 | 10.29 | 712 | 703 | 711 | | | |

Calculated results differing widely from the observed are put in [] brackets; those whose divergence is less but still conspicuous are put in () brackets. When c/l is small all the formulæ necessarily supply results which approach closely to those for an unloaded shaft.

When there is a conspicuous difference between observed and calculated values, the latter, in accordance with Rayleigh's principle, are invariably the larger, except in the case of Dunkerley's own calculations.

CASE 4 (Dunkerley's Cases IV. and XII.).

§ 26. Shaft fixed in direction at one end (A, $x=0$), and supported at the other (B, $x=l$).

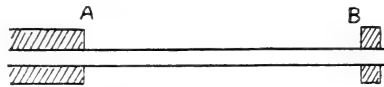

(a) Unloaded shaft : Euler-Bernoulli solution.
The displacement is given by

$$y = \alpha \{ (\cosh \mu x - \cos \mu x)(\sinh \mu l + \sin \mu l) - (\sinh \mu x - \sin \mu x)(\cosh \mu l + \cos \mu l) \}, \quad (1)$$

where α is a constant.

The equation determining μ (*cf.* Dunkerley, *l. c.* p 294) is

$$\coth \mu l = \cot \mu l. \quad (2)$$

The least root of this (Rayleigh's 'Sound,' arts. 180 and 174) is

$$\mu l = 3.9266. \quad (3)$$

Answering to which we have for the critical angular velocity

$$\omega^2 = 237.7 (EI/\sigma \rho l^4). \quad (4)$$

(b) Instead of the Euler-Bernoulli method, we may assume for the unloaded shaft

$$y = \eta x^2(l-x)(3l-2x). \quad (5)$$

If η were replaced by $g\sigma\rho/48EI$, this would give the bending of the shaft under its own weight.

For the dynamical problem we find

$$\left. \begin{aligned} T &= \frac{1}{2}\sigma\rho(\dot{\eta}^2 + \omega^2\eta^2)(19/630)l^3, \\ V &= \frac{1}{2}\eta^2(36/5)EI l^5; \end{aligned} \right\} \quad (6)$$

whence we have for the frequency equation

$$k^2 + \omega^2 = (4536/19) (EI/\sigma \rho l^4), \quad (7)$$

and for the critical angular velocity

$$\omega^2 = 238.7 EI/\sigma \rho l^4. \quad (8)$$

The value of ω given by (8) is only 0.2 per cent. in excess of that given by the exact equation (4).

(c) Mass (M, I') on massless shaft.

Supposing the mass at C ($AC=a$, $BC=b$), and measuring

x from A to C, and x' from B to C, we have for the Rayleigh type of displacement

$$\left. \begin{array}{l} \text{for AC, } y = (3z - a\theta)(x^2/a^2) + (a\theta - 2z)(x^3/a^3), \\ \text{for BC, } y' = \frac{1}{2}(3z + b\theta)(x'/b) - \frac{1}{2}(b\theta + z)(x'^3/b^3). \end{array} \right\} \quad (9)$$

By Lagrange's equations we find

$$\left\{ M(k^2 + \omega^2) - 3EI \frac{a^3 + 4b^3}{a^3b^3} \right\} \left\{ I'(k^2 - \omega^2) - EI \frac{3a + 4b}{ab} \right\} \\ = (3EI)^2 \left(\frac{a^2 - 2b^2}{a^2b^2} \right)^2. \quad (10)$$

When k is omitted this agrees with Dunkerley's equation (*l. c.* p. 321). Equation (10) splits into two factors when

$$a/b = \sqrt{2} = 1.414.$$

In this position of the load the frequencies of what may be called the transverse and the oscillational vibrations are respectively given by

$$\left. \begin{array}{l} k^2 = -\omega^2 + (51 + 36\sqrt{2})(EI/Ml^3) \equiv -\omega^2 + 101.9(EI/Ml^3), \\ k^2 = \omega^2 + (7 + 5\sqrt{2})(EI/I'l) \equiv \omega^2 + 14.14(EI/I'l). \end{array} \right\} \quad (11)$$

If we wholly neglect I' in (10), we have for the critical velocity

$$\omega^2 = 12EI l^3 \div \{ Ma^3b^2(3a + 4b) \}; \quad (12)$$

while retaining I' , but neglecting $(I')^2$, we have

$$\omega^2 = \frac{12EI l^3}{Ma^3b^2(3a + 4b)} \left\{ 1 + \frac{9I'(a^2 - 2b^2)^2}{Ma^2b^2(3a + 4b)^2} \right\}. \quad (13)$$

(*d*) If we assume I' small to commence with, still neglecting the mass of the shaft, we may take

$$\left. \begin{array}{l} \text{in AC, } y = \eta \{ 2l^3(3ax^2 - x^3) - a^2(2a + 3b)(3lx^2 - x^3) \}, \\ \text{in BC, } y' = \eta \{ 3a^2bl^2x' - a^2(2a + 3b)x'^3 \}. \end{array} \right\} \quad (14)$$

When η is replaced by $Mg/12EI l^3$ we have the bending of the shaft under the weight of M .

For the kinetic problem, we find for the frequency equation

$$(k^2 + \omega^2)Ma^3b^2(3a + 4b)^2 + (k^2 - \omega^2)9I'a(a^2 - 2b^2)^2 \\ = 12EI l^3(3a + 4b), \quad (15)$$

and for the critical angular velocity

$$\omega^2 = \frac{12EI l^3}{Ma^3b^2(3a + 4b)} \left\{ 1 - \frac{9I'(a^2 - 2b^2)^2}{Ma^2b^2(3a + 4b)^2} \right\}^{-1}. \quad (16)$$

This agrees with (12) when I' is neglected, with (13) when $(I')^2$ only is neglected.

§ 27. (e) Load (M, I') on massive shaft.

On Dunkerley's hypothesis we have

$$1/\omega^2 = 1/\omega_1^2 + 1/\omega_2^2,$$

where ω_1 is given by (4), and ω_2 by (10), with k omitted.

If the effect of (I') is small we should get from (4) and (13)

$$\frac{1}{\omega^2} = \frac{\sigma \rho l^4}{237.7 EI} + \frac{Ma^3 l^2 (3a + 4b)}{12 EI l^3} - \frac{3 I' a (a^2 - 2b^2)^2}{4 EI l^3 (3a + 4b)}. \quad (17)$$

In this case I have not worked out an independent dynamical method taking both shaft and load into account; but the difficulties would be less than in case (3).

CASE 5 (Dunkerley's Cases V. and XIII.).

§ 28. Shaft supported at ends A and B, and at intermediate point O

$$(OA = a, \quad OB = b, \quad a + b = l).$$

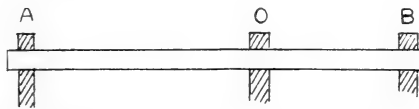

(a) Unloaded shaft: Euler-Bernoulli solution.

As pointed out by Dunkerley, the mathematical conditions are all satisfied if the two relations (*cf.* § 12)

$$\left. \begin{aligned} \mu a &= i\pi, \\ \mu b &= j\pi \end{aligned} \right\} \dots \dots \dots (1)$$

where i and j are integers, can exist simultaneously.

To have a real application to the practical problem, i and j must be small integers, so that (1) is of very limited scope. If, however, the spans are equal, or if the longer, say a , is a multiple of b , we have obviously

$$\mu b = \pi. \quad \dots \dots \dots (2)$$

Answering to this, we obtain for the critical velocity

$$\omega^2 = \pi^4 EI / \sigma \rho b^4 = 97.41 EI / \sigma \rho b^4. \quad \dots \dots (3)$$

This is the same result (*cf.* (a) Case 2) as for a shaft of length l supported at both ends.

Excluding the above special cases, the general equation obtained by Dunkerley (*l. c.* p. 296) is

$$\coth \mu a - \cot \mu a + \coth \mu b - \cot \mu b = 0. \quad \dots \dots (4)$$

If b/a be very small, a first approximation is

$$\coth \mu a - \cot \mu a = 0,$$

the least root of which (*cf.* (a) case 4) is

$$\mu a = 3.9266.$$

This reduction to (a) case 4 only implies, what is physically obvious, that when the support O is close to an end it serves to fix the terminal direction of the shaft. If b/a in (4) is treated as small, and $(b/a)^2$ as negligible, we deduce

$$\mu a = 3.9266 (1 - b/3a), \dots (5)$$

whence

$$\omega^2 = 237.7 (1 - 4b/3a) (EI/\sigma\rho a^4). \dots (6)$$

(b) As (4) is somewhat unmanageable except for special cases, I have tried several algebraic types of displacement, amongst them

$$\left. \begin{aligned} \text{for AO, } y &= \eta \{x^4 - 4a^3x - C(x^3 - 3a^2x) - Dx\}, \\ \text{for BO, } y' &= \eta \{x'^4 - 4b^3x' - C'(x'^3 - 3b^2x') + Dx'\}. \end{aligned} \right\} (7)$$

Here x is measured from A towards O, and x' from B towards O, and

$$\begin{aligned} C &\equiv (3a^2 + ab - b^2)/2a, & C' &\equiv (3b^2 + ab - a^2)/2b, \\ D &\equiv ab(a - b). \end{aligned}$$

Replacing η in (7) by $g\sigma\rho/24EI$ we should have the bending of the shaft under its own weight.

From the kinetic method I find

$$\begin{aligned} k^2 + \omega^2 &= (3/5)(EI/\sigma\rho) \{3(a^5 + b^5) + 5ab(a^3 + b^3) - 5a^2b^2(a + b)\} \div \left\{ \frac{37}{9}(a^9 + b^9) \right. \\ &+ \frac{68}{35}(C^2a^7 + C'^2b^7) + \frac{1}{3}D^2(a^3 + b^3) - \frac{113}{20}(Ca^8 + C'b^8) + \frac{7}{3}D(a^6 - b^6) - \frac{8}{5}D(Ca^5 - C'b^5) \left. \right\}. \end{aligned} (8)$$

Putting $k^2 = 0$ we have the critical angular velocity. The evaluation, though perfectly straightforward, is in general tedious.

For b/a small, however, we easily find

$$k^2 + \omega^2 = (4536/19) (1 - 4b/3a) (EI/\sigma\rho a^4), \dots (9)$$

and thence for the critical velocity

$$\omega^2 = 238.7 (1 - 4b/3a) (EI/\sigma\rho a^4), \dots (10)$$

a result of course in close agreement with (6) (*cf.* also (8) and (4) of case 4, § 26).

Again, if $b = a$ we obtain from (8) for the period and

critical velocity

$$k^2 + \omega^2 = (4536/19)(EI/\sigma\rho a^4), \quad \dots \quad (11)$$

$$\omega^2 = 238.7 (EI/\sigma\rho a^4). \quad \dots \quad (12)$$

(c) As an alternative type to (7) let us take

$$\left. \begin{aligned} \text{for AO, } y &= -\eta\{x^4 - 4a^3x - C(x^3 - 3a^2x) - Dx\}, \\ \text{for BO, } y' &= \eta\{x'^4 - 4b^3x' - C'(x'^3 - 3b^2x') - Dx'\}, \end{aligned} \right\} \quad (13)$$

where now

$$C \equiv (3a^3 + 4a^2b + b^3) \div 2a(a + b), \quad C' \equiv (a^3 + 4ab^2 + 3b^3) \div 2b(a + b),$$

$$D \equiv ab(a^2 + b^2)/(a + b).$$

The above displacements answer to an imaginary gravitational force oppositely directed on the two sides of O.

By Lagrange's equations we deduce

$$k^2 + \omega^2 = (3/5)(EI/\sigma\rho l)(3l^6 - 10abl^4 - 5a^2b^2l^2 + 20a^3b^3) \div \left\{ \frac{37}{9}(a^3 + b^3) + \frac{68}{35}(C^2a^7 + C'^2b^7) + \frac{1}{3}D^2(a^3 + b^3) - \frac{113}{20}(Ca^3 + C'b^3) + \frac{7}{3}D(a^6 + b^6) - \frac{8}{5}D(Ca^5 + C'b^5) \right\}. \quad \dots \quad (14)$$

Omitting k^2 , we have the critical angular velocity.

When b/a is small (14) agrees with (8) in giving (9) and (10). For $b=a$, however, it gives the widely different result

$$k^2 + \omega^2 = (48 \times 63/31)(EI/\sigma\rho a^4), \quad \dots \quad (15)$$

whence for the critical velocity

$$\omega^2 = 97.55(EI/\sigma\rho a^4). \quad \dots \quad (16)$$

This is identical with (7) of case (2), which applies to a single span of length a , and is in close agreement—as it should be—with (3), when b is replaced by a . The divergence of (12) really means (*cf.* § 24 and Table IV.) that its assumed type of vibration answers not to the fundamental note but to an harmonic.

§ 29. Mass (M, I') on massless shaft.

(d) Supposing the load at C, between O and A, at a distance c from O, Rayleigh type displacements are :

$$\left. \begin{aligned} \text{for OC, } y &= \frac{2b(3z - c\theta)}{c(4b + 3c)} \left(x + \frac{3x^2}{2b} \right) + \frac{\theta c(2b + 3c) - 2z(b + 3c)}{4b + 3c} \frac{x^3}{c^3}, \\ \text{for AC, } y' &= \frac{3z + (a - c)\theta}{2(a - c)} x' - \frac{(a - c)\theta + z}{2(a - c)^3} x'^3, \\ \text{for OB, } y'' &= \frac{2b(c\theta - 3z)}{c(4b + 3c)} \left(x'' - \frac{3x''^2}{2b} + \frac{1x''^3}{2b^2} \right), \end{aligned} \right\} \quad (17)$$

where x and x'' are measured from O, and x' from A.

Lagrange's equations lead to

$$\begin{aligned} & \left[M(k^2 + \omega^2) - 3EI \left\{ \frac{1}{(a-c)^3} + \frac{4(b+3c)}{c^3(4b+3c)} \right\} \right] \\ & \times \left[I'(k^2 - \omega^2) - 3EI \left\{ \frac{1}{a-c} + \frac{4(b+c)}{c(4b+3c)} \right\} \right] \\ & - 9(EI)^2 \left\{ \frac{1}{(a-c)^2} - \frac{2(2b+3c)}{c^2(4b+3c)} \right\}^2 = 0. \quad (18) \end{aligned}$$

Omitting k^2 , we obtain an equation for the critical angular velocity which—allowing for a misprint—agrees with Dunkerley's equation A (*l. c.* p. 326). It is worth noticing that the terms independent of k or ω in (18) reduce to

$$36(EI)^2 a^2(a+b) \div \{ c^3(a-c)^3(4b+3c) \}.$$

The quadratic (18) splits into two factors, representing pure transverse and oscillational vibrations, when

$$\begin{aligned} c^2/(a-c)^2 &= (4b+6c)/(4b+3c), \\ &= 1 \text{ when } b/c \text{ is very big (cf. (c) case 2),} \\ &= 2 \text{ when } b/c \text{ is very small (cf. (c) case 4).} \end{aligned}$$

If in (18) we altogether neglect I' we find for the critical velocity

$$\omega^2 = 12EIa^2(a+b) \div [Mc^2(a-c)^2 \{ 4a(b+c) - c^2 \}]. \quad (19)$$

(e) If we assume I' small to begin with, we may replace the displacements in (d) by the simpler type

$$\begin{aligned} \text{in OC, } y &= \eta \left[-2abc(3ac - 2a^2 - c^2)x + 2a^2(a+b)(3cx^2 - x^3) \right. \\ & \quad \left. - c(3ac + 2ab - c^2)(3ax^2 - x^3) \right], \\ \text{in CA, } y &= \eta \left[-2c^3a^2(a+b) + 2ac(c^2b + 3a^2c + 2a^2b)x \right. \\ & \quad \left. - c(3ac + 2ab - c^2)(3ax^2 - x^3) \right], \\ \text{in OB, } y' &= \eta \left[2abc(3ac - 2a^2 - c^2)x' \right. \\ & \quad \left. - (ac/b)(3ac - 2a^2 - c^2)(3bx'^2 - x'^3) \right]. \end{aligned} \quad (20)$$

In the above x is measured from O to A, and x' from O to B.

Replacing η by $(gM/EI)/12a^2(a+b)$, we should have the bending of the shaft due to the weight of M at C.

From Lagrange's equations I find for the frequency equation

$$\begin{aligned} & (k^2 + \omega^2)Mc^2(a-c)^2(4ab + 4ac - c^2)^2 \\ & + (k^2 - \omega^2)I'\{4ab(a-2c) + 3c(2a^2 - 4ac + c^2)\}^2 \\ & = 12EIa^2(a+b)(4ab + 4ac - c^2), \quad \dots \quad (21) \end{aligned}$$

and for the critical velocity

$$\begin{aligned} \omega^2 = & \frac{12EIa^2(a+b)}{Mc^2(a-c)^2(4ab + 4ac - c^2)} \times \\ & \left[1 - \frac{I'\{4ab(a-2c) + 3c(2a^2 - 4ac + c^2)\}^2}{Mc^2(a-c)^2(4ab + 4ac - c^2)^2} \right]^{-1}. \quad (22) \end{aligned}$$

Neglecting I' altogether, we obtain (19).

In the case of two equal spans, or $b=a$, omitting higher powers of I' in (22), we find

$$\begin{aligned} \omega^2 = & \frac{24EIa^3}{Mc^2(a-c)^2(4a^2 + 4ac - c^2)} \times \\ & \left[1 + \frac{I'(4a^3 - 2a^2c - 12ac^2 + 3c^3)^2}{Mc^2(a-c)^2(4a^2 + 4ac - c^2)^2} \right]. \quad \dots \quad (23) \end{aligned}$$

An identical result is deducible—but not so easily—from (18).

§ 30. Load (M, I') on massive shaft.

(f) On Dunkerley's hypothesis the critical velocity is given by

$$1/\omega^2 = 1/\omega_1^2 + 1/\omega_2^2,$$

where ω_1 is given by (3) or (4), and ω_2 by (18) with k omitted.

In the case of equal spans, supposing the effect of I' small, we thus find

$$\begin{aligned} \frac{1}{\omega^2} = & \frac{\sigma pa^4}{97.41EI} + \frac{Mc^2(a-c)^2(4a^2 + 4ac - c^2)}{24EIa^3} \\ & - \frac{I'(4a^3 - 2a^2c - 12ac^2 + 3c^3)^2}{24EIa^3(4a^2 + 4ac - c^2)}. \quad \dots \quad (24) \end{aligned}$$

(g) The best algebraic type of displacement would probably answer to the bending of the shaft under a gravitational force supposed to act on both shaft and load, but oppositely directed on the two spans. I have only worked out results from the simpler type (13), which neglects the influence of the load on the displacement. This leads to the frequency equation

$$(k^2 + \omega^2)R + (k^2 - \omega^2)QI' = S, \quad \dots \quad (25)$$

where

$$\begin{aligned}
 R &= M[(a-c)^4 - 4a^3(a-c) \\
 &\quad - C\{(a-c)^3 - 3a^2(a-c)\} - D(a-c)]^2 \\
 &\quad + \sigma\rho \left[\frac{37}{9}(a^9 + b^9) + \frac{68}{35}(C^2a^7 + C'^2b^7) + \frac{1}{3}D^2(a^3 + b^3) \right. \\
 &\quad \left. - \frac{113}{20}(Ca^8 + C'b^8) + \frac{7}{3}D(a^6 + b^6) - \frac{8}{5}D(Ca^5 + C'b^5) \right], \quad (26) \\
 Q &= [4\{a^3 - (a-c)^3\} - 3\{a^2 - (a-c)^2\}C + D]^2, \\
 S &= \frac{3EI}{5l} \{3l^6 - 10abl^4 - 5a^2b^2l^2 + 20a^3b^3\},
 \end{aligned}$$

the notation being the same as in (c).

Omitting k in (25) we obtain the critical angular velocity. If, for instance, the spans are equal, and I' is negligible, we obtain

$$\omega^2 = \frac{97 \cdot 55 EI}{\sigma\rho a^4} \div \left[1 + \frac{315}{31} \frac{M}{\sigma\rho a} \left\{ \frac{c(a-c)}{a^2} \right\}^2 \left\{ 1 + \frac{c(a-c)}{a^2} \right\}^2 \right] \quad (27)$$

Numerical calculations are here simplified by noticing that the coefficient of M involves c and $a-c$ symmetrically; this implies that the critical velocity is unaltered when the distances of the load from the central and terminal piers are interchanged.

As (27) is based on a displacement which omits the effect of the load, we may expect it to prove less exact the larger the load.

§ 31. Table VI. compares the results calculated by Dunkerley from (18), with k omitted, for the critical number of revolutions per minute in his shaft, supposed massless but carrying one of his pulleys, with corresponding results from the simpler formulæ (19) and (23). The spans are supposed equal.

TABLE VI.

| c/a | 1/16. | | 1/4. | | 1/2. | | 3/4. | | 15/16. | |
|------------------------|-------|-------|------|------|------|------|------|------|--------|-------|
| Pulley ... | I. | II. | I. | II. | I. | II. | I. | II. | I. | II. |
| Dunkerley from (18)... | 31664 | 24173 | 8114 | 4842 | 4987 | 3325 | 6318 | 4288 | 24550 | 18816 |
| „ (19)... | 24760 | 16510 | 7175 | 4784 | 4987 | 3325 | 6284 | 4190 | 19464 | 12978 |
| „ (23)... | 32676 | 27219 | ... | ... | ... | ... | ... | ... | 24976 | 20096 |

When the pulley is close to a support it exerts—*cf.* the analogous case in § 17—an exceedingly small effect on the critical velocity in the practical case of shaft and pulley combined. Except when the pulley is close to a support, we see in Table VI. a close agreement between even the simplest formula (19) and (18). The more complicated formula (23) agrees pretty closely with (18) even for the values 1/16 and 15/16 of c/a ; for the other values the two would be in practical agreement.

§ 32. Table VII. compares the critical number of revolutions actually observed by Dunkerley for the case of equal spans, with those which he calculated from (2) and (18), and the corresponding results from (27), which altogether neglects I' .

TABLE VII.

| c/a | 1/16. | | 1/4. | | 1/2. | | 3/4. | | 15/16. | |
|--------------------|-------|------|------|------|------|------|------|------|--------|------|
| Pulley ... | I. | II. | I. | II. | I. | II. | I. | II. | I. | II. |
| Observed Dunkerley | 4430 | 4524 | 3930 | 3213 | 3420 | 2600 | 3846 | 3056 | 4402 | 4220 |
| from (2)&(18) | 4440 | 4411 | 3925 | 3286 | 3334 | 2671 | 3657 | 3100 | 4411 | 4362 |
| .. (27)... | 4438 | 4381 | 3967 | 3516 | 3604 | 3000 | 3967 | 3516 | 4438 | 4381 |

As theory led us to expect, the agreement of (27) with observation is not so good for the heavier pulley II. as for the lighter.

CASE 6 (Dunkerley's Cases VI. and XIV.).

§ 33. Shaft fixed in direction at both ends.

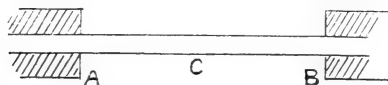

(a) Unloaded shaft: Euler-Bernoulli method (Dunkerley, *l. c.* p. 298).

Measuring x from an end A, and denoting AB by l , we have

$$y = \alpha \{ (\cosh \mu x - \cos \mu x)(\sinh \mu l - \sin \mu l) - (\sinh \mu x - \sin \mu x)(\cosh \mu l - \cos \mu l) \}, \quad \dots \quad (1)$$

where α is a constant, and the value of μ is given by

$$\cosh \mu l \cos \mu l - 1 = 0. \quad \dots \quad (2)$$

The least root of (2) (see Rayleigh's Sound, art. 174) is

$$\mu l = 4.73004, \dots \dots \dots (3)$$

which gives for the critical velocity

$$\omega^2 = 500.6 (EI/\sigma \rho l^4). \dots \dots \dots (4)$$

(b) In the above case of no carried load, an approximate frequency equation is deducible from the simple type

$$y = \eta x^2 (l - x)^2. \dots \dots \dots (5)$$

Replacing η by $g \sigma \rho / 24 EI$ we should have the bending of the shaft under its own weight.

From the kinetic treatment we easily find

$$k^2 + \omega^2 = 504 (EI/\sigma \rho l^4), \dots \dots \dots (6)$$

giving for the critical velocity

$$\omega^2 = 504 (EI/\sigma \rho l^4). \dots \dots \dots (7)$$

The values given by (4) and (7) for ω differ by only about 0.3 per cent.

§ 34. Load (M, I') on massless shaft.

(c) If the load be at C (AC = a, BC = b) we have for Rayleigh type displacements, measuring x from A and x' from B,

$$\left. \begin{aligned} \text{in AC, } y &= (3z - a\theta)(x/a)^2 + (a\theta - 2z)(x/a)^3, \\ \text{in BC, } y' &= (3z + b\theta)(x'/b)^2 - (b\theta + 2z)(x'/b)^3 \end{aligned} \right\} \dots \dots (8)$$

Applying Lagrange's equations we have

$$\left\{ M(k^2 + \omega^2) - 12EI(a^{-3} + b^{-3}) \right\} \left\{ I'(k^2 - \omega^2) - 4EI(a^{-1} + b^{-1}) \right\} = 36(EI)^2(b^{-2} - a^{-2})^2 \dots \dots \dots (9)$$

Omitting k^2 , we obtain for the critical velocity a result agreeing with Dunkerley's (*l. c.* p. 337).

(9) splits into factors, representing pure transverse and oscillational vibrations, when $b = a$. In this case we have for the respective frequencies (*cf.* (11) of §26, and (13) and (14) of §42)

$$\left. \begin{aligned} k^2 &= -\omega^2 + 192EI/Ml^3, \\ k^2 &= \omega^2 + 16EI/I'l. \end{aligned} \right\} \dots \dots \dots (10)$$

If we omit I' altogether in (9) we obtain for the critical velocity

$$\omega^2 = 3EI^3/Ma^3b^3. \dots \dots \dots (11)$$

As a second approximation, when I' is small, we have

$$\omega^2 = (3EI^3/Ma^3b^3) \{ 1 + 9I'(a-b)^2/4Ma^2b^2 \}. \dots (12)$$

(d) If we can assume I' small to begin with, we may replace (8) by

$$\left. \begin{array}{l} \text{in AC, } y = \eta \{ ab^2(a+b)x^2 - \frac{1}{3}b^2(3a+b)x^3 \}, \\ \text{in BC, } y' = \eta \{ a^2b(a+b)x'^2 - \frac{1}{3}a^2(a+3b)x'^3 \} \end{array} \right\} \quad (13)$$

Applying Lagrange's equations we find

$$(k^2 + \omega^2) \frac{4}{3} Ma^3b^3 + (k^2 - \omega^2) I' ab(a-b)^2 = \frac{4}{3} EI(a+b)^3. \quad (14)$$

For the critical angular velocity, writing l for $a+b$, we have

$$\omega^2 = (3EI l^3 / Ma^3b^3) \{ 1 - 9I'(a-b)^2 / 4Ma^2b^2 \}^{-1} \quad (15)$$

Neglecting I' this agrees with (11), neglecting $(I')^2$ with (12).

§ 35. (c) Load (M, I') on massive shaft.

On Dunkerley's hypothesis we have

$$1/\omega^2 = 1/\omega_1^2 + 1/\omega_2^2,$$

where ω_1 is given by (4) and ω_2 by (9) with k omitted.

When I' is small we thus obtain

$$\frac{1}{\omega^2} = \frac{\sigma \rho l^4}{500 \cdot 6 EI} + \frac{Ma^3b^3}{3EI l^3} - \frac{3 I' ab(a-b)^2}{4 EI l^3} \quad (16)$$

I have not worked out a frequency equation based on an assumed type of displacement, but it would present no difficulty. The displacements would combine terms of the types (5) and (13) according to the relative masses of the shaft and load.

GENERAL CONCLUSIONS.

§ 36. In every case here treated when the effect of the moment of inertia of the load has been small—as was true invariably in Dunkerley's experiments, and probably often is in practice—the frequency equation has proved to be of the type

$$k^2 = K^2 - v\omega^2, \quad \dots \dots \dots (1)$$

where $K/2\pi$ is the frequency of the fundamental transverse vibration of the system when not rotating. There would thus seem grounds for supposing that a formula of type (1) will often prove a close approximation to the truth. When this is the case, we can arrive at a close approximation to the velocity answering to whirling without endangering the shaft by actually pushing the velocity to this point. All that is necessary is to determine the frequency of the lowest natural transverse vibration in the shaft when not rotating, and when rotating with any convenient velocity ω_1 .

If these frequencies be $K/2\pi$ and $k_1/2\pi$ respectively, then

it is easily found from (1) that the frequency answering to any arbitrary value of ω is given by

$$k^2 = K^2 - (K^2 - k_1^2)\omega^2/\omega_1^2. \quad \dots \quad (2)$$

Thus the critical angular velocity, Ω say, being that for which k vanishes, is given by

$$\Omega^2 = \omega_1^2 K^2 / (K^2 - k_1^2) \quad \dots \quad (3)$$

As a check on the applicability of (2), it would in general be advisable to determine the frequency $k_2/2\pi$ answering to a second angular velocity ω_2 . If (2) is strictly true, we should obviously have

$$(K^2 - k_2^2)/\omega_2^2 = (K^2 - k_1^2)/\omega_1^2, \quad \dots \quad (4)$$

the quantity on either side of the equation being a value for K^2/Ω^2 .

In all the cases solved, the quantity ν in (1) has approached unity as a limiting value when the moment of inertia of the load has been indefinitely diminished; *i. e.* the angular velocity answering to whirling has approached the limiting value $2\pi n$, where n is the number of transverse vibrations of the fundamental type executed by the system when not rotating in unit of time.

The feasibility of determining frequencies of vibration in actual shaft systems, or models, is a question which I must leave to those experienced in Acoustics and practical Engineering.

§ 37. When a shaft is carried on more than two supports, it is not easy to lay down a suitable basis for the comparison of the critical velocities answering to different terminal conditions. A comparison is, however, easily instituted in Cases 1, 2, 4, and 6, when the shaft is unloaded. In all four cases, suppose the total length l , the mass $m (\equiv \sigma \rho l)$, the stiffness EI , and let ω be the critical angular velocity, $N (= 30\omega/\pi)$ the corresponding number of revolutions per minute. Then we have the results given in Table VIII.

TABLE VIII.

| Case. | State of ends. | Value of $\omega^2 \div (EI/ml^3)$. | Value of $N \div (EI/ml^3)^{\frac{1}{2}}$. |
|-------|--|--------------------------------------|---|
| 1. | One fixed in direction, other free. | 12.36 | 33.58 |
| 2. | Both supported | 97.41 | 94.25 |
| 4. | One fixed in direction, other supported... | 237.7 | 147.2 |
| 6. | Both fixed in direction | 500.6 | 213.7 |

The smaller ω , or N, the more easily is the shaft caused to whirl. Table VIII. thus serves to bring out the great reduction in the tendency to whirl caused by fixing the direction at the ends of the shaft.

§ 38. A comparison is also readily made for a loaded but massless shaft under the conditions of cases 1, 2, 4, and 6, when the moment I' of the load is negligible. This is done in Table IX. The load M is supposed at the end in case 1; in the other cases its distances from the ends A and B are a and b . The so-called "minimum values" of ω^2 and N answer to that position of M which gives the smallest critical velocity. The rest of the notation has the same significance as in Table VIII.

TABLE IX.

| Case. | End A. | End B. | General value of $\omega^2 \div (EI/Ml^3)$. | Value of b/a giving minimum value of ω . | Minimum Values of | |
|--------|------------------|------------------|--|---|-----------------------------|----------------------------------|
| | | | | | $\omega^2 \div (EI/Ml^3)$. | $N \div (EI/Ml^3)^{\frac{1}{2}}$ |
| 1. ... | Direction fixed. | Free. | 3 | | 3 | 16.54 |
| 2. ... | Supported. | Supported. | $3l^4/a^2b^2$ | 1 | 48 | 66.16 |
| 4. ... | Direction fixed. | Supported. | $12 \frac{l^6}{a^3b^2(3a+4b)}$ | $(1/2)^{\frac{1}{2}}$ | 101.9 | 96.4 |
| 6. ... | Direction fixed. | Direction fixed. | $3l^6/a^3b^3$ | 1 | 192.0 | 132.3 |

In cases 2, 4, and 6, the position of the load which supplies the minimum value is precisely that for which Dunkerley's equations and mine agree in making the effect of I' vanish. Again, in every case where I have treated I' as small, the corrective term in I' has increased ω . There are thus reasons for regarding the above minimum values of N as pretty safe measures of the lowest speed at which whirling is likely to arise when a load is attached anywhere to a shaft of much smaller mass.

If we compare the results for ω^2 or N in Table VIII. with the corresponding minimum values in Table IX., we obtain the following as the ratios of m to M for which the critical velocities in the two cases are equal:—

| | | | | |
|-----------------|------|------|------|------|
| Case | 1. | 2. | 4. | 6. |
| m/M | 4.12 | 2.03 | 2.33 | 2.61 |

It follows that when a load is near its most effective position, it must be taken into account as well as the shaft if we aim at a close approximation to the critical velocity.

The general values of ω^2 , however, in Table IX. show how very rapidly the tendency in M to produce whirling falls off as its position approaches a support, especially when the support is such as to fix the direction of the shaft.

§ 39. In considering liability to whirl, we must not lose sight of the possibility of the elastic strains and stresses exceeding the limit of safety before whirling is reached. As an example, let us suppose the shafts circular (solid, or hollow), of external radius a and perimeter p ($p \equiv 2\pi a$), of a material for which

$$\begin{aligned} E &= 20 \times 10^8 \text{ grammes weight per sq. cm. (1270 tons per} \\ \eta &= 1/4, \text{ sq. inch),} \\ \rho &= 7.8 \text{ times the density of water.} \end{aligned}$$

Suppose the shafts unloaded, and denote the maximum stress-difference answering to the critical angular velocity of whirling by \bar{S} , then the following results may be proved:—

TABLE X.

| | Solid Shaft, both ends | | Very thin-walled hollow Shaft, both ends | |
|--------------------------------------|---|---------------|--|----------------|
| | Supported. | Fixed. | Supported. | Fixed. |
| \bar{S} (in tons per sq. inch) ... | $6.61(p/l)^4$ | $34.0(p/l)^4$ | $39.7(p/l)^4$ | $204.0(p/l)^4$ |
| $\bar{S}=2$ tons | $\left\{ \begin{array}{l} l/p= \\ l/a= \end{array} \right.$ | | | |
| | 1.35 | 2.03 | 2.11 | 3.18 |
| | 8.5 | 12.8 | 13.3 | 20.0 |

The value of \bar{S} for the very thin-walled shaft is really 6 times that for the solid shaft, for the assumed value 1/4 of Poisson's ratio. Since the maximum stress-difference answering to the critical velocity varies as the fourth power of the ratio borne by the perimeter (or radius) of the shaft to its length, it increases with great rapidity as the length is reduced, the section remaining unaltered. The physical properties assumed answer fairly to steel; but the results, it may be remarked, depend only on the elasticity, not on the density of the material. Under statical conditions, a stress-difference of 2 tons on the square inch is but a trifle compared to what good steel will stand; but in a rotating shaft, where there are ordinarily rapid alternations of stresses from various sources, it is probably at least as large a contribution from "centrifugal forces" as a cautious engineer will care to see.

When the ratio of the length to the circumference, or

radius, is less than the values recorded in the two last lines of Table X., the stress-difference will exceed 2 tons on the square inch before the shaft whirls.

MATHEMATICAL APPENDIX.

§ 40. The kinetic energy of a body rotating about an axis through its C.G. is given by

$$T_r = \frac{1}{2}(I_1\omega_1^2 + I_2\omega_2^2 + I_3\omega_3^2),$$

where I_1, I_2, I_3 are the principal moments of inertia, and $\omega_1, \omega_2, \omega_3$ the component angular velocities about the three principal axes. Supposing the body one of revolution, and that it rotates with angular velocity ω about a fixed direction with which its axis of figure makes a small angle θ , then

$$\omega_1 = \omega \cos \theta, \quad \omega_2 = \omega \sin \theta, \quad \omega_3 = \dot{\theta},$$

and

$$T_r = \frac{1}{2}\{\omega^2 I_1 - (I_1 - I_2)\omega^2 \sin^2 \theta + I_2 \dot{\theta}^2\}. \quad . \quad . \quad (1)$$

If the body be a flat disk $I_1 = 2I_2$; and if θ be very small $\sin \theta$ may be replaced by θ , thus leading to

$$T_r = \frac{1}{2}\omega^2 I_1 + \frac{1}{2}I_2(\dot{\theta}^2 - \omega^2 \theta^2). \quad . \quad . \quad . \quad (2)$$

This result is applicable to a plate-shaped pulley carried on a rotating shaft, at a place where the tangent to the axis of the shaft is inclined at an angle θ to its undisturbed position. It is of course additional to the energy of the mass supposed collected at its centre of gravity. Unless the thickness of the pulley is small, variations of θ throughout it may not be negligible; and unless it closely resembles a cylinder of revolution, it may be necessary to allow for I_1 not being double I_2 .

In the text, and subsequently in the Appendix, I' is used for I_2 .

§ 41. For illustrative purposes I shall take the case of a massless shaft of length l , supported at its two ends A and B ($AB=l$), carrying a load of mass M , and inertia I' , at an intermediate point C ($AC=a, BC=b$).

For AC we measure x from A, and for BC we measure x' from B. At any time t suppose C to be at a distance z from AB, in the xy plane, and let the tangent at C to the axis of the shaft make an angle θ with AB. Then we must have

$$\left. \begin{aligned} \text{At } x=0, & \quad y = d^2 y / dx^2 = 0, \\ x=a, & \quad y = z, \quad dy/dx = \theta. \\ x'=0, & \quad y' = d^2 y' / dx'^2 = 0, \\ x'=b, & \quad y' = z, \quad dy'/dx' = -\theta. \end{aligned} \right\} . \quad . \quad (3)$$

These conditions are easily seen to be satisfied by

$$\left. \begin{aligned} y &= (3z - a\theta)(x/2a) + (a\theta - z)(x^3/2a^3), \\ y' &= (3z + b\theta)(x'/2b) - (b\theta + z)(x'^3/2b^3), \end{aligned} \right\} \dots (4)$$

when we treat z and θ as constants. Under the same assumption these expressions satisfy

$$d^4y/dx^4 = 0, \quad d^4y'/dx'^4 = 0,$$

equations answering to the absence of external forces on the shaft itself.

The components of velocity at the C.G. C of the load are z perpendicular to AB in the plane of bending, and ωz perpendicular to the plane of bending. Thus, treating θ as small, we have for the kinetic energy of the system

$$T = \frac{1}{2}M(\dot{z}^2 + \omega^2 z^2) + \frac{1}{2}I_1\omega^2 + \frac{1}{2}I'(\dot{\theta}^2 - \omega^2\theta^2). \dots (5)$$

The shaft being supposed massless, contributes nothing to T. It is, however, the seat of the potential energy, V, which is given on the ordinary Euler-Bernoulli theory by

$$V = \frac{1}{2}EI \left\{ \int_0^a (d^2y/dx^2)^2 dx + \int_0^b (d^2y'/dx'^2)^2 dx' \right\} \dots (6)$$

Substituting the values of d^2y/dx^2 and d^2y'/dx'^2 from (4), and carrying out the integrations, we easily find

$$V = \frac{1}{2}EI \{ 3(a\theta - z)^2/a^3 + 3(b\theta + z)^2/b^3 \}. \dots (7)$$

Employing these values of T and V in the two Lagrangian equations

$$\frac{d}{dt} \left(\frac{dT}{dz} \right) - \frac{dT}{dz} + \frac{dV}{dz} = 0, \dots (8)$$

$$\frac{d}{dt} \left(\frac{dT}{d\dot{\theta}} \right) - \frac{dT}{d\theta} + \frac{dV}{d\theta} = 0, \dots (9)$$

we have

$$M(\ddot{z} - \omega^2 z) + 3EIz(a^{-3} + b^{-3}) + 3EI\theta(b^{-2} - a^{-2}) = 0, \dots (10)$$

$$I'(\ddot{\theta} + \omega^2 \theta) + 3EIz(b^{-2} - a^{-2}) + 3EI\theta(b^{-1} + a^{-1}) = 0. \dots (11)$$

For a vibration of frequency $k/2\pi$ we have

$$\ddot{z} = -k^2 z, \quad \ddot{\theta} = -k^2 \theta.$$

Substituting for \ddot{z} and $\ddot{\theta}$ in (10) and (11), and eliminating z and θ between these two equations, we have, as in (8) of § 13,

$$\begin{aligned} \{ M(k^2 + \omega^2) - 3EI(a^{-3} + b^{-3}) \} \{ I'(k^2 - \omega^2) - 3EI(a^{-1} + b^{-1}) \} \\ = 9(EI)^2(b^{-2} - a^{-2})^2 \dots (12) \end{aligned}$$

The term $\frac{1}{2}I_1\omega^2$ contributes nothing to Lagrange's equations and is for this reason omitted in the text.

Assigning any arbitrary value to ω , we obtain two values of k^2 —one of which may be imaginary—answering to two different types of vibration.

§ 42. In general each of the equations (10) and (11) contains both z and θ , and each root of k^2 given by (12) depends on both M and I' . There is obviously, however, a complete separation of the transverse and oscillatory movements when the load is at the centre of the span. For putting $b=a$, we have z only in (10) and θ only in (11); while the right-hand side of (12) vanishes, and we have for the transverse vibration

$$k_1^2 = 48(EI/MI^3) - \omega^2, \dots \dots \dots (13)$$

for the oscillatory vibration

$$k_2^2 = 12(EI/I'l) + \omega^2. \dots \dots \dots (14)$$

Answering to $\omega = 0$ we have

$$\begin{aligned} k_2^2/k_1^2 &= MI^2/4I'l, \\ &= l^2/r^2, \end{aligned}$$

if the load be a thin circular disk of radius r .

Thus even when $\omega = 0$, k_2 will exceed k_1 unless the radius of the disk be equal to the span.

As ω increases, k_2 increases while k_1 diminishes; thus under ordinary circumstances the frequency of the transverse vibration is much the less of the two.

In the above special case it is obvious that k_2 cannot vanish, and that it is only the transverse vibration in connexion with which instability can arise. The critical angular velocity, answering to k_1 becoming nil, is given by

$$\omega^2 = 48(EI/MI^3). \dots \dots \dots (15)$$

Even in the general case it is easily shown that one only of the two values of k^2 supplied by (12) can possibly vanish. For assuming k zero, we find the equation to reduce to

$$\begin{aligned} \omega^4 MI' + \omega^2 \cdot 3EI \{ M(a^{-1} + b^{-1}) - I'(a^{-3} + b^{-3}) \} \\ - 9(EI)^2(a+b)^2/a^3b^3 = 0, \end{aligned} \quad (16)$$

a quadratic in ω^2 whose roots are of opposite sign. As a negative value of ω^2 supplies an imaginary value of ω , there is only one real value of ω for which k can vanish. And as (12), regarded as an equation in k^2 , cannot have equal roots, unless $b=a$, only one of the two values of k^2 can be made to vanish.

§ 43. When there is no load, and an algebraic type of vibration is assumed, the application of the Lagrangian equations is even simpler. Taking, for example, the case of a shaft supported at both ends, we have for the displacement (*cf.* (b) case 2)

$$y = \eta x (l^3 - 2lx^2 + x^3), \dots \dots \dots (17)$$

whence

$$\begin{aligned} T &= \frac{1}{2} \sigma \rho \int_0^l (\dot{y}^2 + \omega^2 y^2) dx = \frac{1}{2} \sigma \rho (\dot{\eta}^2 + \omega^2 \eta^2) \int_0^l x^2 (l^3 - 2lx^2 + x^3)^2 dx \\ &= \frac{1}{2} (\dot{\eta}^2 + \omega^2 \eta^2) (31/630) \sigma \rho l^9, \dots \dots (18) \end{aligned}$$

$$\begin{aligned} V &= \frac{1}{2} EI \int_0^l (d^2y/dx^2)^2 dx = \frac{1}{2} EI \eta^2 \int_0^l 144 x^2 (x-l)^2 dx \\ &= \frac{1}{2} \eta^2 (24/5) EI l^5. \dots \dots \dots (19) \end{aligned}$$

Lagrange's equation

$$\frac{d}{dt} \frac{dT}{d\dot{\eta}} - \frac{dT}{d\eta} + \frac{dV}{d\eta} = 0$$

gives

$$(\ddot{\eta} - \omega^2 \eta) (31/630) \sigma \rho l^9 + (24/5) \eta EI l^5 = 0.$$

Assuming $\eta \propto \cos kt$, and so $\ddot{\eta}/\eta = -k^2$, we have (*cf.* (6), § 12)

$$k^2 + \omega^2 = \frac{24 \times 126}{31} \frac{EI}{\sigma \rho l^4} = \frac{3024}{31} (EI/\sigma \rho l^4). \dots (20)$$

§ 44. Under certain circumstances an equation of type (1), § 1, may be shown to be true for vibration frequencies. The ordinary differential equation for a frictionless simple harmonic motion is

$$M d^2x/dt^2 + Fx = 0, \dots \dots \dots (21)$$

where M is a quantity of the nature of a mass, and F a force of restitution, such as is exerted by a spring. The frequency $k/2\pi$ of the corresponding vibration is given by

$$1/k^2 = M/F. \dots \dots \dots (22)$$

Suppose, now, that the force of restitution remains the same whether we apply one or a series of loads, $M_1, M_2, \&c.$ When the loads are put on one at a time, the corresponding frequency equations are

$$1/k_1^2 = M_1/F, \quad 1/k_2^2 = M_2/F; \dots \dots (23)$$

when put on all together we have for the frequency equation

$$\begin{aligned} 1/k^2 &= (M_1 + M_2 + \dots)/F \\ &= 1/k_1^2 + 1/k_2^2 + \dots \dots \dots (24) \end{aligned}$$

This is analogous of course to Dunkerley's hypothesis, but it is far from amounting to a proof. Even if we assumed that what is true of transverse vibration frequencies is true of whirling velocities, we should have to prove that the addition of pulleys at different parts of a shaft is equivalent to varying the load without affecting the forces of restitution.

§ 45. The following investigation would seem to show that the result is not in general strictly true, though it may be, and not improbably often is, a close approximation to the truth.

Suppose that a massless shaft of length l , supported at its ends A and B, carries a mass M_1 at C ($AC=a$), and a second mass M_2 at D ($CD=c$, $BD=b$), the effect of the moment of inertia being negligible in either case.

Measuring x from A, and x' from B, we may assume the following types of displacement—derived by considering the bending of the shaft under the weight of the two loads:—

$$\left. \begin{aligned}
 \text{from A to C. } y &= \eta [M_1(b+c)x\{l^2 - (b+c)^2 - x^2\} \\
 &\quad + M_2bx(l^2 - b^2 - x^2)], \\
 \text{.. C to D. } y &= \eta [M_1ax'(l^2 - a^2 - x'^2) \\
 &\quad + M_2bx(l^2 - b^2 - x^2)], \\
 \text{.. D to B. } y &= \eta [M_1ax'(l^2 - a^2 - x'^2) \\
 &\quad + M_2(a+c)x'\{l^2 - (a+c)^2 - x'^2\}].
 \end{aligned} \right\} \dots (25)$$

Taking ω as usual for the angular velocity, and applying Lagrange's equations, we find after algebraic manipulation

$$1/(k^2 + \omega^2) = M_1\{a^2(b+c)^2/3EI\} + M_2\{b^2(a+c)^2/3EI\} - R, \quad (26)$$

where

$$\begin{aligned}
 R &= M_1M_2(M_1 + M_2)a^2b^2c^2(4ab + 4ac + 4bc + 3c^2) \\
 &\quad \div 12EI\{M_1^2a^2(b+c)^2 + M_2^2b^2(a+c)^2 \\
 &\quad + M_1M_2ab(2ab + 2ac + 2bc + c^2)\}. \quad (27)
 \end{aligned}$$

For the critical angular velocity answering to whirling we put $k=0$, and find

$$1/\omega^2 = 1/\omega_1^2 + 1/\omega_2^2 - R, \quad (28)$$

where

$$\omega_1^2 = 3EI \div M_1a^2(b+c)^2, \quad \omega_2^2 = 3EI \div M_2b^2(a+c)^2.$$

Referring to (9) or (10) §13, we see that ω_1 and ω_2 are the critical velocities for the shaft when loaded with the mass M_1 and when loaded with the mass M_2 .

In order that (28) should agree with Dunkerley's hypothesis R should vanish. It is, however, obvious that R is positive for all values of M_2/M_1 , and for all values of $a, b,$

and c . It vanishes, it is true, when c vanishes, but the two loads then coincide in position. As R is positive, the application of Dunkerley's hypothesis gives a larger value for $1/\omega^2$, and so a smaller value for ω^2 , than does (28).

This does not entirely disprove Dunkerley's hypothesis, because we are not entitled to assume that (25) accords absolutely with the true type of displacement, and we know from Rayleigh's general theorem that, unless this is the case, the value given by (26) for k^2 must be somewhat in excess, and consequently the value (28) for $1/\omega^2$ somewhat too low. We may however expect, in accordance with Rayleigh's general reasoning, that (26) is a very close approach to the truth; and whilst R is usually much smaller than $1/\omega_1^2 + 1/\omega_2^2$, it is by no means negligible, unless one of the loads be much less than the other, or one of the three lengths, a , b , and c be small.

Considering, however, the various sources of uncertainty, it must be allowed that in the present instance Dunkerley's hypothesis gives at least a fair first approximation. Taking, for example, the fairly representative case presented when the two loads are equal, and a , b , c all equal, we find

$$1/\omega^2 = (15/16)(1/\omega_1^2 + 1/\omega_2^2).$$

§ 46. In carrying out investigations in cases where there are two, three, or more loads, the physical significance of the processes is more easily seen by adopting a generalized notation. In the above case, for instance, it will be found that the displacements at the points where the loads occur are really of the types

$$\eta'(M_1 y_{11} + M_2 y_{12}) \text{ and } \eta'(M_1 y_{12} + M_2 y_{22}),$$

where y_{11} and y_{12} are the displacements at the point where M_1 occurs, due respectively to unit loads at this point and at the point where M_2 occurs. (By a well-known general theorem y_{12} and y_{21} are equal.) The kinetic and the potential energies vary respectively as

$$M_1(M_1 y_{11} + M_2 y_{12})^2 + M_2(M_1 y_{12} + M_2 y_{22})^2 \text{ and} \\ (M_1^2 y_{11}^2 + 2M_1 M_2 y_{12} + M_2^2 y_{22}^2),$$

and the function which appears in the expression for $1/\omega^2$ really varies as

$$M_1 y_{11} + M_2 y_{22} - \\ (y_{11} y_{22} - y_{12}^2) M_1 M_2 (M_1 + M_2) \div \{M_1^2 y_{11}^2 + 2M_1 M_2 y_{12} + M_2^2 y_{22}^2\}.$$

The sign of R in (26) and (28) really turns on the sign of $(y_{11} y_{22} - y_{12}^2)$.

LXI. *Energy of Secondary Röntgen Radiation.* By CHARLES G. BARKLA, M.Sc. (Vict.), B.A. (Cantab.), King's College, Cambridge; Oliver Lodge Fellow, University of Liverpool*.

IN a paper on "Secondary Radiation from Gases subject to X-rays" † experiments were described which led to the following conclusions:—

All gases subject to X-rays are a source of secondary radiation, the nature of which is similar to that of the primary radiation. The absorbability of the secondary radiation is (within the limits of possible error—about 10 per cent. of the absorption coefficient for aluminium) the same as that of the primary radiation producing it.

For a given primary radiation the intensity of secondary radiation from different gases at the same pressure and temperature is proportional to the density of the gas from which it proceeds.

The opinion was expressed that the secondary radiation is due to a kind of scattering of the primary by the corpuscles constituting the molecules of the gas.

Results similar to those which led Sagnac‡ to conclude that the secondary radiation from air was more absorbable than the primary radiation producing it had been obtained, but the evidence was then considered insufficient to lead to a definite conclusion as to the difference in character of the two radiations. A direct method of comparison did not indicate the slightest difference in the absorption of the primary and secondary radiations by similar plates of aluminium.

As the experiments of Townsend§ and Sagnac|| on secondary radiation from metals showed that this radiation was more absorbable than the primary radiation producing it—the change in penetrating power, however, depending on the metal—and as the results referred to led to the probability of a transformation of the radiation by air, further and more careful experiments were made on the subject.

The following method was employed:—

A beam of X-rays passed through rectangular apertures in two parallel lead screens A and B (see figure). Two screens, C and D, were placed in planes perpendicular to the others,

* Communicated by the Physical Society: read March 25, 1904.

† C. G. Barkla, *Phil. Mag.* [6] v. p. 685 (1903).

‡ *Comptes Rendus*, cxxvi. pp. 521–523 (1898).

§ *Proc. Camb. Phil. Soc.* x. p. 217 (1899).

|| *Comptes Rendus*, cxxv. p. 942 (1897).

plate suffered absorption which would be produced by going normally through a plate of thickness $t(1.106)$, t being the actual thickness of the plate.

The average effective thickness of the plate was not more than $1.03t$. To compare the absorbability of the secondary rays with that of the primary, the ratio of the deflexions of the two electroscopes, consequent upon the ionizations produced in these electroscopes by the primary and secondary radiations, was first obtained. From the observation of the deflexion of one of these, the deflexion of the other could then be calculated to within about 3 per cent.

Plates of aluminium of equal thickness were then placed before the electroscopes, so that both the primary and secondary beams suffered absorption by transmission through aluminium. The ratio between the two deflexions consequent upon the passage of the primary and secondary beams through the electroscopes was again determined. In measuring the deflexions, corrections were always made for the result of the normal ionization taking place in the electroscopes. Many experiments were made with rays differing in penetrative power. In some of these the possible error was very small, and they showed that within 4 or 5 per cent. the absorption coefficients for the primary and secondary radiations were the same. Some of the results are given in Table I. (p. 546).

In the second, third, and fourth sets of experiments given in the table, the order of magnitude of the absorption may be seen from a comparison of the duration of experiment and deflexion of the primary electroscope in each case.

A sheet of aluminium of $.04$ cm. thickness reduced the rate of ionization in the electroscope by about 60 per cent.

In the first set the intensity of radiation was altered in the different experiments, so that the duration of experiments was varied little. The ionization in an electroscope was diminished by about 40 per cent. by a sheet of aluminium of $.02$ cm. thickness.

From the results given in the fifth column, it will be seen that in each case the rate of ionization in the secondary electroscope was diminished by the aluminium plate slightly more than that in the primary electroscope. But the effective thickness of the plate before the secondary electroscope was probably between 2 and 3 per cent. greater than that before the primary, so that the actual difference in the absorptions must have been exceedingly small if any difference existed.

Corrections have been made for the normal ionization in each electroscope.

TABLE I.

| Conditions of Exp. | Duration of Exp. | Deflexion of Primary Electroscop. | Deflexion of Secondary Electroscop. | Ratio of Secondary Deflexion to Primary Deflexion. |
|--|------------------|-----------------------------------|-------------------------------------|--|
| Without absorbing plates | minutes. 24 | 31.05 | 10.6 | 34.1 to 100 |
| 2 sheets of .01 cm. Al before each electroscop. | 28 | 31 | 10.45 | 33.7 to 100 |
| Without absorbing plates | 26 | 30.4 | 10.5 | 34.5 to 100 |
| Without absorbing plates | 21 | 34.75 | 10.3 | 29.6 to 100 |
| Sheet of .04 cm. Al before each electroscop. | 50 | 30.4 | 8.15 | 26.8 to 100 |
| Without absorbing plates | 30 | 34.6 | 9.7 | 28 to 100 |
| Without absorbing plates | 25 | 29.05 | 11.3 | 38.9 to 100 |
| Sheet of .04 cm. Al before each electroscop. | 40 | 19.5 | 7.5 | 38.4 to 100 |
| Without absorbing plates | 30 | 23.75 | 9.5 | 40 to 100 |
| Without absorbing plates | 25 | 26.7 | 11.6 | 43.4 to 100 |
| Sheet of .04 cm. Al before each electroscop. | 46 | 20.1 | 8.45 | 42.4 to 100 |
| Without absorbing plates | 20 | 21.2 | 9.2 | 43.4 to 100 |

In order to test this equality in penetrative power for rays differing enormously in character from those previously dealt with, experiments were made with secondary radiation from metals to get a secondary beam of sufficient intensity to use as a primary in experiments similar to those described. The radiation from copper was found to be sufficiently intense to use as a primary beam, as its great ionizing power in some degree compensated for the weakness of the radiation. It was, however, impossible to adopt the method employed with the more intense primary beams, as the ionization produced by what was in this case a tertiary radiation in electroscop M, in the position shown in the figure, was only a small fraction of the normal ionization when the electroscop was not in the path of any known radiation. Instead of placing the electroscop M so far away from the primary beam in

order to get the rays normal to the absorbing plate, and so greatly diminishing the energy of secondary radiation entering the electroscope, it was put immediately behind the aperture in screen C. The effective thickness of the absorbing plate was then much greater than before, as most of the radiation passed through it in a direction making a considerable angle with the normal. Before any accurate results could be obtained of the absorption of this secondary radiation, it was necessary to determine the effective thickness of the plate.

First using a primary beam consisting of rays of moderate penetrative power, such as had been experimented upon previously, it was possible, by comparing the rates of ionization in electroscope M when no absorbing plates were used, when an aluminium plate was placed in the primary beam by aperture P, and when the same plate was placed in front of the electroscope, to calculate, on the assumption that the beam was homogeneous in character, the effective thickness of a plate placed before the secondary electroscope. By using thin plates, the error due to the primary beam being a mixture of radiations differing in character was reduced to a minimum.

To obtain the very absorbable primary beam a copper plate was placed in the induction-coil box opposite the aperture, with the X-ray bulb as close as possible without emitting any direct radiation through the aperture Q. The secondary radiation from copper then constituted the new primary beam, and the tertiary radiation from air was the new secondary radiation. The boundaries of this primary beam were approximately the same as before, so that, neglecting the small error due to want of homogeneity, the effective thickness was as before. From the diminution in the rate of ionization in M when an absorbing plate was put at P, the corresponding diminution when the plate was placed at R was calculated on the assumption that the secondary and primary radiations again had the same penetrative power. This was then compared with the actual absorption produced by the plate at R.

As this test would only hold with accuracy provided the primary and secondary beams consisted of rays of one character, the thickness of the absorbing plate at P which produced the same absorption as a plate of given thickness at R was determined experimentally for the moderately penetrating rays, and the same comparisons were made as before.

This method was still open to the objection that the effective thickness of the plate at R determined experimentally for rays coming direct from an X-ray bulb was not the same as

that for a primary beam coming from a copper plate, for the radiation from metals is more heterogeneous than the primary radiation producing it. The two methods, however, would give different results if want of homogeneity affected them to an appreciable extent.

Both experiments gave within the limits of possible error the same absorption for the secondary as for the primary, showing that even for these very easily absorbed rays, the character of the secondary radiation differs little from that of the primary producing it.

The possible error was in this case naturally much greater than in the previous experiments, and amounted to fully 15 per cent. of the absorption coefficient.

Comparisons were then made between the rates of ionization produced in the two electroscopes when neither primary nor secondary beam was intercepted by absorbing plates, when similar aluminium plates were placed in the primary and secondary beams just before the electroscopes, and when an aluminium plate was placed in the primary beam at the aperture P. As stated previously, the same ratio was given (1) when no plate intercepted either beam as (2) when plates of equal thickness were placed before each electroscope. (3) When a plate was placed in the primary beam at P, the ratio of the rates of ionization in the two electroscopes secondary to primary was increased.

In these experiments the ratio was increased by about 10 per cent. when an aluminium plate .04 cm. thick was placed at P. This plate reduced the ionization in the primary electroscope to about 36 per cent. of its initial value, while the ionization produced by the transmitted radiation was reduced to about 54 per cent. by a second similar plate.

Experiments (1) and (3) showed that the rays which got through the aluminium produced a greater proportional secondary effect than the whole direct primary beam. This result must have been due either to a change in the intensity or in the character of the primary beam in its passage through aluminium. There was a possibility that the intensity of secondary radiation was not proportional to that of the primary radiation, even though the radiations were of the same character; and thus that the diminished intensity accounted for the proportional increase in the ratio of secondary to primary ionization. A given bulb was therefore worked in very different ways, currents of various strengths being passed through, so that in some cases the intensity of radiation was four or five times that in others. The differences in penetrative powers in the different experiments were small.

It was found that the ratio of the rates of ionization was practically the same in each case, showing it to be independent of the intensity of primary radiation.

The increase in the ratio of secondary to primary ionization by placing an absorbing plate at P was therefore due to the change in the character of the primary radiation by transmission through the plate. But it was shown to be independent of the position of the plate in the primary beam, as the ratio was unaltered when the plate was moved from P to Q. Hence the effect of secondary radiation from aluminium was negligible.

The conclusion was then that the rays of higher penetrating power produced a greater secondary ionization in proportion to the primary ionization produced by them than the more absorbable rays. This, again, could not have been due simply to scattering of these constituents in different proportions, for the results of experiments (2) and (3) would then have been identical. We thus arrive at the conclusion that there must have been a greater transformation* of the penetrating than of the more absorbable rays, the increase in ionizing power accounting for the proportional increase in the secondary ionization.

It should be noticed that experiments (2) and (3) do not in any way give a comparison of the absorption of the primary and secondary beams. If the primary beam were homogeneous in character, *i. e.* consisted of rays of one penetrating power, then the ratio of the secondary ionizations in the two cases would be the ratio of the fractions of primary and secondary radiations transmitted by a plate of the thickness used. Such a test would, however, be no more delicate than that given by experiments (1) and (2). If the different constituents of the primary beam were transformed equally, then again this test would be no more delicate than that given by (1) and (2).

The result depends merely on the difference in the transformation of the penetrating and of the more absorbable rays.

If the absorption by aluminium of different radiations were proportional to the ionization produced by these radiations in a given volume of air, then the absorption by aluminium would have been easily measured.

We thus conclude that for the rays experimented upon a

* The measure of transformation used is the ratio of the ionization produced in a given volume of air by the transformed beam to that produced by the primary beam if of the same intensity. This is not the ratio of the absorption coefficients for the rays by air, as the total absorption is not proportional to the ionization, but it is the ratio of what may be called the ionizing powers.

variation in the absorption by aluminium is accompanied by a much greater proportional change in the ionizing power in air.

As it was evident that there was a greater transformation of the more penetrating rays, further experiments were made to detect if possible a difference in the absorption of the secondary rays produced by a primary beam of intensely penetrating rays, and of the primary rays themselves, by plates of aluminium of equal thickness. As the average penetrating power of the radiations from different bulbs used did not differ sufficiently, one bulb was used, and the more absorbable rays were cut off by plates of aluminium. As the intensity of the primary and secondary beams was considerably reduced and the percentage possible error consequently increased, the accuracy of the former experiments was not attained. These experiments, however, seemed to indicate a slightly greater absorption of the secondary radiation than of the primary.

Having proved the approximate equality in penetrative powers of the primary and secondary radiation from air, it became a simple matter to investigate the relation between the energy lost in secondary radiation by a primary beam in its passage through air and the penetrating power of that radiation. The apparatus was arranged as shown in the figure, but with plates C and D much nearer. The ratio of the rates of deflexion of the secondary and primary electroscopes was determined for a given bulb in a fixed position when the current through it was varied, also when the bulb was soft and when hard. The ratio of secondary to primary ionization was apparently slightly greater for the penetrating than for the more absorbable rays. To obtain a beam of very absorbable rays the secondary radiation from copper was again used as the primary. A copper plate was placed as nearly as possible in the position previously occupied by the anticathode of the bulb, so that the boundaries of the beam were approximately the same as before. This was not obtainable with perfect accuracy, because in the former case the radiation had proceeded from practically a point source, while to obtain a beam of sufficient intensity from the copper, a plate several square centimetres in size was used. The difference in the two cases was, however, not considerable. The ratio of secondary to primary ionization was again determined, and was found to be of the same order as when the direct beam from the bulb was used as the primary.

The actual readings obtained are given below, but as the ionization produced in the secondary electroscope was only of the same order of magnitude as that occurring under normal conditions, the possible error was great.

TABLE II.

| Primary Radiation in Experiment. | Duration of Experiment. | Primary Electro-scope Deflexion. | Secondary Electro-scope Deflexion. |
|----------------------------------|-------------------------|----------------------------------|------------------------------------|
| Rays direct from bulb | minutes. 1·3 | 164·6 | 8·9 |
| Secondary rays from copper ... | 50 | 34·4 | 3·8 |
| None | 60 | 2·4 | 1·8 |
| Rays direct from bulb | ·5 | 187 | 7·5 |
| Secondary rays from copper ... | 60 | 71 | 5·5 |
| None: screened by lead plate... | 40 | 1·4 | 1·4 |

After correction for the normal ionization, and for absorption of the secondary rays from copper in their passage from aperture R to electro-scope N of the order of 10 per cent., these readings were:—

| Primary Radiation. | Ratio of Primary to Secondary Electro-scope Deflexion. |
|--------------------------------------|--|
| Rays direct from bulb | 100 to 5·4 |
| Secondary rays from copper | 100 to 6·4 |
| <hr/> | |
| Rays direct from bulb | 100 to 4 |
| Secondary rays from copper | 100 to 4·4 |

As the boundaries of the beam proceeding from copper were necessarily not so well defined as those of the beam direct from the bulb, on account of the much greater area of the source of radiation, the two were not accurately compared, so that the agreement between these results is quite as close as could have been expected. Quantitative results were thus obtained, showing that the secondary radiation from copper is of the same nature as the primary radiation, for the secondary radiation is productive of a tertiary radiation whose intensity bears the same relation to the intensity of the secondary as that of a secondary from air bears to the intensity of the primary producing it.

It has been shown that the intensely penetrating rays transmitted through sheets of aluminium give a slightly higher ratio of secondary ionization to primary ionization than the more absorbable radiation; and that this result is due principally, if not entirely, to the greater difference in ionizing power

between the secondary and primary radiations when penetrating rays constituted the primary beam than when it consisted of more absorbable rays. It is not due to a greater fraction of the energy going as secondary radiation.

We are thus led to the conclusion that—

The energy of secondary radiation from a definite mass of air through which a primary beam of uniform intensity passes is a definite fraction of the energy of the primary beam, whatever be the penetrative power of the primary radiation; or the intensity of secondary radiation depends on the intensity of the primary radiation, but not on the character of that radiation. This verifies the theoretical result given by J. J. Thomson (*'Conduction of Electricity through Gases,'* p. 271).

Energy of Secondary Radiation.

In the passage of Röntgen radiation through gases, part of the energy of this radiation is spent in the production of ions and subsequently appears as heat in the gas when the ions recombine, part appears more directly as heat, and part is productive of secondary radiation. The approximate proportionality between the absorption and the ionization led to the assumption that practically all the energy was spent in the work of ionization; but the experiments of H. A. Wilson* and of Townsend together with those of Rutherford and McClung †, giving the energy required to ionize a molecule and that absorbed per molecule ionized respectively, lead to the conclusion that only a small fraction of the energy absorbed is spent in the work of ionization. The energy of secondary radiation has been regarded as negligible. The experiments described show that the secondary radiation from gases differs little in absorbability from the primary radiation. It is hence an easy matter to compare the intensities of the secondary and primary radiations, for these are proportional to the ionizations produced by them in equal volumes of the same gas through which they pass, and hence the total energy of secondary radiation may be compared with that of the primary.

The electroscope used to measure the intensity of the secondary radiation was placed behind a square aperture 5 cm. by 5 cm. in a lead screen, in such a position as to receive the secondary rays proceeding from the air in a direction approximately at right angles to the direction of propagation of the primary rays (fig. p. 544).

* Phil. Trans. A. 197, p. 415 (1901).

† Phil. Trans. 196, p. 25 (1901).

The solid angle subtended by this aperture at the centre of the source of secondary radiation distant about 18.5 cm. was approximately

$$\frac{5^2}{(18.5)^2} = \left(\frac{1}{3.7}\right)^2 = \omega \text{ say.}$$

Evidence was given in a previous paper leading to the theory that this radiation has its origin in the charged corpuscles constituting the molecules during the passage of X-rays through the gas. The perturbations of these charged corpuscles by the strong electric field in the Röntgen pulses are in directions perpendicular to that of propagation of the primary rays, and the intensity of secondary radiation proceeding from a single corpuscle is different in different directions, being expressed by

$$\frac{1}{4\pi} \frac{e^2 f^2 \sin^2 \theta}{V \cdot r^2} *,$$

e being the charge on the corpuscle, f the acceleration of that corpuscle, V the velocity of light, r the distance of the point considered from the corpuscle, and θ the angle between the line joining these two with the direction of acceleration of the corpuscle.

The rate at which energy is radiated from the corpuscle is

$$\frac{2}{3} \frac{e^2 f^2}{V} †,$$

Consequently the energy received by a small area subtending a solid angle ω' at the corpuscle =

$$\frac{3\omega'}{8\pi} \sin^2 \theta \text{ of the total energy of secondary radiation proceeding from that corpuscle.}$$

Now, as the electric displacements in the Röntgen radiation are in all directions perpendicular to the direction of propagation, and neglecting partial polarization of the primary beam ‡, if the line joining the small area to the source of secondary radiation be in the plane of electric displacements, the energy received by this area =

$$\frac{3\omega'}{8\pi} \cdot \frac{1}{2} \text{ of the total energy of secondary radiation}$$

proceeding from that corpuscle (the average of $\sin^2 \theta$ being $\frac{1}{2}$).

* J. J. Thomson, 'Conduction of Electricity through Gases,' p. 269.

† Through an error in integration this is given as $\frac{1}{3} \frac{e^2 f^2}{V}$ in 'Conduction of Electricity through Gases.'

‡ C. G. Barkla, Nature, March 17, 1904.

The energy of secondary radiation passing through the secondary electroscope was therefore

$$\Sigma \frac{1}{2} \cdot \frac{3}{8\pi} \omega' \cdot E_x,$$

the summation being over all elements of the aperture and all the corpuscles which contribute to the radiation through that aperture.

The effect of radiation from the air in the space G H J K is approximately the same as if all the corpuscles in that space radiated from the central point O. The angle subtended by aperture S at any corpuscle in the outer space shown in the figure depends on the position of the corpuscle, varying from ω just outside the space G H J K to zero at the outer boundaries of T U V W.

A calculation giving a result which can only be regarded as approximate, showed the total effect to be equivalent to that of all the corpuscles in a volume of air equal to about 194 c.c. radiating from O.

Therefore the energy of secondary radiation passing through electroscope M

$$= \frac{3}{16\pi} \omega E \simeq \frac{1}{230} E,$$

E being the total energy of secondary radiation from 194 c.c. of air.

The intensities of the primary and secondary beams were compared by using apertures of various sizes for the primary and secondary electroscopes, and comparing the areas of the two apertures which gave the same rate of leak in similar electroscopes. The intensities of radiation were then inversely as the areas of the apertures. As the electroscopes were not exactly similar they were standardized by finding the rate of leak produced in each by a beam of given cross section and intensity. The proportionality between the ionization produced in a given electroscope and the area of the aperture through which the beam was admitted was verified, so that local effects, as of a small portion of the beam being intercepted by the gold-leaf itself, were negligible.

The result was

$$\frac{\text{Intensity of Sec. Beam at S}}{\text{Intensity of Prim. Beam at R}} = .00000816$$

$$\therefore E = .00000816 \times 230 \times \{ \text{Energy of Primary Beam of same cross section (5}^2 \text{ cm.)} \}$$

Now the length of the primary beam passing through

air and of cross section 25 sq. cm. giving rise to this secondary radiation

$$= \frac{194}{25} = 7.8 \text{ cm.}$$

Hence the energy of secondary radiation proceeding from 1 cm. length of the primary beam passing through air at atmospheric pressure and about 15° C.

$$= \frac{.00000816 \times 230}{7.8}$$

= .00024 of energy of primary radiation passing through.

We thus see that the energy lost by secondary radiation is a considerable fraction of the total absorption, which is of the order .001 of the energy of the primary beam per centimetre.

As this radiation is most intense in the direction of propagation of the primary radiation, the primary beam is reinforced by a portion of the secondary so that the total loss of intensity of a beam whose breadth is not small in comparison with its length is not so much as indicated above.

It was shown in the previous paper that the energy of secondary radiation is proportional to the density of the gas through which the primary beam passes. When we take into consideration the loss of energy due to this secondary radiation, a considerable fraction of the absorption coefficients is accounted for and the ratio of ionization produced to absorption proper (neglecting the absorption due to secondary radiation) is more nearly a constant than the values given by Rutherford show. I think that the variations from this were all within the limits of experimental error*.

The close agreement between the ratio of absorptions found by Rutherford and the ionizations found by J. J. Thomson † for carbonic acid gas and air is accounted for by the fact that for the gases named, the ionizations for a given radiation are proportional to the densities of the gases. But the energy of secondary radiation is also proportional to the density of the gas, hence the sums of the energies lost in ionization and by secondary radiation are in the same ratio.

We thus find that the energy of Röntgen radiation lost by secondary radiation from gases at atmospheric pressure and temperature is very large compared with the energy lost in the work of ionization.

From the results of experiments of Townsend and H. A.

* *Phil. Mag.* [5] xliii. p. 241 (1897).

† 'Conduction of Electricity through Gases,' p. 251.

Wilson with those of Rutherford and McClung, J. J. Thomson* concluded that about $\frac{1}{80}$ of the energy of the rays is expended in the ionization of the gas, the rest being converted into heat. We see, however, that a large fraction—for moderately absorbable rays of the order $\frac{1}{4}$ —goes in secondary radiation. In the case of very penetrating rays the fraction is much larger.

J. J. Thomson has shown that if Röntgen radiation passes through a medium in which there are N ions per cubic centimetre each of mass m and possessing a charge e , then the radiation from each ion as its motion is accelerated by the intense electric fields in the Röntgen pulses, produces a diminution in the energy of the primary radiation, the rate of change of intensity of the primary beam due to this secondary radiation alone being given by the expression

$$\frac{dE}{dx} = -\frac{8\pi}{3} \frac{Ne^4}{m^2} E,$$

E being the intensity of primary radiation and $\frac{dE}{dx}$ the rate of change of intensity.

Now it was experimentally shown that the radiation was independent of the ionization in the gas from which the secondary radiation proceeded, but was proportional to the number of corpuscles or electrons in a given volume of the gas, and hence it was concluded that the corpuscles constituting the molecules were the sources of secondary radiation. Sub-

stituting the values experimentally determined for $\frac{dE}{E dx}$ in the above equation, together with the accepted values of e and m , we may calculate on this theory the number of corpuscles per cubic centimetre of air at atmospheric pressure and temperature, and compare this with the number assigned by the electronic theory of matter.

Taking $\frac{e}{m} = 7 \times 10^6$ and $e = 10^{-20}$,

$$\frac{dE}{dx} = -4 \times 10^{-26} NE.$$

But by experiment $\frac{dE}{dx} = -\cdot 00024 E$,

$$\therefore N = \cdot 6 \times 10^{22}.$$

Considering the range of possible values of e and m , there is a close agreement between the number thus obtained and

* 'Conduction of Electricity through Gases,' p. 255.

that calculated on the electronic theory of matter from the determined values of the number of molecules per cubic centimetre.

The number of ions (here denoting a molecule + or - an electron) necessary to produce the intensity of radiation experimentally determined would be between 10^{30} and 10^{31} per cubic centimetre. This is approximately 10^{11} times the actual number of molecules.

Quantitative measurements thus support the theory that the constituents of the molecules are the radiators.

The laws governing the secondary radiation from gases are thus in perfect agreement with the theory that this radiation proceeds from the negative corpuscles or electrons during the acceleration of their motion by the intense electric fields in the Röntgen pulses passing through the medium containing them.

No quantitative measurements of value have previously been made on the radiation from solids.

An experimental determination of the energy of secondary radiation proceeding from a brass plate which totally absorbed a primary beam was made by H. S. Allen*. He found that the number of ions produced in sulphuretted hydrogen by the secondary rays from brass was about $\frac{1}{2000}$ part of the number which would have been produced by the primary beam if it had been totally absorbed by the gas. This result has no special significance regarding the amount of transformation into secondary radiation, as an unknown fraction—but a very large one—of the total energy of secondary radiation was absorbed by the metal itself and transformed into heat. Only by using very thin sheets can an approximation be made to the fraction of the energy used up in the production of secondary radiation, or even to the character of the radiation proceeding from the metal. Sheets of metal of greater thickness give secondary beams of greater average penetrative power, for the deeper layers are only reached by the penetrating rays, and the most penetrating secondary rays penetrate to the surface in greatest proportion. Consequently the addition of more layers of metal results in the superposition of simply the most penetrating secondary rays, and the composition of the radiation proceeding from a thick plate is thus entirely different from that which is set up in each layer.

To measure the energy of secondary radiation from a solid, the radiation from which differed little in character from that

* Phil. Mag. [6] iii. p. 126 (1902).

of the primary, the same method was employed as has been described for air.

A sheet of paper weighing .373 gr. was placed in the primary beam with its plane inclined at an angle of 45° with the direction of propagation of the primary rays and with the line joining corresponding points of the two apertures R and S. The paper was so placed that the primary beam entering electroscopes N was not intercepted by it. The absorption of the secondary radiation by plates of aluminium was, within 2 or 3 per cent., the same as that of the primary radiation, showing that the difference in character between these radiations was exceedingly small. The energy of secondary radiation was then compared with that proceeding from air. Correction was made for the absorption of primary and secondary radiations in the paper. The absorption produced by a sheet of paper of the same material and thickness as that used in the experiment amounted to about 7 per cent. of the energy of the radiation normally incident upon it. There was also a small correction made for the absorption of part of the secondary radiation from air which passed through the paper.

The results are given below :—

| Secondary Radiator. | Ratio of Secondary Elec. Deflexion to Deflex. of Primary Electroscopes. |
|--|--|
| .373 gr. paper | 38.9 to 100 |
| 194 c.c. of air at 74 cms. press. and 17° C. (.239 gr.) | 25.3 to 100 |

Correcting for absorption in the paper :—

$$\frac{\text{Energy of sec. radiation from .373 gr. paper}}{\text{Energy of sec. radiation from .239 gr. air}} = \frac{42.8}{25.3}$$

This gives as the ratio of the energies of secondary radiation from equal masses of paper and air 113 to 110. These are as nearly equal as the possible errors in estimating the volume of air productive of secondary radiation and in the electroscopes deflexions admit.

We thus arrive at the conclusion that the energy of radiation from gases and light solids, the radiation from which differs little from that of the primary producing it, is for thin layers of equal thickness proportional to the density of the substance; that is, for radiation of given intensity the energy lost in secondary radiation is proportional to the quantity of matter passed through.

Recent experiments on secondary radiation proceeding from thin sheets of metal have also led me to believe—though accurate measurements have not yet been made—that from these also, though the character of the secondary radiation in some cases differs enormously from that of the primary, the

energy of secondary radiation is proportional simply to the quantity of matter passed through by a primary beam of given intensity. Using sheets of different metals, equal weights are productive of a greater secondary ionization the greater the absorbability of this radiation by sheets of aluminium; so that on the assumption that the ionizing-power varies for these radiations at a rate of 5 or 6 times the absorbability in aluminium—evidence for which I have previously given—the energy of radiation from equal masses is approximately the same in each case. As an example, the radiation from tin was approximately 5 times as absorbable by aluminium as the primary radiation, while the ionization produced in the secondary electroscope by this radiation was about 29 times the ionization produced by the secondary radiation proceeding from an equal mass of air.

For the few metals experimented upon, the energy of secondary radiation is of the order of magnitude which would bring it into agreement with the law found for gases and light solids. Further experiments are being made to test this more accurately.

It should be observed that in these measurements the radiation from metals which is absorbed by a few millimetres of air under normal conditions has not been taken account of. This may or may not form a part of the radiation accounted for by the acceleration of the negative corpuscles or electrons in the intense electric fields in the primary Röntgen pulses. Further experiments on the subject are necessary.

The results of these experiments may be summarized thus:—

(1) The character of secondary X-radiation from gases differs slightly from that of the primary producing it. (From air the secondary has greater ionizing power in air.)

(2) The penetrating rays are transformed to a greater extent than the more absorbable rays. (See previous note.)

(3) The energy of secondary radiation from a given gas through which a primary beam of given intensity is passing is independent of the character of the primary radiation.

(4) The energy of secondary radiation from gases and those light solids which are the source of a radiation differing little in character from the primary, is proportional to the quantity of matter through which the primary beam of given intensity passes.

(5) In the passage of X-radiation through air at 0° C. and 76 cms. of the pressure, the diminution of intensity due to secondary radiation is of the order of magnitude .02 per cent. per centimetre.

N.B. This is a large fraction of the total loss of intensity due to all causes for fairly penetrating rays.

(6) Applying experimental results to the expression given by J. J. Thomson for the loss of energy per centimetre (due to radiation) in passing through a medium containing ions, and taking the negative corpuscles with $\frac{e}{m} = 7 \times 10^6$ and $e = 10^{-20}$ as the sources of the radiation, the number of these corpuscles or electrons per c.c. for air under normal conditions is of the order 10^{22} .

(7) Quantitative results show that the secondary radiation from metals, though of different penetrative power, is of the same nature as the primary X-radiation.

(8) Results of the order of magnitude of those given above have been obtained with all metals experimented upon, though the secondary radiation from them differs considerably in character from the primary.

University of Liverpool.

LXII. *The Thomson Effect in Alloys of Bismuth and Tin.*
By S. C. LAWS, B.A., B.Sc., St. John's College, Cambridge;
1851 Exhibition Scholar*.

I. Introductory.

EXPERIMENTS on some of the electrical properties of Bismuth-Tin alloys have already been made by Rollmann †, von Ettingshausen and Nernst ‡, Hutchins §, Spadavecchia ||, and Schulze ¶.

The very interesting nature of the results obtained seemed to warrant a further study of the electrical behaviour of these alloys.

The present communication contains an account of some experiments on the Thomson effect, or the amount of heat evolved or absorbed by a current in passing along a conductor in which a temperature-gradient is maintained, in such alloys.

As is well known, this effect was first observed by Lord Kelvin **, who found that heat was evolved by a current passing down a temperature gradient in copper, whilst in iron an absorption of heat took place under similar circumstances.

* Communicated by Prof. J. J. Thomson.

† Rollmann, Pogg. Ann. lxxxiii. p. 78 (1851).

‡ Von Ettingshausen & Nernst, Wied. Ann. xxxiii. p. 477 (1888).

§ Hutchins, Amer. Jour. of Sci. xlviii. p. 226 (1894).

|| Spadavecchia, Nuov. Cim. ix. p. 432 (1899).

¶ Schulze, Ann. der Phys. ix. p. 555 (1902).

** W. Thomson, Phil. Trans. cxlvi. p. 649 (1856).

Lord Kelvin expressed the relation between the quantity of heat evolved or absorbed, the current and the temperature gradient in the form $dQ = C\sigma d\theta$, where dQ is the amount of heat evolved or absorbed by the current C in passing between two sections whose difference of temperature is $d\theta$. The quantity σ he called the specific heat of electricity.

Comparative values of the specific heat of electricity for a considerable number of metals were obtained by Le Roux *, whilst absolute measurements have since been made by Haga †, Batelli ‡ and King §. In the experiments described in this paper the method used by Haga has been adopted. Briefly, the method is as follows:—The temperature-gradient is obtained by immersing the ends of the experimental rods in baths at definite temperatures, and the value of the specific heat of electricity is found by comparing the change of temperature at a point when a current flowing along the temperature-gradient is reversed with the rise in temperature produced at the same point by a current in the bar when this is at a uniform temperature throughout.

In this latter case the heat generated is known from Joule's law, so that, assuming that within the limits of the experiment change of temperature is proportional to heat developed, the amount of heat produced or absorbed in the former case is at once calculated.

The Thomson effect in bismuth has already been investigated by Batelli ||, but for the sake of comparison, experiments were first made with bismuth and then with alloys containing increasing amounts of tin.

II. Preparation of the Specimens.

The bismuth used in the experiments was obtained as pure as possible by procuring the pure oxide and reducing this in porcelain crucibles with pure potassium cyanide. In this way, bismuth containing no impurity other than 0.02 per cent. of iron was obtained. The tin used was supplied as pure precipitated metal.

The specimens with which the experiments were made were cast in the form of rods about 35 cms. in length, and as thin as their brittle nature would allow—that is, about 5 mm. in diameter. In the case of the alloys the moulds in which the rods were cast consisted of hard glass tubes, of the

* Le Roux, *Ann. de Chimie et de Phys.* x. p. 258 (1867).

† Haga, *Ann. de l'école polyt. de Delft*, i. p. 145 (1885); iii. p. 43 (1886).

‡ Batelli, *Accad. delle Sci. di Torino, Atti*, xxii. p. 548 (1887).

§ King, *Amer. Acad. Proc.* xxxiii. p. 353 (1898).

|| Batelli, *loc. cit.*

required length and diameter, sealed at one end; these were heated to about 240°C . in a bath of oil, and the molten metal, which had been previously kept liquid and well stirred for some hours, poured in and allowed to cool slowly. By cutting with a diamond and gently tapping, the glass was removed from the rods; these were then annealed by placing them in a wide glass tube and heating in an oil-bath to a temperature as near the melting-point as possible and very slowly cooling.

Owing to the greater expansion of bismuth on solidifying, glass tubes could not here be used as moulds, for the metal, at the point where it first began to solidify, expanded to such an extent as to crack the tube, thus allowing any metal that still remained liquid to escape. A satisfactory mould which did not introduce impurities into the metal was made from slate. The mould was obtained in two pieces by clamping together two long slabs of slate, rectangular in cross-section, and drilling a hole of the required diameter along the length of the block with its axis coinciding with the line down the centre of the plane of junction. The walls of this cylindrical space were carefully polished with emery-powder, and the mould placed inside a cylinder around which a coil of german-silver wire was wound.

By sending a current of about 4 amperes through this coil, the mould could be heated to about 250°C . before the liquid metal was poured in. When the metal had solidified the two halves of the mould were separated and the rod withdrawn and annealed as before.

III. *Description of the Apparatus.*

To increase the magnitude of the effect to be measured and also to eliminate as far as possible errors due to the want of homogeneity of the material, two rods were used.

These were placed parallel to one another at a distance apart of 12 cms., with one end of each passing through a rubber stopper into a bath in which water could be kept boiling, and the other end in a bath which might contain melting ice, or through which a current of cold water could be circulated.

The ends in the hot baths were joined by a copper rod so that a current could be sent through the two rods in series.

To the other ends of the rods leads were soldered, and the circuit completed through a battery of accumulators B, adjustable resistance R, ammeter A, and reversing key K_1 (fig. 1).

To measure the changes of temperature, thermocouples

made from thin iron and nickel wires were used, one junction being fastened at a point on the one bar, the other at a point on the second bar, which, under the action of the temperature-gradient, assumed as nearly as possible the same temperature as the former.

Fig. 1.

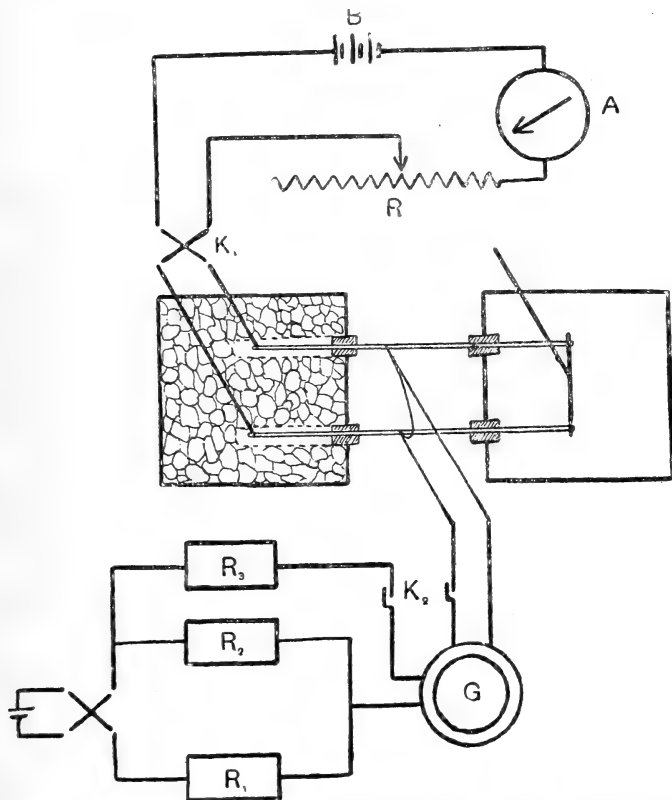

The junctions were separated from the rods by thin strips of mica, and both rods and baths closely packed with cotton-wool.

Usually four such thermocouples were placed at intervals along the rods, so that readings at different temperatures could be obtained without disturbing the packing round the bars. The free ends of the couples were joined up in series with one set of coils of a sensitive differential Thomson galvanometer of low resistance, each couple being joined up to the galvanometer in turn by means of mercury cups.

The galvanometer could be easily arranged to give a

deflexion of 1 division of a scale reflected in a telescope for a current of 10^{-7} amperes, whilst a difference of temperature between the junctions of 1° C. produced a current of 2.2×10^{-5} amperes in the galvanometer circuit, so that a deflexion of 1 division corresponded to a change of temperature of $\frac{1}{2.2 \times 10^{-5} \times 10^{-7}}$ degree C. To measure the current in the galvanometer a null method was employed, the current produced by the E.M.F. of the couple being compensated by adjusting a current in the other set of coils of the galvanometer. This compensating current was obtained from a single secondary cell joined up with a set of known resistances, and by means of a reversing key could be sent in either direction through the galvanometer. From a point R_2 (fig. 1) of the main circuit a current was taken off to pass through the galvanometer and high resistance R_3 . The required magnitude of this compensating current was then obtained by first choosing a suitable value for R_2 (100 ohms say), then adjusting R_1 (5000 ohms), and finally R_3 (1750 ohms); the current is calculated from the E.M.F. of the cell and known resistances.

In order to decide accurately on the value of the compensating current necessary to annul the effect of the current in the junction circuit, it is necessary that the two circuits should be completed at the same instant. This was effected by placing in each circuit a key consisting of a vertical copper rod dropping into a mercury cup. The two rods, which were insulated from each other, were connected to the same movable upright, worked by a string over a pulley, and their lengths were adjusted so that they touched the surface of the mercury in the cups at the same instant. In this way the compensating current could be adjusted so that the galvanometer gave no deflexion when the upright was released and the circuit completed.

This value of the compensating current is then proportional to the difference of temperature between the points of the rods to which the junctions are attached.

IV. *Practice of Method.*

The method of carrying out an experiment is then as follows:—The hot bath is filled with boiling water, which is kept boiling by means of a small gas-flame underneath; the cold bath is filled with melting ice, the ice being prevented from coming into contact with the rods by means of wire gauze caps surrounding their free ends.

When the temperature of the rods has become steady throughout, a constant current—3 or 4 amperes—is passed

through them. The temperatures having again become constant, as indicated by the constant value of the current in the 'junction' circuit, the difference of temperature between the corresponding points of the two rods—or rather, the current in the compensating circuit necessary to counterbalance the current in the 'junction' circuit due to this difference of temperature of the junctions—is observed.

The current through the rods is then reversed, when, by virtue of the Thomson effect, the temperature at any point of the rods changes, one rod experiencing an evolution of heat, the other an absorption. After an interval ranging from 30 minutes to 2 hours, according to the specimen under examination, the temperatures again become constant, when the magnitude of the compensating current in this case is observed. The current through the rods is then again reversed, and readings taken as before and so on. By subtracting the mean of two consecutive readings obtained with the current in the same direction from that with the current in the opposite direction, the mean alteration of temperature is obtained. Since the current is reversed in the two rods, this change of temperature is four times that due to the Thomson effect.

The second part of any experiment consists in measuring the rise of temperature produced by a current in the rods. In this case the rods are at the same temperature throughout, and by means of a lead soldered to the strip of copper joining them, the current is sent through each in turn. The current is sent through one rod, and, when the temperature has become steady, the difference of temperature of corresponding points on the two rods measured as in the former experiment; this circuit is then broken, and the current passed through the other rod. Sufficient time having elapsed for the temperatures to become steady, another reading of the compensating current is taken; the current is then changed back again to the first rod, but in this case made to flow in the opposite direction, and readings taken as before.

The mean alteration in the difference of temperature of the junctions produced by a change of the current from one rod to the other, is then twice that due to the evolution of heat in either rod separately. Assuming that the heat produced is proportional to the change of temperature, the amount of heat evolved or absorbed in the first experiment is obtained, and the value of the specific heat of electricity calculated. For if H_1 is the amount of heat produced or absorbed per unit length per unit time when a current C_1 flows along a

conductor in which there is a gradient of temperature, $\frac{d\theta}{dx}$, then

$$H_1 = C_1 \sigma \frac{d\theta}{dx} \text{ ergs,}$$

where C is measured in electromagnetic units and σ is the specific heat of electricity,

or
$$H_1 = \frac{C_1}{10} \sigma \frac{d\theta}{dx} \text{ ergs,}$$

where C_1 is expressed in amperes.

Also if H_2 is the quantity of heat evolved per unit length per unit time by a current C_2 , then, by Joule's law,

$H_2 = C_2^2 r$ ergs, where r is the resistance per unit length, and both C_2 and r are measured in C.G.S. electromagnetic units,

or $H_2 = 10^7 \times C_2^2 \cdot r$, where C_2 and r are expressed in amperes and ohms respectively.

Hence if δ_1, δ_2 be the changes in the compensating currents in the two cases, these are proportional to the corresponding changes of temperature, and

$$\frac{H_1}{H_2} = \frac{\delta_1/4}{\delta_2/2} = \frac{\delta_1}{2\delta_2} = \frac{C_1 \sigma \frac{d\theta}{dx}}{10^8 C_2^2 r}.$$

Or
$$\sigma = \frac{10^8}{2} \cdot \frac{r}{d\theta/dx} \cdot \frac{C_2^2}{C_1} \cdot \frac{\delta_1}{\delta_2}$$

ergs per C.G.S. absolute unit current per 1° C.

The validity of the above assumption that the amount of heat produced is proportional to the change of temperature is evident from the following data obtained for the rise of temperature due to different currents in the rods—1.23 per cent. tin.

| Current in rods C_1 . | Compensating current γ . | $\frac{\gamma}{C_2}$. |
|----------------------------|------------------------------------|------------------------|
| 1.5 amperes. | 9.97 | 4.43 |
| 1.6 „ | 11.1 | 4.34 |
| 3.0 „ | 39.6 | 4.40 |

It will be seen that within the limits of error of experiment, the rise in temperature is proportional to the square of the current, or, by Joule's law, to the amount of heat developed.

Although the greatest care was taken in preparing the rods, it was found in practice that the temperature of a given point of a rod when this was traversed by a current varied somewhat with the direction of the current when no temperature gradient was applied to the rods.

The magnitude of this effect varied from point to point, and may be attributed to slight irregularities in the composition and diameter of the rods. It was eliminated by measuring the change of temperature produced by a reversal of the current, both when a temperature-gradient was applied to the rods, and when these were at the same temperature throughout, and applying the latter, assumed proportional to the absolute temperature, as a correction to the former.

Another series of observations has then been taken with the rods reversed, so that the temperature-gradient was in the opposite direction along these, and the correction applied as before. As will be seen from the tables given, this correction varied from zero to about 5 per cent. of the whole.

To obtain the temperature-gradients along the rods, the temperatures were measured at various points. For this purpose a number (usually 5) of thermocouples of copper and german-silver were attached at intervals along each rod, one junction of each being fastened to the rod, from which it was separated by thin strips of mica, the other being free outside the covering of cotton-wool, so that it could be immersed in a vessel of water.

Each couple was then joined up in turn with the galvanometer, and the water, in which the second junction was immersed, heated until there was no current in the circuit when this was completed.

The temperature of the water, as shown by a thermometer reading to tenths of a degree, was, then, the temperature of the rod at the point to which the junction was attached; and by plotting temperatures against lengths along the bar, the value of the temperature-gradient at any point could be found.

Readings of the temperatures were taken both when there was no current passing through the rods, and when these were heated by the various currents used in the experiments.

The only other datum required is the resistance per unit length of the rods; when this has been found by measuring the resistance of each rod and taking the mean of the two values, the specific heat of electricity is calculated from the expression given above (p. 566).

V. Experiments with Bismuth.

Mean diameter of rods = 5.79 mm.

Mean resistance of rods = 0.0000453 ohms per mm.

The specific heat of electricity in this metal has been previously measured by Batelli*, who found that the value is proportional to the absolute temperature. Some observations taken are shown in Tables I. and II., from which the value of the specific heat of electricity in bismuth at 32°·5 C. is obtained.

As explained above, in order to obtain an absolute value of the specific heat of electricity, two experiments are necessary, and the tables given include results of experiments of each kind.

The first or Thomson effect experiments consist in measuring the change of temperature produced by a reversal of the current in the rods when there is a temperature-gradient along these.

In Tables—*e. g.* No. I.—showing the results of these experiments, H represents the hour at which the observation was taken; γ_1 the value of the current in the compensating circuit necessary to counterbalance that in the 'junction' circuit when the current, C, indicated at the head of the table is flowing in one direction through the rods; γ_2 the corresponding value of the compensating current when the current in the rods is reversed; $\delta (= \gamma_2 - \gamma_1)$ the change in the value of the compensating current due to a reversal of the current C.

x_1 and x_2 represent the distances from the cold bath at which the two junctions of each thermocouple are placed; the values of $\frac{d\theta}{dx}$ for these values of x are found from curves showing the relation between temperature and distances along the rods for the currents used in the experiments.

The values of the correction shown were found in exactly the same way as those of the Thomson effect, except that they were made when the rods were at a uniform temperature throughout. The correction given represents the mean of the values obtained.

In the second or 'Joule effect' experiments the rise of temperature produced by the flow of the current through the rods when these are at a uniform temperature throughout is obtained.

In tables referring to this second experiment, *e. g.* No. II., γ_1 and γ_2 are the values of the compensating current when the current C passes first in one rod and then in the other.

* Batelli, *loc. cit.* p. 548.

TABLE I.—Thomson Effect.

C=3 amperes. $x_1=3.4$ cms. $\theta=32^{\circ}.5$
 $x_2=3.55$,, $\frac{d\theta}{dx}=0.535$ degree per mm.

| H. | $\gamma_1 \times 10^5$. | $\gamma_2 \times 10^5$. | δ . |
|------|--------------------------|--------------------------|------------|
| 3.34 | -4.562 | | |
| 4.29 | | -4.228 | .381 |
| 5.24 | -4.656 | | |
| 6.15 | | -4.308 | .388 |
| 7.8 | -4.738 | | |
| 8.7 | | -4.404 | .359 |
| 8.59 | -4.785 | | |

Mean value for δ ... 0.376

Correction... .003

δ_1 ... 0.379

TABLE II.—Joule Effect.

C=2 amperes. $x_1=3.4$ cms. $x_2=3.55$ cms.

| H. | $\gamma_1 \times 10^5$. | $\gamma_2 \times 10^5$. | δ_2 . |
|-------|--------------------------|--------------------------|--------------|
| 12.24 | | +0.97 | |
| 1.26 | -1.79 | | 2.84 |
| 2.22 | | +1.12 | |
| 3.27 | -1.72 | | 2.76 |
| 4.23 | | +0.96 | |
| 5.18 | -1.75 | | 2.77 |
| 6.15 | | +1.08 | |
| 7.11 | -1.77 | | 2.83 |
| 8.5 | | +1.05 | |
| 9.0 | -1.68 | | 2.76 |
| 9.55 | | +1.12 | |

Mean value for δ_2 ... 2.79.

From the data given in these tables, the value of σ at $32^{\circ}.5$ C. may be calculated according to the expression on p. 566, when it is found that

$$\sigma = -767 \text{ ergs per C.G.S. absolute unit current per } 1^{\circ} \text{ C.}$$

Other values obtained are shown below :—

| θ . | $\frac{d\theta}{dx}$. | σ . |
|------------|------------------------|--|
| 25 | .525 | -746 ergs per C.G.S. absolute unit current per 1° C. |
| 27.4 | .525 | -753 " " " |
| 32.5 | .535 | -767 " " " |

The value found for σ by Batelli is -12.7×10^{-6} calories or -532 ergs.

The discrepancy between the two results may very well be attributed to some slight difference of composition, for Riecke gives the value $+24.5 \times 10^{-6}$ calories for *commercial* bismuth, and for *pure* bismuth -10.2×10^{-6} calories*. Moreover, Le Roux † in his comparative results obtains the same values for bismuth and iron, whilst Batelli finds for iron the value -1130 ergs ‡.

VI. Experiments with Alloy No. 1.

This alloy was found on analysis to contain 1.23 per cent. tin.

Mean diameter of rods = 4.972 mm.

Mean resistance of rods = 0.00019 ohm per mm.

Some observations taken, from which the value $\sigma = -14300$ is calculated, are shown in Tables III. and IV. ^{74°4}

TABLE III.—Thomson Effect.

C = 3 amperes. $x_1 = 9.85$ cms. $\theta = 74^\circ.4$,
 $x_2 = 9.9$ „ $\frac{d\theta}{dx} = 0.66$ degree per mm.

| H. | $\gamma_1 \times 10^5$. | $\gamma_2 \times 10^5$. | δ . |
|------|--------------------------|--------------------------|------------|
| 3.45 | | +2.33 | |
| 4.27 | -8.58 | | 10.8 |
| 5.9 | | +2.02 | |
| 5.46 | -8.58 | | 10.6 |
| 6.26 | | +1.96 | |
| 7.4 | -8.47 | | 10.6 |
| 8.16 | | +2.44 | |
| 8.52 | -8.30 | | 10.4 |
| 9.31 | | +1.74 | |

Mean value for δ ... 10.6

Correction ... 0.0

δ_1 ... 10.6

TABLE IV.—Joule Effect.

C = 1.6 amperes. $x_1 = 9.85$ cms. $x_2 = 9.9$ cms.

| H. | $\gamma_1 \times 10^5$. | $\gamma_2 \times 10^5$. | δ . |
|------|--------------------------|--------------------------|------------|
| 3.25 | | +4.61 | |
| 4.24 | -4.96 | | 9.04 |
| 5.19 | | +3.50 | |
| 6.14 | -5.23 | | 9.31 |
| 7.9 | | +4.60 | |
| 8.5 | -4.82 | | 8.90 |
| 9.2 | | +3.56 | |

Mean value for δ_2 ... 9.08.

* Riecke, *Experimental-Physik*, ii. p. 345.

† Le Roux, *loc. cit.* p. 277.

‡ Batelli, *loc. cit.* p. 548.

Experiments with this alloy show that the temperature changes considerably with the direction of the current, being from 1 to 2 degrees higher when the current flows up the temperature-gradient than when it flows down the gradient.

The Thomson effect is hence large and negative.

For any value of the current there are thus two values of θ and $d\theta/dx$ at each point of either rod, those shown in the tables being the mean of the four at the points to which the junctions are attached.

In this way the values of the specific heat of electricity calculated from the expression on p. 566 are shown below:—

| θ . | $\frac{d\theta}{dx}$. | σ . | |
|------------|------------------------|------------|---|
| 48.6 | .475 | -11,700 | ergs per C.G.S. absolute unit current per 1° C. |
| 57.2 | .47 | 12,800 | " " " |
| 59.8 | .61 | 12,700 | " " " |
| 62.1 | .56 | 13,100 | " " " |
| 69.3 | .52 | 13,800 | " " " |
| 74.4 | .66 | 14,300 | " " " |
| 75.4 | .60 | 14,800 | " " " |

It should be explained that the wide differences in the values of $d\theta/dx$ in the above table are due to the fact that two different temperature-gradients were used in these experiments: in the one case the cold bath was filled with melting ice as described above, whilst in the second case a stream of cold water was caused to flow through this.

Owing to the inconstancy of the temperature of the water, this latter method was abandoned in later experiments.

The relation between σ and θ is represented graphically in fig. 2.

Fig. 2.

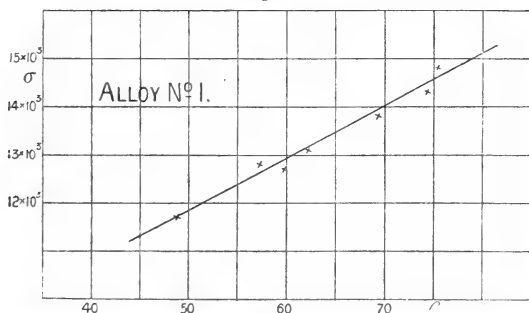

From this it appears that the values of σ increase much more rapidly than the absolute temperature; in fact, a straight line drawn through the points as in the figure cuts the axis of temperatures at -60°C .

It will be observed that these values of σ are about 15 times as large as those given for bismuth; the largest value given by Wiedemann* is for an alloy of bismuth and antimony, and is about 2.3 times as large as that given for bismuth, so that the specific heat of electricity in this alloy is about six times greater than that found for any substance previously examined.

VII. Experiments with Alloy No. 2.

Analyses of this alloy showed that it contained 3.01 per cent. tin.

Mean diameter of rods = 4.973 mm.

Mean resistance of rods = 0.000177 ohm per mm.

Examples of observations made with this alloy are shown in Tables V. and VI.

TABLE V.—Thomson Effect.

C = 3 amperes. $x_1 = 6.1$ cms. $\theta = 54^\circ.3$.
 $x_2 = 6.25$ „ $\frac{d\theta}{dx} = 0.62$ degree per mm.

| H. | $\gamma_1 \times 10^5$ | $\gamma_2 \times 10^5$ | δ . |
|-------|------------------------|------------------------|------------|
| 1.4 | -4.32 | | |
| 3.0 | | +6.33 | 10.10 |
| 4.56 | -3.21 | | |
| 7.2 | | +6.80 | 9.86 |
| 9.2 | -2.92 | | |
| 12.19 | -3.94 | | |
| 2.13 | | +6.49 | 10.11 |
| 4.13 | -3.29 | | |
| 6.11 | | +6.52 | 9.82 |
| 8.8 | -3.31 | | 9.92 |
| 10.4 | | +6.71 | |

Mean value for δ ... 9.96

Correction06

δ_1 ... 9.90

TABLE VI.—Joule Effect.

C = 2 amperes. $x_1 = 6.1$ cms. $x_2 = 6.25$ cms.

| H. | $\gamma_1 \times 10^5$ | $\gamma_2 \times 10^5$ | δ_2 . |
|-------|------------------------|------------------------|--------------|
| 11.29 | -7.26 | | |
| 1.11 | | +8.11 | 15.3 |
| 3.0 | -7.07 | | |
| 4.52 | | +8.60 | 15.7 |
| 6.50 | -7.08 | | |
| 8.42 | | +8.44 | 15.5 |
| 10.33 | -6.99 | | |

Mean value for δ_2 ... 15.5.

* Wiedemann, *Electricität*, Band ii. p. 430.

Results obtained are :—

| θ . | $\frac{d\theta}{dx}$. | σ . | | | |
|------------|------------------------|------------|--|---|---|
| 29.9 | .505 | —9,830 | ergs per C.G.S. unit current per 1° C. | | |
| 29.9 | .545 | 10,200 | " | " | " |
| 44.3 | .59 | 11,600 | " | " | " |
| 48.2 | .57 | 12,500 | " | " | " |
| 50.5 | .625 | 12,200 | " | " | " |
| 54.3 | .62 | 12,600 | " | " | " |
| 57.6 | .67 | 13,000 | " | " | " |
| 61.3 | .66 | 14,200 | " | " | " |
| 68.7 | .71 | 14,700 | " | " | " |
| 72.0 | .68 | 15,300 | " | " | " |

From fig. 3, which shows the relation between σ and temperature, it appears that here also σ increases more rapidly than the absolute temperature, the straight line drawn indicating that the Thomson effect vanishes at -53° C.

Fig. 3.

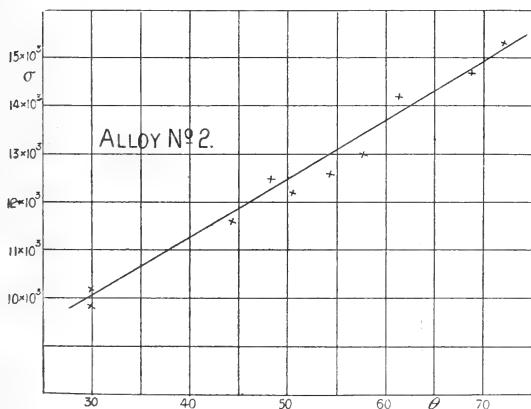

VIII. Experiments with Alloy No. 3.

This alloy was found to contain 10.0 per cent. tin.

Mean diameter of rods = 5.26 mm.

Mean resistance of rods = 0.000107 ohm per mm.

Some observations taken are shown in Tables VII. and VIII.

TABLE VII.—Thomson Effect.

C = 3 amperes. $x_1 = 3.9$ cms. $\theta = 41^\circ$ C.
 $x_2 = 3.9$,, $\frac{d\theta}{dx} = 0.608$ degree per. mm.

| H. | $\gamma_1 \times 10^5$. | $\gamma_2 \times 10^5$. | δ . |
|-------|--------------------------|--------------------------|------------|
| 10.3 | -6.32 | | |
| 11.44 | | +0.65 | 6.83 |
| 1.24 | -6.03 | | |
| 3.6 | | +0.73 | 6.71 |
| 4.46 | -5.93 | | |
| 6.31 | | +0.84 | 6.75 |
| 8.13 | -5.90 | | 6.76 |
| 10.0 | | +0.89 | |
| 10.8 | -6.15 | | |
| 11.48 | | +0.84 | 6.82 |
| 1.28 | -5.82 | | |
| 3.6 | | +0.95 | 6.76 |
| 4.53 | -5.80 | | |
| 6.32 | | +1.04 | 6.75 |
| 8.18 | -5.60 | | 6.72 |
| 9.56 | | +1.19 | |

Mean value for δ ... 6.76

Correction20

δ_1 ... 6.96

TABLE VIII.—Joule Effect.

= 2 amperes. $x_1 = 3.9$ cms. $x_2 = 3.9$ cms.

| H. | $\gamma_1 \times 10^5$. | $\gamma_2 \times 10^5$. | δ_2 . |
|------|--------------------------|--------------------------|--------------|
| 10.6 | -4.79 | | |
| 12.0 | | +4.43 | 9.16 |
| 1.44 | -4.68 | | |
| 3.27 | | +4.40 | 9.05 |
| 5.18 | -4.53 | | |
| 6.59 | | +4.64 | 9.11 |
| 8.58 | -4.40 | | |

Mean value for δ_2 ... 9.11

Results obtained are :—

| θ . | $\frac{d\theta}{dx}$. | σ . |
|------------|------------------------|---|
| 37.8 | .615 | -9230 ergs per G.C.S. unit current per 1° C. |
| 40.6 | .622 | 8960 ,, ,, ,, |
| 41 | .608 | 8970 ,, ,, ,, |
| 41 | .608 | 9290 ,, ,, ,, |
| 43.3 | .627 | 9250 ,, ,, ,, |
| 45.2 | .635 | 9590 ,, ,, ,, |
| 57.2 | .632 | 9800 ,, ,, ,, |
| 69.3 | .70 | 9980 ,, ,, ,, |
| 74.8 | .63 | 10,260 ,, ,, ,, |
| 74.0 | .657 | 10,630 ,, ,, ,, |
| 74.8 | .63 | 10,710 ,, ,, ,, |

It will be seen that the values of σ in this case are somewhat smaller than those obtained for the two former alloys.

Also from fig. 4, which represents the relation between σ and θ , it appears that the Thomson effect vanishes at about -190° C.

Fig. 4.

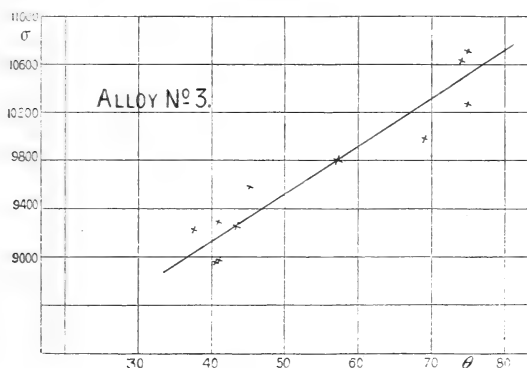

IX. Experiments with Alloy No. 4.

This alloy contains 23.6 per cent. tin.

Mean diameter of rods = 5.50 mm.

Mean resistance of rods = 0.0000425 ohm per mm.

Some observations taken are shown in Tables IX. and X.

TABLE IX.—Thomson Effect.

C = 4 amperes. $x_1 = 2.15$ cms. $\theta = 26^{\circ}.8$.
 $x_2 = 2.15$,, $\frac{d\theta}{dx} = 0.56$ degree per mm.

| H. | $\gamma_1 \times 10^5$. | $\gamma_2 \times 10^5$. | δ . |
|-------|--------------------------|--------------------------|------------|
| 12.34 | -7.66 | | |
| 1.35 | | -5.48 | 2.12 |
| 2.40 | -7.54 | | |
| 3.45 | | -5.46 | 2.10 |
| 4.49 | -7.58 | | |
| 5.53 | | -5.44 | 2.16 |
| 7.1 | -7.62 | | |
| 8.2 | | -5.41 | 2.13 |
| 8.59 | -7.46 | | 2.09 |
| 9.55 | | -5.33 | |

Mean value for δ ... 2.12

Correction ... $\frac{.15}{}$

δ ... 1.97

TABLE X.—Joule Effect.

C = 3 amperes. $x_1 = 2.15$ cms. $x_2 = 2.15$ cms.

| H. | $\gamma_1 \times 10^5$. | $\gamma_2 \times 10^5$. | δ_2 . |
|-------|--------------------------|--------------------------|--------------|
| 12.53 | -2.74 | | |
| 1.58 | | +2.07 | 4.47 |
| 2.55 | -2.07 | | |
| 3.54 | | +1.75 | 4.31 |
| 4.54 | -3.04 | | |
| 5.53 | | +1.74 | 4.52 |
| 6.58 | -2.52 | | |
| 8.1 | | +1.91 | 4.61 |
| 8.59 | -2.88 | | |

Mean value for $\delta_2 \dots 4.48$.

Results obtained for this alloy are:—

| θ . | $\frac{d\theta}{dx}$. | σ . |
|------------|------------------------|--|
| 25.6 | .535 | -3690 ergs per C.G.S. unit current per 1° C. |
| 26.2 | .54 | 3550 " " " |
| 26.8 | .56 | 3760 " " " |
| 38.1 | .56 | 3850 " " " |
| 38.8 | .57 | 3770 " " " |
| 39.5 | .605 | 3900 " " " |
| 53.5 | .705 | 3950 " " " |
| 54.1 | .71 | 3990 " " " |
| 67.7 | .755 | 4060 " " " |
| 68.1 | .77 | 4180 " " " |

It will be seen that the values of σ in this case are less than half those obtained for the previous alloy.

Fig. 5.

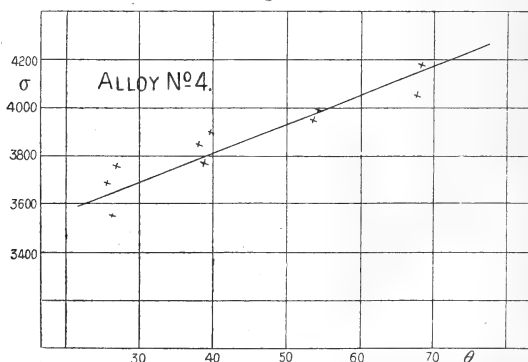

Also from the values of σ and θ plotted in fig. 5, it appears that, for the range of temperatures employed, the Thomson effect in this alloy is proportional to the absolute temperature.

X. Summary of Results.

We are now in a position to infer the manner of the variation of the magnitude of the specific heat of electricity with composition in the case of these alloys.

From fig. 6, which represents the relation between σ and percentage of tin, we see the striking effect of the addition of a very small amount of tin to bismuth, the Thomson effect in an alloy containing 1 per cent. tin being more than 12 times as large as in pure bismuth.

With the addition of more tin, the value of the Thomson effect continues to increase until the alloy contains about 3 per cent. tin, when the effect is about 15 times as large as for bismuth. When the percentage of tin is increased

Fig. 6.

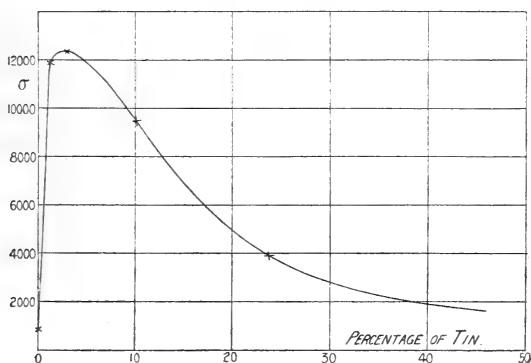

beyond this amount, the value of the specific heat of electricity begins to decrease: this diminution goes on as the amount of tin becomes greater, until finally the Thomson effect in the case of pure tin has fallen to a value which is only about $\frac{1}{300}$ part of that which holds in the case of bismuth.

It may, indeed, happen that traces of substances other than tin in bismuth produce a considerable change in the value of the Thomson effect, and any discrepancies between the values obtained for different specimens of bismuth may well be attributed to the presence of such impurities (see p. 570).

[These experiments also indicate that in the case of alloys at any rate the specific heat of electricity is not necessarily proportional to the absolute temperature. A similar result has been previously pointed out by Haga, whose experiments

showed that in the case of platinum the Thomson effect vanishes at -70° C. *]

In conclusion I desire to express my best thanks to Prof. J. J. Thomson for his advice and suggestions throughout the course of the work, and to my brother, Mr. H. E. Laws, to whom I am indebted for the analyses of the specimens used.

Cavendish Laboratory,
March 25th, 1904.

LXIII. *On the Intensity of the Natural Radiation from Moving Bodies and its Mechanical Reaction.* By Prof. J. LARMOR, Sec.R.S.†

THE subject of the pressure of radiation, which was first reduced into a definite formula by Maxwell, was placed in new and most fruitful light when Boltzmann showed, by following out an idea of Bartoli, that it stood in intimate relation to the law connecting the radiation of a body with its temperature. In a recent memoir ‡ Poynting has based very remarkable results, as regards cosmical dynamics, on the operation of a retarding force due to the back pressure of its own radiation when the radiating body is in motion. The main object of the present note is to treat this aspect of radiation-pressure by more direct methods, and thereby confirm the expression for the mechanical reaction against a moving radiating surface, that has been deduced by Poynting from general considerations, naturally somewhat uncertain, relating to flux of energy.

The pressure exerted by radiation is essentially connected with opacity to it. From formulæ developed on other occasions § it appears that, in the case of a medium which may vary in its properties in any manner along the direction of propagation x , when it is the seat of electric disturbances of simple harmonic period $2\pi/n$, polarized so that the electric force is $(0, Q, 0)$ and the magnetic $(0, 0, \gamma)$, the dynamical equations being thus in Maxwell's notation

* Haga, *loc. cit.* iii. p. 48.

† Reprinted from the *Boltzmann-Festschrift*. Communicated by the Author.

‡ Roy. Soc. Proc. 1903; Phil. Trans. *ibid.*

§ Phil. Trans. 1897 A; or more fully in 'Æther and Matter,' Camb. Univ. Press, 1900, pp. 130-133.

$$4\pi v = -\frac{d\gamma}{dx}, \quad \frac{dQ}{dx} = -\mu \frac{d\gamma}{dt}, \quad v = \sigma Q + \frac{K}{4\pi c^2} \frac{dQ}{dt},$$

the mechanical force acting on any block or segment of it is representable by pressures of intensity

$$\frac{1}{8\pi} \left(\gamma^2 + \frac{1}{c^2 \mu n^2} \frac{dQ^2}{dt^2} \right)$$

applied to the two ends of the segment,—these pressures just cancelling each other, as they ought, when the segment consists of free æther without matter. The mean value of this end-pressure is

$$\frac{1}{16\pi} \left(\gamma_0^2 + \frac{Q_0^2}{c^2 \mu} \right),$$

where γ_0 and Q_0 represent the amplitudes of γ and Q .

When the amplitudes are diminished owing to gradual absorption as the disturbance travels onward, there is thus steady mechanical force exerted in the medium in the direction of propagation. When the electric disturbance is incident on a transparent reflector there is no resultant force on the reflecting surface itself, because γ and Q both remain continuous in crossing it. When, however, the reflector is nearly perfectly opaque, the electric forces in front of it in the incident and reflected disturbances almost cancel each other, while the magnetic force just outside is doubled by its presence: there must thus be disturbance of the nature of alternating electric flux in the skin-layer of the reflector such as will annul this magnetic field in its interior, and it is the electrodynamic forces acting on this layer of current that constitute the aggregate electric pressure, which can be shown* to agree with Maxwell's formula.

From this way of considering the mechanical force, it is readily verified that when the incidence on the reflector is oblique, Poynting is right in taking the incident and reflected wave-trains each to exert their full oblique thrust on the reflector along their directions of propagation.

For radiation to exert steady non-alternating pressure on a small body, it must † be of opaque material. A dielectric mass constituted of perfectly elastic elementary vibrators should not be repelled by radiation. In illustration, consider the simplest type of vibrator, an electric doublet consisting of charges $+e$ and $-e$ separated by a varying distance l , parallel to x , so that its moment M is el . When it is subjected to a simple wave-train travelling along x with

* *Loc. cit.* p. 133.

† *Loc. cit.*

electric force $(0, 0, A \cos pt)$, and therefore magnetic force $c^{-1} (0, A \cos pt, 0)$, the equation of its forced vibration is

$$\frac{d^2 M}{dt^2} + \kappa^2 M = eA \cos pt,$$

so that

$$M = \frac{eA}{\kappa^2 - p^2} \cos pt;$$

and, the vibrator constituting a current element dM/dt , the magnetic field pushes it along z with a mechanical force $\beta dM/dt$, which is

$$p \frac{eA^2 c^{-1}}{\kappa^2 - p^2} \cos pt \sin pt.$$

This electromagnetic force is, however, purely alternating, and so adds up in time to nothing: the only way to obtain steady mechanical pressure on the vibrator is to put the forced vibration out of phase with the exciting field by the introduction of a frictional term into the equation of vibration, which will correspond to opacity.

In the theory of exchanges of radiation, it is customary to represent a perfect reflector as a body of very high electric conductivity. Any body across which the radiation cannot penetrate is, as already stated, subject to a pressure from the radiation just outside it, determined by Maxwell's formula. It is worth while to verify explicitly that the absorbing quality which must be associated with this pressure does not act so as to vitiate the perfection of the reflexion by degrading the energy. This is, of course, readily done. The equations of wave-propagation already formulated lead to

$$\frac{d^2 Q}{dx^2} = 4\pi\mu\sigma \frac{dQ}{dt} + K\mu c^{-2} \frac{d^2 Q}{dt^2}.$$

Writing

$$Q = A e^{int} e^{-ipx},$$

this gives

$$p^2 = K\mu c^{-2} n^2 + 4\pi\mu\sigma nc.$$

Thus, if the conductivity σ is largely preponderant we may write

$$p = (2\pi\mu n\sigma)^{\frac{1}{2}} (1+i), \quad \text{say} = r(1+i).$$

Taking the real part *

$$Q = A e^{int} e^{-rx} \cos rx,$$

* But this is for stationary waves; it should have been for progressive waves $Q = A e^{-rx} \cos(nt - rx)$, giving

$$H = \frac{A^2}{4r} = \frac{A^2}{8\pi} \left(\frac{\lambda\sigma}{\mu c}\right)^{\frac{1}{2}}.$$

the heat developed per second comes out to be

$$H = \sigma \int_0^{\infty} \frac{1}{2} Q^2 dx = \frac{3\sigma A^2}{16r} = \frac{3A^2}{32\pi} \left(\frac{\lambda\sigma}{\mu c}\right)^{\frac{1}{2}}.$$

Now if A_1 is the coefficient for the wave-train directly incident from the free æther and A' that for the wave-train reflected back, the continuity of Q and of $\mu^{-1}dQ/dx$ across the surface gives

$$A_1 + A' = A, \quad \frac{n}{c}(A_1 - A') = \frac{\rho}{\mu} A,$$

so that

$$A_1 = \frac{1}{2} \left(1 + \frac{\rho}{\mu n c}\right) A;$$

and passing again to real parts by taking moduli, the amplitude of the incident train is approximately

$$\frac{1}{2}(\mu^{-1}\lambda\sigma c)^{\frac{1}{2}}A.$$

The energy incident per second is thus

$$\frac{1}{8\pi c^2} c \cdot \frac{1}{4}\mu^{-1}\lambda\sigma c A^2 \quad \text{or} \quad \frac{A^2}{32\pi\mu} \lambda\sigma,$$

of which the part degraded thus forms a negligible fraction inversely proportional to the square root of the conductivity σ .

The waves are thus turned back without sensible loss by degradation, because for an ideal good conductor the surface-layer is at a node of the electric force. There is superficial current in the conductor which gives rise to the Maxwellian repulsion by the agency of the magnetic field, while there is no sensible electric resistance, the small electric force near the node establishing the necessary current without production of heat.

The conditions which here obtain for very high conductivity and short waves also hold for lower conductivity and longer waves. For long heat-waves the proportionality of the absorbing powers of metals to the square roots of their specific resistances has, as is well known, been discovered by Hagen and Rubens, and explained in advance by Drude and afterwards by Planck: this observation carries the interesting result that the resistance-coefficients are nearly the same for such heat-waves as for ordinary steady currents.

Any doubt that may be entertained as to whether radiation exerts a back pressure on the body that emits it, may be diminished by considerations of the kind here employed. The

emitting body being opaque, the source of the radiation is vibratory disturbance of electrons in its surface-layer; these constitute a self-damped current-sheet which is pushed back by the magnetic field it produces, precisely as happens for the corresponding current-sheet at a conducting surface on which radiation is incident as above*.

We now proceed to our problem of the radiation from a moving body. Consider an enclosure, with ideal perfectly reflecting walls, at a uniform temperature throughout, and thus pervaded by the steady natural radiation corresponding to that temperature. The principle of Carnot requires that we cannot by cycles of slow movement of the bodies in the enclosure transform any of this energy at uniform temperature into mechanical effect through the agency of the pressure of radiation. There must therefore be a unique state of density of the total enclosed radiation, independent of the nature of the surfaces of the bodies in movement; for otherwise direct movement with one kind of surface combined with the reverse movement with another kind would constitute a working cycle. The steady aggregate density of radiant energy in the enclosure is therefore not affected by the motion of the bodies; indeed, if this were not so, by opening and closing a window in the enclosure while it is moving at different speeds, cycles could be established which would violate Carnot's principle. Now compare a moving perfectly reflecting surface, which reflects back all the incident radiant energy, with the same moving surface rendered perfectly absorbing: this is allowable, the analogous change from conducting to non-conducting being contemplated in elementary thermal reasoning about Carnot's principle. It follows from the theory of exchanges, that in the state of equilibrium the radiation that is returned must be the same as regards constitution and intensity in both cases. Now the solution of the electrodynamic problem of reflexion from a moving perfect reflector is known †: therefore the law of the radiation from a perfect radiator in motion is determined in complete detail. When the reflector is advancing in a stationary enclosure, the energy-density of the reflected radiation is greater than that of the incident, and the excess is a fraction of the latter equal to four times the ratio of the velocity of the reflector

* [April 22.—There are, however, intricacies here, owing to the internal radiation in the conductor, which are evaded for the present purpose by considering the aggregate force on a moving slab due to the radiation emitted from both faces, as given by the formula at the beginning.]

† Cf. Larmor, British Association Report, 1900; *Encyclopedia Britannica*, article "Radiation," xxxii. 1903.

in its direction to the velocity of light*. Thus, when the enclosure is moving as well as the reflector, the energy of the incident stream coming from its receding walls is in defect by twice the ratio of these velocities, and that of the reflected stream is in excess by twice the same ratio. This latter factor therefore also expresses the excess in the volume-density of natural radiation coming from a perfect radiator that is produced by its own advancing motion; but in a detailed specification of this radiation the modification of the wave-lengths in accordance with the Doppler principle is also to be borne in mind.

A different and generalized mode of treatment may also be adopted, based on Lorentz's transformation for passing from the field of activity of a stationary electrodynamic material system to that of one moving with uniform velocity of translation through the æther. If (f, g, h) and (a, b, c) represent the field of a material system at rest in the æther, then to the first order of v/c ,

$$\left(f, g + \frac{v}{4\pi c^2} c, h - \frac{v}{4\pi c^2} b \right)$$

and $(a, b - 4\pi v h, c + 4\pi v g)$

represent the values of the same vectors, say (f_1, g_1, h_1) and (a_1, b_1, c_1) , for a system in motion parallel to x with velocity v ; and the positions and magnitudes, and therefore relative velocities, of the electrons which produce these fields in the surrounding æther in the two cases are identical at each instant, so that the fields belong to the same material system †.

An enclosing material boundary is supposed to form part of the system, so as to retain the radiant energy at uniform density. Let us compare the densities E and E_1 of energy in the two cases of rest and translation, as given by Maxwell's formula

$$E = 2\pi c^2(f^2 + g^2 + h^2) + \frac{1}{8\pi}(a^2 + b^2 + c^2).$$

We obtain, neglecting $(v/c)^2$ as before,

$$E_1 = E + 2v(gc - hb).$$

* The Maxwellian formula for the pressure of radiation may be based (*loc. cit.*) on this result, in connexion with the conservation of the energy; or conversely, the value of that pressure being assumed on other grounds, this result for the intensity of the reflexion may be based upon it.

† Cf. 'Æther and Matter,' p. 169. [The change to "local time" merely introduces the Doppler effect.]

Now the flux of energy in the æther is by Poynting's rule the vector

$$-c^2(hb - gc, fc - ha, ga - fb),$$

so that the last term in E_1 is $2c^{-2}$ times the scalar product of this flux and the translatory velocity of the system.

Thus the density of the radiation that is travelling in the enclosure in directions inclined towards ν is increased; but in the opposite directions it is diminished by equal amount, so that the aggregate density is unaltered, as already seen.

Taking a particular case, for a plane wave-train represented by (f, g, h) and (a, b, c) , forming part of the steady radiation, which thus travels in the direction perpendicular to both these vectors, the flux of energy per unit time is increased for the moving material system by a fraction of itself equal to twice the component of ν along its direction of propagation divided by the velocity of light. There is diminution in the flux for waves coming from the receding parts of the boundary of the enclosure, and an equal increase for those reflected back, giving in all the factor 4 previously obtained for the change of volume-intensity on reflexion. It may be remarked that this mode of selected orientation of the steady radiation in the moving enclosure clearly satisfies the necessary condition that, when an aperture has been made anywhere into an outer region of steady radiation, the radiation that issues through it is the same as had been previously sent back from the wall at that place.

The same results for the change in the energy flux in any direction may be obtained directly from the flux-formula of Poynting, when the modified values of the vectors in the moving system are inserted. The connexion between the two methods rests on the remark that for a plane progressive wave the flux per unit time is the density multiplied by the velocity of propagation, when there is no dispersion.

The volume-density of radiation emitted from a perfect radiator in any direction thus involves a factor $1 + 2k$, where k is the ratio of the velocity of the radiator in that direction to the velocity of light; and the pressure of this ray, exerted directly backward, is altered accordingly, with consequences considered by Poynting in the memoir already referred to.

This result is in fact what clearly obtains if on an ultimate dynamical theory the energies of the vibratory motions of the radiating sources are not affected by the uniform translation, but depend only on the temperature or other physical cause, as Carnot's principle requires; for the amplitude of the vibration communicated to æther then remains the same, but

owing to the shortening of the waves, the velocity in this vibration is changed, and therefore the volume-density of vibratory energy in the æther is modified as above. And the Lorentz transformation has shown us what is not so immediately obvious, that also on the electric view which considers the sources to be constituted of vibrating electrons, though their relative motions are not affected by the uniform translation as again Carnot's principle demands, yet the vibratory energy emitted from them is modified in the manner here described.

Cambridge, September 21, 1903.

[*Note added Dec. 26.*—As the intensity of the pressure of radiation depends on the instantaneous state of the adjacent medium, it may be expected to remain equal to the energy per unit volume, as above assumed, whether the body that it acts on is at rest or in motion.

We may verify in detail for a plane-polarized wave-train with electric force $(0, Q, 0)$, current $(0, v, 0)$, and magnetic force $(0, 0, \gamma)$, incident directly on an absorbing face perpendicular to x . Then* the mechanical force in the absorber per unit volume is

$$X = \left(v - \frac{dg}{dt} \right) \gamma,$$

where

$$4\pi v = -\frac{d\gamma}{dx}, \quad \frac{dQ}{dx} = -\mu \left(\frac{d}{dt} + v \frac{d}{dx} \right) \gamma,$$

and

$$g = \frac{Q}{4\pi C^2},$$

v being the velocity of the material medium, with which the axes of coordinates travel. Thus

$$\int_{x_1}^{x_2} X dx = - \left| \frac{\gamma^2}{8\pi} \right|_{x_1}^{x_2} - \frac{1}{4\pi C^2} \int_{x_1}^{x_2} \gamma \frac{dQ}{dt} dx.$$

Let the slice between x_1 and x_2 be an indefinitely thin one containing the absorbing interface; as Q is continuous across it, dQ/dt is very small outside it; thus, γ being finite, the last term is negligible, and the mechanical force acting on the slice is equal to the value of $\gamma^2/8\pi$ just outside it, where Q is null; thus it is equal to the energy-density just outside, whether the absorber is in motion or not.

From the way of considering the origin of this mechanical

* 'Æther and Matter,' 1900, § 65.

force above, as acting on the interfacial current-sheet, it is not difficult to verify that when the incidence is oblique, the incident, reflected, and refracted wave-trains exert independently on the reflecting surface their full oblique thrusts in their own directions of propagation, as is implied in Prof. Poynting's calculations referred to at the beginning.

The result here verified, that motion of a material body does not affect the pressure exerted on it by the ambient radiation, has been rejected by Prof. Poynting in a later postscript added to the memoir above referred to, on the ground that radiation shot out of a radiator A into a moving absorber B would, according to it, alter the store of momentum of the two bodies. But if the bodies are in thermal equilibrium, other compensating events are at the same time occurring, viz. the absorber B is also radiating towards A. And indeed if the temperatures of A and B are unequal, the aggregate momentum of both admittedly does change on account of their radiation.

If the present argument is right, the view which considers a ray to be a simple carrier of momentum from the one body to the other cannot therefore be maintained.

It may be noticed, in connexion with p. 584 *supra*, that for the same amplitude of ionic excursions in the vibrating molecule, as determined by its maximum electric moment, and for the same periodic time, it follows from Hertz's formulæ for a simple radiator, and may be generalized by the theory of dimensions, that the radiation emitted per unit time is proportional to the refractive index of the surrounding medium, and therefore the equilibrium-density of the radiation in that medium is proportional to the square of the same index, in accordance with Balfour Stewart's law derived from the doctrine of equilibrium of exchanges between sources at uniform temperature.]

LXIV. *Note on the Measurement of Small Inductances and Capacities, and on a Standard of Small Inductance.* By J. A. FLEMING, D.Sc., F.R.S., Professor of Electrical Engineering in University College, London*.

LAST year a paper was read before the Physical Society by the present writer and Mr. W. C. Clinton, on the "Measurement of Small Capacities and Inductances" †.

In that paper we described two forms of motor-driven commutator for the measurement of small capacities and

* Communicated by the Physical Society: read March 25, 1904.

† See Proc. Phys. Soc. Lond. vol. xviii. p. 386; also Phil. Mag. May 1903, p. 493.

inductances. Since that date, these appliances have been extensively used for this purpose in the Pender Electrical Laboratory at the University College.

In the measurement of small inductances lying in value between 100,000 and 10,000 centimetres, it is essential to use in connexion with the modification of the Anderson method*, described in our paper, a very sensitive galvanometer; and when small inductances of this order are being measured we have since found that the stray field from the motor employed to drive the commutator produces, by a dynamo action, a small electromotive force in the commutator which makes itself evident in the galvanometer circuit, and so gives rise to an irregularity, vitiating the results. The remedy for this, of course, is to employ an enclosed iron-clad motor, or else to place the commutator at a greater distance from the motor, connecting the two by a long shaft. This has already been done and has been found to be effective.

Meanwhile, in the course of the experiments to overcome these difficulties, the attempt was made to use a telephone in place of the galvanometer and a simple interrupted current in the battery-circuit. In the bridge arrangement described by Prof. Anderson (*loc. cit.*) we substituted an ordinary buzzer in the battery-circuit to interrupt the current at the rate of about 100 per second, and in the bridge-circuit an ordinary Bell telephone for the galvanometer, the commutator being abolished. Under these circumstances, it was found that an observer with sharp hearing could obtain a very good balance when a coil having small inductance was placed in one arm of the bridge, and a condenser of suitable capacity placed as described by Prof. Anderson (see fig. 1).

Mr. J. C. Shields, who has been engaged in experiments on this matter in the Pender Laboratory, found that with this arrangement he could make very quick and fairly accurate determinations of small inductances, the accuracy of the reading being determined by the limits within which a value could be assigned to r in the equation given by Prof. Anderson, viz. :

$$L = C\{r(R + S) + RQ\},$$

the value of r being that of a resistance inserted in the bridge-circuit, which is varied until no sound is heard in the telephone.

In the above equation L is the inductance and R the resistance of the coil being measured, C the capacity of the condenser, and S and Q the resistances of the adjacent

* See Phil. Mag. vol. xxxi. p. 329 (1891).

and opposite bridge-arms, and r the resistance inserted in series with the telephone in the bridge-circuit.

When r was adjusted to produce silence in the telephone, it was found that variations to the extent of about 1 per cent. either way, and sometimes much less, caused the sound to reappear in the telephone, and hence gave the limits within which the inductance L could be determined.

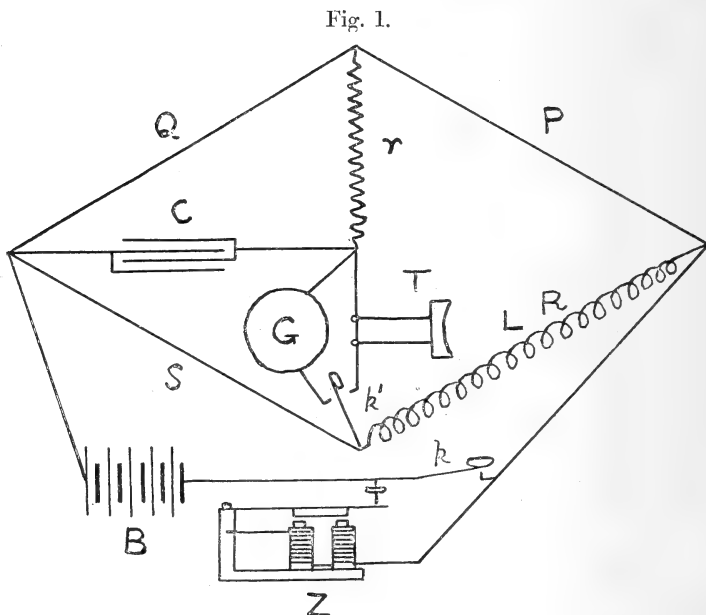

In the experiments here described, the capacity generally employed consisted of two leyden-jars, the joint capacity of which had been determined carefully with the Fleming-Clinton commutator, and found to have the value 0.00272 microfarad. The tests of this telephone method were made by Mr. J. C. Shields on a number of coils of silk-covered copper wire, each of which consisted of one layer of the wire wound uniformly and in closely adjacent turns upon a wooden or glass circular-sectioned rod. One coil, much employed, consisted of a wooden rod about two metres in length wound over as above described with one layer of no. 32 s.w.g. wire in closely adjacent turns. The mean diameter of one circular turn of this wire was 4.096 centimetres, and the length of the solenoid or spiral wire was 200.3 centimetres, and the number of turns of wire 5000 in all, and hence

the number of turns per centimetre of length of the spiral was 24.96.

This long coil belonged to a resonance apparatus designed by Seibt, and is hence alluded to as the long Seibt coil. The resistance of the wire on this coil was about 152 ohms, and it was connected to a Wheatstone's bridge (as shown in fig. 1), the other arms of which are denoted by P, Q, and S.

The arrangement of apparatus used, consisted therefore of an ordinary Post-Office plug Wheatstone's bridge having the spiral of which the inductance was to be determined connected to it. The battery-circuit contained the buzzer, and the bridge-circuit a telephone in series with a plug resistance-box, affording values for r . The condenser consisted of one or more leyden-jars or a mica condenser. The steady balance was obtained first in the usual way with a galvanometer and steady current.

The following Table gives the values of the bridge-arms, the bridge resistance r , the capacity used, and the inductance L calculated from the formula given by Anderson.

The Table contains two sets of measurements, one set marked A, made by Mr. Shields with the Fleming-Clinton commutator, and the other marked B, made with the telephone and buzzer as above described.

TABLE I.—Results of Inductance Measurements of a Long Coil, having a Dimension ratio of 50 : 1.

| P. | Q. | R. | S. | r . | C. in mfd. | L. observed in cms. |
|------|--------|--------|--------|-------------|---------------|------------------------|
| 100 | 1000 | 152.26 | 1522.6 | 4260 | 0.00272 | 19,900,000 |
| 100 | 1000 | 152.31 | 1523.1 | 7675 | 0.00149 | 19,400,000 |
| 100 | 1000 | 151.1 | 1511 | 4400 ± 50 | 0.00272 | 20,300,000 |
| 1000 | 10,000 | 151.5 | 1515 | 3350 ± 50 | 0.00272 | 19,200,000 |
| 100 | 10,000 | 151.5 | 15150 | 365 ± 5 | 0.00272 | 19,300,000 |
| 1000 | 1000 | 152 | 152 | 24200 ± 100 | 0.00272 | 20,100,000 |
| 100 | 1000 | 151.4 | 1514 | 4400 ± 50 | 0.00272 | 20,300,000 |
| 1000 | 10,000 | 151.4 | 1514 | 3330 ± 20 | 0.00272 | 19,200,000 |
| 10 | 1000 | 151.7 | 15170 | 485 ± 5 | 0.00272 | 20,600,000 |
| 100 | 10,000 | 151.7 | 15170 | 365 ± 5 | 0.00272 | 19,300,000 |
| 100 | 100 | 152 | 152 | 217 ± 1 | 0.256 | 20,800,000 |

Mean of A readings = 19.7×10^6 cms.

Mean of B readings = 19.9×10^6 cms.

Value calculated from the formula $L = (\pi D t)(\pi DN) = 20.6 \times 10^6$ cms.

By numerous observations on coils of this kind, sometimes 50 diameters long or even less, the wire being wound in a single layer and in closely adjacent turns, the writer has

found that a very simple formula enables the inductance to be calculated very approximately.

If D is the mean diameter of the axis of one circular turn of the wire forming the solenoid, and if l is the length of the solenoid, and N the total number of turns on the solenoid, then it is clear that the magnetic force per unit of current in the central portions of the interior of the coil is equal to $4\pi N/l$, and the total self-linked flux is $4\pi N^2\pi D^2/4l$. Hence, if we neglect the variation of flux at the ends and consider that all up the coil it has the same value as at the centre, the inductance L of the coil is given by the formula

$$L = \pi^2 D^2 t^2 l;$$

where t is written for the turns per unit of length of the solenoid $= N/l$.

Hence the above equation may be written

$$L = (\pi D t)(\pi D N).$$

The first factor $\pi D t$ is the length of wire wound on one unit of length of the cylindrical rod used as a core. This factor is of no dimensions and is a mere numeric.

The second factor $\pi D N$ is the total length of wire used. Hence, we have for such a solenoid:—

$$\text{Inductance} = \left(\frac{\text{length of wire per}}{\text{unit length of solenoid}} \right) \times \left(\frac{\text{total length of wire}}{\text{used to form solenoid}} \right).$$

Applying this rule to the above mentioned long Seibt coil, we have for the total length of wire used

$$3 \cdot 1416 \times 4 \cdot 096 \times 5000 \text{ cms.} = 64340 \text{ cms.},$$

and the length wound on per centimetre of the rod is

$$3 \cdot 1416 \times 4 \cdot 096 \times 5000 \div 200 \cdot 3 = 321 \text{ cms.},$$

and hence

$$L = 20 \cdot 6 \times 10^6 \text{ cms nearly, or } 20 \cdot 6 \text{ millihenrys.}$$

It will be seen from Table I. that the average observed value of L for this coil, as calculated from nine bridge-readings made with the telephone method, is $19 \cdot 9 \times 10^6$ cms. nearly; and hence the inductance calculated by the above rule agrees within 3·5 per cent. with that obtained by actual measurement.

This rule affords a very simple and convenient guide for constructing small known inductances. All that it is necessary to do is to wind silk-covered copper wire in one layer and in closely adjacent turns on a glass rod of measured diameter, and make the length of the solenoid at least 50 times the diameter. The inductance can then be predetermined

to within say 2 per cent. and adjusted to be of required value by varying the length and diameter of the rod. A series of tuning inductances can in this manner be easily made, which, when associated with known capacities, give circuits having known oscillation frequencies.

When the coils have a smaller dimension-ratio, being only 6 or 7 diameters long, then the above rule always gives, as it should do, an inductance value which is too large, but even in the case of such short coils not by very many per cent. This may be seen from the inductance measurements made by the telephone method on four short coils called for distinction A, B, C, and D, which had the following dimensions and windings. The coils were made of silk-covered no. 36 or no. 38 wire wound on glass tubes.

TABLE II.

| Coil. | Length of Solenoid = l . | Diameter of Solenoid = D . | Number of Windings = N . | Calculated Inductance = L from the formula $L = (\pi D l)(\pi D N)$. |
|---------|----------------------------|------------------------------|----------------------------|---|
| A | 20.5 cms. | 3.3 cms. | 513 | 1,379,800 cms. |
| B | 20.4 cms. | 3.5 cms. | 813 | 3,918,200 cms. |
| C | 20.8 cms. | 3.4 cms. | 847 | 3,935,200 cms. |
| D | 20.9 cms. | 3.7 cms. | 850 | 4,670,800 cms. |

The inductance of these coils was measured with the bridge and telephone, using a capacity of 0.00272 microfarad and the bridge values were as in Table III. (p. 592).

The mean values of the observed inductances of each coil differ from the extreme values in some cases by less than 1 per cent., and in no case by more than 2 per cent. The mean observed values are less (as they should be) than the values calculated by the formula $L = (\pi D l)(\pi D N)$ by about 6 or 7 per cent.

It has always been found that when the dimension ratio is as much as 50:1 or more, then there is a close agreement between the observed and calculated value of the inductance. The above described telephone and buzzer modification of the Anderson method can be therefore used to calculate the value of the capacity used in the bridge, assuming the calculated value of the inductance of the inductive arm. Thus, if in the measurements recorded in Table I. we take the inductance

TABLE III.—Results of Inductance Measurements on Short Coils, having a Dimension ratio of 7 : 1.

(Telephone and buzzer in combination with Anderson's method.)

| Coil. | Bridge-arms in ohms. | | | | <i>r</i> . ohms. | C. mfd. | L. Inductance observed. cms. | Mean value and greatest deviation from mean. | L. Calculated by formula. |
|-------|----------------------|------|-------|------|---------------------|------------|---------------------------------------|---|------------------------------------|
| | P. | Q. | R. | S. | | | | | |
| A | 10 | 1000 | 12·23 | 1223 | 384±2 | ·00272 | 1,321,000 | 1,295,000 +26,000 -13,000 | 1,379,800 |
| | 100 | 110 | 12·73 | 14 | 164½ | ·2222 | 1,288,000 | | |
| | 100 | 100 | 13·00 | 13 | 173 | ·2222 | 1,288,000 | | |
| | 10 | 1000 | 12·22 | 1222 | 370±2 | ·00272 | 1,282,000 | | |
| B | 100 | 1000 | 76·9 | 769 | 1450±4 | ·00272 | 3,550,000 | 3,537,000 +13,000 -13,000 | 3,918,200 |
| | 100 | 1000 | 77·1 | 771 | 1440±10 | ·00272 | 3,530,000 | | |
| | 100 | 100 | 78·0 | 78 | 51+<1 | ·2222 | 3,524,000 | | |
| | 10 | 10 | 78·0 | 78 | 96+<1 | ·2222 | 3,543,000 | | |
| C | 100 | 1000 | 80·3 | 803 | 1440±5 | ·00272 | 3,680,000 | 3,661,000 +19,000 -11,000 | 3,935,200 |
| | 100 | 100 | 83·0 | 83 | 49±1 | ·2222 | 3,652,000 | | |
| | 10 | 10 | 83·0 | 83 | 94±1 | ·2222 | 3,652,000 | | |
| D | 100 | 1000 | 86·5 | 865 | 1555±5 | ·00272 | 4,257,000 | 4,300,000 +41,000 -43,000 | 4,670,800 |
| | 100 | 100 | 88·0 | 88 | 60±1 | ·2222 | 4,302,000 | | |
| | 10 | 10 | 88·0 | 88 | 106±1 | ·2222 | 4,341,000 | | |

of the long coil to be 20·6 millihenrys, and use the bridge readings to calculate the value of the capacity of the leyden-jars, we find it to be 0·00282 mfd. The values of this capacity measured by the intermittent discharge method was found to be 0·00272 mfd. Hence, the bridge-telephone-buzzer method, which needs no special appliances other than those found in every laboratory, provides a means of determining with fair accuracy quite small capacities very easily, and can be applied to the measurement of the capacities of telegraph wires or aerials or very short lengths of cables.

The method has been used for the calibration of a variable inductance made for certain resonance experiments. This inductance standard was constructed as follows :—

A cylinder of boxwood about 10 centimetres in diameter and 45 cms. in length is provided at the ends with brass plates carrying centre pins, by means of which it is suspended in bearings. This cylinder is cut with a screw of 6 threads to the inch, and in this is wound a no. 14 s.w.g. copper wire, the ends of which are attached to the end plates. Parallel with the cylinder (see fig. 2) is fixed a brass rod about 1 cm. in diameter on which slides a travelling bar, the end of which

carries a brush which makes contact with the copper spiral at one place.

Fig. 2.

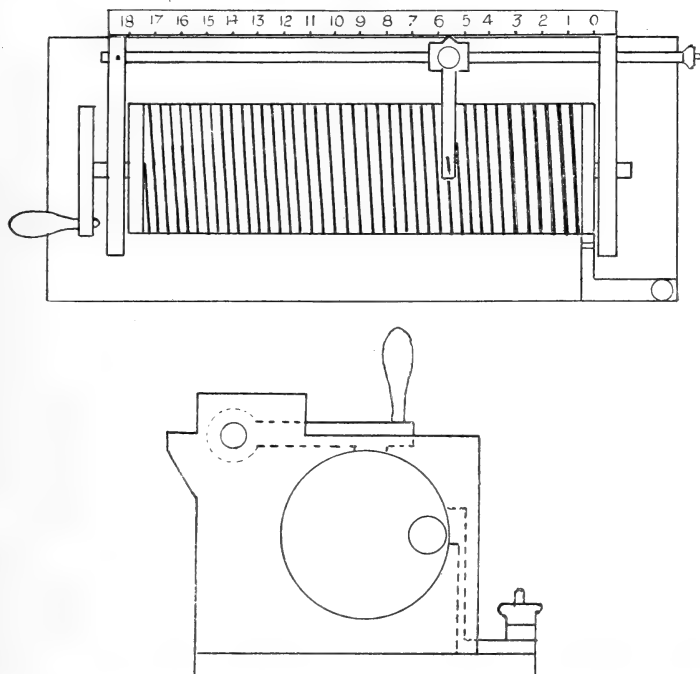

A spring presses against one of the brass end plates of the cylinder and carries a terminal. The sliding bar can be moved along to any position, its setting being determined by a scale, and the amount of inductance included between the two terminals can therefore be varied. The sliding bar can be lifted and moved quickly from one position to another, or moved slowly by turning the cylinder, in which case a gradual variation of inductance takes place.

The inductance of the whole spiral was measured by the telephone-buzzer-bridge method, and found to be 227,000 cms., and it was also measured for every 5 or 10 turns and found to be as shown in Table IV.

The value of the inductance predetermined by the formula above is 246,000 cms. for 100 turns, thus showing about nine per cent. excess over the real value. The above-mentioned formula cannot of course be applied to the case of a spiral having such a small dimension ratio as 4.5 : 1. The scale of

the instrument has been divided to read in microhenrys directly.

TABLE IV.

| No. of turns of wire. | Inductance in cms. | No. of turns of wire. | Inductance in cms. |
|-----------------------|--------------------|-----------------------|--------------------|
| 0 | 0 | 60 | 124,000 |
| 10 | 10,000 | 70 | 148,000 |
| 20 | 28,000 | 80 | 172,000 |
| 30 | 50,000 | 90 | 196,000 |
| 40 | 75,000 | 100 | 220,000 |
| 50 | 100,000 | Total | 227,000 |

The above observations have been set out in a curve (see fig. 3).

Fig. 3.

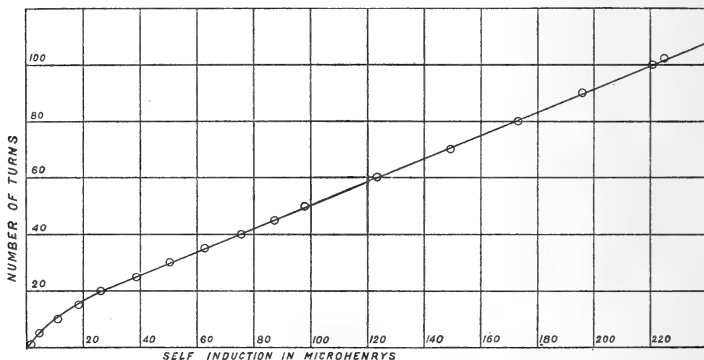

Such a graduated standard of inductance is useful in tuning wireless telegraph-circuits and in experiments on resonance.

By the above described method the measurement of inductances, even as small as 2 or 3 microhenrys, is reduced to an extremely simple straightforward method, capable of being carried out without any special appliances, other than those found in every testing-room and laboratory. By its aid inductance as small as 10 microhenrys can be measured with an accuracy of about 5 per cent., and inductances of the order of a millihenry with an accuracy of at least 1 per cent.

A good method of constructing a small inductance of known value is to stretch two round wires of diameter d cms. parallel to each other at a distance D cms. apart. If these are short-circuited at the far end by a cross bar, first at one

place and then at another nearer place closer by a distance l cms., then the difference of the inductances measured in the two cases has a value L such that;

$$L = 2l \left\{ 4.606 \log_{10} \frac{2D}{d} + \frac{1}{2} \right\} \text{ cms.}$$

This formula is easily derived from one given by Maxwell. It is a simple matter to obtain in this manner an inductance having a value say of 30,000 cms., and by its aid to test methods of measurement.

By the use of a long solenoid having an inductance pre-determined by the rule given above, the method can be used for the determination of small capacities of the order of a thousandth of a microfarad. It is to be hoped, therefore, that in future those who describe experiments or appliances such as wireless telegraphy arrangements in which such small capacities or inductances are used, will cease from the practice of speaking of jars with so many "square inches or square centimetres of coated surface," and take the slight trouble to measure and record the capacity and inductances, and in this way afford the means of testing theories of the operation of the appliances.

It can hardly be said that the practical problem of measuring with great accuracy very small inductances of the order of 1 microhenry or less has been satisfactorily solved.

Probably in the case of inductances of very low resistance the best method to adopt would be to measure the fall of potential down the conductor first, with a continuous current, and then with a high-frequency sine form alternating current. Professor W. Stroud and Mr. J. H. Oates recently described a bridge method employing alternating currents, which they stated could be employed for the measurement of very small inductances*.

LXV. *On a Hot-Wire Ammeter for the Measurement of very small Alternating Currents.* By J. A. FLEMING, D.Sc., F.R.S., Professor of Electrical Engineering in University College, London†.

THERE are many occasions on which it becomes necessary to measure a small alternating current of the order of one-hundredth of an ampere.

In taking the magnetizing currents of small transformers

* See Prof. W. Stroud and Mr. J. H. Oates on the "Application of Alternating Currents to the Calibration of Capacities and Inductances," *Phil. Mag.* ser. 6, vol. vi. p. 707 (1903).

† Communicated by the Physical Society: read March 25, 1904.

of one kilowatt size or less for the determination of the power-factor on the high-tension side, say, at 2000 volts, the magnetizing current to be measured may be at most about 0.02 of an ampere, or less in proportion to the size of the transformer.

The capacity of a small condenser or short length of cable or wireless telegraph aerial can be measured by means of a simple harmonic electromotive force, if we have the means of measuring a small alternating current and a high voltage. For if a simple harmonic electromotive force of frequency $n=2\pi/p$, and R.M.S. value V , is applied to a condenser of capacity C microfarads, then the alternating current (R.M.S. value) flowing into it has a value of $CpV/10^6$ amperes, *provided there is no sensible resonance*.

If the frequency is about 80 so that $p=500$ and if $V=2000$ volts, then a capacity as small as $1/500$ of a microfarad can be measured in this manner, provided we have the means of measuring the voltage V and an alternating current of the above-named magnitude. This can of course be done by any form of electro-dynamometer adapted for measuring very small currents, but the hot-wire ammeter here described is much simpler to construct.

The following form of hot-wire ammeter can be so made as to measure currents as small as two milliamperes, and is easily calibrated at the time of using it.

The ammeter consists of a wooden box (A B, see fig. 1) 104 cms. in length, 8 cms. in height, and 6 cms. in width.

Fig. 1.

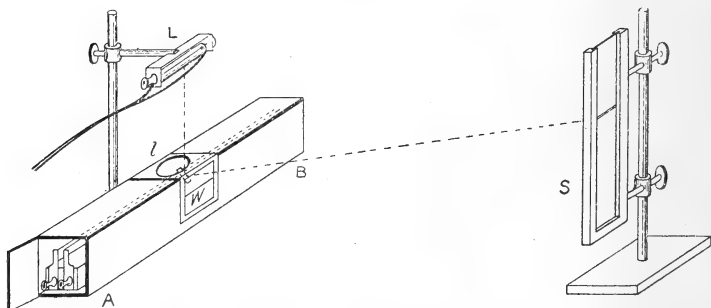

The top of this box opens on hinges, and in the centre is fixed an achromatic convex lens l having a focal length of 10 cms. The front of the box is cut down to form a window, W , which is glazed with a sheet of thin transparent mica (see fig. 1). In the box is fixed a square rod of well-seasoned pine, a metre in length and 2.5 cms. in width and breadth. To each end

of this rod are fixed two small brass uprights to which terminal screws are attached and also small spring pieces of brass, *p p*, which are pressed in by screws passing through the uprights (see figs. 1 and 2).

To these springs at each end of the rod are attached fine wires, either of pure silver or of some high resistance alloy, such as constantan, platinoid, &c., according to the use to which the instrument is to be placed.

In the instrument I have already constructed, these wires are of platinoid, the length of the wires being one metre and the diameter 0.05 of a millimetre. The distance apart of these wires is about 5 millimetres. The extremities of these wires are soldered to the two spring pieces at the ends of the wooden rod, and the tension of these wires can be adjusted by means of the screws passing through the small uprights and pressing against the spring pieces.

To the centre of the wooden rod carrying the above-mentioned fine wires are fastened two very delicate spiral springs, *s*, which have their other ends looped over the long straight wires. These spiral springs are made of extremely fine platinoid wire, and they serve to keep the ammeter wires tight (see fig. 2).

Fig. 2.

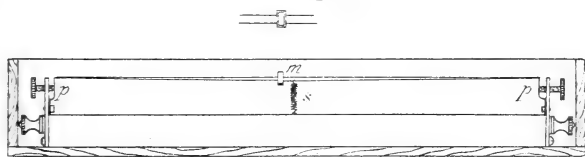

If one of the wires is heated by passing a current through it, it sags down slightly. This sag is indicated in the following manner:—The two wires are embraced by an exceedingly small loop of paper *m* made from a strip of paper a couple of millimetres in width and about 12 or 15 millimetres in length.

To this loop of paper is attached with a touch of shellac a fragment of silvered microscopic glass about a couple of millimetres in width and 5 millimetres in length.

The tension of one of the wires is so adjusted that when no current is passing through either of them one wire sags more than the other, and this little loop of paper and its attached mirror sets itself at an angle of about 45 degrees to the horizontal. This is attained by slightly relaxing the tension on one of the wires. Upon the lid of the containing box is carried an incandescent lamp, having a straight or horseshoe-shaped filament, and in front of the box is placed (see fig. 1)

a vertical strip of ground glass S, carried in a brass grooved frame which can be adjusted to any height on a vertical metal rod. The height of the incandescent lamp is so adjusted that the lens forms a clear image of the filament or of one leg of the filament upon the ground glass in the form of a horizontal line of light. With a good lens this image can be made very sharp. The lens actually used was the objective of an old opera-glass. A hood of metal or asbestos placed over the lamp prevents the direct rays of the lamp falling on the ground-glass screen. The screen can be conveniently placed about a metre from the wire box.

If, then, a small current is passed through the slacker of the two measuring wires, its sag will increase and the small mirror attached to the two wires will be tilted, and the image of the filament on the ground glass will move down, but return again to its original zero, as soon as the current is removed.

As a preliminary step, both the wires must be aged by sending intermittently a small current through them for a considerable time, this current being continually interrupted.

In the instrument actually made, the platinoid wires have a resistance of about 168 ohms each; hence, if an electromotive force of 2 volts is applied to the ends of the wires, a current of about $1/84$ of an ampere passes through them.

The instrument is calibrated in the following manner:—A secondary cell having a measured electromotive force, say, of about 2 volts, is connected in series with one of the working wires through a resistance-box of the usual plug pattern. By varying this resistance, different currents are passed through the wire and the position of the spot of light on the screen corresponding to the different currents is noted.

If the wire employed is of platinoid or of constantan, its resistance will not be altered appreciably by different small currents passed through it, and hence the resistance of the wire can be determined once for all, with a sufficient degree of approximation for practical purposes, by means of a potentiometer. When this has once been done, a few observations taken with a cell of known electromotive force and a plug resistance-box used as above, enable the observer to mark off on the ground-glass strip with a pencil the position of the line of light for various known currents lying within a certain range. The strip of ground glass may then be removed and applied to a sheet of squared paper, and a curve plotted down showing the deflexions in terms of the actual currents. This curve proves to be a parabola (see fig. 3) because, if we plot the logarithms of the deflexions and the

logarithms of the currents, we have a straight line delineated, making an angle with the horizontal, the tangent of which is equal to 2. If, then, we replace the ground-glass screen in its original position and pass through the ammeter

Fig. 3.

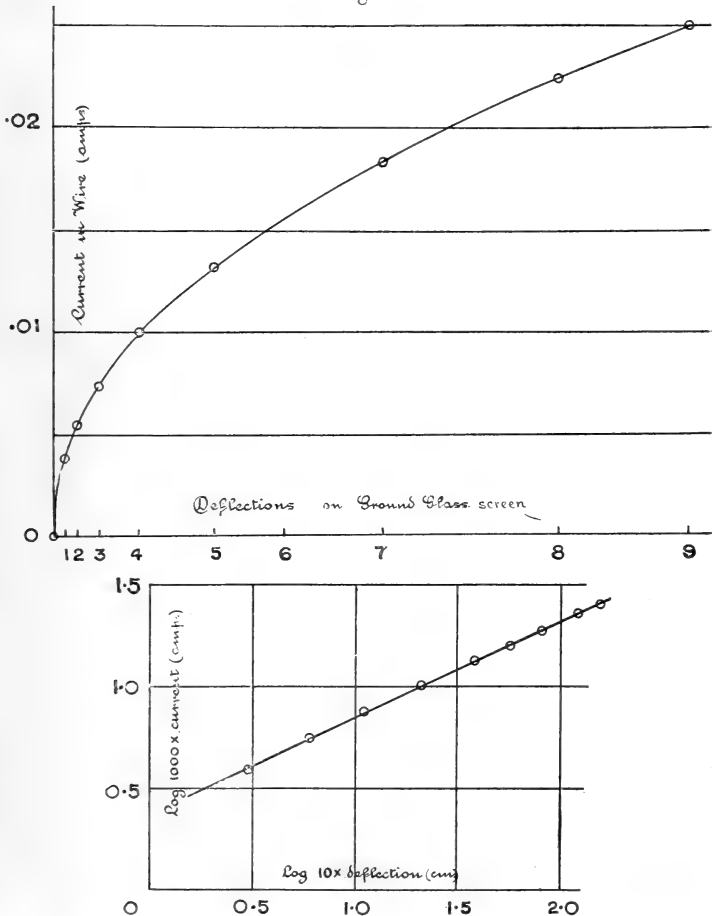

wire any current, continuous or alternating, lying within the range of the graduation, the resulting deflexion of the line of light on the screen can be at once marked off on the ground glass, and from the curve of calibration obtained as above described the ampere value of this current becomes at once known.

In the instrument actually used the deflexion of the line

of light on the scale placed at a distance of about 80 cms. from the mirror, produced by an application of two volts to the wire, is about 3 centimetres, and 4 volts produce about 12 centimetres deflexion: hence, current of about $1/100$ of an ampere or 10 milliamperes produces a deflexion which can be accurately read to within 2 or 3 per cent., and a current of as small as 5 milliamperes thus can be measured.

The particular class of wire with which the instrument should be strung depends on the uses to which it is to be put. If the object is to read a current of as small a value as possible, then the wire must be as fine as possible and made of a material of high specific resistance, such as constantan.

Messrs. Hartmann & Braun of Frankfurt have recently given attention to the production of very fine wires drawn from different pure metals and alloys, and they are able to furnish wires of pure metals and high-resistance alloys drawn down to diameters varying between 0.05 mm. and 0.02 mm. The resistance of a constantan wire of the latter size per metre is about 1350 ohms, whilst a wire of pure silver of the larger size has a resistance of only 8 ohms per metre.

The sag of the wire used in the above described instrument depends essentially upon its temperature, and its temperature depends upon the rate at which energy is being expended in it, per unit of its surface. Accordingly, for the measurement of the smallest currents the wires must be of high-resistance material and as small as possible in diameter, whilst for the measurement of small voltages the wire must be made of a material like silver with high conductivity.

The resistance R of the ammeter wire corresponding to different currents A through it can be determined as follows:—The ammeter wire is joined in series with a plug-resistance R_1 , and also with a constant resistance R_2 which may be either 20 or 40 ohms.

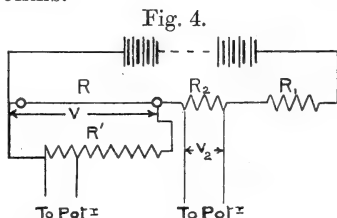

The ammeter wire is also shunted by a divided resistance R' (see fig. 4), and from a section of this resistance and from the terminals of the resistance R_2 wires are taken to a potentiometer. A battery of 100 volts is connected up, so as to

send a small current through the ammeter wire, and this is adjusted until the terminal potential-difference of the ends of the ammeter wire is either 2, 4, or 6 volts as required. Let this last potential-difference be called V , and the P.D. down the resistance R_2 be called V_2 . Also let the resistance of the ammeter wire under the working circumstances be R . Then V/R is the current through the ammeter wire and V/R' the current through the divided resistance, and the sum $V/R + V/R'$ is equal to V_2/R_2 which is measured. Hence R can be determined corresponding to various values of V/R .

In the case of the actual calibration of the hot-wire ammeter already made, the resistance R' was 497 ohms, and hence the resistance R was obtained from the equation

$$\frac{V}{R} + \frac{V}{497} = \frac{V_2}{R_2}.$$

The following table gives the observed values of V , V_2 , R_2 , and R_1 , and the calculated values of the wire-resistance R and current A for the two platinoid wires (1) and (2) in the instrument already made.

TABLE I.

| | Wire (1). | | | Wire (2). | | |
|---------------------------|-----------|--------|--------|-----------|--------|--------|
| | | | | | | |
| V (in volts) | 2 | 4 | 6 | 2 | 4 | 6 |
| V_2 " | 0.639 | 1.277 | 0.9575 | 0.634 | 1.2675 | 0.9500 |
| R_1 (in ohms) | 6372 | 3191 | 2070 | 6415 | 3212 | 2088 |
| R_2 " | 40 | 40 | 20 | 40 | 40 | 20 |
| V_2/R_2 (in amperes) .. | 0.0159 | 0.0319 | 0.0478 | 0.0158 | 0.0317 | 0.0475 |
| A " | 0.0119 | 0.0238 | 0.0357 | 0.0118 | 0.0236 | 0.0354 |
| R (calc.) in ohms ... | 168.3 | 167.8 | 167.8 | 169.8 | 169.1 | 169.3 |

Between the above limits of current 0.01 and 0.04 ampere the resistance of wire (1) may be taken as 168 ohms and that of wire (2) as 169.4 ohms.

As an instance of the use of this ammeter and also of the precautions necessary in using it, the following measurements of the capacity of leyden-jars taken with it may be given.

Two leyden-jars were employed which will be called respectively no. 1 and no. 2. A small alternating current transformer having a transformation ratio of 1 to 118 was employed to step up the voltage of an alternator having an electromotive force curve of nearly simple sine form.

The jar to be measured was connected across the high-tension terminals of the transformer, and the hot-wire

ammeter inserted so as to measure the alternating current taken by the jar. The high and low tension voltages were measured by Kelvin electrostatic voltmeters. The capacity of the jar or jars was calculated from the condenser-current A , as read on the ammeter from the expression $A = C_p V / 106$, where V is the reading of the electrostatic voltmeter across the high-tension terminals of the transformer. The following Table II. gives the observations:—

TABLE II.

| Condenser. | Terminal Voltages of Transformer. | | Frequency used = n . | $p = 2\pi n$. | Observed Condenser Current = A . | Calculated Capacity in Microfarads = C . |
|------------------------------|-----------------------------------|--------|------------------------|----------------|------------------------------------|--|
| | L.T. | H.T. | | | | |
| Jar no. 1 ... | 97.5 | 13,750 | 73.7 | 463 | 0.0112 | 0.00176 |
| | 101.8 | 14,400 | 76.7 | 483 | 0.0121 | 0.00174 |
| Jar no. 2 ... | 97.0 | 13,650 | 73.7 | 463 | 0.0107 | 0.00169 |
| | 101.7 | 14,250 | 76.7 | 483 | 0.0110 | 0.00159 |
| Jars nos. 1 & 2 in parallel. | 97.0 | 15,300 | 73.7 | 462 | 0.0204 | 0.00287 |
| | 101.8 | 16,350 | 76.7 | 483 | 0.0226 | 0.00285 |

The capacities of the jars as measured by the rotating commutator described by the author and Mr. Clinton (see Proc. Phys. Soc. Lond. vol. xviii. p. 386, also Phil. Mag. May 1903, p. 493) were as follows:—Jar no. 1 = 0.00154 mfd., Jar no. 2 = 0.00124 mfd., Jars nos. 1 & 2 in parallel = 0.0028 mfd.

Hence it will be seen that the hot-wire ammeter gave a capacity in close approximation to that given by the commutator method for the joint capacity of the jars, but that there was an apparent increase of capacity when the jars were measured separately by the ammeter method. This is clearly due to resonance. The changes in the transformation ratio of the transformer due to the addition of the capacity are apparent from the figures in Table II. Hence, in using this method, the precaution must always be taken of having sufficiently large capacity in parallel with the one to be measured to destroy resonance, but the current into the capacity, which it is desired to measure, is alone measured by the hot-wire ammeter.

In connexion with this subject, I have had occasion to notice the manner in which even the small capacity of a Kelvin high-tension voltmeter will, in conjunction with the inductance of some transformers of high inductance, produce

a marked alteration of the change ratio of transformation, by reason of resonance, when the transformer is used at certain voltages. The small capacity of a high-tension electrostatic voltmeter across the high-tension terminals of a transformer, will, as shown by the figures in Table III. below, sensibly affect the change-ratio.

The transformer tested was worked at a frequency of about 80, and the voltage of the high-tension and low-tension terminals measured by electrostatic voltmeters over a certain range of voltage, no other load being on the high-tension side.

The change-ratio is far from constant, as shown by the figures in Table III., and this is clearly due to the resonance produced by the capacity of the high-tension voltmeter. Under such circumstances, when brush-discharges are taking place in the interior of the voltmeter it possesses a spurious and increased capacity, and hence, in using electrostatic voltmeters, a single reading should not be accepted too readily as giving the change-ratio of a transformer.

TABLE III.

| Transformer Terminal Voltages measured by Kelvin Electrostatic Voltmeters. | | Transformation Ratio. Frequency = 80. |
|--|------|---|
| H.T. | L.T. | |
| 16,350 | 515 | 31·7 : 1 |
| 16,650 | 503 | 33·1 : 1 |
| 16,850 | 460 | 36·6 : 1 |
| 16,900 | 435 | 38·8 : 1 |
| 16,750 | 415 | 40·3 : 1 |
| 15,000 | 360 | 41·6 : 1 |
| 12,000 | 303 | 39·6 : 1 |

As an instance of the application of this hot-wire ammeter in measuring the magnetizing currents of small transformers, the following figures may be given:—A transformer of 1 k.w. size had the hot-wire ammeter above described placed in series with its primary circuit, and as a check and test of accuracy a known high resistance R of 3450 ohms was also put in series with the hot-wire ammeter, and a Kelvin electrostatic voltmeter was connected to the terminals of this high resistance. The following readings were then taken:—The voltage V at the primary terminals of the transformer, the voltage V' at the terminals of the high resistance R,

and the deflexion of the hot-wire ammeter, were found to be as follows :—

$$R=3450 \text{ ohms, } V'=114.5 \text{ volts. } V=2000 \text{ volts.}$$

Hence the magnetizing current of the transformer was $114.5/3450=0.033$ ampere.

The hot-wire ammeter was calibrated as above described, and the reading of the magnetizing current taken with it was found to be 0.034 of an ampere. Hence the value of the same current as determined by the electrostatic voltmeter, and the high resistance by the ratio V/R and that determined by the hot-wire instrument were in very fair agreement.

The hot-wire ammeter has, however, the advantage over the high-resistance and electrostatic voltmeter method, that it is easier to calibrate and also involves a less drop in voltage, the more so as the current to be measured is smaller.

This form of hot-wire ammeter has many uses. It can be employed as a relay operated by small alternating currents to set in action appliances only workable with continuous currents. In this case the sagging wire is made to drop a steel needle on to a mercury surface and thus close the circuit required.

As a research instrument, it may be useful because it appears that the deflexion of the ray of light created by the sag of the wire within useful limits of working is almost exactly proportional to the square of the current passing through the wire, and hence standardization is effected by passing one current of known value through the instrument, whilst if a suitable wire is employed, it can be calibrated with sufficient accuracy for most technical purposes by applying to the ends of the ammeter wire 2, 4, or 6 volts obtained from 1, 2, or 3 secondary cells, if need be a suitable resistance being interposed. For measuring alternating currents of a few milliamperes for electromedical purposes, it should also be useful.

When currents larger than a few milliamperes have to be measured, it can easily be accomplished by the same fine wire ammeter, by shunting the terminals with a resistance either equal to or one-half, one-third, or one- n th of that of the wire resistance. Thus, if the above described ammeter is shunted with 168 ohms, or with 84 ohms, or 42 ohms, then the ammeter readings have to be multiplied by 2, by 3, or by 5, to evaluate the whole current, and if shunted by a shunt of one- n th of its own resistance, then the readings have to be multiplied by $n+1$.

The above described ammeter has been skilfully made for me by my assistant, Mr. A. Blok, who has also carried out for me the measurements described.

LXVI. *Notices respecting New Books.*

A Course of Modern Analysis. By E. T. WHITTAKER, M.A.
Cambridge University Press. 1902.

THE extended title of this exceptionally excellent work is "An Introduction to the General Theory of Infinite Series and of Analytic Functions; with an account of the principal Transcendental Functions." When it is stated further that the functions discussed are the Gamma, the Legendre, the Hypergeometric, the Bessel, and the Elliptic Functions, the general scope of the book will be understood. The author has shown great discrimination and reserve in his treatment; for it is only too easy in a subject of this kind to deviate into side issues so that the student has the vaguest ideas as to the general aim of his wanderings. Here, however, we find in the 170 pages which constitute Part I. a lucid, compact, and yet sufficiently detailed development of the theory of functions in a form necessary and sufficient—to use the familiar phrase—for a sound discussion of the important special types of functions treated of in Part II. Each chapter is enriched with an appropriate set of examples or exercises, many of which are important theorems associated with the names of the discoverers. Had the majority of these been treated at length as part of the text—as is the custom with some authors—the book could easily have been made of formidable dimensions. In this connexion especially the author has shown great wisdom. The working student will probably find it profitable to read the text carefully through so as to get a general view of the subject, and then turn back and familiarize himself with the methods by working a selection of the exercises out in detail. The value of the book is further enhanced by a series of short historic notes and by constant references to important memoirs by the many distinguished mathematicians who have helped to develop the modern theory of functions.

Mathematical Crystallography and the Theory of Groups of Movements.
By HAROLD HILTON, M.A. Oxford: At the Clarendon Press.
1903.

MR. HILTON is to be congratulated on having made an important contribution to our mathematical literature. Crystallography is a science which in its practical aspects concerns the mineralogist and the chemist; but very few of those who are familiar with the forms and classification of crystals will find Mr. Hilton's pages easy reading. After a discussion of the geometry of crystals and the various laws recognized by crystallographers, the author enters upon his real work, namely, the complete mathematical discussion and classification of the various groups of movements possible under the limitations suggested by the laws of crystals. The book is in fact a treatise on the theory of a set of finite groups of a special type, involving certain operations of translation, reflexion, and

rotation. The theory of the point-groups is worked out in detail in Chapters IV., V., and VI., and it is proved that there are 32, and only 32, finite groups of movements consistent with the law of rational indices. Two brief chapters on the relations between crystalline symmetry and physical properties and on the growth of crystals complete Part I.; and the rest of the book is devoted to the structure theory of crystalline matter. There is thus presented for the first time to English readers in connected form the geometrical theory of crystal structure. The 230 space groups capable of representing crystalline form are worked out in sufficient detail, and are profusely illustrated by diagrams drawn on the lines suggested by Federow. Mr. Hilton lays no claim to originality, but aims at reproducing mainly the system developed by Schoenflies. He has, however, laid other writers under contribution; and his own powers are in evidence in the clearness of exposition and compactness of demonstration. The argument is frequently very condensed, and every line demands the closest attention on the part of the reader if he wishes really to follow the demonstration. There is a steady strain upon the geometrical and kinematical imagination, a strain which comparatively few of those who are practically interested in crystallographic questions will care to undergo. But the mathematical student interested in the theory of groups will be greatly benefited by a careful study of Mr. Hilton's pages. Towards the close of the book reference is made to dynamic possibilities of crystalline structure as distinguished from geometrical possibilities. Here, of course, we encounter questions of molecular stability which can hardly at present be stated, far less solved.

Thermodynamics and Chemistry: A non-Mathematical Treatise for Chemists and Students of Chemistry. By P. DUHEM, Professor of Theoretical Physics at the University of Bordeaux. Authorized translation by George K. Burgess. New York: John Wiley & Sons. 1903. Pp. xxi+445.

A LARGE number of chemists and students of chemistry find it difficult, if not impossible, to follow the modern developments of the theory of chemical equilibria, by reason of their insufficient knowledge of the mathematical processes whose aid must be invoked in a thorough discussion of the subject. To such the translation of Professor Duhem's book will be a welcome addition to their scientific library, as the author deals with the subject without the use of analysis. Such a method must necessarily have its shortcomings, and the reader must now and then be asked to take certain things for granted which could readily be demonstrated were the use of mathematical analysis not forbidden. On the other hand, the non-mathematical reader has the satisfaction of knowing that, having consented to take certain statements on the authority of the mathematicians, he will not, in this book, have to wade through pages of, to him, unintelligible symbols.

The first six chapters of the book deal with work and energy, quantity of heat and internal energy, chemical calorimetry, chemical equilibrium and the reversible transformation, the principles of chemical statics and the phase rule. Chapter vii. contains a large number of applications of the phase rule to multivariant systems. The succeeding chapters, viii. to xii., are concerned with mono- and bi-variant systems. Chapters xiii. and xiv. deal with mixed crystals and metallic alloys; chapter xv. with the chemical mechanics of perfect gases; chapter xvii. with capillary actions and apparent false equilibria; chapter xviii. with genuine false equilibria; chapter xix. with unequally heated spaces; and the concluding chapter xx. with chemical dynamics and explosions.

A noticeable and highly praiseworthy feature of the book is the very large number of illustrative examples. Especially is this feature valuable in the earlier chapters of the book, devoted to general theoretical considerations, as it enables the reader to form a much more accurate and vivid idea of the subject under discussion than would otherwise be possible.

Considering the valuable service which Dr. Burgess has rendered to English-speaking students by translating this work, it may seem ungrateful to criticise the translation adversely. Yet no one could possibly mistake the rendering for an original work in English. French idioms abound. These may be overlooked by an indulgent reader, but when it comes to the wholesale importation of French words without any attempt at translation, the reader's patience cannot but be sorely tried. What, for example, are we to make of the following:—"it is shown in mechanics by methods which we cannot *expose* here . . ." ? Or why does the author speak of a *renversible* change (without even italicising the term)? To pass to another matter, we consider that a modern writer on chemical theory has no more right to speak of vapour-*tension*, meaning pressure, than a modern writer on dynamics has to apply the term "power" to a force.

The revision of the proof-sheets must have been carried out very carelessly, as there are numerous instances of missing letters. For this, however, the publishers are to blame.

Fractional Distillation. By SYDNEY YOUNG, D.Sc., F.R.S., Professor of Chemistry in University College, Bristol. With 72 illustrations. London: Macmillan & Co., Ltd. 1903. Pp. xii + 284.

PROFESSOR SYDNEY YOUNG'S name is so well known in connexion with the numerous difficult and highly important physico-chemical researches carried out by him, that the present volume, which contains a vast amount of information, some of which has never been published elsewhere, is sure to meet with a warm welcome from the increasing band of workers on the borderland of physics and chemistry. The book is remarkable alike for the logical arrangement of the subject-matter and the lucid and

easy style of exposition. The first chapter is devoted to a careful account of the construction of various forms of still, and contains many useful practical hints. The next few chapters deal with the boiling-point of a pure liquid, the vapour-pressures and boiling-points of mixed liquids, and the composition of the liquid and vapour phases (considered both experimentally and theoretically). In chapter vii. we have detailed directions for carrying out a fractional distillation. The next two chapters deal with the theoretical relations between the weight and composition of the distillate, and the relation between the boiling-points of residue and distillate. Chapters x.-xii. are devoted to a very full account of modifications of the still-head; and in chapter xiii. the subject of continuous distillation is dealt with. Fractional distillation with an improved still-head is then taken up in chapter xiv., and distillation on the manufacturing scale in chapter xv. The important subject of fractional distillation as a method of quantitative analysis is next dealt with. In chapter xvii. we have an account of methods by which the composition of mixtures of constant boiling-point may be determined; and in chapter xviii. an account of the indirect method of separating the components of a mixture of constant boiling-point. The concluding chapter is devoted to general remarks on the subject. An Appendix containing tables of temperature corrections for the height of the barometer, and a very copious index form useful additions. A highly commendable feature of the book consists in the numerous bibliographical references given at the end of each chapter.

LXVII. *Intelligence and Miscellaneous Articles.*

AN INSTRUMENT FOR DRAWING CONICS.

To the Editors of the Philosophical Magazine.

Trinity College, Dublin,
14th April, 1904.

GENTLEMEN,

WITH reference to my article in the March number of the Philosophical Magazine, I wish to state that I have since received a paper in the Russian language by Prof. Prince Kougoushef of Warsaw, which was published in 1899, and is a description of a 'new conicograph' which is evidently the same as that which forms the subject of my paper. Although my instrument was constructed in 1895 and shown at the time to several scientific gentlemen connected with Trinity College, Dublin, I did not previously publish any account of it, and consequently Prince Kougoushef is fully entitled to claim priority.

In making this acknowledgment I desire to express my regret that, at the time of writing my paper, I was unaware that it had been anticipated.

I am, Gentlemen,
Yours faithfully,
J. R. COTTER.

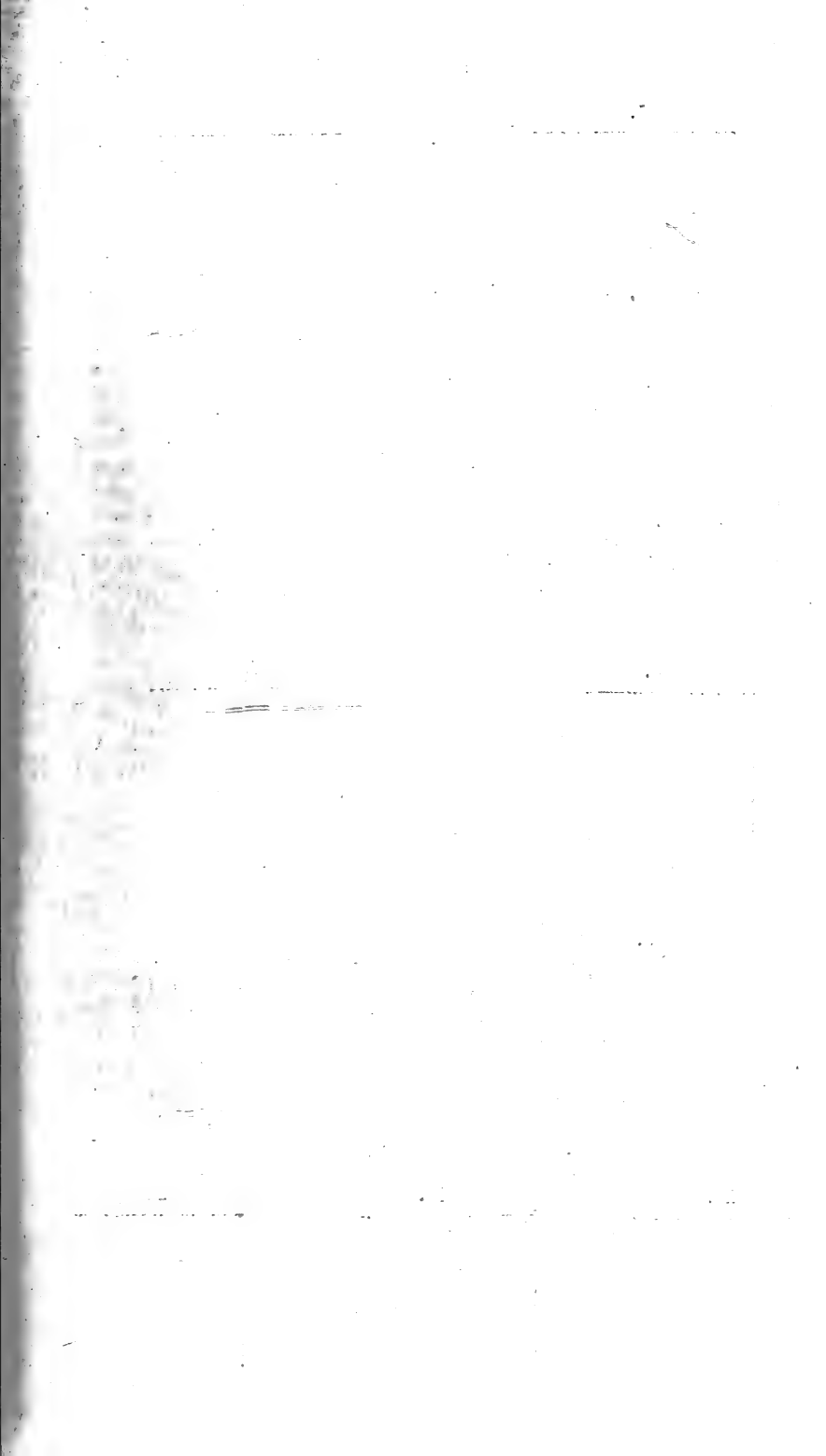

1.



2.



3.

4.

5.

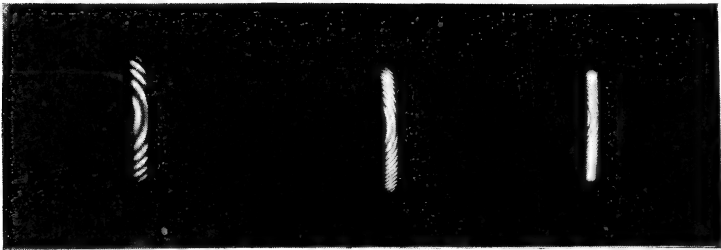

6.

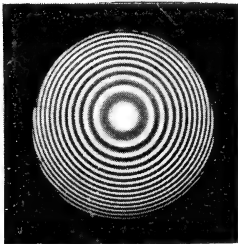

7.

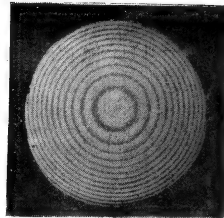

8.

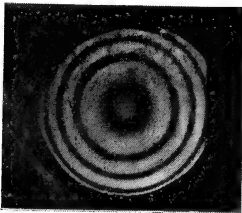

9.

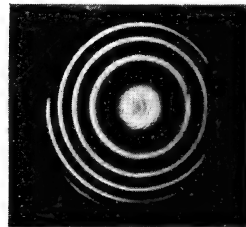

10.

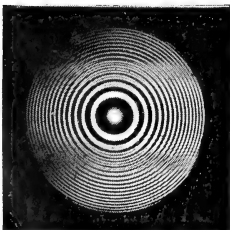

11.

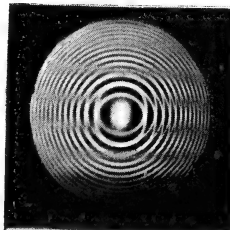

12.

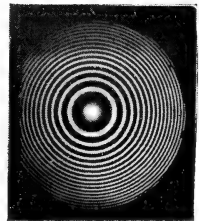

13.

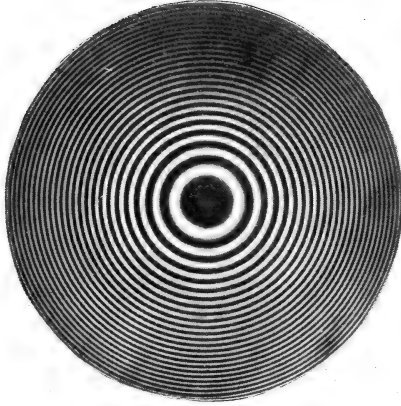

14.

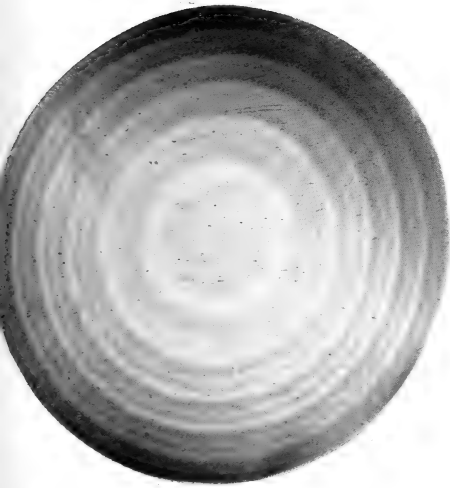

15.

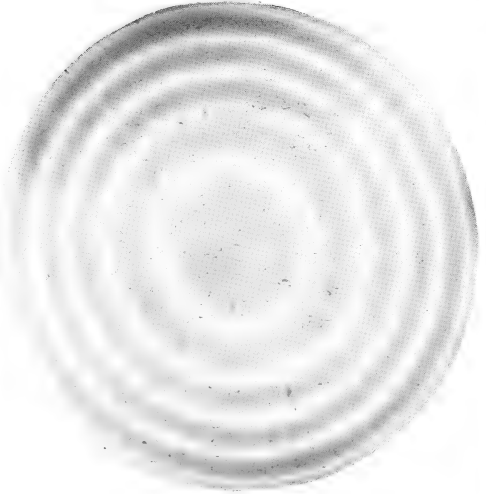

16.

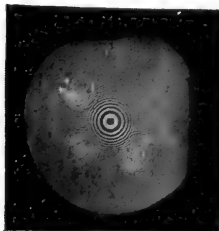



THE
LONDON, EDINBURGH, AND DUBLIN
PHILOSOPHICAL MAGAZINE
AND
JOURNAL OF SCIENCE.

[SIXTH SERIES.]

JUNE 1904.

LXVIII. *On Deep-water Two-dimensional Waves produced by any given Initiating Disturbance.* By LORD KELVIN*.

§ 1. CONSIDER frictionless water in a straight canal, infinitely long and infinitely deep, with vertical sides. Let it be disturbed from rest by any change of pressure on the surface, uniform in every line perpendicular to the plain sides, and left to itself under constant air pressure. It is required to find the displacement and velocity of every particle of the water at any future time. Our initial condition will be fully specified by a given normal component velocity, and a normal component displacement, at every part of the surface.

§ 2. Taking O, any point at a distance h above the undisturbed water level, draw OX parallel to the length of the canal, and OZ vertically downwards. Let ξ , ζ be the displacement-components of any particle of the water whose undisturbed position is (x, z) . We suppose the disturbance infinitesimal; by which we mean that the change of distance between any two particles of water is infinitely small in comparison with their undisturbed distance; and the line joining them experiences changes of direction which are infinitely small in comparison with the radian. Water being assumed frictionless, its motion, started primarily from rest by pressure applied to the free surface, is essentially irrotational. Hence we have

$$\xi = \frac{d}{dx} \phi(x, z, t); \quad \zeta = \frac{d}{dz} \phi(x, z, t); \quad \dot{\xi} = \frac{d}{dx} \dot{\phi}; \quad \dot{\zeta} = \frac{d}{dz} \dot{\phi}. \quad (1);$$

where $\phi(x, z, t)$, or ϕ , as we may write it for brevity when

* From the Proceedings of the Royal Society of Edinburgh for Feb. 1, 1904. Communicated by the Author.

convenient, is a function of the variables which may be called the displacement-potential; and $\dot{\phi}(x, z, t)$ is what is commonly called the velocity-potential. Thus a knowledge of the function ϕ , for all values of x, z, t , completely defines the displacement and the velocity of the fluid. And, by the fundamentals of hydrokinetics, a knowledge of ϕ for every point of the free surface suffices to determine its value throughout the water; in virtue of the equation

$$\frac{d^2\phi}{dx^2} + \frac{d^2\phi}{dz^2} = 0 \dots \dots \dots (2).$$

The motion being infinitesimal, and the density being taken as unity, another application of the fundamental hydrokinetics shows that, as found by Cauchy and Poisson,

$$p - \Pi = g(z - h + \zeta) - \frac{d^2\phi}{dt^2} = g(z - h) + g \frac{d\phi}{dz} - \frac{d^2\phi}{dt^2} \dots (3);$$

where g denotes gravity; Π the uniform atmospheric pressure on the free surface; and p the pressure at the point $(x, z + \zeta)$ within the fluid.

§ 3. To apply (3) to the wave-surface, put in it, $z = h$; it gives

$$g \left(\frac{d\phi}{dz} \right)_{z=h} = \left(\frac{d^2\phi}{dt^2} \right)_{z=h} \dots \dots \dots (4);$$

and therefore if we could find a solution of this equation for all values of z , with (2) satisfied, we should have a solution of our present problem. Now we can find such a solution; by a curiously altered application of Fourier's celebrated solution

$$\left[(t + c)^{-\frac{1}{2}} e^{\frac{-x^2}{4k(t+c)}}, \text{ for } \frac{dv}{dt} = k \frac{d^2v}{dx^2}, \right]$$

his equation for the linear conduction of heat. Change $t + c, x, k$, into $z + \iota x, t, g^{-1}$ respectively:—we have (4), and we see that a solution of it is

$$\frac{1}{\sqrt{(z + \iota x)}} e^{\frac{-gt^2}{4(z + \iota x)}} \dots \dots \dots (5);$$

which also satisfies (2) because any function of $z + \iota x$ satisfies (2) if ι denotes $\sqrt{-1}$. Hence if {RS} denotes a realization*

* A very easy way of effecting the realizations in (6) and (9) is by aid of De Moivre's theorem with, for one angle concerned in it, $\chi = \tan^{-1} c/z$; and another angle $= gt^2x/4(z^2 + x^2)$.

by taking half sum of what is written after it with $\pm u$, we have, as a real solution of (4) for our problem

$${}_1\phi(x, z, t) = \{RS\} \frac{1}{\sqrt{(z+ux)}} \epsilon^{\frac{-gt^2}{4(z+ux)}} \dots \dots (6),$$

$$= \frac{1}{\sqrt{2} \cdot \rho} \left[\sqrt{(\rho+z)} \cos \frac{gt^2 x}{4\rho^2} + \sqrt{(\rho-z)} \sin \frac{gt^2 x}{4\rho^2} \right] \epsilon^{\frac{-gt^2 z}{4\rho^2}} \left. \dots \dots \dots (7)^*, \right\}$$

where $\rho^2 = r^2 + x^2$

$$= \sqrt{\frac{1}{\rho}} \sin \left(\frac{gt^2 x}{4\rho^2} + \theta \right) \epsilon^{\frac{-gt^2 z}{\rho^2}} \left. \dots \dots \dots (8). \right\}$$

where $\theta = \tan^{-1} \sqrt{\frac{\rho+z}{\rho-z}}$

The sign of $\sqrt{(\rho-z)}$ changes when x passes through zero.

Going back now to (5), and denoting by {RD} the difference of its values for $\pm u$ divided by $2u$, we have another solution of our problem essentially different from (6), as follows

$${}_2\phi(x, z, t) = \{RD\} \frac{1}{\sqrt{(z+ux)}} \epsilon^{\frac{-gt^2}{4(z+ux)}} \dots \dots (9),$$

$$= \frac{1}{\sqrt{2} \cdot \rho} \left[\sqrt{(\rho+z)} \sin \frac{gt^2 x}{4\rho^2} - \sqrt{(\rho-z)} \cos \frac{gt^2 x}{4\rho^2} \right] \epsilon^{\frac{-gt^2 z}{4\rho^2}} \dots \dots (10),$$

$$= \sqrt{\frac{1}{\rho}} \sin \left(\frac{gt^2 x}{4\rho^2} + \theta - \frac{\pi}{2} \right) \epsilon^{\frac{-gt^2 z}{4\rho^2}} \dots \dots \dots (11).$$

§ 4. The annexed diagram, fig. 1, represents for $t=0$ the solutions ${}_2\phi$ and ${}_1\phi$ as functions of x , with $z=1$ for convenience in the drawing. The formulas which we find by taking $t=0$ in (7) $\times \sqrt{2}$ and $10 \times \sqrt{2}$ are

$${}_1\phi = \frac{\sqrt{[\sqrt{(x^2+z^2)}+z]}}{\sqrt{(x^2+z^2)}}; \quad {}_2\phi = \frac{\sqrt{[\sqrt{(x^2+z^2)}-z]}}{\sqrt{(x^2+z^2)}} \quad (12).$$

Before passing to the practical interpretation of our solutions, remark first that (12) contain full specifications of two distinct initiating disturbances; in each of which ϕ may be taken as a displacement-potential, or as a velocity-potential, or as a horizontal displacement-component or velocity, or as a vertical displacement-component or velocity. Thus we have really preparation for *sic* different cases of motion, of which we shall choose one, $-\zeta = \sqrt{2} \times (7)$, for detailed examination.

* This solution was given in the Proc. Roy. Soc. Edinb. Jan. 7, 1887, and Phil. Mag. Feb. 1887. It is quoted in App. C of "Baltimore Lectures," p. 531.

Fig. 1.

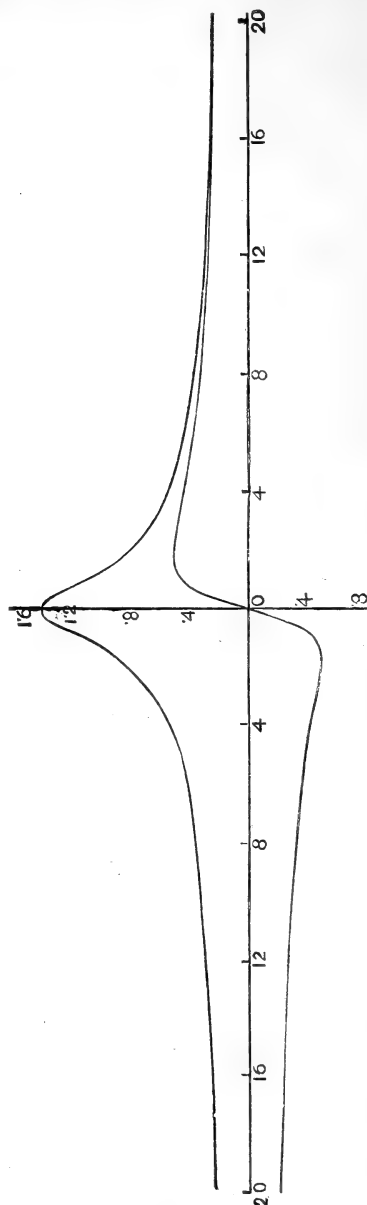

$t=0, z=1$. Abscissas represent time; ordinates $\sqrt{\frac{(\rho+z)}{\rho}}, \sqrt{\frac{(\rho-z)}{\rho}}$.

§ 5. Taking $z=h=1$, for the water surface, let the two curves of figure 1 represent initial *displacements*, (12), of the water surface, left to itself with the water everywhere at

rest. The displacements at any subsequent time t are expressed in real symbols by (7) (10) without the divisor $\sqrt{2}$, and by (8) (11) with a factor $\sqrt{2}$ introduced; either of which may be chosen according to convenience in calculation. One set has thus been calculated from (8), with $g=4$, and $z=1$, for six values of t ; $\cdot 5$, $1\cdot 5$, 2 , $2\cdot 5$, and 5 ; and for a sufficiently large number of values of x to represent the results by the curves shown in figs. 2 and 3. Except for the time $t=5$, each curve shows sufficiently all the most interesting characteristics of the figure of the water at the corresponding time. The curve for $t=5$ does not perceptibly leave the zero line at distances $x < 1\cdot 8$; but if we could see it, it would show us two and a half wavelets possessing very interesting characteristics; shown in the table of numbers, § 7 below, by which we see that several different curves with scales of ordinates magnified from one to one thousand, and to one million, and to ten thousand million, would be needed to exhibit them graphically.

§ 6. Looking to the curves for $t=0$ and $t=\frac{1}{2}$; we see that at first the water rises at all distances from the middle of the disturbance greater than $x=1\cdot 9$, and falls at less distances. And we see that the middle ($x=0$) remains a crest (or positive maximum) till a very short time before $t=\frac{1}{2}$, when it begins to be a hollow. A crest then comes into existence beside it and begins to travel outwards. On the third curve, $t=1$, we see this crest, travelled to a distance $x=1\cdot 7$, from the middle where it came into being; and on the fourth, fifth, sixth, seventh curves (figs. 1, 2) we see it got to distances $2\cdot 9$, $4\cdot 8$, $6\cdot 5$, 22 , at the times $1\frac{1}{2}$, 2 , $2\frac{1}{2}$, 5 . This crest travelling rightwards on our diagrams has its anterior slope very gradual down to the undisturbed level at $x=\infty$. Its posterior slope is much steeper; and ends at the bottom of the hollow in the middle of the disturbance, at times from $t=\frac{1}{2}$ to $t=1\frac{1}{2}$. At some time, which must be very soon after $t=1\frac{1}{2}$, this hollow begins to travel rightwards from the middle, followed by a fresh crest shed off from the middle. At $t=2$, the hollow has got as far as $x=\cdot 9$; at $t=2\frac{1}{2}$, and 5 , respectively, it has reached $x=1\cdot 75$ and $x=6\cdot 7$. Looking in imagination to the extension of our curves leftwards from the middle of the diagram, we find an exact counterpart of what we have been examining on the right. Thus we see an initial elevation, symmetrical on the two sides of a convex crest, of height $1\cdot 41$ above the undisturbed level, sinking in the middle and rising on the two flanks. The crest becomes less and less convex till it gets down to height $1\cdot 1$, when it becomes concave; and two equal and similar wave-crests are

shed off on the two sides, travelling away from it rightwards and leftwards with accelerated velocities, each remaining for ever convex. Thus we see the beginnings of two endless processions of waves travelling outwards in the two directions; originating as infinitesimal wavelets shed off on the two sides of the middle line. Each crest and each hollow travels with increasing velocity. Each wave-length, from crest to crest, or from hollow to hollow, becomes longer and longer as it advances outwards; all this according to law fully expressed in (8) of § 3 above.

§ 7. Here is now the table of numbers promised in § 5 above; it practically defines the forms and magnitudes of the two and a half wavelets, between $x=0$ and $x=2$, which the space-curve for $t=5$ (figs. 2 and 3) fails to show.

$$\rho^2 = x^2 + h^2; \quad h=1; \quad g=4; \quad t=5; \quad -\zeta = \sqrt{\frac{2}{\rho}} \sin\left(\frac{xt^2}{\rho^2} + \theta\right) e^{-\rho^2}.$$

| Col. 1. | Col. 2. | Col. 3. | Col. 4. | Col. 5. | Col. 6. | Col. 7. |
|---------|---------------------------|---|---|---|---------------------------|---|
| x . | $\sqrt{\frac{1}{\rho}}$. | $\sqrt{\frac{\rho+1}{2\rho}} = \sin \theta$. | Initial Elevation of Water-surface at Distance x . $\sin \theta \cdot \sqrt{\frac{2}{\rho}} = \zeta_0$. | $\sin\left(\frac{xt^2}{\rho^2} + \theta\right)$. | $e^{-\frac{1}{\rho^2}}$. | Elevation of Water-surface at Time t , and Distance x . $-\zeta$. |
| 0 | 1.4142 | 1.0000 | 1.4142 | 1.0000 | 10 ⁻¹⁰ .1357 | +10 ⁻¹⁰ .1965 |
| .05 | 1.4140 | .9997 | 1.4140 | .3434 | ..1478 | ..0717 |
| .064 | ... | ... | ... | 0 | ... | 0 |
| .10 | 1.410 | .9987 | 1.409 | -.7541 | ..1778 | -10 ⁻¹⁰ .1891 |
| .15 | 1.407 | .9972 | 1.403 | -.8997 | ..3066 | ..3882 |
| .20 | 1.401 | .9952 | 1.393 | -.0032 | ..3632 | ..0016 |
| .202 | ... | ... | ... | 0 | ... | 0 |
| .30 | 1.384 | .9894 | 1.370 | .8997 | ..1094 | +10 ⁻¹⁰ 1.362 |
| .363 | ... | ... | ... | 0 | ... | 0 |
| .40 | 1.362 | .9820 | 1.338 | -.5451 | ..4366 | -10 ⁻¹⁰ 3.243 |
| .60 | 1.309 | .9638 | 1.262 | -.2341 | ..103.9 | ..31.84 |
| .632 | ... | ... | ... | 0 | ... | 0 |
| .80 | 1.249 | .9437 | 1.179 | .7593 | 10 ⁻⁵ .02396 | +10 ⁻⁵ .0227 |
| 1.00 | 1.190 | .9239 | 1.099 | .8962 | ..2958 | ..3152 |
| 1.25 | 1.118 | .9015 | 1.007 | .6831 | ..5.793 | ..4.424 |
| 1.50 | 1.053 | .8817 | .9287 | .4923 | ..45.63 | ..23.67 |
| 1.517 | ... | ... | ... | 0 | ... | 0 |
| 1.75 | .9961 | .8651 | .8616 | -.6832 | ..212.5 | -10 ⁻⁵ .1446 |
| 2.00 | .9456 | .8506 | .8045 | -.9997 | ..848.2 | ..801.9 |
| 2.50 | .8612 | .8243 | .7142 | -.1633 | ..03180 | ..447.3 |
| 2.54 | ... | ... | ... | 0 | ... | 0 |
| 3.00 | .7952 | .8113 | .6451 | .8296 | ..08210 | ..0542 |
| 3.50 | .7411 | .7980 | .5917 | .9473 | ..1516 | ..1064 |

$$h=1; \rho=4; t=5; -\zeta = \sqrt{\frac{2}{\rho}} \sin\left(\frac{xt^2}{\rho^2} + \theta\right) e^{-\frac{t^2}{\rho^2}}$$

| Col. 1. | Col. 2. | Col. 3. | Col. 4. | Col. 5. | Col. 6. | Col. 7. |
|----------|---------------------------|---------------------------------|--|---|-----------------------------|---|
| x . | $\sqrt{\frac{1}{\rho}}$. | $\sqrt{\rho+1} = \sin \theta$. | Initial Elevation of Water-surface at Distance x . | $\sin\left(\frac{xt^2}{\rho^2} + \theta\right)$. | $e^{-\frac{t^2}{\rho^2}}$. | Elevation of Water-surface at Time t , and Distance x . |
| 4.0 | .6965 | .7882 | .5490 | .4856 | .2298 | .07771 |
| 4.41 | ... | ... | ... | 0 | ... | 0 |
| 4.5 | .6588 | .7798 | .5139 | -.0944 | .3083 | -.01917 |
| 5.0 | .6262 | .7733 | .4843 | -.5084 | .3823 | -.1336 |
| 5.5 | .5981 | .7678 | .4592 | -.8457 | .4493 | -.2273 |
| 6.0 | .5733 | .7629 | .4375 | -.9781 | .5122 | -.2872 |
| 6.5 | .5513 | .7587 | .4185 | -.9956 | .5641 | -.3096 |
| 7.0 | .5318 | .7555 | .4018 | -.9374 | .6066 | -.3024 |
| 7.5 | .5150 | .7522 | .3868 | -.8333 | .6462 | -.2773 |
| 8.0 | .4980 | .7494 | .3734 | -.7053 | .6808 | -.2392 |
| 9.0 | .4699 | .7451 | .3502 | -.4289 | .7372 | -.1486 |
| 10 | .4461 | .7416 | .3308 | -.1679 | .6346 | -.04753 |
| 10.62 | ... | ... | ... | 0 | ... | 0 |
| 11 | .4255 | .7385 | .3142 | .05698 | .8147 | .01975 |
| 12 | .4076 | .7359 | .2999 | .2428 | .8416 | .08375 |
| 13 | .3916 | .7339 | .2874 | .3940 | .8644 | .1334 |
| 14 | .3775 | .7318 | .2763 | .5175 | .8808 | .1721 |
| 15 | .3648 | .7302 | .2663 | .6163 | .8954 | .2013 |
| 16 | .3533 | .7286 | .2574 | .6953 | .9082 | .2231 |
| 18 | .3331 | .7266 | .2419 | .8098 | .9260 | .2498 |
| 20 | .3160 | .7256 | .2290 | .8831 | .9396 | .2622 |
| 22 | .3014 | .7230 | .2179 | .9313 | .9497 | .2666 |
| 24 | .2885 | .7216 | .2082 | .9627 | .9579 | .2661 |
| 26 | .2772 | .7206 | .1998 | .9815 | .9638 | .2622 |
| 28 | .2672 | .7193 | .1923 | .9915 | .9685 | .2565 |
| 30 | .2581 | .7187 | .1856 | .9979 | .9727 | .2505 |
| 32 | .2500 | .7181 | .1795 | .9999 | .9759 | .2439 |
| 34 | .2425 | .7173 | .1740 | .9993 | .9786 | .2371 |
| 38 | .2294 | .7163 | .1643 | .9933 | .9828 | .2240 |
| 42 | .2182 | .7155 | .1561 | .9840 | .9847 | .2188 |
| 46 | .2084 | .7147 | .1490 | .9734 | .9883 | .2005 |
| 50 | .2000 | .7141 | .1428 | .9623 | .9902 | .1905 |
| 55 | .1906 | .7135 | .1360 | .9486 | .9917 | .1794 |
| 60 | .1826 | .7129 | .1302 | .9361 | .9931 | .1697 |
| 70 | .1690 | .7120 | .1204 | .9125 | .9949 | .1535 |
| 80 | .1581 | .7114 | .1125 | .8931 | .9961 | .1407 |
| 100 | .1415 | .7108 | .1005 | .8626 | .9977 | .1217 |
| ∞ | 0 | .7071 | 0 | .7071 | 1.0000 | 0 |

§ 8. Look at the values shown in the previous table for the three factors which constitute ζ ;—we see that the first factor (col. 2) decreases slowly from $x=0$ to $x=\infty$; the second factor (col. 5) alternates between $+1$ and -1 with increasing distances (semi-wave-lengths) from zero to zero as x increases.

Fig. 2.

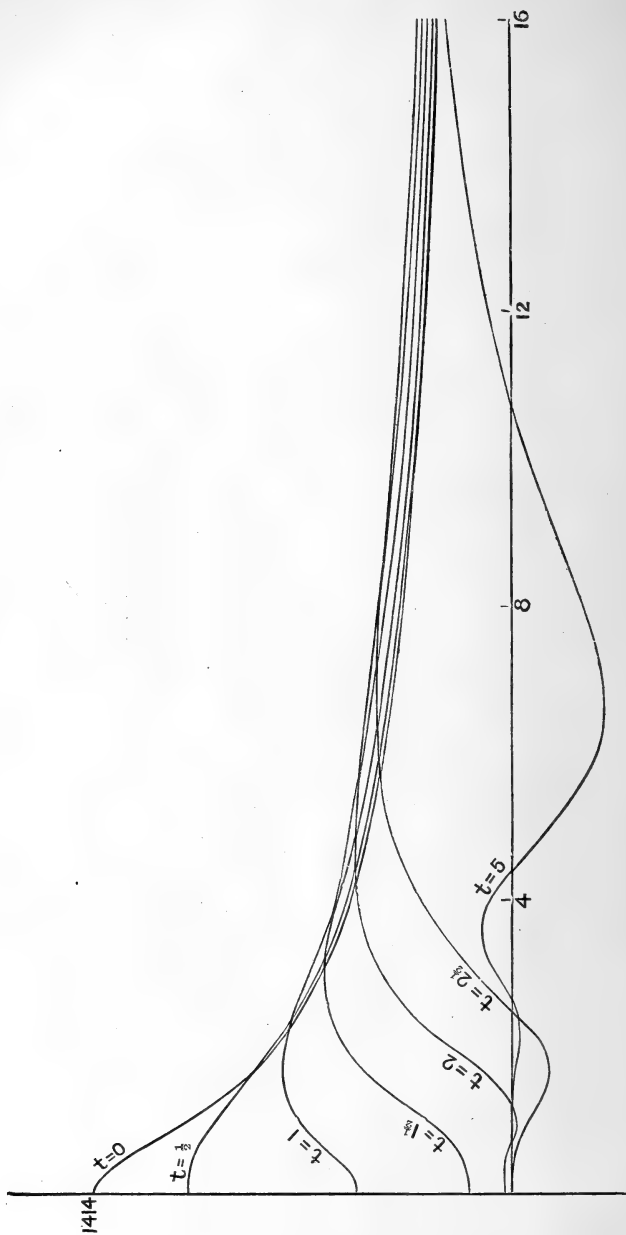
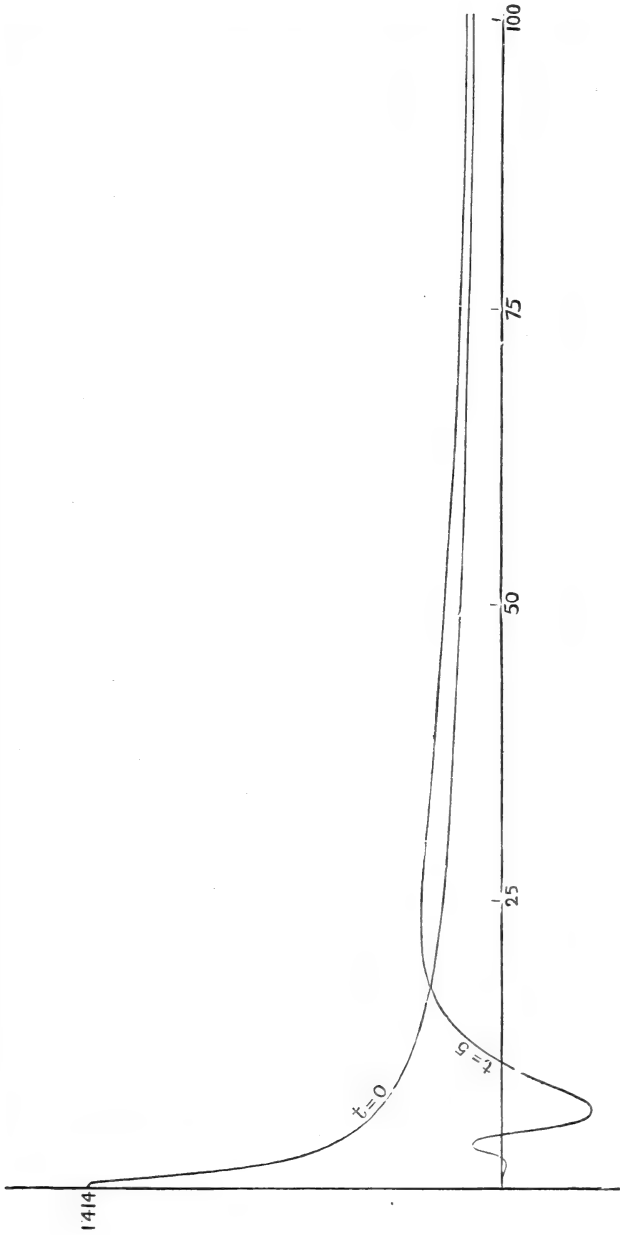

Fig. 3.



The third factor (col. 6) increases gradually from ϵ^{-t^2/h^2} at $x=0$, to 1 at $x=\infty$. At $x=50h$, the third factor is $\cdot99$, which is so nearly unity that the diminution of amplitude is, for all greater values of x , practically given by the first factor alone, which diminishes from $\cdot2$ at $x=50h$, to 0 at $x=\infty$.

§ 9. The diagrams hitherto given, figs. 1, 2, 3, may be called space-curves, as on each of them abscissas represent distance from the centre of the disturbance. Fig. 4 is a time-curve (abscissas representing time) for $x=2h$. It represents a very gradual rise, from $t=0$ to $t=\cdot6$, followed by a fall to a minimum at $t=2\cdot8$, and a succession of alternations, with smaller and smaller maximum elevations and depressions, and shorter and shorter times from zero to zero, on to $t=\infty$. The same words with altered figures describe the changes of water level at any fixed position farther from the centre of disturbance than $x=2$. The following table shows, for the case $x=100h$, all the times of zero less than $71h$, and the elevations and depressions at the intermediate times when the second factor (col. 5 of § 7) has its maximum and minimum values (± 1). These elevations and depressions are very approximately the greatest in the intervals between the zeros, because the third factor (col. 6, § 7) varies but slowly, as shown in the first column of the present table.

$$h=1; \quad x=100; \quad \rho=100\cdot005\cdot h; \quad \theta=\tan^{-1}\sqrt{\frac{101}{99}}=45^\circ 18'.$$

| $\frac{-t^2}{\rho^2}$ | Times of Zero and of Approximate Maximum Elevation and Depression. | Approximate Maximum Elevations and Depressions. | $\frac{-t^2}{\rho^2}$ | Times of Zero and of Approximate Maximum Elevation and Depression. | Approximate Maximum Elevations and Depressions. |
|-----------------------|--|---|-----------------------|--|---|
| $\cdot9922$ | 8.333 | $+\cdot1403$ | $\cdot7718$ | 50.90 | $+\cdot1091$ |
| ... | 15.33 | 0 | ... | 52.42 | 0 |
| $\cdot9616$ | 19.80 | $-\cdot1360$ | $\cdot7478$ | 53.90 | $-\cdot1058$ |
| ... | 23.43 | 0 | ... | 55.34 | 0 |
| $\cdot9317$ | 26.57 | $+\cdot1317$ | $\cdot7247$ | 56.74 | $+\cdot1025$ |
| ... | 29.38 | 0 | ... | 58.10 | 0 |
| $\cdot9031$ | 31.94 | $-\cdot1277$ | $\cdot7023$ | 59.45 | $-\cdot0993$ |
| ... | 34.31 | 0 | ... | 60.75 | 0 |
| $\cdot8750$ | 36.54 | $+\cdot1237$ | $\cdot6806$ | 62.03 | $+\cdot0962$ |
| ... | 38.62 | 0 | ... | 63.29 | 0 |
| $\cdot8480$ | 40.61 | $-\cdot1199$ | $\cdot6595$ | 64.51 | $-\cdot0933$ |
| ... | 42.50 | 0 | ... | 65.72 | 0 |
| $\cdot8219$ | 44.31 | $+\cdot1162$ | $\cdot6392$ | 66.90 | $+\cdot0904$ |
| ... | 46.04 | 0 | ... | 68.07 | 0 |
| $\cdot7964$ | 47.72 | $-\cdot1157$ | $\cdot6195$ | 69.21 | $-\cdot0876$ |
| ... | 49.34 | 0 | ... | 70.34 | 0 |

Fig. 4.

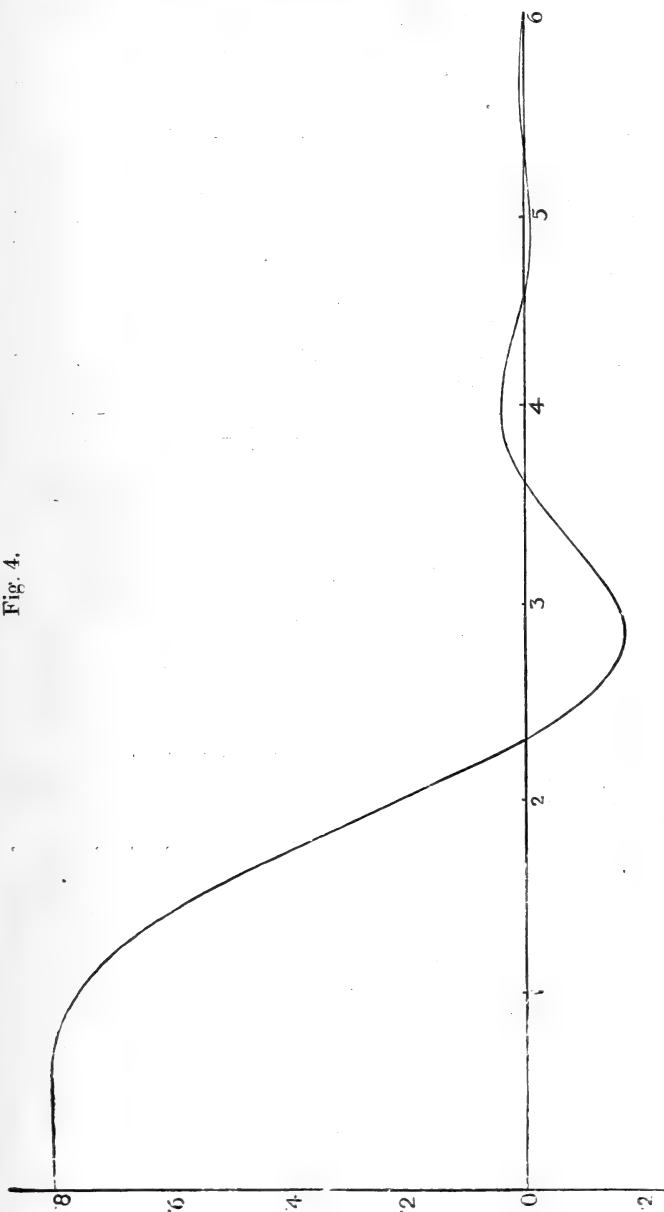

$\alpha = 2h, g = 4.$ Abscissas represent time. $-\zeta = \sqrt{\frac{2}{\sqrt{5}} \sin\left(\frac{2t^2}{5} + \sin^{-1} \frac{\sqrt{5}+1}{2\sqrt{5}}\right) \epsilon^{-\frac{t^2}{5}}}.$

§ 10. Our assumption $h=1$ for the free surface involves no restriction of our solution to a particular case of the general formula (7). Our assumption $g=4$ merely means that our unit of abscissas is half the space fallen through in our unit of time. The fundamental formulas of § 3 may be geometrically explained by, as in § 2, taking O , our origin of co-ordinates, at a height h above the water level, and defining ρ as the distance of any particle of the fluid from it. When, as in §§ 5-9, we are only concerned with particles in the free surface (that is to say when $z=h$), we see that if x is a large multiple of z , $\rho \doteq x$. See for example the heading of the table of § 9. And if we are concerned with particles below the surface, we still have $\rho \doteq x$, if x is a large multiple of z . Thus we have the following approximation for (7) of § 3:—

$${}_1\phi(x, z, t) \doteq \frac{1}{\sqrt{2 \cdot x}} \left[\sqrt{(x+z)} \cos \frac{gt^2}{4x} + \sqrt{(x-z)} \sin \frac{gt^2}{4x} \right] e^{-\frac{gt^2 z}{4x^2}} \quad (13).$$

Suppose now $d\phi/dt$ to represent ζ (instead of ϕ , as in §§ 5-9); we have

$$\zeta = \frac{d}{dt} {}_1\phi(x, z, t) \quad \dots \quad (14),$$

which is easily found from (13) without farther restrictive suppositions. But if we suppose that z is negligibly small in comparison with x ; and farther that

$$\frac{gt^2 z}{4x^2} \doteq 0 \quad \dots \quad (15),$$

we find by (14)

$$\zeta \doteq 2 \sqrt{2 \cdot x^3} \cdot 2 \left(\cos \frac{gt^2}{4x} - \sin \frac{gt^2}{4x} \right) \quad \dots \quad (16).$$

This, except the sign — instead of +, is Cauchy's solution*; of which he says that when the time has advanced so much as to violate a condition equivalent to (15), "le mouvement change avec la méthode d'approximation." The remainder of his Note XVI. (about 100 pages) is chiefly devoted to very elaborate efforts to obtain definite results for the larger values of t . This object is thoroughly attained by the exponential factor in (8) of § 3 above, without the crippling restriction $z/x \doteq 0$ which vitiates (16) for small values of x .

* *Œuvres*, vol. i. note xvi. p. 193.

LXIX. *On the ascertained Absence of Effects of Motion through the Æther, in relation to the Constitution of Matter, and on the Fitz-Gerald-Lorentz Hypothesis.* By Prof. J. LARMOR, Sec.R.S.*

IN a recent paper by Prof. D. B. Brace (Phil. Mag. April 1904, p. 318) the author removes by very refined experimenting all trace of doubt from Lord Rayleigh's conclusion that motion of transparent solids through the æther does not induce any double refraction, even to the second order of the ratio of the velocity of the translation to that of radiation; but he infers from this the non-existence of the second-order deformation of the solid due to its translation, suggested by FitzGerald and by H. A. Lorentz to account for Michelson's earlier demonstrated absence of effect on optical interferences over long paths in free æther. As he remarks, it had previously been suggested by Lord Rayleigh that such an inference might possibly follow from this result. The object of this note is to explain that the inference in question is the opposite to that which I still hold to be the natural result of the theory of the motion of molecular aggregates through æther, as hitherto developed †.

The argument of Prof. Brace proceeds on the basis that the *whole* effect of the convection through the æther is to *introduce new forces* between the molecules, causing the shrinkage aforesaid along the direction of convection; and it can be readily granted that if this were all, double refraction must result. But both the line of argument suggested as probable by Lorentz ‡, and the molecular analysis offered by me some years later §, proceed by comparing a system shrunk in the FitzGerald-Lorentz manner and convected through the æther, with the *same system* unshrunk and at rest, and finding a complete correspondence between them as regards the states and activities of the individual molecules. As the argument is somewhat complex and has been misunderstood, a brief re-statement of the result may prove useful.

We are to compare the field of physical activity of a system of molecules at rest, with the field of the identically same configuration of molecules in uniform translatory motion through æther. If small quantities of the order of the square of the ratio of the velocity of convection to that of radiation (v/c) are neglected, the Maxwellian physical equations for the

* Communicated by the Physical Society: read May 27, 1904.

† 'Æther and Matter,' Camb. Univ. Press, 1900, chapter xi.

‡ 'Versuch einer Theorie,' 1895, §§ 91-2, translated in part in 'Æther and Matter,' p. 186.

§ *Loc. cit.*

second system, referred of course to axes of co-ordinates moving along with it, can be reduced to the form belonging to the same system at rest, by the transformation first developed by Lorentz: namely, each point in space is to have its own origin from which time is measured, its "local time" in Lorentz's phraseology, and then the values of the electric and magnetic vectors

$$(f, g, h) \text{ and } (a, b, c),$$

at all points in the æther between the molecules in the system at rest, are the same as those of the vectors

$$\left(f, g - \frac{v}{4\pi c^2} a, h + \frac{v}{4\pi c^2} b\right) \text{ and } (a, b + 4\pi v h, c - 4\pi v g)$$

at the corresponding points in the convected system at the same local times. This correspondence can, in fact, be shown to locate the electrons at corresponding points in the two systems, and to make them equal; if, then, they are held in rigid connexion, or more generally if their states of orbital motion in the molecules are conserved, the effect of translatory motion of the system with velocity v is to transform the æthereal field around them and between them as here specified. The fields of æthereal activity are *not identical*, but where one vanishes at any point so does the other at the same point. This conclusion was reached by Lorentz, who pointed out that it carried with it a null result for all recognizable optical tests of convection in the system, up to the first order, with the one exception of the Doppler effect which is involved in the "local" time measurements, and which is only a partial exception because it refers to radiation coming from outside the system.

Does, however, the system of electrons need to be constrained in order to prevent change of configuration when being convected? The force acting on an individual electron e is thereby changed from

$$4\pi c^2 e \left(f, g - \frac{v}{4\pi c^2} c, h + \frac{v}{4\pi c^2} b\right) \text{ to } 4\pi c^2 e (f, g, h).$$

If there is a magnetic field (a, b, c) there will thus be alteration: if there is no sensible average magnetic field, even among the molecules, we may perhaps fairly assume, with Lorentz, that no constraint is needed in order to prevent change in molecular configuration in the system due to convection. Anyhow, the absence of recognizable optical result to the first order is certain, as the physical constants of the system in bulk must be unaltered to that order.

But the brilliant experimenting of Michelson and Morley

had already led to the recognition of absence of optical result up to the second order of the ratio of the velocities. Thus the question was suggested whether the above correspondence between the resting and convected systems can be effectively extended up to the second order. It is, in fact, found that the Maxwellian circuital equations of æthereal activity, in the ambient æther, referred to axes moving along with the uniform velocity of convection v , can be reduced to the same form as for axes at rest, up to and including $(v/c)^2$, but not $(v/c)^3$, by adopting a local time $\epsilon^{-\frac{1}{2}}(t - vx/c^2)$ as before, but with a new unit $\epsilon^{-\frac{1}{2}}$, and also a reduced unit of length parallel to x equal to $\epsilon^{-\frac{1}{2}}$, where here and in what follows ϵ represents $1 + v^2/c^2$, the units of length along y and z remaining unaltered. It is found that for two æther-fields, one referred to fixed axes and the other to moving axes, standing in this mutual correlation, the electrons, or poles, in approaching which the æthereal electric vector becomes infinite as er^{-1} , are situated at corresponding points and are of equal values: the relation, exact to the second order, is now that

$$(j', g, h) \text{ and } (a, b, c)$$

in the field belonging to the fixed system of poles correspond to

$$\epsilon^{\frac{1}{2}} \left(\epsilon^{-\frac{1}{2}} j', g - \frac{v}{4\pi c^2} c, h + \frac{v}{4\pi c^2} b \right)$$

and

$$\epsilon^{\frac{1}{2}} (\epsilon^{-\frac{1}{2}} a, b + 4\pi v h, c - 4\pi v g)$$

for the field belonging to the convected system; where ϵ is $1 + v^2/c^2$, as above, the factor $\epsilon^{\frac{1}{2}}$ being needed to make corresponding poles equal in value instead of merely proportional.

If each pole or electron is connected with a molecule possessing extraneous mass, and it may be having an extraneous field of gravitational and other force of its own, and thereby interacting with other molecules, we shall want to know the forces exerted on that molecule by the surrounding æther, in order to form its own equations of motion, which must be combined with those of the æther-field around it in order to constitute a complete system. But if such other forces are molecularly insignificant, or better, if the electron is a mere passive pole—nucleus of beknottedness in some way—in the æther, conditioned and controlled entirely by the æther around it, just as a vortex ring is conditioned by the fluid in which it subsists and is also carried along thereby, then, as in the familiar hydrodynamics of vortices, the motion of the æther determines the motion of the entirely passive

electrons, and the idea of force acting between them and the æther is dispensed with.

If, then, matter is for physical purposes a purely æthereal system, if it is constituted of simple polar singularities or electrons, positive and negative, in the Maxwellian æther, the nuclei of which may be either practically points or else small regions of æther with internal connexions of pure constraint, the propositions above stated for the first order are extended to the second order of v/c , with the single addition of the FitzGerald-Lorentz shrinkage in the scale of space, and an equal one in the scale of time, which, being isotropic, is unrecognizable.

On such a theory as this the criticism presents itself, and was in fact at once made, that one hypothesis is needed to annul optical effects to the first order; that when these were found to be actually null to the second order another hypothesis had to be added; and that another hypothesis would be required for the third order, while in fact there was no reason to believe that they were not exactly null to all orders. Such a train of remarks indicates that the nature of the hypotheses has been overlooked. And if indeed it could be proved that the optical effect is null up to the third order, that circumstance would not demolish the theory, but would rather point to some finer adjustments than it provides for: needless to say the attempt would indefinitely transcend existing experimental possibilities.

As, then, the theory contains no further power of immediate adaptation, what are the hypotheses on which it rests, and how far are they gratuitous hypotheses introduced for this purpose alone? Up to the first order the electron hypothesis, that electricity is atomic, suffices by itself, as Lorentz was the first to show. Yet, even if the nature of the particles of the cathode discharge had never been made out, and the Zeeman effect had never been discovered, the facts known to Ampère and Faraday were sufficient to *demonstrate* that no other conception of electricity than the atomic one is logically self-consistent*.

Up to the second order the hypothesis that matter is constituted electrically—of electrons—is required in addition. For this there is no independent evidence except perhaps the general simplicity of the correlations of physical law. The circumstance that positive electrons have not yet been isolated naturally counts considerably on the other side; yet the theory puts no limit to the size and inertia and complexity of an electron, it only prescribes that it must be a collocation of æther poles connected together by some sort of pure constraint, but with no extraneous activities.

* Cf. 'Æther and Matter,' p. 337.

Any rival theory must on the threshold give an account of the Michelson null optical result, of Trouton's null electric result for convection of a charged condenser *, and of Rayleigh's absence of double refraction now rendered thoroughly secure by Brace †.

As electrons are already held to be a reality on various grounds, theoretical and experimental, it would appear therefore that there is much to be said for a benevolent attitude to the proposition that all the interactions of matter, so far as the laws of physics and chemistry extend, are to be described as phenomena occurring in and through the æther, and thus differentiated from the more recondite world of vital growth and change which they make manifest to our senses. This principle does not yet, so far as one can see, stand in the way of any other branch of physical science, while it accounts for the very remarkable absence of influence of the earth's motion through space on the most sensitive phenomena, and is almost led up to thereby.

It is pertinent to the present subject to refer to Mr. Sutherland's recent remarks (*Phil. Mag.* April, p. 406) on the magnetic effect of electric convection, in relation to the mysterious action of a dielectric varnish that has been announced by Crémieu and Pender. The discrepancy in the conservation of energy, there described, applied to the domain of electric polarization, is too startling to have been overlooked by the current theory ‡; and accordingly closer consideration gets rid of the difficulty. When an electron e is transferred in an electric field from a place where the potential is V_1 to a place where it is V_2 , the force acting on it, being e multiplied by the gradient of V , does work equal to $e(V_1 - V_2)$. When, however, the electron is embedded in a piece of dielectric matter which is so transferred, the force acting on the electron itself is diminished by the presence of the surrounding polarized matter, and so the work done on the electron is less than before: but now the electric polarization induced by the electron in this surrounding matter is also acted on by the electric field, and if we add the work done on it during the movement, we shall get the same total work as before for the system that is moved, and there will be no discrepancy to be otherwise explained.

Cambridge, April 7, 1904.

* *Phil. Trans.* 1903.

† The null influence on optical rotation, observed by Rayleigh, counts here as a first-order effect.

‡ *Cf. Phil. Trans.*, 1897 A, p. 248, and 'Æther and Matter,' 1900, Appendix A.

LXX. *On the Temperature-Variation of the Coefficient of Expansion of Pure Nickel.* By E. PHILIP HARRISON, Ph.D. (Zürich), 1851 Exhibition Research Scholar of University College, London; King's College, Cambridge*.

IN 1869 G. Gore† published an account of some experiments on "A Momentary Molecular Change in Iron Wire," in which he showed that if a stretched iron wire be heated to bright redness and then allowed to cool, at a certain temperature there occurs a diminution in the rate of contraction of the metal, which may even become a momentary expansion in the case of particular specimens under suitable conditions. It was found that three conditions were necessary in order to obtain this effect, which is generally known as "Gore's Phenomenon."

- (i.) The wire should be cooling.
- (ii.) It should be under a sufficient tension.
- (iii.) It should have been heated to a sufficiently high temperature.

In every case observed by Gore, the wires after use were found to be permanently elongated.

Some years after Gore's experiments Barrett‡ showed that this anomalous behaviour of iron was not confined to cooling specimens alone, but that the effects occur just as definitely, though in the reverse order, when the wire is heated.

A phenomenon similar to that of Gore was noticed by H. Tomlinson§ during a research on the torsional rigidity of iron wire at high temperatures. He found that if the specimen were heated while under the influence of a very small torsional couple at bright redness, there occurred a sudden twist in the wire in the opposite sense to the applied couple, while an "untwist" took place at the same temperature during cooling. The effect is as though there were a sudden increase in the elasticity of the iron at a certain temperature during heating. For soft iron, this twisting jerk occurs at approximately the same temperature whether the metal is heated or cooled; but for hard specimens the twist is delayed during cooling till a lower temperature is reached.

These sudden changes have long been regarded as having connexion with the loss of magnetic quality which occurs in iron at a high temperature, and were considered in this con-

* Communicated by Prof. J. J. Thomson, F.R.S.

† G. Gore, Proc. Roy. Soc. 1869.

‡ Barrett, Phil. Mag. ser. 4, vol. xlvi.

§ Tomlinson, Phil. Mag. vol. xxiv. (1887).

nexion by a Committee of the British Association in 1890*. With these anomalous changes has also been associated the phenomenon of recalescence; but it is noticeable, as Tomlinson has pointed out, that recalescence only appears in specimens for which the "untwist" is delayed in the manner just described. Thus in Tomlinson's view, iron possesses two critical points in respect to torsional rigidity, the lower one at a dull red heat, at which recalescence occurs (if at all) and at which the intensity of the magnetization vanishes; and the other at bright redness, with which is associated the elasticity change for both rising and falling temperatures in the case of soft iron, and for a rising temperature only in the case of harder specimens.

Tomlinson observed the same effect for an impure nickel (containing a large percentage of iron), but he failed to observe any such changes in the pure metal.

Up to the present time the same remark has generally been believed to apply to Gore's phenomenon for nickel.

The experiments described below were made with the object of testing this last point rather more carefully, since a change in the coefficient of expansion at or near the magnetic critical point was certainly probable, in view of the resemblance of nickel to iron as regards peculiarities in their physical properties.

The nickel employed was from a very pure specimen of wire, kindly given to the author some years ago by Professor H. L. Callendar, F.R.S., and which has been already used in a research on the temperature variation of thermoelectric force and resistance, as well as in an investigation (shortly to be published) on the magnetic properties of nickel at high temperatures.

The diameter of the specimen was 0.0765 cm.

Present Experiments.

The method employed in the present experiments was to observe by means of reading-microscopes the expansion of a definite portion of the nickel wire. The wire was heated electrically by direct passage of a current through it, and its temperature was deduced from its resistance. The relation between temperature and resistance had previously been determined by experiments on the same specimen of nickel †.

* B. A. Report, 1890, by Committee on "Molecular Phenomena associated with the Magnetization of Iron."

† Harrison, *Phil. Mag.* February 1902.

The wire was mounted in the following manner :—

On a solid base-board of mahogany A, fig. 1 (55 cms. long by 30 cms. wide by 3.5 cms. thick) was cut a groove (1.5 cm. deep by 1.8 cm. wide) which extended the whole length of the board. Thick brass plates E, F were screwed to the board in such a way as to close up the ends of the groove, and the nickel was then mounted so as to lie centrally therein. To effect this, one end of the wire was firmly clamped to a brass boss on the plate E, while the other end was attached to a brass disk D which was pressed outwards by the spring S. The spring was kept in position by a tube T rigidly attached to the end-plate, while D was steadied by being soldered to another brass tube K which just slid inside T. The spring served the double purpose of keeping the wire under slight tension and of taking up the slack due to expansion.

The tension on the wire could be regulated by adjusting a circular brass plate M which worked on a screw-thread cut on the tube T; by screwing M outwards or inwards the spring could be either compressed or relaxed, and the tension on the wire increased or reduced. The tension used throughout these experiments was just enough to keep the wire straight.

Binding-screws at B₁ and B₂ allowed the nickel to be placed in circuit with the heating current.

Two fine scratches q and q' (fig. 1) about 10 cms. apart were made on the wire; and it was the expansion of this portion qq' that was observed.

At t and t' fine platinum wires were silver-soldered to the nickel for the purpose of measuring the resistance of the experimental portion tt' of the wire. The distances $qt, q't'$ were each 4.5 cms.; and thus as

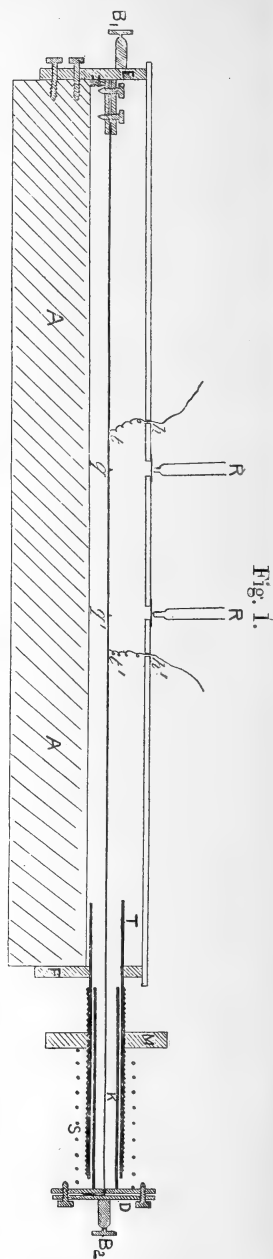

the whole length of the wire was 60 cms., the distance of t or t' from the ends of the specimen was great enough to ensure the existence of a uniform temperature over the experimental portion of the nickel.

During an experiment, the top of the groove was closed by a strip of wood containing two holes covered with mica through which the scratches could be viewed. The fine platinum leads r, r' were brought out through small holes h and soldered to binding-screws on the base-board.

Two separate reading-microscopes of the travelling type were used, and it was therefore necessary to know accurately the distance between the two scratches at a particular temperature. This was effected by making a comparison of the nickel wire with a standard scale, at the temperature of the laboratory.

The microscopes were read to the thousandth of a millimetre.

Measurement of the Temperature.

The resistance of the portion $t t'$ of the nickel was determined by comparing the potential-difference between t and t'

Fig. 2.

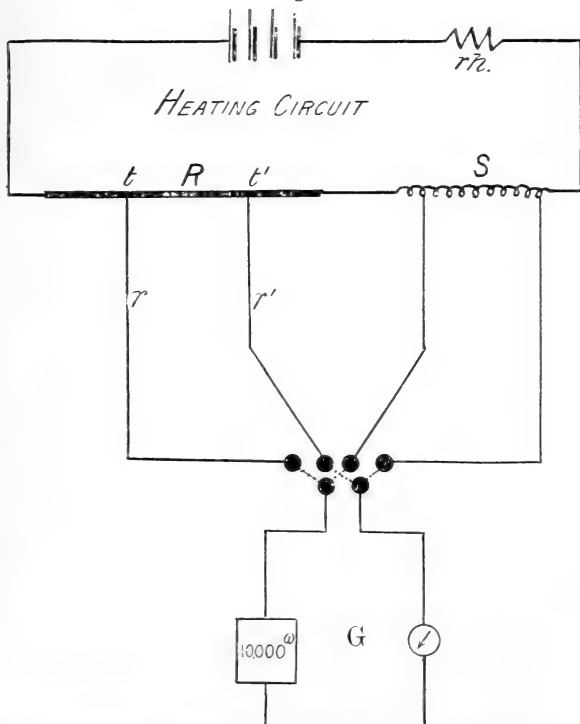

with the potential-difference between two points on a standard resistance which was in series with the nickel and carried the

same current (fig. 2). The standard was made of manganin wire, and was kept cool by being immersed in paraffin-oil and surrounded by a coil of "composition" tubing through which cold water circulated. At two points on the manganin were soldered fine copper wires, which, like the pair of platinum wires coming from the nickel, served as permanent "potential-leads."

The resistances of these two pairs of potential-leads were adjusted to within $\frac{1}{20}$ of an ohm of one another by means of a small coil of fine german-silver wire in series with one of the copper leads (from the manganin). The resistance of the manganin wire between the points of attachment of the two leads was carefully determined, and will be referred to as "the standard resistance."

The galvanometer-circuit consisted of a high-resistance D'Arsonval in series with about 10,000 ω , and the deflexions of the mirror were read by scale and telescope in the usual way. The scale was by Casella on porcelain, and calibration was considered to be unnecessary.

In making an observation of resistance, the pair of potential-leads from the nickel, and the pair from the standard, were alternately connected to the terminals of the galvanometer-circuit G (fig. 2), corresponding deflexions of the galvanometer being noted. These deflexions are proportional to the resistances of the nickel and standard respectively, provided that the resistances of the two pairs of potential-leads are approximately equal. The accuracy of the resistance measurements under these conditions is as great as that of which the particular scale and telescope arrangement was capable*. It was arranged that deflexions due to the nickel were as nearly as possible equal to those due to the standard. A special mercury switch was constructed for the purpose of quickly putting nickel or standard potential-leads into the galvanometer-circuit.

The temperature of the nickel was deduced from a curve previously obtained which gave the relation between the resistance of a certain length of the wire and its temperature.

If " r " is the resistance of the present wire (A) at, say, 18° and R its resistance at t° ;

And if " r' " is the resistance at 18° of the wire (B) whose temperature coefficient is known;

And if S is the resistance of the "standard;"

Then we have

$$\text{Resistance at } t^\circ \text{ of wire B} = \frac{r'}{r} R;$$

* If the two pairs of potential-leads differ by .2 ohm, the error in Ni resistance is 2×10^{-7} ohm; and this would give rise to an error of 2×10^{-6} ampere in the current through the galvanometer—an estimate which is outside the figure of merit of the instrument used.

also
$$\frac{R}{S} = \frac{\text{deflexion due to nickel}}{\text{deflexion due to standard}} = \frac{\delta_{Ni}}{\delta_{St}};$$

whence

$$\begin{aligned} \text{Resistance at } t^\circ \text{ of wire B} &= \frac{r'}{r} S \frac{\delta_{Ni}}{\delta_{St}} \\ &= (\text{in the actual experiment}) \cdot 2346 \frac{\delta_{Ni}}{\delta_{St}} \end{aligned}$$

Thus in order to determine the temperature of the wire under experiment it was only necessary to read off the abscissa (t°) corresponding to the resistance as calculated above.

Method of Observation.

Each of the two microscopes having been focussed on the nickel, so that the cross-wire lay on an edge of the appropriate scratch, readings of the microscopes were taken when the wire was at the temperature of the laboratory. The value of this temperature was obtained in two ways: firstly, by means of a mercury thermometer laid along the groove; and, secondly, by passing through the heating circuit a current, so small as not appreciably to heat the wire, but by means of which the resistance of the nickel and therefore its temperature could be determined. The two temperatures agreed very well, and served to check the adjustments.

The heating current, obtained from storage-cells, was then started, and when the temperature was steady as observed by the galvanometer-reading, observations of deflexion were made, and immediately afterwards the micrometer-heads of the microscopes were turned till the cross-wires again lay on the edges of the scratches. Deflexions due to nickel and standard were once more noted, and the micrometers read. The heating current was then increased, and the process repeated at temperature intervals of 15° or 20° till the nickel began to glow. The same operations were then gone through while the temperature of the wire was decreased.

The heating current varied from about 2 amperes to 10 amperes, at an E.M.F. of 26 volts.

Discussion of Results.

In the curve (fig. 3) is exhibited the actual change of length as the temperature varies between 0° and 500° . If "L" is the distance between the scratches at any particular temperature, the ordinates on the curve show the values of $(L-10) \times 10^2$ cms. Up to a temperature of about 365° the

curve is regular; between 365° and 380° there occurs an anomalous change in the expansion, while above 380° the curve is again regular, though now it is linear with a different slope to the regular part of the curve which precedes it.

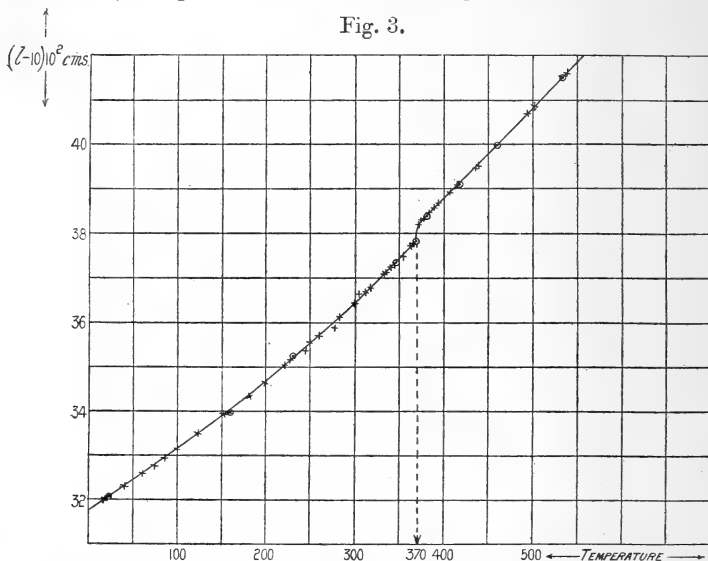

No difference in the position or shape of the anomalous portion of this curve was noticed, whether the temperature was rising or falling. It is also worthy of notice that in every case the wire returned after heating to its original length: there was no permanent elongation.

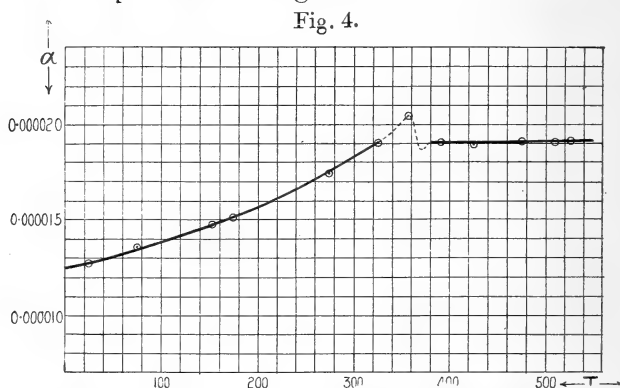

From the curve fig. 3 is calculated the mean coefficient of expansion over 50° ranges, between 0° and 300° , and the result is shown graphically in fig. 4.

It can be represented up to 300° by the parabolic formula

$$\alpha_t = 10^{-8}(1280 + .75t + .0035t^2)*,$$

which is calculated so as to agree with the experimental curve at 100°, 200°, 300°. Above 300° this formula does not agree with experiment.

From 380° upwards the coefficient is constant, and has the value .0000191.

Of the two tables which follow, the one is an example of the values of the expansion actually observed, and shows how the observations were reduced, while the other gives values of the mean coefficient of linear expansion.

| Distance between Scratches at beginning of range. | Shift of Left-hand Scratch. | Shift of Right-hand Scratch. | δ . | Value of $\frac{\delta Ni}{\delta St}$. | Temperature range. | |
|---|-----------------------------|------------------------------|------------|--|--------------------|--------|
| | | | | | Lower. | Upper. |
| 10-32000 | .01565 | .02345 | .00780 | .1445 | 16.4 | 75.5 |
| 10-32780 | .01016 | .01655 | .00639 | .1654 | 75.5 | 112.3 |
| 10-33419 | .01890 | .02820 | .00930 | .2114 | 112.3 | 182.3 |
| 10-34349 | .03825 | .06110 | .02285 | .3165 | 182.3 | 305.0 |
| 10-36634 | .02423 | .03495 | .01072 | .3894 | 305.0 | 364.2 |
| 10-37706 | .01976 | .02920 | .00944 | .4144 | 364.2 | 395.0 |
| 10-38650 | .02068 | .02935 | .00867 | .4360 | 395.0 | 442.0 |
| 10-39517 | .04094 | .06160 | .02066 | .4760 | 442.0 | 539.0 |
| 10-41583 | | | | | 539.0 | |

Mean Values of the Coefficient of Expansion.

| Range of Temperature. | Mean Temperature. | α . |
|-----------------------|-------------------|------------|
| 0 to 50 | 25.0 | .0000128 |
| 50 " 100 | 75.0 | .0000136 |
| 150 " 200 | 175.0 | .0000151 |
| 250 " 300 | 275.0 | .0000174 |
| 300 " 350 | 325.0 | .0000191 |
| 350 " 365 | 357.5 | .0000205 |
| 380 " 400 | 390.0 | .0000191 |
| 400 " 450 | 425.0 | .0000189 |
| 450 " 500 | 475.0 | .0000192 |
| 500 " 550 | 525.0 | .0000190 |

* Cp. Tutton's value for nickel

$$\alpha_t = 10^{-8}(1248 + .74t)$$

(Proc. Roy. Soc. Nos. 415-419).

The anomalous part of the curve extends from 340° to 370° , which is very approximately the range over which changes occur in the thermoelectric force and resistance of the same specimen of nickel. Moreover, it has recently been shown by the author, in some experiments not yet published, that this interval is also that over which the magnetic permeability of the same specimen changes—the actual critical temperature, at which the susceptibility vanishes, being just over 370° .

The present experiments may thus be summarized as follows:—

(1) For pure nickel there exists a sudden change in the coefficient of expansion, between the temperatures of 365° and 370° C.

(2) The change is of the same magnitude, and occurs at the same temperature, whether the wire is heated or cooled.

(3) No permanent elongation of the nickel is observed after heating.

(4) Successive heatings and coolings entirely fail to “wipe out” the effect, or indeed to modify it in the least.

In view of the permanent elongation which occurred in all Gore's experiments, the effect he observed was no doubt largely a question of change in the elastic constants. It has been pointed out in the Report of the British Association Committee that the presence of carbon in the iron, and the consequent formation of carbides at the critical temperature, largely explained these and other peculiarities in iron. But in view of the purity of the present specimen of nickel, it seems unlikely that such an explanation would account for the facts above described; it appears more probable that in this case the real cause of the phenomenon which occurs at the “critical temperature” is to be sought for in the metal itself, although in the case of impure metals the true effect might be masked and modified by changes of a chemical nature.

In conclusion I wish to express my best thanks to Professor J. J. Thomson for the facilities that he has placed at my disposal and for kind advice given during the course of these experiments at the Cavendish Laboratory.

LXXI. *A Comparison of the Periods of the Electrical Vibrations associated with Simple Circuits.* By J. A. POLLOCK, Professor of Physics in the University of Sydney. With an Appendix by J. C. CLOSE, Deas-Thomson Scholar in Physics*.

Introductory.

THE object of the present research has been to compare the periods of the electrical vibrations connected with narrow rectangular closed circuits with those of the oscillations associated with straight wires and with open and closed rings.

The essential features of the experimental method adopted are as follows:—A condenser is discharged in the neighbourhood of a narrow rectangular closed circuit; oscillatory currents are thus set up in the rectangle, which in turn induce others in a third circuit of required shape. Observations of the amplitudes of the disturbances in the circuits are made with Rutherford's magnetic detectors, while the dimensions of the circuits are adjusted, step by step, until finally all three are in tune. The length of a circuit of any shape can thus be found which has the same period of electrical vibration as that of a given narrow rectangular closed circuit.

When the experiments were commenced, it was generally considered, on theoretical grounds, that the wave-length of the free oscillation connected with open resonators was equal to twice the length of the circuit †; and certain experimental evidence had lately been published ‡ which apparently accorded with such a view. The well-known experiments of Sarasin and De la Rive and others, however, make the wave-length greater than twice the length of the resonator. It seemed essential therefore to strengthen, if possible, the experimental position, and with this object in view the present experiments were undertaken. Since their practical completion, theoretical support has been withdrawn from the results first mentioned, by the publication of Macdonald's Adams Prize Essay on Electric Waves (Cambridge, 1902), which has wholly changed the theoretical aspect.

Macdonald's calculations so closely agree with the bulk of

* Communicated by the Author. Read before the Royal Society of New South Wales.

† Kirchhoff, *Pogg. Ann.* vol. cxxi., 1864. Thomson, 'Recent Researches,' p. 340 (1893). Poincaré, 'Les Oscillations Electriques,' p. 273 (G. Carré, Paris, 1894).

‡ Turpain, *Journ. de Phys.* vol. x. p. 425 (1901); Slaby, *Electrotech. Zeit.* No. 9, p. 165 (1902).

the experimental evidence, that there can no longer be any doubt that the wave-length of the free oscillation associated with open circuits is considerably greater than twice the length of the wire.

General Results.

Open Circuits.—A. Slaby (*Electrotech. Zeit.* No. 9, p. 165, 1902) has investigated with a spark-micrometer the potential at various points of a straight wire when electrical vibrations take place along it. He finds a stationary wave with potential loops at the ends, and a relative node at the middle. Such an experiment does not seem calculated to determine the actual wave-length of the vibration connected with the wire, but apparently Dr. Slaby is satisfied, from a consideration of the observations, that the wave-length of the oscillation is equal to twice the length of the wire. He has also theoretically discussed the problem, and “the calculation gives a full confirmation of the experimental results.” The experiments were made with wires from one to ten metres long.

Drude, in *Ann. der Phys.* ix, 2, p. 293 (1902), publishes an account of an elaborate research on the vibration-period and self-induction of wire coils, in connexion with the construction of Tesla transformers. On page 328 he gives the results of the investigation with coils with few windings and with single circles. Drude does not measure the period of the vibration connected with straight wires, but states that for a thin straight wire the half wave-length is equal to the length of the wire. He refers to a calculation of Abraham (*Wied. Ann.* vol. lxvi, p. 471, 1898) which gives the half wave-length 0.85 per cent. greater than the wire-length, for a straight wire 0.25 cm. in diameter and 77 cms. long.

In the present experiments, the comparison of the periods has been made in all cases between circuits constructed of copper wire 0.33 cm. in diameter and rectangles of thin brass wire 0.04 cm. thick, the rectangles being 30 cms. wide.

It is found that the perimeters of the rectangles are greater than twice the length of straight wires which have the same period of electrical vibration, the ratio of the lengths varying from 2.45 for a rectangle 760 cms. in perimeter, to 2.31 for one whose perimeter is 1200 cms.

Approximately at least, the wave-length of the electrical vibration associated with narrow rectangular closed circuits may be taken as equal to the perimeters of the rectangles. It appears then from these experiments, that the wave-length

of the oscillation connected with a straight wire is much greater than twice the length of the wire, a result opposed to Slaby's conclusions and to Drude's statement.

For open circular resonators Sarasin and De la Rive* obtain results which are usually stated by saying that the wave-length of the free electrical oscillation connected with such circuits is equal to eight times the diameter of the circuit or to 2.55 times the wire-length. These results have been abundantly verified in a general sense, but it is doubtful if the statement is not too wide, as it takes no account of the diameter of the wire of which the resonator is made, nor of the shape or configuration of the ends of the circuit.

Turpain, from observations published quite recently, arrives at a different conclusion. He has investigated the problem of the vibration connected with circular resonators in an ingenious manner, by inclosing them in exhausted glass tubes, and judging of the electrical state of the wires by the luminosity produced in the rarefied gas. Turpain has published many accounts of his experiments, finally summarizing his work in the *Journal de Physique*, vol. x. p. 425 (1901). On p. 435 *et seq.* he describes experiments made with an open circular resonator and part of the inducing field inclosed in an exhausted vessel, and others where only the spark-gap was surrounded with rarefied gas. In both cases, it is stated that the resonator responds when one half the exciting wave-length is equal to the length of the resonator. Turpain considers it experimentally established that "the length of the wave of the electrical oscillation which excites a wire-formed resonator is equal (allowance being made for the micrometer perturbation) to double the length of the resonator." That a perturbation set up at the spark-gap is not, however, responsible for any apparent discrepancy between theory and experiment, was shown by the work of Strindberg†, who confirmed Sarasin & De la Rive's results with a resonator in which no spark occurred. If Turpain has interpreted his experiments aright, his results must be considered at variance with the great body of experimental evidence and with present theory.

Drude (*loc. cit.* p. 330) gives the measures of the wave-length of the vibration connected with four open circles, three of them being supported by wooden cores and one being wholly surrounded by air. For the latter, the half wave-length is 259 cms. when the length of the wire is 243 cms., the ratio

* Sarasin & De la Rive, *C. R.* vol. cx. 1890, vol. cxii. 1891, vol. cxv. 1892.

† Strindberg, *C. R.* vol. cxxii, p. 1403 (1896).

being 1.065. Drude concludes from this experiment that "the half natural wave-length of a nearly closed thin wire circle is 6.5 per cent. greater than its length." This value I believe to be far too small.

With the circuits used, the present experiments give for the ratio of the perimeters of rectangles 30 cms. in width to the lengths of open circular circuits, when both have the same period of vibration, values varying from 2.38 for a rectangle with a perimeter of 760 cms., to 2.28 for one whose perimeter is 1050 cms., the gaps in the circles being about 15 cms. long to avoid any appreciable capacity effect due to the proximity of the ends of the circuit.

Comparing this result with that given just above for straight wires, it is found that the electrical vibration connected with a wire bent into the form of a circle, with a considerable gap in its circumference, has a shorter period than that associated with a straight wire of the same length. The actual result obtained is that a copper wire 0.33 cm. in diameter, if bent into the form of a circular arc, with its ends separated by a distance of about 15 cms., requires to be 3.2 per cent. longer than a straight wire of the same gauge 310 cms. long to give a radiation of the same wave-length, and 3.4 per cent. longer than a straight wire 445 cms. in length. This result is to be expected when the ends of the circular arc are not brought too closely together, as the inductance of the wire is less in the circular form than when straight and the capacity is practically unaltered (see Thomson, 'Recent Researches,' § 385).

A further decrease of inductance without appreciable change of capacity can be made by bending the wire forming the open circle into the shape of a narrow rectangle with an open end. One would expect, therefore, the period of vibration in such a circuit to be somewhat less than that in an open circle of the same perimeter. That the periods of electrical vibration connected with such circuits are, at least, nearly equal when the perimeters are the same, is shown by a result obtained by Sarasin & De la Rive* in connexion with their experiments with waves along wires. In these experiments it was found that the distance from the free ends of the wires to the first node was nearly equal to half the circumference of the resonator, and in such a case of parallel wires with free ends, the end section may be considered to correspond with an open rectangle. Macdonald, 'Electric Waves,' p. 121, in giving the distance to the first node from the end of the wire as 0.192λ , makes the ratio of wave-length

* Sarasin & De la Rive, *C. R.* vol. cx. 1890.

to perimeter of open rectangle 2.60, or the period of vibration in such a circuit longer than in the case of an open circle of the same perimeter. Bumstead, in the *Am. Journ. Sci.* vol. xiv. p. 359 (1902), investigates theoretically the reflexion of electric waves at the free ends of a parallel wire system. If I understand the result aright, it means that the distance from the free end of the wire to the first node is always less than a quarter the wave-length along the wires by half the distance between them. This cannot be generally true.

Kiebitz (*Ann. der Physik*, v. 4, p. 872, 1901) has found the length of an open circle resonator when in tune with a straight-rod oscillator. The rod being 250 cms. long, 2.8 cms. was finally taken as the resonance-length for the open circle, a result slightly different from that given above, where the distance between the ends of the resonator was much greater than in Kiebitz's experiment.

Sarasin & De la Rive, as the result of their final measurements*, give the wave-length of the vibration connected with open resonators, made of stout wire 1 cm. in diameter, as 600 cms. for an open circle 23.4 cms. in circumference, and 400 cms. for one 156 cms. in circumference. This makes the wave-length 2.56 times the length of the circuit.

Macdonald, 'Electric Waves,' p. 111, in considering the question of stationary waves in open circuits, calculates the wave-length for any resonator, and finds for the fundamental mode of vibration, $\lambda_0 = 2.53l$ where l is the length of the circuit, a value in wonderful agreement with Sarasin & De la Rive's conclusions. Apparently, according to theory, the wave-length is independent, within wide limits, of the diameter of the wire of which the resonator is made, and the ratio of wave-length to length of circuit independent of the size of the circle.

By extrapolation (see fig. 2) the present experiments give, for a circle 200 cms in circumference, the ratio of perimeter of rectangle to length of circuit 2.45. This is less than the ratio of wave-length to circumference as given above by Sarasin & De la Rive for a similar-sized circle and as calculated by Macdonald. In considering the difference it is necessary to remember that extra capacity effects at the ends of the resonator may not have been altogether negligible in Sarasin & De la Rive's apparatus. On the other hand, the wave-length of the vibration connected with narrow rectangular closed circuits, made of wire of finite thickness, may be a little longer than their perimeters. Again, the wave-length

* Sarasin & De la Rive, *C. R.* vol. cxv. p. 1280 (1892).

may be affected by the diameter of the wire of which the resonators are made.

Closed Rings.—In *Ann. der Physik*, vi. 4, p. 741 (1901), Kiebitz shows how a filings-coherer may be used to determine the existence of electrical resonance. In one set of experiments, the coherer was placed across a gap in a circular resonator. The oscillator was a straight wire 77 cms. long. It is stated, as the result of these trials, that with such a resonator there is the best response when its length is equal to the wave-length of the radiation falling on it. This is asserting a little too much. The only statement justified by the experiments, on this point, is that the resonator gives the best response when its length is double that of the straight-wire oscillator.

Kiebitz's resonator must be considered a completely closed ring, and his experiment proves the possibility of inducing oscillations in connexion with such a circuit. The present experiments give a result not differing greatly from that just stated.

Turpain (*Journ. de Phys.* vol. x, p. 434, 1901), from experiments with the resonator inclosed in an exhausted glass tube, says:—"If one completely closes the gap no current circulates in the closed circuit which the resonator presents. The electric density is zero at every point of the circuit at each instant." In view of Kiebitz's experiment this statement must be considered inaccurate.

The result of the present experiments on closed rings may be stated as follows:—Taking as a standard the period of the electrical vibration associated with a narrow rectangular closed circuit, where the longer side of the rectangle is parallel to the direction of propagation of the waves, an elliptical closed circuit of very small eccentricity, with its major axis parallel to the same direction, may be considered to have the same period of electrical vibration if its perimeter is equal to that of the rectangle. If the eccentricity of the ellipse is increased, the perimeter has to be decreased to keep the period of vibration unaltered, until in the limit, when the form becomes circular, the ratio of the perimeter of the rectangle to the circumference of the circle becomes 1.11 for a circle 800 cms. in circumference, the circle being made of copper wire 0.33 cm. in diameter, and the rectangle, 30 cms. wide, of thin brass wire 0.04 cm. thick. If the form of the circuit is further altered, so that the major axis of the ellipse becomes at right angles to the direction of propagation of the waves, the perimeter has to be further decreased to keep the period unchanged.

Pocklington (Proc. Camb. Phil. Soc. vol. ix. p. 324, 1897) has calculated theoretically the period of the free electrical vibration associated with a closed circular ring, and has arrived at the result that the wave-length is rather less than the circumference of the circle. Kiebitz's experiment and the present investigation give a value rather greater than the circumference. The problem of the electrical oscillations connected with closed circuits is discussed generally by Macdonald ('Electric Waves,' p. 62), but calculations for special cases are not given.

Diameter of the Wire forming the Circuits.—St. John, in experiments with waves along wires (Phil. Mag. vol. xxxviii. 1894), for oscillations of the same period, obtains a 5 per cent. increase in the value of the wave-length along parallel copper wires as the diameter of the wires changes from 0.04 cm. to 0.12 cm. In St. John's investigation, however, the problem is complicated by the presence of extra capacity at the ends of the circuit. No difference of period has been found in the present experiments between a rectangle made of thin brass wire 0.04 cm. in diameter and one of copper wire 0.33 cm. thick. An open circle was compared with the rectangles in turn, and was in tune with each of them when its circumference was 380 cms., the perimeter of each rectangle being 886 cms. and the width 30 cms.

Permeability of the Medium surrounding the Circuits.—With the rapid alternations of current used in these experiments, it is not to be expected that the permeability of the material of the circuit would have a considerable effect on the period of vibration (see St. John, *loc. cit.*). The permeability of the medium outside the wire, on the other hand, is of primary importance in this connexion. This may be readily shown by surrounding the middle portion of an open circuit, where the current is concentrated, when electrical oscillations take place in it, with fine, well-insulated iron filings, and comparing the period of vibration with that connected with the circuit in air. In the case tried, the central part of a straight copper wire 0.33 cm. in diameter, covered with paraffined paper, passed centrally through a glass tube 70 cms. long and 1 cm. internal diameter, the tube being filled with paraffined iron filings. The wire under these circumstances when 345 cms. long had the same period of electrical vibration as a copper wire of the same gauge wholly in air 370 cms. long.

Results of present Investigation.

In the following Tables, under the headings "perimeter of rectangle" and "length of straight (or curved) wire," the
Phil. Mag. S. 6. Vol. 7. No. 42. June 1904. 2 X

respective lengths of the two circuits when the electrical oscillations connected with them are in unison, are placed in the same row, the fundamental mode of vibration only being investigated. The rectangles have been made with sides of thin brass wire 0.04 cm. in diameter, the ends being of copper wire 0.33 cm. thick. The other circuits have been constructed wholly of copper wire 0.33 cm. in diameter. From the result of an experiment described above, I believe both circuits may be considered to have been formed of the copper wire. The rectangles were in all cases 30 cms. wide.

Three methods have been used in the determinations. The results by the final one are considered of much greater weight than those by the earlier methods, and the observations have therefore been divided in the tables.

TABLE I.—Straight Wires.

| Length of straight wire. | | Perimeter of rectangle in tune with straight wire. | Perimeter of rectangle. |
|--------------------------|---------------------|--|--------------------------|
| Final method. | Earlier methods. | | Length of straight wire. |
| 310 | | 760 | 2.45 |
| | 355 | 860 | 2.42 |
| 370 | | 886 | 2.40 |
| | 400 | 955 | 2.39 |
| 445 | | 1050 | 2.33 |
| | 500 | 1165 | 2.33 |
| 520 | | 1200 | 2.31 |

The relation connecting the above observations is shown graphically in fig. 1.

Open Circles.—The ends of the circles were bare and were separated by a distance of about 15 cms., so as to avoid any appreciable capacity effect due to their proximity. A result given by Close at the end of this paper, shows that in separating the ends of a bare-ended resonator, 152 cms. in circumference, made of copper wire 0.33 cm. in diameter, practically no change is made in the period of vibration when the distance between them exceeds 8 cms. The actual length of the wire is given in the table under the heading "length of circular arc."

Fig. 1.—Straight Wires.

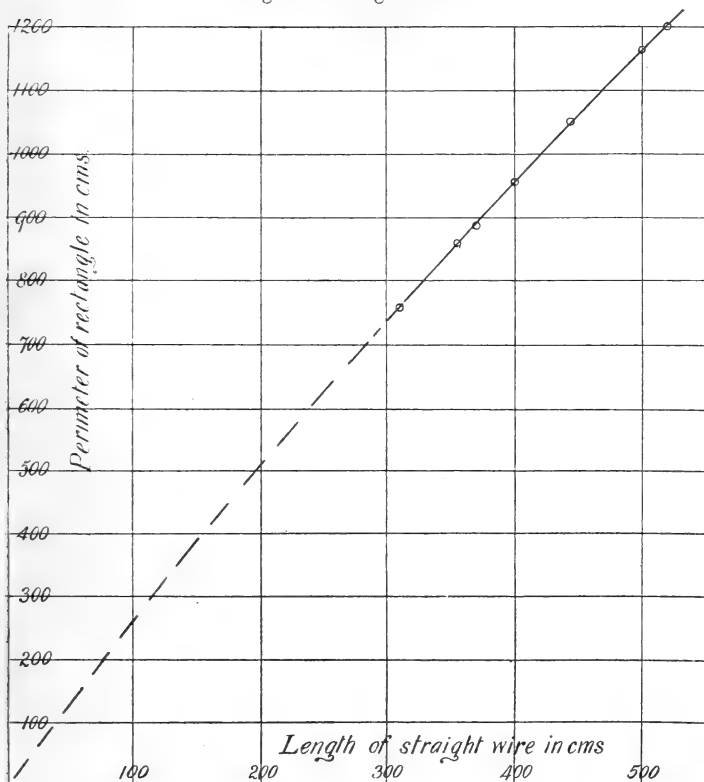
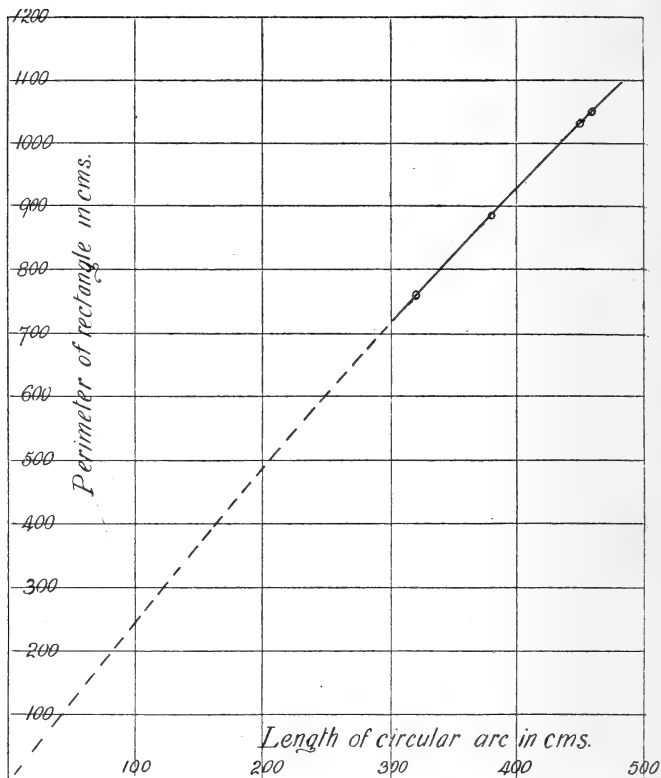

TABLE II.—Open Circles.

| Length of circular arc. | | Perimeter of rectangle in tune with circular arc. | Perimeter of rectangle. Length of circular arc. |
|-------------------------|------------------|---|---|
| Final method. | Earlier methods, | | |
| 320 | | 760 | 2.38 |
| 380 | | 886 | 2.33 |
| | 450 | 1030 | 2.30 |
| 460 | | 1050 | 2.28 |

The relation connecting these values is shown graphically in fig. 2.

Fig. 2.—Open Circles.



Closed Circuits.—In the case of other than circular circuits no attempt was made to make the shape truly elliptical, and they must be considered merely as ovals approximating to the elliptical form. The perimeter and the ratio of the major and minor axes, given in the table, sufficiently indicate their shape. The ratio given is the length of the axis parallel to the direction of propagation of the waves along the circuit to the length of the axis perpendicular to this direction.

The relation connecting the values obtained for closed circles is shown graphically in fig. 3.

TABLE III.—Closed Circuits.

| Ratio of axes. | Perimeter of circuit. | | Perimeter of rectangle in tune with circuit. | Perimeter of rectangle. Perimeter of circuit. |
|----------------|-----------------------|------------------|--|--|
| | Final method. | Earlier methods. | | |
| 6.78 | 850 | | 886 | 1.04 |
| 2.37 | 830 | | 886 | 1.07 |
| 2.33 | | 750 | 815 | 1.09 |
| 1.00 | 670 | | 760 | 1.13 |
| 1.00 | 800 | | 886 | 1.11 |
| 1.00 | | 900 | 990 | 1.10 |
| 0.69 | | 750 | 872 | 1.16 |
| 0.56 | 760 | | 886 | 1.17 |
| 0.53 | | 750 | 880 | 1.17 |
| 0.28 | | 750 | 900 | 1.20 |

Fig. 3.—Closed Circles.

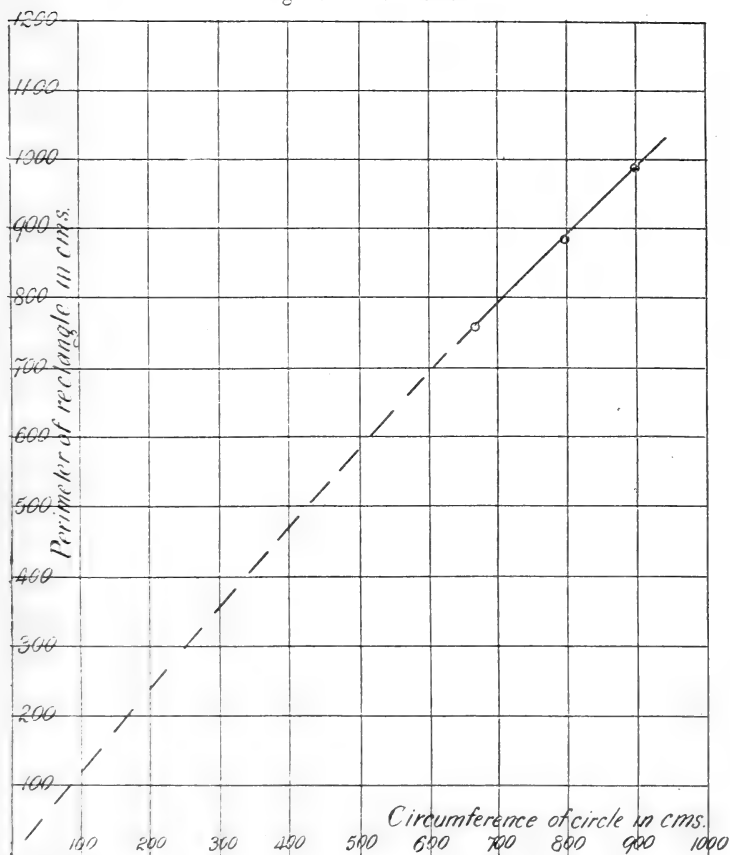

Three methods have been used in this investigation. In the first, a condenser C, with a discharge circuit *a a*, is arranged as indicated in fig. 4, the diagram not being drawn to scale.

Fig. 4.

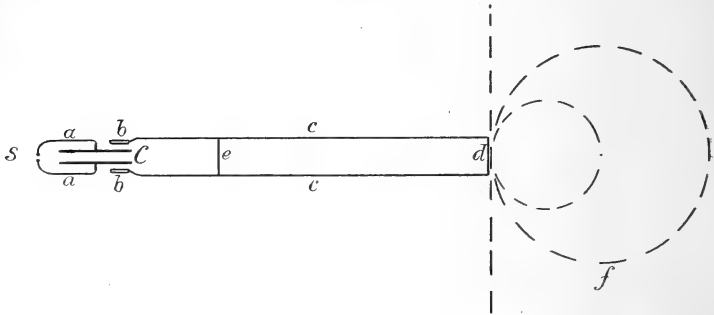

The condenser-plates are attached to wooden stands, one of which can be moved by a screw, the two condenser-plates always being strictly parallel. One of the discharge-wires is cut and connexion remade through a pool of mercury. This enables the condenser-plates to be set at any distance from each other without disturbing the spark-gap *s*. Two small hollow brass boxes, *b b*, are placed close to the condenser-plates. The boxes are provided with pegs which can be turned from the outside. To these pegs parallel wires are attached, the wires coming out through holes in the sides of the boxes. This arrangement of wires leading into hollow boxes was used by St. John*, and it enables the length of the wires to be conveniently altered without changing the capacity of the system near the condenser-plates.

The wires are bridged at their ends and at some other point as at *e*. At a distance of 1 cm. from the terminal bridge is placed a third circuit *f*, whose vibration period it is desired to compare with that of the rectangle formed by the parallel wires and the two bridges. In fig. 4 the position of various third circuits used is shown in dotted lines.

A preliminary investigation has to be made to determine the relation between the length of the wires *c c* and the distance between the condenser-plates when the wire system and the condenser circuit are in tune. The procedure is as follows:—With a given length of the wires, observations are taken of the waves along them, due to a discharge of the

* St. John, Phil. Mag. vol. xxxviii. (1894).

condenser, for different distances between the condenser-plates. That position of the condenser-plates is sought which is connected with the strongest vibration in the wire system with three nodes in its whole length. The investigation is made for various lengths of the wires, and curves are then drawn, so that for any wire-length the position of the nodes may be known, and the distance between the condenser-plates found which makes the condenser circuit in tune with the wire system. The characteristics of the waves along the wires are determined by the use of the magnetic detector invented by Rutherford, and described by him in the *Phil. Trans.* clxxxix. (1897) p. 8. The method is the same as that given by the author and Vonwiller in a paper on "Some Experiments on Electric Waves in Short Wire Systems," published in the *Phil. Mag.* for June 1902.

To determine the length of a circuit of given shape which has the same period of electrical vibration as that of a rectangle, the circuit is placed behind the bridge *d*, as shown in fig. 4, with a portion of it, at which is situated a current loop, parallel to the bridge at a distance of about one centimetre from it. In some experiments the terminal bridge has been removed and the ends of the parallel wires attached directly to the third circuit. The results have been the same in both instances.

In the case of straight wires, two small insulating tubes are placed symmetrically on the wire usually about 200 cms. apart. Each tube is encircled by a single loop of wire, the loops being attached by fine wires to mercury cups in a piece of hard rubber placed a little behind the middle of the straight wire, so that the ends of the solenoid of the detector may be joined to them. Readings with the detector are now taken on discharging the condenser, for various lengths of the parallel wires. At each adjustment of the length, the position of the bridge on the wires, and the distance between the condenser-plates, are altered by reference to the curves obtained in the preliminary investigation, so that the condenser circuit is always kept in tune with the parallel wire system. When the amplitude of the vibration in the straight wire is a maximum under these circumstances, as determined by observations with the detector, the wave-length of the vibration connected with the straight wire is considered to be the same as that associated with the rectangle formed by the parallel wires and the two bridges. Experiments with the other circuits have been made in a similar manner. A complete set of results was obtained by this method.

A second plan has been to set the condenser circuit and the

parallel wire system in tune with each other, and keeping this part of the apparatus fixed, to alter the length of the third circuit by successive steps of 10 or 20 cms. From a plot of the observations of the disturbances in the third circuit, its length when it is in tune with the rectangle may be found. This method is more satisfactory than the former one in that each successive step involves the alteration of only one of three circuits, instead of two as in that case.

In repeating the experiments by this method, the plots of the observations showed more decided maxima. When the repetition was practically completed, owing to greater accordance among the observations due to the improvement in the character of the spark resulting from greater experience in the preparation of the spark knobs, two maxima close together were noticed in the plot of the observations with one of the straight wires. As the position of the maxima could be altered by changing the condenser-plate distance, the observation pointed to a want of success in tuning the condenser and rectangular circuits, an operation of considerable difficulty, and threw doubt on the accuracy of all the previous work.

It was decided therefore, after consideration, to do away with the hollow boxes attached to the rectangular circuit, which complicate the operation of tuning, and simply place the narrow end of a fixed rectangle near the spark-gap of the condenser circuit. The tuning of the condenser and rectangular circuits now involved only a change of the condenser-plate distance. This operation was performed for three rectangles of different perimeters. It was found, however, that a want of tune between the condenser and rectangular circuits could be better detected by observations of the disturbance in the third circuit than of that in the rectangle itself.

The following procedure was finally adopted as giving the most definite results:—For a given distance between the condenser-plates, observations are taken of the disturbances in the third circuit while altering its length by successive steps. This series of observations is repeated for various distances between the condenser-plates. The plots of the observations show the relation between the disturbance in the third circuit and its length for various condenser-plate distances. That distance between the condenser-plates in connexion with which the plot shows the most definitely marked maximum, and in which the observations are perfectly symmetrical round this point, is taken as the distance which makes the condenser circuit in tune with the rectangle.

This operation of tuning the circuits is a tedious one; it has involved in some cases the comparison of fifteen complete

curves drawn from observations obtained as just described. Once the circuits are tuned, the series of observations, necessary for a determination of the length of a third circuit when in tune with the rectangle, need only be repeated until the chance of a fortuitous accordance of the observations is eliminated.

Typical examples of the curves obtained are given in fig. 5. The ordinates represent the difference of reading in cms. of the deflexions caused by the detector before and after demagnetization; they are proportional to the magnitude of the disturbances in the third circuit. Abscissæ represent the length of the third circuit, observations being usually taken for successive lengths differing by 20 cms. As the demagnetization of the detector depends, *ceteris paribus*, on the length of the spark, such curves are only wholly comparable when they represent observations taken with the same spark-gap.

In fig. 5, curve 1 is a plot of observations taken in connexion with one of the straight wires, using the solenoidal

Fig. 5.

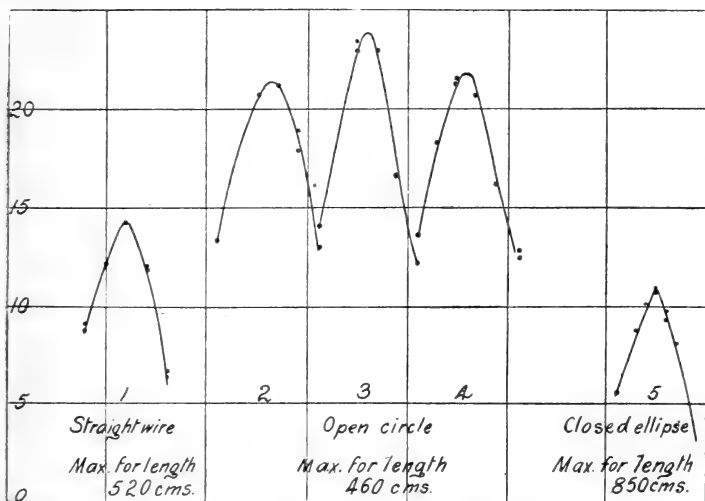

detector. Curves, 2, 3, and 4 refer to the case of one of the open circles. They are the plots of series of observations, without alteration of spark-gap, taken with condenser-plate distances successively increased by 0.1 cm., the solenoidal detector being used. For tuning the condenser and rectangular circuits thirteen such curves were obtained, the series being extended and repeated three times to avoid any chance accordance of the observations. Curve 5 is a plot of observa-

tions with a closed ellipse using the longitudinal detector (see *infra*). In this case the observations near the maximum are taken with ellipses differing in perimeter by 10 cms.

The maximum is much more definitely marked in the case of open circles than in circuits of other shapes, and here a want of tune between the condenser and rectangular circuits seems to have less effect in altering the character of the curve of the observations than in other cases. It has been found a more difficult matter to get a series of accordant observations with closed circuits than with open ones.

The Sparks in the Condenser Circuit.—Practically the only difficulty in connexion with the determination of numerical relationships in the case of Hertzian waves of small wavelength, lies with the spark which discharges the condenser. Many forms of detector are completely reliable. On the other hand, the character of the sparks is so variable and the conditions which determine it at present so obscure, that chance seems to enter largely into these investigations. Many spark-knobs have had to be tried in some cases in this research before the observations became quite accordant. To obtain a more uniform effect, a series of sparks may be taken for each observation, a method which has been used by many experimenters. As is well-known, however, only a limited number of sparks can pass between the knobs before the character changes owing to the deterioration of the discharge surfaces. In the present case, after trial, it was on the whole considered best to discharge the condenser once for each observation.

The condenser was charged from the secondary of a small induction-coil. The primary circuit of the coil was closed and opened by two keys worked by a heavy pendulum, the interruption taking place very quickly. The circuit was opened in air, the gap being short-circuited by the condenser of the coil. A variable resistance was inserted in the primary circuit, and adjusted so that when the spark-knobs were set, the difference of potential established on working the coil was just sufficient to break down the dielectric.

If the spark-gap is watched through a lens, as in these experiments for each discharge, it is seen that successive sparks jump across the gap from different points of the knobs. Their character may be either round, long, or irregular, either large or small, single or double, scarcely ever quite the same for two sparks together. The demagnetization of the detector has been found to so greatly depend on the path of the spark and on its character, that it was useless to retain any observations except in those cases where the sparks passed across the centre of the gap, and where the character was as far as could be

judged the same for all. Hundreds of observations have been rejected on account of irregularity of the spark. On the other hand, hundreds of discharges, where the sparks looked perfect, have given results utterly non-accordant.

For the earlier of these experiments the sparks passed between aluminium spheres 1 cm. in diameter. The spheres were constantly repolished and were immersed in a large bath of paraffin-oil kept well stirred. A considerable improvement resulted on replacing the aluminium spheres by small spheres of platinum made by rounding the ends of platinum wires 0.13 cm. in diameter in the oxyhydrogen flame. With a flame not too hot and with patience, little hemispheres can be finally obtained on the ends of these wires whose surface and figure seem to leave nothing to be desired. About 30 sparks can in general be taken from such ends, though many more in some cases before they require to be re-fused. In some few instances series of observations have been obtained accordant among themselves, but differing from another series with the conditions unaltered. This has been due no doubt to the apparently chance nature of the character of the spark. No result has been retained which has not been fully confirmed by repetition.

The Detectors.—For the majority of the observations, and particularly for the final ones, Rutherford's solenoidal detector has been used. In the later experiments with straight wires where the length of the wire is altered, keeping the loops of the fine wires attached to the detector at a fixed distance apart on the straight wire, as described above, tends to increase the reading for shorter lengths. Such action has been found not to affect the result. In the experiments with open circles, the loops of the detector-wires were always at the ends of the circular wire, and in those with closed circuits always at the ends of a diameter at right angles to the long side of the rectangular circuit.

To show that the length of the detector-wires does not influence the result of an experiment, the following trials were made with a straight wire :—(1) The wires to the detector, each 100 cms. long, once looped round an insulating tube on the straight wire ; (2) wires each 40 cms. long soldered to the straight wire ; (3) wires 25 cms. long soldered to the straight wire ; (4) wires 10 cms. long soldered to the straight wire. In each case the observations gave the same result, the straight wire 400 cms. long being in tune with a rectangle 955 cms. in perimeter.

Further, an exhaustive comparison has been made between the results given by the solenoidal detector and those obtained with Rutherford's longitudinal detector. The latter was made

of a piece of pianoforte steel wire 5.5 cms. long which had been dissolved in acid until its diameter was 0.014 cm. The ends of the steel wire were soldered to two pieces of copper wire each 1 cm. long and 0.33 cm. in diameter. The wire was then firmly fixed by means of the copper ends in a glass tube, the copper pieces projecting a few millimetres beyond the ends of the tube. In an experiment the detector, after being magnetized to saturation, replaced a similar length cut from the middle portion of the circuit under investigation. Connexion was made by amalgamating the copper ends which were in contact, excess of mercury always being present. The magnitude of the disturbance in the third circuit is estimated by its demagnetizing effect on the steel wire, the detector being placed after magnetization and demagnetization in a geometrical clamp with one of its poles close to the magnet of a magnetometer.

The results obtained with the longitudinal detector, in no less than 16 cases, are identical with those found with the solenoidal one, showing that the demagnetizations of the core of the latter are not affected in the present instance by any vibration peculiar to the detector circuit. This point has also been considered by Chant (*Am. Journ. Sci.* xv. p. 54, 1903). The circuits examined have been made of copper wire 0.33 cm. in diameter; the increase of inductance due to replacing 5 cms. in the central part of the circuit by the fine steel wire seems to have been negligible.

It has been found in this research more difficult to work with the longitudinal detector than with the solenoidal one. The former requires more delicate handling and a more sensitive magnetic arrangement for detecting changes of magnetization.

The experiments have been carried out in a room 10 metres long by 6 metres wide, bare with the exception of gas and water pipes round the room.

The Physical Laboratory,
The University of Sydney,
November 25th, 1903.

APPENDIX.

The Effect of Capacity at the Ends of a Circular Resonator.
By J. C. CLOSE, *Deas-Thomson Scholar in Physics.*

With a similar apparatus to that described on p. 646 of the above paper, but of smaller dimensions, the vibrations connected with open circular resonators were compared with those of a narrow rectangular closed circuit. The resonators were made of copper wire 0.33 cm. in diameter, and the wire was in all cases 152 cms. long. The rectangle was made of

thin brass wire 0.04 cm. thick, the width of the rectangles being 31 cms. The experiments were made by the first method, described on p. 647, in which the length of the resonator is kept constant, the length of the parallel wires being altered by winding the wire into the little boxes. In an experiment the length of the parallel wires was altered by steps of 5 or 10 cms., and readings taken of the disturbance in the resonator, with a Rutherford solenoidal detector, on discharging the condenser. The observations with the detector were plotted against lengths of rectangular circuit and a curve drawn freely through the points obtained. The crest of the curve has been taken as marking the length of the rectangular circuit when in tune with the open circle.

The sparks discharging the condenser passed between aluminium spheres immersed in paraffin-oil. In spite of

Fig. 6.

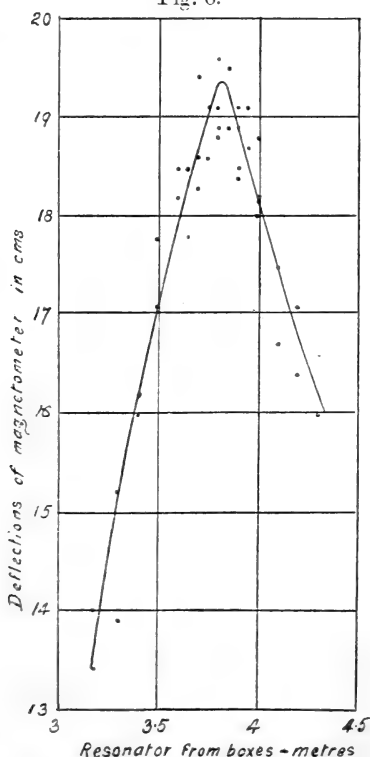

the fact that the discharge-surfaces were kept well polished, the sparks were not uniform in character; this accounts for the variations in the readings. At least two sets of observations were taken in determining the position of each crest. A specimen curve is given in fig. 6.

Observations were first taken with a resonator with bare ends, the distance between them being varied from 0.05 cm. to 4.7 cms. Two other resonators were tried, one with spheres 1.7 cm. in diameter on its ends, and the other with spheres 2.2 cms. in diameter, the length of the wire connecting the two spheres being 152 cms. long in both cases. The following is a table of the results obtained, the distance between the knobs being the length of the gap in the circuit.

TABLE IV.

| Wire-length. | Diam. of spheres at ends of wire. | Distance between surfaces of spheres. | Perimeter of rectangle in tune with resonator. |
|--------------|-----------------------------------|---------------------------------------|--|
| 152 cms. | 0.0 | 0.05 cms. | 404 cms. |
| " " | " " | 3.05 " | 387 " |
| " " | " " | 4.70 " | 387 " |
| 152 " | 1.70 cms. | 0.20 " | 425 " |
| " " | " " | 0.78 " | 420 " |
| " " | " " | 9.10 " | 396 " |
| 152 " | 2.20 " | 0.20 " | 428 " |
| " " | " " | 0.78 " | 423 " |
| " " | " " | 3.95 " | 404 " |

The relations between the values given in the above table are shown graphically in fig. 7.

Fig. 7.

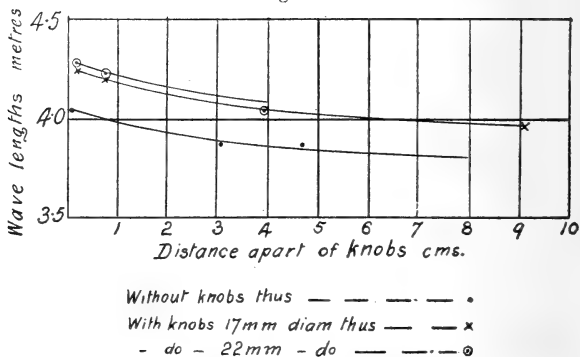

The curves show the effect of extra capacity at the ends of the resonator in increasing the period of the free vibration. The effect of bringing the ends of the resonator closer together is to increase the end capacity and hence the period. In separating the ends practically no change is made in the

period of the free vibration when the distance between the ends exceeds 8 cms. Several attempts were made to determine the period of the free vibration of the resonator with bare ends close enough for a spark to pass between them, but they were unsuccessful.

The Physical Laboratory,
The University of Sydney,
December 8th, 1902.

LXXII. *A Contribution to the Study of the Dielectric Constant of Water at Low Temperatures.* By O. U. VONWILLER, B.Sc., Demonstrator in Physics in the University of Sydney, N.S.W.*

THE experiments described in the following paper were carried out with the object of investigating the variation of the dielectric constant of water with temperature in the neighbourhood of 4° C.

C. B. Thwing (Phys. Rev. ii. p. 35) carried out some experiments which apparently showed the existence of a critical point at 4° C., the dielectric constant rising to a maximum value at that point and then decreasing as the temperature rose. On the other hand, Drude (Wied. Ann. lix. 1896) and other experimenters have not observed such an effect.

The author's experiments were carried out with electrical oscillations having a frequency of about 25 millions per sec., produced in a Lecher wire-system by the oscillatory discharge of a condenser.

The arrangement of the apparatus is shown in fig. 1. A

Fig. 1.

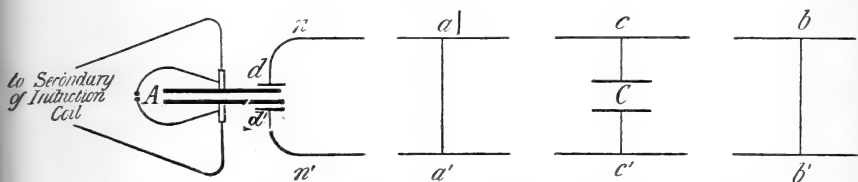

is a condenser consisting of two parallel circular brass plates, 30 centimetres in diameter, connected to the ends of the secondary of an induction-coil.

This condenser is discharged by means of a spark between two aluminium knobs immersed in kerosene, and joined to

* Communicated by the Author. Read before the Royal Society of New South Wales.

the condenser plates by brass rods 3 millimetres thick and 30 centimetres long, bent into an approximately circular form. Two brass plates, dd' , 8.8 centimetres in diameter, are held 8 millimetres from the plates of A, and attached to them are brass wires $db, d'b'$, .36 millimetre in diameter and 30 centimetres apart except the parts $dn, d'n'$, each 27 centimetres long, where the wires curve in. Two bridges of copper wire aa' and bb' are placed across these brass wires. The circuit $daa'd'$ is called the Primary, and $abb'a'$ the Secondary. Across the wires is placed a light wooden slider, the wires passing through small glass tubes attached to it; round each of these tubes is a single loop of wire which leads to the terminal of a Rutherford detector, the deflexions produced by which on a magnetometer were used in determining the character of the oscillations set up in the wires. The details of the detector and the method of using it are similar to those described by Prof. Pollock and the author in their experiments on Electric Waves in Short Wire Systems (Phil. Mag. June 1902).

With the bridge $a a'$ at a distance of 170 centimetres from $n n'$, the wooden slider carrying the detector being 5 centimetres from nn' , the capacity of A was altered by varying the distance between the plates until the primary was in resonance with the condenser vibration, the deflexions produced by the detector being greatest when this is the case.

The effective length of the primary is now $\frac{\lambda}{2}$, where λ is the wave-length of the condenser radiation. By altering the position of the bridge bb' the secondary can be brought into resonance with the primary, this being the case when its effective length is λ , the correct position being determined by keeping the slider midway between the two bridges, *i. e.* at a loop of the wave, and altering the length of the circuit until a maximum deflexion is obtained.

In these experiments a condenser C was placed across the wires of the secondary at some place cc' . The effect of this capacity is equivalent to an addition to the length of the wires, the wave-length of free vibrations in the circuit $abb'a'$ being given by λ in the equation

$$\cot \frac{2\pi a}{\lambda} + \cot \frac{2\pi b}{\lambda} = \frac{2\pi C}{\lambda s},$$

as shown by Morton (Phil. Mag. May 1897). a and b being the distances from the middle points of the bridges aa' and bb' respectively to the condenser, C the capacity of the

condenser, and s the capacity per unit length of the two parallel wires.

If the secondary is in resonance with the primary, a change in the capacity of C will throw it out of resonance, and the deflexions produced by the detector will be smaller. An investigation of Morton's formula shows that a given percentage change of capacity produces the greatest proportionate change in the effective length of the circuit when $a=b=\lambda/8$, the effect of the capacity being thus equivalent to an addition of $\lambda/2$ to the length of the circuit.

It has always been observed, however, that when the primary and secondary are in resonance a comparatively great change in the effective length of the secondary is necessary to produce an appreciable change in the deflexion; but when the two circuits are not in tune, the deflexions vary by a considerably greater amount for a given alteration of length of secondary.

In order to determine the conditions under which the greatest change in deflexion results from a given percentage change in the capacity of C , a series of trials was made with an air-condenser consisting of two circular zinc plates 30 centimetres in diameter, the capacity of which was varied by altering the distance between the plates. In these trials a and b were given various values, and as a result it was found that the highest degree of sensitiveness was obtained when $a=b=\frac{\lambda}{8}$ approximately, the capacity being much too large to give good resonance.

With this arrangement the slider with the detector was placed close to the condenser, the detector was thus practically about halfway between the bridge and the middle of the circuit, *i. e.* halfway between a node and a loop of the wave, and so the deflexions obtained were really considerably smaller than if it could have been placed at the loop.

A condenser with water as its dielectric was now attached to the wires in the position where the best results were obtained with the air-condenser: here $a=b=300$ centimetres, and the slider was between a and c and distant 5 centimetres from the latter point. The condenser consisted of two wires similar to the main wires, and each 25 centimetres long. These wires first ran horizontally towards one another and then were bent vertically downwards at a distance varying in different experiments from 9 to 11 centimetres apart, dipping into water placed in a large glass vessel.

With the water at the temperature of the room, the depth to which the wires were immersed was varied by increasing

or decreasing the amount of water in the vessel, and so varying the capacity. The depth was altered until the deflexion obtained was about the same as that obtained with the air-condenser when its capacity was such that the arrangement was in its most sensitive state. The water was then removed and ice-cold water poured into the vessel to the same level, and readings taken at frequent intervals as the temperature rose, the temperature of the water being observed on two mercury thermometers, and the water being continually stirred.

As the temperature rose the change of capacity was indicated by a change in deflexion. Between 0° and 15° there was on the whole a decided increase in deflexion, showing a decrease in capacity; but in these earlier experiments, owing to irregularities in sparking it was impossible to say definitely whether the deflexion at 4° was higher or lower than that at 0° , the variation in successive sparks being so great as to mask the change between these points.

On several occasions there appeared to be an indication of a minimum deflexion in the neighbourhood of 4° ; but on other trials, apparently equally reliable, this result was not obtained. In any case the variation of capacity necessary to produce the apparent change would have been very small—much smaller than that obtained by Thwing, which would have produced an unmistakable change.

Single sparks only were taken, the deflexions thus obtained being more regular on the whole than those in which a series of sparks were taken for each observation.

In order to obviate this variation of deflexion due to the irregular sparking, another slider and detector were placed near the open end of the primary, and the deflexions produced by this detector on a second magnetometer were observed. These deflexions should have been constant. With the secondary unchanged, when a series of readings were taken, although the deflexions produced by either detector varied considerably, the ratio of the two deflexions was found to vary to a much less extent.

The following table shows a set of four readings of deflexions of primary and secondary detectors, and the ratio of the two, no change being made during the four readings:—

| δ_p . | δ_s . | $1000 \delta_s / \delta_p$. |
|--------------|--------------|------------------------------|
| 31.5 | 28.7 | 911 |
| 37.1 | 33.5 | 903 |
| 34.4 | 31.8 | 924 |
| 32.5 | 29.6 | 911 |

δ_p being the deflexion produced by the detector in the primary, and δ_s the deflexion produced by the detector in the secondary.

Accordingly, in subsequent experiments the deflexions produced by detectors in both primary and secondary were taken after each spark, and the variation of the ratio of the two observed.

These experiments all indicated a continuous fall in capacity as the temperature rose, at least no marked critical point at 4° C. being shown.

In order to ascertain the extent of the change of capacity, a condenser consisting of two circular brass plates, 30.2 centimetres in diameter and .755 centimetre thick, which could be moved apart in a direction perpendicular to their planes, was substituted for the water condenser, and observations were taken with the plates at different distances apart. The capacities at these distances were calculated by Kirchhoff's formula :

$$c = \frac{r^2}{4a} + \frac{r}{4\pi a} \left\{ -a + a \log \frac{16\pi r(a+d)}{a^2} + d \log \frac{a+d}{d} \right\}^*$$

where r is the radius of the plates, a their distance apart, and

Fig. 2.

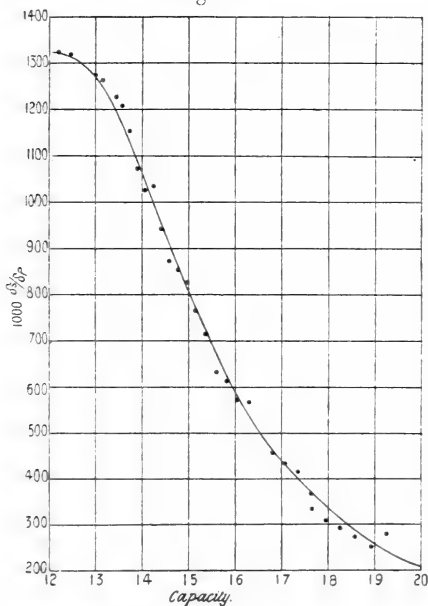

d their thickness ; and the resulting curve between capacities and the ratio $1000\lambda \delta_s/\delta_p$ is shown in fig. 2. This curve

* *Abhandl.* p. 112.

shows how the sensitiveness for a given change of capacity decreases as we approach the position of resonance.

Figs. 3, 4, 5, and 6 were now drawn, in which the abscissæ represent temperatures, and the ordinates the capacities of

Fig. 3.

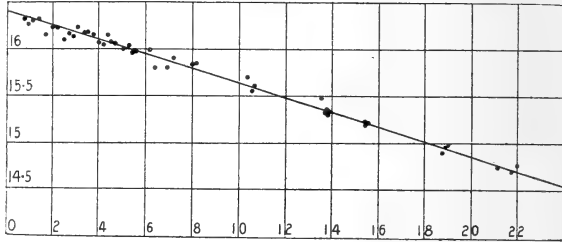

Fig. 4.

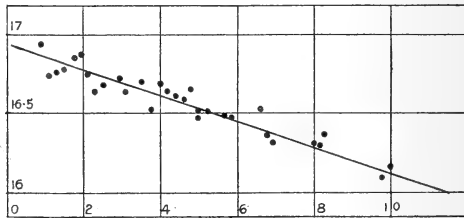

Fig. 5.

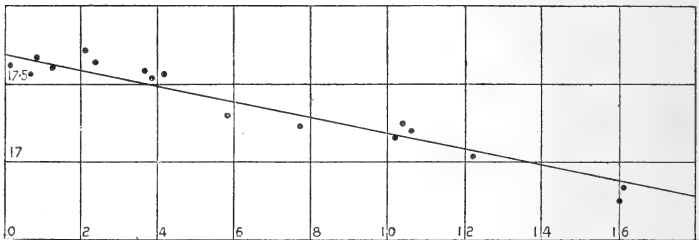
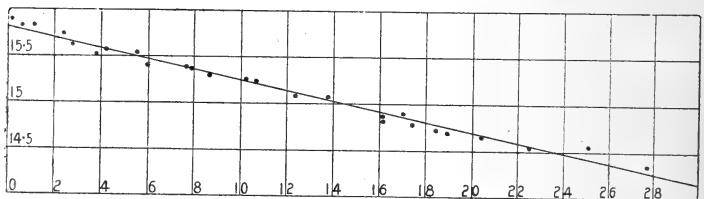

Fig. 6.



the water-condenser, the capacities being obtained from the curve in fig. 2 for the values of $1000 \times \delta_s / \delta_p$ obtained at

the various temperatures. In all these curves there is to be noticed a decided fall in capacity as the temperature rose ; and the curves are practically straight lines.

The change of capacity for 1° rise in temperature, expressed as a percentage of the capacity at 0° C., obtained from the different curves is :

| | |
|-------------------|------|
| From fig. 3 . . . | .464 |
| „ fig. 4 . . . | .478 |
| „ fig. 5 . . . | .287 |
| „ fig. 6 . . . | .344 |

The dielectric of the condenser consisted partly of air and partly of water, the wires being out of the water for a considerable part of their length ; and as the variation affected only the water, the total percentage change of capacity is less than that of the dielectric constant of the water.

In the first two trials recorded above the water was placed in a large glass vessel 25 centimetres square, and the depth of water in it was about 15 centimetres ; but in the other two the water was placed in a beaker 15 centimetres in diameter and the depth of water was about 15 centimetres : so in this case the air would have a greater relative share in the whole effect, and the observed change is less than in the former trials, where the variation in capacity is probably very nearly equal to the variation in the dielectric constant of water. In all four trials the wires were immersed to a depth of 5 or 6 centimetres, and were from 9 to 11 centimetres apart.

The assumption has been made that when the same deflexion is obtained with the water- and air-condensers, the capacities are the same. By removing water from the vessel, and so decreasing the capacity, we can come into a position of resonance ; and it was found that the maximum deflexions obtained when this was done were practically the same as the greatest deflexions obtained with the air-condenser, and so the conductivity of the water has no appreciable effect and the above assumption is probably permissible.

The specific conductivity of the water was measured, and found to be 3.7×10^{-6} at 18°·8 C.

These results show no indication of the large effect observed by Thwing at 4° C. With the exception of the results shown in fig. 5, all the observations are definitely lower at 4° than at 0°. According to Thwing the dielectric constant at 0° is 79·4 and at 4° 85·20, *i. e.* it increases by 7·2 per cent. In fig. 3 the capacity at 0° is 16·39 ; if it were 7·2 per cent. higher at 4°, the capacity would be 17·51 at that temperature.

An inspection of the curves shows that any change of that order could not fail to be detected.

In conclusion, I desire to express my best thanks to Professor Pollock for many valuable suggestions and for his continued encouragement during the work.

The University of Sydney.

LXXIII. *On the Vapour-Pressure of Mercury at Ordinary Temperatures.* By EDWARD W. MORLEY*.

IN 1890, when attempting to determine the density of hydrogen with accuracy, it became convenient to know the vapour-pressure of mercury at ordinary temperatures. There were extant two series of actual measurements at such temperatures, and four computations of the desired values from extrapolation formulæ founded on observations at higher temperatures.

The first of these computations was due to Regnault †, and was published by him in 1862. A second and a third were published by Hagen ‡ and by Hertz § in 1882. Ramsay and Young || published the fourth in 1886.

Regnault also made a few observations at temperatures below 100°, which were published with those mentioned above. They seem to have been of service only in guiding conjecture as to the vapour-pressure which was assumed for 0°. Lastly, van der Plaats ¶ in 1886 published direct determinations of the vapour-pressure at 0° and at the temperature of his laboratory.

The following table gives the vapour-pressure of mercury at certain temperatures according to these authorities :—

| Temp. | Regnault. | Hagen. | Hertz. | Ramsay & Young. | van der Plaats. |
|-------|---------------|--------------|----------------|-----------------|-----------------|
| 0 | mm. 0·0200 | mm. 0·015 | mm. 0·00019 | mm. ... | mm. 0·0047 |
| 10 | 0·0268 | 0·018 | 0·0005 | ... | 0·008 |
| 20 | 0·0372 | 0·021 | 0·0013 | | |
| 30 | 0·0530 | 0·026 | 0·0029 | | |
| 40 | 0·0767 | 0·033 | 0·0063 | 0·008 | |
| 50 | 0·1120 | 0·042 | 0·013 | 0·015 | |

* Communicated by the Author.

† *Relation des Expériences*, ii, p. 506.

‡ Wiedemann's *Annalen*, xvii. p. 618.

§ *Ibid.* xvii. p. 197.

|| Chem. Soc. Journal, xlix. p. 37.

¶ *Recueil des Travaux Chimiques des Pays-Bas*, v. p. 149.

These results, at first sight, seem to leave the whole matter very doubtful. The figures for 0° , for instance, differ in the ratio of 1, 25, 75, and 100.

The case is altered when we examine critically the different series of experiments. Regnault's values may first be dismissed from consideration. His value for 0° is simply *assumed* as differing from the truth by a negligible quantity; but the precision needed now is greater. Values for temperatures other than 0° depend on an interpolation formula computed from values for 0° , 128° , 256° , 384° , and 512° . But Regnault had much difficulty with the observations at high temperatures, and the determinations were few and not concordant. Even if the true form of the function which expresses the relation between temperature and vapour-pressure were known, Regnault's determinations would not, in the case of mercury, give values for the constants of the formula accurately enough for present needs; and he used only an empirical interpolation formula. Admirable as was his work, we have here to do with quantities which are smaller than the limits of accuracy which he claimed for such measurements.

Hagen's measurements may also be disregarded. He determined the difference of level between the two arms of an exhausted syphon-gauge, one of which was connected with a vessel kept at a temperature at which the vapour-pressure of mercury may be considered negligible. He made numerous experiments as nearly as convenient to the temperatures of 0° , 50° , 100° , 150° , and 200° . By least square computations, he obtained the pressures corresponding to these precise temperatures; from which normal values an interpolation formula was calculated. The determinations for the two higher temperatures were known to be in error on account of the rapidity of the evaporation from the surface of the mercury. The work satisfactorily proved that the values given by Regnault below 100° were much too large. But Hagen's values cannot be accepted, if for no other reason, at least because his interpolation formula is too inconsistent with what we know of the behaviour of saturated vapours. The percentage increase of pressure due to an increase of temperature by ten degrees diminishes with increasing temperature; but Hagen's table gives an increase of 46 per cent. between 90° and 100° , while that from 0° to 10° is only 17 per cent.

The experiments of Hertz were made with care, and their principle was satisfactory. When a liquid evaporates into a gas whose pressure is greater than that of the saturated vapour of the liquid, the vapour very near the surface of the liquid

is very nearly saturated. If, at a given temperature, the liquid is brought to the same level in the two arms of a differential manometer containing only the saturated vapour of the liquid in one arm, and containing some gas in the other, a measurement of the pressure of the gas determines that of the saturated vapour. The uncertainty of the observations was 0.02 mm. An interpolation formula was computed from the observations at temperatures from 89° to 206° , and it would be difficult to improve his results until the very small quantities which represent the vapour-pressure of mercury at ordinary temperatures are made to depend, not on a somewhat remote extrapolation, and an extrapolation from values whose errors are many times as large as the quantities sought, but on direct measurement.

The measurements of Ramsay and Young are also very satisfactory for temperatures above 100° . The ratio of the absolute temperatures of water and of mercury having the same vapour-pressures varies so regularly, that if it is determined for a few temperatures, it is known for all temperatures. From this ratio and from the well-known vapour-pressures of water, they computed the vapour-pressure of mercury for temperatures from 135° to 520° . Below 135° the method could not be used, because the corresponding vapour-pressures of water are not well known; they therefore determined an extrapolation formula from the values for 160° , 220° , and 280° , from which they computed values for temperatures down to 40° .

We have, therefore, a determination by Hertz covering the interval from 0° to 100° , and one by Ramsay and Young for the interval from 40° to 100° . From 50° to 100° the mean difference between the two values is only 6.5 per cent. The mean difference between the values of the same experimenters from 120° to 220° is 8.6 per cent.; so that the agreement from 50° to 100° is satisfactory. But at 40° the difference is 27 per cent.

The observations of van der Plaats were made at the temperatures in question, and were numerous and careful. He passed a known volume of an inert gas through pure mercury in such a way as to saturate it with the vapour of mercury. The mercury was then collected by absorption and weighed. It is not easy to suggest a cause tending to make values obtained in this way larger than the truth. But it was and is impossible to accept them. The results at 0° and 10° are twenty-five and sixteen times as large as those of Hertz. Hertz found it impossible to detect the vapour-pressure of mercury below 50° . But if the values of van der

Plaats are right there would have been no difficulty in detecting it even at 30°.

I have made two series of determinations of the vapour-pressure of mercury, one before the publication by van der Plaats, and one recently. A known volume of a dry and inert gas was passed through a weighed quantity of mercury in such a way as to saturate it with the vapour. The volume of the gas when reduced to the temperature of the mercury gave the volume of the saturated vapour; the loss of weight by the mercury gave the weight of this saturated vapour. From this can be computed the pressure of the vapour with sufficient approximation.

In the earlier observations the mercury was kept in a room whose temperature changed but little, and this temperature was learned from the trace made by a registering thermometer. The mercury had been repeatedly treated with nitric acid and repeatedly distilled in a vacuum. It was put in a spiral absorption-tube of the form devised by Winkler. The counterpoise was made up of an equal volume of glass and an equal volume of mercury. Carbon dioxide was obtained from a drum containing the liquid, dried with phosphorus pentoxide, and passed through the mercury at the rate of not more than two litres an hour. The gas escaping from the absorption apparatus was measured with an experimental gas-meter. Each experiment continued about two weeks; the loss of weight of mercury in this time was from 2.5 mg. to 4.0 mg. The values obtained for the vapour-pressure of mercury at a temperature a little below 16° C. were 0.0009 mm., 0.0010 mm., 0.0012 mm., and 0.0010 mm. This being sufficient for my purpose at the time, the experiments were discontinued.

Recently they have been resumed and carried to temperatures as high as 70°. In this series, a large vessel of water was kept at a constant temperature by means of a thermostat, the water being thoroughly stirred by a small screw-propeller driven by an electric or a hydraulic motor. In the water was a metallic enclosure containing the two Winkler absorption-tubes filled with mercury; the mercury was purified as in the earlier experiments. Carbon dioxide was produced from hydrochloric acid and marble, washed in a saturated solution of sodium acid carbonate, and dried with phosphorus pentoxide. The rate of flow was regulated by fusing into the glass part of the connecting tubes a capillary tube of such diameter and length as was found suitable, since a stop-cock changes its rate of delivery too quickly. After the gas had passed through the two absorption apparatus, its

volume was determined by means of two experimental gas-meters.

One experiment at 50° was lost by projection of mercury, and when the experiment was repeated, it was so done as to give convincing proof that the current of gas used was perfectly saturated with mercurial vapour. Two absorption apparatus were put in series. Hydrogen was produced by the action of hydrochloric acid on zinc, washed with solution of potassium hydroxide, and dried with phosphorus pentoxide. The regulated current passed first through one of the two absorption apparatus; since it required a pressure of one inch of mercury to force the gas through the second apparatus, the volume of the gas was now one thirtieth less than it became after passing through the second absorption apparatus. If, then, the gas was saturated with mercurial vapour in the first apparatus, it would still take up one twenty-ninth as much mercury in expanding to its final volume in the second absorption apparatus. By reference to the second experiment at the temperature 50°, it will be seen that the quantity taken up from the second absorption apparatus was this twenty-ninth part, and that therefore it is satisfactorily proved that the current of gas was perfectly saturated with vapour of mercury. It may be added that, after a few hours, the current of gas always passed through the mercury in a thin film and not in bubbles, and that the diffusion of vapour through this thin film could not but be rapid.

The following table gives the temperature of the mercury and of the gas-meter in each experiment, the volume of gas at the meter and in the act of passing through the mercury, the loss of weight of the mercury, and the loss for one litre of gas:—

| Temp. of mercury. | Temp. of gas-meter. | Volume at meter. | Volume at mercury. | Loss of weight of mercury. | Loss per litre. |
|-------------------|---------------------|------------------|--------------------|----------------------------|-----------------|
| | | L. | L. | mg. | mg. |
| 40·0 | 13·6 | 297·7 | 325·2 | 17·25 | 0·053 |
| " | " | 257·0 | 280·7 | 15·57 | 0·056 |
| 60·0 | 10·3 | 153·2 | 176·7 | 36·60 | 0·207 |
| " | " | 115·0 | 132·6 | 27·15 | 0·205 |
| 70·0 | 19·0 | 105·2 | 123·6 | 46·89 | 0·379 |
| " | " | 91·3 | 107·2 | 40·31 | 0·376 |
| 50·0 | 18·5 | 147·5 | 163·5 | 18·11 | 0·111 |
| " | 17·0 | 228·0 | 253·9 | { 27·8 0·9 } | 0·113 |
| 30·0 | 16·4 | 246·1 | 257·8 | 7·35 | 0·0285 |
| " | 16·7 | 288·7 | 301·9 | 8·23 | 0·0273 |

The following table gives the mean values adopted for each

temperature, the weight of one litre of a hypothetical mercury vapour having a vapour-pressure measured by one millimetre of mercury, and the actual pressure corresponding to the weights of vapour observed. There is added a series of values computed from the formula

$$p = ab^t, \text{ in which } \log a = \bar{4}.6064, \text{ and } \log b = 0.02856,$$

which agrees sufficiently well with the observations.

| Temperature. | Weight of one litre of mercury vapour. | Weight of one litre of mercury vapour at 1 mm. | Vapour-pressure, observed. | Vapour-pressure, computed. |
|--------------|--|--|----------------------------|----------------------------|
| 0 | mg. | mg. | mm. | mm. |
| 0 | ... | ... | ... | 0.0004 |
| 10 | ... | ... | ... | 0.0008 |
| 16 | ... | ... | 0.0010 | 0.0012 |
| 20 | ... | ... | ... | 0.0015 |
| 30 | 0.028 | 10.60 | 0.0027 | 0.003 |
| 40 | 0.054 | 10.26 | 0.0052 | 0.006 |
| 50 | 0.112 | 9.94 | 0.0113 | 0.011 |
| 60 | 0.206 | 9.65 | 0.0214 | 0.021 |
| 70 | 0.378 | 9.37 | 0.0404 | 0.040 |

It will be observed that the formulæ of Hertz and of Ramsay and Young give values comparing well with the results of actual measurements, except Hertz's values for 0° and 10°, which are sensibly too small, though the difference is expressed in ten-thousandths of a millimetre. The values given by van der Plaats are ten times as large as my own; the latter have now been found the same, in experiments made in three different years and with many modifications of apparatus.

LXXIV. *On the Principles of Aerodynamics and their Application, by the Method of Dynamical Similarity, to some special Problems.* By Prof. M. SMOLUCHOWSKI-SMOLAN, Ph.D., LL.D., University, Lemberg*.

§ 1. **W**HAT is the characteristic feature of aerodynamics, contrasting it with hydrodynamics? Compressibility, of course; but it is not mere isothermic compressibility which makes up the difference: there comes in, in general, as a factor of equal order of magnitude, variation of temperature, as produced by the motion of the gas.

To appreciate its importance, consider, for example, the difference between Newton's and Laplace's formula for the

* Communicated by the Author.

velocity of sound, and St. Venant & Wantzel's experiments* on effusion of gases, extended and confirmed by many subsequent authors, by which these phenomena have been shown to differ widely from what the isothermic theory maintains. In fact, the isothermic theory has to be limited to the few exceptional cases of slow viscous motion, where conduction of heat is prevalent; transpiration through capillary tubes and slow oscillations of pendulums seem to be the only examples of practical importance.

In the two cases alluded to, and in most others, heat of adiabatic compression † is a prominent factor; but, in general, the heat produced by internal friction is no negligible quantity either. It was sufficient in Joule and Kelvin's plug experiments to annul the cooling by expansion, and in other experiments of those authors (Kelvin, *Math. Phys. Papers*, i. pp. 351, 400, 445) to produce considerable heating effects.

§ 2. In hitherto published papers and treatises on aerodynamics, isothermic formulas and adiabatic ones are to be found, but no proofs of the thermic supposition underlying them; some authors, after explaining both theories, satisfy themselves with the statement that reality probably will be contained between those thermic extremities—a rather rough and unsatisfactory way of speculating.

It is impossible, indeed, to develop a reasonable theory of these phenomena, unless we unite the mechanics with the thermodynamics of the subject. Such is the starting-point for the following considerations, being contributions to what may be called "exact" aerodynamics.

The thermodynamics of our case are contained in an equation which appears, in its complete form, for the first time in 1894, derived from somewhat specialized kinetic considerations by Kirchhoff and Natanson, in a more general way by Neumann ‡. It follows easily from the principle of conservation of energy: by equating the increase of internal energy (caloric, kinetic, potential) of an element of mass, on its path:

$$\frac{D}{Dt} \left[\frac{c}{A} \theta + \frac{u^2 + v^2 + w^2}{2} + U \right],$$

* *J. d. l'Ecole Polyt.* xvi. p. 92 (1839); see *ex. gr.* Wilde, *Phil. Mag.* xx. p. 531 (1885), xxi. p. 494 (1886).

† In acoustics it is predominant, above all others, there taking it into account is sufficient for a first approximation, and this is the only part of aerodynamics, therefore, where a systematic theory has been built up.

‡ Kirchhoff, *Vorlesung. ü. Wärme*, p. 194 (1894); Natanson, *Bull. Acad. Cracovie*, 1895; Neumann, *Gött. Ber.* 1894, p. 19.

to the quantity of heat transferred into it by conduction and to the work done by the stresses on its surface, which last term may be calculated in known manner (Lamb, Hydrodyn. p. 517).

Thus we get, using div and $\frac{D}{Dt}$ as symbols for

$$\frac{\partial u}{\partial x} + \frac{\partial v}{\partial y} + \frac{\partial w}{\partial z} \text{ and } \frac{\partial}{\partial t} + u \frac{\partial}{\partial x} + v \frac{\partial}{\partial y} + w \frac{\partial}{\partial z} \text{ respectively,}$$

$$\frac{c}{A} \rho \frac{D\theta}{Dt} = -p \text{ div} + \Phi + \kappa \Delta^2 \theta, \dots \quad (1)$$

where the first term on the right side represents the effect of adiabatic expansion, the second one the dissipation function of viscosity

$$\Phi = -\frac{2}{3} \mu \text{div}^2 + \mu \left\{ 2 \left[\left(\frac{\partial u}{\partial x} \right)^2 + \left(\frac{\partial v}{\partial y} \right)^2 + \left(\frac{\partial w}{\partial z} \right)^2 \right] \right. \\ \left. + \left(\frac{\partial w}{\partial y} + \frac{\partial v}{\partial z} \right)^2 + \left(\frac{\partial u}{\partial z} + \frac{\partial w}{\partial x} \right)^2 + \left(\frac{\partial v}{\partial x} + \frac{\partial u}{\partial y} \right)^2 \right\},$$

the third one the effect of thermic conduction.

This equation, which with regard to the equation of continuity may be written in the more convenient form

$$\frac{Dp}{Dt} + kp \text{ div} = (k-1) [\Phi + \kappa \Delta^2 \theta], \dots \quad (2)$$

denoting by k the ratio of specific heats, has to be added to the usual equations of motion.

If the gradients of temperature are considerable, however, these latter ones are to be corrected by additional expressions arising from the thermal variability of viscosity. In this, most general, case they take the rather clumsy form:

$$\rho \frac{Du}{Dt} = \rho X - \frac{\partial p}{\partial x} + \mu \left[\Delta^2 u + \frac{1}{3} \frac{\partial \text{div}}{\partial x} \right] + 2 \frac{\partial \mu}{\partial x} \left[\frac{\partial u}{\partial x} - \frac{1}{3} \text{div} \right] \\ + \frac{\partial \mu}{\partial y} \left[\frac{\partial v}{\partial x} + \frac{\partial u}{\partial y} \right] + \frac{\partial \mu}{\partial z} \left[\frac{\partial w}{\partial x} + \frac{\partial u}{\partial z} \right]. \dots \quad (3)$$

Three such equations, the equation of continuity, the law of Boyle-Charles, equation (2), constitute the fundamental equations of aerodynamics.

It is useless, of course, trying to get exact solutions of this system, unless for very specialized conditions. Some examples of this kind have been given in a paper of mine, published in the *Bullet. d. l'Acad. Cracovie*, 1903, together with some applications of the method of successive approximations,

which is characterized by a considerable generality, and is the only hitherto known general method of dealing with such problems. Its practical use, unfortunately, is rather limited, and we see no way yet leading to explicit solutions of the most important problems of aerodynamics, such as resistance of bodies in rapid motion, or flow of gases through wide tubes, where turbulent motions play a prominent part.

§ 3. There are to be noted, however, some results obtained by application of the fundamental equation (2) to such cases as the last-named one, which present some interest, as correcting in several respects the common opinion on the thermal effects in outflowing gases.

Thus it cannot be proved, as I have shown (*loc. cit.*), that stationary flow of a perfect gas leaves its temperature unchanged. This is true only for the mean temperature of the outflowing gas—in parts where its motion is sufficiently slow and uniform, supposing the walls of the tube to be heat insulators,—but its different stream-lines may be heated or cooled.

If the gas is flowing out from a closed reservoir, its temperature, after having passed the “rapids,” will be identical—with the same restrictions—with that of the gas contained in the reservoir, cooling down according to the adiabatic formula. But, contrary to common opinion, the use of this formula for viscous gases in motion is erroneous. It has to be replaced by an approximate equation, valid under certain restrictions for every stream-line:

$$\frac{kR}{k-1} (\theta_0 - \theta) = \frac{u^2 + v^2 + w^2}{2}$$

which is not identical with the adiabatic law, except for ideal gases.

These results concerning the thermal effects do not give us much help, however, in unravelling the complicated laws of such motions themselves, as defined by our system of equations. It does not seem probable, indeed, that theory of aerodynamics will soon surpass the experimental methods in efficiency; and we must still apply to these latter ones as the chief sources of knowledge for the present.

§ 4. The more important seems to me a simple method of reasoning, founded on the above equations, by which exact conclusions can be derived in many cases, and which often proves useful by verifying experimental results or by extending their range. This is the method of “mechanical” or “dynamical similarity,” which, being closely allied with

the well-known method of dimensions, seems to have been used for the first time in hydrodynamics by Helmholtz, but has not yet been made use of for "exact" aerodynamics.

It consists in examining what solutions can be derived from a known solution, by magnifying the variables in certain constant proportions and by a suitable change in the constant coefficients.

As examples* of, partly exact, partly approximate, application in hydrodynamics may be quoted:—The criterion for the validity of Poiseuille's law (Helmholtz, *Wied. Ann.* vii. p. 375 (1879); Reynolds, *Phil. Trans.* clxxiv. (1883), clxxxvi. (1895)); or the criterion for the formula of viscous resistance for a sphere moving through liquid (Lamb, *Hydrod.* p. 533), and Froude's calculation of ship resistance. There ought to be mentioned, too, Boussinesq's investigation (*Journ. de Physique*, i. p. 65, 1902), on the cooling effect of currents raised in various liquids by a heated body—which I believe to be erroneous, however, as depending on the equations for ideal liquids, and wanting complete alteration in the manner of § 14,—and two papers of Helmholtz, connected with "rough" aerodynamics.

One of them (*Ges. Abh.* iii. p. 309) contains his most suggestive theory of cloud-waves; it belongs to the class of "approximate" applications, however, as resting on the equations for irrotational motion of incompressible fluids, with neglect of viscosity and capillarity, which seem to play no insignificant part in the formation of waves on water by wind.

The other paper (*Ges. Abh.* i. p. 158), dealing with dynamical similarity in aerodynamics in general, and with the analogy of ship-resistance to balloon-resistance in particular, gives cause to most serious objections. The general considerations are limited by the supposition of isothermal compressibility, excluding by itself nearly all practical applications, and by the tacit supposition of small changes of pressure. The application to the comparison of ships and balloons is vitiated, besides, by neglect of viscosity (which would imply no resistance at all for constant velocity in liquids), by a fatal slip in the numerical suppositions, lastly by neglect of gravitational ship-waves, differing widely from compressional balloon-waves.

Generally speaking, there may exist some rough analogy between motions of liquids and gases in some cases, but no

* Fuller details concerning this question are given in a paper contained in *Prace mat. fiz. Warsz.* xv. (1904).

exact similarity in the sense above defined, which we are going to set out in detail in what follows.

§ 5. In order to get the necessary conditions to be fulfilled by similar motions of gases, let us substitute the new variables $mx, my, mz, nu, nv, nw, \frac{m}{n}t, h\theta, bp$, and the coefficients $\frac{R}{\alpha}, \beta\mu, \gamma\kappa$ for the variables $x, y, z, u, v, w, t, \theta, p$ and coefficients R, μ, κ respectively. Evidently the coefficient k cannot be changed; motions of gases with different values of k cannot display exact similarity. All the following considerations are limited, therefore, to gases with the same value of k .

We may take into account the variability of viscosity and conductivity, too, by putting $\beta h^\epsilon \mu, \gamma h^\epsilon \kappa$ instead of μ, κ , in supposing these coefficients to be proportional to the ϵ th power of temperature. According to Barus and Puluš, ϵ has the value $\frac{2}{3}$ for the viscosity of air and hydrogen; the kinetic theory requires an identical value for conductivity; experimental evidence, though, seems to point to a somewhat smaller number, 0.57 according to Eichhorn and Müller; but this difference, the reality of which is by no means beyond doubt, could have no appreciable influence, except in careful special experiments.

By substitution of those variables in (2) and (3) there result the conditions of similarity (in the case of no external forces):

$$\frac{abm^2}{hn} = \frac{b}{n} = \frac{\beta m h^\epsilon}{n^2}; \quad \frac{mb}{n} = \frac{\beta m^2 k^2}{n^2} = \frac{\gamma k^{\epsilon+1}}{n^2};$$

which can be reduced to three relations:—

$$\frac{\beta}{\alpha\gamma} = 1; \quad m = \sqrt{\frac{h}{\alpha}}; \quad b = \frac{\beta h^{\epsilon+\frac{1}{2}}}{n\sqrt{\alpha}}. \quad \dots \quad (4)$$

As the first equation tells, similarity is possible only for gases which have a common value of $\frac{\mu R}{\kappa}$; this restriction, however, is not of great importance in practice, since it is fulfilled by itself with sufficient approximation for some gases, as the following table shows [μ and κ for air being taken as unity, and the molecular weight M being substituted for $\frac{1}{R}$]:—

| $k=1.4.$ | H ₂ . | O ₂ . | N ₂ . | CO. | NO. |
|-----------------------------------|---------------------------|---------------------------|----------------------------|-----------------------------|-----------------------------|
| $\frac{\kappa M}{\mu} \dots\dots$ | $\frac{6.7.2}{0.50} = 27$ | $\frac{1.0.32}{1.1} = 29$ | $\frac{1.0.28}{0.97} = 29$ | $\frac{0.98.28}{0.97} = 28$ | $\frac{0.95.30}{0.98} = 29$ |

| $k=1.3.$ | CO ₂ . | N ₂ O. | CH ₄ . | NH ₃ . |
|--|-----------------------------|-----------------------------|-----------------------------|-----------------------------|
| $\frac{\kappa M}{\mu} \dots\dots\dots$ | $\frac{0.64.44}{0.82} = 34$ | $\frac{0.67.44}{0.82} = 36$ | $\frac{1.37.16}{0.62} = 35$ | $\frac{0.92.17}{0.57} = 27$ |

The two remaining conditions define two of the four variables: velocity, dimension of length, pressure, temperature, for any special gas, the two others remaining arbitrary, which implies a much greater variety of applications than in the case of hydrodynamics.

§ 6. The simplest example demonstrating the principle of similarity (4, 2) is the common formula for the velocity of sound, $\sqrt{kR\theta}$, this velocity being independent of pressure and dimensions. That condition is valid, too, for the higher order of exactitude, where the influence of those variables has to be taken into consideration, as in Kirchhoff's formula for the propagation of sound through narrow tubes, or for Earnshaw's and Riemann's results concerning waves of sound of finite amplitude; but in these cases pressure is supposed to assume values corresponding to (4, 3).

Besides, the following applications may serve to show the use of similarity.

§ 7. The only hitherto known theoretical result about resistance of moving bodies, agreeing approximately with experiments on pendulums, is its proportionality to the first power of velocity, in the case of extremely slow motion. For a greater speed, experiments have proved approximate proportionality to the second power; but when the speed approaches the range of velocity of sound, the increase of resistance is much more rapid, and, after crossing this range, slower again*.

Besides, resistance is commonly supposed to vary in proportion to superficial dimensions, although experiments have not been in very close accordance with this supposition, and in proportion to the density of the gas, although there is no experimental evidence yet whatever for this rule. Neither has the influence of temperature nor of pressure been investigated, nor have gases other than air been tried.

* Useful information about these subjects is to be found in *Encyclopädie d. math. Wissensch.* iv. 2, p. 160 (Finsterwalder), p. 190 (Cranz), Leipzig, 1903.

Now let us see what information we can get about these points by our method. Suppose, first, our having found the empirical relation between resistance B and linear dimensions x of similar bodies, moving all with the same velocity in air of pressure p_0 and temperature θ_0 : $B = \phi(x)$.

If we wish to know the resistance in air of other pressure p , symbolized by $B = f(x, p)$, we have only to find out the similar case among those known already. This is the case

$$\left(\text{by: } \alpha = \beta = h = m = 1; n = \frac{1}{b}\right)$$

belonging to the linear dimensions $\frac{xp}{p_0}$, with resistance $\phi\left(\frac{xp}{p_0}\right)$. Now, as the dimension of resistance requires proportionality in the two cases to $bn^2 = \frac{1}{b}$, it follows that the required law of resistance is given by

$$f(x, p) = \frac{p_0}{p} \phi\left(\frac{xp}{p_0}\right).$$

Thus, if supposing (α) resistance to be proportional to linear dimensions, $\phi(x) = ax$, we must infer its being independent of the pressure altogether, whilst (β) proportionality to superficial dimensions necessarily must be connected with proportionality to pressure.

If the influence of velocity, too, has been found experimentally (for a given pressure and temperature)— $\phi(u, x)$ denoting this relation now—the range of these results can be extended, by similar reasoning ($\alpha = \beta = b = 1$; $m = \sqrt{h}$; $n = h^{\epsilon + \frac{1}{2}}$), to include the effect of variation of temperature.

We shall have for the resistance at temperature θ

$$B = f(u, x, \theta) = \left[\frac{\theta}{\theta_0}\right]^{2\epsilon+1} \phi\left(u\sqrt{\frac{\theta}{\theta_0}}, x\left(\frac{\theta}{\theta_0}\right)^{\epsilon+\frac{1}{2}}\right).$$

Moreover, if the gas be other than air, the influence of its molecular weight and viscosity can be inferred from the same experimental results, and in the same way, by similarity ($b = h = 1$; $m = \frac{1}{\sqrt{\alpha}}$; $n = \frac{\beta}{\sqrt{\alpha}}$).

For the most general case, thus, resistance is determined by

$$B = f(u, x, \theta, p, h, \alpha, \mu) \\ = \left(\frac{\mu}{\mu_0}\right)^2 \left(\frac{\theta}{\theta_0}\right)^{2\epsilon+1} \frac{M_0 p_0}{M p} \phi\left(u\sqrt{\frac{\theta M}{\theta_0 M_0}}; \frac{x \mu_0 p}{\mu p_0} \sqrt{\frac{M}{M_0}} \left(\frac{\theta}{\theta_0}\right)^{\epsilon+\frac{1}{2}}\right). \quad (5)$$

Suppose experiments to have demonstrated (α) proportionality to velocity and to linear dimensions; then it follows that resistance must be strictly proportional to the viscosity of the gas, corresponding to its temperature. On the contrary, if resistance increases at the rate of the squares of velocity and dimensions, it must be proportional to the density of the gas.

It ought to be emphasized, with respect to the above-mentioned experimental researches, that the usual supposition of proportionality to density and surface is inconsistent with any other law than that of square of velocity.

§ 8. A singular phenomenon, not restricting, however, the preceding conclusions, are the turbulent motions setting in when a certain limit of stability is surpassed and increasing with velocity of the moving body to such a degree as to produce a whistling sound. Although no attempt even seems to have been made to give a theory of it, we may predict, in consequence of ($\alpha = \beta = h = m = 1 : b = \frac{1}{n}$), the number of vibrations (of dimension $\frac{1}{t} = \frac{m}{n}$)—for a given speed and temperature—to be inversely proportional to the dimensions of similar moving bodies, if simultaneously pressure is changed in the same ratio.

A relation of similar form, but containing additional empirical elements, has been found by Strouhal (Wied. Ann. v. p. 216, 1878) in his experiments on sounds produced by the motion of cylindrical bodies, for example wires, in air of atmospheric pressure: the number of vibrations was proportional to the ratio of velocity to diameter of the moving body, $N = \frac{cv}{r}$.

Now we may prove easily, by our method, this formula to imply: independence of the sound of pressure and temperature. Strouhal, on the contrary, maintains an elevation of sound to be produced by increase of temperature; but his numbers referring to the temperatures of 9°·5 C. and 37° C. do not seem to be very conclusive; on the other hand, too, the above formula is not quite exact. The influence of pressure has not been investigated experimentally.

There have not been used any other gases than air in these experiments; but it can be shown, by the principle of similarity, that the constant c must have the same value for different gases; the sound must be independent of their nature.

§ 9. Experiments made by Joule and Kelvin (*loc. cit. ante*) on the heating effect produced in thermometers and wires

forming thermoelectric couples, by rapid motion in air, have established its approximate proportionality to the square of velocity and its independence of the substance and dimensions of the moving body (about 1° C. for $55 \frac{\text{m.}}{\text{sec.}}$; in the limits of $30\text{--}100 \frac{\text{m.}}{\text{sec.}}$); thus, denoting the coefficient of proportionality by $f(\theta, p)$, we shall have

$$\Delta\theta = u^2 f(\theta, p).$$

By supposing $(\alpha = \beta = h = m = 1; n = \frac{1}{b})$ there results a similar movement, with unchanged $\Delta\theta$, u , but changed pressure; whence we have

$$f(\theta, p) = f(\theta, pb).$$

Thus the heating effect $\Delta\theta$ must be independent of pressure; and similarly there follows by

$$(\alpha = \beta = b = 1; m = \sqrt{h}; n = h^{\epsilon + \frac{1}{2}})$$

its independence of the temperature.

Moreover, comparison of different gases

$$(\alpha = m = h = b = 1; n = \beta), \quad (\beta = m = b = 1; h = \alpha; n = \alpha^\epsilon)$$

demonstrates its independence of their viscosity, but proportionality to their molecular weight.

These results may be embraced by the formula

$$\Delta\theta = aMu^2,$$

where a is the same constant for all gases (provided k be equal).

If its extrapolation beyond the velocity of sound were allowed—which seems improbable—we should infer from it a heating effect of 2500° C. for a meteor moving with a speed of $2.8 \frac{\text{km}}{\text{sec.}}$. No conclusions can be drawn as yet about the effect of small velocities (in Kelvin's experiment below $30 \frac{\text{m.}}{\text{sec.}}$), where the above empirical formula is not applicable and where the measurements were not sufficient to define the modification required.

§ 10. Let us consider, now, in a similar way the flow of gases through pipes and holes. To the extreme case of a small difference of pressure on both sides of a capillary tube, there applies the law of Poiseuille-Graham-Meyer,

$$\Omega = \frac{r^4 \pi}{8\mu} \frac{p_2 - p_1}{l}.$$

By similarity ($\alpha = \beta = m = h = 1$; $b = \frac{1}{n}$) it is evident that this law, if valid for a certain tube, can be applied to a tube n times wider and longer only if the pressures be diminished in the same proportion.

Then velocity will remain unchanged, the outflowing volume will be increased n^2 times. This last result, however, is not limited to capillary tubes, not even to stationary flow; it can be applied just as well, for example, to effusion of gas from a closed reservoir through a small aperture.

This law of Poiseuille is the starting-point for the usual method of measuring viscosity of gases. But as its theoretical deduction implies neglect of inertia terms, of longitudinal friction, of thermic effects, forming serious obstacles to its accuracy and wider applicability, it may be worth drawing attention to the fact that relative measures, nevertheless, will give quite accurate results if effected in a suitable way.

For if we use pressures not such as we like, but such as are proportional to the value of the ratio $\frac{\mu}{\sqrt{M}}$ for different gases, the motions will be similar (by $h = n = 1$; $m = \frac{1}{\sqrt{\alpha}}$; $b = \frac{\beta}{\sqrt{\alpha}}$), and the ratio of effective difference of pressure to the outflowing volume $\frac{p_2 - p_1}{\Omega}$ will be the exact measure of viscosity.

Again, the validity of this result does not depend on the use of capillary tubes; it holds good, just as well, for the opposite case, of effusion through a hole in a thin wall; but evidently the use of capillary tubes is more convenient, since errors arising from incorrect application of pressures are of no importance there.

Likewise exact measurements of the thermic variability of viscosity may be performed by observing the value $\frac{p_2 - p_1}{\Omega}$, if such pressures p_1 , p_2 be chosen at different temperatures as are proportional to the $(\epsilon + \frac{1}{2})$ power of temperature

$$[\text{by } \alpha = \beta = n = 1; m = \sqrt{h}; b = h^{\epsilon + \frac{1}{2}}].$$

Maxwell's method of oscillating disks could be improved in a similar but somewhat more complicated manner. It would be interesting to take these researches up again with regard to those improvements, as investigations on thermic variability of viscosity have made no decisive progress since the time when Schumann (*Wied. Ann.* xxiii. p. 353, 1884)

obtained inexplicable contradictory results by careful experiments on both methods.

§ 11. The theory of motion of gases in wider tubes, such as used for gas-pipes, is quite obscure as yet; the formula most used in practice is

$$u = a \sqrt{\frac{(p_2 - p_1)d}{l\rho}},$$

where a is a constant, d the diameter of the pipe, l its length, u the mean velocity. Its form, indeed, satisfies the conditions of similarity, even for different gases, if by ρ be understood their density $\rho = \frac{p}{R\theta}$. Some other empirical forms, on the contrary, as, for instance, Stockalper's,

$$u = a \sqrt{\frac{(p_2 - p_1)d}{l\rho \left(5 + \frac{1}{d}\right)}},$$

derived from experiments at the Gotthard tunnel, must be rejected, as incongruous. For any law of the general form

$$u = \phi(p_1, p_2, l, d)$$

must remain unchanged by substitution of the corresponding values $\left(\frac{p_1}{n}, \frac{p_2}{n}, nl, nd\right)$.

But it is sufficient to know the experimental relation between u and p_1, p_2, l for a certain value of diameter and temperature in air; then we get the most general form for any gas and any d, θ , by similarity, in the form

$$u = \sqrt{\frac{\theta \overline{M}_0}{\theta_0 \overline{M}}} \phi\left(sp_1, sp_2, l \frac{d_0}{d}\right), \quad \dots \quad (6)$$

where s is an abbreviation for $\frac{\mu_0 d}{\mu d_0} \sqrt{\frac{\overline{M}}{\overline{M}_0}} \left(\frac{\theta_0}{\theta}\right)^{\epsilon + \frac{1}{2}}$.

For the opposite extreme to transpiration, viz. the effusion through a fine aperture in a thin wall, commonly Bunsen's law, maintaining proportionality of the passing volume to $\frac{1}{\sqrt{M}}$ for different gases, is accepted, at least for small difference of pressure, although recent researches (for example, Donnan, *Phil. Mag.* xlix. p. 423, 1900) have shown the agreement to be by no means satisfactory; the rule would apply with exactness, on the contrary, under the same supposition as in the analogous case above, supposing pressures to be chosen in proportion of $\frac{\mu}{\sqrt{M}}$.

By similarity ($\beta = h = b = 1$; $n = m = \frac{1}{\sqrt{\alpha}}$) it can be shown easily that a consequence of Bunsen's law in its usual form—with constant pressures—is proportionality of the passing volume to the cross-section of aperture, while proportionality to the third power of its dimensions would imply inverse proportionality to viscosity—this last rule being illustrated by the example of the transpiration formula.

§ 12. According to numerous experimental investigations about effusion (see § 1) the velocity of the stream of gas cannot be augmented, by increase of pressure, beyond a certain limit, not depending on the difference of internal and external pressure, but on their ratio $\frac{p_2}{p_1}$ (= about 1.89).

Now suppose two experiments with the same mouth-piece being made where this ratio has been attained $\frac{p_2}{p_1} = \frac{P_2}{P_1}$.

Then the second experiment is similar to a third one, with the same velocity, with pressures p_1, p_2 , but with dimensions of the mouth-piece increased in the ratio $\frac{P_1}{p_1} = \frac{P_2}{p_2}$, whence it

follows—in accordance with the experiments alluded to—that this velocity must be independent of those dimensions. (Approximately equal to the velocity of sound, Hugoniot, *Compt. Rend.* ciii. p. 1178 (1886); Lamb, *Hydrod.* p. 28.)

Mach and Salcher (*Wied. Ann.* xlii. 1890) and Emden (*Wied. Ann.* xlix. 1899) noticed the formation of striæ in the stream of gas, when the above critical ratio was surpassed. According to Emden's interpretation, they are a series of standing waves of sound, accompanied by changes of density. Their distances, carefully measured, were found to satisfy the relation

$$\lambda = 0.88d \sqrt{\frac{p_2}{p_1} - 1.9}.$$

Emden, however, might have saved part of the experimental work by use of our method; for it is sufficient to know that λ is a function of the ratio of pressures; the proportionality to the dimension d follows of itself from the similarity

$$\left(\alpha = \beta = h = m = 1; b = \frac{1}{n}\right).$$

Likewise, such a result being established for air, there follows necessarily, by ($b = h = 1$; $m = \frac{1}{\sqrt{\alpha}}$; $n = \frac{\beta}{\sqrt{\alpha}}$), its

independence of the nature of the gas—demonstrated, in fact, by Emden—and its independence of temperature, which has not yet been investigated.

§ 13. The acoustical phenomenon accompanying the rush of gas through a slit has been studied experimentally by Kohlrausch (*Wied. Ann.* xiii. p. 545 (1881)) with respect to width of the slit and to pressure in the reservoir. The influence of the pressure outside, of temperature, and nature of gas, might be inferred by our method, too, from this research; but we do not enter into this matter, as the results, not fitting easily into analytical expressions, are represented by tables, which would be rather cumbersome for use.

§ 14. In the preceding investigations the effect of external forces has been entirely neglected—whilst there exist certain classes of phenomena where gravity plays a prominent part; for example, motions of the earth's atmosphere or convective currents produced by inequalities of temperature. By considerations analogous to those in § 5 we get three conditions for similarity to be fulfilled in such cases:—

$$m^2 = n = ah; \quad b = \beta \frac{m}{n} h^e; \quad . \quad . \quad . \quad . \quad (7)$$

Let us examine, in this respect, Lorenz's result concerning the amount of heat given off by 1 cm.² of a vertical plane [height H, breadth infinite, temperature \mathfrak{S}_0 above that T of the surrounding gas] which was evaluated approximately (*Wied. Ann.* xiii. p. 592, 1881):—

$$L = -\kappa \frac{\partial \mathfrak{S}}{\partial x} = 0.548 \sqrt[4]{\frac{cg\kappa^2 \rho^2}{\mu H T}} \mathfrak{S}_0^{\frac{5}{4}}.$$

The form of this expression looks rather peculiar; but we satisfy ourselves of its dimensions fulfilling the conditions of similarity—as far, however, only as the coefficient ϵ is neglected, which points to a serious restriction of its validity.

§ 15. The presence of those convection-currents gives much trouble in the determination of thermic conductivity of gases. Their influence can be diminished by rarefying the gas; but rarefaction below a certain limit of pressure would imply another source of errors in certain molecular “discontinuities of temperature,” as I have called these phenomena (*Phil. Mag.* xlv. p. 192, 1898).

Now it may be noticed that relative measurements of conductivity can be strictly performed, notwithstanding the unknown convective currents, by using corresponding

pressures and corresponding dimensions of vessels for different gases (according to $h=1$; $n=\alpha$; $b=\frac{\beta}{\sqrt{\alpha}}$).

Also the thermic variability of conductivity—not yet known with desirable precision—may be investigated in an analogous manner, by application of similar motions. If we make use, for the higher temperatures, of vessels with dimensions increased in proportion of the first, and of pressure increased in proportion of the $(\epsilon-\frac{1}{2})$ th power of temperature, the quantity of heat transferred must be proportional to θ^ϵ , whence ϵ may be determined. The method of heating wires by electric currents may be easily adapted to this way of experimenting.

We confine ourselves to these few examples on this sort of similarity, since its range of applications is less extensive and since there is little experimental work hitherto done which could serve as a basis for further speculations.

LXXV. *The Condensation Method of Demonstrating the Ionisation of Air under Normal Conditions.* By C. T. R. WILSON, M.A., F.R.S., Fellow of Sidney Sussex College, Cambridge*.

SOME years ago I described experiments † which proved that when air saturated with water-vapour has been freed from dust particles, it will still give condensation in the form of drops on sudden expansion provided the expansion exceeds a definite limit. If $v_1 v_2$ be the volume of the air before and after the sudden expansion, then if v_2/v_1 be less than 1.25 no drops are produced on expansion, but if this critical expansion be exceeded a rainlike condensation results. The drops remain comparatively few if v_2/v_1 does not exceed a second limit about 1.38. It was found that exposure of the air to Röntgen or other ionising rays increased enormously the number of drops produced by expansions between these limits, the least expansion required to cause the formation of drops remaining, however, the same. It was concluded that the nuclei giving the clouds in air exposed to Röntgen rays are to be identified with the ions to which its conducting power under the action of the rays is attributed, and that the few drops always produced with expansions exceeding the critical value are due to ions of the same nature continually being produced even in the absence of the rays.

* Communicated by the Author.

† Phil. Trans. vol. clxxxix. p. 265 (1897).

Further experiments showed* that the number of drops produced by expansions between the above-mentioned limits in air exposed to Röntgen rays, is reduced in a very striking manner when a sufficiently strong electric field is maintained across the air before expansion, thus proving that the nuclei move in an electric field and are therefore electrically charged, and presumably identical with the ions to which the conducting power is due. On the other hand, similar experiments made in the absence of ionising agents failed to show any diminution of the number of drops by the action of even very strong fields. The absolute identity of the degree of supersaturation required to cause condensation upon ions and upon the nuclei to which the rainlike condensation is due, made it difficult to believe that the latter are not ions also, and to explain their non-removal by an electric field it was suggested that they might be ions produced in some way as a result of the expansion. When, however, subsequent experiments † on the leakage of electricity from conductors suspended within closed vessels, showed that a continual slight ionisation of the air is always going on in such vessels, it appeared more likely that the rainlike condensation really is due to this ionisation, and that the failure to detect any diminution in the number of drops under the action of an electric field is due to some defect in the conditions of the experiments. In the experiments thus far made the vessels used had been small, and to permit of a strong electric field being applied the air was enclosed between conducting surfaces generally only a centimetre or less apart; in many cases one of the conductors was a layer of water at the bottom of the vessel, the other being a horizontal metal plate coated with wet filter-paper. The drops were under these conditions very few whether an electric field was applied or not; it was thought that if a much larger volume of air were used there would be more chance of detecting the diminution in number when an electric field was applied. This expectation has been realized. With the large apparatus described below the effect of an electric field in removing the nuclei which gave rise to the rainlike condensation is very striking.

The construction of the apparatus ‡ (shown in the figure) is the same in principle as in the experiments on condensation nuclei which I have described in previous papers. On

* Phil. Trans. vol. excii. p. 403 (1899).

† Geitel, *Physikalische Zeitschrift*, vol. ii. p. 116; C. T. R. Wilson, Roy. Soc. Proc. vol. lxxviii. p. 151.

‡ The apparatus was made by Messrs. W. G. Pye & Co., Cambridge. To Mr. Pye I am indebted for many suggestions as to the mechanical details.

account of the much larger size of the new apparatus, the mechanism by which the sudden expansion is produced was

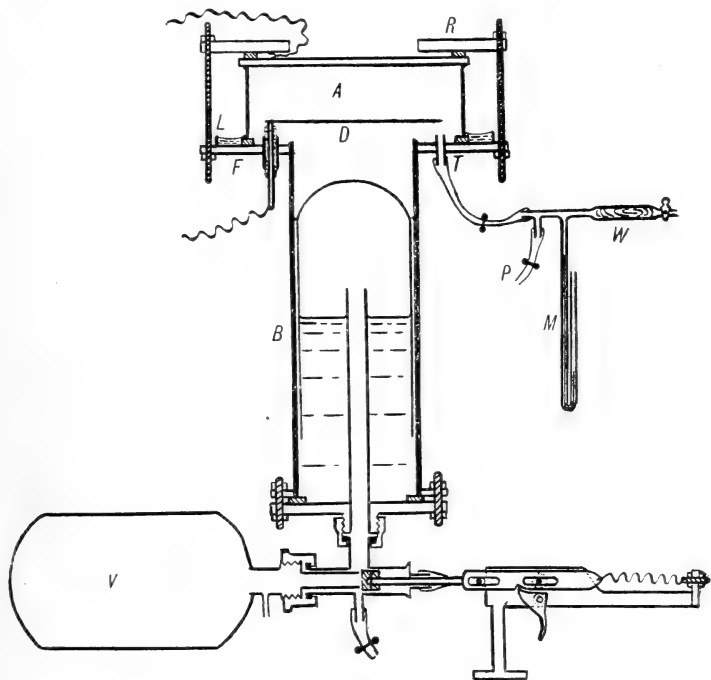

constructed, however, of brass, not, as in the older experiments, of glass. The cloud chamber *A*, in which the drops formed by expansion are viewed, is a glass cylinder 18.5 cms. in internal diameter and 5.9 cms. high. Its roof consists of a thick brass disk cemented to it by means of sealing-wax. The cylinder rests on an indiarubber ring lying on an annular brass plate *F*, which forms a flange at the top of the expansion cylinder *B*. The glass cylinder is squeezed down on the indiarubber by means of an upper annular brass plate *R* resting on the roof of the cloud chamber, from which it is separated by a second indiarubber ring; the upper and lower annular plates are connected by six bolts, by means of which the necessary pressure can be applied. The external diameter of the annular plates is 26 cms.; about one cm. from the edge of the lower one on its upper surface a thin ring *L* of brass 1.2 cm. high is soldered. This serves to contain water, all risk of air leaking in below the edge of the glass cylinder being thus removed. Through three symmetrically placed tubes penetrating the lower plate of the cloud chamber are

sealed three insulated brass rods supporting a horizontal brass disk D, 15.3 cms. in diameter. Between this disk and the roof of the cloud chamber, 4.7 cms. above it, any desired difference of potential could be maintained by means of a battery of storage-cells. Both this disk and that forming the roof were covered on the surfaces facing one another with wet filter-paper. In addition to the three tubes through which pass the supports of the brass disk, the floor of the vessel is pierced by a fourth smaller tube T, by means of which air can be removed from or admitted into the apparatus.

Below the cloud chamber and supporting it is a vertical brass expansion cylinder B, 10 cms. in internal diameter and 30 cms. long. Sliding freely in this and serving as a piston is a thin-walled brass cylinder open below and with a hemispherical top, the length of the cylindrical part being 18.75 cms., the thickness of the walls being less than one millimetre. The expansion cylinder is bolted by means of a flange at its lower end against a thick brass disk, an india-rubber ring, of which the internal diameter is considerably less and the external diameter greater than that of the cylinder, being inserted between them. Rising up from the centre of the disk is a brass tube 18 cms. long and 1.3 cms. in internal diameter. The cylinder is filled with water to within a few cms. from the top of this tube. By means of the mechanism to be presently described, the central tube can be put into sudden communication with a vacuum chamber V, thus causing the piston to fly sharply down against the india-rubber at the bottom of the cylinder, and to remain pressed tightly against this so that no air or water can escape. It is in this way that the sudden expansion is produced: on putting the central tube in communication with the atmosphere instead of the vacuum chamber, the piston rises to its original position.

The thick brass disk to which the expansion cylinder is attached rests upon an iron tripod (not shown in the figure) to the top of which it is firmly fixed by three screws. The feet of the tripod are screwed down to a board. The tubes for making connexion with the vacuum chamber are shown below the expansion cylinder. For convenience the connexions are made with screw-joints, india-rubber washers being inserted to prevent leakage. The vacuum chamber was a brass cylinder 22 cms. long and 14 cms. in diameter, with rounded ends; it was maintained at low pressure by a water-jet pump. A gauge was connected to avoid the risk of making an expansion while the vacuum was not sufficiently good. The construction of the mechanism for making sudden

communication with the vacuum chamber is the same as in the smaller apparatus described in previous papers, but of brass instead of glass; its mode of working will be understood from the figure. An indiarubber stopper held tightly by the pressure of the atmosphere against the end of the tube leading to the vacuum-chamber V can be suddenly pulled away by a spring released by the trigger arrangement shown. In this way the sudden motion of the piston, and the consequent expansion of the air in the cloud chamber, are effected.

The final volume of the air after expansion is always the same, for the piston is then held against the indiarubber at the bottom, owing to the low pressure below. To vary the expansion the initial volume has to be varied. The air before expansion is always at very nearly atmospheric pressure—really at a pressure less than that of the atmosphere by the pressure required to balance the weight of the partially immersed piston, the air below the piston being always before expansion at atmospheric pressure. The amount of any expansion is determined by adjusting the pressure after opening communication with the gauge M, before allowing the piston to rise after the previous expansion, a sufficiently long interval being allowed to elapse for the temperature to return to that of the surroundings; the constancy of the pressure serves as a test of this condition being fulfilled. The pressure thus determined will be the same as the pressure after the next expansion has taken place and the temperature has again become steady. The ratio of the air-pressure before expansion (*i. e.*, of the whole pressure in the cloud chamber less the saturation pressure of the aqueous vapour) to that after expansion will then be equal to v_2/v_1 , the ratio of the final to the initial volume. To adjust the final pressure to any desired value, air can be admitted from the atmosphere through the cotton-wool filter W, or removed by opening communication with the water-pump through the tube P.

The drops resulting from expansion are illuminated by a narrow beam of light converging to a focus at the centre of the cloud chamber; the source was in most cases an arc or lime-light; the effects were, however, quite easily observed with the light from an ordinary luminous flame. It was found convenient to coat the outside of the glass with black enamel over half the circumference, leaving, however, a vertical strip about one cm. wide in the middle for the light to enter; the glass immediately opposite this slit was also blackened over a width of a few cms. Any drops produced were then well seen on looking towards the centre of

the cylinder through the unblackened portions of the glass*.

The apparatus gave a value for the least expansion required in order that rainlike condensation might result, which agreed well with that obtained in previous experiments with much smaller apparatus.

The results of one series of measurements, those of May 15th, 1903, are given below.

p = gauge-reading when piston is at bottom.

w = pressure required to support weight of piston.

B = barometer-reading.

π = maximum vapour-pressure of water at temperature of experiment.

Then
$$v_2/v_1 = \frac{B - w - \pi}{B - p - \pi}.$$

In the experiment temperature = 15° C. Barometer = 766 mm. π = 13 mm. w = 5 mm.

In the Table which follows the result of the expansion corresponding to various values of the gauge-reading is given (a) when the upper and lower plates were metallically connected; (b) when a difference of potential of 160 volts was maintained between them.

| Gauge-reading in millimetres. | P.D.=0. | P.D.=160 volts. |
|-------------------------------|-----------------|-----------------|
| 159 | Shower. | |
| 153 | Very few drops. | |
| 151 | No drops. | |
| 152 | No drops. | |
| 153 | Very few drops. | No drops. |
| 155 | Shower. | No drops. |
| 160.5 | Shower. | No drops. |
| 171 | Shower. | Very few drops. |
| 177 | Dense shower. | Very few drops. |

Value of v_2/v_1 when rainlike condensation begins (in the absence of an electrical field)

$$v_2/v_1 = \frac{766 - 5 - 13}{766 - 153 - 13} = 1.247.$$

In the early experiments† the value found for the least expansion required for rainlike condensation was $v_2/v_1 = 1.252$.

* The apparatus was exhibited at the British Association meeting at Southport last September, and the removal of the ions by an electric field demonstrated.

† Phil. Trans. vol. clxxxix. p. 265.

The above observations show also the very marked effect of an electric field. It will be observed that when v_2/v_1 only slightly exceeds the critical value, a difference of potential of 160 volts entirely prevents the formation of drops. When the expansion is made larger a few drops are seen even in presence of the field; the drops were found to increase in number as the expansion was increased. That some drops should be formed when the expansion considerably exceeds the critical value, even in presence of a strong field, is not surprising; for the supersaturation when nuclei are few or absent will exceed the critical value for a finite time, the longer the greater the expansion. Any ions, set free while the supersaturation exceeds the critical value, will come into action as condensation nuclei and give rise to drops before the electric field has had time to remove them.

A difference of potential of 40 volts between the plates was found to reduce the number of drops formed on expansion to sensibly the same degree as 1000 volts. Even a potential-difference of two volts produced a noticeable diminution. In the older small-scale experiments, in which the distance between the plates was often considerably less than one cm., the strength of the field for a given difference of potential would be about five times as great as in the present experiments, and the maximum distance the ions had to travel only one-fifth as great; the effect of a given difference of potential in removing ions would then be much greater. It is possible that accidental differences of potential may in some cases have already largely reduced the number of ions present, so that the additional reduction following the application of much stronger fields was not noticeable. In the small apparatus also the number of ions present per c.c. in the absence of an electric field would be less on account of the much greater rate of loss of ions by diffusion to the walls of the vessel. The number of drops being small a larger share of water would fall to each, and they would fall too rapidly for variations in their number to be readily detected.

The total number of ions present when a steady state is reached, in the absence of an electric field, is such that the number of ions removed per second by recombination and by diffusions to the sides is equal to the number produced per second. On account of the small rate of production of ions, diffusion rather than recombination is in these experiments the more important factor in limiting the number of ions even with the large apparatus; with the small apparatus the loss of ions by recombination is negligible in comparison with that due to diffusion to the walls. Let us assume, for example,

that 40 ions of either sign are produced per second in each c.c. This is the rate of ionization deduced from leakage experiments in a small vessel of silvered glass*. (The number 20, given in the original paper, was deduced from the experiments by using J. J. Thomson's first value for the ionic charge, since shown by him and by H. A. Wilson to be about twice too large †.) If q be the rate of production of ions per c.c. per second, then the number of ions of either sign in each c.c., if loss by diffusion be ignored, will be given by

$$N = \sqrt{q/\alpha},$$

where α is the coefficient of recombination. Putting $q=40$, $\alpha=3.3 \times 10^3 e$ (where e is the ionic charge) and $e=3 \times 10^{-10}$ we have $N=6 \times 10^3$. If, on the other hand, we neglect the loss by recombination and consider only the loss by diffusion, then in a column of one sq. cm. in cross section extending from plate to plate and perpendicular to the plates, the number

of ions when a steady state is reached is equal to $\frac{2}{3} \frac{q}{D} l^3$,

where $2l$ is the distance between the plates and D is the coefficient of diffusion of the ions through the gas (J. J. Thomson, 'Electrical Properties of Gases,' p. 21). The average number for every c.c. of air between the plates will be

$$N = \frac{1}{3} \frac{q}{D} l^2.$$

For negative ions in moist air D is equal to $0.035 \ddagger$. Thus when q is 40, $N=4 \times 10^2 l^2$. In an apparatus with plates less than a centimetre apart, as in many of the older experiments, so that l is less than $\frac{1}{2}$, N is less than 100 per c.c. instead of the 6×10^3 obtained when only loss by recombination is considered: thus in this case the final number of ions is determined by diffusion, the loss by recombination being negligible. With the larger apparatus of the present paper $2l=5$ cms., $N=4 \times 10^2 \times 2.5^2=2.5 \times 10^3$ when we consider only the loss of ions by diffusion. The loss by recombination is now no longer negligible, but the loss by diffusion is the more important factor; the total number of ions when a steady condition is reached will be less than the value obtained when either recombination or diffusion is ignored, it must be somewhat less than 2.5×10^3 per c.c.

* C. T. R. Wilson, Roy. Soc. Proc. vol. lxxviii. p. 151.

† J. J. Thomson, Phil. Mag. vol. v. p. 346; H. A. Wilson, Phil. Mag. vol. v. p. 429 (1903).

‡ Townsend, Phil. Trans. A. cxcv. p. 259 (1900).

The value of q , the rate of production of ions, used above was deduced from measurements of the leakage of electricity through air contained in a small vessel of silvered glass. As a part of the effect is almost certainly due to a somewhat easily absorbable radiation from the walls, a smaller value of q is to be expected in a larger vessel such as that used in the experiment now described; q has, moreover, been shown by several observers to depend on the material of which the walls are composed. The experiments of H. L. Cooke*, who used a brass vessel of 1100 c.c. capacity, are more nearly comparable with those of the present investigation. The value of q found by him (without special shielding of the apparatus) was about one-third of the value used in the above calculations. If we use this value the effect of recombination becomes still less important in comparison with that of diffusion; and if we ignore recombination, the maximum number of negative ions in the absence of an electrical field, being proportional to q , is reduced to less than 900 per c.c.

I have not yet succeeded in making any direct determination of the number of drops actually produced on expansion. A superior limit to the number was, however, obtained indirectly by observing the rate of fall of the drops—the method adopted by J. J. Thomson in his determination of the charge carried by an ion. In this method of finding the number of the drops, the total quantity of water which separates out from each c.c. as a result of a given adiabatic expansion is calculated and assumed to be equally distributed among the drops; while the radius of the drops is obtained from the rate of fall by the use of Stokes' formula. When the drops are so few and the fall so rapid as in the present experiments, one cannot assume that they attain their maximum size; in other words, that sensibly all the available water is condensed upon the drops. The value found for the number of drops by dividing the total available water by the volume of each drop (as obtained from the rate of fall) will therefore be too high, but may be considered as a superior limit below which the actual number of drops really lies.

A series of observations, in which comparatively rough measurements of the time taken by the drops to fall were attempted, gave the following results. Expansions capable of catching all the negative ions produced drops all of which had fallen to the lower plate in less than three seconds; the temperature being 14° C. The distance between the

* H. L. Cooke, *Phil. Mag.* vol. vi. p. 403 (1903).

plates, *i. e.* the maximum distance fallen, was 4·7 cms.; the rate of fall when negative ions alone came into action thus did not exceed 1·6 cm. per second. Treating these data in the manner described by Professor Thomson*, we find that the number of negative ions present, in the absence of an electric field, is less than 1000 per c.c. : this is in agreement with the value calculated above from the data afforded by leakage experiments.

LXXVI. *Escape of Gases from Atmospheres.*

To the Editors of the Philosophical Magazine.

GENTLEMEN,—

A LETTER under the above heading, by Mr. S. R. Cook in 'Nature' of the 24th of March, puts forward views which ought not to remain on record without reply; and as between 30 and 40 years ago I carried on the investigation into the rate at which gases can escape from atmospheres in the same way as Mr. Cook has done, and arrived from the premisses employed by him at substantially the same conclusions, perhaps the best answer will be to state the considerations which led me to distrust that line of argument, and finally to abandon it. To do this, however, requires more to be said than can be brought within the compass of a letter to a weekly journal; and on this account, and because the discussion is a physical discussion and concerns one of nature's greater operations, I venture to request for the following pages the hospitality of the *Philosophical Magazine*.

A study of the phenomena attending the escape of gases from atmospheres has been approached in two ways—*inductively* †, by arguing upwards from events which are found to have occurred or to be in process of occurring in nature; and *deductively* ‡, by drawing inferences from the supposition that it is legitimate to attribute to the real gases of nature, behaviour which it has been ascertained would prevail in certain models of gas, so much simpler in their

* 'Electrical Properties of Gases,' p. 121.

† "Of Atmospheres upon Planets and Satellites." By G. Johnstone Stoney, F.R.S. See *Scientific Transactions of the Royal Dublin Society*, vol. vi. p. 305 (October 1897); or *Astrophysical Journal*, vol. vii. p. 25 (January 1898).

‡ "On the Escape of Gases from Planetary Atmospheres according to the Kinetic Theory." By S. R. Cook. See *Astrophysical Journal*, vol. xi. No. 1 (January 1900).

"The Kinetic Theory of Planetary Atmospheres." By Professor G. H. Bryan, F.R.S. See *Philosophical Transactions*, A. vol. cxvii. p. 1 (March 1900).

constitution than real gases that the progress of events within them is susceptible of mathematical treatment.

The two methods, as hitherto employed, have led to contradictory results, of which one at least must be erroneous. Mr. Cook, who has of recent years employed the deductive method, expresses the opinion in his letter that the numerical results which have been arrived at by this method "will have to stand" until they can be disproved "by other *a priori* reasoning." Serious students of nature must, I think, hold that man, in his dealings with nature, is not in a position to limit in this way the kind of proof he will accept; and that it is sufficient if *in any way* Mr. Cook's inferences from Maxwell's researches can be disproved, whether by valid *a priori* or by valid *a posteriori* reasoning. And, moreover, that when once they are disproved we are brought face to face with the fact that there has been a mistake somewhere in the data which have led those who trusted in them to a false conclusion.

What convinced me several decades ago that the conclusion at which I arrived, and at which Mr. Cook has arrived, is false, is that it represents the moon as incompetent to get rid of the atmosphere which it originally shared with the earth, and of the gases which it has since evolved in abundance from its own interior. We knew 35 years ago, as we know now, that any reasoning which makes out that the moon has retained its atmosphere, must have a flaw in it somewhere. Furthermore, since that time, other facts not then known have come to light, and in a marked degree confirm the judgment which was then formed. Our confidence that we are on the right track is justifiably strengthened when, as in this case, further discoveries as they emerge confirm the view to which we had been led when our materials were more scanty. The presence of helium on the earth was not then known: and the argument* which has been based on what is now known of its behaviour may be summarised as follows:—Helium is supplied to the earth's atmosphere through certain hot springs, and under circumstances which indicate that it also oozes up through the soil. It is, however, what is carried up by the water of these springs that can be subjected to experimental examination. The other gases of our atmosphere, such as nitrogen, oxygen, and argon, are found to accompany the

* The argument here summarised is based on the marvellous determinations made by Sir William Ramsay, K.C.B., F.R.S., in his laboratory, and will be found with the necessary details in a paper "On the Behaviour of Helium in the Earth's Atmosphere," by G. Johnstone Stoney. See *Astrophysical Journal*, vol. xi. p. 369 (1900).

helium in those springs: but with this marked difference, that whereas the other gases are present in such proportions as are consistent with their merely being portions of those gases which are being returned to the atmosphere after having been washed down into the earth from the atmosphere by rain, the case is entirely different when we come to helium. The quantity of helium passed into the atmosphere through those springs, is found to be from 3000 to 6000 times more than can be accounted for as a return to the atmosphere of helium which had been washed down out of it. Accordingly we are justified in regarding this great surplus of helium as being an addition which is being uninterruptedly made to the atmosphere. Notwithstanding this, the quantity of helium in the atmosphere has not gone on increasing. The earth at the present rate of supply furnishes in a small number of years a quantity of helium equal to the quantity which the atmosphere can at present retain,—*i. e.* in a number of years which is exceedingly small from a geological standpoint, which is the point of view that is here appropriate. The inference from these facts is the obvious one, that helium is by some agency being eliminated from our atmosphere as fast as it is being introduced into the atmosphere from the earth. Two possible agencies for the elimination of the helium suggest themselves—chemical reactions; and an escape of helium from the upper part of the atmosphere. Of these, chemical agency is excluded by the extreme chemical inertness of helium. What remains then is that there is an outflow of helium from the top of the atmosphere equal to the inflow at the bottom, and that the trace of helium which is at any one time present in the atmosphere is helium part of which is slowly making its way upwards to the situation from which some of its molecules can escape, and so produce that outflow which balances the net influx at the bottom of the atmosphere.

Having satisfied myself that the deductive method as I applied it (and as Mr. Cook has applied it) lands us in erroneous results, I set to work to scrutinize the data of the deductive argument with a view to ascertaining how far they may be depended upon, and at what points they are doubtful. All branches of physics require us to be more or less on our guard against trusting without sufficient scrutiny to inferences from that mixture of theory and hypothesis of which we are obliged to make use in order to be able to employ mathematics in physical research. The demand for this caution becomes a pressing one when, as in gases, we are obliged to deal with immense numbers of events, *each of which has its own dynamical history with incidents peculiar to itself*, and where

what chances on some of these occasions differs enormously from that which occurs in most of them. Of this kind are the interactions between the molecules of a gas and the inter-fused æther, and especially those complicated struggles between molecules which we call their encounters—events each of which, when viewed, as it ought to be viewed, from the molecular standpoint, is a battle lasting a long time as time has to be measured in molecular physics, and with an immense number and variety of incidents. These—the interactions between the molecules and the æther, and the interactions between molecule and molecule—are the primary events, the real determining events, which occur within a gas: while the movements of the molecules as they dart about between one encounter and the next; the spectrum radiated by the gas; the ions which present themselves after some of the encounters; the compounds which result from chemical reactions during some of the encounters (if what we are dealing with happens to be a mixture of suitable gases); and finally that remarkable partition of energy between the events going on within the molecules and the translational motions of the molecules, which is effected during some of the encounters—all of these are subordinate events depending upon those which are above spoken of as the primary events. When dealing with such almost immeasurably intricate and obscure operations of nature, it behoves us with the very utmost caution to distinguish between what is theory and what hypothesis in the data we employ, in order to be able to ascertain how far any conclusions we draw follow from the one, and how far they involve the other with the risks inseparable from it.

Theories are suppositions we hope to be true; hypotheses are suppositions we expect to be useful. As to theories, they are either correct or erroneous. They may be, they usually are, but they by no means need be, of use to man. The virtue of a theory is simply to be true. On the other hand, hypotheses usually make use of machinery which we can see to be simpler than that operating in nature; and especially is this the case with those hypotheses to which we are obliged to have recourse in mathematical investigations, which, in order to be of use, must be so great a simplification of the complex intricacies of nature that human mathematics shall be able to cope with them.

The *theory* of gas universally put forward in scientific books when the present writer was young, was the erroneous statical theory that the molecules of a gas may be stationary, that they have a capacity for expanding and contracting, and that each molecule presses against its neighbours. An illustration

frequently made use of in those days was that of a froth of bubbles pressing against one another. This erroneous theory held the field in Avogadro's time and for more than thirty years afterwards; but in the fifties of the nineteenth century it was gradually, though not without protest, displaced (chiefly through a masterly series of papers by Clausius) by the Kinetic Theory, which is now the prevalent theory. The Kinetic Theory of Gas, as formulated by Clausius, regards the molecules of a gas as missiles of equal mass, darting about in space and not acting *sensibly* on one another except when "encounters" chance to take place, *i. e.*, not until the centres of mass of two molecules get within an interval of one another which is less—usually much less—than the average length of the free paths which the molecules describe between the encounters; which free paths are accordingly approximately straight and pursued with unvarying speed except so far as they may be slightly influenced by gravity or other external cause, or by some excessively minute part of the interactions between molecules, if any such survives when the interval between molecules gets beyond what we may call their encountering distance.

This is the Kinetic Theory of Gas as put forward by its founder*, and any system of bodies which conforms to this definition may be called a *Kinetic System*. Thus, there are in nature as many kinetic systems as there are distinct gases; and moreover, all those models of gas in which the progress of events has been studied by mathematicians are *each of them* a kinetic system. So also are the cosmic bodies of celestial space, if we eliminate from the definition the condition that the masses must be equal; and, in fact, some modification of this clause of the definition is essential even as regards gases, inasmuch as in all the gases of nature there are found some of the missiles differing in mass from others—thus, in diatomic gases ions present themselves with masses that seem to be half the mass of average molecules.

We may add further details without trespassing beyond the domain of theory, *i. e.*, while still endeavouring to describe events as they occur in nature. Thus we may add that elaborate internal events are going on within all these missiles, which internal events absorb about one-third of the

* Clausius's papers were preceded by a paper by Waterston which was presented to the Royal Society in 1845, but which was not then published. This paper when it long afterwards came to be printed was found to contain a most valuable anticipation of the kinetic theory as developed by Clausius. If Waterston's paper had been printed in due course, the Kinetic Theory would probably have been adequately dealt with some years sooner.

whole available energy of the gas ; and we know that two partitions of energy take place—one a partition of energy (which probably goes on uninterruptedly) between these internal events of the molecules and the events of the æther, the other a partition of energy which now and then occurs with comparative suddenness between the internal events of the molecules and their translational motions. This latter transfer of energy seems to take place only when two molecules are in grip with one another during an encounter, and not at every encounter, but only during those which take place under certain necessary conditions. If, as seems probable, encounters with these special characteristics are as rare as those which result in the breaking down of molecules into ions, or of those which result in chemical reaction in a mixture of equal volumes of chlorine and hydrogen, then the infrequency of their recurrence can be estimated ; and, in cases in which it has been found possible to make the estimate, the infrequency seems to range from one out of 10^9 encounters down to about one in 10^{19} , when we pursue the observations so far as they have been recorded.

It is here that I strongly suspect, though I am not in a position to claim that I know, that the mistake has been made by Mr. Cook, and by my friend Professor Bryan, who both tacitly assume that this partition of energy is a process which goes on uninterruptedly, even in the upper parts of the atmosphere. Whether the mistake be here or elsewhere may as yet be only highly probable ; but that a mistake exists *somewhere* in the premisses of the deductive argument was placed beyond question by nature when she presented to us events that have occurred, or are occurring, which negative some of the inferences to which those data lead. We may be unable with certitude to put our finger upon the precise spot where the mistake came in, but that a mistake has come in somewhere can be proved.

When Maxwell determines his law for the distribution of speeds in a kinetic system, he exercises a caution* which has not always been observed by his successors, and is careful to present the law as the law governing the distribution of speeds (not in every, or indeed in any gas, but) in a kinetic system which consists of numberless equal particles, each of which is a perfectly rigid and perfectly elastic sphere, after an immense number of collisions have taken place—assumptions which he afterwards varied in different ways, as by substituting particles of other forms, or points repelling

* See Maxwell's 'Scientific Papers,' vol. i. p. 380 ; or Phil. Mag. for January 1860.

one another inversely as the fifth power of the distance. The several assumptions which he thus makes are put forward not as theory but as hypothesis; they do not profess to reproduce any existing gas, but substitute for the gas an artificial model; and Maxwell is careful to keep this prominently before the mind of his reader.

As to his exponential law for the distribution of speeds, it is the solution of a functional equation, which in turn is the expression of the assumption that the number of molecules whose velocities lie between u, v, w , and $u + \delta u, v + \delta v, w + \delta w$ must be some function of u, v , and w . Now this is true of Maxwell's models, but cannot be the case in any gas in which there is an irruption of energy from the internal motions to the translational on the occurrence of events which depend either wholly or partly on conditions other than the mere translatory speeds of the molecules—such conditions for example as the aspects of the two molecules to one another when the encounter is about to take place, or the phases at which the internal motions had arrived at that instant of time, or many other conditions that are possible and can be easily conceived. Accordingly, whenever a mathematician applies Maxwell's law under the impression that, as regards any particular gas, it is more than an approximate law, he tacitly assumes either that there are no internal events (as in Maxwell's models), or that if there be internal events (as in all real gases) the partition of energy between these internal events and the translational motions is a transfer taking place at such short intervals that it may legitimately be treated by the mathematician as a process which goes on continuously and at a constant rate. At the bottom of our atmosphere an event that happens once in 10^9 encounters occurs to each molecule as often as 7 or 8 times per second. Even here the assumption that the transfer of energy goes on uninterruptedly makes but a rough approximation to the truth, and it is utterly remote from being an approximation in that penultimate stratum of the atmosphere from which nearly the whole escape of molecules takes place, and especially in regard to an event like the escape of a molecule from the earth, which is mainly the outcome of the circumstance that an individual encounter has chanced to be very unlike ordinary encounters. Hence, in no real gas can the actual law of the distribution of speeds be *identical* with Maxwell's exponential law, nor with any of the exponential laws of Maxwell's successors; although under the conditions which prevail in our laboratories these laws may be an approximation sufficient for many useful purposes.

The cases in which Maxwell's approximate law may legitimately be employed can be pointed out. Whenever an approximate law presents itself in an exponential form with negative index, the approximation holds good as an approximation over that small part of the range where the exponential function acquires large values, but can no longer be depended upon as an approximation in regard to the parts of the range where the exponential function is small. Maxwell makes a legitimate use of his law when, through its instrumentality, he discovered his remarkable explanation of viscosity and diffusion, and investigated the laws of those phenomena. In reference to these, what happens in the case of velocities which are infrequent is of small account; but the application made by Prof. Bryan and Mr. Cook is to the rare events which occur within that part of the range where the approximation breaks down and where, in consequence, the exponential law is misleading. It is this oversight to which I think it likely that we are mainly to refer numerical results which are found to clash with events that have taken place or that are taking place upon the moon and the earth.

The inquiry in which I engaged in the sixties of the last century led also to the detection of other defects in the premisses made use of by those who have trusted in the deductive method. One of these concerns the ambiguities which surround the use of the term "temperature." Temperature is not one physical measurement but two groups of physical measurements, essentially different according as we test equality of temperature by there being no transfer of heat *by conduction* when two bodies are brought into contact, or *by radiation* when they are made to stand apart. This establishes a division of temperatures into two principal groups, and these groups require further subdivision. The temperature of a body determined in these two different ways may be called its conduction temperature and its radiation temperature; of each of which there are several varieties. There are accordingly many different kinds of temperature. In the case of gases, conduction (including convection) is mainly concerned with the translational speeds of the molecules, while radiation in the first instance affects only the internal events going on within the molecules. In most laboratory experiments (carried on as they must be at the bottom of our atmosphere) the partition of energy between the internal events of each molecule and its translational movements takes place so frequently—probably several times every second in a gas at standard temperature and pressure—that the distinction even between the two main kinds of

temperature does not need to be attended to. But, to go to the opposite extreme, let us consider the case of a gaseous molecule which has escaped from the earth and travels like an independent planet through space. Here no interchange of energy can take place between the translational movement of the molecule and its internal events. Under suitable external influences either of them may be made to vary to any extent without this affecting the other. The two kinds of energy, or if we please so to call them of temperature, have become divorced; and intermediate stages between these extremes would be found to exist within an atmosphere if we could explore it from its bottom to its top.

Further distinctions have to be made within the two principal kinds of temperature. Those which have to be taken into account in the present investigation are the varieties of radiation temperature. A body, like the sun, acting by radiation upon different gases has no one definite radiation temperature, but may be at a different radiation temperature in regard to each gas. Thus, the sun is hotter with regard to the helium of the earth's atmosphere than with regard to its hydrogen. This we know, because the radiations from the sun which can affect hydrogen come in the form of the rays corresponding to the hydrogen lines of the solar spectrum which are dark, while the radiations which raise the temperature of helium come through rays corresponding to the helium lines, of which the principal one within the visible spectrum—the double line D_3 —is as bright as the neighbouring part of the spectrum. Hence the radiation which reaches helium in the outer part of our atmosphere has the full intensity of radiation from the sun's photosphere.

Reviewing the whole case, we find that in the stratum of the earth's atmosphere from which helium escapes, the opportunities for exchanging energy between the internal motions and the translational, instead of occurring to each molecule several times per second, may be so infrequent that they occur only once in several hours. During all its intermediate flights the molecule is exposed during the daytime to the full glare of radiation as intense as direct radiation from the sun's photosphere. In this way the internal motions of the molecule will be kept for some hours excited to intense activity, and if during these hours that special kind of encounter happens to take place which affords an opportunity for an interchange between the internal and translational energies, the two encountering molecules will fling asunder with what may be described as explosive violence.

All that is then necessary for a molecule to escape is that one of the two that have encountered shall have the direction of its flight outward, that it shall have sufficient speed, and that it shall escape other encounters. If the chance that these events shall happen befalls each molecule in the penultimate stratum of the helium atmosphere as often as once in several days, there would probably be an abundant outflow of helium from the earth to account for the observed rate of its escape.

Here, however, we are on debatable ground. We can only follow events in detail with probability, not with certainty. But on the other hand, when we trust to the inductive argument based on the ascertained behaviour of helium, as stated in an earlier paragraph, *we are on secure ground*. We may rely on the conclusion to which it leads viz., that helium *is* escaping from the earth's atmosphere, and that the rate of escape is the same as the rate of the net inflow from the earth into the atmosphere. By the net inflow is meant the supply after deducting something like a $1/6000$ or $1/3000$ part of the whole, in order to allow for the very minute quantity of helium that had been washed out of the atmosphere by rain and which is being restored to it.

There are other matters, too, which would need to be understood and allowed for before we should be entitled to trust the deductive method of proof. Thus, the internal events that go on within the molecules of matter are of more than one kind, and in gases stand differently related to the translational motions. This is revealed to us by phosphorescence and other phenomena. An attempt to make a preliminary classification of these internal events has been made by the present writer in a memoir on the Kinetic Theory of Gas*. But without going into these and other matters, enough has been said to show how inadequate the deductive method is—at least as hitherto handled—to be a safe guide in dealing with the matters with which it has been made to grapple. This of course also shows that objections based on investigations of this character, have no weight against the testimony about the rate at which gases do actually escape from atmospheres which is given by such *facts* as the absence of atmosphere from the moon and the behaviour of helium upon the earth.

* "Of the Kinetic Theory of Gas regarded as illustrating Nature." By G. Johnstone Stoney, F.R.S. See Scientific Proceedings of the Royal Dublin Society of June 1895, vol. viii. p. 356; or Phil. Mag. for October 1895, p. 362.

The objection urged by Mr. Cook against accepting the inductive proof of the actual rate of escape of gases from atmospheres, is analogous to the objection urged by some scientific men when in 1867 I brought forward a proof* that in an atmosphere of mixed gases the atmosphere of each gas must have a different limit, the lighter constituents overlapping and extending beyond those which are denser. "Oh!" it was then said, "That can't be the case. It is inconsistent with Dalton's Law of the equal diffusion of gases." Yet I have lived to see my conclusion generally, I believe universally, accepted by physical astronomers; and I look forward with some hope to an ultimate acquiescence in what is now being objected to, in reference to the escape of gases from atmospheres. In both cases the objection rests on the same error—the mistake of hypothesis for theory, and the consequent mistake of a law which is approximate for a law of nature.

I am, dear Sirs, faithfully yours,

30 Ledbury Road, W.,
May 12, 1904.

G. JOHNSTONE STONEY.

LXXVII. *Notes on Non-homocentric Pencils, and the Shadows produced by them.*—I. *An Elementary Treatment of the Standard Astigmatic Pencil.* By WILLIAM BENNETT†.

A STANDARD astigmatic pencil is one of which all the rays pass through two focal lines, at right angles to one another and to the axis of the pencil. Let the axis of the pencil be taken as the axis of Z, and let the focal lines be parallel to the axes of X and Y respectively, and at distances a and b from the origin. Then the projections of the pencil on the planes of XZ and YZ are as shown in fig. 1.

It is evident from this figure that the change in the transverse sections of the pencil consists in a uniform stretching or compression in a direction perpendicular to each of the focal lines, the stretchings or compressions proceeding at unequal rates. Thus, if the section is anywhere a conic with axes parallel to the focal lines, it is everywhere so. The pencil is also of rectangular section with sides parallel to the focal lines at all points if at any; and this is the section obtained if the extent of the pencil is defined by limiting the lengths of the focal lines.

* "On the Physical Constitution of the Sun and Stars." By G. Johnstone Stoney, F.R.S. See Proceedings of the Royal Society, No. 105, p. 1 (1898). See especially paragraphs 23, 24, 25.

† Communicated by the Physical Society: read January 22, 1904.

Any form being assigned to the section by a plane perpendicular to the axis, and the position of the focal lines relative to the plane being defined, it is easy, by drawing

Fig. 1.

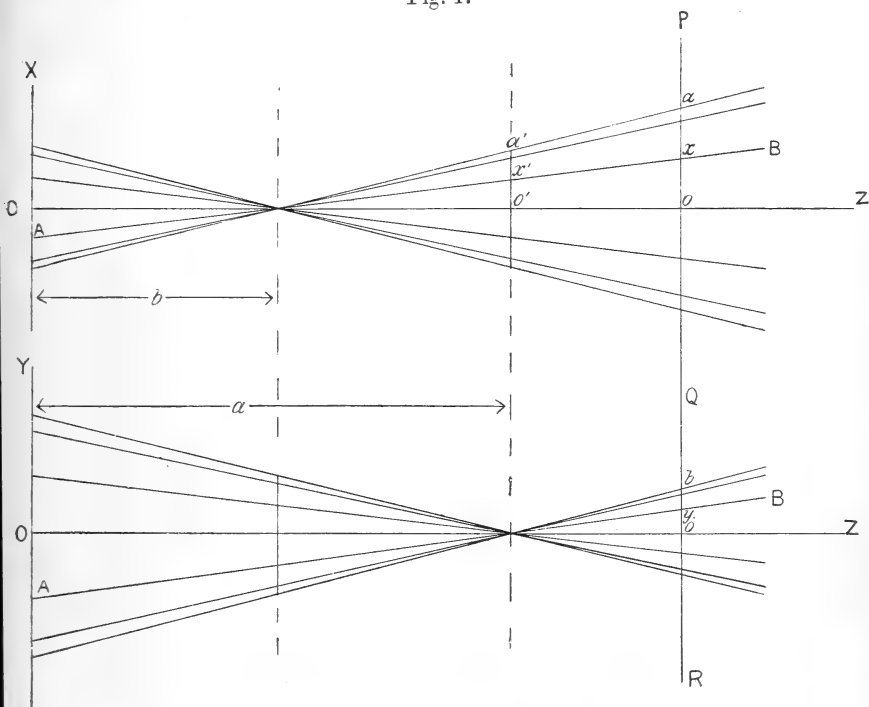

plans and elevations of the rays through a number of points on the boundary of the section, to obtain graphically the section by any other plane parallel to the first. The two sections being drawn on card or metal, and erected in the correct relative positions, corresponding points may be joined by threads or wires and a model of the rays obtained.

Model 1 represents the bounding surface of a pencil of elliptic section. The construction was simplified by taking for the first section an ellipse with its horizontal axis twice the length of its vertical axis, and letting the focal lines divide the distance between the two sections into three equal parts, the horizontal line being nearer the first section; the second section is an equal and similar ellipse, with its longer axis vertical.

Model 2 represents a pencil of rectangular section, and was constructed in a similar way.

Mr. R. J. Sowter has shown * that for rays on the bounding surface of the elliptic-sectioned pencil the eccentric angle (ϕ) is constant: this also follows simply from a consideration of fig. 1. For if the section by the plane PQR is bounded by an ellipse of semiaxes oa and ob , the coordinates of the intersection of the bounding ray AB with this ellipse are ox and oy . Since oa will be the radius of the auxiliary circle, $\cos \phi = \frac{ox}{oa}$, which will have the same value for any point on AB. It is to be noted that ϕ is to be measured always from the axis parallel to OX, whether this be the major or the minor.

Prof. S. P. Thompson has called attention to the rotation of the shadow of a straight wire placed across the pencil: this also appears from fig. 1. Let x_0, y_0 be the coordinates of any point in the plane $Z=0$. The ray through this point is given by

$$\begin{cases} x = \frac{b-z}{b} x_0, \\ y = \frac{a-z}{a} y_0. \end{cases}$$

So that, if

$$y = mx + c$$

be the equation of a line in the plane $Z=0$, the rays passing through this line rule the surface

$$\frac{ay}{a-z} = m \frac{bx}{b-z} + c.$$

This equation gives also the shadow thrown on a plane perpendicular to the axis—that is, the section of the pencil by the plane. This is a straight line whose inclination is

$$\tan^{-1} \frac{b(a-z)}{a(b-z)} m.$$

This inclination varies continually with z . Its tangent

$$\begin{aligned} &= 0 \quad \text{when } z = a, \\ &= \infty \quad \text{when } z = b, \\ &= \frac{bm}{a} \quad \text{when } z = \pm \infty. \end{aligned}$$

The whole amount of rotation between $z = \infty$ and $z = -\infty$ is 180° , 90° of which occurs between the focal lines.

Model 3 represents the shadow-surface, and Model 4 shows its relation to the boundary of the pencil.

* Phil. Mag. Oct. 1903.

As this surface is ruled by rays passing through three straight lines, it is a ruled quadric ; further, since these three lines lie in parallel planes, it is a hyperbolic paraboloid.

One set of generators is the rays. If p, q, r be the direction-cosines of the ray through x_0, y_0 , we get from its equations

$$\frac{p}{\frac{x_0}{b}} = \frac{q}{\frac{y_0}{a}} = \frac{r}{-1}.$$

Since $y_0 = mx_0 + c$, we have, eliminating x_0 and y_0 ,

$$aq - mbp + cr = 0 ;$$

that is, the rays are parallel to the plane

$$ay - mbx + cz = 0.$$

If $c=0$, that is if the object-line meets the axis, this becomes

$$y = \frac{b}{a} mx.$$

This case is shown in Model 5, which consists of the shadow-surface and the plane $y = \frac{b}{a} mx$.

The other set of generators are the shadow-lines in planes parallel to $z=0$.

The section by any plane not perpendicular to the axis will be an hyperbola whose equation can be obtained from the equations of the plane and the surface.

If the object-line does not lie in a plane perpendicular to the axis, the ray-surface is an hyperboloid of one sheet, and the shadow on a plane at right angles to the axis becomes an hyperbola. But since a generator of each set passes through every point on the surface, the shadow can always be reduced to a straight line by tilting the plane upon which it is received.

The equation of the ray-surface in this case can be obtained as follows :—

The equations to a ray through the point (x_0, y_0, z_0) are

$$\left. \begin{aligned} x &= \frac{z-b}{z_0-b} x_0, \\ y &= \frac{z-a}{z_0-a} y_0, \end{aligned} \right\}$$

Let the object-line be defined by the equations

$$\left. \begin{aligned} x &= mz + h \\ y &= nz + k \end{aligned} \right\}$$

Then, since (x_0, y_0, z_0) lies on this line, the ray becomes

$$\left. \begin{aligned} x &= \frac{z-b}{z_0-b} (mz_0+h) \\ y &= \frac{z-a}{z_0-a} (nz_0+k) \end{aligned} \right\}.$$

Equating the values of z_0 obtained from these, we get for the equation of the ruled surface :

$$\frac{xb+h(z-b)}{x-m(z-b)} = \frac{ya+k(z-a)}{y-n(z-a)} \quad (=z_0);$$

i. e.,

$$(a-b)xy - (am+h)(z-b)y + (bn+k)(z-a)x + (nh-mk)(z-a)(z-b) = 0.$$

This represents a ruled quadric whose section by a plane $z=\text{const.}$ is the rectangular hyperbola whose equation is obtained by substituting for z its constant value.

The asymptotes of this section lie in the planes

$$x = \frac{am+h}{a-b} (z-b)$$

and

$$y = \frac{bn+k}{a-b} (z-a)$$

respectively, each of which passes through one of the focal lines.

The two sets of generators are given by the two pairs of equations :

$$\left. \begin{aligned} \frac{xb+h(z-b)}{x-m(z-b)} &= \lambda \\ \frac{ya+k(z-a)}{y-n(z-a)} &= \lambda \end{aligned} \right\}$$

and

$$\left. \begin{aligned} \frac{xb+h(z-b)}{ya+k(z-a)} &= \mu \\ \frac{x-m(z-b)}{y-n(z-a)} &= \mu \end{aligned} \right\}$$

respectively.

The first set is the rays, and $\lambda=z_0$. The object-line and the focal lines are members of the second set. The two focal lines are given by $\mu=0$ and $\mu=\infty$ respectively, and the object-line by $\mu=\frac{mb+h}{na+k}$. This case is illustrated in model 6.

It will be seen that the object-wire may be moved into the position of any generator of the second set, except the two focal lines, without altering the form of the shadow.

If the plane on which the shadow is taken is not perpendicular to the axis of z , the section is still a conic. If it is turned so as to contain one of the generators of the second set, the section will become two straight lines; the other being the ray which lies wholly in that plane and comes from the point in which the plane is cut by the object-line.

This is an example of a two-part shadow, of which one part is due to a single point of the object.

It is to be noted that although the complete shadow is an hyperbola, it does not follow that both branches will be seen with a pencil limited by any aperture. In fact only one branch will be seen, unless some of the rays which meet it have and some have not passed through one of the focal lines.

The positions of the focal lines produced by reflexion or refraction of a small pencil may be often found by use of the method of sagittæ due to Prof. Thompson. The case of refraction through the centre of a thin lens is taken as an example.

Let r_1 and r_2 be the radii of curvature of a small thin convex lens of diameter $2a$, and refractive index μ .

Then the thickness (t) of the lens is given by

$$t = \frac{a^2}{2} \left(\frac{1}{r_1} + \frac{1}{r_2} \right).$$

Let a small pencil inclined at an angle ϕ to the axis of the lens fall centrally upon it.

Then if a plane wave-front fall upon the glass, the centre of it travels (see fig. 2) through glass for a distance $\frac{t}{\cos \phi_1}$, where $\sin \phi_1 = \frac{\sin \phi}{\mu}$. But this is in a direction making an angle $\phi - \phi_1$ with the direction of the pencil; so it is only advanced thereby a distance $\frac{t}{\cos \phi_1} \cos(\phi - \phi_1)$. Meanwhile the edges of the wave-front travelling in air have advanced a distance $\frac{\mu t}{\cos \phi_1}$; so that the relative retardation of the centre is $\frac{t}{\cos \phi_1} \{ \mu - \cos(\phi - \phi_1) \}$, which reduces to

$$\frac{a^2}{2} \left(\frac{1}{r_1} + \frac{1}{r_2} \right) (\mu \cos \phi_1 - \cos \phi) \equiv A \cdot \frac{a^2}{2}.$$

This is the relative retardation of the centre over the edges of a piece of the incident wave-front whose width is $2a$ in a direction perpendicular to the plane of fig. 2 and $2a \cos \phi$ in that plane.

Fig. 2.

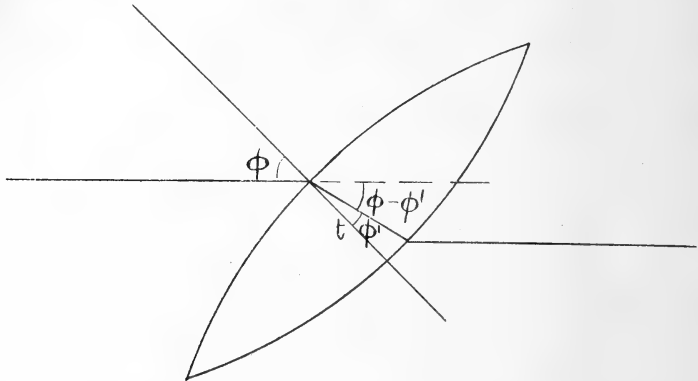

The changes in the curvatures of the principal sections of the wave-front are A and $\frac{A}{\cos^2 \phi}$. That is to say, the lens behaves like a bicylindrical lens whose principal converging powers are A and $A \sec^2 \phi$. This is a standard result derived in Heath's Optics by the use of the characteristic function. It only holds, however, for very narrow pencils and thin lenses, as it assumes that a is a small quantity of the first, and hence t of the second order.

LXXVIII. *Notes on Non-homocentric Pencils, and the Shadows produced by them.*—II. *Shadows produced by Axially Symmetrical Pencils possessing Spherical Aberration.* By WILLIAM BENNETT*.

[Plate XXVII.]

ATTENTION has recently been drawn by Prof. S. P. Thompson to some curious shadows produced when a straight wire is introduced into an axially symmetrical converging pencil proceeding from a lens or mirror and possessing spherical aberration.

The case to be investigated is that of the shadows of a straight wire in a pencil produced by the reflexion of a parallel beam at a concave spherical mirror. The wire, and

* Communicated by the Physical Society: read March 11, 1904.

the plane on which the shadow is received, will be taken perpendicular to the axis of the pencil. Let a be the radius of curvature of the mirror (fig. 1), then a ray which meets

Fig. 1.

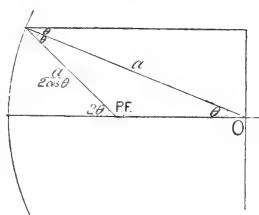

the mirror at an angular distance θ from its pole will, after reflexion, make an angle 2θ with the axis, and will meet it at a distance $\frac{a}{2 \cos \theta}$ from the centre

Values of $\frac{a}{2 \cos \theta}$

being tabulated, it is easy to make a drawing of a part of the pencil to any scale. The most important shadows are those produced when the wire is near the principal focus and between it and the mirror; and in the consideration of these it is convenient to think of the form of the wave-front which meets the wire, and of the trace left upon it after it has passed the wire. A method for drawing the wave-front has been given by Prof. R. W. Wood* ; but as this method is inconvenient for large-scale drawings, a modification of it was adopted. The optical distance from the incident wave-front, which passes through the centre of curvature, to the

axis is $a \left(\cos \theta + \frac{1}{2 \cos \theta} \right)$. The distance from this wave-front to that which passes after reflexion through the principal focus is $\frac{3a}{2}$. A reflected ray therefore meets the latter wave-front at a distance $a \left(\frac{3}{2} - \cos \theta - \frac{1}{2 \cos \theta} \right)$ beyond its intersection with the axis. The values of this quantity were calculated for different values of 2θ , and measured off on a large scale drawing of the rays near the principal focus. The other wave-fronts were obtained by measuring back a series of equal distances along the rays, starting from the

* Phil. Mag. [5] vol. 1. (July 1900).

wave-front first formed. The result is seen in fig. 2, which gives a better view of the form of the waves in this region

Fig. 2

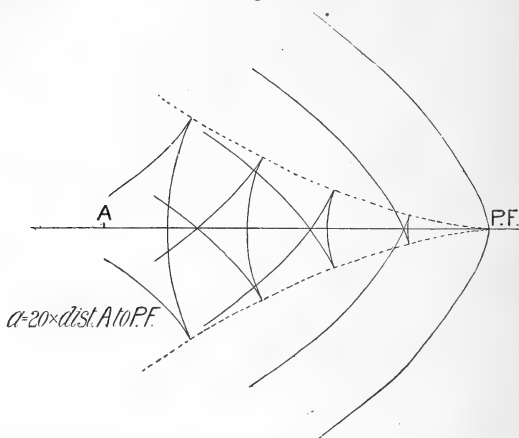

than can be obtained from the smaller figure given by Prof. Wood. The waves are shown as proceeding from a mirror of aperture 52° lying to the left of the diagram; the complete forms are given by Prof. Wood in the paper already referred to. Each wave-front is a figure of revolution consisting of a saucer-shaped part in front, bounded by a circular cuspidal edge which is tracing out the caustic surface, and a trailing part behind, which has already passed the caustic.

The wave-fronts are given by the equations

$$\begin{cases} r = \left\{ K - a \left(\cos \theta + \frac{1}{2 \cos \theta} \right) \right\} \sin 2\theta, \\ c = r \cot 2\theta - \frac{a}{2 \cos \theta}, \end{cases}$$

where K is a parameter constant over any one wave-front, being, in fact, the optical distance from the incident wave-front through the centre of curvature. These equations, however, are not easily worked with.

Imagine the wire placed so as to meet only the trailing part of the wave-front; as the curvature of the wave-front is not uniform, the trace left upon it by the wire will be distorted as the wave advances, and the shadow will be a single-branched curve on the same side of and farther from the axis. This curve will be concave to the axis in its central parts, and will have two points of inflexion and an asymptote parallel to the wire.

Let the wire be moved towards the axis until it just grazes the passing cuspidal edge. The trace will now consist of the branch previously considered and a conjugate point which, when the principal focus is passed and the wave-front completely unfolded, will be on the other side of the axis.

If the wire is moved still farther on it is met three times by the advancing wave-front : once by the saucer, next by the trail immediately behind, and finally by the tail part of the trail from the other side. The first two intersections, however, are continuous and meet upon the cuspidal edges forming a closed curve. The complete shadow now consists of an open branch, and a closed branch on the other side of the axis. If the wire intersects the axis the shadow passes into the ϕ form particularly noticed by Prof. Thompson. The circular part of this is due to a single point on the wave, the intersection of the trail with the axis (the normals to the wave-surface at this point forming a circular cone), and will of course be absent if the trail has not yet met the axis.

If the wire is placed so near to the mirror that the cusp has not yet begun to form (this stage is not shown in fig. 2), the shadow will be single-branched and open on the opposite side of the axis. It will also be convex towards the axis. This, however, becomes closed, and an open branch appears on the other side of the axis if the angular aperture of the mirror is increased. If, on the other hand, the wire is beyond the principal focus, the shadow will be of the form first described.

Fig. 4 (p. 710) is a reproduction of a series of drawings of the shadow curves. These were obtained in the following way:—Cylindrical coordinates were taken with the axis of the pencil for the axis of z and the origin at the centre of curvature, the positive direction of z being away from the mirror, and ϕ being measured from the plane of the paper. The wire lies in the plane $z=b$ at right angles to the paper and its distance from the axis is d . The shadow is considered in the

Fig. 3.

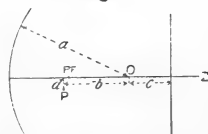

plane $z=c$ (fig. 3). The equations of a ray are

$$\begin{cases} \phi = \text{const.} \\ r = -\tan 2\theta \left(z + \frac{a}{2 \cos \theta} \right). \end{cases}$$

Fig. 4.

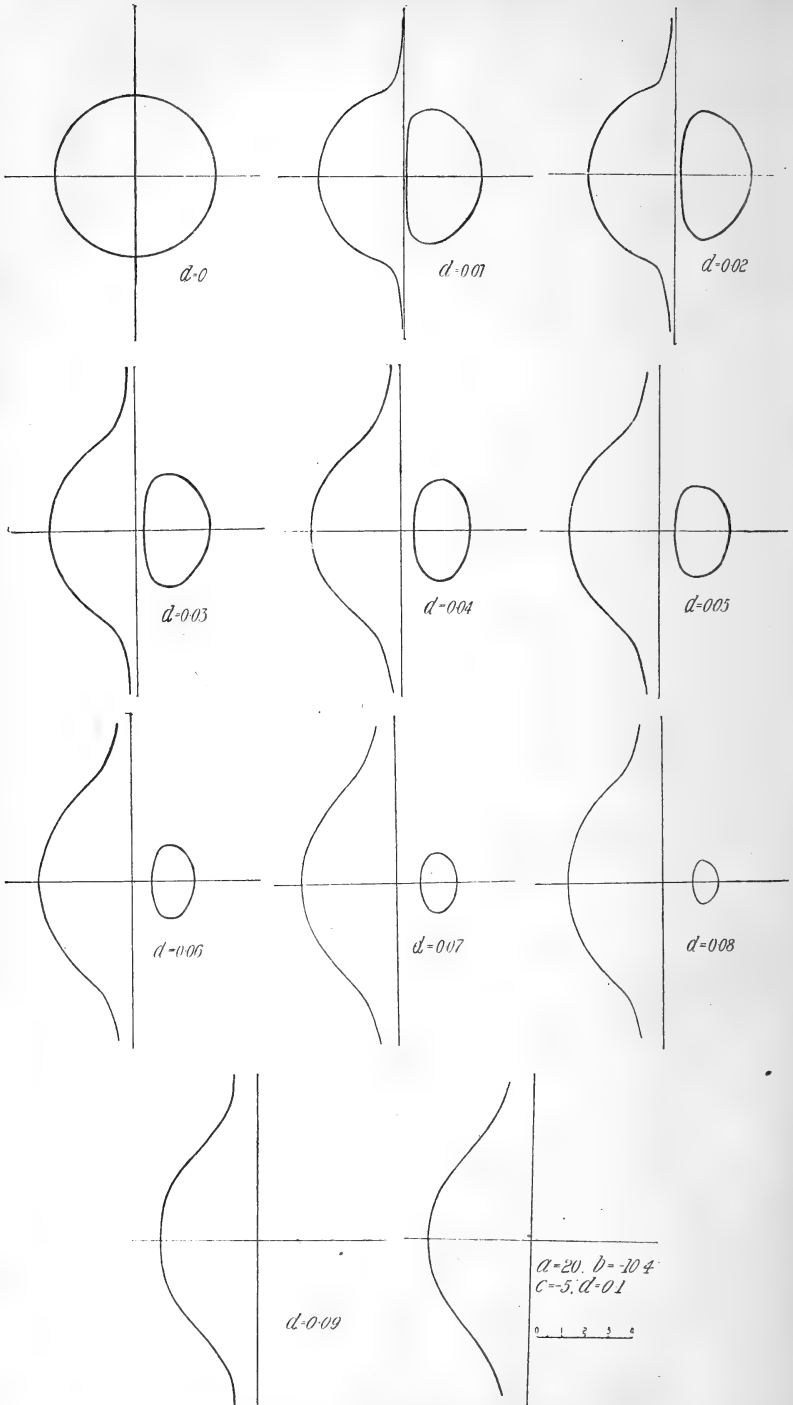

From the second of these equations values of r were computed for different values of θ , in the planes $z=b$ and $z=c$. Sections of the pencil by these two planes were obtained by drawing a number of concentric circles with the values of r for radii, crossed by radial lines at intervals of 5° . It will be obvious that corresponding points on the two sections lie on the same ray. The numerical values taken in the preparation of fig. 5 are: $a=20$, $b=-10.4$, $c=-5$, while d has values rising from 0 to .1 by .01 at a time. Parts of the two sections obtained are reproduced in fig. 5. The section at $z=-10.4$ was drawn to 20 times the scale of the other.

Fig. 5.

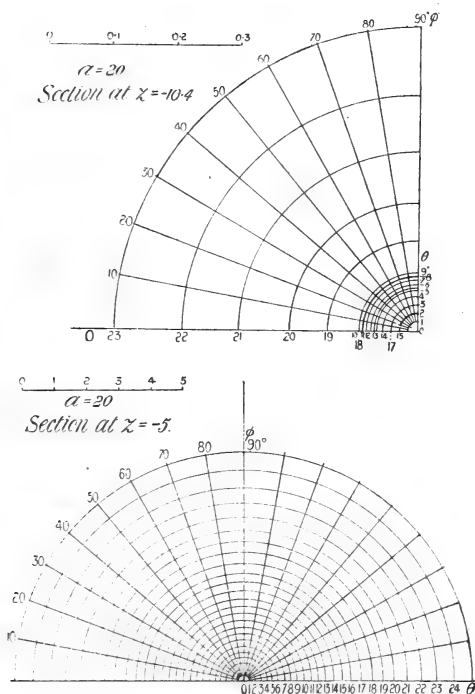

A thread was stretched over the first section to represent the position of the wire, the angular positions of the intersections with the wire were noted, and the corresponding points on the second section were marked on a piece of tracing-paper placed upon it. The form of the shadow is obtained by drawing through these points. The results are

shown in fig. 4. The way in which the ϕ form passes into the two-branched form is worthy of attention.

This method of working can of course be applied to find the shadow of an object of any shape, and is applicable to other kinds of pencils. If the two sections are drawn to the same scale, a thread model of the pencil can be made by erecting them in parallel planes and joining corresponding points by strings.

It will be noted that to each point of the wire there correspond three points in the shadow, and that all four lie in a plane passing through the axis. Thus if the wire terminates at the nearest point to the axis, the shadow will be as shown in fig. 6.

Fig. 6.

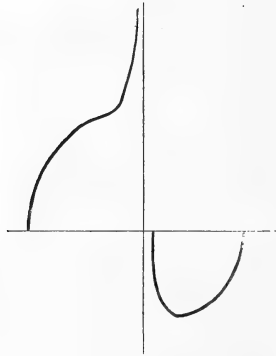

The equation of the shadow can be deduced without difficulty:—

The equations of a ray are :

$$\begin{cases} \phi = \text{const.} \\ r = -\tan 2\theta \left(z + \frac{a}{2 \cos \theta} \right). \end{cases}$$

The wire is given by :

$$\begin{cases} z = b, \\ r = \frac{d}{\cos \phi}. \end{cases}$$

Where the ray meets the screen $z = c$, and we have

$$r = -\tan 2\theta \left(c + \frac{a}{2 \cos \theta} \right). \dots \dots (1)$$

But since the ray passes through a point in the wire,

$$\frac{d}{\cos \phi} = -\tan 2\theta \left(b + \frac{a}{2 \cos \theta} \right). \dots \dots (2)$$

From (1) and (2),

$$\frac{r \cos \phi}{d} = \frac{c + \frac{a}{2 \cos \theta}}{b + \frac{a}{2 \cos \theta}},$$

whence

$$\cos \theta = \frac{a(r \cos \phi - d)}{2(cd - br \cos \phi)} \dots \dots \dots (3)$$

We will now eliminate θ between (1) and (3). Squaring (1) we have

$$\begin{aligned} r^2 &= \left(c + \frac{a}{2 \cos \theta} \right)^2 \tan^2 2\theta \\ &= \left(c + \frac{a}{2 \cos \theta} \right)^2 \cdot \frac{4 \cos^2 \theta (1 - \cos^2 \theta)}{(2 \cos^2 \theta - 1)^2}. \end{aligned}$$

Substituting for $\cos \theta$ and simplifying :

$$\begin{aligned} &\{a^2(2 \cos \phi - d)^2 - 2(cd - br \cos \phi)^2\}^2 \\ &= \cos^2 \phi a^2 (b - c)^2 \{4(cd - br \cos \phi)^2 - a^2(r \cos \phi - d)^2\}. \end{aligned}$$

This is the polar equation to the shadow, and is of the fourth degree in r .

Substituting $r \cos \phi = x$ and $r^2 = x^2 + y^2$ we get the Cartesian equation

$$\begin{aligned} &\{a^2(x - d)^2 - 2(cd - bx)^2\}^2 (x^2 + y^2) \\ &= x^2 a^2 (b - c)^2 \{4(cd - bx)^2 - a^2(x - d)^2\}. \end{aligned}$$

This is of the sixth degree and is met in six points by a line through the origin. Two degrees, however, are accounted for by a conjugate double point at the origin, introduced in the transformation. We are left with four shadow points for each point of the object. Evidently, however, the analysis applies to the complete spherical mirror, and one or three of these points will be due to rays which would pass virtually through the object after reflexion at the missing convex surface. The condition for this will be seen on reference to fig. 7, which shows a section of the complete mirror and of the epicycloid, which is the caustic for reflexion at both surfaces, the part to the right of the centre for the convex and that to the left for the concave surface. The rays which pass through any point are the tangents drawn through it to the epicycloid. Of these there are four if the point is outside the epicycloid; three from the concave and one from the convex surface of the mirror if the point is to the left of the centre, and three from the convex and one from the concave if it is to the right. If the point is inside the epicycloid

there will be two rays only, one from each surface. Evidently, then, the virtual shadow passes through much the same forms as we have already seen for the real.

Fig. 7.

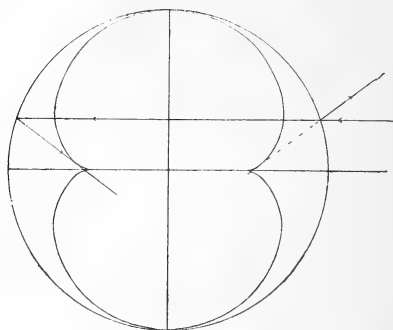

If the virtual shadow were drawn in fig. 4 it would be nearly straight, very close to the axis, and on the same side of it as the object.

Referring back to the Cartesian equation, we see that there are two asymptotes parallel to the axis of y given by

$$a^2(x-d)^2 - 2(cd-bx)^2 = 0;$$

or

$$x = \frac{a \pm c\sqrt{2}}{a \pm b\sqrt{2}} d;$$

so that we have always two open branches to the shadow, one real and the other virtual, and a closed branch which may be real or virtual, which contracts to a point when the object touches the caustic surface and vanishes when it does not meet it at all.

The Cartesian equation gives y^2 as a single-valued function of x and affords an alternative method for plotting the shadow forms.

If the pencil is not parallel before reflexion, or if we take a pencil rendered convergent by a lens with spherical surfaces, we get in general a less simple expression for the longitudinal aberration, and the equation of the shadow takes a more complicated form. The real shadows are, however, of much the same appearance. Fig. 8 (Pl. XXVII.) shows a series of photographs of shadows of a straight wire in a pencil produced by refraction at a plano-convex lens. The lens used was of about 10 cms. diameter and the radius of curvature of its spherical face was 7.8 cms. The disposition of the apparatus was as follows:—An image of the filament of a Nernst lamp was focussed on to a card screen pierced by a pinhole, so that the image

actually crossed the pinhole. The plano-convex lens was placed 43 cms. beyond this with its convex side towards the incident light. A vertical wire was placed in the emergent beam about 18 cms. from the lens, and its shadow received on a photographic plate 15 cms. beyond. As the shadows were heavily fringed with colour, a coloured screen was placed before the lamp. This consisted of a parallel-sided glass cell 5 mms. thick, containing equal volumes of a 0.5 % solution of acid green in water and 0.1 % solution of tartrazin. This was recommended by Mr. A. J. Bull as transmitting only a short region in the blue-green of the spectrum, from about $\lambda 4900$ to $\lambda 5100$, and proved very satisfactory. The plates were Westerndorp and Wehner's Isochromatic. Fig. 9 (Pl. XXVII.) shows a shadow obtained by this method with the wire not completely crossing the pencil, and illustrates the collinearity of the shadows of a point.

There is another and a more convenient way in which these forms can be observed. If the eye takes the place of the illuminated pinhole, the disposition of the lens or mirror and the object-wire remaining the same, the form of the image of the wire that is seen is that of a section of the surface ruled by rays passing through the pupil and the object-wire, which is that of the virtual shadow on the surface of the lens or mirror, and practically identical with that of the real shadow on a plane beyond the wire. Thus the forms can be seen with great clearness by looking at the reflexion in a concave mirror of a straight wire held suitably between the mirror and the eye. On moving the eye from side to side the image passes through the same phases, as shown in fig. 4, while if the eye be moved nearer to or farther from the mirror, the effect of moving the wire in a direction parallel to the axis is imitated. If two eyes are used two of the phases are seen simultaneously. Similar results can be obtained by looking at a wire through a suitable lens; the chromatic effects are more in evidence if the wire is replaced by the straight filament of an incandescent lamp, or by an illuminated slit, so that the shadow-forms are seen bright against a dark background. If the slit is replaced by a number of parallel slits, or by a rectangular grating, very complicated forms are seen, which are formed by the superposition of the curves due to the various straight slits. I have seen the same effect by looking through the globe of a sunshine recorder at the rulings on the record strip beneath.

This arrangement may also be used for photographing the shadows, the eye being replaced by a camera. The place of the pupil must be taken by the diaphragm of the lens, which must be stopped down to a small aperture.

INDEX TO VOL. VII.

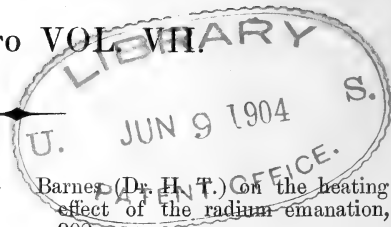

- ABADY (J.)** on the Simmance-Abady flicker photometer, 341.
Aerodynamics, on the principles of, 667.
Æther, on double refraction in matter moving through the, 317; neutron structure of the, 440; on the ascertained absence of effects of motion through the, in relation to the constitution of matter, 621.
Aggregates, on the transfinite cardinal numbers of well-ordered, 61.
Air, on the condensation method of demonstrating the ionization of, 681.
Allan (Dr. G. E.) on the magnetism of basalt, 45.
Allan (S. J.) on the radioactivity of the atmosphere, 140.
Ammeter, on a hot-wire, for the measurement of small alternating currents, 595.
Andrews (E. S.) on the viscosity of pitch-like substances, 347.
Angle, on the division of an, in an arbitrary ratio, 75.
Appleyard (R.) on the conductometer, 281.
Arc, on the, in metallic vapours, 95.
Astigmatic pencil, on the standard, 700.
Atmosphere, on the radioactivity of the, 140.
Atmospheres, on the escape of gases from, 690.
Atomic vibration, on the nature of, 420.
Atoms, on the structure of, 237; on the dielectric capacity of, 402.
Austin (L. W.) on the disintegration of the platinum metals in different gases, 388.
Barkla (C. G.) on the energy of secondary Röntgen radiation, 543.
Barnes (Dr. H. T.) on the heating effect of the radium emanation, 202.
Barnes (J.) on the analysis of bright spectrum lines, 485.
Basalt, on the magnetism of, 45.
Bennett (W.), notes on non-homocentric pencils, 700, 706.
Bismuth, on the Thomson effect in alloys of, 560.
Books, new:—Nordmann's *Essai sur le rôle des ondes Hertziennes en Astronomie Physique*, 77; Fleming's *Handbook for the Electrical Laboratory and Testing Room*, 233; Michelson's *Light Waves and Their Uses*, 235; Mathias's *Le Point Critique des Corps Purs*, 235; Classen's *Ausgewählte Methoden der analytischen Chemie*, 236; *Annuaire pour l'an 1904*, 236; Perrin's *Traité de Chimie Physique*, 307; Planck's *Treatise on Thermodynamics*, 308; Ostwald's *Die Schule der Chemie*, 309; Pernter's *Allerlei Methoden, das Wetter zu prophezeien*, 310; Poincaré's *La Science et l'Hypothèse*, 310; Stark's *Die Dissoziierung und Umwandlung Chemischer Atome*, 414; Whittaker's *Course of Modern Analysis*, 605; Hilton's *Mathematical Crystallography*, 605; Duhem's *Thermodynamics and Chemistry*, 606; Young's *Fractional Distillation*, 607.
Borgnet's method of dividing an angle in an arbitrary ratio, on, 75.
Boulton (W. S.) on the igneous rocks at Spring Cove, 313.
Brace (Prof. D. B.) on double refraction in matter moving through the æther, 317.

- Bumstead (Dr. H. A.) on the variation of entropy as treated by Prof. Willard Gibbs, 8.
- Burbury (S. H.) on the kinetic theory of gases, 467.
- Burrard (Major S. G.) on deflexions of the plumb-line in India, 292.
- Cadmium, analysis of the bright lines in the spectrum of, 500.
- Canal rays, on the relation of the electric charges transported by, to the exciting current, 180.
- Capacities, on the measurement of small, 586.
- Capacity, on the effect of, at the ends of a circular resonator, 652.
- Cathode rays, on the relation of the electric charges transported by, to the exciting current, 180.
- Cavitation, on the occurrence of, in lubrication, 329.
- Chant (C. A.) on the variation of potential along the transmitting antenna in wireless telegraphy, 124.
- Chartres (R.), note on π , 315.
- Chree (Dr. C.) on the bending of magnetometer deflexion-bars, 39; on the whirling and transverse vibrations of rotating shafts, 504.
- Circuits, comparison of the periods of the electrical vibrations associated with simple, 635.
- Close (J. C.) on the effect of capacity at the ends of a circular resonator, 652.
- Conduction currents in metals, on the number of electrons conveying the, 151.
- Conductometer, on the, 281.
- Conics, on an instrument for drawing, 274, 608.
- Contact difference of potential, on the theory of, 435.
- Cotter (J. R.) on an instrument for drawing conics, 274, 608.
- Crémieu-Pender discovery, on the, 405.
- Darwin (H.) on an electric thermostat, 408.
- Davison (Dr. C.) on the Derby earthquakes of 1903, 416.
- Dielectric capacity of atoms, on the, 402.
- constant of water at low temperatures, on the, 655.
- Diffraction, on some new cases of, 376.
- Diffusion in solution of dissociated gases, on the, 266.
- Double refraction in matter moving through the æther, on, 317.
- Electric capacities, on the comparison of, 362; on the measurement of small, 586.
- charges, on the relation of the, transported by cathode and canal rays to the exciting current, 180; on ions, on the, 276.
- conductivity, on a new instrument for the comparison of, 281; on the theory of, 423; of solutions, on the, 469.
- current, on the radiation from an alternating circular, 336; on a hot-wire ammeter for the measurement of small alternating, 595.
- field, on the motion of radium in the, 303.
- inductance, on a standard of small, 586.
- origin of rigidity, on the, 417.
- thermostat, on an, 408.
- vibrations associated with simple circuits, comparison of the periods of the, 635.
- Electrical qualities of metals, on relations between the optical and, 157.
- Electricity, on the effect of the passage of, through a mixture of oxygen and hydrogen at low pressures, 223.
- Electrons, on the number of, conveying the conduction currents in metals, 151.
- English (Lt.-Col. T.) on Eocene formations surrounding the Dardanelles, 414.
- Entropy, on the variation of, 8.
- Everett (Prof. J. D.) on Borgnet's method of dividing an angle in an arbitrary ratio, 75.
- Fisher (Rev. O.) on deflexions of the plumb-line in India, 14.
- Fitzgerald-Lorentz hypothesis, on the, 621.
- Fleming (Prof. J. A.) on the measurement of small inductances and capacities, 586; on a hot-wire ammeter for the measurement of small alternating currents, 595.
- Francis (Dr. W.), obituary notice of, 315.
- Gases, on the effect of temperature on

- the ionization produced in, by Röntgen rays, 81; on the solubility and diffusion in solution of dissociated, 266; on the charges on ions produced in, 276; on the disintegration of the platinum metals in different, 388; on the kinetic theory of, 467; on the escape of, from atmospheres, 690.
- Geological Society, proceedings of the, 79, 310, 414.
- Glass, on the viscosity of soda-, 353.
- Gore's phenomenon, on, 626.
- Gregory (Prof. J. W.) on the glacial geology of Tasmania, 80.
- Hagen (Prof. E.) on relations between the optical and the electrical qualities of metals, 157.
- Harrison (Dr. E. P.) on the temperature-variation of the coefficient of expansion of pure nickel, 626.
- Himalaya mountains, on the attraction of the, upon the plumb-line, 14, 292.
- Holborn (L.) on the disintegration of the platinum metals in different gases, 388.
- Hosking (R.) on the electrical conductivity and fluidity of solutions, 469.
- Houstoun (R. A.), spectroscopic notes, 456.
- Hydrogen and oxygen at low pressures, on the effect of the passage of electricity through a mixture of, 223; analysis of the bright lines in the spectrum of, 501.
- Inductances, on the measurement of small, 586.
- Interference, on some new cases of, 376.
- Ionization produced in gases by Röntgen rays, on the effect of temperature on the, 81; on the condensation method of demonstrating the, of air, 681.
- Ions, on the charges on, 276.
- Jeans (J. H.) on the kinetic theory of gases, 467.
- Joly (Prof. J.) on the motion of radium in the electric field, 303.
- Jourdain (P. E. B.) on the transfinite cardinal numbers of well-ordered aggregates, 61; on the transfinite cardinal numbers of number-classes in general, 294.
- Kelvin (Lord) on the nature of the emanations from radium, 220; on the destruction of cambric by exposure to radium bromide, 233; on deep-water two-dimensional waves produced by any given initiating disturbance, 609.
- Kirkby (Rev. P. J.) on the effect of the passage of electricity through a mixture of oxygen and hydrogen at low pressures, 223.
- Larmor (Prof. J.) on the intensity of the natural radiation from moving bodies and its mechanical reaction, 578; on the ascertained absence of effects of motion through the æther in relation to the constitution of matter, 621.
- Laws (S. C.) on the Thomson effect in alloys of bismuth and tin, 560.
- Leininger (F.) on the relation of the electric charges transported by cathode and canal rays to the exciting current, 180.
- Light, on non-homocentric pencils of, 700, 706.
- Lubrication, on the occurrence of cavitation in, 329.
- McClelland (Prof. J. A.) on the emanation given off by radium, 355; on the comparison of capacities in electrical work, 362.
- McClung (R. K.) on the effect of temperature on the ionization produced in gases by Röntgen rays, 81.
- Magnetic behaviour of basaltic bars when heated in air, on the, 45.
- Magnetism, on the, of basalt, 45.
- Magnetograph, on a quartz-thread vertical force, 393.
- Magnetometer deflexion-bars, on the bending of, 39.
- Magneto-static field, on stresses in a, 399.
- Mercury, analysis of the bright lines in the spectrum of, 496; on the vapour-pressure of, 662.
- Mercury vapour, on the arc in, 95.
- Metallic vapours, on the arc in, 95.
- Metals, on the number of electrons conveying the conduction currents in, 151; on relations between the optical and electrical qualities of, 157; on the disintegration of the platinum, in different gases, 388.
- Michelson-Morley experiment, on the, 317, 405, 621.

- Morgan (Prof. C. Ll.) on the igneous rocks of the Bristol district, 310.
- Morley (E. W.) on the vapour-pressure of mercury at ordinary temperatures, 662.
- Nagaoka (Prof. H.) on the kinetics of a system of particles illustrating the line and the band spectrum and the phenomena of radioactivity, 445.
- Nickel, on the temperature-variation of the coefficient of expansion of pure, 626.
- Optical and electrical qualities of metals, on relations between the, 157.
- Orr (Prof. W. McF.) on the radiation from an alternating circular current, 336.
- Oxygen and hydrogen at low pressures, on the effect of the passage of electricity through a mixture of, 223.
- Parabolas, on a novel instrument for drawing, 200.
- Pearson (Prof. K.) on a novel instrument for drawing parabolas, 200.
- Pencils, notes on non-homocentric, 700, 706.
- Pfund (A. H.) on the selenium cell, 26.
- Photographic action of radium rays, on the, 288.
- Photometer, on the Simmance-Abady flicker, 341.
- π , note on, 315.
- Pitch-like substances, on the viscosity of, 347.
- Platinum metals, on the disintegration of the, in different gases, 388.
- Plumb-line, on deflexions of the, in India, 14, 292.
- Pollock (Prof. J. A.) on the periods of the electrical vibrations associated with simple circuits, 635.
- Porter (T. C.) on a method of mechanically reinforcing sounds, 283.
- Potential, on the variation of, along the transmitting antenna in wireless telegraphy, 124.
- Radiation from an alternating circular current, on the, 336; on the energy of secondary Röntgen, 543; on the intensity of the natural, from moving bodies, 578.
- Radioactive substances, application of, to the comparison of capacities, 362.
- Radioactivity of the atmosphere, on the, 140; on the kinetics of a system of particles illustrating the phenomena of, 445.
- Radium, on the motion of, in the electric field, 303.
- Radium emanation, on the heating effect of the, 202; on the nature of the, 220; on the rotting of cambic by exposure to, 233; on the photographic action of, 288; on the charge carried by the, 355.
- Rau (Prof. H. N.) on a deep-sea deposit from Kilacheri, 313.
- Reid (C. and E. M.) on a palæolithic floor at Prah Sands, 312.
- Resonator, on the effect of capacity at the ends of a circular, 652.
- Reynolds (Prof. S. H.) on the igneous rocks of the Bristol district, 310; on the Rhætic beds of the S. Wales direct line, 314.
- Richardson (O. W.) on the solubility and diffusion in solution of dissociated gases, 266.
- Rigidity, on the electric origin of, 417.
- Röntgen radiation, on the effect of temperature on the ionization produced in gases by, 81; on the energy of secondary, 543.
- Rubens (Prof. H.) on relations between the optical and the electrical qualities of metals, 157.
- Rutherford (Prof. E.) on the heating effect of the radium emanation, 202.
- Schuster (Prof. A.) on a simple explanation of Talbot's bands, 1; on the number of electrons conveying the conduction currents in metals, 151.
- Selenium cell, on the, 26.
- Shadows produced by axially symmetrical pencils, on, 706.
- Shafts, on the whirling and transverse vibrations of rotating, 504.
- Short (A. R.) on the Rhætic beds of England, 311.
- Simmance (—) on the Simmance-Abady flicker photometer, 341.

- Skinner (S.) on the photographic action of radium rays, 288; on the occurrence of cavitation in lubrication, 329.
- Smoluchowski-Smolán (Prof. M.) on the principles of aerodynamics, 667.
- Solubility of dissociated gases, on the, 266.
- Solutions, on the electrical conductivity and fluidity of, 469.
- Sounds, on a method of mechanically reinforcing, 283.
- Spectroscopic notes, 456.
- Spectrum, on the explanation of Talbot's bands in a, 1; on the kinetics of a system of particles illustrating the line and the band, 445; on the analysis of bright lines of the, 485.
- Stoney (Dr. G. J.) on the escape of gases from atmospheres, 690.
- Stresses in a magneto-static field, on, 399.
- Sutherland (W.) on the dielectric capacity of atoms, 402; on the Crémieu-Pender discovery, 405; on the electric origin of rigidity, 417.
- Talbot's bands, on a simple explanation of, 1.
- Temperature, on the effect of, on the ionization produced in gases by Röntgen rays, 81.
- Thallium, analysis of the bright lines in the spectrum of, 501.
- Thermostat, on an electric, 408.
- Thomson (Prof. J. J.) on the structure of the atom, 237.
- Thomson effect in alloys of bismuth and tin, on the, 560.
- Threlfall (Prof. R.) on a new form of sensitive hot-wire voltmeter, 371.
- Tin, on the Thomson effect in alloys of, 560.
- Townsend (Prof. J. S.) on the charges of ions, 276.
- Transfinite cardinal numbers of well-ordered aggregates, on the, 61; of number-classes in general, on the, 294.
- Trouton (Prof. F. T.) on the viscosity of pitch-like substances, 347.
- Vaughan (A.) on the Rhætic beds of the S. Wales direct line, 314.
- Viscosity of pitch-like substances, on the, 347.
- Voltmeter, on a new form of sensitive hot-wire, 371.
- Vonwiller (Dr. O. U.) on the dielectric constant of water at low temperatures, 655.
- Walker (E. E.) on the garnet-bearing rocks of the Borrowdale series, 79.
- Walker (G. W.) on stresses in a magneto-static field, 399.
- Water, on the dielectric constant of, at low temperatures, 655.
- Watson (Prof. W.) on a quartz-thread vertical force magnetograph, 393.
- Waves, on deep-water two-dimensional, 609.
- Weintraub (Dr. E.) on the arc in metallic vapours in an exhausted space, 95.
- Whirling of rotating shafts, on the, 504.
- Wilson (C. T. R.) on the condensation method of demonstrating the ionization of air under normal conditions, 681.
- Wireless telegraphy, on the variation of potential along the transmitting antenna in, 124.
- Wood (Prof. R. W.) on some new cases of interference and diffraction, 376.

END OF THE SEVENTH VOLUME.

FIG. 8.

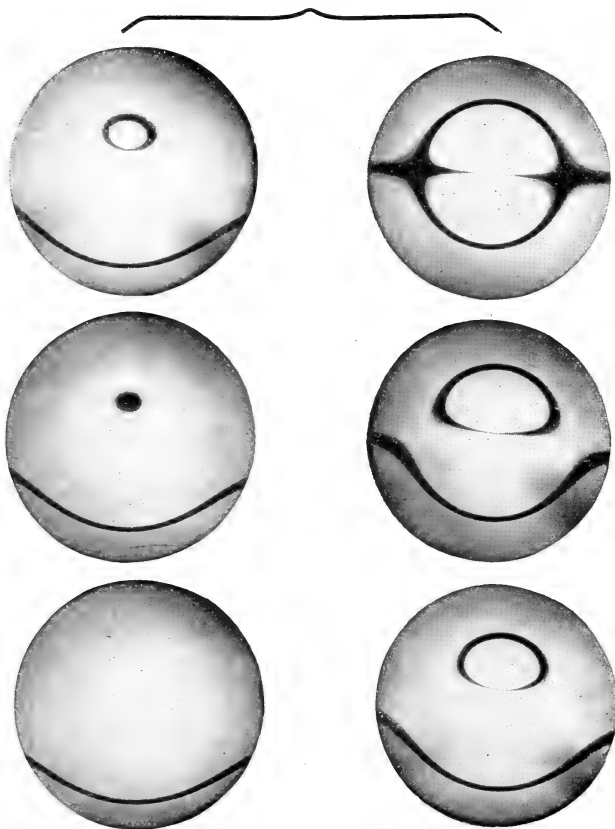
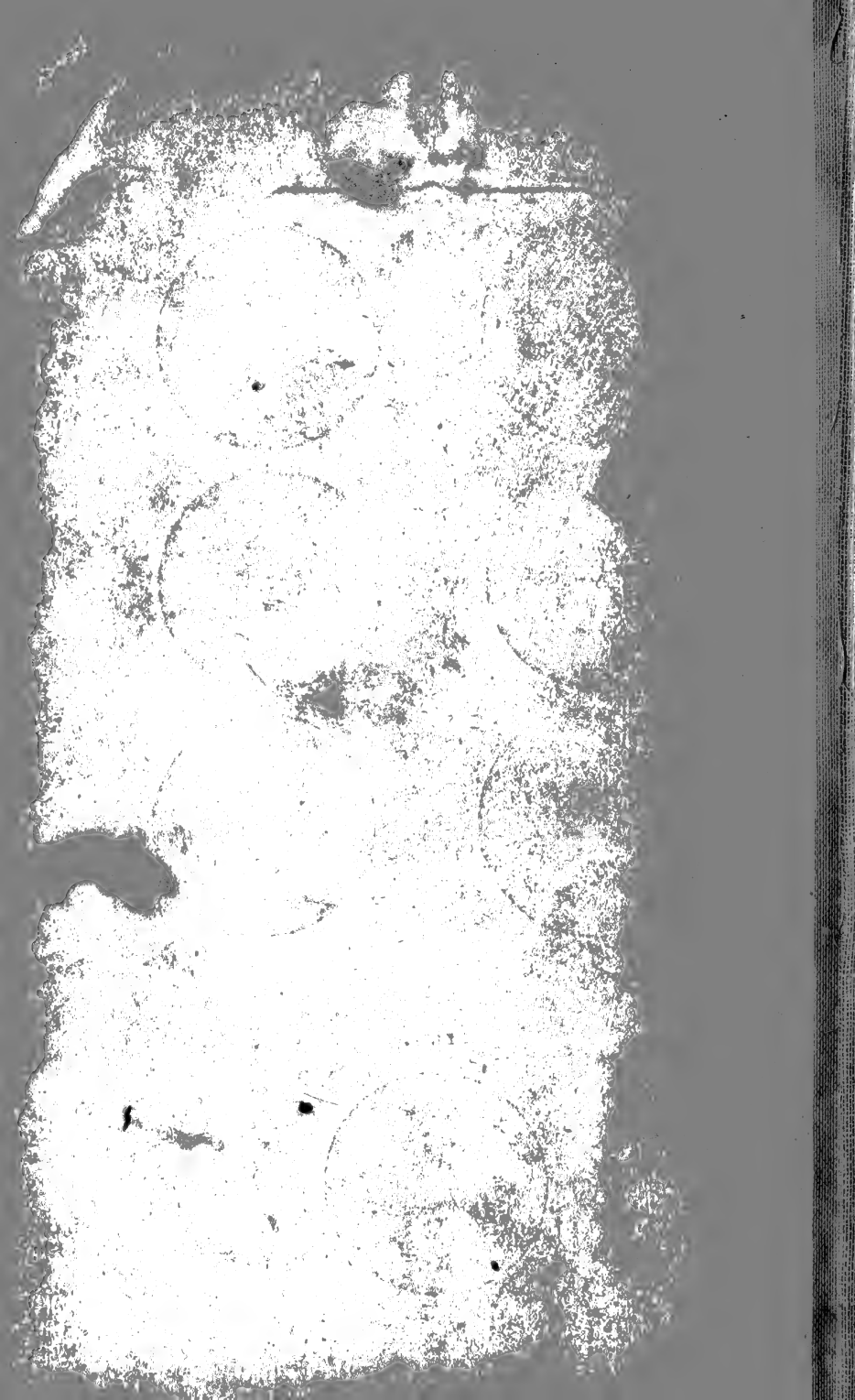
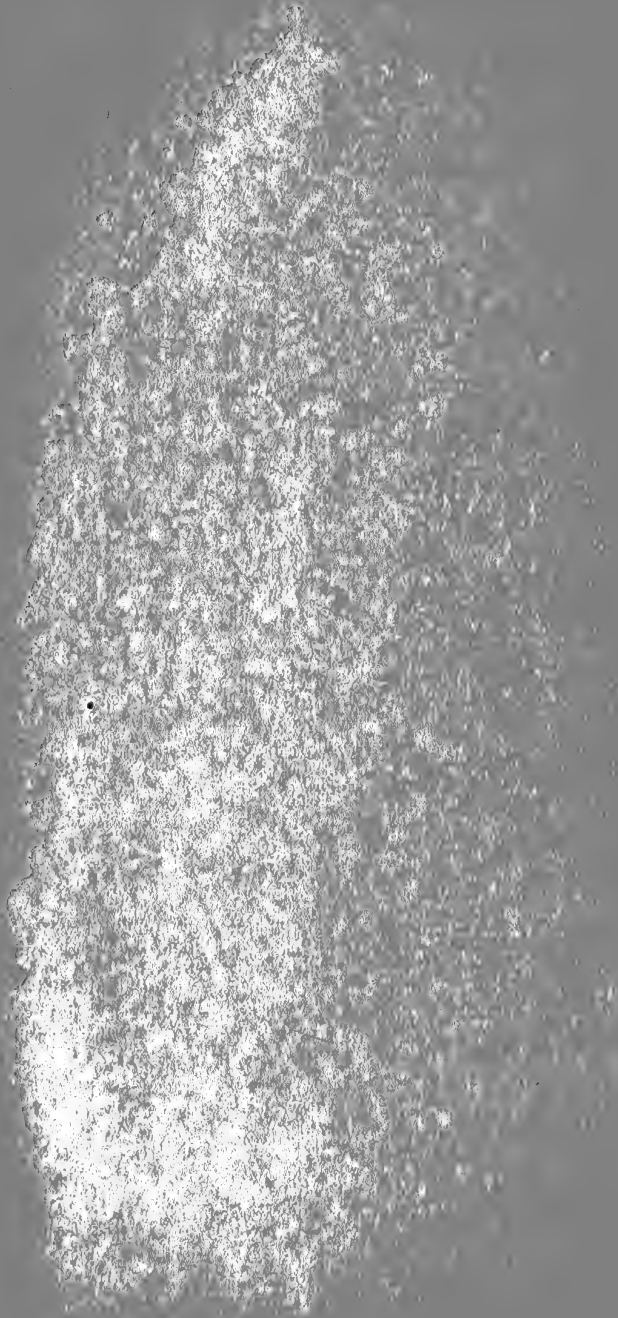

FIG. 9.









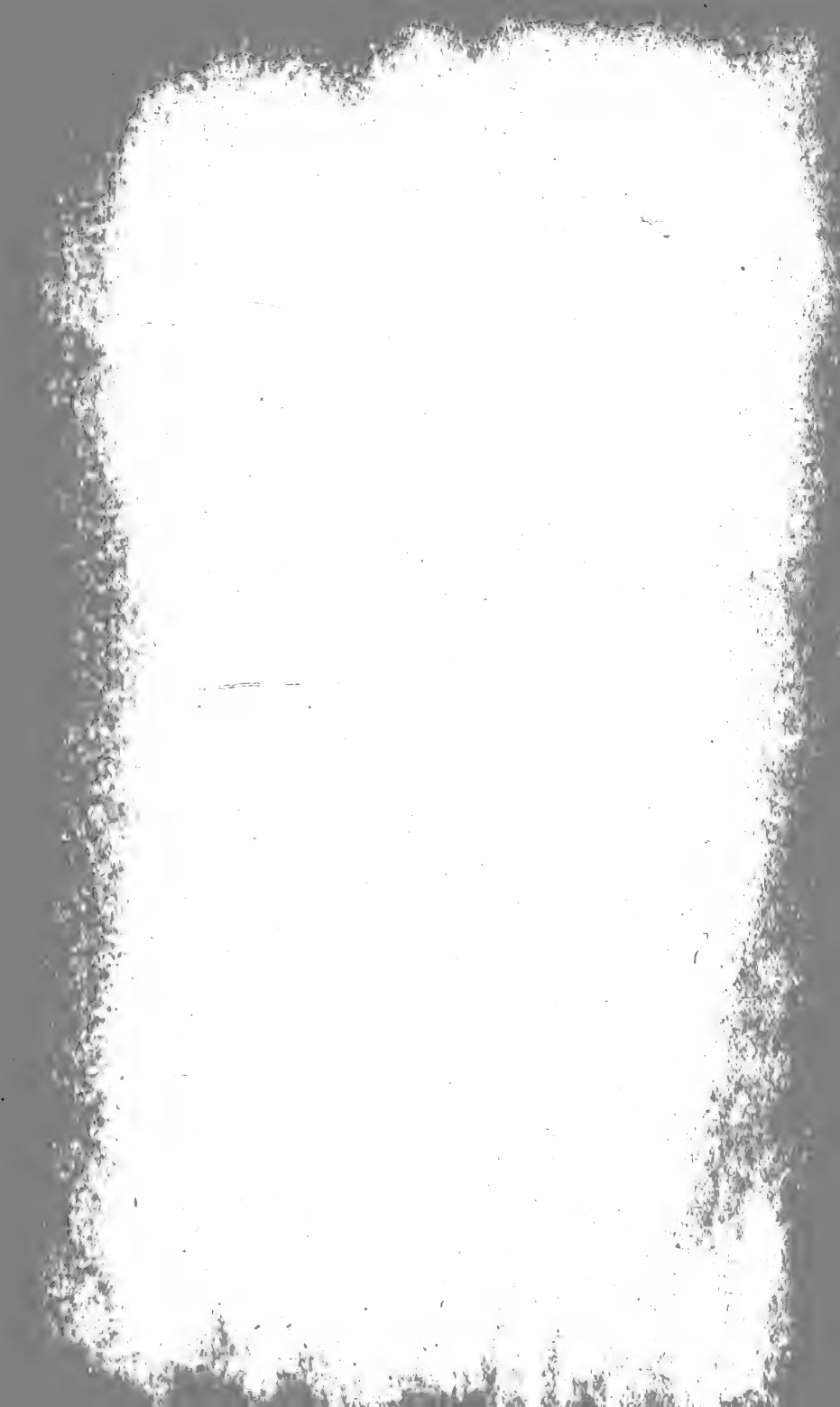

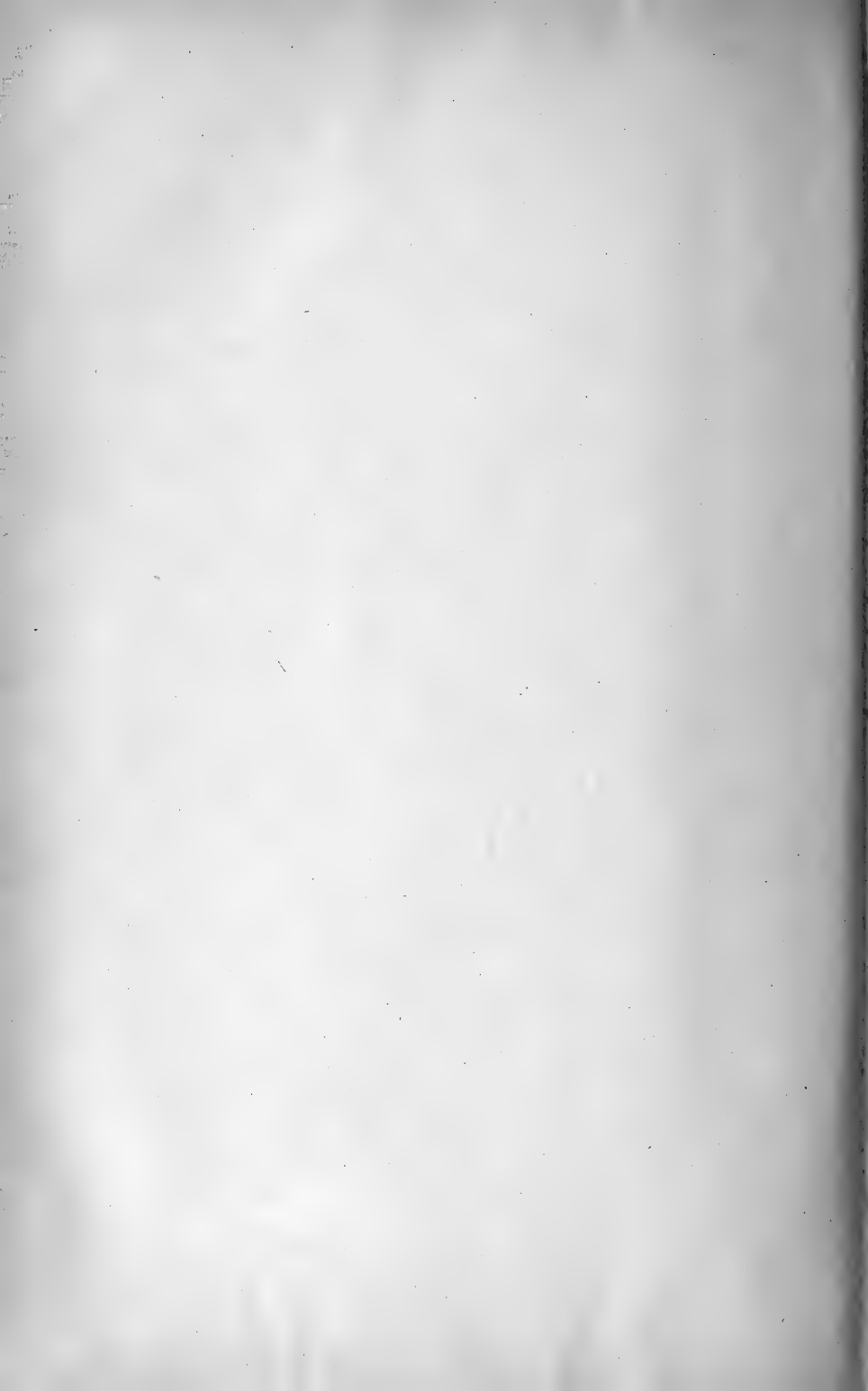

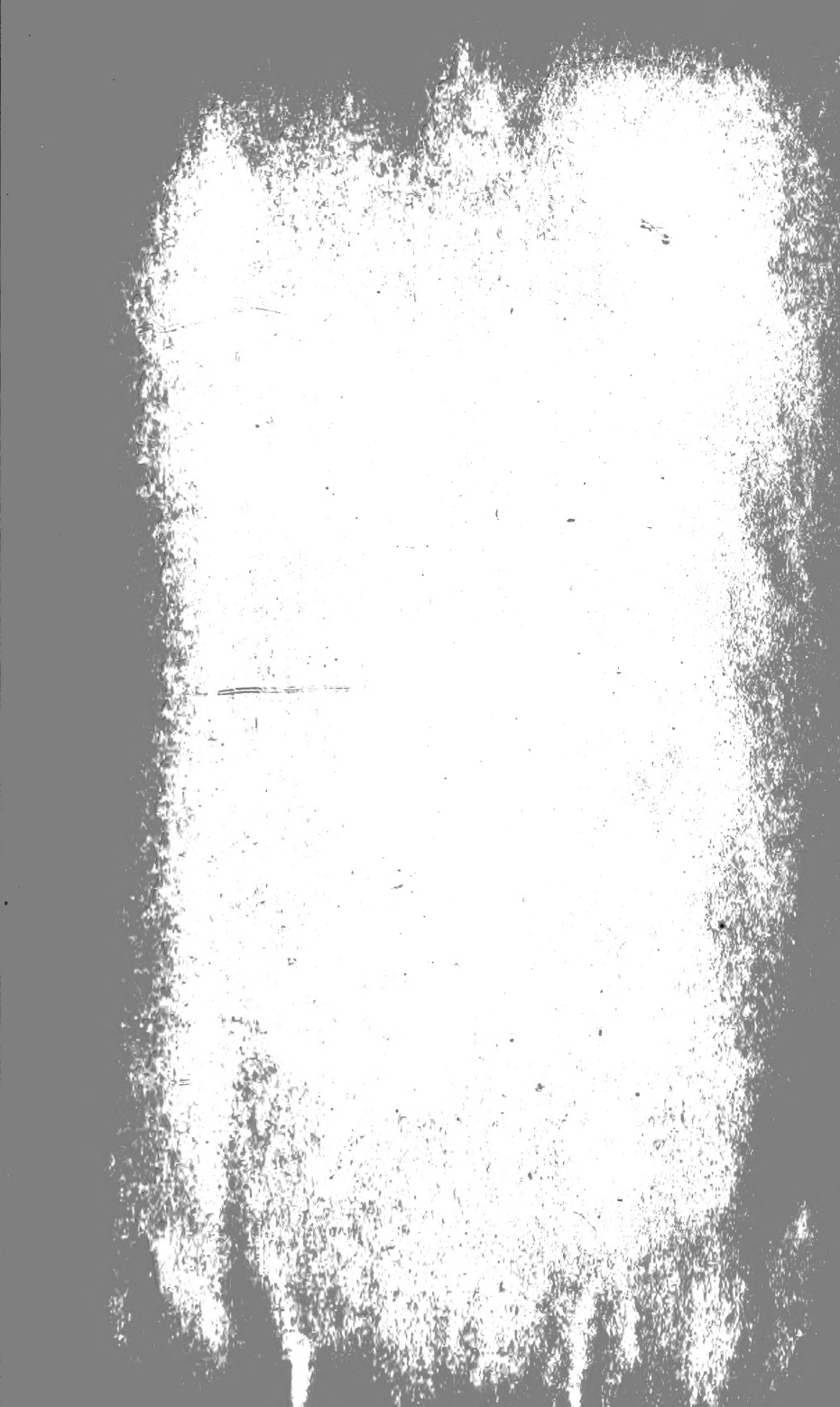

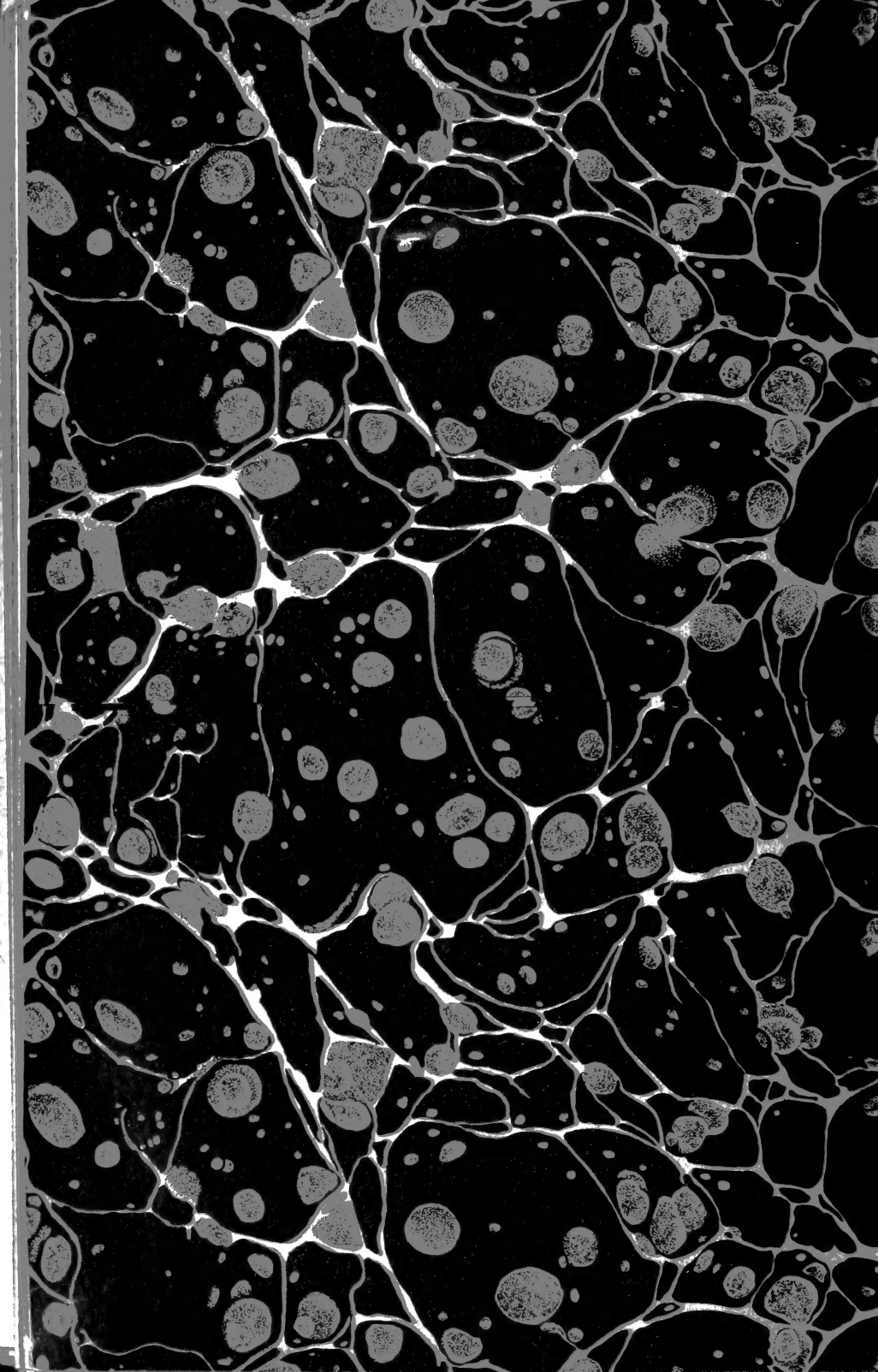

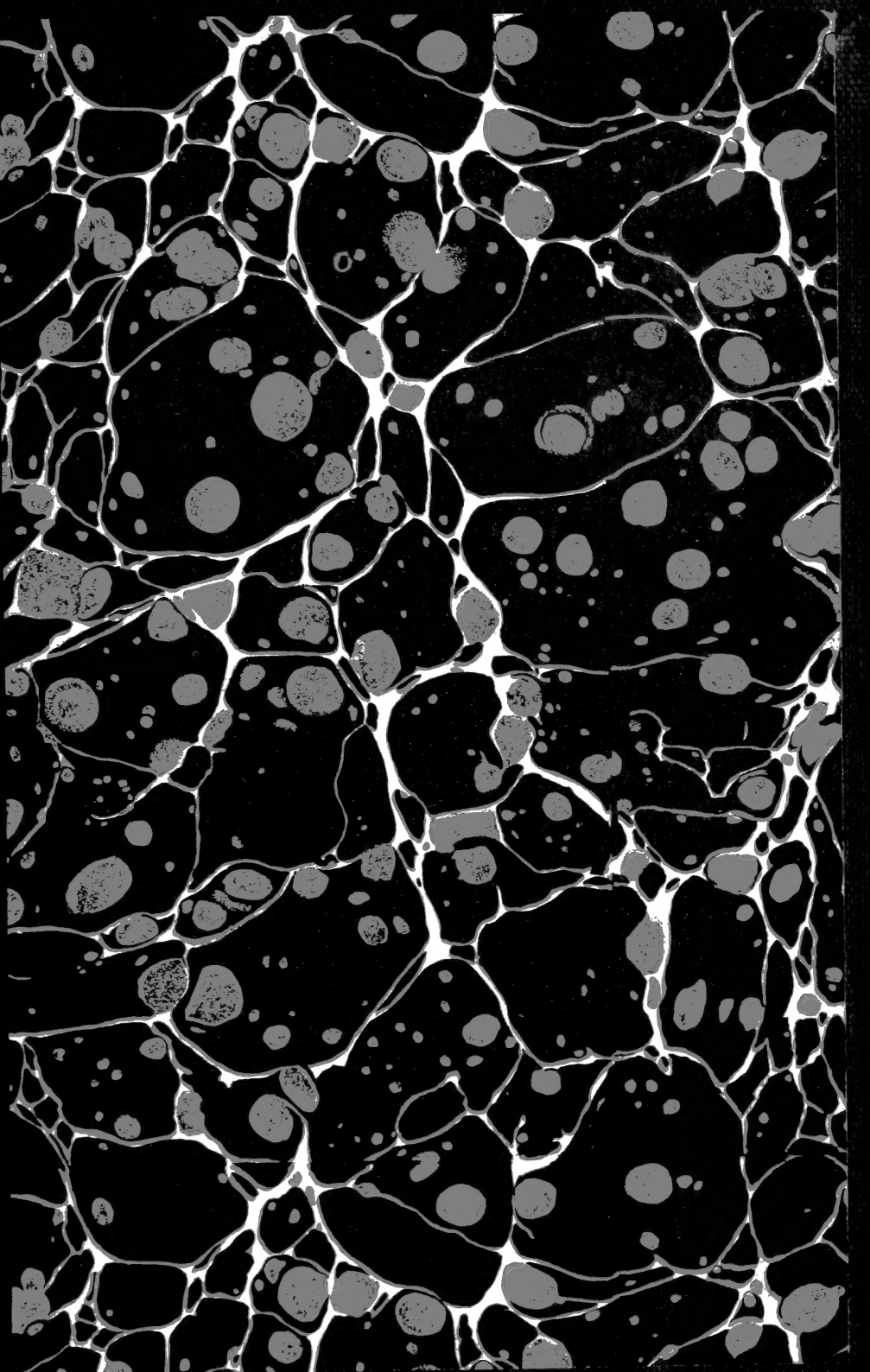

SMITHSONIAN INSTITUTION LIBRARIES



3 9088 01202 4733