

LOUDEN



HAY UNLOADING TOOLS
DAIRY BARN EQUIPMENT
HORSE STABLE EQUIPMENT
LITTER AND FEED CARRIERS
BARN DOOR HANGERS
SPECIALTIES



ESTABLISHED
1867

THE LOUDEN MACHINE CO. COMPANY

FAIRFIELD
IOWA

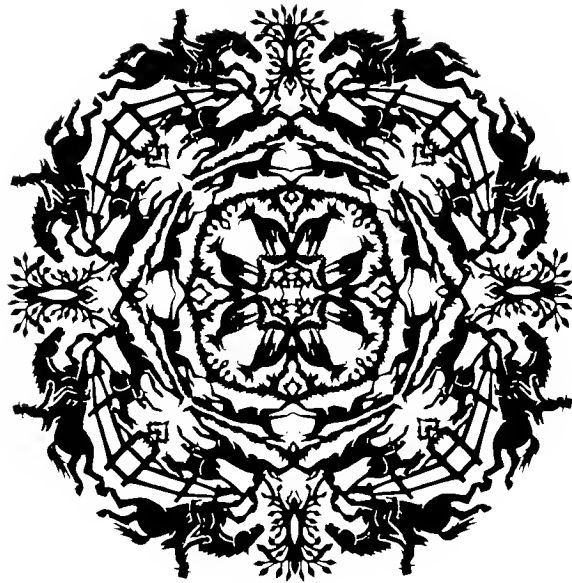

JOHN A. SEAVERNS

GENERAL INDEX

Complete Index, Pages 222-224

Hay Tools

	PAGES
Hay Carriers and Fittings	8 32
Power Hoists	33 35
Hay Forks, Slings, and Fittings	38 48
Pulleys and Other Specialties	49 56
Barn and Garage Door Hangers and Specialties	59 67

Dairy Barn Equipment

Cow Stalls and Fittings	76 97
Mangers and Manger Divisions	98 106
Stanchions	109 114
Water Bowls	115 119
Steel Pens, Gates, Hinges, Etc.	120 133
Miscellaneous Supplies and Information	134 139
Cupolas, Ventilators, and Window Ventilators	141 146
Manger and Gutter Drains	147, 148, and 212
Paint	149

Litter, Feed, and Other Carriers

General Information	152 155
Litter Carriers	157 166
Feed Carriers and Trucks	167 171
Harness Carriers	171
Merchandise Carriers	172
Milk Can Carriers	173 174
Truck and Fittings, Swinging Cranes, Switches, Etc.	175 190
Arrangements for Bams	191 193

Horse Stable Equipment

Hay Racks	198 203
Feed Boxes	204 206
Watering Troughs	207 208
Horse Stalls, Partitions, and Supplies	208 211
Harness Hooks and Salt Roll Holders	210
Cess Pools	212
Higbie Oats Cleaner	213

Barn Plans

General Information	217 220
Specimen Plans	220 221

LOUDEN

HAY UNLOADING TOOLS
BARN AND GARAGE DOOR HANGERS
DAIRY BARN EQUIPMENT
LITTER, FEED, MERCHANDISE, AND MILK CAN
CARRIERS
HORSE STABLE EQUIPMENT
CUPOLAS, VENTILATORS, DRAINS, ETC.
HARDWARE SPECIALTIES

GENERAL CATALOG No. 46

Issued November, 1916

The largest factory in the world devoted exclusively to the
manufacture of Barn and Stable Equipment.

MAIN FACTORY, FAIRFIELD, IOWA

BRANCH HOUSES

The Loudon Machinery Company, St. Paul, Minnesota
The Loudon Machinery Company, Albany, New York
The Loudon Machinery Company, Chicago, Illinois
The Harbison Manufacturing Company, Kansas City, Missouri

CANADIAN FACTORY

The Loudon Machinery Company, Guelph, Ontario

THE LOUDEN MACHINERY COMPANY

PAID UP CAPITAL, \$750,000

ESTABLISHED 1867

FAIRFIELD, IOWA



THE LOUDEN MACHINERY COMPANY
ALBANY N.Y.

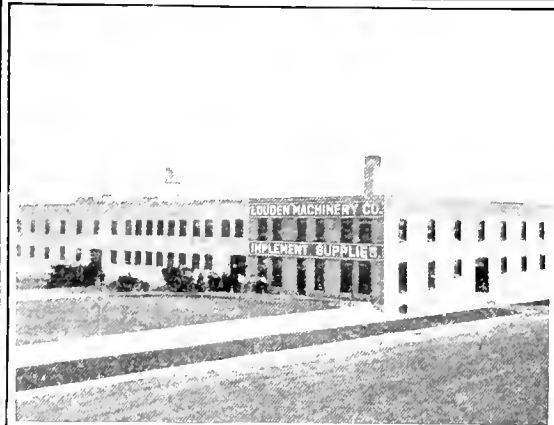

THE LOUDEN MACHINERY COMPANY
ST. PAUL, MINN.

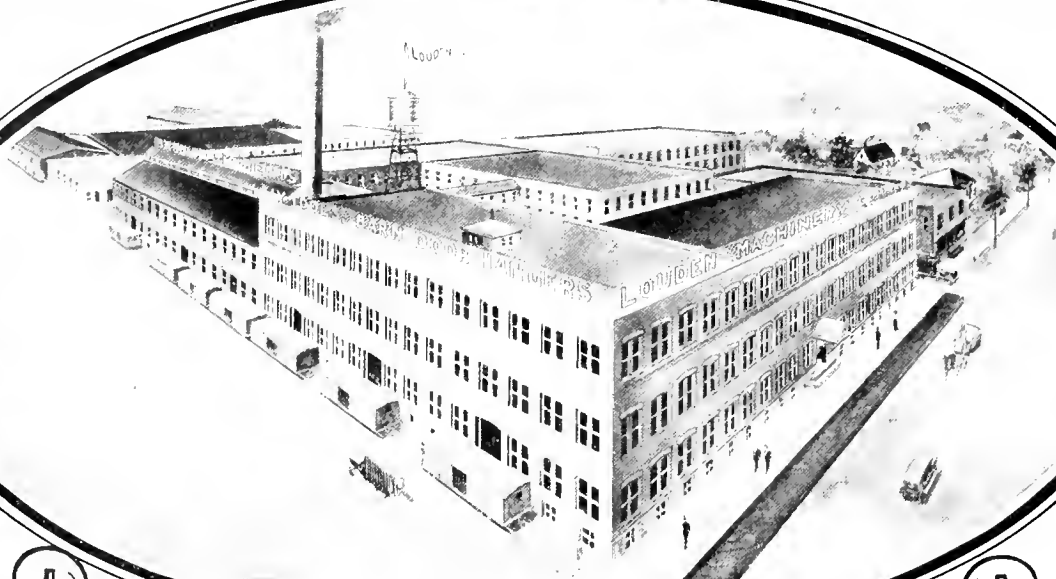

HOME OFFICE AND FACTORY, FAIRFIELD, IOWA.

FACTORY AND BRANCH HOUSES OF THE LOUDEN MACHINERY CO. IN U.S.A.



THE HARBISON MFG. CO. KANSAS CITY, MO.
WESTERN REPRESENTATIVES

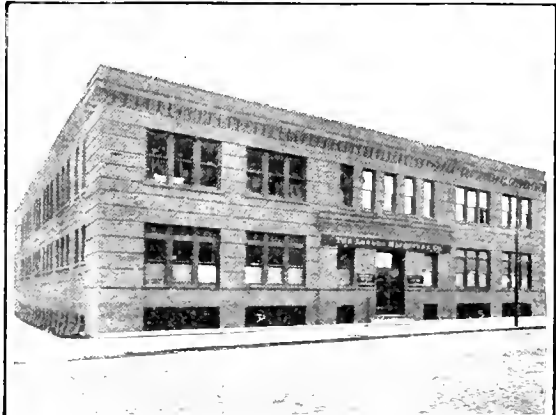

THE LOUDEN MACHINERY COMPANY
CHICAGO, ILL.

INTRODUCTORY

The number of barns equipped with Louden products runs into the millions and these goods have been sold—not as a result of advertising, not as a result of a superior selling organization, but as a result of the sterling worth of Louden quality.

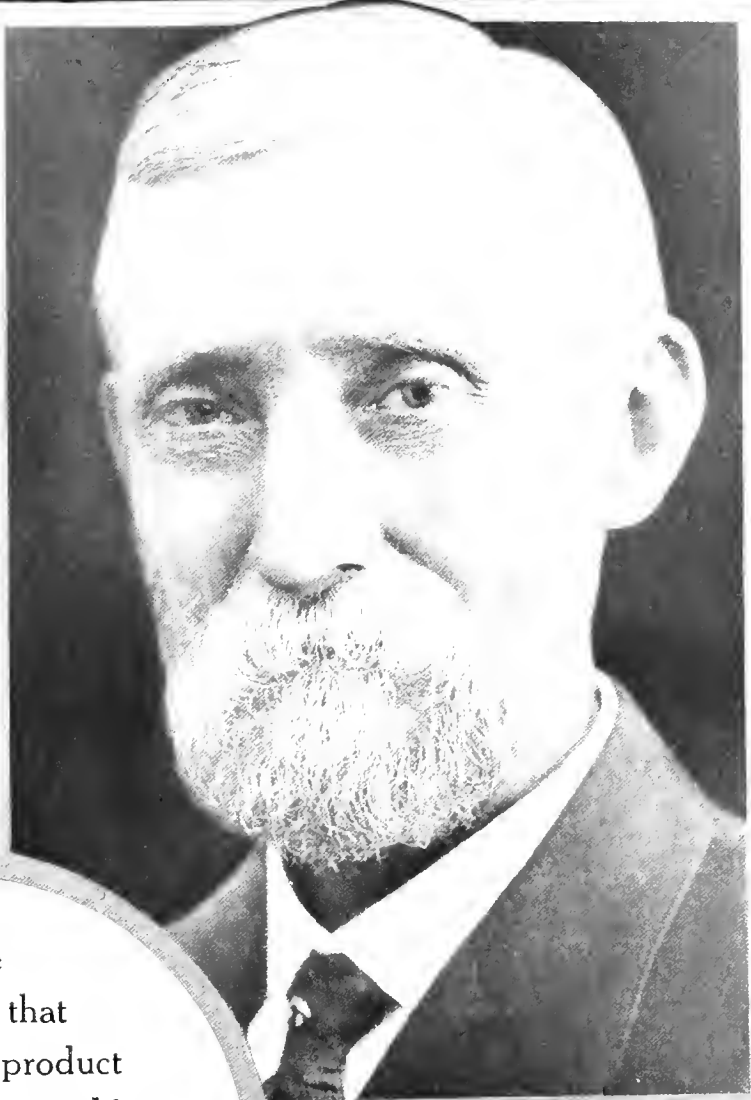

We are determined that every Louden product will go out in working order; that it will work easily; that it will work safely; that it will fulfill every claim made for it and more.

During its entire history—nearly fifty years—this company has held to this determination, and this determination is the foundation of its success.



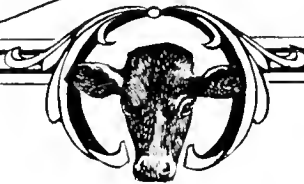

LOUDEN HAY TOOLS

	PAGE
Hay Carriers (Fork)	8-13
Hay Carriers (Sling)	14-24
Round Barn Equipment	25-27
Cable Ricker	28-29
Track and Track Fittings	30-32
Power Hoist.....	33-35
Balance Grapple Forks	38-39
Harpoon Forks ..	40
Slings and Sling Fittings	41-48
Pulleys.....	49-51
Specialties	52-56

CHOOSING HAY UNLOADING TOOLS

While a majority of our friends who receive this catalog are posted on the subject of Hay Unloading Tools, we believe that a few words, outlining in a general way the different points to be considered in choosing an outfit, will be of interest to many.

Kinds of Barns

Barns may be divided into four classes:

1. **The Single End Hoist Barn.** In this type of barn the hay is taken into the mow at one end of the barn.
2. **The Double End Hoist Barn.** Hay may be taken into this type of barn from either end of the building.
3. **The Center Drive Barn.** This type has a driveway running through the center; hay is lifted up to the necessary height and carried into the left or right mow as desired.
4. **The Round Barn.** This type of barn requires special equipment. (See pages 25 to 27.)

Forks or Slings?

After classifying your barn, the next point to consider is whether you want to use a Fork or Slings to remove the hay from the wagon. This must be very largely a matter of individual choice, and a careful reading of the descriptions of Forks, pages 38 to 40 and of Slings, pages 41 to 44, will help in the solution. Either Forks or Slings can be used in any type of barn.

The Carrier For You

A Hay Carrier is classified either as a Fork Carrier or Sling Carrier. A Fork Carrier can, by using our Self-Locking Sling Pulleys (see page 46) be used with Slings and a Sling Carrier can handle Forks, if a Fork Clevis (see page 45) is attached.

We recommend, that, insofar as possible, a choice be made between Forks and Slings before choosing a Carrier.

The following short descriptions give an idea of the different carriers:
Junior Fork Carrier

There are more Louden Junior Fork Carriers in use than any other carrier made. They meet all conditions and requirements for a fork carrier. They can be used in either center-drive or end-hoist barn. They can be depended upon to do their work at all times and under all reasonable conditions. (See page 8.)

Senior Fork Carrier

This is the strongest Fork Carrier made and is easy to operate. It can be used in Center Drive or End Hoist barns and is specially recommended where heavy loads are to be handled. (See page 10.)

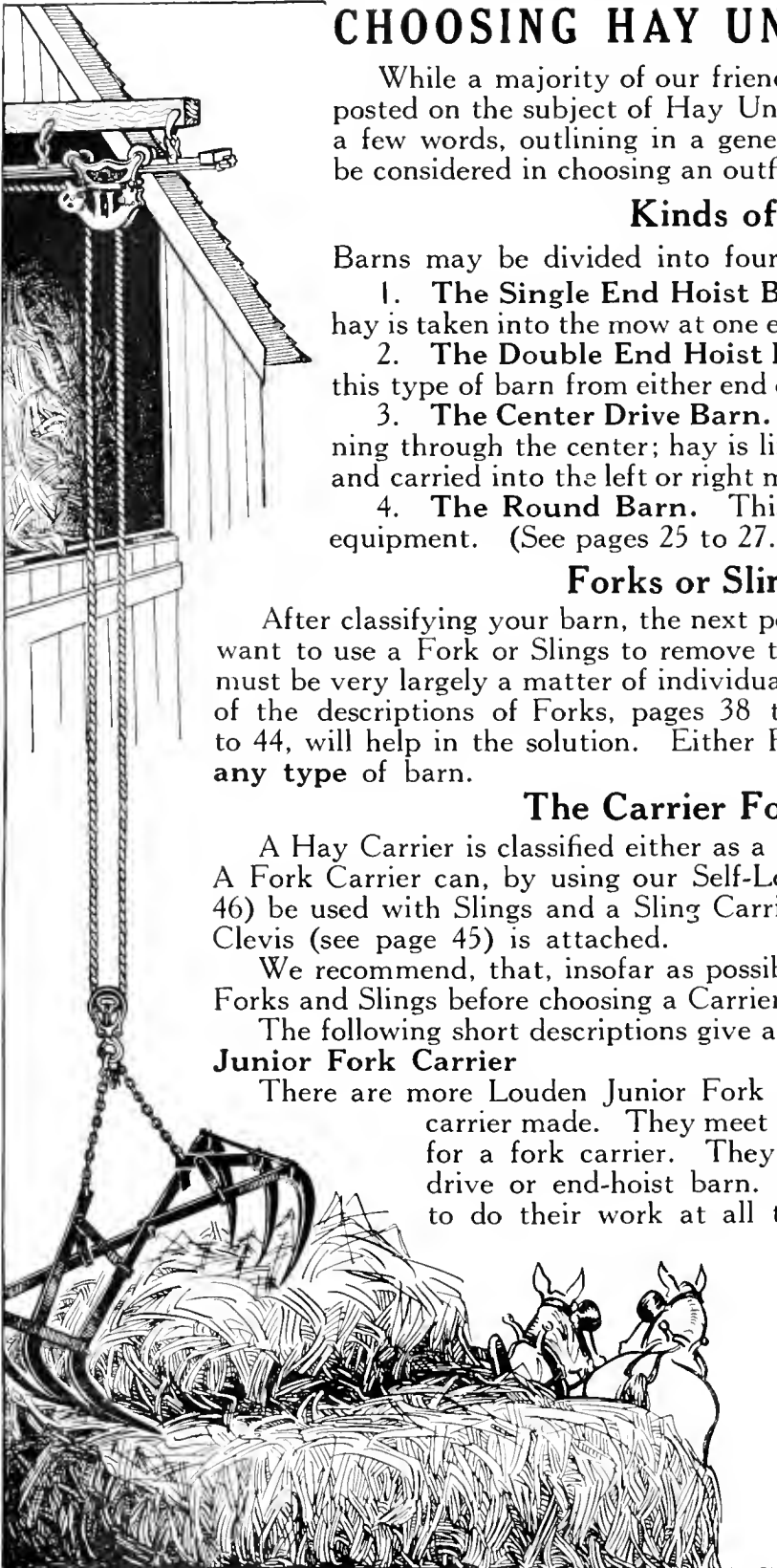

Carry-All Sling Carrier

This Carrier is the heaviest, strongest and easiest working Sling Carrier manufactured. It is adapted for use in any style barn. For a large barn where there are large loads of hay to be mowed the Carry-All will handle half-ton loads safely, and will not cut or break the fibre of the rope, and will give satisfaction under all reasonable conditions. (See page 14.)

Iowa Sling Carrier

The Iowa Sling carrier is adapted for use in any style barn. It is not so heavily built as the Carry-All, but for all general work it gives entire satisfaction. (See page 18.)

Cross Draft Carrier

This carrier can be used in any type of barn but is recommended for barns where hay is taken up in the center. The carrier works on a new principle—the horse walks away from the barn to elevate the load and turns back toward the barn to pull the load back into the mow. This saves one half the travel of the horse. (See page 22.)

Round Barn Outfit

The special Round Barn Carrier operated with a Louden Triple Drum Power Hoist makes the most satisfactory outfit for unloading and mowing hay in a round barn. (See page 25.)

Carriers for Wood Track

Louden Junior Fork Carrier is recommended for use with forks. (See page 13.) Reversible Sling Carrier is recommended for use with slings. (See page 21.)

Louden Specialties

Louden Barn Door Hangers. Our line of barn door hangers is well known, and our leading hanger, the Bird-Proof, is the most popular made. (Page 60.)

Louden's Cable Ricker (pages 28-29) is an economical and satisfactory method of stacking hay in the field.

A Louden Power Hoist (pages 33-35) will save money during the haying season if there is a gasoline engine or other power on the farm, and will be of great service whenever a "powerful lift" is needed.

Louden's Hoisting Singletree is a great convenience wherever a horse is used for hoisting. (See page 53.)

Louden Hay Rack Clamps enable any farmer to build a strong, serviceable hay rack with little expense. (See page 54.)

Louden Combination Rack Irons are useful when an all-purpose rack is desired, as it is easily changed for hay, wood, or hogs. (See page 55.)

Louden Offset Hinge is the best solution for the gable-end mow door. (See page 53.)

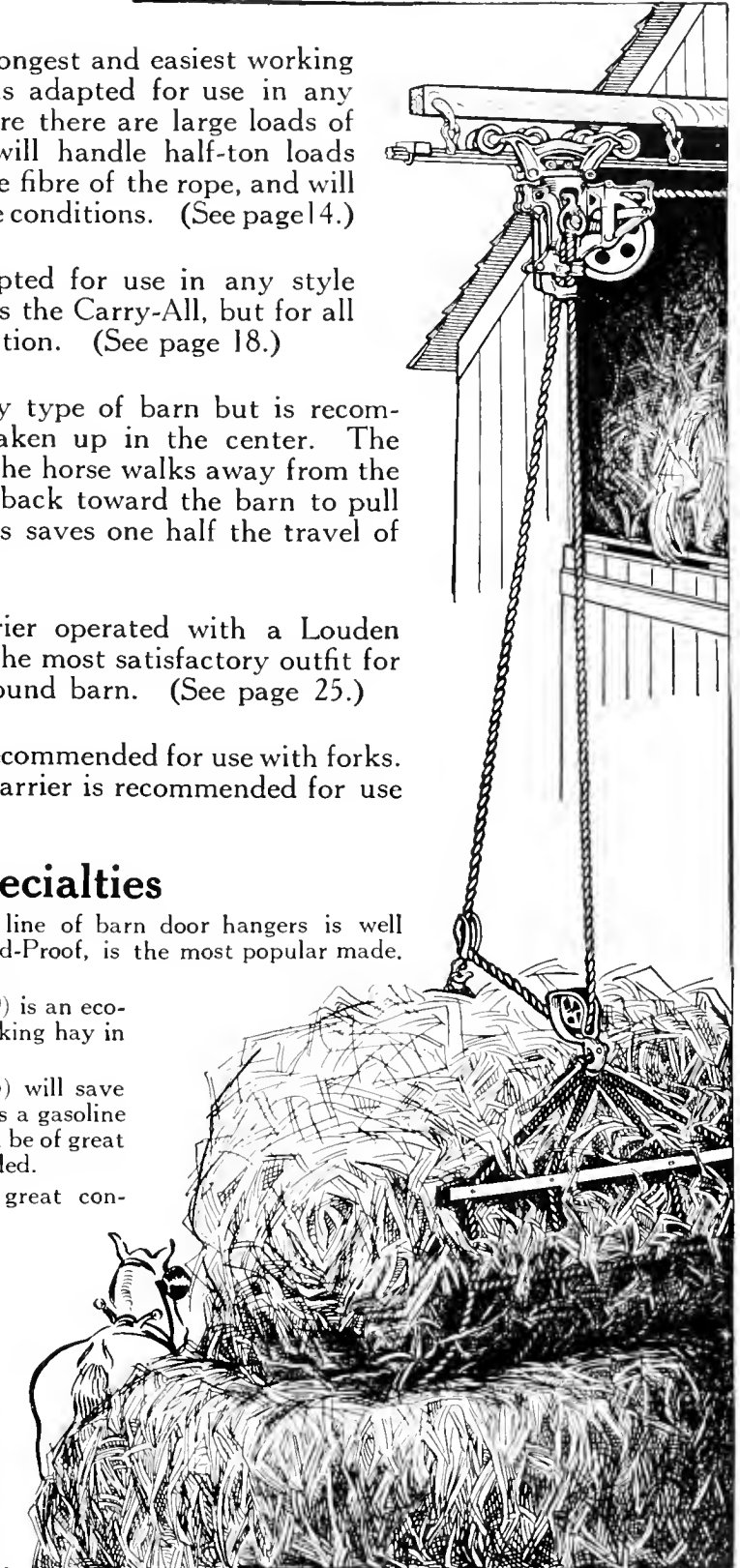

Louden Junior Hay Fork Carrier—Fig. 430

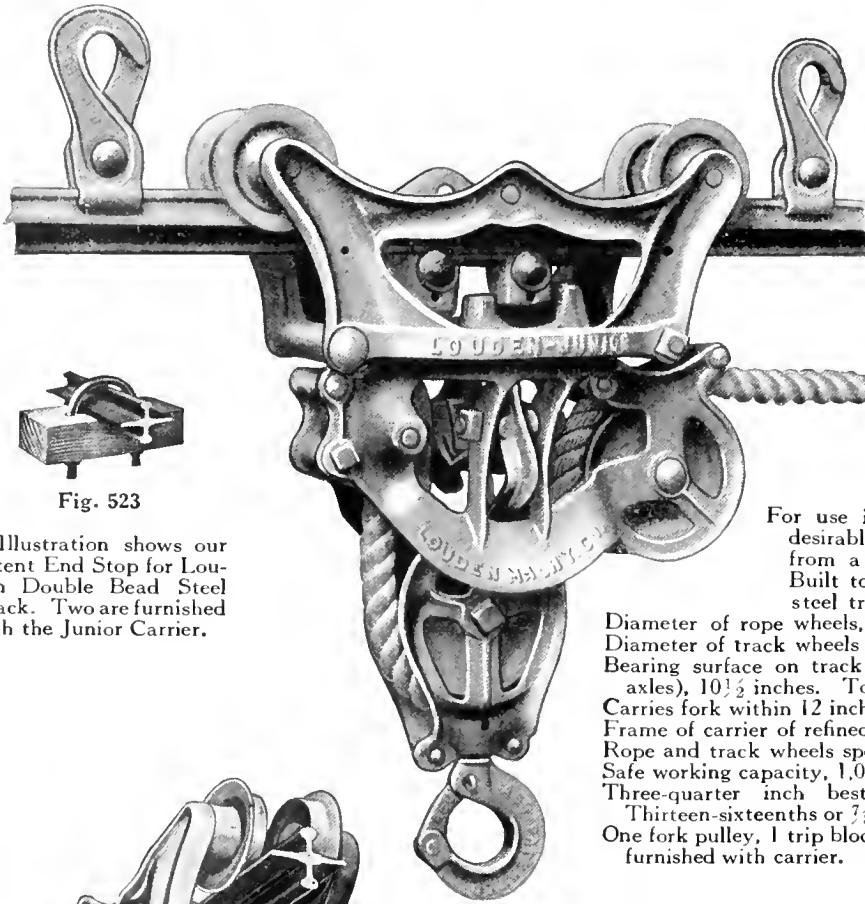

Fig. 1123

Trip Block Furnished as Part of Carrier



Fig. 523

Illustration shows our patent End Stop for Louden Double Bead Steel Track. Two are furnished with the Junior Carrier.

Specifications

For use in any style of barn. Especially desirable in barns where hay is unloaded from a center driveway or at both ends. Built to operate on Louden Double Bead steel track.

- Diameter of rope wheels, 4 inches.
- Diameter of track wheels on tread, $2\frac{1}{4}$ inches.
- Bearing surface on track (distance between front and rear axles), $10\frac{1}{2}$ inches. Total length of carrier, 13 inches.
- Carries fork within 12 inches of track.
- Frame of carrier of refined malleable iron.
- Rope and track wheels special quality gray iron.
- Safe working capacity, 1,000 pounds.
- Three-quarter inch best manilla rope is recommended.
- Thirteen-sixteenths or $\frac{7}{8}$ inch rope can be used.
- One fork pulley, 1 trip block, 2 end stop blocks, 1 rope swivel furnished with carrier. Weight, 25 pounds.

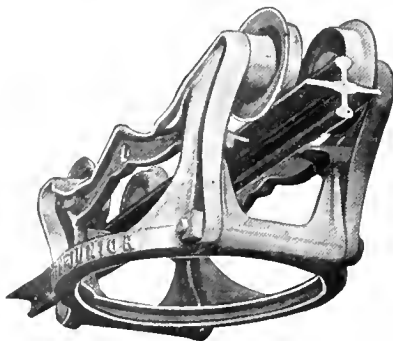

Fig. 7

Fig. 7 is an end view of the upper frame of all the Louden Swivel Carriers, showing the great strength. The sides carrying the wheels are joined together by two end pieces. These end pieces have upwardly extending arms (as seen in cut), which are secured to the sides above while a bolt holds them together at the bottom, thus making the strongest possible frame, and at the same time saving space, as all the space taken up below the track is the thickness of the end pieces. This is a distinctive Louden feature.

The wheel arms are thoroughly braced and will never spread with a heavy load and let the carrier off the track.

The Louden Junior is the most popular and the biggest selling hay fork carrier. Its construction is simple and compact. More of these carriers are in use in the barns of the country than any other hay carrier made. For twenty years it has been standard and doing its work safely and surely on thousands of farms.

This carrier is suitable for use in any style of barn. Where hay is taken up at the end of building it works easily and smoothly as a one-way carrier. It is a "Louden swivel" carrier and where hay is unloaded from a center driveway it is quickly reversed. The pulley through which draft rope works in the end of the barn is changed from one end to the other. The carrier can then be swiveled around by giving a swinging pull on the draft rope. No climbing up to the carrier necessary. In long barns where hay is unloaded at both ends the carrier can be changed from one end to the other without changing a rope or pulley.

The carrier has the wide flaring mouth and the round topped fork pulley that have made all Louden Carriers popular with hay growers. The fork pulley never fails to enter the carrier at the proper time. It is not necessary that the wagon should be directly under the carrier. The wide flaring mouth receives the round fork pulley no matter from what angle the fork is drawn and regardless of swinging load or twisting ropes. No failure, no backing up of the team to make the second trial.

Louden Junior Hay Fork Carrier—Continued



Cut A
The end of the rope is fastened in the Carrier with our patent swivel iron knot, as shown in A. The rope is placed through the tilting eye, S (Fig. C 430), and the iron knot resting loosely thereon makes a complete, durable and simple swivel, which lets all kink and twist out of the rope.



Fig. C, 430
Showing the wide flaring mouth.

The end of the rope is fastened in the carrier with our patent swivel iron knot. (See S in Fig. C 430.) The rope is placed through the tilting eye S and the iron knot, resting loosely on the eye, makes a complete, durable and simple swivel. This swivel allows all twists and kinks of the rope to escape. Many times when a new rope is first put in a carrier it will twist and kink so badly as to cause delays and annoyance. Sometimes it is necessary to take the rope out and turn it end for end. The swivel iron knot with the Loudon Junior Carrier does away with all that trouble.

The rope wheels in the carrier and in the fork pulley are 4 inches in diameter and are heavy and strong. The wheels revolve on heavy malleable iron bushings recessed into the main frame. The short, heavy bushings sustain the weight of the load while the bolt passing through holds the frame of the carrier together. The wheels are perfectly formed and so smooth that the wear on the rope is reduced to a minimum.

The hook in the fork pulley which carries the fork is attached to the pulley by a strong swivel connection. Even should the load of hay turn around while being raised the ropes will not twist. This swivel hook in the fork pulley makes it practical to set the fork in the hay at any angle desired.

The grappling hooks in the carrier take a deep grip in the frame of the fork pulley. They grip the pulley securely, at the same time permitting the pulley to swing freely. This is of immense advantage as it permits filling the mow up to the track with no risk of breaking the carrier or the pulley. This also makes it practical to take a large forkful through a small door or over high beams.

The wheel arms are short and thick, reinforced by wide ribs. The wheels are equally strong; they are $2\frac{1}{4}$ inches in diameter on tread. The web is directly under the tread where the support is most needed. The track wheels operate on large, heavy axles, three-fourths of an inch in diameter, flared at the shoulders to give additional strength and prevent the wheels from binding on the frame. The track wheels and axles are milled true, insuring little wear. On special orders this carrier can be equipped with eight wheels and oscillating engine trucks, same as shown with Iowa Sling Carrier, Fig. 821, page 18. A small charge will be made for this change.

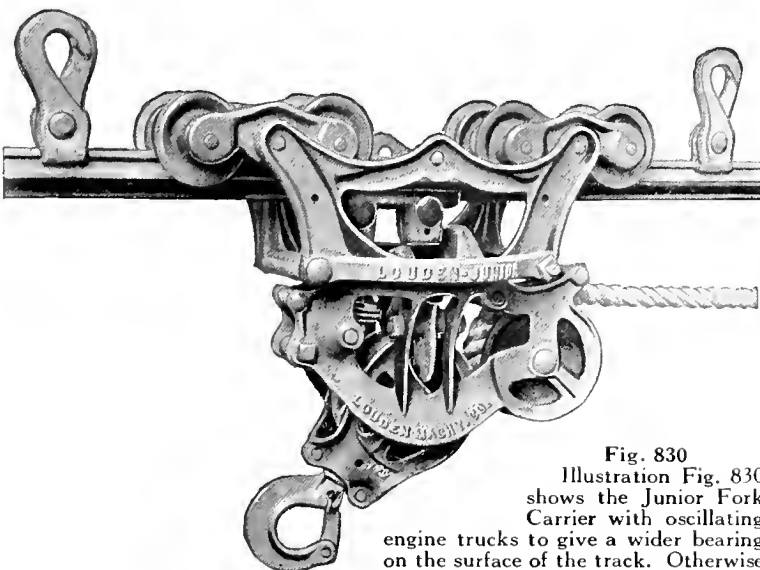

shown on opposite page. In illustration the fork pulley is swung back as it would be when pulling hay into a well filled mow.

Fig. 830
Illustration Fig. 830 shows the Junior Fork Carrier with oscillating engine trucks to give a wider bearing on the surface of the track. Otherwise this carrier is the same as Fig. 430

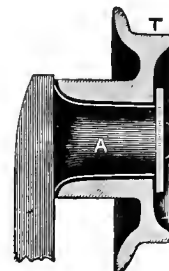

Cut W

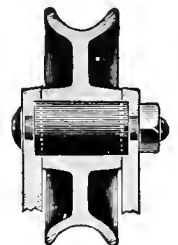

Cut B

Cut W represents Loudon's improved Track Wheel, having the web of the wheel directly under the tread T, which makes it strong and durable. It also shows the wheel axles, which are of solid malleable iron (more durable than steel) rounded out where it joins the carrier frame, so as to give it the greatest possible strength.

Cut B shows how the large rope wheels are protected by shields which makes it easy on the rope. The bearings are chilled and run on large malleable bushings recessed into the sides and bolted through. This feature is patented.

Louden Senior Hay Fork Carrier—Fig. 1100

Specifications

For use in any type or size of barn.

Built regularly to operate on Loudon Double Bead Steel Track. (See pages 30 and 31 for Track and Track Fittings.)

Furnished regular with Rope Wheel for manilla rope.

Furnished on special order with Rope Wheel for wire draft rope.

Diameter of Rope Wheel in carrier and Fork pulley, 7 inches.

Rope Wheels are roller bearing.

Diameter of Track Wheels on treads 3 inches.

Track wheels are not roller bearing.

Bearing surface on track (distance between front and rear axles), 15 inches.

Total length of carrier, 21 inches.

Carries fork within 20 inches of the track.

Frame of carrier of refined malleable iron.

Rope and Track Wheels special quality gray iron

Safe working capacity, 1,500 pounds.

$\frac{3}{4}$ -inch best manilla rope is recommended.

Any size rope from $\frac{3}{4}$ -inch to 1 inch may be used.

One fork Pulley, 1 Trip Block, and two End Stop Blocks are furnished with the carrier.

Weight, 34 pounds.

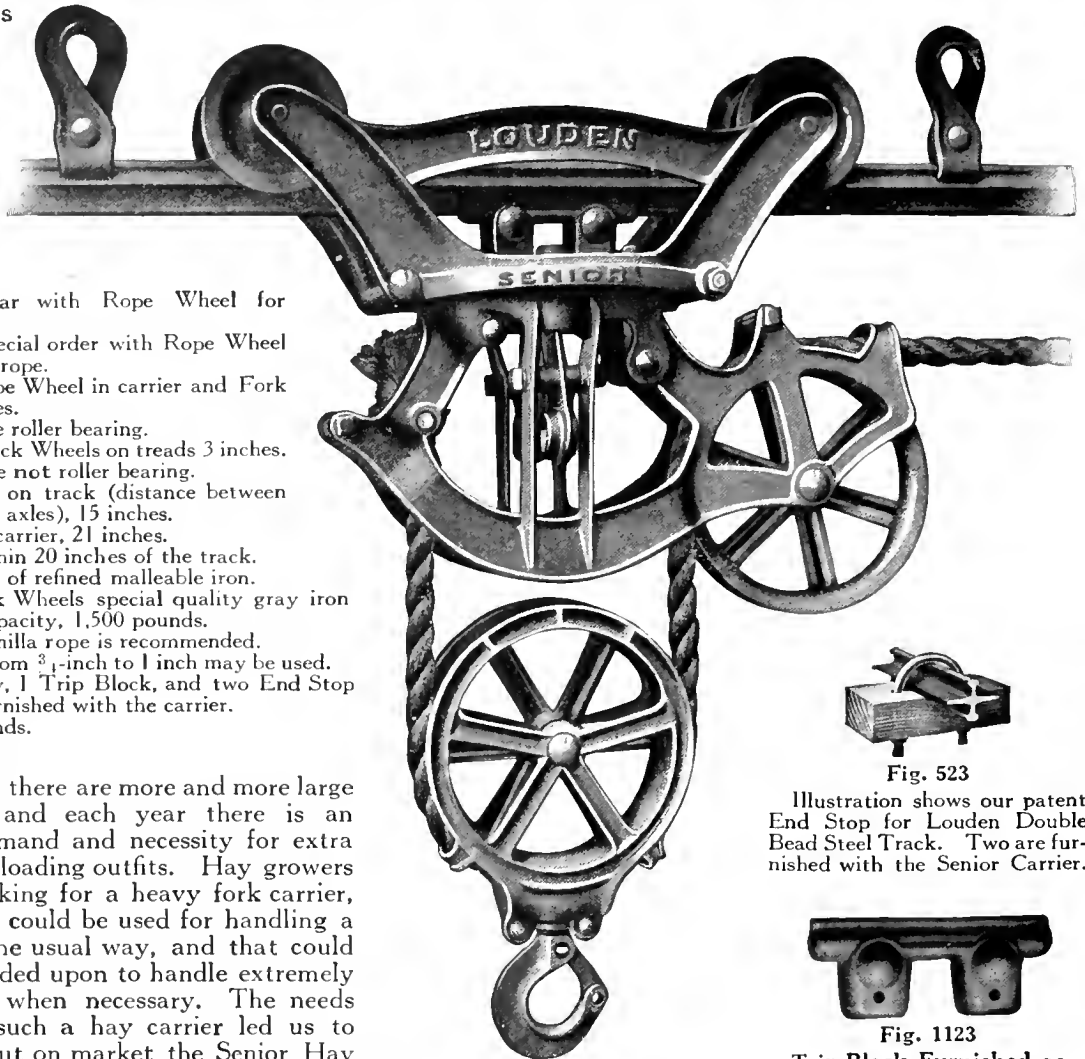

Fig. 1100

Fig. 523

Illustration shows our patent End Stop for Loudon Double Bead Steel Track. Two are furnished with the Senior Carrier.

Fig. 1123

Trip Block Furnished as Part of Carrier

Each year there are more and more large barns built, and each year there is an increasing demand and necessity for extra heavy hay-unloading outfits. Hay growers have been asking for a heavy fork carrier, a carrier that could be used for handling a hay fork in the usual way, and that could also be depended upon to handle extremely heavy loads when necessary. The needs and call for such a hay carrier led us to design and put on market the Senior Hay Fork Carrier.

This Carrier throughout is built strong and sturdy and in addition, its mechanism is simple and sure. It has the wide flaring mouth and the round-topped fork pulley that has been a distinctive feature of Loudon Carriers for years. The fork pulley will never fail to register from whatever angle it may be drawn, and the grappling hooks take a deep, sure grip on the pulley.

The Loudon Senior is a "Louden swivel" frame carrier and is equally efficient whether hay is taken up from the end of the barn or from a center driveway. When used in a barn having a center drive, when one end of the barn is filled the pulley at the end of the barn, through which the draft rope passes, is carried over and hung in place at the other end. When this is done a swinging jerk on the draft rope from the wagon or ground will reverse the carrier and it will be ready to work in the other end.

The Loudon Senior has been tested in our factory under loads weighing 2,300 pounds. Operated vigorously under this load, the carrier showed no signs of weakness. We guarantee that it will handle a load weighing 1,500 lbs. continuously and with safety.

The bearing surface on the track—the distance from center to center between front and rear track wheels—is 15 inches. This wide bearing distributes the load along a greater surface, making it possible for the track to carry large loads without strain.

The Rope Wheels of the Senior carrier are roller bearing. This large wheel (7 inches in diameter), together with the roller bearing, 7-inch fork pulley, reduces friction to a minimum, and makes the hoisting of the load from wagon much easier than with an ordinary carrier.

Louden Senior Hay Fork Carrier—Continued

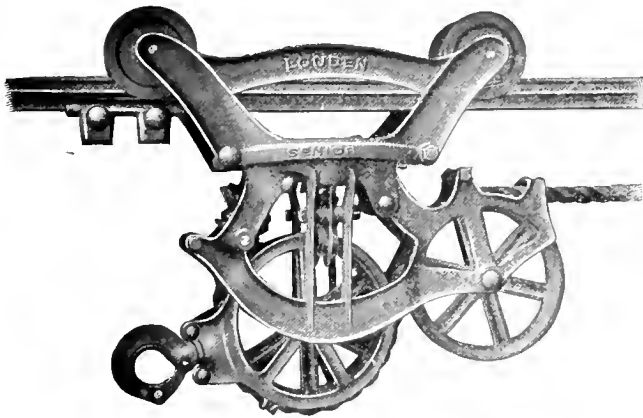

Showing Swinging Fork Pulley
Loads can be dragged over beams or other obstructions
without endangering carrier.

from any angle, not having to stand directly under the carrier, and the Fork Pulley will always register true. This feature, together with our patented rope swivel, which lets the kinks and twists run out of the rope while forkful is being hoisted, saves a world of time that is worth many dollars in haytime.

The rope swivel on this carrier is built into the carrier and is a big improvement over any rope swivel before offered. You simply pass the end of the rope through the swivel and tie a knot in the rope.

With a good, solid knot in the end of the rope, everything is sure to hold, and the swivel works free, permitting the twist to run out of the rope.

The Locking Dog has a new, distinctive feature, in that it is pivoted by means of a bolt. The Locking Dog may be easily taken out of the carrier without disturbing any of the other parts.

The Rope Wheel in the Fork pulley is 7 inches in diameter. The outer pulley casing is extra strong as it has four ribbed spokes and the outer circumference has two heavy ribs running parallel with each other. These, together with the cross ribs, make an exceedingly strong frame.

The carrier is built for use with any size of rope $\frac{3}{4}$ -inch to 1 inch. We recommend a $\frac{3}{4}$ -inch manilla rope as it is easier to handle, and costs less than a larger rope. Some users prefer, $\frac{1}{2}$, $\frac{7}{8}$, $\frac{1}{2}$, or 1 inch rope, and where a large rope is preferred the new carrier handles it perfectly.

Fig. 7 is an end view of the upper frame of all the Louden Swivel Carriers, showing the great strength. The sides carrying the wheels are joined together by two end pieces A. These end pieces have upwardly extending arms (as seen in cut), which are secured to the sides above while a bolt holds them together at the bottom, thus making the strongest possible frame, and at the same time saving space, as all the space taken up below the track is the thickness of the end pieces A.

The wheel arms are thoroughly braced and will never spread with a heavy load and let the carrier off the track.

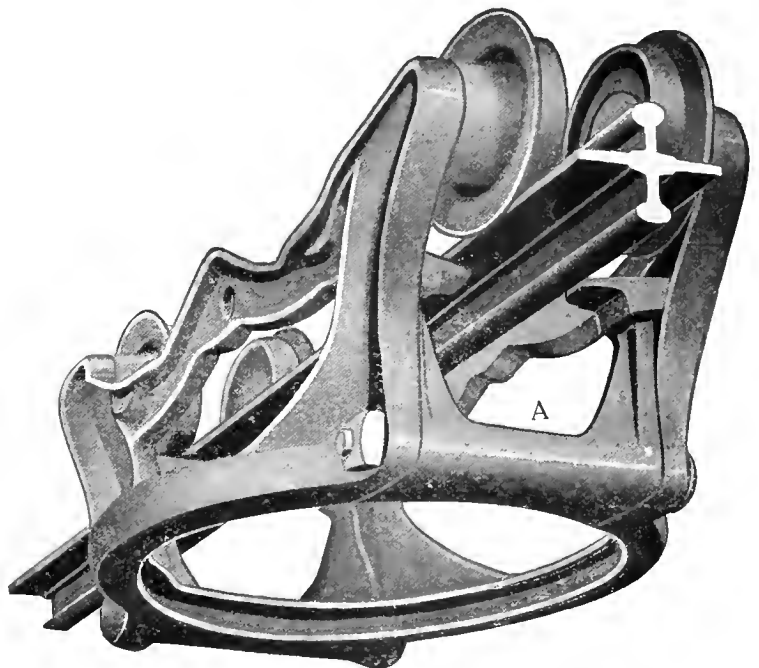

Fig. 7

The Track Wheels are 3 inches in diameter on tread, are heavy and of great strength. They are not roller bearing, as it takes very little power to pull the carrier along the track compared with the power necessary to hoist the load. Too great an ease of propulsion would be a disadvantage through the tendency of the carrier to "run away" when leaving the trip block.

With the Louden Senior Track Carrier the barn can be filled clear to the track. There is no danger of breaking any part of the carrier, as the load can swing back directly behind carrier when necessary. This feature of the Swinging Fork Pulley also makes it easy to pull large forkfuls through small doors and over high beams without danger of breakage.

The round top of the Fork Pulley and the wide flaring mouth of the carrier is a big advantage in busy haytime. The wagon can be unloaded



Louden Power Hoist and Carry-all Sling on an Iowa Farm. Louden Hay Tools save dollars in busy hay time



The use of Louden Hay Tools is world wide. This is the Ryneke Farm, Jönghybed, Sweden. This sling load weighs 1,700 lbs.

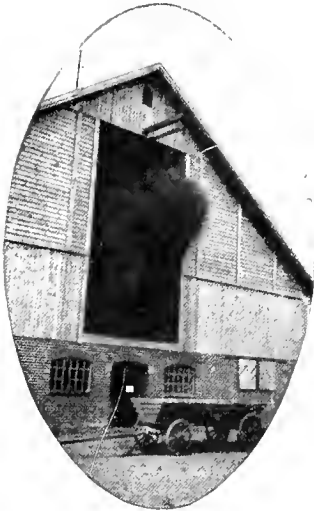

A big sling load going into a barn in Germany. Louden Hay Tools are used all over the world.

Waukesha, Wisconsin,
Aug. 11, 1914.

Louden Machinery Company,
Gentlemen:

We harvested 150 acres of alfalfa in 1913 and 1914, and are the largest alfalfa growers in Wisconsin. Our engine hoist, slings, horse forks, tracks, cars, and pulleys are all Louden hay tools. Goods of other makes were replaced by Louden make, because we found Louden goods to be more durable and convenient.

Durability of haying machinery means so much to us as we have so much hay to handle. Good reliable machinery is very important because one has extra help around, the weather is warm, and hay should be handled quickly and easily, and tools should be made to be handled by men conveniently, thus saving time, labor, expense, and worry in taking care of the hay crop when it is ready for mowing or stacking. No one can afford to spend the time for repairs or repairing poorly constructed or faulty in operation hay tools.

Yours very truly,

SWARTZ BROS.,

Per P. C. S.



Louden Grapple Fork lifting a big load of hay. Louden Forks meet every requirement



Louden Cable Rickers, Carriers and Grapple Forks are friends of the farmer when big, solid, water shedding stacks are desired.



The Cornfalla farms have Louden Hay Tools exclusively. Read the opinions expressed in a letter above and write for catalogs.

Louden Junior Hay Fork Carrier for Wood Track

Fig. 441

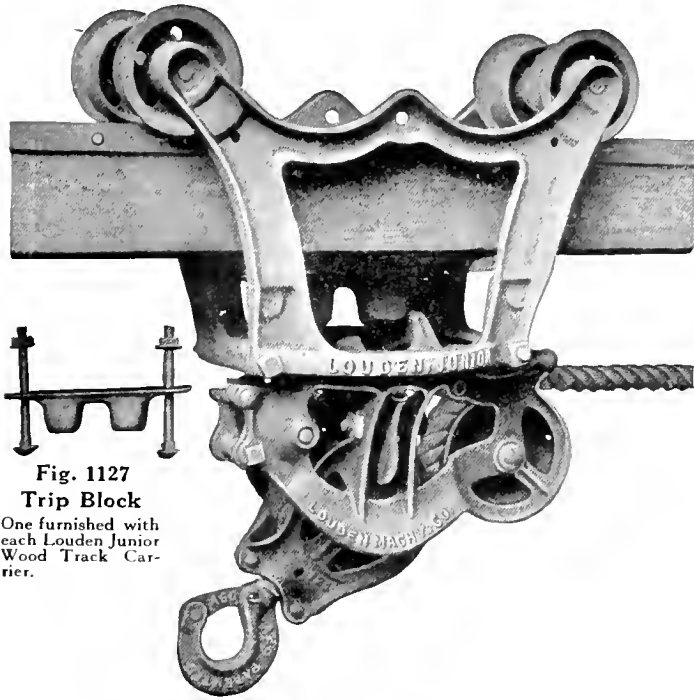

Fig. 1127
Trip Block
One furnished with
each Loudon Junior
Wood Track Car-
rier.

Fig. 441 (Capital)

Specifications

Operates on 4x4 wood track.
For use in any style of barn.
Diameter of Rope Wheels 4 inches.
Diameter of Track Wheels $3\frac{1}{4}$ inches.
Bearing surface on track (distance between front and rear axles)
 $12\frac{3}{4}$ inches.
Total length of carrier 16 inches.
Carries fork within $13\frac{1}{2}$ inches of the track.
Frame of carrier of refined malleable iron.
Rope and Track Wheels special quality gray iron.
Safe working capacity, 1,000 pounds.
Three-fourths inch rope, best manilla is recommended.
 $\frac{1}{8}$ or $\frac{7}{8}$ inch rope can be used.
One Fork Pulley, 1 Trip Block, 1 Rope Swivel furnished with Carrier.
Weight, 28 pounds.

In the past 4x4 Wood Tracks for hay carriers were installed in a considerable number of barns. This was when wood was cheap and steel high in price. At the present time a wood hay track is rarely placed in a building. The steel tracks are as cheap as wood, they occupy less room and hay carriers work so much easier and smoother on the steel that it is a mistake to put wood track in a building.

Where track is already in the building or where for some special reason it is desired to use a Wood Track, no better carrier can be put into service than the Loudon Junior Wood Track Carrier.

This carrier is built exactly like the Loudon Junior Fork Carrier for steel track (Fig. 430, page 8), except it is built to operate on a 4x4 wood track instead of on steel track.

The carrier is suitable for use in any style of barn. Where hay is taken up at the end of building it works easily and smoothly as a One-Way Carrier. It is a Swivel Frame Carrier and in barns having a center driveway it is easily and quickly reversed to work on either side.

The carrier has the wide flaring mouth and the round top fork pulley of all Loudon carriers. The fork pulley never fails to enter the carrier at the proper time. The wide flaring mouth of the carrier receives the pulley no matter from what angle the fork is drawn and regardless of swinging load or twisting ropes.

The grappling hooks in the carrier take a deep grip in the frame of the fork pulley. They grip the pulley securely, at the same time permitting the pulley to swing freely. This permits the mow to be filled clear up to the track without danger of breaking the pulley.

The frame of the carrier is of refined malleable iron built sturdy and strong to handle heavy loads. The members are clamped securely together with bolts; there is no possibility of the frame spreading or breaking under the strain of heavy loads.

Louden Carry-All Sling Carrier Fig. 1103

Specifications

The heaviest and strongest Hay Sling Carrier made For use in any type or size of barn.

Built to operate on Louden Double Bead Steel Track.

Diameter of Rope Wheel in carrier, 10 inches.

Diameter of Rope Wheel in sling pulleys, 4 inches

Rope Wheel in carrier is roller bearing.

Diameter of Track Wheels on tread, 3 inches.

Track wheels are not roller bearing.

Bearing surface on track (distance between front and rear axles), 19 $\frac{1}{2}$ inches.

Total length of carrier, 22 $\frac{1}{2}$ inches.

Carries slings within 26 inches of the track.

Frame of carrier of refined malleable iron.

Rope and track wheels special quality gray iron.

Safe working capacity, 2,500 pounds.

Seven-eighths inch best manilla rope is recommended

Three-quarter inch rope may be used.

Two Sling Pulleys, 1 Trip Block, 2 End Stop Elocks furnished with each carrier.

Weight, 77 pounds.

(See pages 30 and 31 for Track and Track Fittings.)

The Carry-All Hay Sling Carrier, as its name implies, was built to carry big loads of all kinds of hay. The importance of the hay crop and its increasing value from year to year is resulting in a larger acreage and more tons of hay in all the hay-growing regions. The necessity of being prepared to handle the hay with speed and safety when the weather is right and the hay is right has developed the need for heavier equipment.

In many of the heavy hay-growing sections farmers are building larger barns and with roof construction strong enough to permit an entire wagon load of hay to be handled at a single lift. With a desire to furnish a carrier that would do this work in the big hay barns and at the same time be suitable for use in the ordinary farm barn we designed the Carry-All Sling Carrier.

This carrier has been tested under loads weighing 3,200 pounds. It has been tried with horse power, engine power, and electric power. It has been tried out in barns of all sizes and under all kinds of conditions. It is already making good in hundreds of barns and in every test the carrier proved its efficiency, its strength, and its perfect working mechanism.

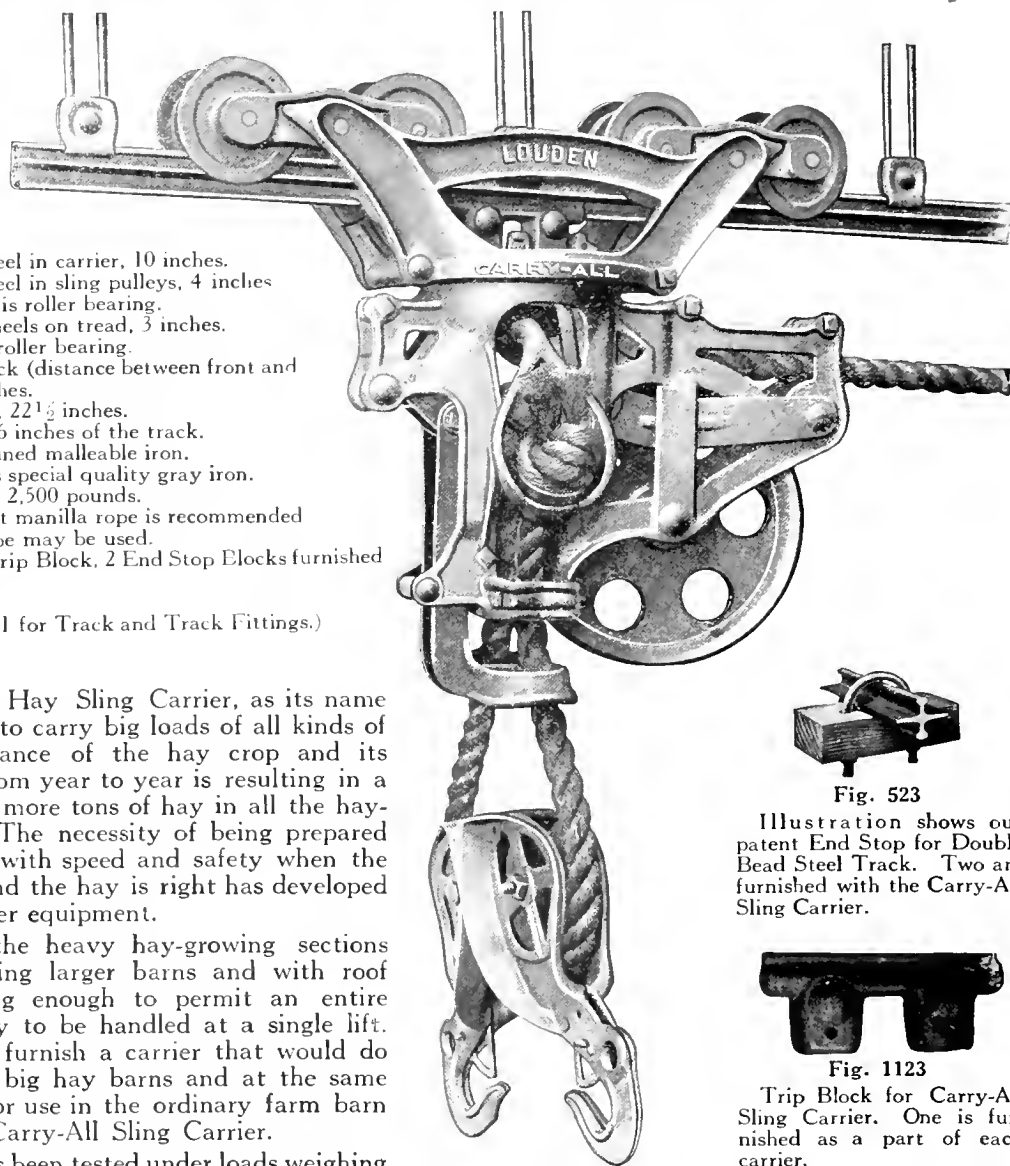

Fig. 1103 (Heavy)
Patent Pending

Fig. 523

Illustration shows our patent End Stop for Double Bead Steel Track. Two are furnished with the Carry-All Sling Carrier.

Fig. 1123

Trip Block for Carry-All Sling Carrier. One is furnished as a part of each carrier.

Non-Wear Rope Lock

The Rope Lock in this carrier is positive and sure. There is no chance for the rope to slip. The lock will not wear the rope as it grips it evenly. The Rope Lock castings have a bearing of 9 inches on the rope. They conform to the diameter of the Rope Wheel and when the Rope Lock goes into action engaging the rope for a distance of 9 inches and bending it around the outside of the Rope Wheel the rope cannot slip. Handling a dead weight (steel pipe) of 3,200 pounds the rope did not slip the fraction of an inch.

The end of the draft rope is knotted into the cup-shaped rope swivel which rests in the fulcrum lever. The fulcrum lever exerts a direct pressure on the rope lock. When carrying a load the weight of the load is held on top of the rope lock. The heavier the load the more securely does the lock hold.

William Louden, Pioneer Hay Tool Inventor and Manufacturer, Is Popularly Known as "The Man Who Made High Barns Possible." Imagine, if You Can, Filling These Mows with Pitchforks.

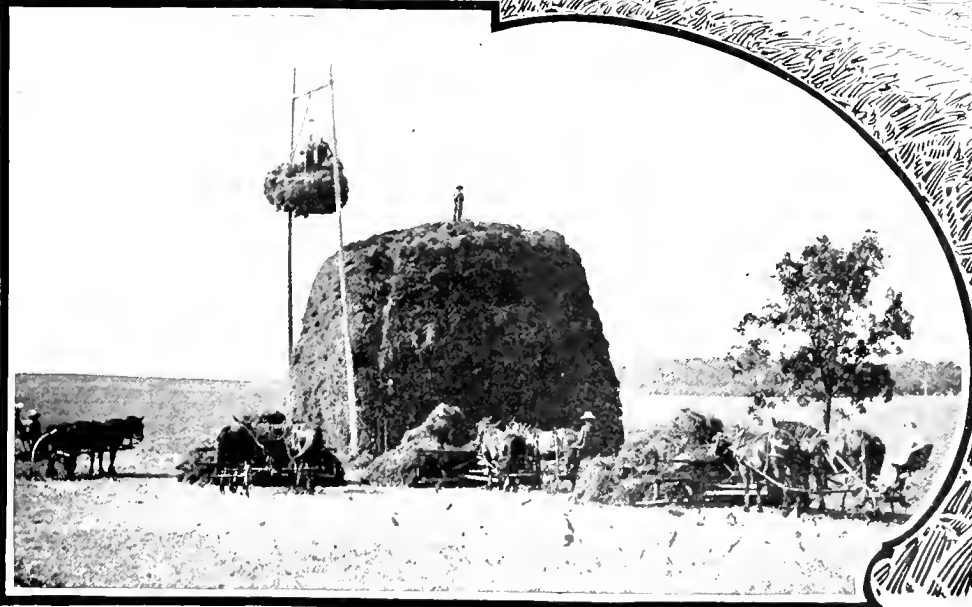
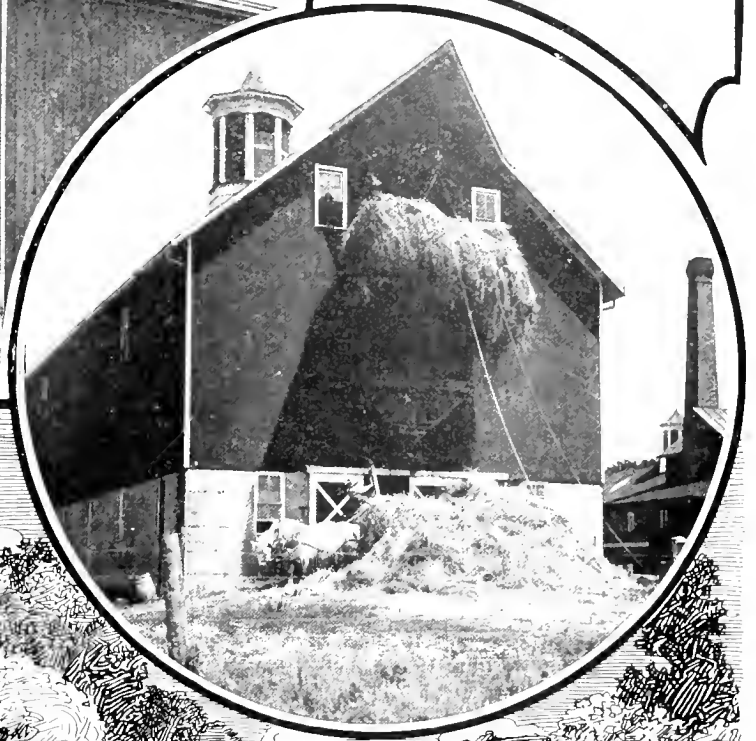
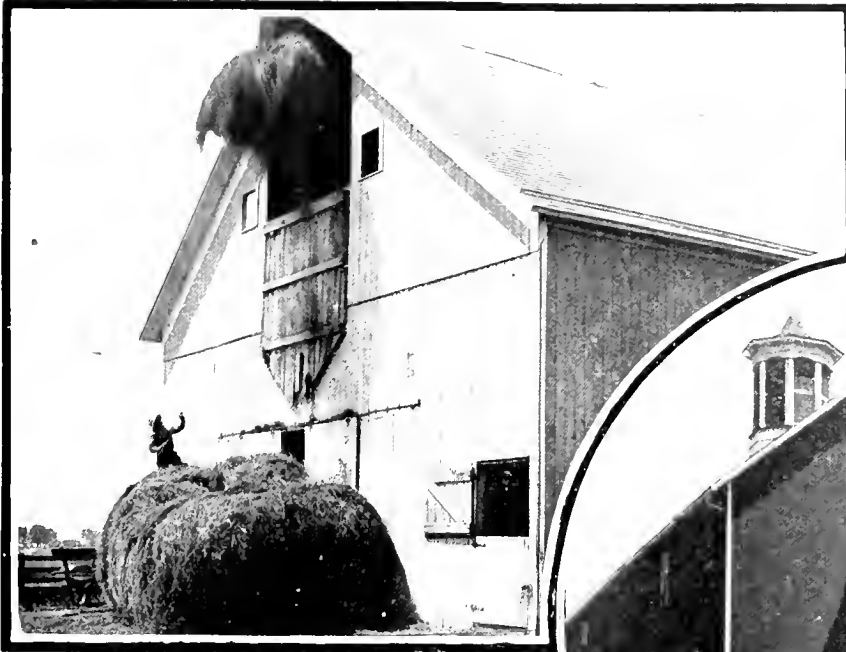

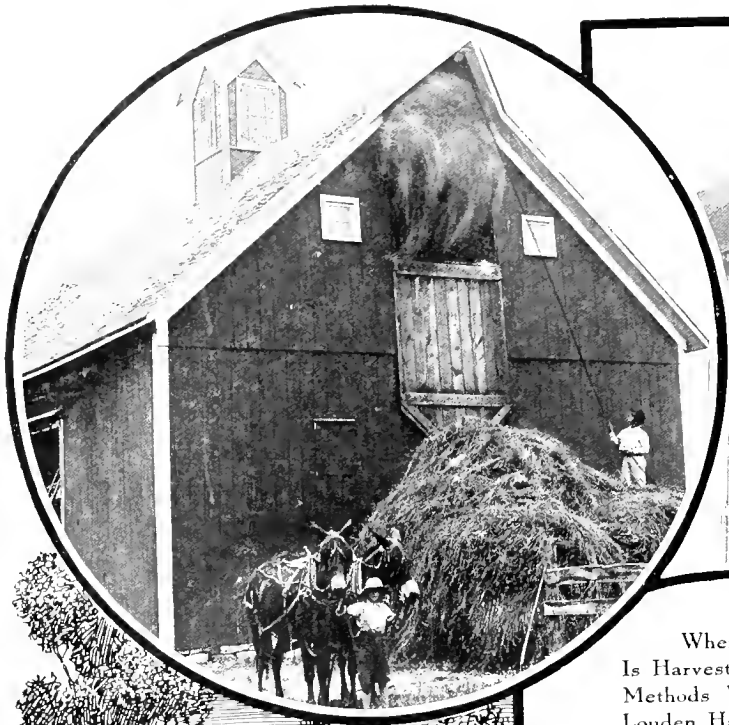

Wherever Hay
Is Harvested By Modern
Methods You Will Find
Louden Hay Tools.

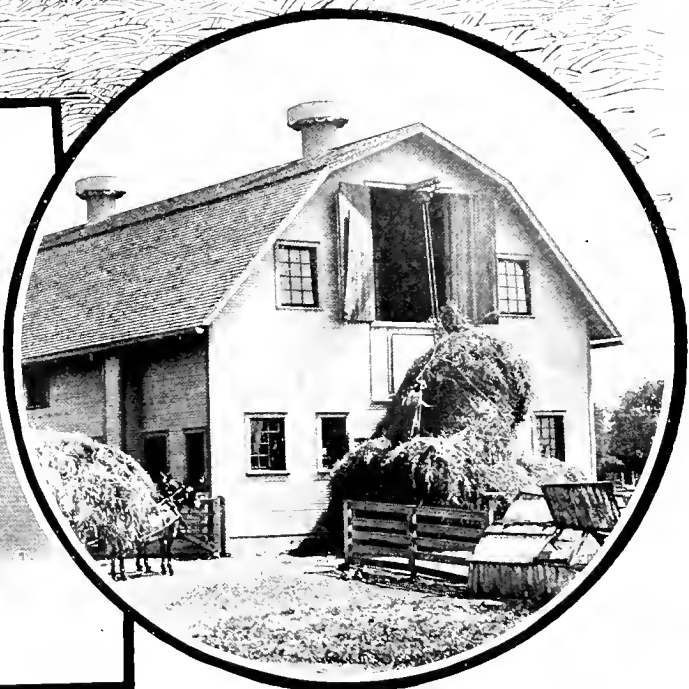
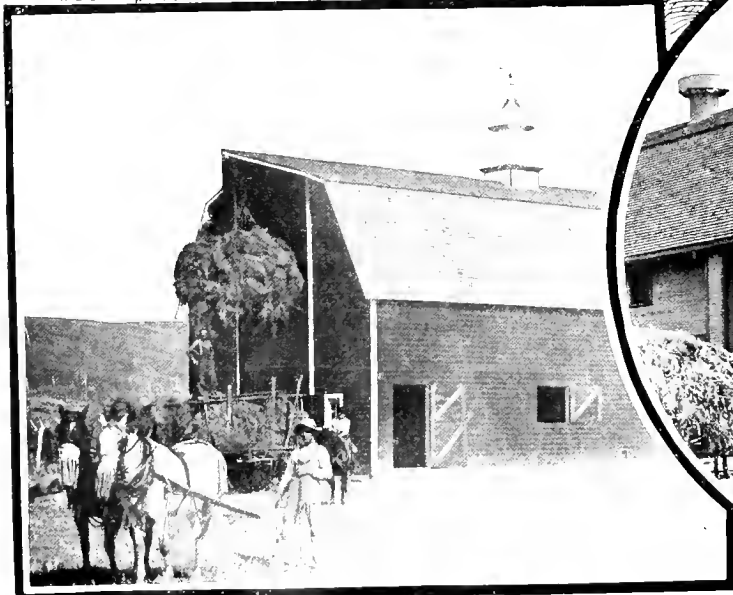
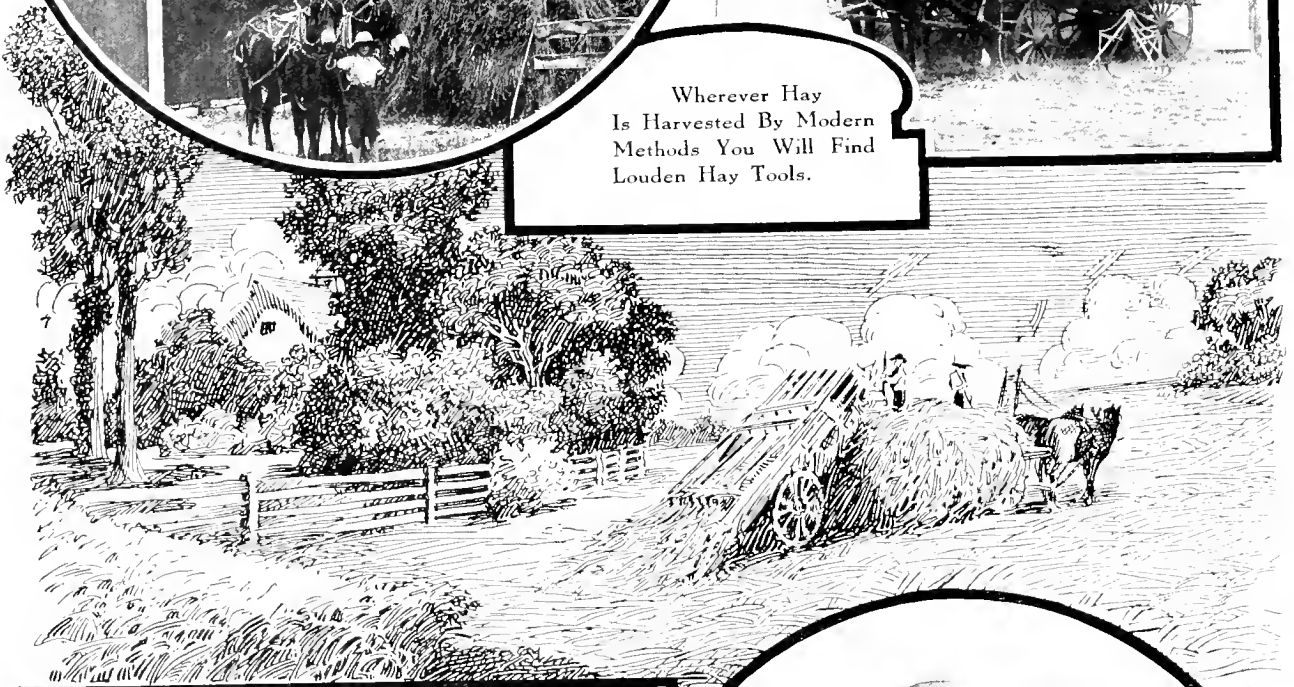

Carry-All Sling Carrier—Continued

The work of the Rope Lock is supplemented by a ratchet lock on the Rope Wheel. When the Rope Lock goes into action the ratchet lever drops into place and prevents the Rope Wheel from turning backward. This aids the Rope Lock and prevents wear on the rope.

Ten-Inch Roller-Bearing Rope Wheel

The Rope Wheel in the Carry-All Carrier is 10 inches in diameter and is roller bearing. This is the largest Rope Wheel used in any hay carrier and is an important improvement. The large roller-bearing wheel reduces friction and makes it possible to lift heavier loads with less power. Also the empty sling can be brought back to the wagon with less effort and pulling on the ropes than any other sling carrier.

The frame of the carrier is of the Louden Swivel Type. The same principle is used in the swivel as in use on all our swivel carriers. (See Fig. 7, page 11.) It will work with equal satisfaction and efficiency in barns having a center driveway or where hay is taken up at one end. In center-drive barns the change from one end to the other is easily and quickly made. The pulley in one end of the barn is changed over to the other end; the carrier can then be swiveled around from the barn floor. No climbing up to the carrier necessary.

The track wheels are 3 inches in diameter on tread and are heavy and of great strength. There are eight track wheels on each carrier working on oscillating "engine trucks". This distributes the load evenly on the track and insures that every wheel is going to run true and carry its share of the load.

The sling pulleys carry the load at right angles to the track. This is important as the hay is delivered into the mow just as it comes from the wagon. When the hay is dropped it spreads out broadly at right angles to the track, requiring less labor and time to mow it back.

The locking dog in the carrier has a square catch which engages the trip block bolted to the track. The carrier is held positively on the trip while the load is being elevated. When the load is pulled up and the sling pulleys strike the trip stirrup the carrier automatically releases from the trip, the rope lock is thrown into action holding the load so it cannot slip back. When the carrier leaves the trip it runs easily and steadily and after the hay is dropped in the mow the carrier is returned to the trip block with scarcely an effort. (We recommend using a weight return for returning the empty carrier. See Fig. 529, page 19.)

The Louden Carry-All Hay Sling Carrier, the Louden Carry-All Hay Sling (see Fig. 984, page 42), and a Louden Power Hoist (page 34), make the best hay-unloading outfit ever offered for handling big loads of hay.

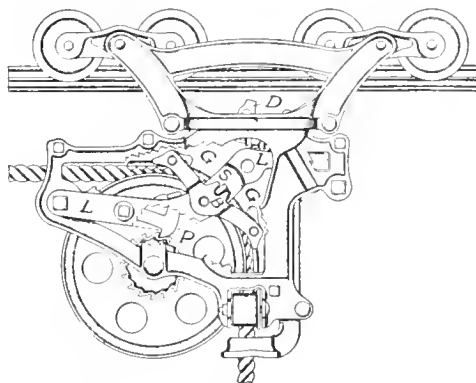

Cross Section View and Description of Locking Mechanism in Carry-All Hay Sling Carrier.

A portion of the frame is broken away to show the arrangement of the grip to hold the hoisting rope and prevent the sling load from dropping down while the carrier is running along the track.

Fig. 1302

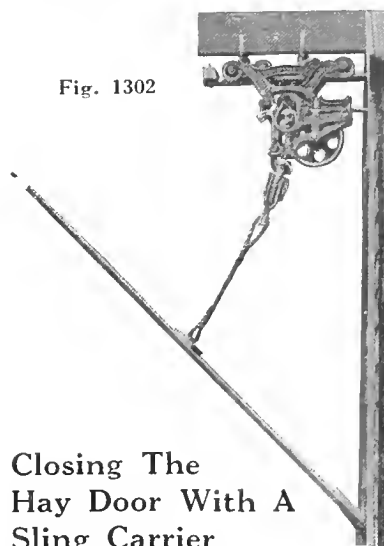

Closing The Hay Door With A Sling Carrier

When it is desired to close the hay mow door with the Carry-All, or any similar sling carrier, the sling pulleys should be attached to the door in the manner shown by Fig. 1302.

The door should be lifted from about the middle instead of from a point near the top; otherwise the pulleys will be drawn so far to one side that they will not release the carrier properly.

A short piece of rope, with a loop at the free end to hook the pulleys into, should be attached to the doors by means of an eye-bolt or U-bolt. It should be long enough to permit the sling pulleys to trip the carrier when the door is at an angle of about 45 degrees. For the Carry-All Sling Carrier about 4 feet of rope is required for a 10-foot door, and 5 feet for a 12-foot door.

When the carrier leaves the trip it is drawn along the track far enough to close the door.

Louden Iowa Sling Carrier—Fig. 821

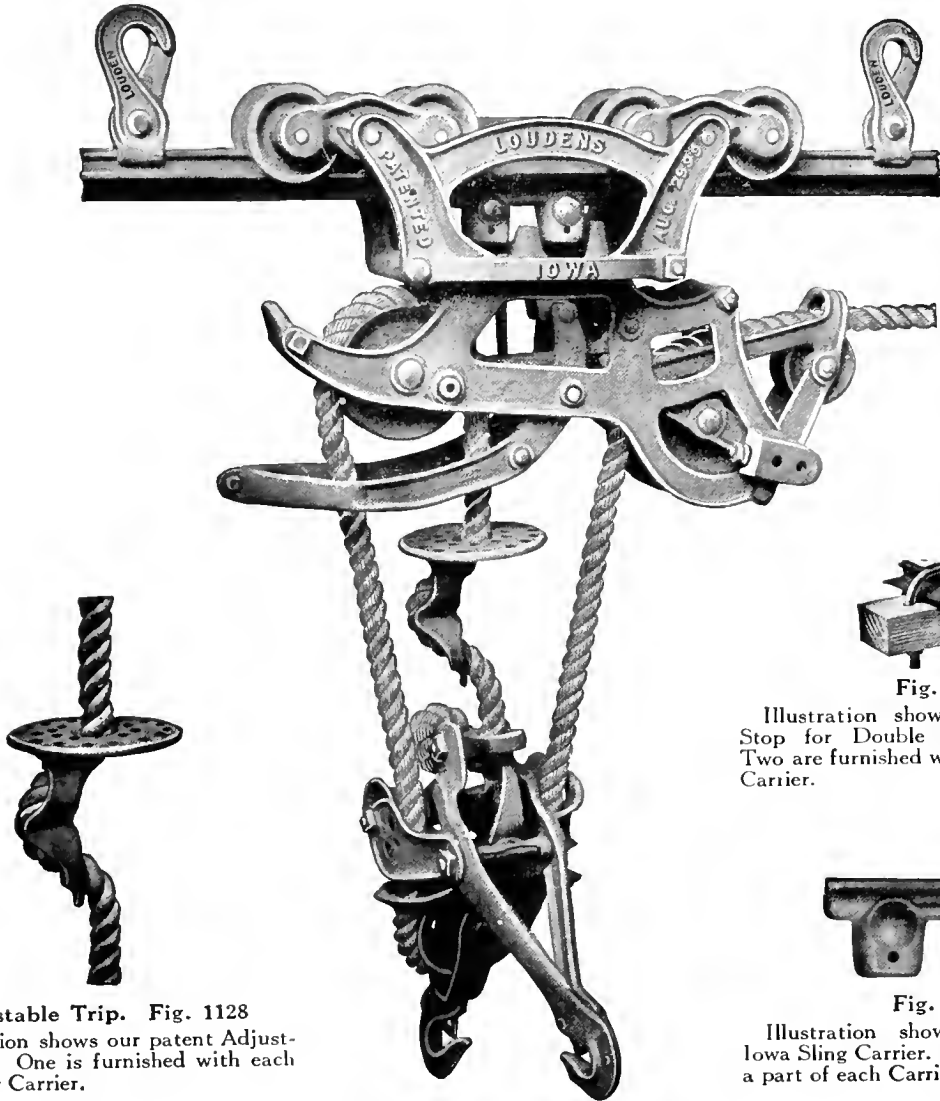

Fig. 821 (Chariot)
Specifications

Adjustable Trip. Fig. 1128
Illustration shows our patent Adjustable Trip. One is furnished with each Iowa Sling Carrier.

For use in any style of barn.
Built to operate on Loudens Double Bead Steel Track.
Diameter of Rope Wheels in carrier and sling pulleys, 4 inches.
Diameter of Track Wheels on tread, $2\frac{1}{4}$ inches.
Bearing surface on track (distance between front and rear axles), $14\frac{1}{2}$ inches.
Total length of carrier, $19\frac{1}{2}$ inches.
Carries slings within 26 inches of track.
Frame of carrier refined malleable iron.
Rope and Track Wheels special quality gray iron.
Safe working capacity, 2,000 pounds.

Rope Lock is adjustable to different size ropes.
Three-quarter inch best manilla rope is recommended
Illustration shows carrier with Right-angle Sling Pulleys which we recommend.
Parallel Sling Pulleys (Fig. 649, page 48) may be used if preferred.
Two Sling Pulleys, 1 Trip Block, 1 Trip Adjuster, and 2 End Stop Blocks are furnished with each carrier.
Weight, 47 pounds.

(See pages 30 and 31 for Track and Track Fittings.)

Fig. 523

Illustration shows our patent End Stop for Double Bead Steel Track. Two are furnished with each Iowa Sling Carrier.

Fig. 1123

Illustration shows Trip Block for Iowa Sling Carrier. One is furnished as a part of each Carrier.

Louden Iowa Sling Carrier—Continued

For simplicity of design and mechanism and for positive, dependable action the Iowa Sling Carrier ranks with the foremost. It was designed for heavy, everyday work in the hay barn. It has gone through a dozen or more hay harvests; is doing satisfactory service in thousands of barns, and is pleasing its users.

The carrier is of the Louden swivel frame type. It can be used with perfect success in any type of barn and is particularly well adapted for use in barns having a center driveway. In center drive barns the carrier can be changed from one side to the other in a minute's time and without climbing up to the carrier or pulling the ropes through. The pulley in the end of the barn is changed from one end to the other and the carrier frame swiveled around on the stop from the barn floor by a swinging pull on the ropes.

The frame of the carrier is of refined malleable iron. Heavy strengthening webs are used where strength is necessary. At all points where heaviest strain is exerted castings are reinforced to give needed strength. The mechanism of the carrier (the rope lock and the latching dogs and parts) is extremely simple. There is nothing to get out of order and the parts are all easily accessible.

There are eight track wheels on each carrier operating on oscillating "engine trucks." This distributes the weight of the load evenly on the track and insures that every wheel will do its full share of the work. The wheels are bored smooth and true and turn on $\frac{3}{4}$ -inch milled axles and will not bind or run hard.

The rope lock has a long bearing surface on the rope. When the carrier is tripped the rope lock instantly grips the rope and holds it firmly. There is no slipping, nor wear on the rope. The rope lock is adjustable to different size ropes.

Each carrier is provided with an adjustable trip. This trip is placed on the draft rope (see illustration) and is adjustable to different heights. By this means the carrier may be released and the load carried into the mow at any height. Unless, on account of beams or hay already in the mow, it is not necessary to lift the load clear up to the track.

In operation, when the sling pulleys or the adjustable trip strikes the release lever, the locking device drops down and the carrier moves away from the stop smoothly and steadily. In the same operation the rope lock is thrown on and holds the load until the sling is tripped. When the carrier is brought back to the stop the rope lock is released and the weight of the pulleys and sling brings them down to the wagon.

Hay forks may be used with this carrier by using the fork clevis described on page 45, Fig. 653.

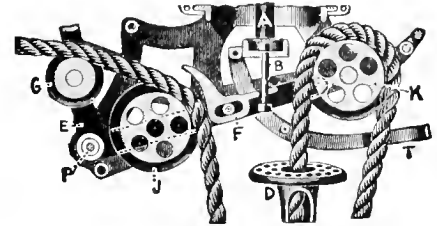

Fig. 528

Fig. 528 is a sectional view showing the locking mechanism in the Iowa Sling Carrier and also how the carrier is threaded. Pulleys G and J are mounted on Tilting Frame E pivoted at P. The Brake F is pivotally connected with the tilting frame, forming a knee joint, which grips the rope between the Brake F and Pulley J when the carrier is tripped. Brake F is held free from the rope while the load is being elevated by Bolt B attached to Locking Dog A, which operates with the track stop.

Louden Weight Return

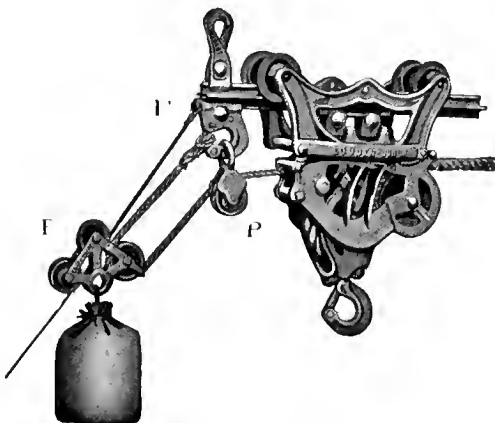

Fig. 529. Weight 3 pounds.

Specifications

Weight, 3 pounds.

A Weight Return for returning the carrier to the trip block after the load has been deposited in the mow is desirable with all hay carriers, especially so in long or high barns.

The Weight Return brings the carrier back to the trip block promptly, and always with enough force to securely latch the carrier.

Fig. 529 shows End Weight Return attached to carrier and arranged for End Hoist barn. It shows our improved Return Pulley R on wire guy, Clamp Hook H and Pulley P. A wire guy is preferable to a rope guy.

In ordering, state kind of track used to get Hook H to fit it. A bag of sand is the best weight to use.

Louden Reversible Sling Carrier—Fig. 315

(For Wood Track)

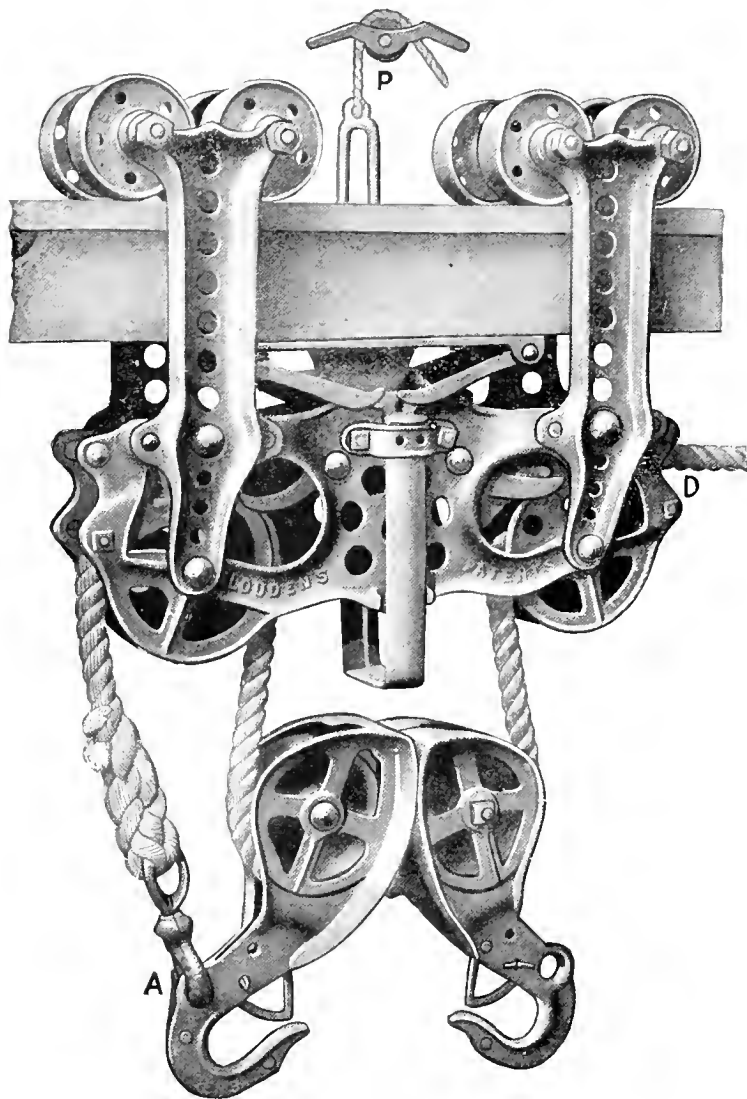

Fig. 315
Specifications

Operates on 4x4 wood track.
 For use in any style of barn.
 Diameter of Rope Wheels, 4⁵/₈ inches.
 Diameter of Track Wheels, 3 inches.
 Bearing surface on track (distance between front and rear axles), 15 inches.
 Total length of Carrier, 18 inches.
 Carries slings within 19 inches of the track.
 Frame of Carrier refined malleable iron.
 Rope and Track Wheels special quality gray iron.
 Safe working capacity, 2,000 pounds.
 Three-fourths inch best Manilla Rope is recommended
 One pair Sling Pulleys, 1 Trip Block, 1 Rope Hook, 1 Comb Pulley,
 1 Lift Link furnished with Carrier.
 Weight, 52 pounds.

The Reversible Sling Carrier is a strong, dependable carrier built to operate on 4x4 wood track. In the illustration the carrier is shown with parallel sling pulleys rigged triple draft.

The mechanism of the carrier is very simple and compact. There is a double rope lock, each lock having a long bearing surface on the rope. When the load is elevated, and the sling pulleys strike the trip stirrup, the rope locks go into action holding the load secure. There is no chance for the load to slip back and wear on the rope is reduced to a minimum.

The Carrier is fitted with eight track wheels. The wheel arms are heavy and strong and will not spread under the weight of heavy loads.

The Trip Blocks are adjustable. Two or more trips can be used on the same track and as many of them as desired can be lifted up to allow the carrier to pass through. The frame of the carrier is of the straight reversible (not swivel) type. To reverse the carrier for work in the opposite mow, the draft rope is pulled through the carrier. The end of the rope at D is carried through pulley at end of barn and from there, on down to the horse or team. The other end of the rope is fastened in the eye, A, in the sling pulley.



Fig. 435 (Perch)
 One Comb Pulley Furnished with Each Reversible Wood Track Carrier.



Fig. 383 (Excelsior)
 One Rope Hook Furnished with Each Reversible Wood Track Carrier.



Fig. 1130
 One Trip Block Furnished with Each Reversible Wood Track Carrier.

LOUDEN HAY TOOLS

Have Proved Their Worth In
Field and Barn. They Have
Been the World's Standard
for Fifty Years.

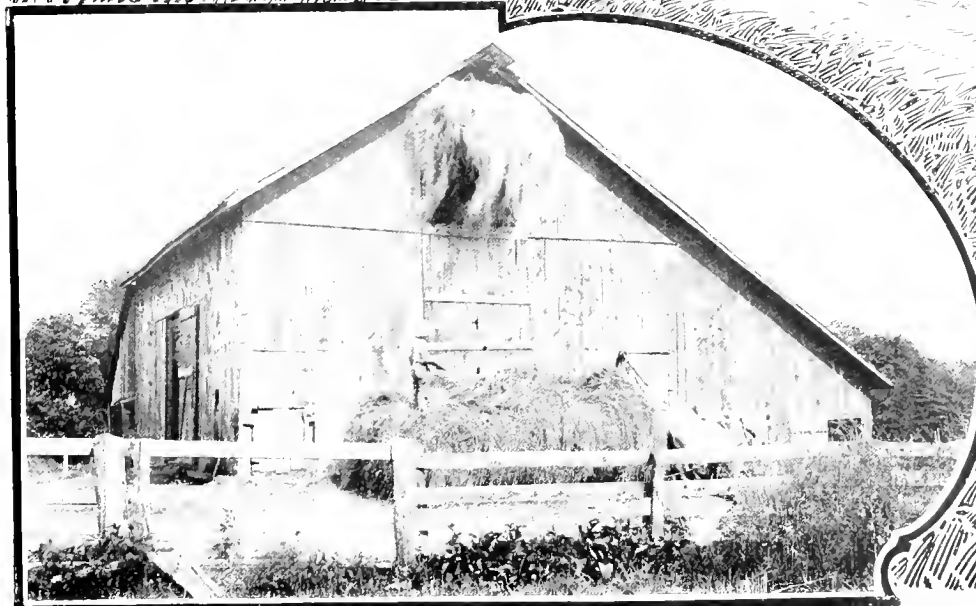
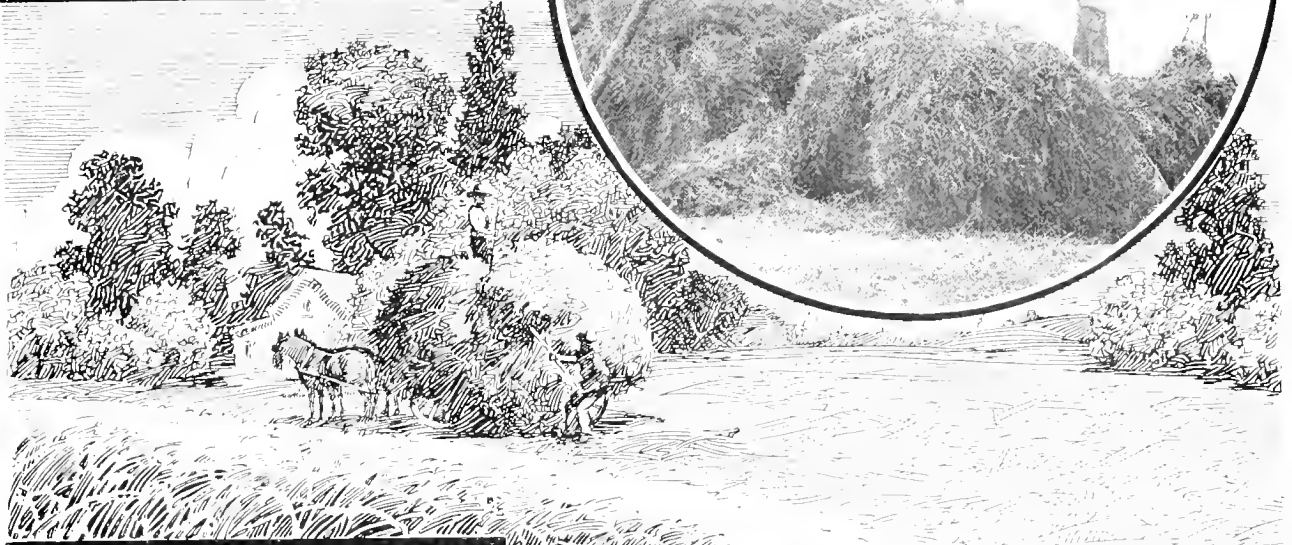
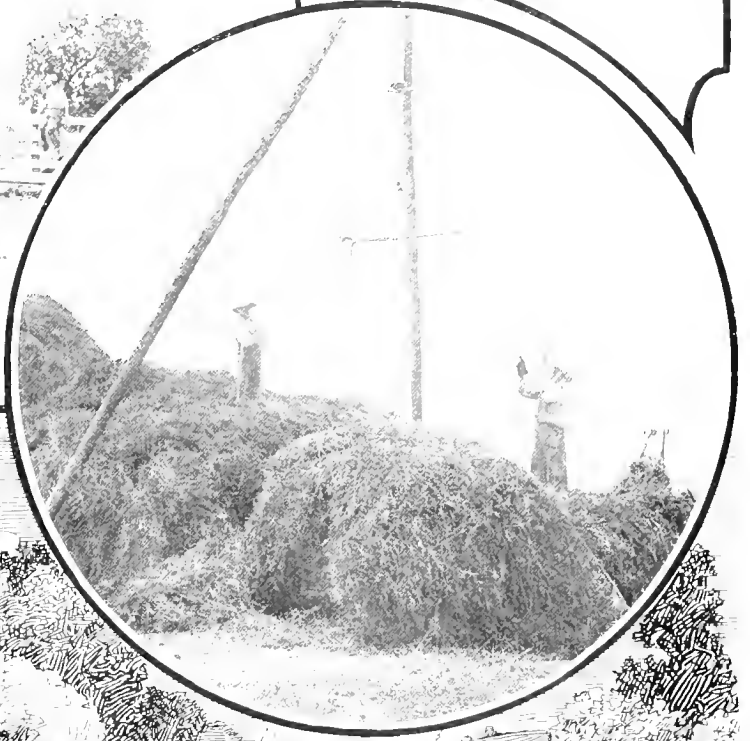
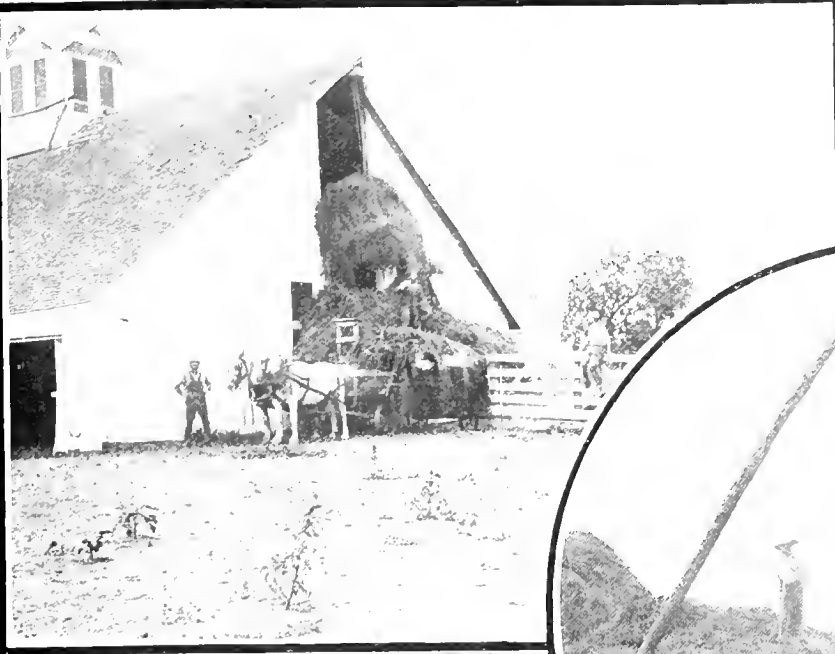

Louden Cross Draft Hay Carrier—Fig. 817

(For Sling or Fork)

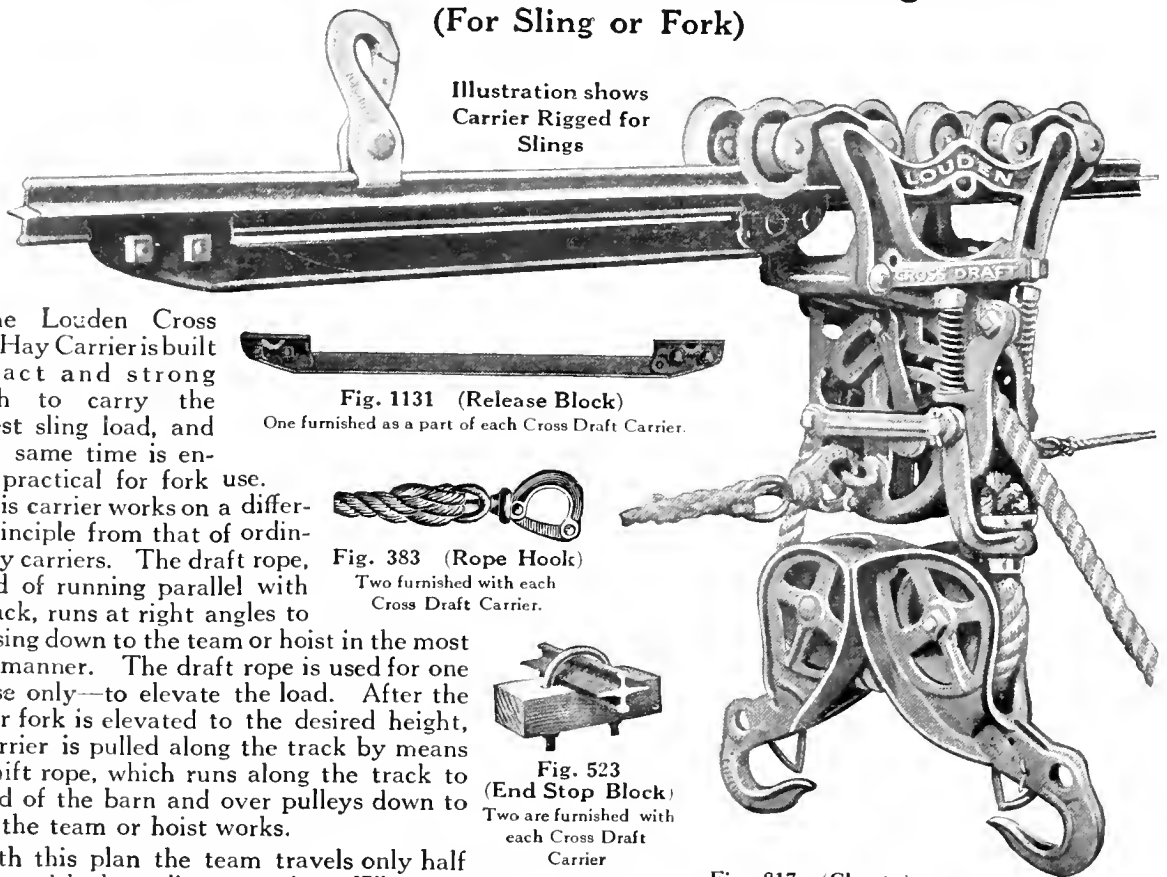

Illustration shows
Carrier Rigged for
Slings

Fig. 1131 (Release Block)

One furnished as a part of each Cross Draft Carrier.



Fig. 383 (Rope Hook)

Two furnished with each
Cross Draft Carrier.



Fig. 523
(End Stop Block)

Two are furnished with
each Cross Draft
Carrier

Fig. 817 (Chaste)
Patented July 25, 1911

Specifications

Recommended for use in barns where hay is elevated from a center driveway. Built to handle hay slings, but will handle hay fork with equal satisfaction. Operates on Louden Double Bead Steel Track. Diameter of the Rope Wheel in carrier, 6 inches. Diameter of the Rope Wheels in sling pulley or fork pulley, 4 inches. Diameter of Track Wheels on tread, 3 inches. Bearing surface on track (distance between front and rear axles), 16 inches. Total length of Carrier, 21 inches. Carries slings or fork within 21 inches of the track. Frame of the carrier of refined malleable iron. Rope and track wheels special quality gray iron. Safe working capacity, 2,000 pounds. Seven-eighths-inch best manilla rope is recommended, and urged for use with this carrier. Thirteen-sixteenths-inch rope can be used, but $\frac{7}{8}$ -inch is better. Two-Sling Pulleys, 1 Release block, 1 3-Part Rope Hitch, 2 Swivel Rope Hooks, 2 End Stop Blocks, furnished with each carrier. Unless otherwise specified sling pulleys will be furnished with the carrier. If Hay Fork is to be used, fork pulley (Fig. 366, page 51) will be furnished instead of sling pulleys. Weight for sling use, 49 pounds. Weight for fork use, 42 pounds.

The Louden Cross Draft Hay Carrier is built compact and strong enough to carry the heaviest sling load, and at the same time is entirely practical for fork use.

This carrier works on a different principle from that of ordinary hay carriers. The draft rope, instead of running parallel with the track, runs at right angles to it, passing down to the team or hoist in the most direct manner. The draft rope is used for one purpose only—to elevate the load. After the sling or fork is elevated to the desired height, the carrier is pulled along the track by means of a shift rope, which runs along the track to the end of the barn and over pulleys down to where the team or hoist works.

With this plan the team travels only half as far as with the ordinary carrier. When the team is walking out from the barn, it is hoisting the load; when the load reaches the proper height, the shift rope is hooked to the team and as the return to the barn is made the carrier is pulled along the track into the mow. As there is a shift rope on each side of the carrier, one is always ready to use to return the empty carrier, no matter into which mow the hay has been carried.

For handling slings the carrier should be rigged with sling pulleys, as shown in the illustration. For fork use the sling pulleys would be replaced with the Louden Fork Pulley. (See Fig. 366, page 51.) If a Louden Fork Pulley is not at hand, any common pulley can be used.

The carrier is provided with an automatic lock. This lock will hold the hay suspended at any height. When the load is elevated high enough to pass into the mow, the team is stopped and turned back toward the barn. The end of the idle shift rope is attached to the singletree and as the team returns to the starting place, the carrier is drawn along the track to the end of the barn.

The Cross Draft Carrier has many advantages over ordinary carriers. The draft is more direct, it requires about one-half less draft rope and as it passes over only one large sheave in the Carrier there is less friction, thus requiring less power to elevate the load. The horse has to walk only about half as far and gets back quicker, thus saving time and also space in

Louden Cross Draft Hay Carrier—Continued

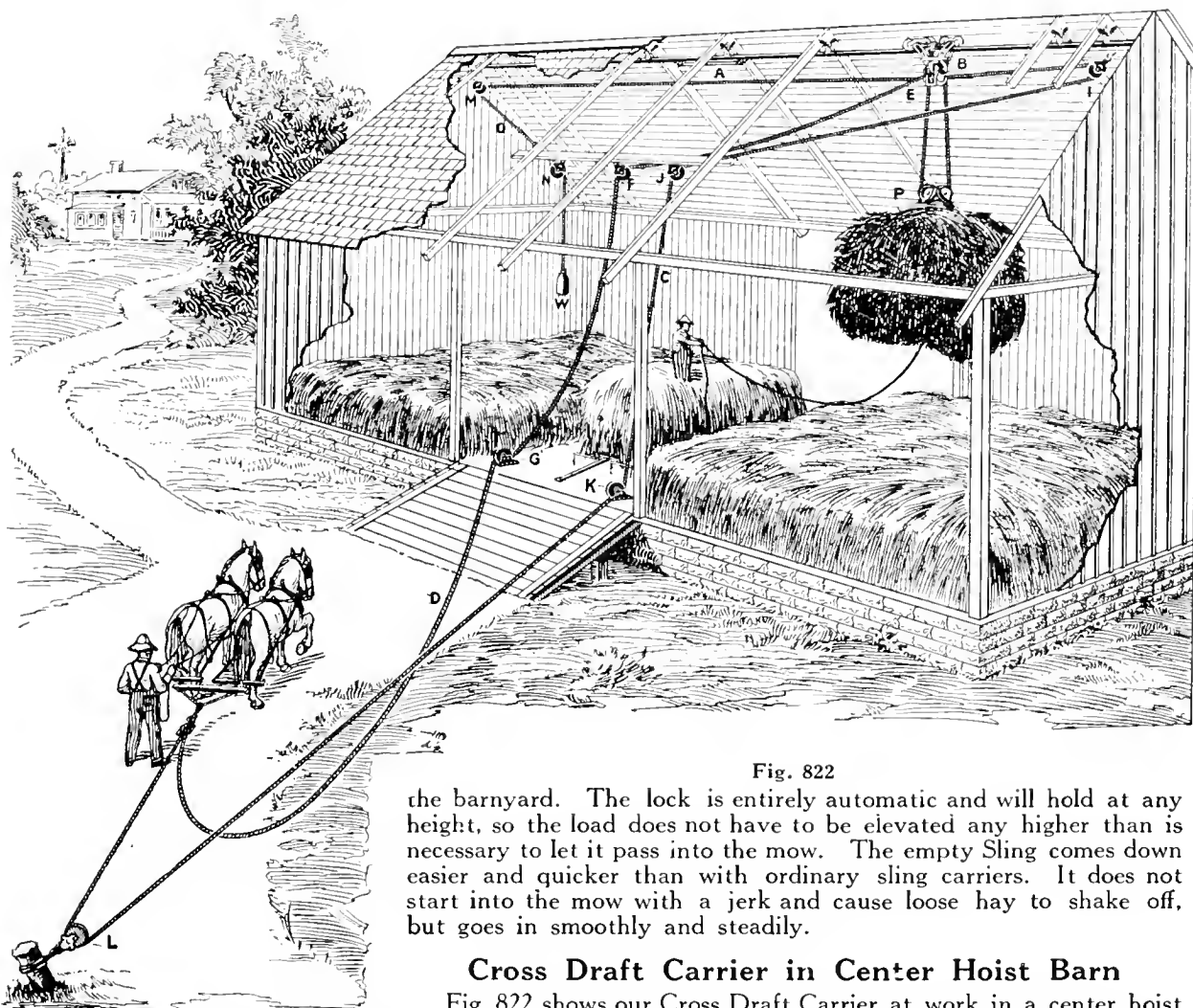

Fig. 822

the barnyard. The lock is entirely automatic and will hold at any height, so the load does not have to be elevated any higher than is necessary to let it pass into the mow. The empty Sling comes down easier and quicker than with ordinary sling carriers. It does not start into the mow with a jerk and cause loose hay to shake off, but goes in smoothly and steadily.

Cross Draft Carrier in Center Hoist Barn

Fig. 822 shows our Cross Draft Carrier at work in a center hoist barn. The sling load has been elevated by the Draft Rope D until it is high enough to pass into the mow, **the automatic lock in the carrier holding it at any desired height.** The Shift Rope C has been connected to the trip of the Rope Hook, the horses have been turned back toward the barn and the Sling load is being drawn into the right-hand end of the barn and the operator is **ready to trip it** when it reaches the proper place. The draft rope is first secured to the Spring Clevis E of the Carrier B by means of **our patent swivel**, then passed down through the Sling Pulleys P, then up through the carrier and on through the Draft Pulleys F and G and is connected to the Rope Hook. The Shift Rope C is fastened to one of the **swivel eyes on the carrier**, and is then passed through the Shift Pulleys I, J, K, and L.

In elevating the hay the team is driven from the Pulley G to or past the Pulley L, as may be required by the distance the hay is to be elevated, and in turning back, the shift rope is connected to the trip of the Rope Hook, which **draws the carrier with its load into the mow** as the team is driven to the barn. The shift rope is then tripped from the rope hook, the carrier is drawn back to the Release Block A, by the Weight W, **when the empty sling will descend of its own weight, and when unhooked from the Pulleys P everything will be ready for another load.**

The instant the horses stop, or if a singletree or anything else should break, **the lock takes the weight of the load** and holds it securely without a particle of slipping. While loaded, the lock is **always in position** to hold the load at any point of elevation.

The carrier will work without the Release Block A by removing the lock-latch, but it works much better with it, as by this means **the empty sling or fork can not drop down in the mow.** This is a fault

Cross Draft Carrier in Center Hoist—Continued

that all other cross draft carriers have and we have entirely overcome it by the use of this lock-latch in the carrier and the Release Block A on the track. The carrier does not have to stand over the release block in elevating the load, notwithstanding this is its usual position. It may stand on either side or be drawn across it, **without any effect when loaded**, but it will **always release the lock when the carrier is empty**. In this way the empty fork or sling is prevented from dropping down in the mow, while the lock will **always be released** to permit them to descend at the proper place.

The stake to which Pulley L is fastened should be set far enough out in the yard to permit the team, after turning back, to draw the carrier to the end of the mow before getting too close to the Pulley G, and there should be 10 feet extra to connect the shift rope easily and quickly to the trip of the Hook H. The longer the barn, the **farther away** the Pulley L must be set.

To take the hay into the other end of the barn, remove the Weight W from the Shift Rope O which is connected to the swivel eye on the other side of the carrier and is passed through the Shift Pulleys M and N. **Withdraw the Shift Rope C** from the Pulleys K and L and attach to it the Weight W. Now run the Shift Rope O through the Pulley K (as shown by dotted line) and then through the Pulley L, and you are **ready for business** in the other end of the barn. It may be better to use a **separate rope** out in the barn yard, which may be done by using a hitch similar to A, Fig. 819. When this is done the Shift Ropes C and O will only have to be long enough to pass through the Pulley K.

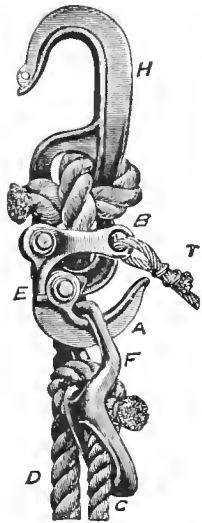

Fig. 819

Louden's Cross Draft Rope Hook

Fig. 819 represents our Cross Draft Rope Hook, which is an important part of the outfit, for upon its **convenience and quickness** of operation considerable depends. The Draft Rope D is secured, as shown, to the **main part of the Hook H**, while the Shift Rope C is fastened to the Hitch F, which in turn is hooked in the **Trip Hook A**. This is held in place and tripped by the Latch E, having an Eye B to which the Trip Cord T is connected. The shift rope is much more **easily and quickly connected to** and tripped from our rope hook than the devices used with other cross draft carriers.

When the hay reaches the **proper height** to pass into the mow, the team is turned back toward the barn and the Hitch F is **readily and quickly slipped** over the Trip Hook A; and when the hay has reached **the point of deposit** in the mow, a **slight pull** on the trip cord will disengage the Latch E, and release the Shift Rope C. In this way the hay **will not be drawn beyond** the proper place and **frequently** the hay will be discharged, the carrier returned and the empty sling or fork brought down to the load by the time the team gets back to the barn.

Louden's Cross Draft Hay Carrier

Outfit for 60-foot barn, 40-foot peak

	Fig.	Page
1 Cross Draft Carrier	817	22
54 feet of Double Bead Steel Track	571	30
7 High-Grade Draft Pulleys	468	49
1 Upright Floor Pulley	364	50
30 Steel Track Hangers	498	30
30 Rafter Brackets	424	31
5 Rafter Pulley Hooks	390	52
1 Floor Pulley Hook	389	52
2 Hoisting Singletrees	344	53
1 Rope Spreader Attachment	345	53

Three slings are generally used, but in place of these, one sling and two harpoon forks or one grapple fork may be used.

To get correct length of draft rope, multiply distance from floor to peak of barn by 3 and add 20 feet. To get right amount of shift rope multiply length of barn by 2; also distance from floor to peak by 2 and add 20 feet. If extra rope is used out in yard make this the length of longest mow, with half the width of driveway added. If not, add this length to total length of shift rope.

Five-eighths is best for the shift rope. Three-quarters will answer, but is more expensive and being heavier makes the carrier harder to draw back. To get correct length of trip cord, take length of longest mow and add 25 feet. Set post for Pulley L out 10 feet further than half length of barn.

Louden Round Barn Hay Unloading Outfits

Within recent years there has been much discussion regarding the advantages and disadvantages of round barns. It is not our purpose in this catalog to enter into a discussion of the merits of such buildings. We know that in certain localities round barns have come into favor and one of the problems in connection with these buildings has been the hay unloading outfit. Operating a hay carrier on a straight-away track and operating a hay carrier on a circle track are two entirely different propositions. It was our business to provide successful tools for unloading hay on the circle track. We have perfected hay unloading equipment to meet every condition in the round barn and with which hay may be handled and stored as quickly, as cheaply, as easily, and as safely as in rectangular barns.

Louden Round Barn Hay Carrier—Fig. 1104 (For Fork or Slings)

Specifications

The only successful hay fork and hay sling carrier made for circle track.

For use in round barns of all sizes.

Built to operate on Louden Double Bead steel track only.

Diameter of rope wheel in carrier, 6 inches.

Diameter of rope wheels in sling pulley and fork pulley, 4 inches.

Diameter of track wheels on tread, 3 inches.

Track wheels are supported on heavy truck castings attached to main frame of carrier by means of strong swivel connection.

Bearing surface on track (distance between front and rear axles), 16 inches.

Total length of carrier, 21 inches.

Carries slings or fork within 21 inches of the track.

Frame of carrier of refined malleable iron.

Rope and track wheels special quality gray iron.

Safe working capacity, 2,000 pounds.

Note: Five-inch link track hangers (Fig. 832, page 30) should always be ordered for circle track for round barns.

Seven-eighths inch best manila rope is recommended and urged for use with this carrier.

Thirteen-sixteenths inch rope may be used but $\frac{7}{8}$ inch is better.

Two sling pulleys, 1 release block, 2 end stop blocks, 2 swivel rope hooks furnished with this carrier.

Unless otherwise specified, parallel sling pulleys will always be furnished with this carrier.

If hay fork is to be used fork pulley (Fig. 366, page 51) will be furnished instead of sling pulleys.

Weight for sling use, 57 pounds.

Weight for fork use, 50 pounds.

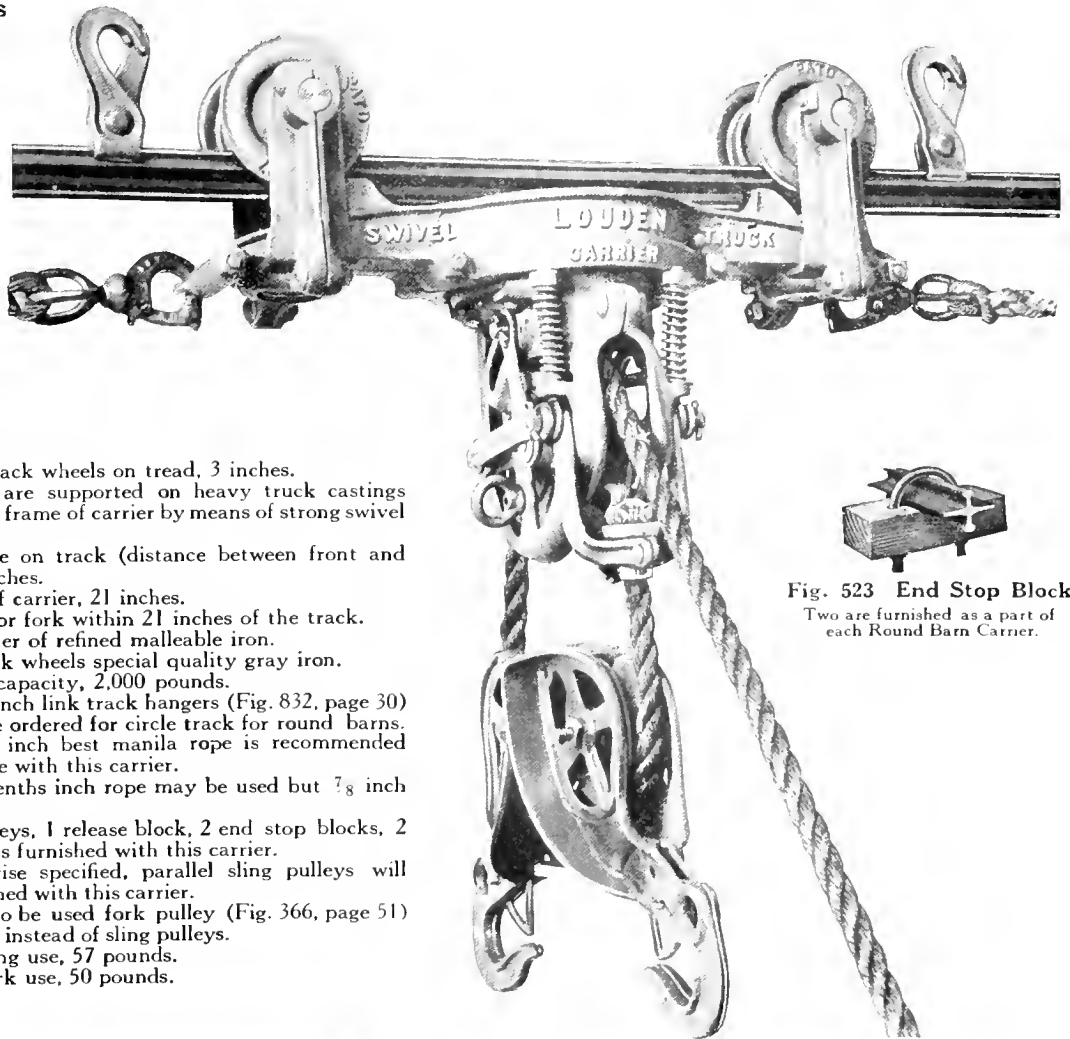

Fig. 523 End Stop Block
Two are furnished as a part of each Round Barn Carrier.



Fig. 1131 (Release Block)
One is furnished with each Round Barn Carrier.

Fig. 1104
(Round)

Patented July 25, 1911.



Fig. 383 (Excelsior)

Two Rope Hooks furnished with each Round Barn Carrier.

Louden Round Barn Hay Carrier—Continued

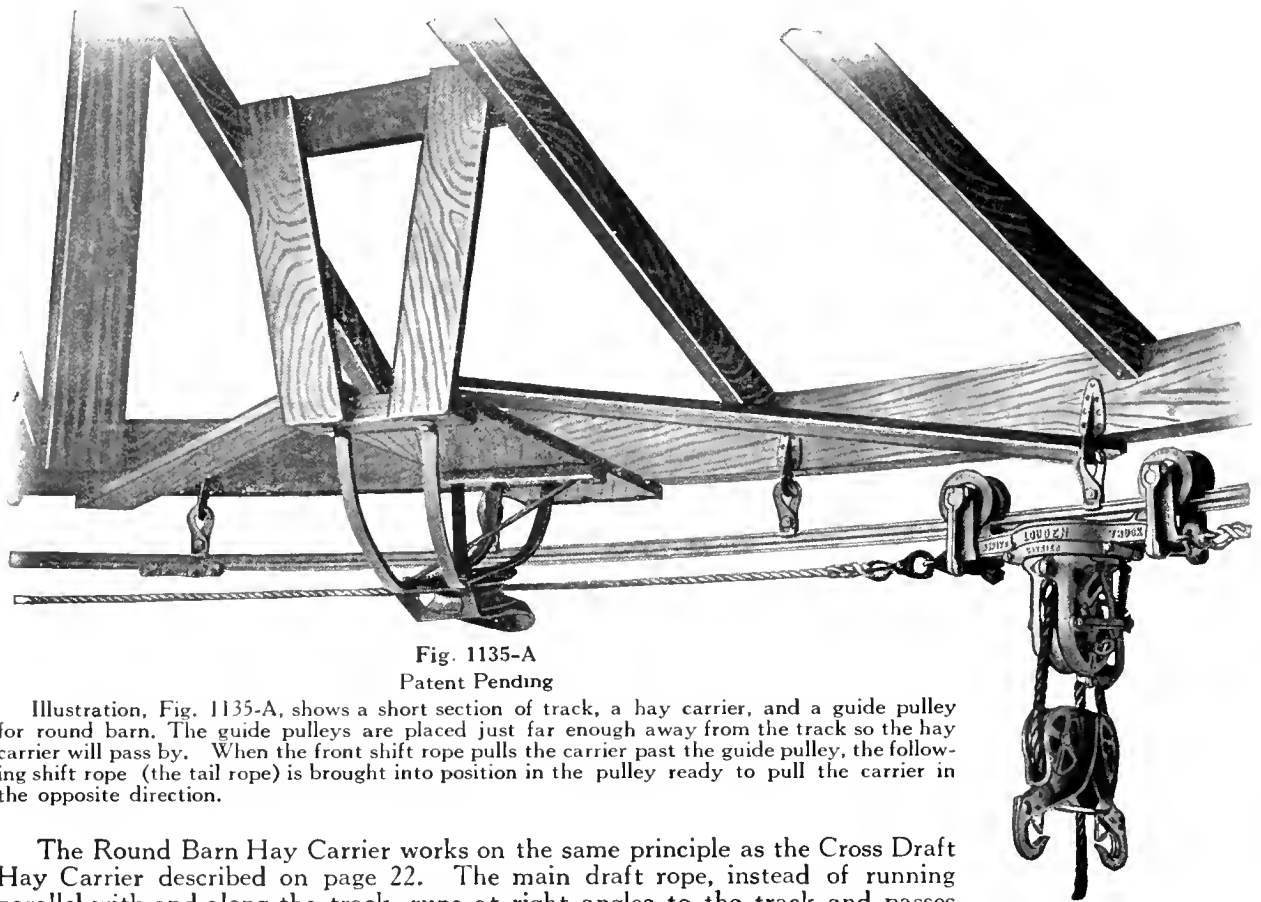

Fig. 1135-A
Patent Pending

Illustration, Fig. 1135-A, shows a short section of track, a hay carrier, and a guide pulley for round barn. The guide pulleys are placed just far enough away from the track so the hay carrier will pass by. When the front shift rope pulls the carrier past the guide pulley, the following shift rope (the tail rope) is brought into position in the pulley ready to pull the carrier in the opposite direction.

The Round Barn Hay Carrier works on the same principle as the Cross Draft Hay Carrier described on page 22. The main draft rope, instead of running parallel with and along the track, runs at right angles to the track and passes down to the team or hoist in the most direct manner. The draft rope is used solely to elevate the hay and not to pull the carrier along the track. With the draft rope passing directly from the carrier to the team or hoist, only about half as much draft rope is required as with an ordinary hay carrier. This also greatly reduces friction, as the rope does not have to pass over so many pulleys, making it possible to lift heavier loads with less power.

Independent shift ropes are used for pulling the carrier along the track. Good quality $\frac{5}{8}$ -inch rope is suitable for shift ropes. Two of these ropes are necessary, one end of each rope being attached to opposite sides of the carrier, the other end passing around the guide pulleys and continuing to the hoist or to the team and weight return as the case may be.

Where engine or electric power is at hand, this outfit used in connection with a Louden Triple Drum Power Hoist (see Fig. 1132, page 35) makes the most complete and perfect hay unloading outfit ever installed in any barn. The lower end of the main draft rope is connected to the main drum of the hoist. The lower end of each of the shift ropes is attached to the respective two smaller drums of the hoist.

The main drum of the hoist is used to elevate the load. It is not necessary to raise the load up to the track unless beams or hay already in the mow interfere. The load can be stopped at any height and can be carried in either direction from the driveway at will. The instant the tension is released on the draft rope the rope lock goes into action and will catch and hold the load. If it is desired to carry the hay to the right, the right hand drum, and if to the left, the left hand drum, is brought into action. This pulls the carrier along the track and when the load is dropped the opposite drum is brought into play and the empty carrier is returned to the release block. The entire operation is extremely simple and the hoist can be handled by anyone.

Louden Round Barn Hay Carrier—Continued

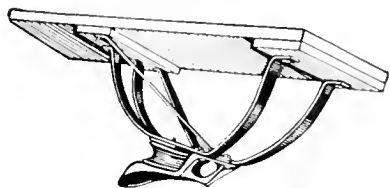

Fig. 1135

Guide Pulley

Specifications

Length of mounting block, 36 inches.
 Width of mounting block, 12 inches.
 Depth of mounting block, 12 $\frac{1}{2}$ inches.
 Diameter of pulley, 6 $\frac{1}{2}$ inches.
 Weight, complete, 26 $\frac{1}{2}$ pounds.

We furnish the track bent to form a circle track of any diameter. Each section of the track is put through a bending machine, and is bent uniform and true, and without kinking the flange or injury to the track. We furnish suitable hangers for supporting the track from rafters or from purlin plate as desired. It should be remembered that the higher up in the building the track is placed the easier it will be to fill the mow full.

Special guide pulleys are used for holding the shift ropes in parallel position with the track. These pulleys are furnished mounted on a board (see Fig 1135A, page 26), and are easy to put in place. The pulley sheave or rope wheel is mounted in a malleable iron casing and supported by steel braces. The pulley is mounted in a slightly tilted position; also, the lower pulley casing extends beyond and slightly upward in front of the rope wheel, thus holding the shift ropes in position. Even should the ropes become very slack they will not fall out of the pulley.

Where a complete circle track is installed, seven or eight or more guide pulleys should be used. The purpose of the guide pulleys is to carry the shift rope as nearly parallel with the track as possible. The number of pulleys necessary is determined by the diameter of the track. Always enough pulleys should be used so the carrier will be pulled straight ahead, not sideways.

Where there is a silo in the center of the building, it would be necessary to detach one shift rope from the hoist and carry it around the silo when changing to work the carrier in the opposite mow. This change is easily made, requiring only two or three minutes' time.

This rig can be used with horse power instead of the hoist and when so used the arrangement of ropes would be only slightly changed. Instead of one shift rope passing around the complete circle, as shown with hoist, both shift ropes would pass over pulleys and be arranged to correspond with the arrangement in rectangular barns. (See Fig. 822, page 23.)

This special unloading outfit for round barns will do satisfactory work in barns of all sizes. Hay forks or hay slings can be used and the rig will handle heavy loads of all kinds of hay.

Garden City, Minn., June 6, 1916.

Louden Machinery Co., St. Paul, Minn.

Gentlemen:

We are well pleased with the entire outfit that we have of yours in our round barn. The Hay Carrier outfit works to a "T." In fact the entire equipment is O. K.

Yours truly, Lester Fleming.

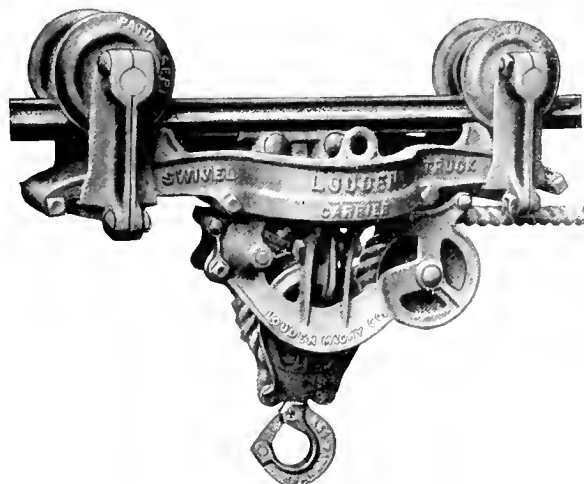

Fig. 430 $\frac{1}{2}$

Junior Round Barn Fork Carrier—Fig. 430 $\frac{1}{2}$

Where it is desired to use an ordinary type of fork hay carrier in a round barn, we recommend the Junior Fork carrier, same as described on page 8, except that it is fitted with special extra heavy swivel trucks. The swivel trucks permit the track wheels to adjust themselves to the bend of the track so there is no excessive wear and no binding on the track. Aside from the swivel trucks, this carrier is exactly the same as the Junior Carrier, Fig 430, described on page 8, and will give complete satisfaction wherever used.

Louden Junior Hay Fork Carrier For Cable Track—Fig. 621

Specifications

For stacking hay in the field.
 Built to operate on $\frac{5}{8}$ -inch or $\frac{1}{2}$ -inch cable.
 Diameter of rope wheels 4 inches.
 Diameter of track wheels on tread, $3\frac{1}{4}$ inches.
 Bearing surface on track (distance between front and rear axles), 10 inches.
 Total length of carrier, 14 inches.
 Carries fork within 13 inches of the track.
 Frame of carrier of refined malleable iron.
 Rope and Track Wheels special quality gray iron.
 $\frac{3}{4}$ inch best manilla rope is recommended.
 $\frac{13}{16}$ or $\frac{7}{8}$ inch rope may be used.
 Safe working capacity 1,000 pounds.
 One Fork Pulley, 1 Trip Block, 1 Rope Swivel, furnished with carrier.
 Weight, 24 pounds.

This Carrier was designed for use in connection with the Loudon Cable Ricker for stacking hay. It operates on a wire cable track ($\frac{5}{8}$ inch or $\frac{1}{2}$ inch diameter) and does its work as nearly perfect as can be. It is built along the same general lines as the Loudon Junior Carrier for steel track. It is compactly and stoutly built, its working parts are extremely simple and it never fails to work right.

The poles at the end and the cable track above also act as guides for building the stack. Stacks of any size up to 60 feet in length can be built with the cable ricker. We furnish the cable in any lengths desired. The cable should be allowed to extend to the ground, on the outside of the poles, at each end, thus forming guys. Forty feet of cable should be allowed outside of the poles at each end. Where 30-foot poles are used and a 50-foot stack is to be built, 140 feet of cable would be required. This allows room to drive the load of hay inside the poles and thus secure a straight lift up to the carrier. Where poles longer than 30 feet are used add 2 feet of cable for each added foot of pole length.

We do not furnish poles as they cannot conveniently be shipped by local freight. Poles should be 5 to 6 inches in diameter at the top and 30 feet or more in length.

This cable ricker is easy to set up, easy to move from place to place, and when not in use the metal parts can be stored in small space. With ordinary care the outfit will last many years.

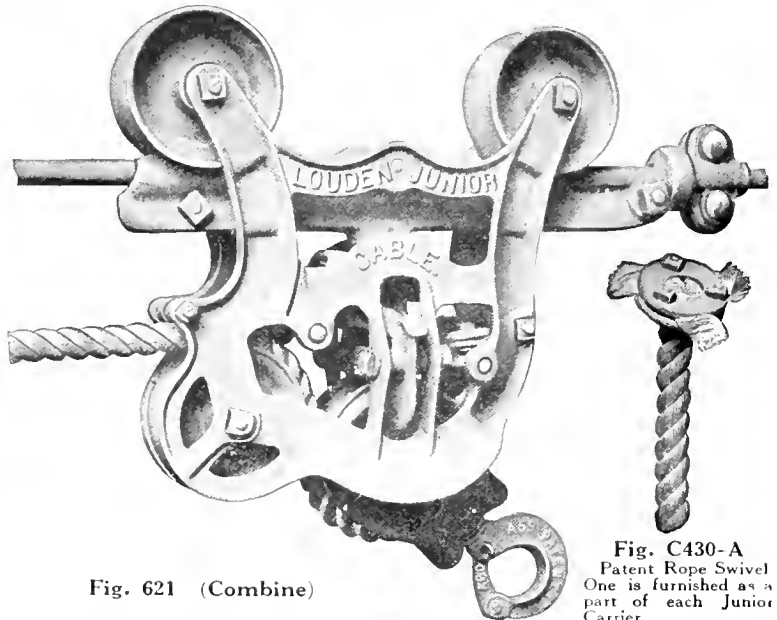

Fig. 621 (Combine)

Fig. C430-A
 Patent Rope Swivel
 One is furnished as a part of each Junior Carrier.

Trip Block. Fig. 801 (March)
 One is furnished as a part of each Cable Carrier.

Louden Cable Ricker Outfit

For Stack 50 Feet Long

1 Loudon Junior Cable Carrier	Fig. 621
1 Loudon 6-Tine Balance Grapple Fork (page 38)	Fig. 351
140 feet $\frac{5}{8}$ -inch Galvanized Steel Wire Rope	Fig. 417
2 High-Grade Draft Pulleys (page 49)	Fig. 468
2 Cable Loop Clamps	Fig. 337
4 Cable Stop Clamps	Fig. 337½

The $\frac{1}{2}$ -inch size Galvanized Steel Wire Rope, Fig. 417, or the $\frac{1}{2}$ -inch size Galvanized Wire Strand may be substituted for the $\frac{5}{8}$ -inch size Wire Rope specified above if desired.
 170 ft. $\frac{3}{4}$ -inch Manilla Draft Rope and 90 feet $\frac{3}{8}$ -inch Trip Rope would be required with this outfit.

We do not furnish poles.



Louden Cable Ricker—Continued

Galvanized Steel Wire Rope

Fig. 417 is a Galvanized Steel Wire Rope. It is composed of six strands, seven wires to the strand, laid about a hemp center, thus forming a rope of 42 wires. It has a breaking strain of 8 tons. It is extremely durable and pliable enough to handle easily. We can furnish this wire rope in $\frac{1}{2}$ -inch or $\frac{5}{8}$ -inch size, as may be desired. We recommend the heavier size. Either Fig. 417 or Fig. 418 may be used as the track for the Carrier. Fig. 417 makes the best track, but is more expensive. Five-eighth inch size: Weight per 100 ft., 76 pounds. One-half inch size: Weight per hundred feet, 61 pounds.



Fig. 417 (May)

Galvanized Steel Strand, $\frac{1}{2}$ -in. Diameter

Fig. 418 is composed of seven No. 8 Wires. Estimated breaking strain about four tons. This makes a cheaper track than the Galvanized Steel Wire Rope and is used quite often. Weight per 100 feet, 50 pounds.



Fig. 418 (June)

Cable Clamps

Fig. 337 is our Wire Cable Loop Clamp and is used to make a loop at the end of the cable. Two of these should be used with each stacker. Weight each, $1\frac{1}{4}$ pounds.

The Wire Cable Stop Clamp, Fig. 337 $\frac{1}{2}$, is placed on the wire cable track at either side of the poles at the end of the stack to hold the upper ends of the poles securely in position. Four of these Clamps are used for each stacker. Weight each, 1 pound.

These clamps are made of malleable iron and are held together with two good, strong bolts, which grip the cable firmly so that they will not slip.



Fig. 337 (Porto)



Fig. 337 $\frac{1}{2}$ (Rico)

Louden Steel Track and Track Fixtures

For Hay Carriers

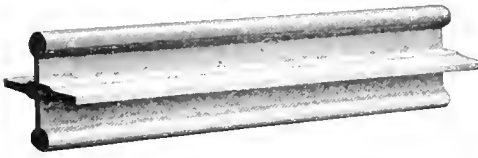

Fig. 571 (Clara)

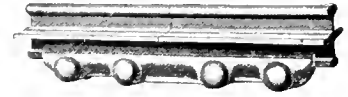

Fig. 550 (Mohler)

Louden Double Bead Steel Track—Fig. 571

Fig. 571 shows a section of Louden Double Bead Steel Track. This track is a special quality high carbon steel. It is 2 inches wide, $1\frac{1}{8}$ inches high and, properly supported every 24 inches, it will safely carry a load of 3000 pounds. Weight, per foot, 2 pounds.

Splice Clamp for Double Bead Steel—Fig. 550

Fig. 550 is the Splice Clamp for Louden Double Bead Steel Track. It is of malleable iron and is held firmly in place on the under side of the track by four bolts. It is easily attached, holds the flanges of the track level and makes it just as strong at the joint as at any other point. Care should be used to see that the nuts on the four bolts are drawn tight. After the nuts have apparently been made tight, the bolts should be set by striking them a heavy blow on the head with a hammer. After this is done it will be found the nuts can be drawn still tighter and the clamps will hold securely.

Enough clamps for the track are furnished with every shipment.
Weight, each, 1½ pounds.

Louden Track Hangers

Fig. 498. Louden Standard Track Hanger for Double Bead Steel Track. Made of malleable iron, in two parts, securely clamped together by short, heavy bolt.

Weight, per dozen, 6 pounds.

Fig. 500. Louden Light Track Hanger for Double Bead Steel Track. Made of malleable iron, in two parts, securely clamped together by short, heavy bolt. The same style as the Louden Standard Hanger except not so heavy.

Weight, per dozen, $4\frac{1}{2}$ pounds.

Fig. 832. Link Track Hanger (5-inch) for Double Bead Steel Track. The clamp is of malleable iron, the link of steel. This hanger is for use any place but is particularly adapted to uneven ceilings. Standard length of link, 5 inches. Can be furnished any length desired.

Weight, 5-inch link, per dozen, 6 pounds.



Fig. 498
(Carson)



Fig. 500
(Camp)



Fig. 832
Pat. Sept. 1, 1908

The Louden Machinery Company,
Fairfield, Iowa

Gentlemen:

I would be pleased to get your new General Catalog.

I have replaced a . . . Hay Carrier and track with the Louden Junior on account of jumping track and bad registering when rope was twisty.

The Louden hugs the rail under all conditions. The swivel takes the kink out of the rope. It is hard to beat.

Yours truly,

Ph. Block.

South Haven, Minn., July 2, 1916

Ruthon, Minn., June 28, 1916.

The Louden Machinery Company,
Fairfield, Iowa.

Gentlemen:

I am pleased to say that I am well satisfied with your barn equipment. I bought from you Hay Track and Carrier, Litter Carrier, Steel Stanchions, Cupolas, etc. Everything is handy and works fine. Will be pleased to recommend it to everybody who wants to improve their barn with this modern equipment.

Yours truly,

Andrew Madsen.

Track and Track Fixtures—Continued



Fig. 780 14-inch (Canna)

Fig. 781 16-inch (Chestnut)

Fig. 780. Straight Hang Hook for wood track. Made of $\frac{1}{2}$ -inch steel rod and furnished in two lengths.

Weight, 14-inch size, per dozen, $10\frac{1}{2}$ pounds.



Fig. 372 (Cairo)

Jointed Hang Hook for Wood Track

Weight, 16-inch size, per dozen, 12 pounds.

Fig. 372. Jointed Hang Hook for wood track. Made of $\frac{1}{2}$ -inch steel rod. Total length, 14 inches. Weight, per dozen, $13\frac{1}{2}$ pounds.

Rafter and Ridgepole Brackets

Fig. 424. Improved Malleable Rafter Bracket, our strongest and best.

Weight, per dozen, $4\frac{1}{2}$ pounds.

Fig. 425. Malleable Rafter Bracket, common pattern.

Weight, per dozen, 3 pounds.

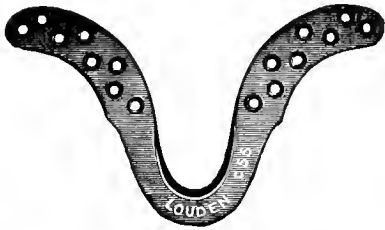

Fig. 424 (Casper)

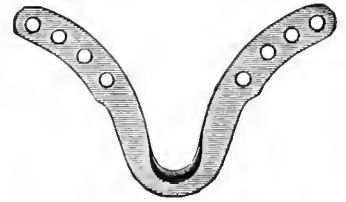

Fig. 425 (Caesar)

Malleable Ridgepole Bracket

Fig. 465. Malleable Ridgepole Bracket, used when the track is hung parallel to a joist or 2-inch timber.

Weight, per dozen, 3 pounds.

Fig. 675. Side Rafter Bracket, used for hanging track to rafters on one side of the roof.

Weight, per dozen, $5\frac{1}{4}$ pounds.

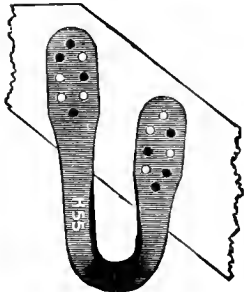

Fig. 675 (Cute)

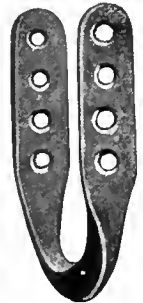

Fig. 465 (Cubeb)

Side Beam Bracket

Fig. 725. Side Beam Bracket for hanging track parallel to the side of a timber.

Weight, per dozen, 6 pounds.



Fig. 373 (Cement)

Barbed Chisel-Point Steel Nail

Fig. 373. Barbed Chisel-Point Steel Nail for putting up rafter or ridgepole brackets. Cut shows actual size.

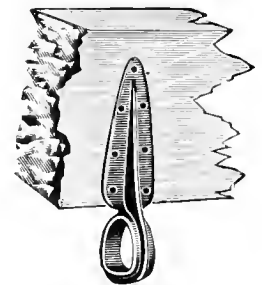
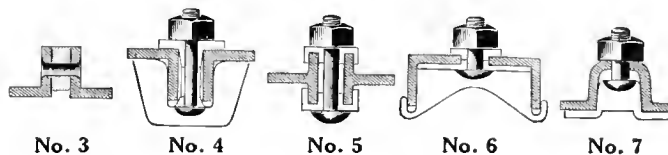

Fig. 725 (Beam)

Other Hay Carrier Tracks



No. 3

No. 4

No. 5

No. 6

No. 7

We do not furnish these tracks, but we fit our Junior Carrier to run on them. In ordering Carrier state the number and size of your track.

No. 3 is 2 inches wide; Nos. 4 and 5, $2\frac{1}{2}$; No. 6, $2\frac{5}{8}$, and No. 7, $2\frac{1}{4}$ inches wide.

Putting Up Hay Carrier Tracks

While a barn is being built and while the shingles or sheeting are within a couple of feet of the comb of the roof, is the best time to install a Hay Carrier Track. At this time it is an easy matter to do the work, as the sheeting forms all the scaffold necessary. To install a Hay Carrier Track after a barn is finished means doing the work from below by scaffold or ladder, depending on the height of the barn.

The track may be hung perfectly level or it may be given a slight incline, making it lower at the point where the track stop is attached and the hay is elevated. The track should always be hung straight and true, and close up to the peak of the barn, but allowing room enough below rafters for the Carrier to run freely. To do this stretch a line from one end of the barn to the other immediately below the peak of the rafters, and nail the Rafter Brackets to the rafters in a straight line.

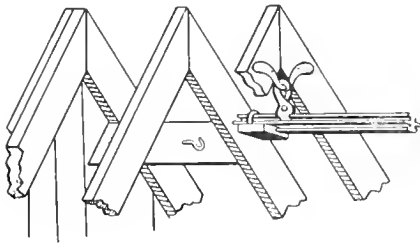

Fig. 617

A collar beam should be spiked to the second pair of rafters from each end, in which hooks are to be screwed for Pulleys, as shown in Fig. 617. This will bring the ends of the track within about a foot of the pulleys as shown in the cut. The collar beams may be 2x6, or 4x4—chamfered off thin at the ends so they can be properly spiked to the rafters. When a piece 2 inches thick is used, an inch piece should be nailed on the back of the center where the screw of the hook goes through, so as to make it 3 inches thick at this place. The collar beams should be about 4 feet long with the ends cut the slant of the rafters, or long enough so the pulley attached to it will let the rope run close to, but not rub on the under side of the track.

(Note—It is a poor plan to screw the hook into one of the rafters, as shown in some hay tool catalogs, because in heavy work it is liable to pull out a single rafter.)

The track should be taken up in sections and hung to the brackets and then spliced together. The Brackets and Track Hangers which support the track may be placed 4 feet apart for light work, but it is better to have a support from every rafter, and for heavy work a hanger and bracket should be put on each side of the rafters where the hay is taken up.

The bolts in the Hangers and Splice Clamps should be drawn up as tight as possible with a wrench, then strike the head of the bolt with a hammer so as to set it, and tighten up the nuts again. When this is done they will not get loose.

If the hay is to be taken in at end of barn, the track should be extended out $2\frac{1}{2}$ to 3 feet when Fork is used and 4 feet when Slings are used. In case the track is installed before the roof is finished, the best plan is to use a good 2x6 or 4x6 long enough to extend out as far as necessary and back in the barn to the third or fourth rafter. Let this extend between the rafters the same as a ridge pole. On this extension support or ridge pole, use our Ridge Pole Brackets.

The extension may be covered if desired. Cut a brace to reach from the outer end of the extension to a point on the rafters even with the side of the door and sheet and shingle over to this brace. This not only serves as a roof, but also as a brace for the extension.

About Rope

Many persons think they should use not less than 1-inch rope on a Hay Carrier. This is a mistake. Use the best grade of manilla rope and never use it heavier than $\frac{7}{8}$ -inch in diameter and $\frac{3}{4}$ -inch diameter rope is better. Do not be persuaded to use either a large or cheap grade of rope. Cheap rope is usually hard twisted and kinks badly. In our fifty years' experience with Hay Carriers we have learned that the $\frac{3}{4}$ -inch manilla rope is the best size to use and in no case should larger diameter than $\frac{7}{8}$ -inch be used. The Pulleys used with Hay Carriers are intended for these sizes of rope and larger will not work so well.

An inch rope should have not less than a 10-inch pulley, and when used on a smaller pulley the bend will be so short that the strands will wear themselves out rubbing on each other, besides it will cost nearly, if not fully, twice as much as three-quarter rope. According to government tests the following are the approximate weights and strength of new manilla rope:

	Pounds
Three-eighths inch trip rope.....	1,275
Half-inch rope, $12\frac{1}{2}$ feet weigh 1 pound; strength.....	1,760
Five-eighths rope, $7\frac{1}{2}$ feet weigh 1 pound; strength.....	3,140
Three-quarter rope, 6 feet weigh 1 pound; strength.....	3,970
Seven-eighths rope, $4\frac{1}{2}$ feet weigh 1 pound; strength.....	4,900
One-inch rope, $3\frac{1}{2}$ feet weigh 1 pound; strength.....	7,050

Louden Power Hoist

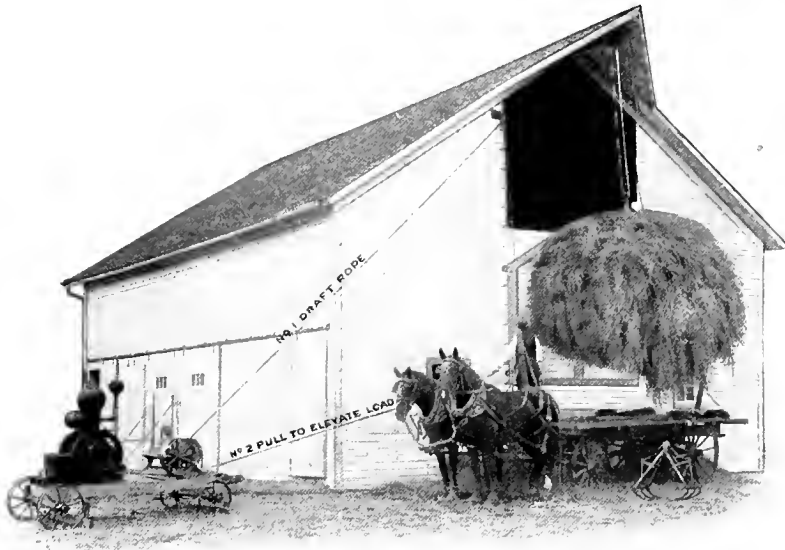

Above illustration shows Louden Single Drum Power Hoist and four horse power gasoline engine lifting 1,000 pounds of hay. The top of the load has been removed with hay fork; a sling is being used for the last load. Note how completely it cleans up the rack.

The clutch on Louden Power Hoists is simple, powerful, and dependable. The contact blocks are of hard maple and in operation are forced into the cone-shaped metal drive. They are accessible by removing a single pin, and are mounted on eccentric benches, making them adjustable to take up the wear. One set of blocks will last several seasons and they can be replaced for a few cents and in ten minutes' time.

When help is scarce and high priced, and all the horses are needed in the field, the Power Hoist comes to the rescue and does the work of both a team and man. Not only that, but it does the same work in about one-fourth the time.

Reduce these facts to figures and you will have the proof of our claim that a Power Hoist will easily pay for itself in a single season.

There is nothing complicated about it—no delicate mechanism. It is just a plain, common sense, sturdy machine built to handle big loads easily and to save time and labor in hay harvest.

There is as much difference between unloading hay with a hoist and with horse power as there is between handling it with horse power and with a pitchfork. Try one out this season.

How long a Power Hoist will last is still to be proved, for the first hoists placed on the market by the Louden Machinery Company, over ten years ago, though much inferior to the later models, are still giving efficient, and satisfactory service.

The convenience of the hoist is increased for general farm purposes by mounting it on the same truck with a portable engine. In this manner it is easily moved from place to place and will be handy for practically all of the heavy lifting about the farm and elsewhere, such as removing wagon boxes and hay racks from wagons, cleaning and digging wells, elevating roots from root cellars, and silage from underground silos. It can also be used successfully for storing ice and for elevating grain with a dump box.

While the Louden Power Hoist is designed primarily for unloading hay, it has been found exceedingly valuable for many other uses. Here is what a builder writes: "We used the Louden Power Hoist in building a concrete stack at the plant of the Iowa Malleable Iron Company. It was most satisfactory and proved a great saving in time and effort. It handled the cement in 800-pound lots as fast as the power mixers were able to deliver it. I am confident from the design and behavior of the hoist that it will handle a ton."

There is a great need for time and labor saving equipment in hay harvest, as the season is short and the crop is valuable. A delay of a few hours may mean a serious loss.

Louden Power Hoists are designed for quick, efficient work. They are so simple that anyone may quickly understand and operate them, and the great numbers in which they are manufactured enable us to put them on the market at a price within reach of every farmer.

The hoist may be used with any kind of power—steam, gasoline or electric. Under ordinary conditions three or four H. P. is sufficient, though five or six H. P. is better. Engine and hoist may be located in any convenient place.

The whole operation is extremely simple. Five minutes' practice will put the operator in perfect control of the hoist and its load. Its action is positive and it always responds to the levers.

Louden Single Drum Power Hoist—Fig. 965

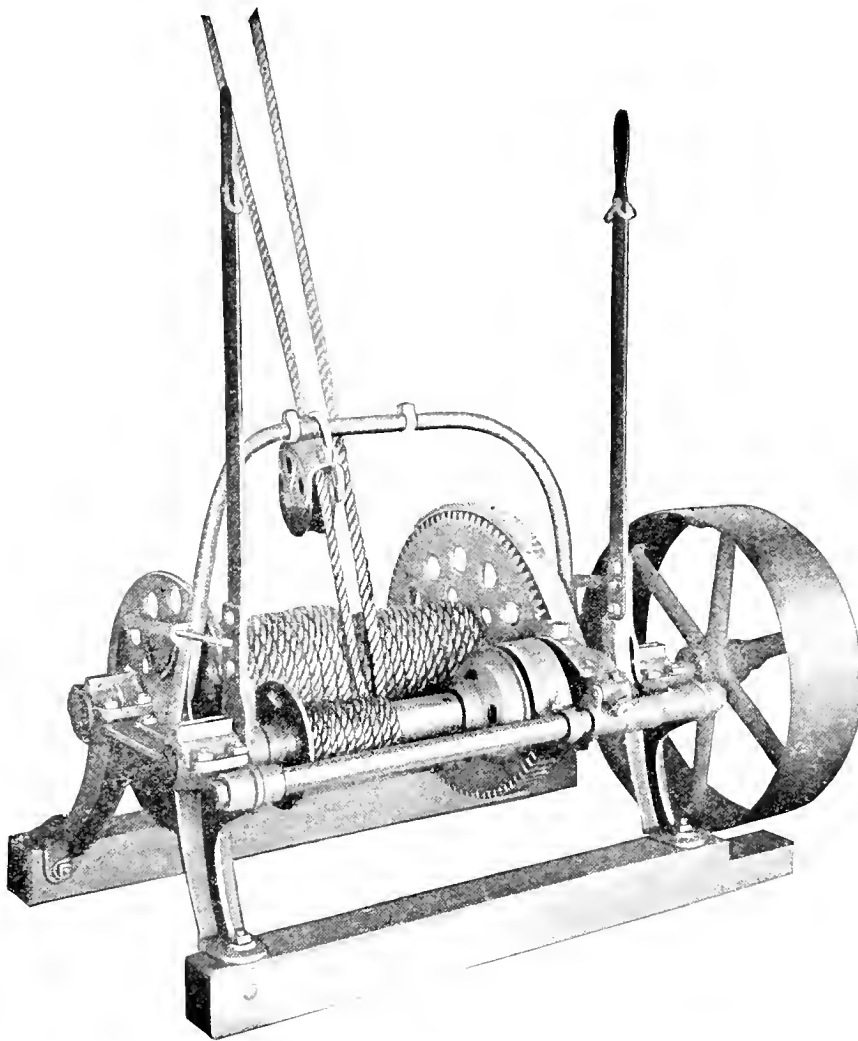

Fig. 965

Specifications

Operation: Load carried in one direction by use of large drum. Empty carrier returned by use of small drum.

Main Drum: Length, 20 inches; diameter, 6 inches; diameter of drum flanges, 15 inches. Capacity; 300 feet of $\frac{3}{4}$ -inch rope or 400 feet of $\frac{1}{2}$ -inch rope.

Return Drum: Length, 11 inches; capacity, 300 feet of $\frac{1}{2}$ -inch rope.

Belt Wheel, pressed steel; diameter, 20 inches; width of face, 6 inches.

Total width, 25 inches.

Total length, 43 inches.

Floor space necessary, 25x36 inches. (Note: Where hoist is mounted on truck, sufficient room for operator to stand should be allowed.)

Weight complete, 308 pounds (ready to ship).

Where the load is to be carried in one direction only, as in an end hoist barn, the Single Drum Power Hoist is used. This hoist has one large drum for elevating the load and carrying it into the mow, and a smaller drum for returning the empty carrier. It is equipped with adjustable friction clutch and band brake.

One of the most valuable features of the Single Drum Hoist is the fact that it may be controlled from the load by means of ropes. There are only two ropes to handle—one to elevate the load and run it back into the mow, and one to operate the return drum and bring the empty carrier back to the wagon.

There is no time lost, no waiting, no changing of team from wagon to draft rope. All that is necessary is to set the fork in the load, or if slings are used, to attach the sling pulleys, then pull slightly on the main friction rope and the load goes up and into the mow. When the load is tripped, a slight pull on the return rope will bring the carrier back.

Louden Triple Drum Power Hoist—Fig. 1132

Specifications

Operation: Load hoisted to desired height by use of large drum. Load carried along track to the right by right hand small drum, or to the left by left hand small drum.

Main Drum: Length, 20 inches; diameter, 6 inches; diameter of drum flanges, 15 inches; capacity, 300 feet of $\frac{3}{4}$ -inch rope or 400 feet of $\frac{1}{2}$ -inch rope.

Small Drums (Each): Length, 8 inches; capacity, 175 feet of $\frac{1}{2}$ -inch rope.

Belt Wheel, pressed steel; diameter, 20 inches; width of face, 6 inches.

Total width, 48 inches.

Total length, 65 inches.

Floor space necessary for base, 38 x 65 inches. (Note: This is actual base. Where hoist is mounted on truck, sufficient room for operator to stand should be allowed.)

Weight complete, 636 pounds.

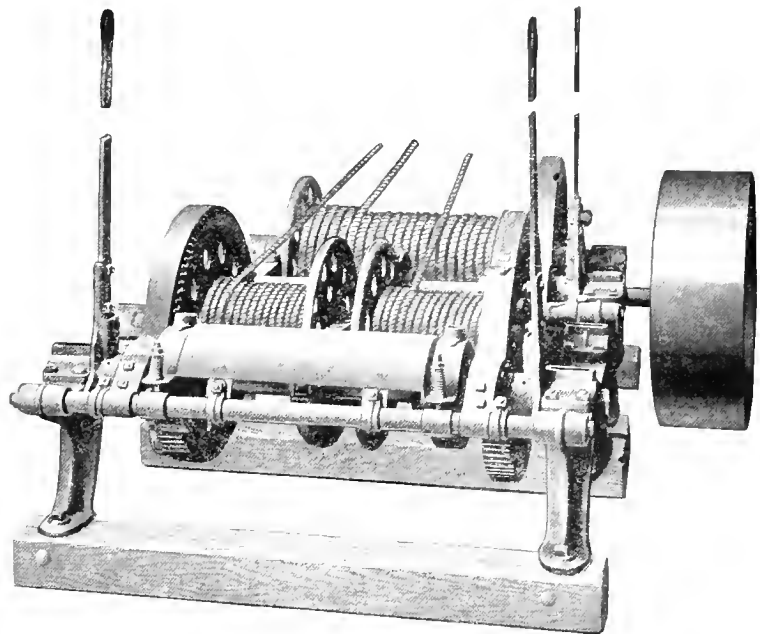

Fig. 1132

In a center drive barn, where the hay is to be stored in mows on both sides of the driveway, or in a Round barn, the Triple Drum Power Hoist should be used. With this hoist and a Cross Draft Sling Carrier, hay can be picked up and carried into either mow at the will of the operator. One load can be put in the right hand mow and the next in the left hand mow, if desired, without the changing of ropes or pulleys.

It is not necessary to carry the load clear up to the track. Unless cross timbers interfere, the hay may be run back into the mow at any height.

The Louden Triple Drum Power Hoist has three complete hoisting drums mounted in the same frame. They operate by friction clutch. Pull the levers to you and they force the clutch into contact; release them and the power is released automatically; push them from you and the brakes are applied.

Complete Power Rigs for Barns

The Power Hoist can be used successfully with any kind of a Hay Carrier. We shall be glad to send you specifications and prices for a complete power outfit for your barn, for either fork or sling use. Tell us whether you take up hay from the end of the barn, or from a center driveway, and mention the carrier and sling (or fork) you prefer. You'll be surprised to learn how little a Power Hoist will add to the cost of your hay unloading outfit, as compared with the saving it effects.

Louden Machinery Company, Fairfield, Iowa
Gentlemen;

Redstone, Mont., May 23, 1913.

My barn is equipped with a Louden Hay Carrier and Slings which I bought of you the fall of 1910. The slings are the largest you sold. I can unload 1,000 lbs. at each pull, easy. I have a very large door, 9x12. I consider the outfit good in every way.

Yours truly,

John H. Schlag.

Using the Power Hoist
in the Field



THE LOUDEN POWER HOIST

In the Field and at the Barn,
or Wherever a "LIFT" Is
Needed, the Louden Power
Hoist "Makes Good."



Using the Louden Power Hoist
at the University of Illinois



Putting Up Ice With the
Louden Power Hoist

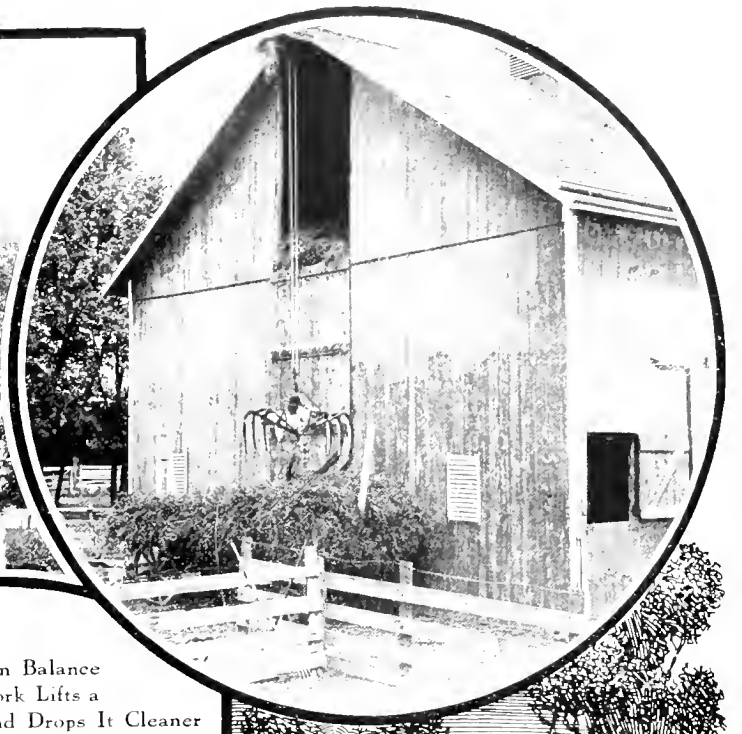

The Louden Balance
Grapple Fork Lifts a
Bigger Load and Drops It Cleaner
Than Any Other Hay Fork Made.

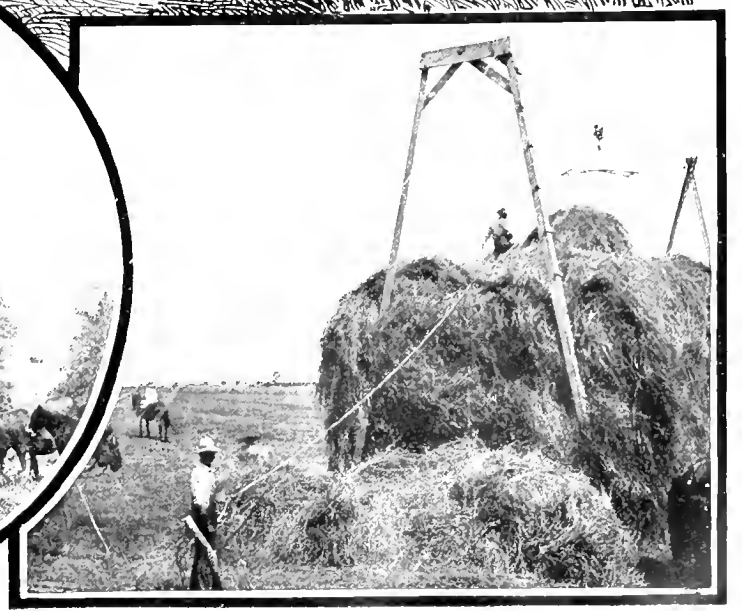
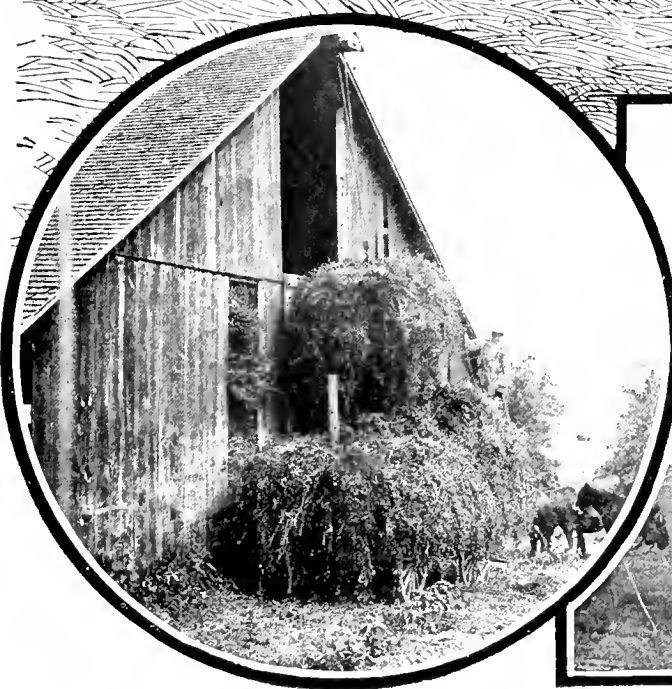
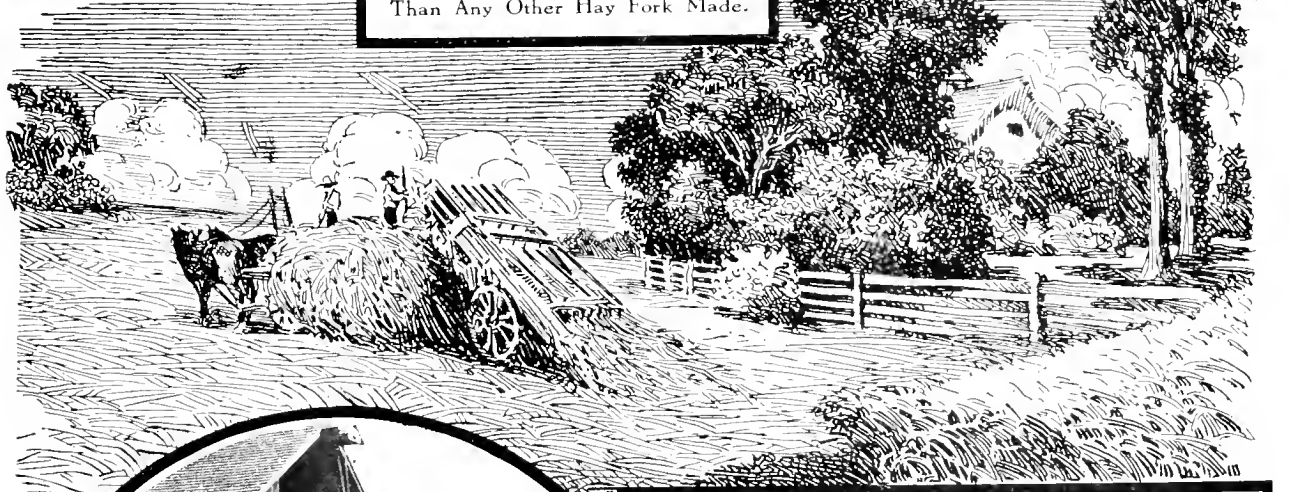

Louden Balance Grapple Hay Forks

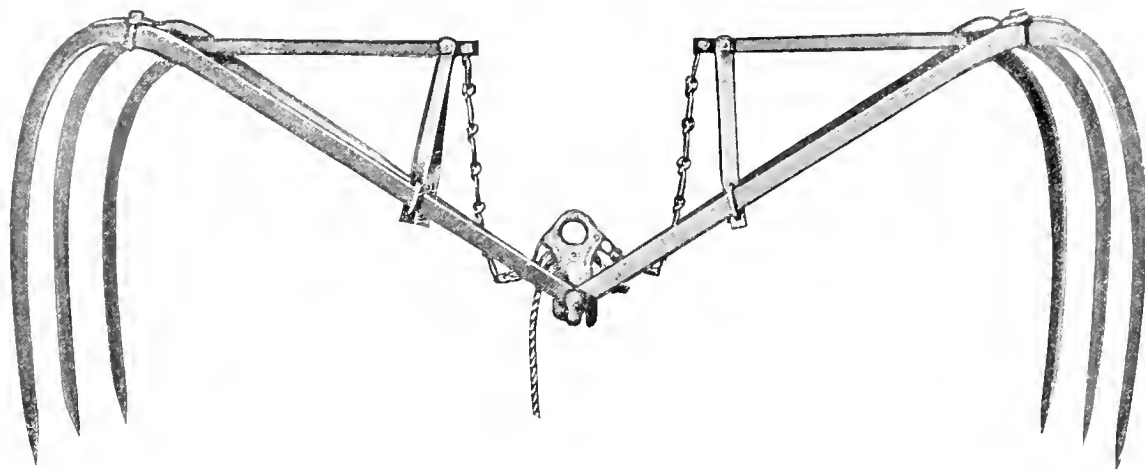

Louden Standard 6-Tine Balance Grapple Fork. Fig. 351. (Planet)

Specifications

Spreads when open, 58 inches.
Width between outside tines, 19 inches.
Tines go into hay 24 inches.
Weight, 45 pounds.

Louden Balance Grapple Hay Forks are in use in all parts of the United States and Canada and in all kinds of hay. Wherever the fork is known customers are enthusiastic in saying it cannot be beaten in any respect by any hay fork that has ever been made.

The arched support is covered by patents and is the greatest improvement ever made in grapple forks. It secures a perfect balance, by means of which the fork can be either opened or closed with the slightest touch. The fork is neat in design and perfectly balanced in all of its parts and adequately strong for any work it will ever be called upon to do.

The material used in the construction of the fork is a special high-grade steel. The steel is very stiff with just enough spring to it so it will not bend or break under the heaviest work. The tines of the cheaper constructed forks soon become bent and twisted out of shape and the fork is made useless. Be sure to get a Louden Fork. They are built of special steel that will hold its shape under the heaviest work.

For Timothy Hay

In long timothy hay, any kind of hay fork can be used with fairly good satisfaction. Much of the success in using a harpoon fork depends on the manner in which the hay is loaded on the wagon. If the man on the wagon knows how and has the time to load carefully, fairly good results are secured with a harpoon fork. The best results, however, are always secured with the Louden Grapple Fork. No difference how the hay is loaded on the wagon, the Louden Balance Grapple Fork handles it right. When using a harpoon fork, there is always a lot of hay that will shake loose and fall back to the wagon or on the barn floor. All of this litter and extra work is saved by using a Louden Balance Grapple Fork.

For Clover Hay

It is annoying and expensive to try to use a harpoon fork for unloading clover hay, and especially so if the hay has become a little dry. As a rule, the fork will pull up through the hay and lift only a very small load. It takes about three

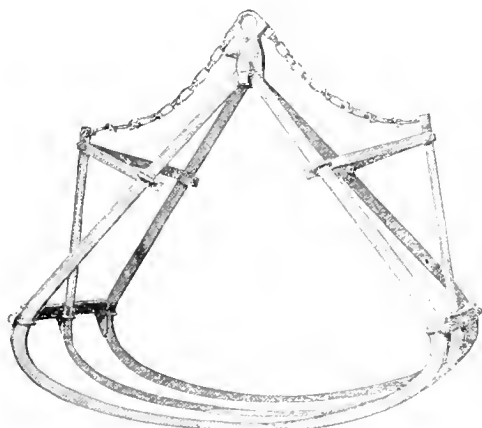

Fig. A-351 6-Tine Fork Closed

Louden Balance Grapple Hay Forks—Continued

times as long and requires about three times as much hard work to unload a load of clover hay with a harpoon fork as it does with a Louden Balance Grapple Fork. The fork puts its arms, so to speak, around a great bunch of hay and binds it in Nature's own way, just as you would pick it up and hold it in your arms. Working in clover hay, the grapple fork will pay for itself in two days' use and will save a lot of hard work.

Alfalfa Hay

The Louden Grapple Fork will make equally as good a showing in one kind of hay as it does in another. It handles them all as nearly the right way as any fork could possibly do. The Louden Grapple Fork, however, is exceptionally strong in alfalfa. It has an affinity for alfalfa hay. It will take alfalfa hay from the wagon and carry it into the hay mow or up on to the stack in such big bunches that users are astonished and delighted with its efficiency. Another thing, when the fork lets go of the hay it spreads it out and makes it easy to mow away.

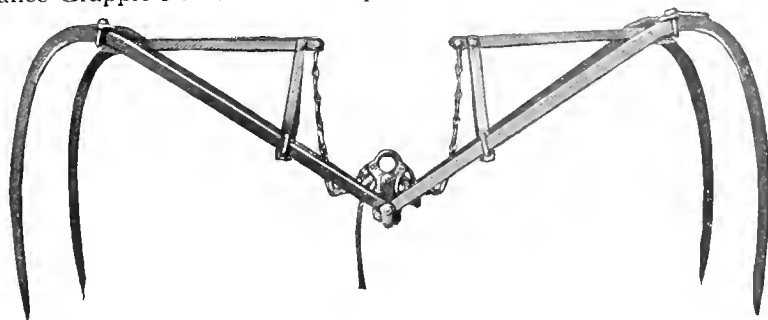

Fig. 648 (Prophet)
4-Tine Fork Open

Louden Standard 4-Tine Balance Grapple Fork

Specifications

Spreads when open, 58 inches.
Width between outside tines, 19 inches.
Tines go into hay 24 inches.
Weight, 40 pounds.

It drops every straw and no hay is left clinging to the tines and bothering in that respect.

Other Hay

The Louden Balance Grapple Fork will handle any kind of hay. In the Far North where the Canada field pea flourishes and in the Far South where the cow pea blooms, the fork is handling the work successfully and growing in popularity each year. The grapple fork will successfully handle threshed straw. Many Michigan customers are using the fork for putting their bean crops into sheds preparatory to threshing. Where there is hay or forage of any kind to handle, the Louden Balance Grapple Fork will do it successfully.

At first thought it might seem a fork of this size would be hard to handle. On the contrary, it is easy to handle. When the hay carrier is returned to the trip block and the fork pulley is released, the fork will settle down to the wagon without any pulling or hauling. The fork goes down open all ready to set into the hay. The man on the load can grasp the fork as it comes down and swing it into position and set it into the hay just as easy and just as quickly as a harpoon fork.

The fork is furnished in three sizes. The Standard 6-tine size is the one most largely used. The 4-tine fork is exactly the same as the 6-tine fork except the center tine is left out on each side. The extra large 6-tine fork is built heavier throughout than the other forks. The Standard size 6-tine and 4-tine forks are large enough for practical use under average conditions. The extra large fork is desirable for clover and alfalfa where extremely heavy loads are to be handled.

Fig. 686 (Farmer)

Extra large 6-Tine Fork Closed

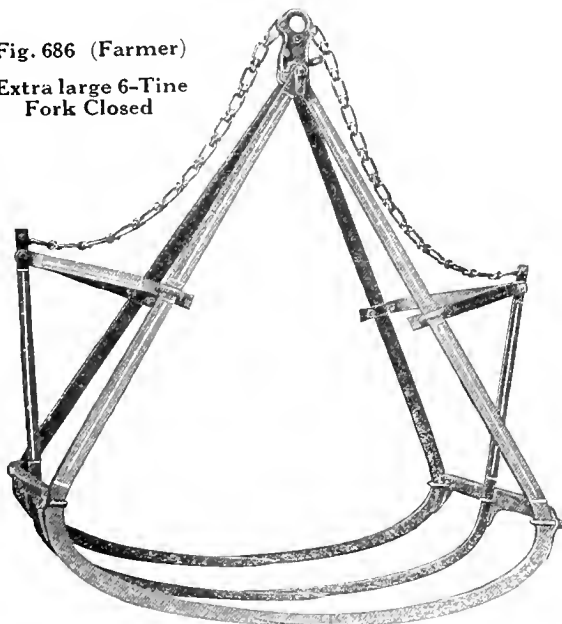

Louden Extra Large 6-Tine Balance Grapple Fork

Specifications

Spreads when open, 6 feet 7 inches.
Width between outside tines, 25 inches.
Tines go into hay 24 inches.
Weight, 50 pounds.

Louden Rocker-Bar Hay Fork—Fig. 1137

The Louden Rocker-Bar Hay Fork is an extra strong fork constructed out of the best quality high carbon fork steel. The fork will enter the hay easily. The tines lock in position either open or closed and the toes cannot double back when entering green or tough hay.

The cross bar on the fork is placed near the top and it gathers the hay or grain from the end of the point instead of from two inches above the bottom. This fork, therefore, has a larger capacity and will carry bigger loads than the ordinary double harpoon fork. When the load is carried into the mow the fork trips easy and will drop its load clean.

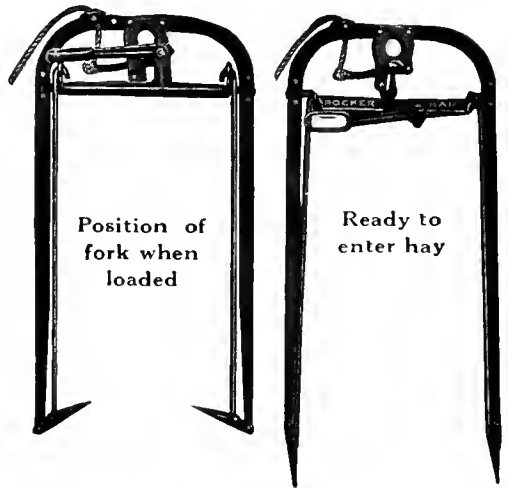

Fig. 1137 (Tuttle)
Specifications

For use in any style of barn.
Can be used with any kind of hay carrier.
Will handle any kind of hay.
Length of tines under head (distance tines go in hay), 31 inches.
The tines and main frame of the fork are of special high carbon fork steel.
The rocker bar, toes and lock are malleable iron.
Weight, 20 pounds.



View B View A
Fig. 350 (Peerless)

Specifications

For use in any type of barn.
Can be used with any hay carrier.
For use in all kinds of hay.
Body and tines of special quality fork steel.
Lock lever of malleable iron.
Length of tines, 24 inches.
Weight, 12 pounds.

Nellis Single Harpoon Fork Fig. 356

Specifications

For use in any type of barn.
Can be used with any hay carrier.
Length of tine, 26 inches.
Weight, 13 pounds.

This is the old original type of hay fork. It will do good service in long, heavy timothy hay. Is not so successful in clover or alfalfa, especially if the hay is somewhat dry.

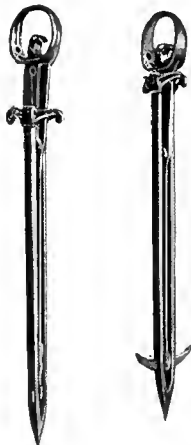

Fig. 356 (Poker)

Louden Triple Harpoon Fork Fig. 350

The Louden Triple Harpoon Fork is the lightest weight and at the same time the strongest harpoon fork made. The fork is all fork. It will go down into the hay clear out of sight, will lift a bigger load and carry the load closer to the track than any other harpoon fork made.

In Fig. 350, View A shows the fork open, ready to enter the hay. The small tapering tines will enter the hay easily. The lever is then pushed downward, forcing the tines into the position as shown in View B. In addition to lifting big loads, the triple harpoon fork will bind its load from top to bottom and prevent the hay from shaking loose and falling back.

This fork can be used with any make of hay carrier and is so strong and compactly built that it will give years of service.

Harris Double Harpoon Fork—Fig. 353

Specifications

For use in any type of barn.
Can be used on any kind of hay carrier.
Made in three sizes:

Standard size.

Length of tines under cross bar, 24½ inches.
Width between tines, 15½ inches.
Weight, 19 pounds.

Intermediate size.

Length of tines under cross bar, 31 inches.
Width between tines, 15½ inches.
Weight, 20 pounds.

Large size (Alfalfa).

Length of tines under cross bar, 32 inches.
Width between tines, 21 inches.
Weight, 32 pounds.

The Harris Double Harpoon is the original harpoon fork. It has been on the market for years and will do good work under all ordinary conditions.

It is built of genuine fork steel, for use in any barn, with any type of hay carrier and in any kind of hay.

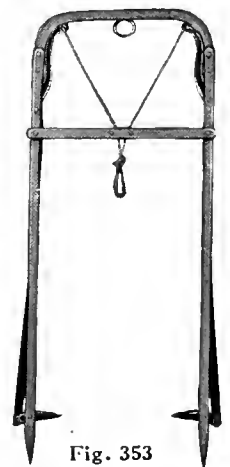

Fig. 353

Louden Hay Slings and Fittings

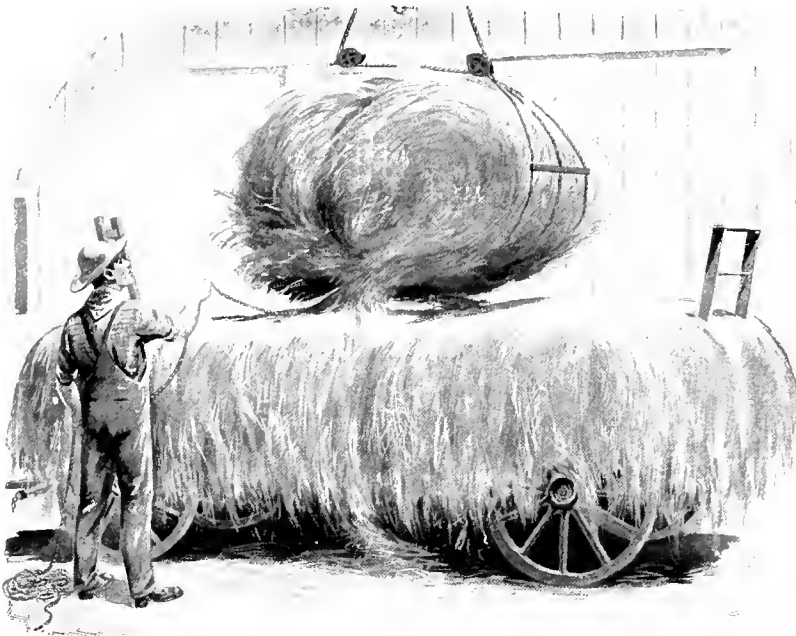

Fig. 319

large scale. Slings spread the full length of a fourteen to sixteen foot rack require about ten feet of space between the track and beams for the load to pass through.

Where a large amount of hay is to be handled, and there is sufficient clearance room through the hay door and in the mow for the large loads, there is no plan that equals the use of slings. Generally three slings are used to a wagon, taking the load into the mow at three drafts, and cleaning the rack perfectly with no shatterings to pick up.

The first sling is placed on the rack, using care to draw the ends out where they can be reached when the hay is piled on. One-third of the load is placed, another sling laid on, again using care to lay out the ends where they will be in reach. Another third of the hay is then loaded and the third sling laid on, when the loading is completed.

In unloading the hay, the sling pulleys are spread apart and one hooked into each end of the top sling. The power on the draft rope gradually brings them together and rolls the hay up as shown in Fig. 319. When the sling is tripped the spring of the hay causes it to unroll and spread in the mow evenly (See Fig. 320), and in practically the same shape it occupied on the wagon.

We were the originators of successful slings and sling carriers, and we warrant ours to be superior to any on the market. We have made a special study of slings and sling carriers, and during the past twenty-five years we have thoroughly tested and greatly improved them.

The Use of Slings

Like everything else, some judgment is required in using slings to obtain the best results. The power available, the length of rack, the size of wagon-loads, and the space above beams in the barn should all be considered and the number of slings estimated and their length adjusted accordingly.

Slings require more room over beams than forks, therefore it is unwise to purchase a sling outfit that hangs away down below the track. We have always watched this point carefully and our carriers and sling attachments have been made compactly so as to occupy the least possible space.

Our experience has been that the rack should not be over sixteen feet long (and fourteen feet is better) unless the barn, elevator and everything else are on a very

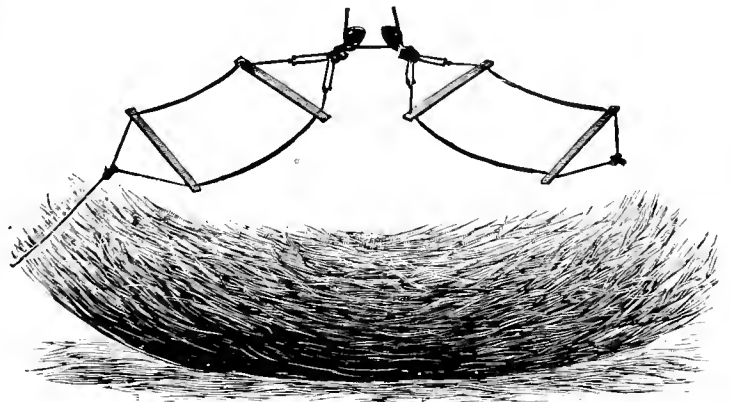

Fig. 320

See How it Spreads the Hay

It is tripped in the center below the hay and separates into two parts, letting hay drop out between them, perfectly clear, and without tilting it on edge, as side trip slings invariably do. The hay being first rolled up, as shown above, **UNROLLS** when discharged and spreads out in the mow or on the stack as wide as the length of the Sling, and in **EXACTLY THE SAME SHAPE** it lay on the load.

Louden Carry-All Hay Sling—Fig. 984

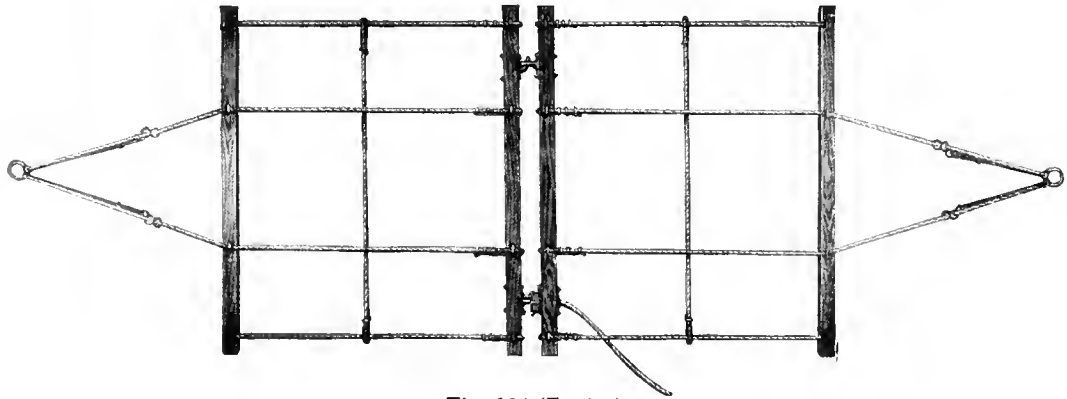

Fig. 984 (Entire)

Specifications

For use in any type of barn.
 Can be handled with any Sling Hay Carrier.
 Standard width of sling, 6 feet.
 Cross bars are of hard wood, 2"x2"x6'.
 Length of sling is adjustable from 15 to 21 feet.
 Main ropes, $\frac{1}{2}$ inch.
 Center cross rope, $\frac{3}{8}$ inch.

Outside rope, $\frac{7}{16}$ inch.
 Trip rope, $\frac{5}{16}$ inch.
 Ropes clamped to cross bars with steel hook bolts.
 Sling coupling of malleable iron.
 Safe working capacity, 2,000 pounds.
 Weight, 36 pounds.

The Carry-All is the popular leader of the widely known and widely used Loudon line of Hay Slings. It is designed for hard, heavy work and yet it works so perfectly and so easily that it is adapted for use anywhere that a hay sling can be used.

This sling is strong enough to permit unloading an ordinary load of hay at a single lift, and can safely be used to handle ton loads. The design of the sling is new. The two cross bars in the center are held close together and are connected by a strong double lock instead of one lock only, as generally used.

This is the ideal sling for handling short growths, such as threshed straw, headed grain, bound grain, dry or short clover and alfalfa. On account of its close construction and the fact that it is connected at two points in the middle, there is no chance for short hay or straw to shatter through or fall out. The sling is equally adapted for handling the long and heavy growths.

The double lock works easily and perfectly. The trip rope attaches to one lock only, the other lock being merely a hook and an eye. A slight pull on the single trip rope releases both locks simultaneously. The lock releases as easy under a heavy load as a light one. In coupling the sling together the hook is inserted in the eye and at the other end the catch is snapped into place. The connection is quickly made and will hold securely.

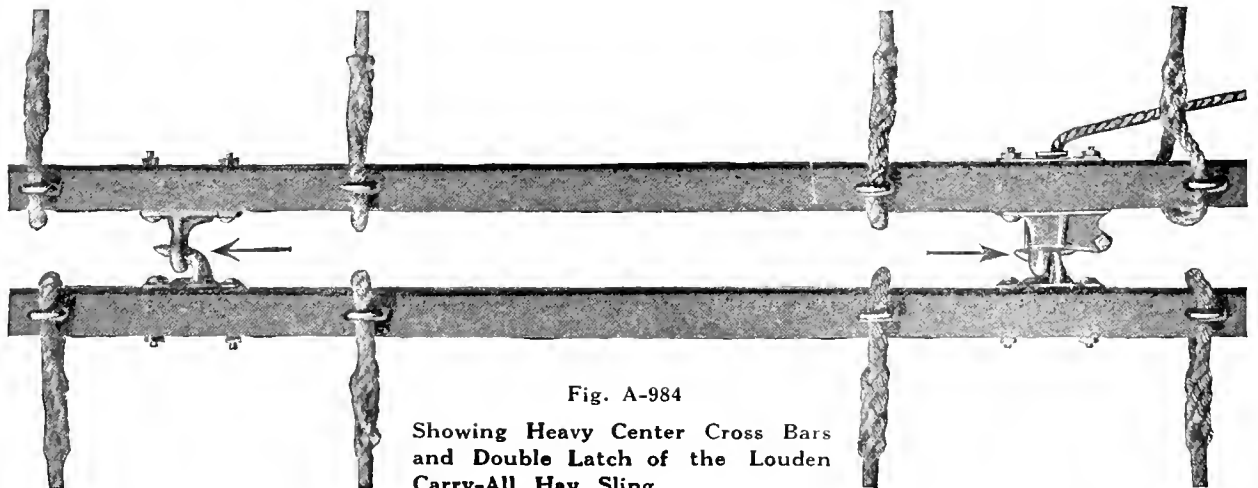

Fig. A-984

Showing Heavy Center Cross Bars and Double Latch of the Loudon Carry-All Hay Sling.

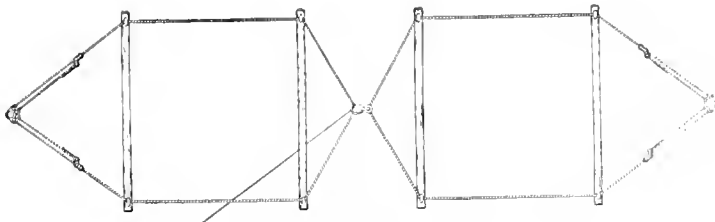

Fig. 666 (4-ft., Moon; 5-ft., Mars)

Specifications

For use wherever a sling can be used.
 Can be handled on any Sling Hay Carrier.
 Furnished in 4-ft. width and 5-ft. width.
 Cross bars are of 2-inch by 2-inch hard wood.
 Length of sling is adjustable from 15 feet to 21 feet.
 Main ropes, $\frac{1}{2}$ inch.
 Trip rope, $\frac{5}{16}$ inch.
 Ropes clamped to cross bars with Steel Hook Bolts.
 Sling coupling of malleable iron.
 Safe working capacity, 1,000 pounds.
 Weight, 4-ft. size, 16 $\frac{1}{2}$ pounds.

Weight, 5-ft. size, 27 pounds.

Louden Three-Rope Sling

The Louden Three-Rope Sling is very strong and dependable. There are three main ropes on each side. This offers a close, compact construction and makes this a desirable sling for handling the shorter growths of hay or threshed straw.

The coupling in the center is made strong for heavy work. The latch holds securely until the proper time when an easy pull on the trip rope will cause the coupling to separate and sling to drop its load.

This sling is adapted for use anywhere that a sling can be used.

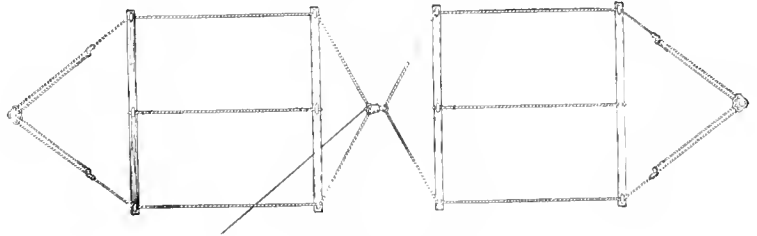

Fig. 600 (Modern)

Specifications

For use in any type of barn.
 Can be handled with any Sling Hay Carrier.
 Standard width of sling, 5 feet.
 Cross bars are of hard wood, 2 inches by 2 inches by 5 feet.
 Length of sling is adjustable from 15 to 21 feet.
 Outside ropes, $\frac{1}{2}$ inch.
 Center ropes, $\frac{3}{8}$ inch.
 Trip rope, $\frac{1}{16}$ inch.
 Ropes clamped to cross bars with Steel Hook Bolts.
 Sling coupling of malleable iron.
 Safe working capacity, 1,400 pounds.
 Weight, 20 pounds.

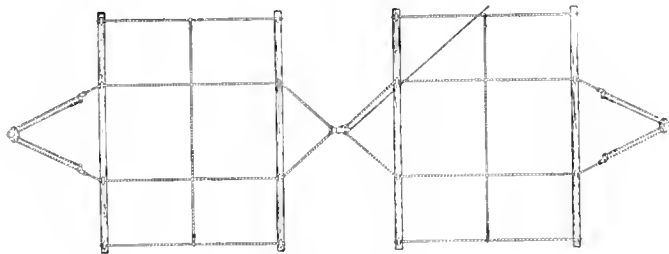

Fig. 324 (Moxie)

Specifications

For use in any type of barn. Can be handled with any Sling Hay Carrier.
 Will handle any kind of hay. Width of sling, 6 feet.
 Cross bars are of hard wood, 2 inches by 2 inches by 6 feet.
 Length of sling is adjustable from 15 feet to 21 feet.
 Main ropes, $\frac{1}{2}$ inch. Center cross ropes, and outside ropes, $\frac{3}{8}$ inch.
 Trip rope, $\frac{5}{16}$ inch.
 Ropes clamped to cross bars with steel hook bolts.
 Sling coupling of malleable iron. Safe working capacity, 1,600 pounds.
 Weight, 28 pounds.

Louden Standard Hay Sling

The Standard Sling is the first successful type of hay sling placed on the market. It is a serviceable sling for general use and will give good wear and service. For extreme short stuff we recommend one of the more closely constructed slings described in these pages.

The Standard Hay Sling has the strength and wearing qualities necessary for satisfactory work, and the moderate price at which the sling is sold has made it very popular among hay growers. The sling is adjustable in length from 15 feet to 21 feet.

Louden California Hay Sling

The California Hay Sling is designed for handling any kind of hay. It is especially recommended for very short hay or bound or headed grain. It is called the California Sling because of the great demand for it in the Golden State.

With the exception of the Carry-All it is the heaviest and most compact sling we make. The coupling in the center is extra heavy and has a strong catch that will hold securely until the proper time when it trips easily.

The sling is adjustable in length from 15 feet to 21 feet and by loosening the hook bolts the cross bars may be adjusted to fit any rack.

Sling Coupling—Fig. 516

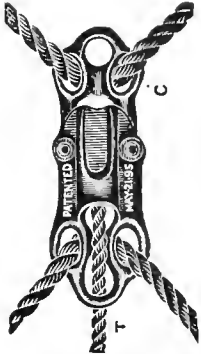

Fig. 516 (Mate)

The coupling used with all Louden Slings except the Carry-All. The coupling is made of malleable iron. The working parts are completely protected and the trip cord can be easily and quickly attached. While the catch is positive and secure, a slight pull on the trip rope will cause the coupling to unlatch. Weight, 2½ pounds.

Louden Handy Hay Sling and Holder Fig. 1106

(For Use With Sling Carrier Only)

Weight, Three-Rope Sling, 4¾ pounds
Weight, Two-Rope Sling, 3¾ pounds

The ease and convenience with which this all-rope sling can be handled has gained for it the appropriate name "Handy". As the sling has no spreaders it can more easily be carried and spread on the rack than slings having cross bars.

The sling trips at the end (or side) instead of in the center as do other slings. The sling can be made up of two ropes or three ropes as desired. The sling holder is provided with three latch hooks to carry either style sling.

The Louden Handy Hay Sling is the only sling of its kind that is made adjustable so it can be lengthened or shortened to fit any length rack. It will handle any kind of hay or forage. The sling is easily drawn out from under hay in the mow and can be used in filling the barn full up to the comb. Three slings are generally required for each wagon.



Fig. 1106 (Handy)



Fig. 1106-A
Weight
2 pounds

Only one holder (Fig. 1106-A) is required for each carrier. The holder is made of malleable iron. The holder is intended for use with right angle or parallel sling pulleys. The latch or trip in the holder is quickly set and is secure and will trip easily at the proper time.

Side Trip Sling Holder

(For Use With Fork Carrier Only)

Fig. 328 represents our Side Trip Sling Holder, and Fig. 329 is the same with ropes attached. The ropes are laid crosswise on the rack under hay to be elevated and the ends are drawn up by hand. The looped ends are slipped over the trip Y, which is then locked. The other ends are usually drawn through the hook H and tied in a bow knot. Four sets of ropes to a wagon are generally used.

Weight, 2¼ pounds.

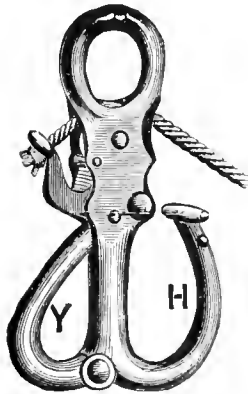

Fig. 328 (Martyr)



Fig. 329

How To Securely Clamp Metal Parts Together

- 1st. Put all the clamps on loosely so the parts can be easily racked to line them up properly.
- 2d. After they are all in proper position draw the nuts up tight with a wrench.
- 3d. When tightly drawn, hit the heads of the bolts heavily with a hammer to set them.
- 4th. Tighten up the nuts again with a wrench as much as can be safely done.

When treated this way the bolts will not be liable to get loose but without hammering their heads so as to solidly set them they will be liable to work loose under a strain and especially so under a jar. This is important in attaching clamps of any kind, especially splice clamps for overhead track, couplings and clamps for connecting the tubing of animal stalls and pens together, especially pens to hold vicious bulls and for other purposes requiring solidity and durability of structure.

Louden Fork Clevis—Fig. 652

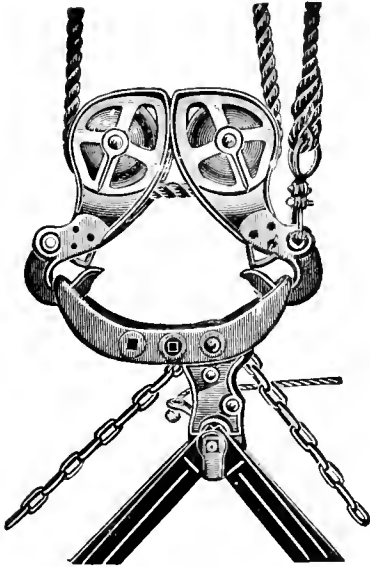

Fig. 652 (Maroon)

Specifications

Can be used with Parallel or Right-angle Sling Pulleys.
 Can be used with any style of fork.
 Made of malleable iron.
 Weight, $2\frac{1}{4}$ pounds.

Figs. 652 and 653 represent our Fork Clevis attached to sling pulleys and by means of which a hay fork can be used with Louden Hay Sling Carriers. The Fork Clevis is attached to the top of the fork by means of a heavy bushing placed between the two sides of the clevis and held in place by a bolt. The clevis with the fork attached can be hooked on to the sling pulleys in a moment. There is no loss of time making the change from sling to fork.

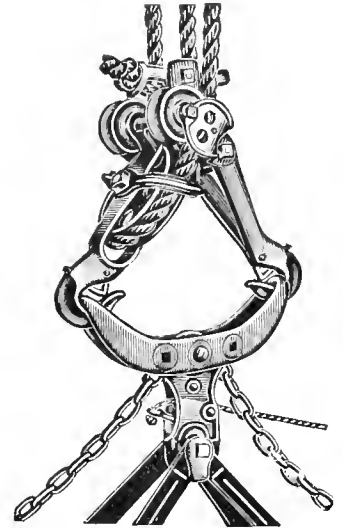

Fig. 653 (Maroon)

This clevis is largely used where a sling carrier is in the barn and the practice is followed of removing the top of the load with a fork and cleaning up the rack with a sling. The fork can be hung in the middle or one-third way from one end as may be necessary to balance it with double or triple draft. Fig. 652 shows the clevis in use with our Parallel pulleys and Fig. 653 with our Self-Locking Pulleys. The upper end of Louden Balance Grapple Fork is shown in the illustrations.

Louden Sling Binding Pulley—Fig. 332

Many farmers and hay growers follow the practice of removing the top of the load with a fork and cleaning up the rack with a sling. Or, sometimes, it is necessary to haul a load of dry, fine straw that cannot well be handled with a fork, and it is desired to use a sling.

The Louden Sling Binding Pulley is the tool to use for this work.

It can be used with any Fork Carrier having not larger than 4-inch fork pulley and without any change of rope or re-threading of carrier. In the illustration the Pulley A represents the regular fork pulley used with the carrier. The Pulley B is the Sling Binding Pulley. The Fork Pulley A is slipped through the Sling Pulley B, the two pulleys are then spread apart and hooked into the two ends of the sling. When the load starts to lift, the Fork Pulley A slips back through the Sling Pulley B and registers in the carrier. This binds the load securely and the carrier supports the load as it is being carried back into the mow the same as in ordinary work. The Pulley B is the only extra part necessary to handle. This can be kept hanging within easy reach of the man on the load, so no time is lost in changing from fork to sling.

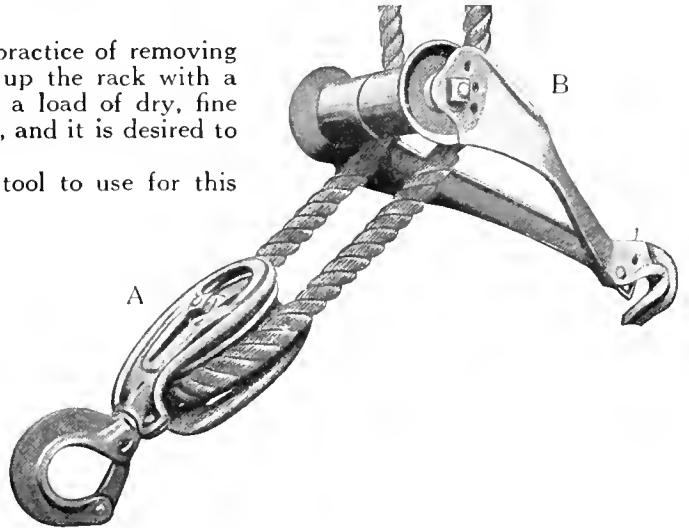

Fig. 332 (Mentor)

Specifications

Frame made of malleable iron.
 Wheels special quality gray iron.
 Weight (part B only), 5 pounds.

Louden Self-Locking Sling Pulleys—Fig. 330

(Right Angle Sling Pulleys)

Specifications

Furnished with registering head to fit any Hay Carrier. Used with Louden Carriers, slings are carried within 20 inches of the track.

Pulleys are of malleable iron except the wheels. Wheels are of special quality gray iron. Weight, 10 pounds.

It is sometimes desired to use Hay Slings in barns already equipped with Fork Carriers. If the track is good and the carrier is strong and sturdy, this can be done. Figs. 330-331 illustrate the Louden Self-Locking Sling Pulleys. With these pulleys slings can be handled with any hay carrier, using a registering head. We can furnish the pulleys fitted with any of the registering heads illustrated on opposite page and new heads are made to fit other carriers when there is sufficient call for them.

Our advice to customers who wish to use Hay Slings and who have a considerable amount of hay to handle, is to buy a regular sling carrier built for heavy work.

However, we sell thousands of these sling pulleys for use with fork carriers of all kinds and they always give good satisfaction so long as care is used not to overload the carriers.

Fig. 422 represents a set of Louden Self-Locking Sling Pulleys in use with our Louden Junior Fork Carrier.

The pulleys are shown locked together but not yet registered in the carrier. Fig. 330 is a front view of the pulleys locked together and Fig. 331 is a side view of the pulleys spread apart to connect to the sling. As the load is elevated, the two parts of the sling pulley come together and lock as shown in Fig. 330. The registering head then enters the carrier and is engaged by the grappling hooks the same as the fork pulley when a fork is being used.

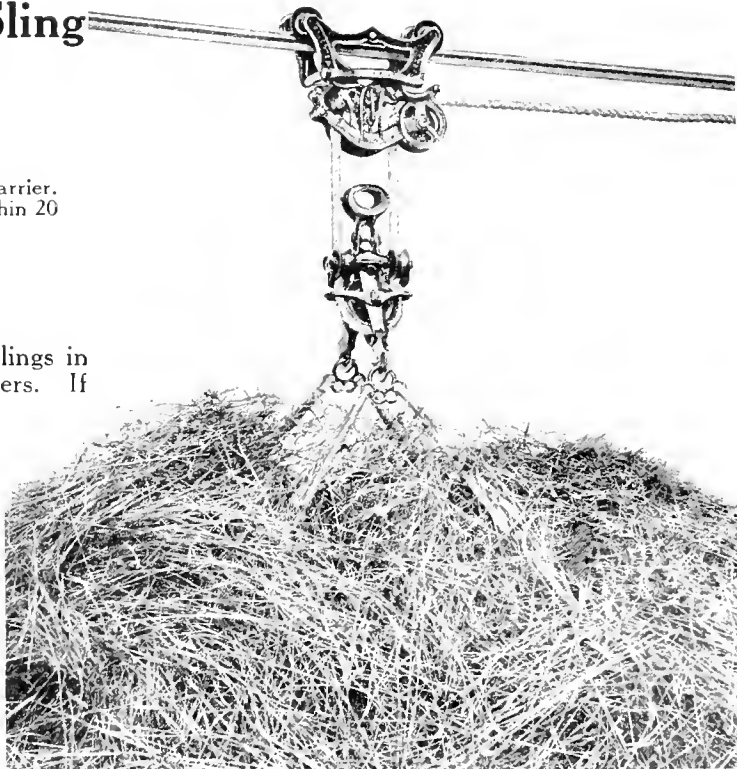

Fig. 422

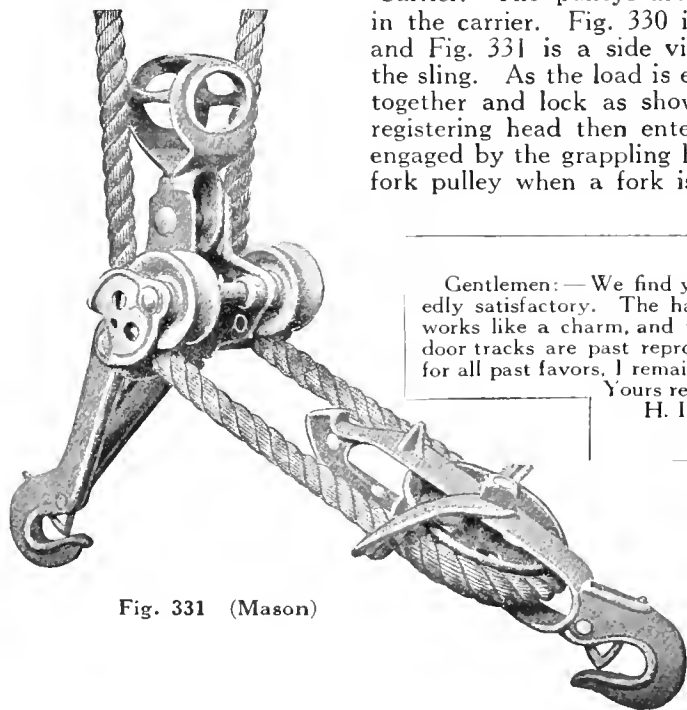

Fig. 331 (Mason)

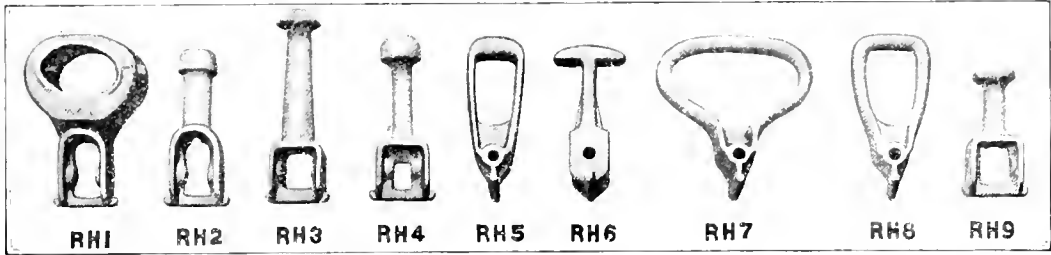

Fig. 330

July 30, 1914.
Gentlemen:— We find your goods unexpectedly satisfactory. The hay track and carrier works like a charm, and the hanger and barn door tracks are past reproach. Thanking you for all past favors, I remain,

Yours respectfully,
H. I. Armour,
Rising Sun, Md.

Registering Heads for Louden Self-Locking Sling Pulleys



RH1 **RH2** **RH3** **RH4** **RH5** **RH6** **RH7** **RH8** **RH9**
 Louden Hall Star Leader Church Porter Milwaukee Reversible Milwaukee Swivel Burbanks Eclipse

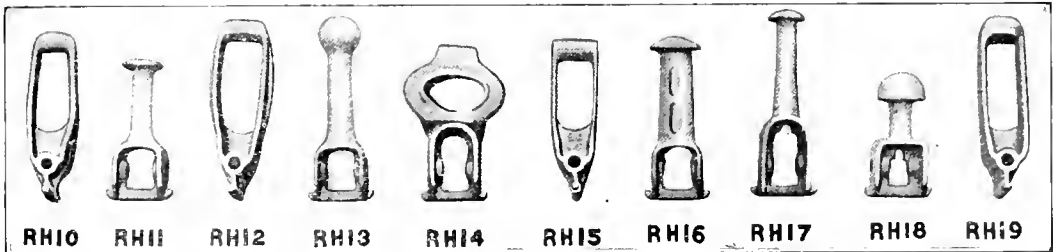

RH10 **RH11** **RH12** **RH13** **RH14** **RH15** **RH16** **RH17** **RH18** **RH19**
 Ney and Superior Osborn Jordan C., B. & Q. Myers O. K. Ashland Myers Combination Ideal and Jumbo Janesville Deadlock Haymaker or Imperial

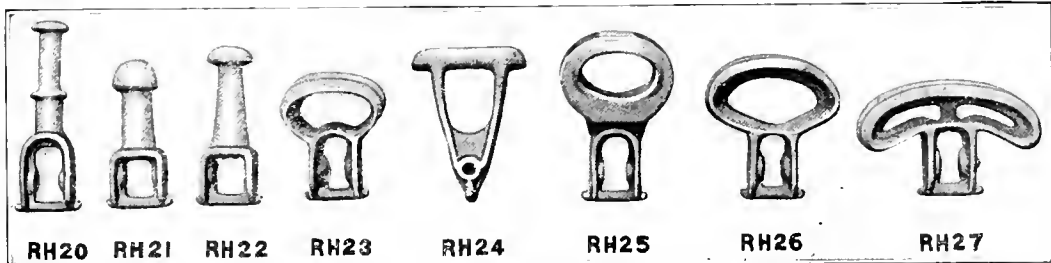

RH20 **RH21** **RH22** **RH23** **RH24** **RH25** **RH26** **RH27**
 Porter's Swivel Boyd Diamond New Diamond Boyd Reversible Unloader Clover Leaf W. B. Acme 1st Pattern W. B. Acme Improved

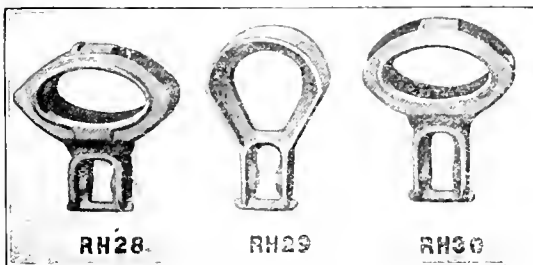

RH28 **RH29** **RH30**
 Louden Senior Meadow King Meyers Unloader 7-in. Sheave

The illustrations above show the Registering Heads which we make for our Self-Locking Sling Pulleys. These heads will fit the different carriers named.

When in doubt as to the head required, send the fork pulley of your carrier by express, prepaid, and we will fit the pulley with the proper head and return fork pulley with order.

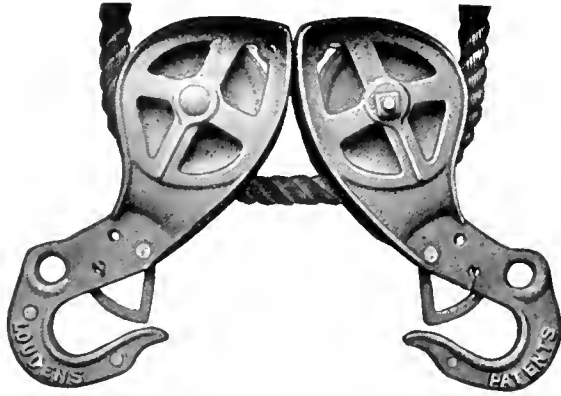

Fig. 649 (Mastiff)

Louden Parallel Sling Pulleys Fig. 649

Specifications

Can be used with any Louden Hay Sling Carrier.
 Can be used with any center-trip Hay Sling.
 Frame of pulley of refined malleable iron.
 Rope wheels of special quality gray iron.
 Diameter of Rope Wheels, 4 inches.
 Weight per pair (2 pulleys), 10½ pounds.

The Louden Parallel Sling Pulleys are built for service and wear and for use wherever there is need for a sling pulley. The frame of the pulley is of malleable iron with heavy reinforcing ribs at points where strength is needed.

The meeting edges of the pulleys are provided with wide flanges and the upper ends are closed so they cannot run into each other. The rope wheels and the pulley frames are made smooth and free from sharp corners so they will not wear the rope. The hooks are fitted with self-acting safety stops to prevent the slings from becoming detached. Eyes are provided in the lower end of the pulleys into which the end of draft rope can be fastened when it is desired to rig the pulleys triple draft.

Louden Senior Parallel Pulleys Fig. 650

Specifications

For use with cable draft rope.
 Can be used with any center-trip Hay Sling.
 Frame of pulley of refined malleable iron.
 Rope wheels of special quality gray iron.
 Diameter of Rope Wheels, 5 inches.
 Weight, per pair (2 pulleys), 15½ pounds.

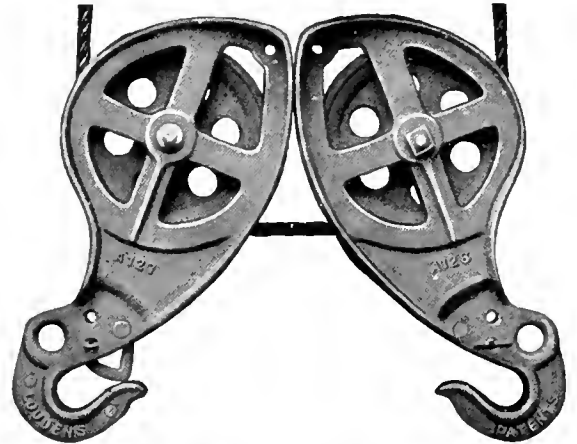

Fig. 650 (Miller)

The Louden Senior Parallel Sling Pulleys are of the same design as the regular parallel sling pulleys except they are larger and heavier and are fitted with sheaves or rope wheels for 3/8-inch cable draft rope instead of manila rope. The Senior pulleys are desirable where the work is extremely heavy.

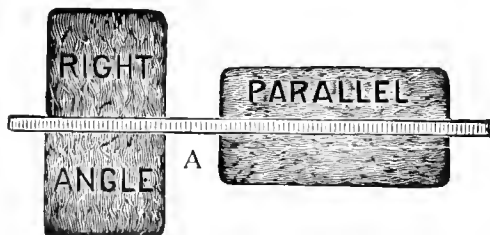

Fig. 412

Right Angle and Parallel Pulleys

Fig. 412 shows how the hay is deposited in the mow with respect to the Track A when Right Angle or Parallel Sling Pulleys are used. The Right Angle Pulleys spread the hay wider in the mow than the Parallel Pulleys, unless the latter are twisted quarter round before tripping the sling.

Louden High-Grade Pulleys

Patented May 20, 1902.

Use of Pulleys

Every article about a haying outfit should be first-class, strong and durable. When hay tools break in the haying season it means delay, loss of time, frequently loss and injury of hay, and occasionally serious accidents. Such breakages occur chiefly from the use of poor pulleys. It is therefore important that every user of Hay Tools should buy first-class pulleys.

We make a specialty of High-Grade Pulleys which we illustrate on the following pages. We have given special care and attention to the designing of our pulleys, taking into consideration every detail which would add to their merits. In making the eye and the frame we have placed the metal where the strength is needed, and cut it out where it is not needed, so that the pulley may have all the strength necessary, and at the same time be light and neat and not cumbersome to handle. The frame is made in two parts, held together by rivets and bolts. The wheel or sheave turns on a large malleable bushing, recessed into the frame of the pulley and held in position by a bolt. This gives the pulley great strength.

We handle the cheaper grade pulleys, but we cannot too strongly recommend the use of the best pulleys that can be purchased. Do not be persuaded to use cheap pulleys. The saving is only a trifle in the first cost, and the use of cheap pulleys may mean much damage and loss in harvest. The best is the cheapest in the end.

Louden High-Grade Pulleys have, through many years of continuous, satisfactory service, proved themselves superior in design, construction and durability. They have no sharp corners to wear the rope. The eyes are heavily ribbed and have tubular swivels, which add materially to their strength and efficiency.

The wood sheaves turn on large metallic bushings, recessed into the sides of the pulley frames, held in place by heavy bolts. The bearings in the iron sheaves also turn on large bushings which support the weight of the load and protect the connecting bolts from wear.

The sheaves in the four pulleys shown on this page are interchangeable. Fig. 553 is a sectional view of the Iron Sheave Pulley, showing the tubular eye, the projection in the frame which protects the rope from the edge of the sheave, the malleable bushings on which the sheave turns, the recess in the frame in which the bushing rests, and the bolt that holds it in place. This shows the sturdy construction which characterizes all Louden High-Grade Pulleys and gives them marked superiority over all others.

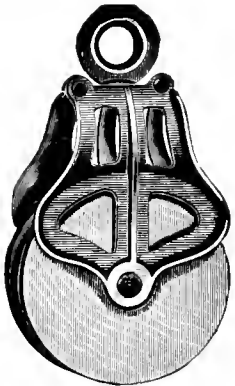

Fig. 467 (Paragon)
Fig. 467. Knot Passing Pulley. Malleable frame, swivel eye, 6-inch hard maple sheave seasoned in oil.
Weight, 3¼ pounds.

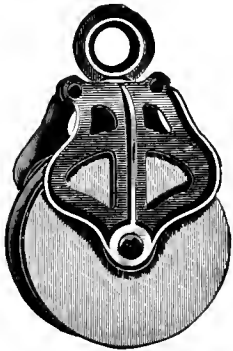

Fig. 468 (Prelude)
Fig. 468. Draft Pulley. Malleable frame, swivel eye, 6-inch hard maple sheave seasoned in oil.
Weight, 3 pounds.



Fig. 553
Sectional View of Louden High Grade Pulleys.

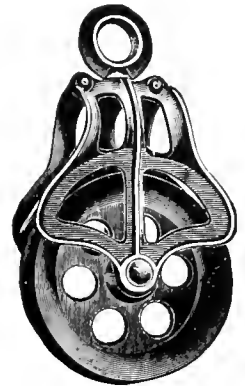

Fig. 494 (Passport)
Fig. 494. Knot Passing Pulley. Malleable frame, swivel eye, 6-inch diameter sheave. Sheave made of special quality gray iron.
Weight, 5½ pounds.

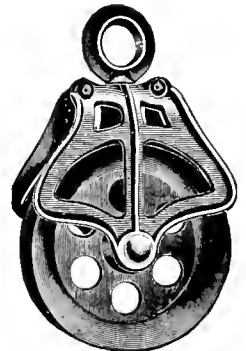

Fig. 495 (Password)
Fig. 495. Draft Pulley. Malleable frame, swivel eye, 6-inch diameter sheave. Sheave made of special quality gray iron.
Weight, 5½ pounds.

Louden Mammoth Pulley—Fig. 519

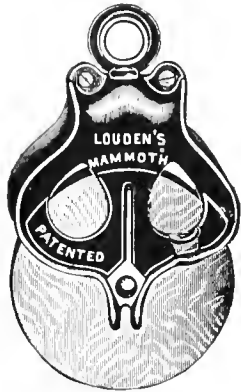

Fig. 519 (Pencil)

Specifications

Weight, 5½ pounds.

The Mammoth Pulley is made for heavy work. It has a select 7-inch hard maple sheave, seasoned in oil. It has the tubular swivel eye, large malleable bushings on which the sheave turns, the guard over the edge of the sheave to prevent the rope from cutting,—in fact all of the good features of the pulleys previously described, and in addition is larger and stronger. The large sheave makes this pulley easy on the rope.



Fig. 579 (Perfect)

Specifications

Fig. 579. Cable Pulley. Malleable iron frame. Swivel eye. 8-inch diameter sheave. Sheave is made of special quality gray iron. Weight, 9¼ pounds.

Cable Pulleys—Figs. 579-651

Our Cable Pulleys are made with malleable iron frames and have all the good features of our Rope Pulleys—the tubular swivel eye, frame made in two parts, held together with bolts and rivets, large malleable bushing, held in recess in the pulley frame by a bolt, and projections or guards in the opening of the frame to protect the cable from the edge of the sheaves (see page 49, Fig. 553). We make them with iron wheels only, and the pulley throughout is made extra strong. The hole in the sheave is chilled and turns on a malleable bushing. The groove in the sheave is made suitable for ¾-inch diameter wire cable.

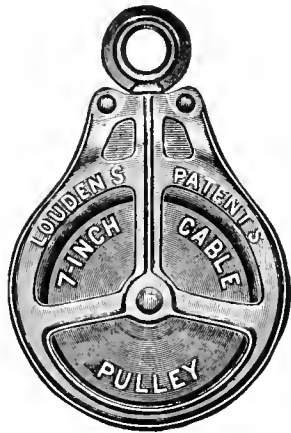

Fig. 651 (Kuroki)

Specifications

Fig. 651. Cable Pulley. Malleable iron frame. Swivel eye. 7-inch diameter sheave. Sheave made of special quality gray iron. Weight, 9 pounds.

Louden Upright Floor Pulley Fig. 364

This pulley is designed for use on the floor and in other places where common pulleys lop over when the rope is loosened, thus causing the rope to rub and bind in the pulleys. Every user of Hay Tools knows this is annoying and expensive.

Our upright Floor Pulley does not lop over or unhook, nor bind and hold the rope while the carrier is being drawn back. A slot in the bottom of the pulley slips over the head of the skein bolt, which is screwed into the floor and while holding the pulley upright, lets it turn freely in any direction. They may be used with as good results on a wall or a post in a vertical or inclined position, as in a horizontal position.

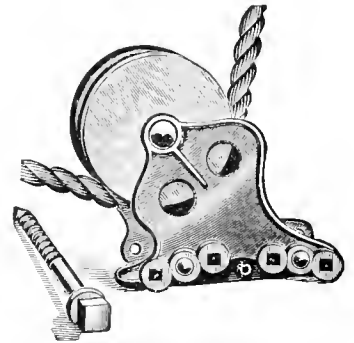

Fig. 364 (Palace)

Specifications

Fig. 364. Floor Pulley. Malleable iron frame. 4½-inch diameter sheave. Sheave made of hard maple seasoned in oil. Attaches to floor with lag screw. Weight, 5½ pounds.

Louden Machinery Co., Fairfield, Iowa.
Gentlemen:

Ridgway, Ill. Feb. 9. 1914.

I received the large Grapple Fork you shipped January 10th, which was in good condition. I am well satisfied with the fork. I have been handling short wheat straw. I was surprised to see the fork handle the loose straw so well, which means that I am more than satisfied with it.

Yours very truly,

Kelly E. Moye.

Some Special Pulleys



Fig. 366
(Togard)



Fig. 359
(Pointer)



Fig. 435
(Perch)



Fig. 360
(Parasite)

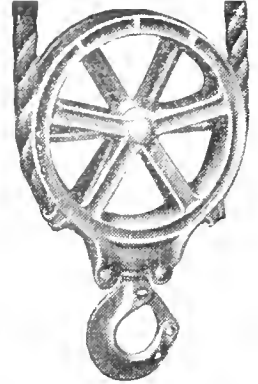

Fig. 1139

Fig. 366 is our Fork Pulley used with all of our Fork Carriers except our Senior Carrier, Fig. 1100. It has a 4-inch sheave and a strong malleable frame with safety hook that has the tubular swivel. Weight, $3\frac{3}{4}$ pounds.

Fig. 359 is our Return Pulley with 3-in. wood sheave for $\frac{1}{2}$ -in. rope and smaller. Made the same as our High-grade pulleys on page 49. Weight, 1 pound.

Fig. 435 is our Comb Pulley, for lifting cord to pass over, in the peak of barn. It has $1\frac{3}{4}$ -in. iron sheave. Weight, $\frac{5}{8}$ pound.

Fig. 360 is our Malleable Case Check Pulley with $1\frac{1}{4}$ in. iron sheave. Built extra strong for $\frac{3}{8}$ -in. rope and smaller. Weight, 6 ounces.

Fig. 1139 is our Fork Pulley used with our Senior Fork Carrier only. It has a 7-in. sheave made of special gray iron. Both Fork Pulleys are built on the same line as our high grade pulleys. Weight, 6 pounds.

Louden Snatch Pulley Block—Fig. 623



Fig. 623 (Pawn)
Specifications

Frame made of malleable iron.
Rope wheel special quality gray iron.
Rope wheel 4 inches diameter.
Weight, $4\frac{1}{4}$ pounds.

The Snatch Pulley Block shortens the distance the horse travels. After passing through the lower draft pulley, the end of the rope is made fast to the barn wall or a stake driven in the ground. Before making the end of the rope fast a washer should be slipped on and a knot tied in the rope, as shown in the illustration. The Snatch Pulley can then be put in place on the rope. One side of the pulley is open so the rope can be thrown off and on. When the load is pulled into the mow, the rope can be thrown off the pulley and the fork returned to the wagon without waiting for the return of the horse.

Cast Frame Pulleys

Fig. 522. Cast Frame Draft Pulley, 6-inch wood sheave, has large, loose pin, self-oiling axle. Weight, $3\frac{1}{4}$ pounds.

Fig. 729. Cast Frame Knot Passing Pulley, 6-inch wood sheave has large, loose pin, self-oiling axle. Weight, 4 pounds.

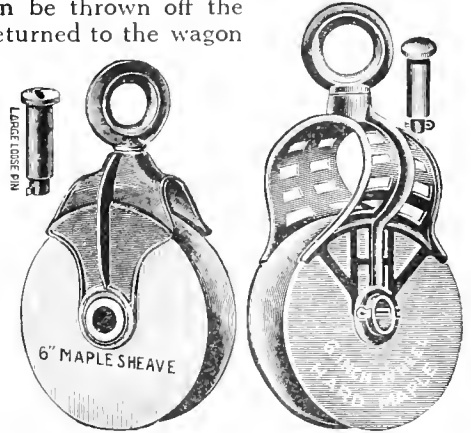

Fig. 522 (Presto) Fig. 729 (Peter)

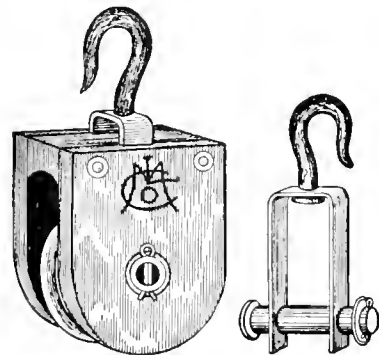

Fig. 641 (Ray)

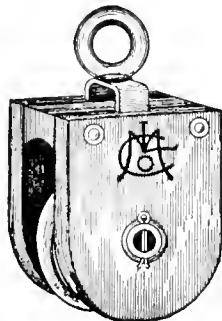

Fig. 642 (Frank)

Wood Frame Pulley—Reed Pattern

The frame is made of hard wood held together by rivets at the top. It is provided with wrought steel yoke to support the large, hollow, self-lubricating axle on which the sheave turns. Sheaves made of hard maple. A good strong pulley. Fig. 641 shows the pulley with steel hook. Fig. 642 shows pulley with malleable eye. Weight, $2\frac{3}{4}$ pounds.

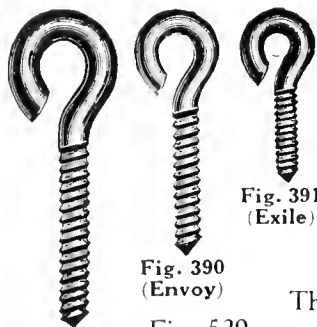

Fig. 389 (Ensing)

Fig. 390 (Envoy)

Fig. 391 (Exile)

Louden Pulley Hooks, Etc.

Fig. 389. Steel Floor Pulley Hook, $\frac{3}{4}$ x 7 inches. Weight, per dozen, 15 pounds.

Fig. 390. Steel Rafter Pulley Hook, $\frac{5}{8}$ x 6 inches. Weight, per dozen, $10\frac{1}{2}$ pounds.

Fig. 391. Steel Return Pulley Hook, $\frac{1}{2}$ x $3\frac{1}{2}$ inches. Weight, per dozen, 3 pounds.



Fig. 470 (Provost)

Pulley Holders for Steel Track

The Pulley Holder, Fig. 470, is designed for use with the Louden Weight Return, Fig. 529, page 19, and also at any other place where it is necessary to hang a pulley immediately underneath a Steel Hay Carrier Track.

Fig. 470 shows Pully Holder for Double-Bead Steel Track. Weight, $\frac{7}{8}$ pounds. It is made of refined malleable iron and is clamped to the steel track by means of heavy bolts.

How to Set Pulley Hooks

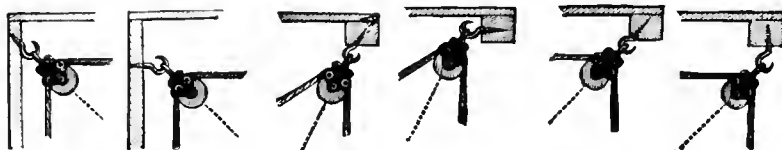

Pulley Hooks should always be set so they will stand straight with the line of draft, as shown by the dotted lines. When the pull is crossways it will bend the hook. Of the illustration at left, the first, third and fifth are

right; while second, fourth and sixth are wrong. It is the Cross Pull that bends or breaks the hook. A $\frac{5}{8}$ or $\frac{3}{4}$ hook put in right will stand more than a $\frac{7}{8}$ -inch hook put in wrong.

Louden Bracket Pulley Holder—Fig. 348

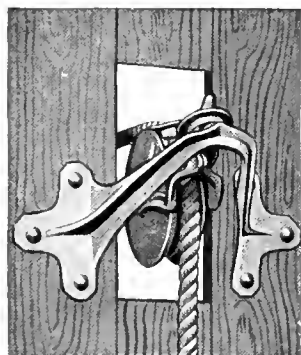

Fig. 348 (Pyramid)

Specifications

For supporting pulley for draft rope. Made of malleable iron. Will carry any common pulley. Weight, 3 pounds.

Louden Bracket Pulley Holder is used to carry the draft rope out through the barn siding close to the eaves and carries the rope close to the mow so that the hay does not interfere with the rope or pulleys when the mow is full. The hole in the side of the barn is small and the pulley is up close to the eave and is always in the dry. Pulley can be put in or removed easily from inside of the barn. In barns where hay is taken in at one end or both ends, if the rope is run the nearest way to the ground from the end of the track, it reduces friction and requires less rope.

The holder supports the pulley and at the same time allows it to adjust itself in line with the draft. It also holds the rope free so it does not rub and wear on the timbers. To attach the holder, cut a hole in the barn siding 4 inches wide and 8 or 10 inches high. Bolt the holder in place so the hook will be even with the top of the hole. Bolts are furnished with the holder. This is an inexpensive article that should be included with every hay-unloading outfit for barns as described. The saving in the amount of draft rope required, the less amount of wear on the rope, and the reduced friction, make the Bracket Pulley Holder a profitable investment immediately.

Louden Lightning Rope Hitch—Fig. 367

Made of Malleable Iron



Fig. 367 (Emery)



Fig. 383 (Excelsior) Louden Swivel Rope Hook with safety latch. Weight $\frac{1}{4}$ pound.

For quickly connecting Singletrees or Doubletrees to draft rope. No time lost tying or untying knots in the rope. The rope is slipped through the hitch and the end bent around and slipped under itself. It can be instantly attached or detached and will hold securely; also can be adjusted to lengthen or shorten the rope. It is provided with a safety hook which will not become unlatched. Weight, $1\frac{1}{8}$ pounds.

Louden Hoisting Singletree—Fig. 344

Specifications

For use wherever hoisting is to be done with a horse.
Body of hard wood.
Trimming of malleable iron.
Weight, 6 pounds.



Fig. 344

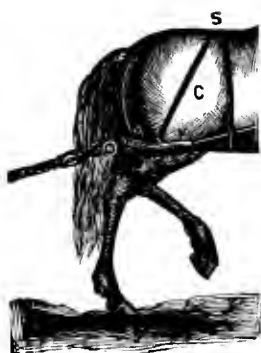

Fig. 344A (Prince)

The Louden Hoisting Singletree was designed for use anywhere that hoisting is to be done with a horse or team when the Singletree has no support. It is especially popular and desirable for use with the hay unloading rig at hay time. It is equally valuable for any kind of hoisting with horse power, plowing or cutting ice, plowing in orchards, vineyards or other places when the ends of the singletree is liable to injure the trees or vines.

The Singletree does not drag against the horse's legs, and the traces do not unhook or get under the horse's feet in backing or turning. The traces pass through keepers (K) and along back of singletree to hook in center. The Singletree being bent, this brings it close to the horse, like a breeching, without having to shorten the traces and it is held up by a cord (C), having a snap (S), which hooks into the trace carrier iron. The eye to which the draft rope is fastened is swiveled, which keeps it from kinking.

The Singletree saves much time. The horse can be turned short around and there is no chance for the horse to get over the traces. Also the rope is held up off the ground so the horse cannot step on it.

Louden's Spreader Attachment—Fig. 345

Fig. 345 shows our Spreader Attachment by which two Singletrees can be hitched together for use with a team. For ordinary hoisting purposes, we use a rope with a spreader and attach the hoisting rope to it, as shown by enlarged figure in center. For other work a chain may be used. There is no other rig equal to this for four or six horse teaming, as it does not strike the horses' legs and causes no weight whatever on the necks of the team behind. To attach Singletrees remove the hooks from ends of Spreader, hook on Singletree and replace hooks and bolts. Weight, 5 pounds.

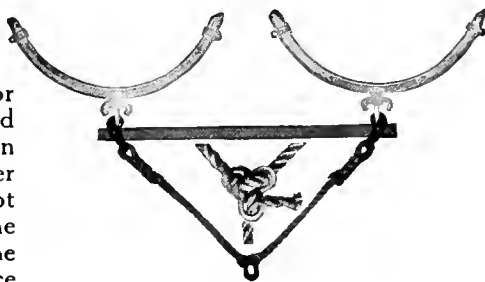

Fig. 345 (Pension)

Louden Offset Hinges—Fig. 349

Specifications

For gable hay doors on barns.
Made of malleable iron.
Hinged together with heavy bolt.
Weight (one hinge only), 2 pounds.

Weight full set fittings for gable door
(2 hinges, 2 hooks and staples, 2 small hooks), 4½ pounds.

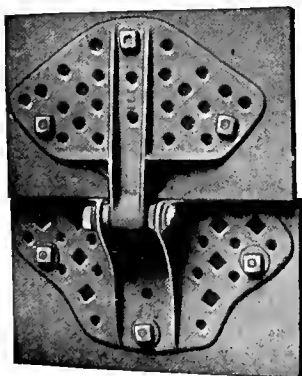

Fig. 349 (Puss)

out wind and rain. It is made of malleable iron and is very strong. Two hinges are sufficient for all ordinary doors. For extremely large, heavy doors three hinges should be used. The hinge is made wide to insure a solid bearing on the door and to give plenty of room for bolts and screws.

The gable hay door hung with our Offset Hinges, as shown in Fig. 347 is practical, cheap and easy to make. The door can be opened and closed with the hay carrier. This can be done from the ground either by hand or with a horse.

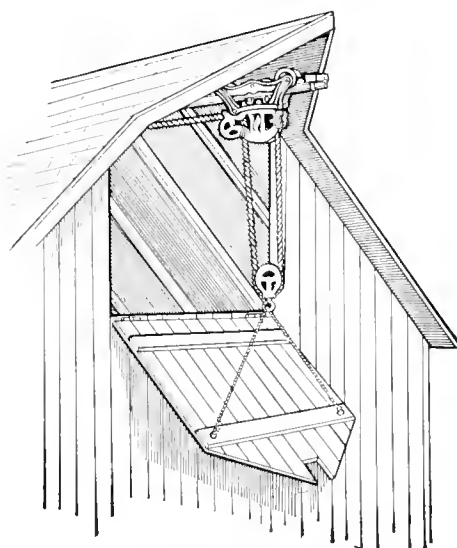

Fig. 347

Louden Hay Door with Offset Hinges

Louden Improved Hay Rack Clamps—Fig. 555

Specifications Patented Oct. 20, 1903.

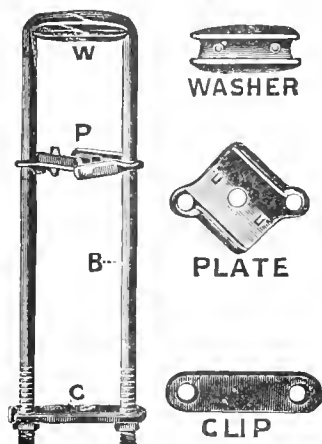

Fig. 645

WASHER



PLATE



CLIP

For building Hay Racks of all sizes. U-shaped bolts are steel, $\frac{3}{8}$ inch diameter, 12, 14, 16, and 18 inches long.

Top washer and intermediate plate malleable iron. Clip washer of steel.

A set of clamps consists of the following:

8 top washers "W". 8 intermediate plates, "P".
8 lower clip plates "C". 8 U-shaped clamp bolts, "B".

Weight, per set 12-inch bolts, $11\frac{1}{2}$ pounds.

Weight, per set 14-inch bolts, $11\frac{3}{4}$ pounds.

Weight, per set 16-inch bolts, $12\frac{3}{4}$ pounds.

Weight, per set 18-inch bolts, $13\frac{1}{2}$ pounds.

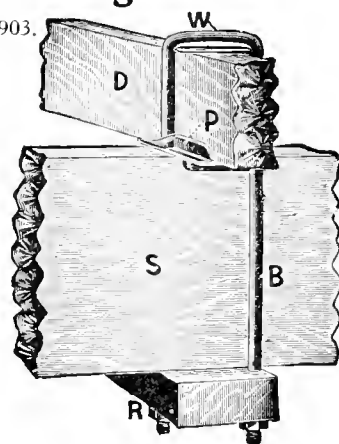

Fig. 646

By means of the Louden Hay Rack Clamps and Plates the timbers of the rack can be put together and securely held in position without having to bore holes in the sills or upper cross pieces. The rack can be built in one-half the time where the clamps are used and timbers are not weakened by having holes bored in them.

In illustration, Fig. 647, is shown a hay rack under course of construction, the main and cross sills having been clamped together. The washers are placed at the points "W", the intermediate plates at "P", and the clip plates at "C". There is no easier way or better place to build a hay rack than on the running gears of a wagon. No measuring will be necessary and the rack will always fit the bolsters.

Lengthen out reach until weight of the load will be evenly divided between front and rear axles; stand main sills on edge close up to standards; place cross sills in position and clamp the two together as shown in Figs. 646 and 647. The upper cross pieces should be set about two inches back from the ends of main sills in order that the intermediate plates may get a good, firm hold on the timbers. In this way any one can build a good rack in a short time, the only tools necessary being wrench and hammer. The rack will be about one-third stronger than if built in the old way, as the sills will not be weakened by holes, and the time saved will more than pay for the clamps.

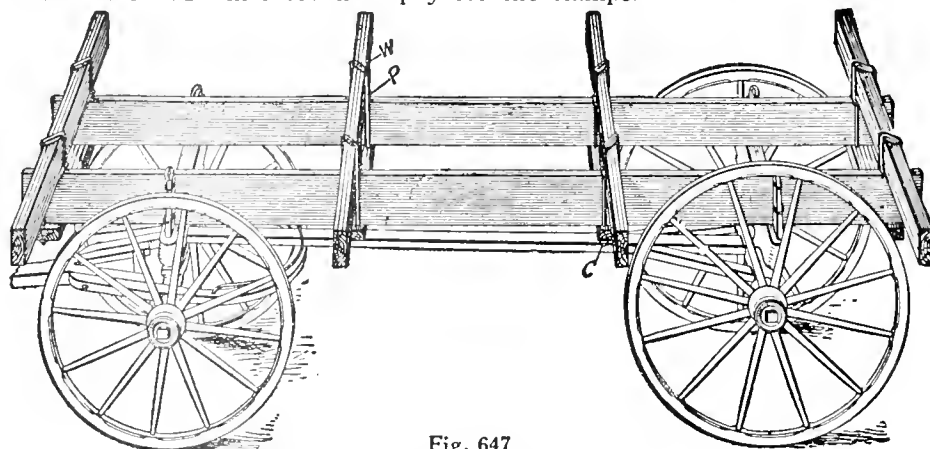

Fig. 647

Material Necessary for Sixteen-Foot Rack

- Two pieces 2x8, 16 ft. long for main sills.
- One piece 2x4, 16 ft. long to be cut up for bottom pieces
- Four pieces 2x4, 7 ft. long for cross bars.
- Two pieces 2x4, 6 ft. long for front ladder.
- Four pieces 2x6, 6 ft. long for sides of rear wheel covering.
- Four boards 1x8, 16 ft. long for lengthwise pieces on sides.
- One board 1x6, 12 ft. long for tops of wheel coverings.
- Two boards 1x12, 16 ft. long for bottom of rack.

The above specifications cover material necessary for rack 7x16 feet to be used with our 14-inch clamps; but if it is desired to make a rack of different length or width the dimensions of the lumber must be changed accordingly. To build a rack with larger main or cross sills use the 16 or 18 inch clamps.

The Intermediate Plates are of malleable iron and have heavy flanged edges or shoulders to fit over the edges of the main sills "S", and cross pieces "D", holding them firmly in position. These plates also have lugs or projections (two above and two below), that are driven into the timbers when the clamps are drawn down tight, thus preventing all rubbing or chafing and making it impossible for the sills or cross pieces to warp and get out of line.

The Top Washers are also of malleable iron and have a good, wide bearing surface to prevent them from cutting into the wood. The steel bottom plates are extra heavy and not only act as washers but prevent the bottom cross pieces from being split by a severe strain.

Louden Combination Rack Irons—Fig. 593

For Making Hay Racks, Hog Racks, and Wood Racks

Patented May 12, 1908

Specifications

The castings D and H are of the best malleable iron. A set securely packed in a box consists of 8 holders D, 8 inside irons H, and 40 bolts; all $\frac{3}{8}$ diameter. They are packed with bolts for 8-inch side rails. The lower outside bolts are $5\frac{1}{2}$ and the lower inside bolts are 7 inches long. For 6-inch side rails change these bolts for bolts 2 inches shorter; and for 10-inch side rails, 2 inches longer. Weight, per set, 23 pounds.

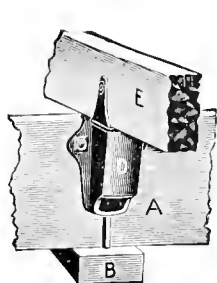

Fig. 593 (Fox)

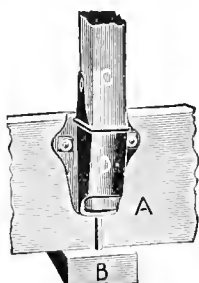

Fig. 594

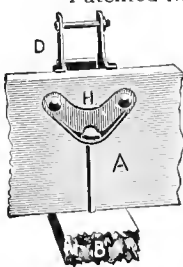

Fig. 595

between which the cross timber E of the rack is held by a bolt passing through the lugs and timber, as shown in Fig. 593. The castings are of the best malleable iron.

In changing to a hog or wood rack the cross timber E is removed and the stake C inserted in the holder. It may be bolted there if desired, as shown by Fig. 594. The stake is set edgewise, which makes it much stronger than when set sidewise.

The bottom timber B, is held in place by two bolts, one on each side of the timber A. Figs. 593 and 594 show the outside bolt passed through the bottom of the holder D, and the timber B. Fig. 595 shows the inside bolt, supported by iron H. Castings D and H are clamped to opposite sides of the timber A by two common bolts. There is no chance for the timbers to spread apart.

They are most practical and serviceable rack irons. The iron D is a regular stake holder, provided with lugs or bars at the upper end

Louden Stake Holders

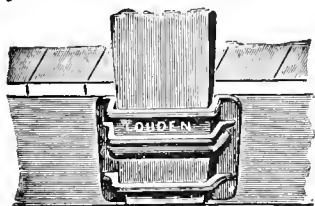

Fig. 398 (Santiago)

Fig. 398. Malleable iron. Rounded at the edges to prevent wear on the stake. Is held in place by a $\frac{1}{2}$ -inch clip bolt, furnished with each holder. Will receive stake $1\frac{5}{8} \times 3\frac{1}{8}$ inches. A very strong holder. Weight, $1\frac{1}{4}$ pounds.

Fig. 398 $\frac{1}{2}$. Malleable iron. Tapering and rounded at edges to prevent wear on the stake. Held in place by ordinary bolts (bolts not furnished with holder). Weight, $1\frac{1}{4}$ pounds.

Fig. 624. Steel stake holder. $2\frac{1}{2}$ inches wide, $\frac{1}{8}$ -inch thick. Will hold 2x3 or 2x4 inch stake, tapering at lower end. This holder is designed to bolt to the ends of the cross timbers on a hay rack, so the basket of the hay rack may be removed from the floor or attached to it, at will. Weight, $1\frac{1}{2}$ pounds.

Fig. 627. Pressed steel stake holder. Is made from steel 3 inches wide and $\frac{1}{8}$ inch thick and holds stake $1\frac{1}{2} \times 3$ inches. The top is flaring and bent over to prevent wearing a notch into the stake. This is an inexpensive and durable stake holder. Weight, 1 pound.

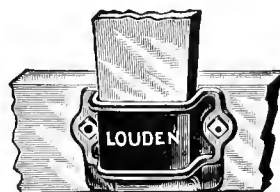

Fig. 398 $\frac{1}{2}$ (Tampa)

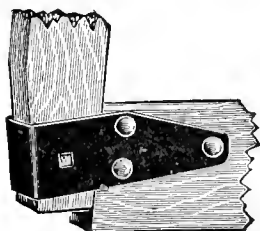

Fig. 624 (Bahama)

Pressed Steel Stake Holder



Fig. 627 (Beach)

Louden Self-Opening Ice Tongs

Specifications

Main body and tines are best crucible steel.

Handle of refined malleable iron.

Riveted together with heavy non-rust rivets.

Points of tines tempered for sharpening.

Made in three sizes:

Fig. 426. 13-inch size. Weight, $2\frac{1}{2}$ pounds,

Fig. 695. 17-inch size. Weight, $2\frac{3}{4}$ pounds,

Fig. 696. 21-inch size. Weight, 3 pounds.

The Louden Self Opening Tongs can be operated perfectly with one hand. When the hand is closed down on the handle the tongs open to their widest extent. When picking up a block of ice or other article, the weight of the article, when lifted, causes the tongs to hold fast and firm.



Fig. 426

13-inch. (Cardenas)

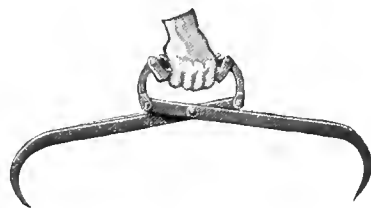

Fig. 695 17-inch (Mantanza)

Fig. 696 21-inch (Sharp)

The 13-inch tong is the popular size for household use, while the two larger sizes are used for heavier work. These tongs are excellent for moving small boxes, nail kegs, etc., in stores and warehouses.

Louden Wire Stretcher and Hoist

Specifications

Wire Stretcher—Fig. 1268

Patented July 7, 1908.

Fitted with 16 feet of $\frac{3}{8}$ -inch sisal rope.
Weight, $5\frac{1}{4}$ pounds.



Fig. 1268 (Key West)

The Loudon Wire Stretcher is the strongest tackle stretcher made. In stretching the wire the operator stands away from the wire, out of danger, while tightening the tension, instead of close up to it as with other stretchers.

The wire grips are fitted with raised flanges or guards which absolutely prevent wires from slipping under the eccentric grips. These grips are fitted with handle one-third longer than other stretchers, and have an offset curve, giving more convenience and greater power for setting the grip with the hand.

The rope grip is positive and will never slip, but will hold the wire at any tension, or a load at any height.

The wire grips never fail to hold. It is equally satisfactory for stretching barbed wire or woven wire. The frames of the pulley blocks are made of high-grade steel, and the fittings are the best malleable iron.

The iron rope sheaves are very smooth to prevent wear on the rope. They turn on special steel thimbles, insuring ease of operation and great strength. The stretcher is reeved with a full $\frac{3}{8}$ -inch rope, which is included with it.

A swivel at the end next the wire and away from the post lets the twist out of the wire but does not let the stretcher itself turn and tangle the ropes, as do stretchers having a swivel next to the post, or at both ends. This hoist has a 400-pound capacity. When in use the operator is away from the load instead of under it.

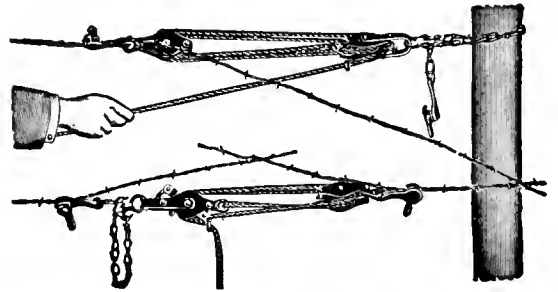

Fig. 807

Fig. 807 shows Loudon's Perfect Stretcher Hoist stretching and splicing barbed wire; while Fig. 808 shows same stretching woven wire fence, using two stretchers, one at the top and the other at the bottom of the fence.

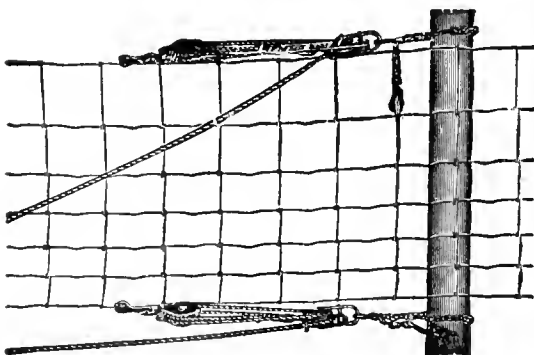

Fig. 808

Apison, Tenn., Aug. 1, 1914.

Louden Machinery Company, Fairfield, Iowa.
Gentlemen:

I beg leave to say that the outfit has given entire satisfaction and that I am much pleased with it. I have used other makes of hay forks but this is the best that I have ever seen.

It is the only fork in the community and has caused a lot of comment. The gentleman from whom I bought the farm came around to see it work. He had been handling over a hundred acres of hay every year with the back-breaking pitchfork method, and when he saw the fork work and the ease with which I filled my mow, he said, "That thing works like it had good sense." I told him that the man who made it had a good supply.

I shall always be ready to demonstrate the outfit to any of my neighbors, for I feel that it is the best hired man that a farmer can get. Thanking you for all favors, I am

Yours very truly, (Signed) J. L. Hinshaw.

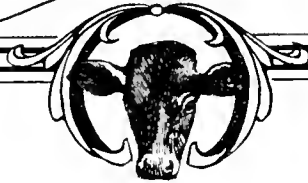
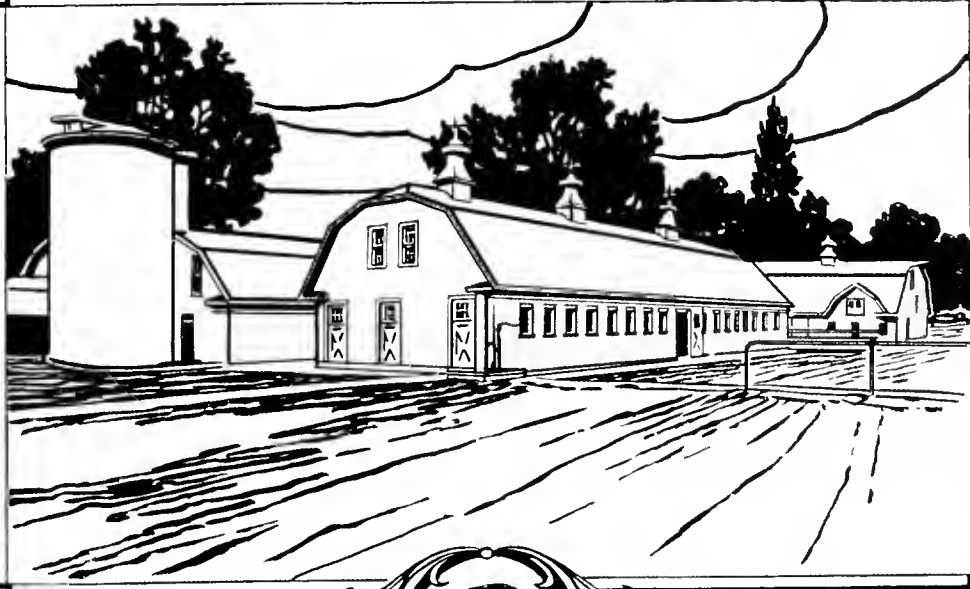

LOUDEN BARN AND GARAGE DOOR HANGERS

	PAGE
Special Garage Door Hanger	59
Bird Proof Barn Door Hanger	60-64
Double Tread Barn Door Hanger.....	65
Double Strap Barn Door Hanger	66
Standard Barn Door Hanger	66
Door Specialties	67
Silent Salesman.....	68

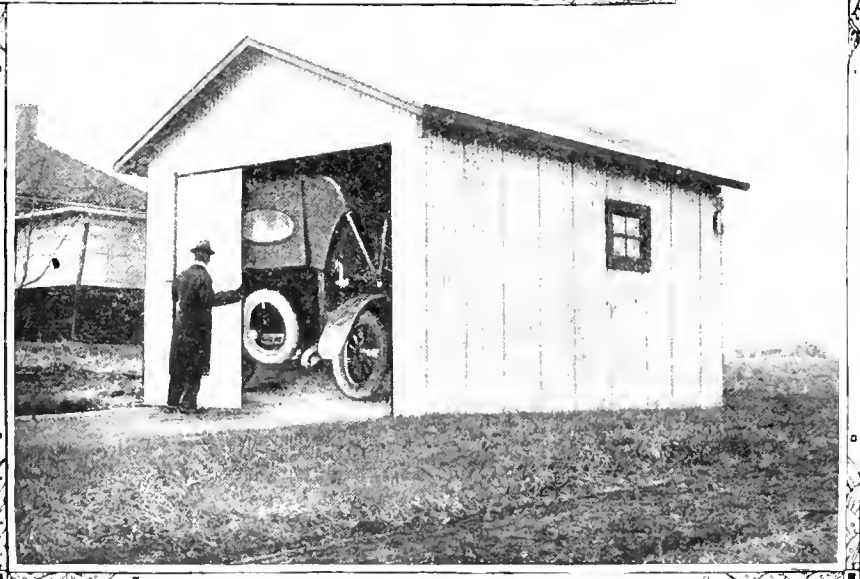
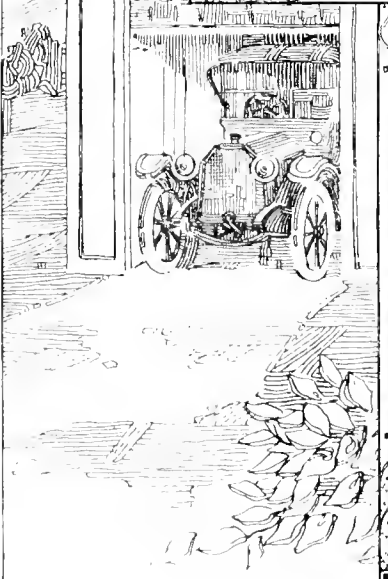
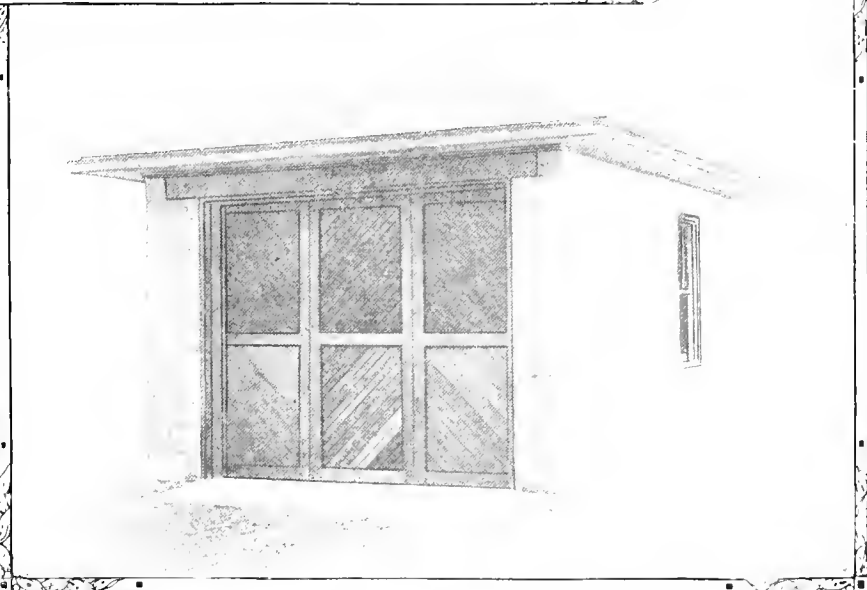
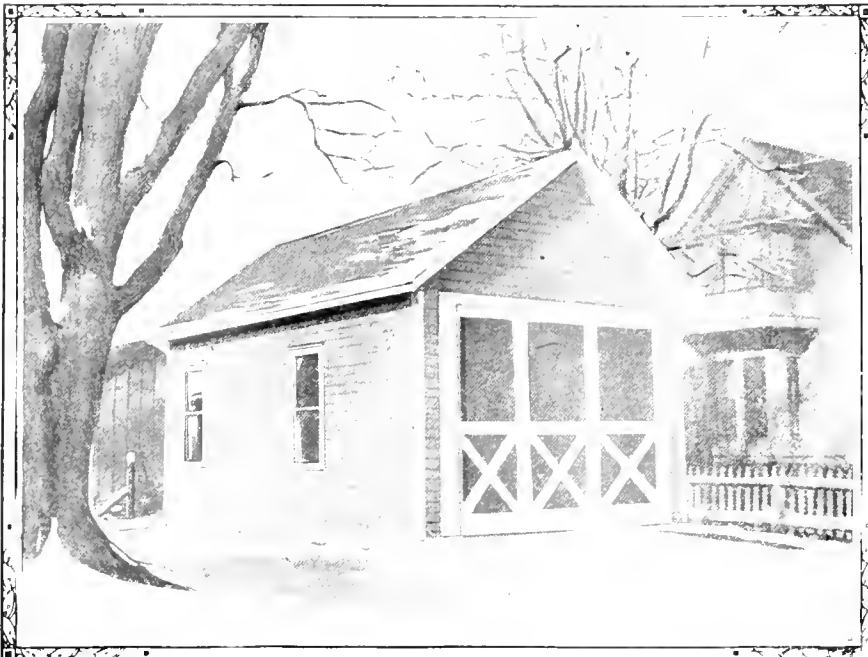

Louden Special Garage Door Hanger Fig. 1273

Specifications

Louden garage Door Hanger complete consists of sufficient track for 6, 8, 10 or 12 foot door together with the following fittings.

3 Special Swivel Trolley Hangers.

6 Six-inch Strap Hinges.

2 Door Handles.

2 Floor Stay Rollers.

1 Wall Stay Roller.

1 Hasp and Staple.

6 Dozen Screws.

$\frac{1}{2}$ Pound Barbed Chisel Point Nails.

Weights: Track weighs 1 pound per foot. Fitting weigh, 18 pounds.

Installation: Full directions are furnished with each outfit. Any carpenter can build door and hang properly. Track comes in straight sections which are easily bent to fit building.

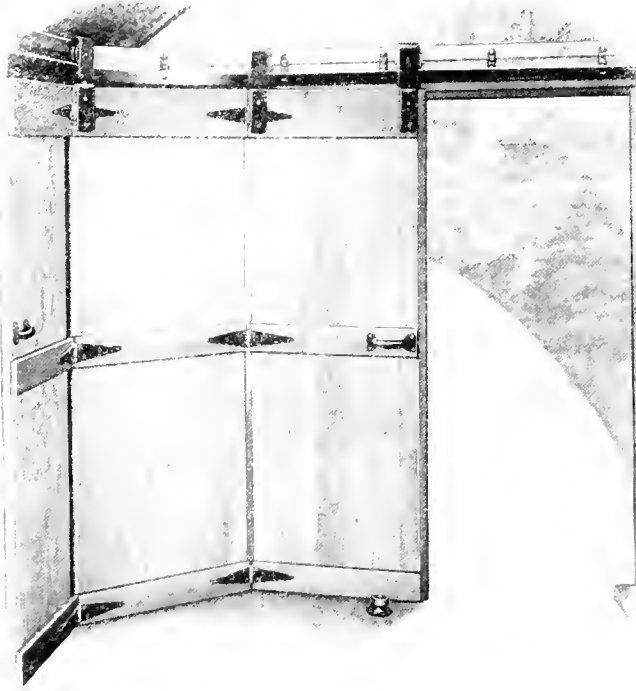

Fig. 1273

Patented May 30, 1916.

It is curved at the corner and extends along the adjoining wall. The door is hinged in three parts, and takes up but little room in turning the corner. It lies against the side wall when open.

The roller bearing trolleys are swiveled at the point where they connect with the door straps. They are attached to two sections of the door only, the third being free to swing like an ordinary hinged door. This affords a convenient doorway for passing in and out, and makes it unnecessary to open the whole door so frequently.

The door is held to its place at the bottom by two stay rollers, screwed to the floor. A third stay roller, attached to the door itself, prevents its rubbing or binding on the side wall.

This hanger is destined to be the most popular, biggest selling, and most satisfactory garage Door Hanger on the market to-day.

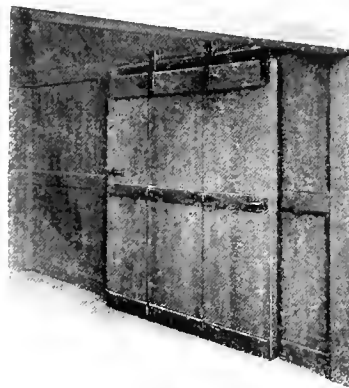

Fig. 1273-A

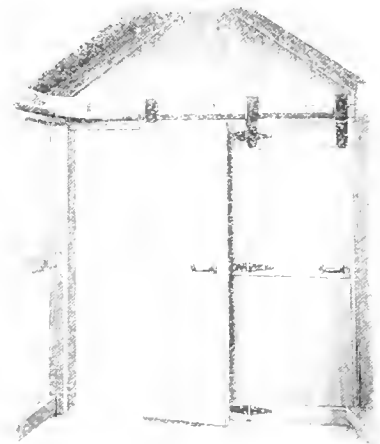

Fig. 1273-B

Louden Bird-Proof Barn Door Track and Hangers—Fig. 911

Specifications

For all kinds of doors, large and small.
 Track is tubular and trolleys travel inside.
 Trolley cannot get off the track.
 Track is made of No. 14-gauge special steel.
 Dimensions of track inside, $1\frac{5}{8}$ inches wide by $2\frac{1}{8}$ inches deep.
 Supporting brackets for track of steel with embossed reinforcements.
 Wall brackets of refined malleable iron.
 Supporting wall brackets may be placed 36 inches apart, for heavy doors, space 24 inches apart.
 End stops and splices for track packed with trolleys
 Track is furnished in 4-ft., 6-ft., and 8-ft. lengths.
 Weight of track per foot, $1\frac{3}{4}$ pounds.
 Weight of supporting brackets per dozen pair, 9 pounds.

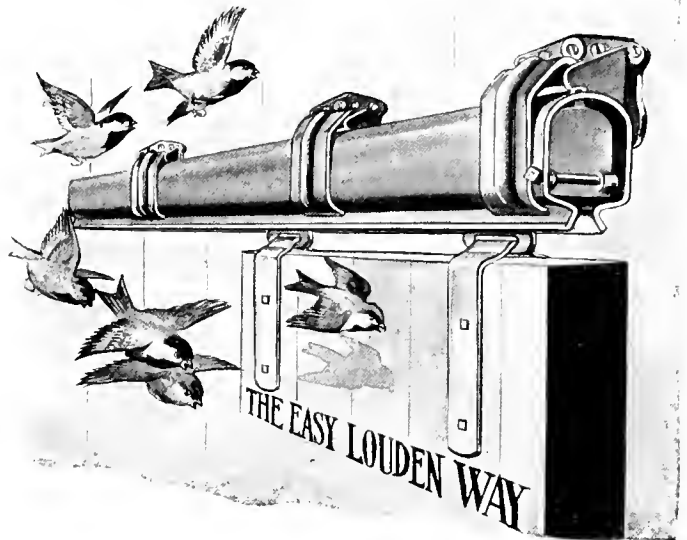

Fig. 911

Patented June 11, 1912

Special Features

Trolleys Completely Enclosed. The only opening is the narrow slit beneath the track. There is no chance for the trolleys to be clogged or derailed. The track is absolutely proof against nesting birds, trash, rain, snow or sleet.

Flexible at Two Points. The joint in the hanger strap allows the door to swing out away from the building, frequently avoiding breakage by crowding stock. The joint in the track support permits the track itself to swing out from the building, making it possible to easily dislodge trash and dirt which may accumulate behind the track and rot out the siding. This double flexibility allows the door to fit snugly without sticking or binding.

Roller Bearing Tandem Trolleys. The Trolley Wheels revolve on hardened steel roller bearings around a tempered steel shaft. Always roll easily. A light push will open or close the heaviest door.

Trolleys Run on Level Tread. The Bird-Proof Track is square, not oval. The level tread reduces friction to the minimum and overcomes the wedging tendency frequently found in oval tracks which support heavy doors.

Simple and Strong in Construction. The form of the Bird-Proof Track, and the special grade of steel used in its manufacture, combine to give it wonderful strength and rigidity. It is further strengthened by the curved lips on the under side of the track. Will not sag under the weight of heavy doors.

Door Hanger Trolleys—Fig. 902

Specifications

Frame of trolley of pressed steel with embossed reinforcements.
 Supporting loop for strap that carries door of refined malleable iron.
 Straps that carry door of No. 12 gauge steel, $1\frac{3}{4}$ inches wide.
 Straps are furnished regular for doors $1\frac{3}{4}$ inches thick.
 Track wheels are of special quality gray iron.
 Track wheels are 2 inches in diameter and are roller bearing. (See Fig. 19B and C, Page 62.)
 Bolts for attaching hangers to doors, also end stops and splices for track are packed with each set of trolleys.
 Each set of hangers packed in neat paper box.
 Weight per dozen sets, 72 pounds.

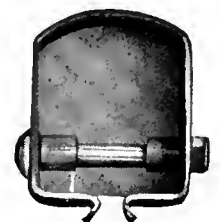

Metal End Stop Completely Closes Track

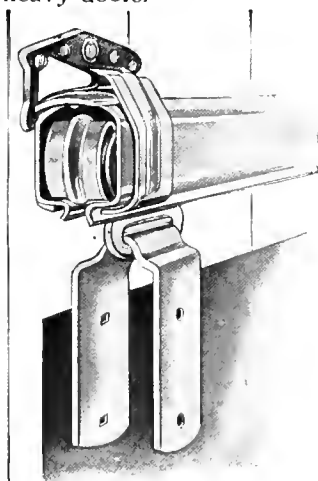

Fig. 961

Showing End View of Track with End Stop Removed

Louden Bird-Proof Barn Door Track and Hangers—Continued

We believe this to be the neatest, strongest, easiest operated, and most serviceable barn door hanger on the market. It has been in use on thousands of barns and we have heard nothing but good words spoken of it. You can make no mistake in choosing Bird-Proof. It will give you perfect service.

The Track

The track of the Bird-Proof Hanger is made from a solid sheet of steel pressed into shape. The ends are closed by special end stops, bolted in. The track is completely enclosed, with the exception of the narrow slit at the bottom for the hanger strap to work in.

The lips of the track on each side of the slit are curved downward and outward. This feature gives strength and stiffness to the track and insures an even surface on which the wheels run.

The track is made in standard sections of 4, 6, and 8 feet long. When two or more sections are used, the ends are held together by a steel splice. The splice is put on without rivets or bolts and holds the sections firmly so they can never spread apart. **No other track on the market has this feature.**

Support of the Track

The track is supported by heavy steel brackets bent to fit snugly around the track and close up to the lips on the under side. A heavy corrugated rib in the center reinforces them strongly—they will never spread and the track cannot sag under the weight of the heaviest doors.

The brackets are hung to heavy, malleable iron wall fixtures which are bolted to the wall and support the track in the proper position. The connection between the brackets and wall fixtures is flexible and allows the track to swing freely out sidewise—one of two points of flexibility in this hanger.

Fig. 961 shows how closely the brackets fit around the track, how the trolley wheel fits into the groove of the track and how the lips of this groove curve out.

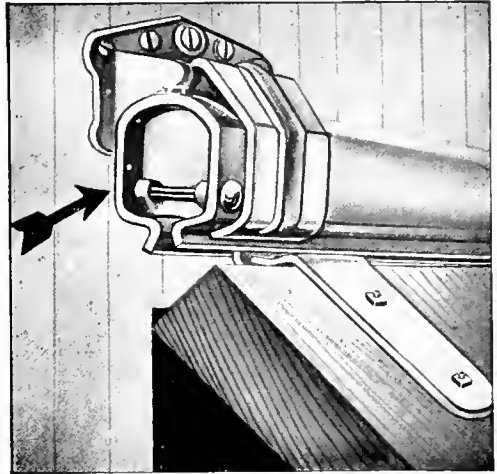

Fig. 918

Flexibility of Track

Fig. 918 shows the track hanging in normal position, but with the door swung partly out. This is the flexibility for which there is the most common need. It saves many a break from crowding stock and the free swing prevents the door from sticking and binding in sliding past an uneven wall.

The arrow points to the narrow space between the track and the barn siding which sometimes fills up with trash and dirt. With an enclosed track nailed or fastened solid to the wall the dirt cannot readily be cleaned out, and when wet will rust the track and rot the barn siding.

The Louden Flexible Bird-Proof Hanger is the only one that perfectly overcomes this serious fault.

By simply pressing outward on the door from the inside, the track may be swung out to allow the trash and chaff to drop out. This may be done instantly and easily without gouging it out with a pitchfork or other tool.

The Splice for Louden Bird-Proof Track

In Fig. 895 is shown the splice clamp for holding the ends of the track, together. No. 1 shows the splice clamp standing on edge on top of the track and ready to be placed in position.

No. 2 shows the splice in position and the steel bracket pushed partly over it. It will be noted that in No. 1 and No. 2 the malleable bracket which attaches to the barn wall



Track Bracket and Supporting Bracket
For Bird Proof Track

Louden Bird-Proof Barn Door Track and Hangers—Continued

is turned away from the wall. In this position the bracket will easily slip over the splice.

In No. 3 the bracket is slipped entirely over the splice and is turned the other way and fastened to the wall. In this position the bracket binds down on the splice, holding it just as firm and solid as though it were riveted or bolted in place. This is a valuable and important feature, as the splice absolutely prevents the ends of the track from separating and making a rough place in the track, or possibly allowing the trolley to drop out. The Loudon Bird-Proof Track is the only tubular track having this valuable feature.

Galvanizing

At a small additional cost the Bird-Proof Hanger may be furnished galvanized if desired. We have our own galvanizing plant. By this process steel or iron is covered with a heavy galvanized coating which protects the metal from rust and corrosion and gives it a longer life of service.

The Trolleys

The Loudon Bird-Proof Hanger has a set of two tandem trolleys. Each trolley has two solid iron wheels, fitted with steel roller bearings and revolving on a steel shaft. These wheels are carried in a heavy double truck frame of steel with a corrugated rib to strengthen it. The wheel shafts are riveted firmly into this frame at each end, and can never work loose or get out of order. Our patent revolving washer protects the bearings from wear, reduces friction and adds years of life to the service of the hanger.

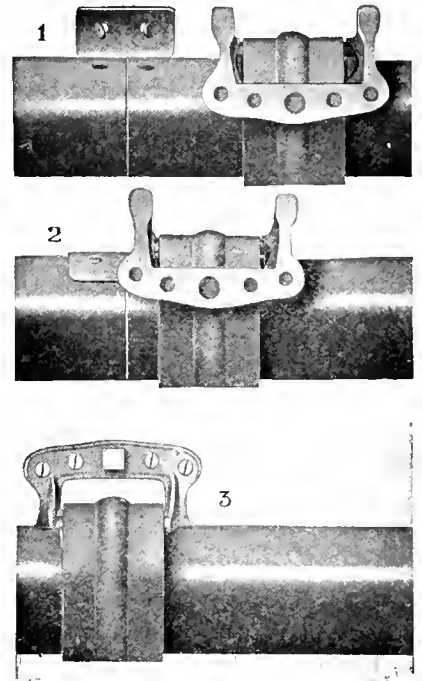

Fig. 895

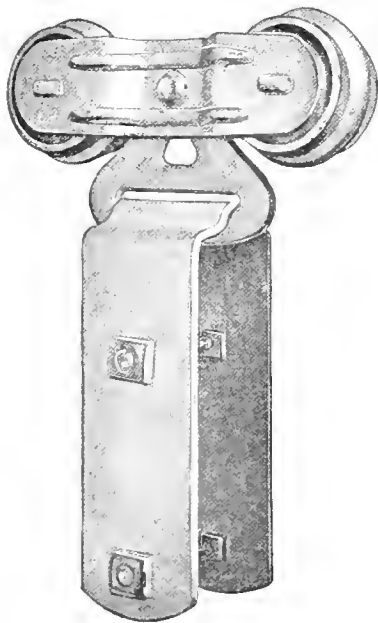

Fig. 902

Roller-Bearing Tandem Trolley

The supporting parts are of heavy malleable iron, riveted to the truck frame midway between the two wheels. This malleable support comes down just below the lips of the track and carries a broad steel strap which attaches to the door. This is the second point of flexibility in the Loudon Bird-Proof Hanger, and allows the door to swing freely sidewise. (See Fig. 902.)

View B is an end or edgewise view of one wheel, showing the rib or bulge in the center of its face. This rib fits neatly into the slot in the track (See Fig. 961) and keeps the wheels always in perfect alignment; they can never wobble from side to side and bind or rub against the side of the track. View C shows the roller bearings of the wheels.

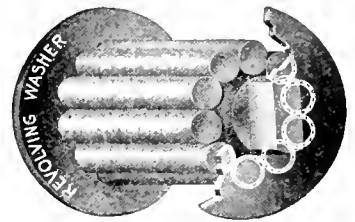
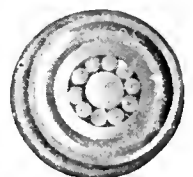

Fig. 19

Detail of Roller Bearing



View B



View C

Louden Bird-Proof Track Adjustable Trolleys

Fig. 1052

Patent Pending.

Adjustable hangers permit door to be adjusted $\frac{3}{4}$ inch both lateral and vertical.

Frame of trolley of pressed steel with embossed reinforcements.

Strap or casting that carries door of refined malleable iron.

Adjustable feature permits use of hangers on doors from $1\frac{1}{2}$ to 3 inches in thickness.

Track wheels are of special quality gray iron.

Track wheels are two inches in diameter and are roller bearing. (See Fig. 19 B and C, Page 62).

Bolts for attaching to doors, also end stops and splices for track are packed with each set of hangers. Each set of hangers packed in neat paper box. Weight, per set, $6\frac{3}{4}$ pounds.

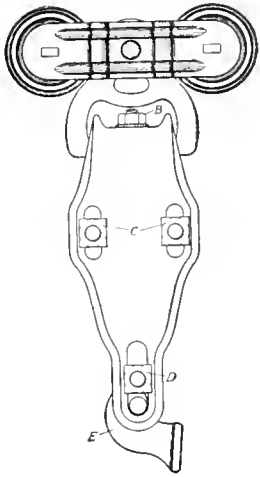

Fig. 1052

The Louden Adjustable Hanger for Bird-Proof Barn Door Hanger is without doubt superior to other hangers where conditions make an adjustable hanger necessary. One man with a monkey wrench can quickly and easily adjust the hangers so that the door will clear frost-swollen ground that would make the door rub at the bottom, or make the door hang true where the siding or joists have become warped out of shape. The Louden Adjustable Hanger makes it possible for one man to hang the heaviest door, as the trolleys are run into the track before being attached to the door.

Fig. 1052 shows front view of Adjustable Hanger. By turning the eccentric (E) with a wrench, the door may be raised or lowered as desired. The bolts (C and D, Figures 1052 and 1053) when nuts are loosened allow the door to be adjusted up and down, while the bolt (B) (Fig. 1053) permits the door to hang closer or farther from the barn as desired.

Fig. 1053A shows how the door is "hooked" into the trolley-strap. This is the feature that makes hanging a door an easy task.

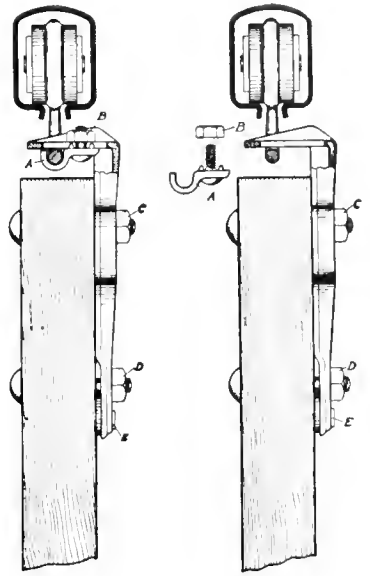

Fig. 1053

1053A

Double Bracket for Bird Proof Track—Fig. 1204

It is often necessary to hang doors in such a way that one can slide past the other. For such an arrangement we furnish a double track support from which two sections of Bird Proof Track may be hung, one just outside the other.

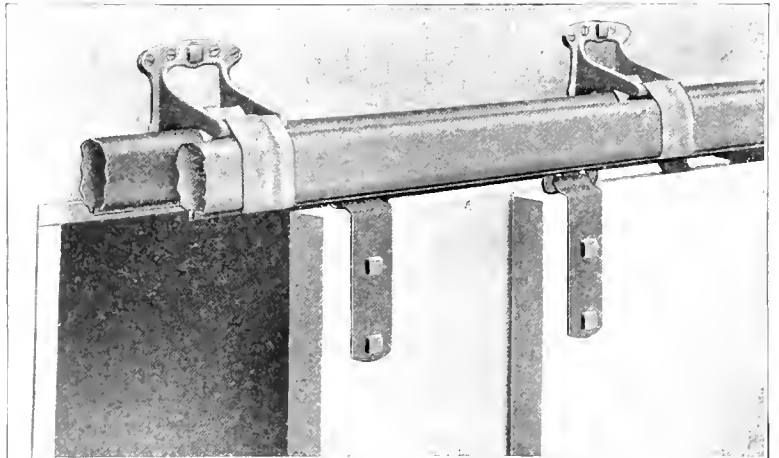

Fig. 1204

This equipment is the same in every way as the regular Bird Proof, except that the supporting bracket is longer, and has supports for two track brackets.

The doors hang true and fit snugly. There is no waste space between them.

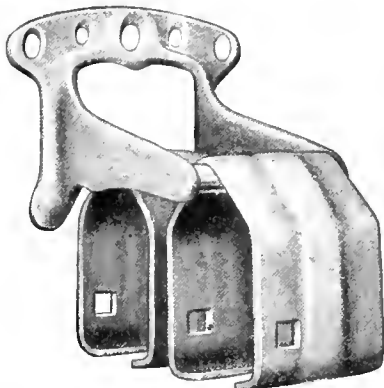

Fig. 1285

Double Supporting Bracket

Louden Covered Bird Proof Barn Door Track Fig. 1200

The Louden Covered Bird-Proof Door Hanger Track is the heaviest, strongest, and neatest barn door track made. The tube in which the trolleys travel is made from a single sheet of 14-gauge steel pressed into shape. The tube is $1\frac{5}{8}$ inches wide and $2\frac{1}{16}$ inches deep inside and is exactly the same as the regular bird-proof track described on page 60.

The track is completely enclosed except the narrow opening at the bottom for the hanger strap to work in. The lips of the track on the bottom bend downward and outward making a strong support for the trolleys and also preventing any dust or moisture from getting in the track. The trolleys travel on a level tread and there is no opportunity for the track to spread or bind on the trolleys.

The cover being attached to the top and side of track by a process of electric welding, makes it conform readily to its shape and renders it absolutely strong and rigid.

The cover has an embossed reinforcement every 9 inches which adds greatly to its strength. At the extreme upper edge of the cover the edge is bent sharply toward the building. When the track is made fast to the barn this upper edge presses into the barn siding, and no water or moisture can get behind the track. One inch of the upper edge of the cover lies flat against the barn wall and is provided with holes to receive the lag screws for making it fast.

The track is rigidly attached to the barn wall and in this respect it differs from the regular bird-proof track, which is flexibly hung. The lower edge of the cover extends below the upper edge of the door. All water and moisture is turned to the outside of the door and the track and the upper edge of the door are completely protected from the weather.

The back side of the main track has embossed knobs or buttons to hold the track away from the building. (See Fig. 1201.) This allows an air space between the track and the building, with no opportunity for moisture to accumulate and rust the track or rot the barn siding.

The ends of the track are closed with steel stops bolted in. (See Fig. 918, page 61.) There is no opportunity for trash, dirt or weather to reach the trolleys. The track is always clear and heavy or light



Fig. 1200

Specifications



Lag Screw

- For all kinds of doors, large and small.
- Track is tubular and trolleys travel inside.
- Trolleys cannot get off the track.
- The regular Bird-Proof Hanger, Fig. 902, or Bird-Proof Adjustable Hanger, Fig. 1052, operates in this track.
- Body of track is made of No. 14 gauge special steel.
- Dimensions of track inside, $1\frac{5}{8}$ inches wide by $2\frac{1}{16}$ inches deep.
- The tubular track has a steel cover made of No. 18 gauge steel, and being attached by an electric weld, forms a part of the track making it absolutely strong and rigid.
- Embossed reinforcements every nine inches give great strength to the cover.
- Cover is made fast to barn wall with lag screws.
- Upper edge of cover is provided with holes for lag screws for attaching to barn wall.
- Lower edge of cover extends down beyond the upper edge of door so rain and snow cannot blow under.
- The extreme upper edge of cover bends sharply toward wall. When track is in place this edge presses into the barn wall preventing moisture from penetrating behind the track.
- The back side of the main tube is provided with embossed buttons which hold the track away and allow an air space between the track and the wall.
- Track is furnished in 4-ft., 6-ft., and 8-ft. lengths.



Fig. 1201. Rear View of Covered Bird-Proof Track

doors travel easy, smooth and true. To the man who desires practical utility, long and perfect service, a neat and attractive design in a barn door track, the slight extra cost of this track as compared with others on the market will always be remembered as a good investment.

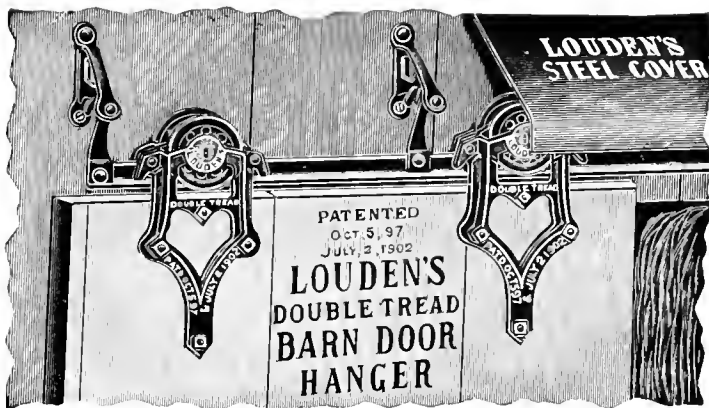

Fig. 458

Specifications Track

For all kinds of doors, large or small.
Track is an inverted steel T-rail.
Width of track $1\frac{1}{2}$ inches.
Track hooks are of refined malleable iron and are riveted solid to the track.
Wall brackets are of refined malleable iron.
Track hooks engage eyes in the wall brackets making the track flexible, a very valuable feature.
Wall brackets and track hooks are furnished with the track.
A steel splice clamp is attached to one end of each section of track.
The opposite end of track section is punched to receive splice and rivet.
Rivets for splice clamps are packed in box with trolleys.
Track is furnished in 4 ft., 6 ft., and 8 ft. lengths.
Weight of track per foot (including track hooks and wall brackets), $1\frac{1}{3}$ pounds.

and ready to go. There is an absolute center draft; no side hitch to make a strain on the hanger or throw the door out of plumb.

The four wheels which carry the weight of the door are fitted with turned and tempered steel roller bearings. Ten of these bearings revolve about a turned and tempered steel shaft.

Door Hanger Trolleys

Frame of trolleys of refined malleable iron.
There are four trolleys with each set of hangers.
Track wheels are of special quality gray iron.
Track wheels are $2\frac{3}{4}$ inches in diameter and are roller bearing. (See Fig. 19B and C, Page 62.)
Wheels travel on opposite sides of the inverted T-rail, giving a perfect center draft.
Suitable for use on doors from $1\frac{1}{2}$ to 2 inches in thickness.
Bolts for attaching to doors packed with each set of hangers.
Each set of hangers packed in neat paper box.
Weight, per set, 6 pounds.

Track for Double-Tread Hanger

The track is a special T-rail of high carbon steel. Will not sag or break with the heaviest door. The hooks and brackets are of refined malleable iron.



Fig. 452 (Evans) Louden Double-Tread Track are securely spliced together; not simply butted together as is frequently the case with cheaper tracks. Cannot become uneven or spread apart at the joint. Made in 4, 6 and 8 foot lengths.

Louden Double-Tread Barn Door Track and Hanger Fig. 458

The Double-Tread was the pioneer Flexible Barn Door Hanger, and continues to be one of the leading hangers in the market. It is compact, durable, and serviceable, simple and strong in construction and sure in its operation. Thousands of these hangers which have been in constant use for many years are still rendering faithful, efficient service—never a hitch in their operation; not a cent paid out for repairs.

Construction

The Double-Tread is in reality two sets of hangers—a set on each side of the door fitted to run on opposite edges of an inverted T-rail. The track is flexibly hung to brackets secured to the wall, and will accommodate itself to the inequalities of the barn siding. The door can be closely fitted without danger of sticking or binding on account of the warping of door or siding. This feature gives it a decided advantage over all rigid hangers. The track, being a T-rail, takes up the least possible room, and the hanger frame is consequently shortened and straightened.

The parts of the hanger being clamped solidly together on both sides of the track makes it impossible for the trolleys to jump the track. The door is always in place

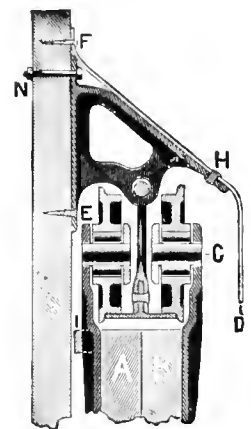

Fig. 453
Sectional View

Louden Double-Strap Covered Jointed Barn Door Hanger—Fig. 566

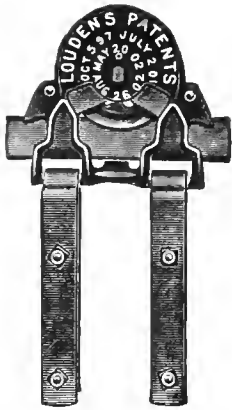

Fig. 566 (Reliance)

Specifications

Frame of trolley of refined malleable iron.
 There are two trolleys with each set of hangers.
 Track wheels are of special quality gray iron.
 Track wheels are 3 inches in diameter and are roller bearing. (See Fig. 19B and C, Page 62.)
 Track wheels are protected from weather and trash by a heavy malleable iron hood.
 Straps which attach to the door are of No. 12 gauge steel, $1\frac{1}{8}$ inches wide.
 Bolts for attaching to doors packed with each set of hangers.
 Each set of hangers packed in neat paper box.
 Weight, per set or pair, $6\frac{1}{2}$ pounds.

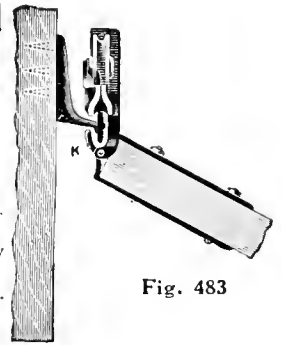

Fig. 483

The Louden Double Strap Barn Door Hanger is giving complete satisfaction in thousands of barns. It is especially recommended for medium size doors.

This hanger, like all all others of Louden manufacture, is flexible; that is, it allows the door to swing freely away from the building. (See Fig. 483.)

The trolleys are fitted with tempered steel roller bearings; always roll smoothly and easily. Each wheel is protected by a malleable iron hood. (See Fig. 566.)

The two straps with four bolts make the Double Strap Hanger much stronger and more durable than similar hangers having but a single strap and two bolts. The wide frame with the double strap feature also serves to hold the hanger rigid lengthwise of the track and eliminates the end play found in hangers with a single bearing directly under the center of the wheel.

Track for Jointed Hangers—Fig. 487

Specifications

Track is of high carbon steel $\frac{3}{16} \times 1\frac{1}{4}$ inches.
 Supporting wall brackets of refined malleable iron.
 Wall brackets are riveted solid to the track.
 A strong malleable iron splice is attached to each end of each section of track.

The opposite end is punched with hole to receive splice and the connection is easily made and secure.
 Track is furnished in 4-ft., 6-ft., and 8-ft. lengths.
 Weight of track, per foot, 1 pound (including supporting brackets and splices)

Fig. 487 is the track used for Louden Jointed Hangers. It is made of the best high carbon steel, $\frac{3}{16} \times 1\frac{1}{4}$ inches, and will stand twice the strain ordinarily required.

The ends of the sections are securely spliced together by a malleable iron splice riveted into the ends, and it is impossible for them to become separated, as do tracks that are simply butted together. This splice is riveted to one end of each section before leaving our factory, and the other end punched so the connection is easily and quickly made. This makes one solid rail of the whole track, no matter how many pieces have been used, and makes a continuous even tread for the hanger.



Fig. 487 (Marble)

We use a refined malleable iron bracket, mortised through the track and riveted on by hand—no machine work. These brackets have a heavy flange on each side and a brace below to hold the track in place. This adds materially to the stiffness of the track and gives it great strength. Made in 4, 6, and 8 foot lengths.

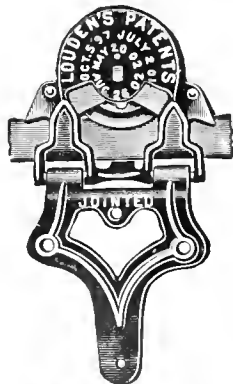

Fig. 567 (Shamrock)

Standard Jointed Barn Door Hanger—Fig. 567

Specifications

Frame of trolleys of refined malleable iron.
 There are two trolleys with each set of hangers.
 Track wheels are of special quality gray iron.
 Track wheels are 3 inches in diameter and are roller bearing. (See Fig. 19B & C, Page 62.)
 Track wheels are protected from weather and trash by a heavy malleable iron hood.
 The strap which attaches to the door is of malleable iron with heavy reinforcing ribs.
 Suitable for use on doors of any thickness.
 Bolts for attaching to doors packed with each set of trolleys.
 Each set of trolleys packed in neat paper box.
 Weight, per set or pair, $6\frac{1}{4}$ pounds.

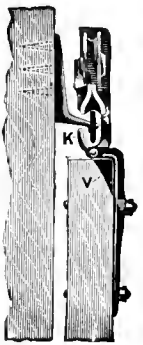

Fig. 485

Standard Jointed Barn Door Hanger—Continued

The Standard Covered Jointed Hanger, Fig. 567, is the same as the Double Strap Covered Hanger, Fig. 566, except the strap which attaches to the door is refined malleable iron instead of steel and bolts to one side of the door only. The trolley wheel is protected from weather by a malleable iron hood. It is provided with keeper lugs which prevent trolley from getting off the track. Also projections on each side of the trolley cleans trash or other obstructions off the track. Suitable for use on all kinds of barn doors.

Louden's Sliding Door Latch—Fig. 455

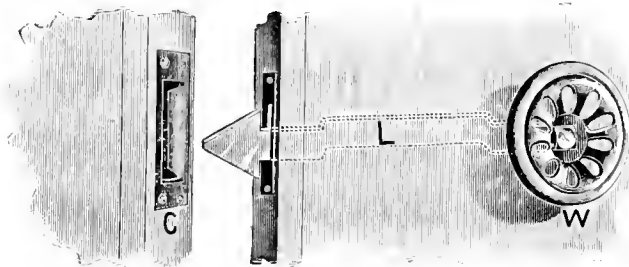

Fig. 455 (Manilla)

guide the latch into it. It is reversible and may be used for right or left hand doors. Made of malleable iron, is strong and durable and can be used on double or single doors.

Specifications

Consists of 3 parts, viz: latch with knob; metal catch for latch; metal strip for door with slot in which latch works.
Length of latch-point to center of knob, 8 inches.
Length of catch, 4 inches.
Diameter of knob, 3 inches.
Weight, 1 pound 6 ounces.

The latch is lifted and the door opened and closed by the hand wheel, W, which is generally placed on the outside, while the central part (dotted lines L) is bent to form a hand hold on the inside. The catch, C, has flaring edges to

Louden's Stay Rollers

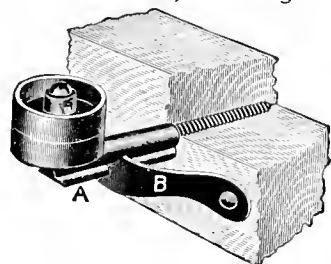

Fig. 456 (Cuba)

Specifications

Diameter of roller, $1\frac{5}{8}$ inches.
Length of screw (to center of roller), 6 inches. Roller adjustable to suit thickness of door.
Weight, 12 ounces.

Fig. 456. This roller is screwed into the wall to suit the thickness of the door; and then the brace, B, is slipped over the rib, A, and fastened to the wall by screws or nails. This prevents it from turning and getting the roller out of place.

Fig. 457. This roller can be adjusted to the thickness of any door, either before or after fastening to the building, by setting one nut.

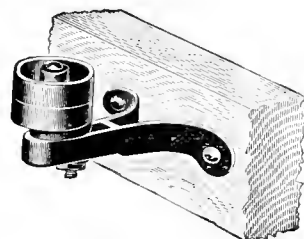

Fig. 457 (Havana)

Specifications

Diameter of roller, $1\frac{5}{8}$ inches.
Length of bracket, 4 inches.
Roller adjustable to suit thickness of door.
Weight, 13 ounces.

Louden Door Stop—Fig. 1205

Every sliding door should be provided with a stop; it prevents the continual wrenching of the track supports.

While any block of wood may be made to serve this purpose, a neat metal stop is desirable. The Loudon Pressed Steel Bumper or Stop is the most satisfactory door stop made and costs but a trifle. Specify it in your barn door hanger order.

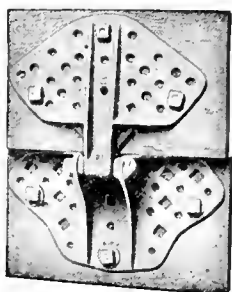

Fig. 349 (Puss)

Specifications

Width, $7\frac{3}{4}$ inches.
Length, $8\frac{1}{2}$ inches.
Offset, 1 inch.
Weight, 2 pounds.

Louden Offset Hinge—Fig. 349

Louden Offset Hinges are unequalled for hanging gable-end doors. These hinges are made with an offset that allows the bottom of the door to lap on the siding and keep out the rain. When the door is open it drops down against the siding and hugs it so closely that it is out of the way of the load of hay and allows the wagon to be drawn close up to the barn. The wind does not interfere with a door hung with these hinges. Doors hung with Offset Hinges may be arranged to open either by hand

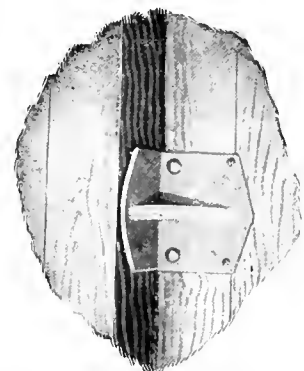

Fig. 1205

Specifications

Width, $3\frac{1}{2}$ inches.
Bumping surface, $3\frac{1}{2} \times 17\frac{1}{8}$ inches.
Reinforced by rib.
Weight, 8 ounces.

or horse power, and the hinges are of sufficient strength to safely handle the largest doors. Bolts or screws may be used for hanging. Three Offset Hinges may be used for extra large doors.

Louden Silent Salesman

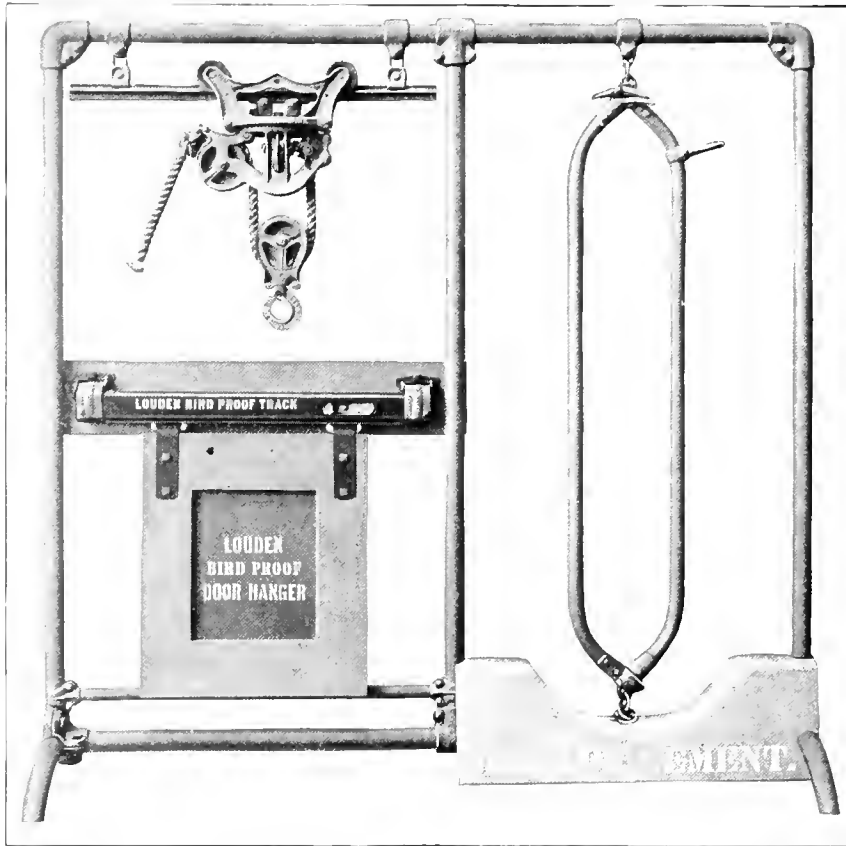

Specifications

Height: 5 ft. 4 inches.
Width: 5 ft. 2 inches.
Shipping weight, 200 pounds.

Construction: Tubular steel with the smooth, dust-proof Loudon connections. Model Door, beautiful natural wood finish. Stanchion curb, wood painted to resemble cement.

Equipment: One Loudon Junior Fork Carrier with short section of track, and Trip Block; one model door with Loudon Bird Proof Track, having cut-out to show trolleys; One Loudon Tubular Steel Stanchion equipped with upper and lower holders and stanchion guide.

No charge for substituting Covered Bird Proof Track for Standard.

Gentlemen: We think this display which you furnished us has practically doubled our business in your line over the preceding year. It bears out the old statement that goods well displayed are half sold.

Seaman-Clark Hardware Co.
Albia, Iowa.

Every Loudon dealer should have a Loudon Silent Salesman.

A Silent Salesman is a producer—not an expense. It is the greatest creator of sales for barn equipment ever put in a store.

It is neat and convenient—a handsome fixture that is a credit to any store.

Hay carriers, especially, have always been hard to demonstrate, but with a Silent Salesman the customer will often "sell himself" before he mentions to the merchant that he needs an outfit.

Many dealers have laid the foundation for a big stall and stanchion business with the Silent Salesman. Many dealers who never sold a steel stanchion before ordering the Salesman are now doing a nice stall business.

On special orders any hay carrier desired may be substituted for the Loudon Junior, and, if desired, Covered Bird Proof may be substituted for the Standard Bird Proof track.

Send us your order for a Silent Salesman. It will help you build up a big barn-equipment trade.

We have **hundreds** of letters from dealers who are enthusiastic over the results obtained.

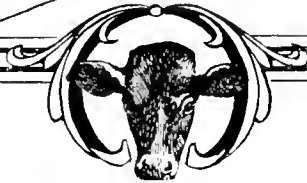

LOUDEN STEEL STALLS, STANCHIONS AND PENS

	PAGE
The Equipment of Dairy Barns.....	71-75
<i>By Wm. Loudon</i>	
Steel Stalls and Fittings.....	76-97
Standardized Mangers	98-101
Spring Balance Manger Divisions.....	102-104
Spring Balance Mangers.....	104-106
Stanchions.....	109-114
Water Bowls.....	115-119
Calf Pens.....	120-121
Cow Pens	124-125
Bull Pens	126-128
Hog Pens	129-131
Gates and Fittings.....	132-133
Building Columns.....	134-135
Cupolas and Ventilators	141-143
Window Ventilators	146
Manger and Gutter Drains.....	147-148
Paint	149

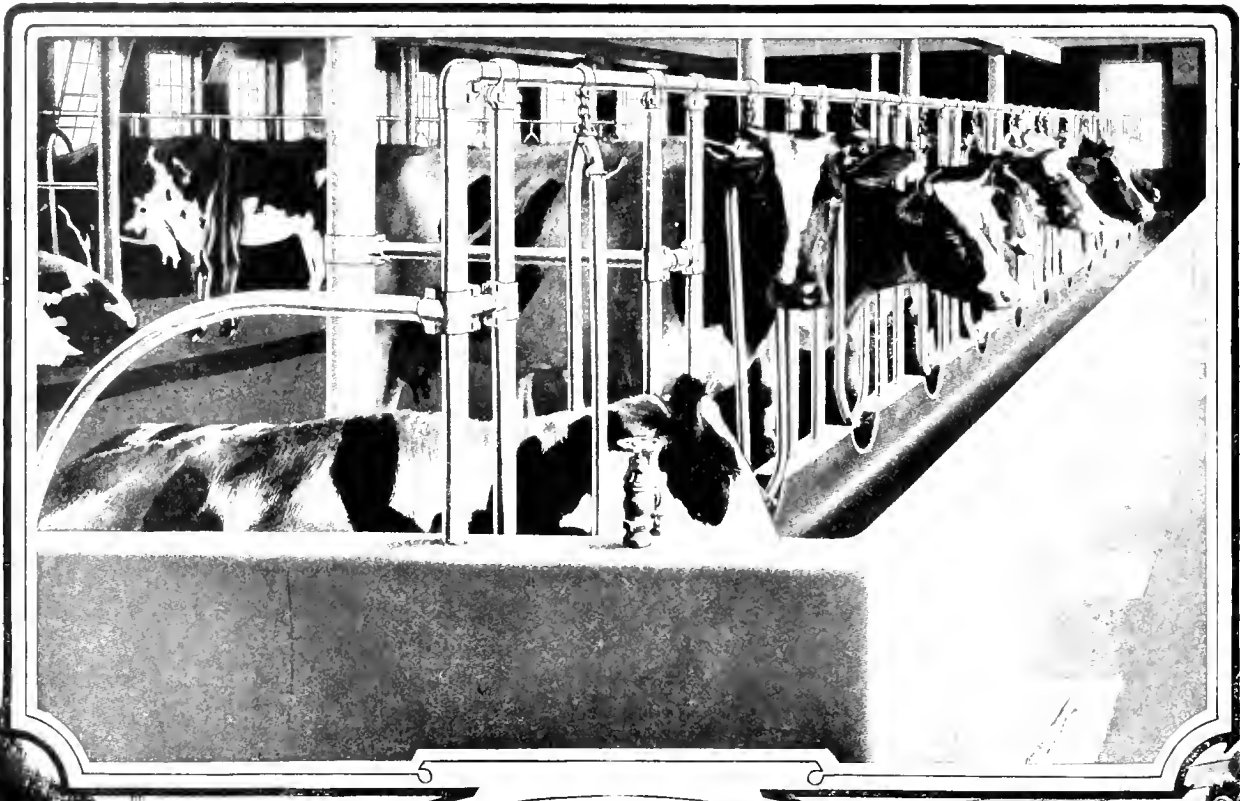

Louden Equipped Barns
are Sanitary and Economical, and the
Cows Enjoy True "Pasture Comfort."
Barn of W. S. Moscrip,
Lake Elmo, Minn.



The Equipment of Dairy Barns

By William Louden

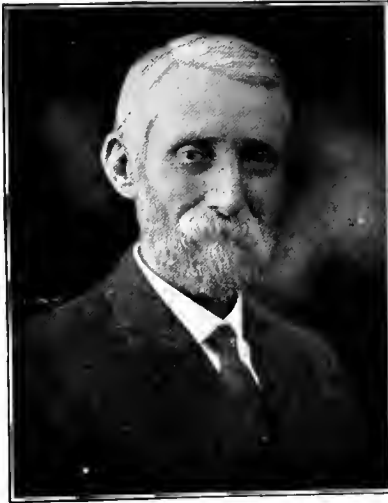

The growth of the dairy industry in this country during the last few years has been unprecedented. This growth marks an epoch in our history—the passing of the period of exploitation and the beginning of the policy of conservation. In all new countries, with cheap land and a virgin soil, dairying is more or less neglected, but as the price of land advances and its fertility decreases, dairying has to be taken up to save the soil and make farming profitable.

As the dairy business increases, better facilities are needed to keep pace with its development and to meet its requirements. This is particularly true of Dairy Barn Equipments. Milk production is the foundation of the dairy business, and anything that will add to milk production or make it more economical or profitable is important and should receive the most careful consideration.

It is well known that the cow is a sensitive animal, and that she will respond readily and liberally to comfortable surroundings and to kind treatment. She has the power of withholding her milk, and will divert her energies from its production to the protection of herself against uncomfortable or unsanitary conditions. This fact is known by all who have given attention to the subject. In numerous instances milk production has been increased from 30 to 40 per cent by making the cow more comfortable and giving her more sanitary surroundings.

This fact is further attested by the great increase and growing popularity of modern dairy barn equipments. The old style wooden stalls and stanchions, which were little better than ancient inquisition stocks, with their flagrantly insanitary features added to that of positive cruelty—seriously curtailing milk production, as well as injuring the cows and making the work harder—have been condemned, and are being rapidly discarded. It makes no difference how large or how small the herd, whether it consists of two or a hundred cows—whether the owner is an exclusive dairyman or a general farmer—he cannot afford to use this old style, out-of-date equipment.

In making the change from the old to the new, or in selecting a new equipment for the first time, the question arises as to the kind of equipment

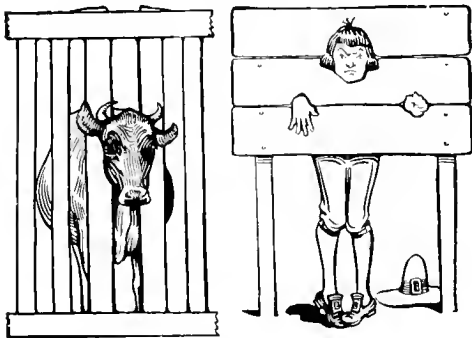

Equally Comfortable

to use, and the purchaser is sometimes puzzled in making a choice. One of the objects of this catalog is to assist in making a wise selection. Of course, the primary object is to point out the superior qualities of the Louden goods, but, in addition to this we desire to furnish the information necessary to enable the purchaser to get what will best suit his needs.

Above everything else we desire **satisfied customers**—customers who will not only be satisfied for the time being while the novelty of the thing is fresh, but who will **continue to be satisfied** as the years go by—the customers who will always be glad to **speak a good word**. These are the kind of customers required to build up and maintain a permanent business.

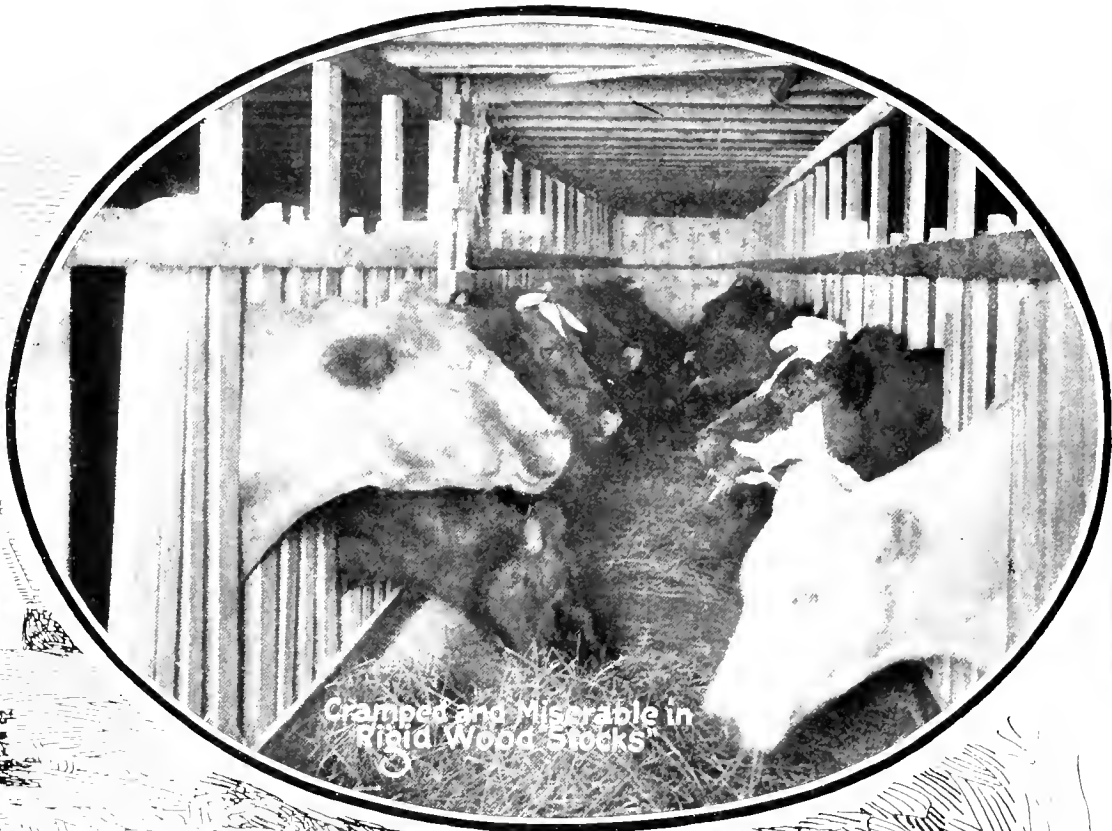

*Cramped and Miserable in
Rigid Wood Stocks*



Give Your Cows
the Comfort and Freedom of
Louden Swinging Steel Stanchions
and
Watch the Milk Yield Jump!

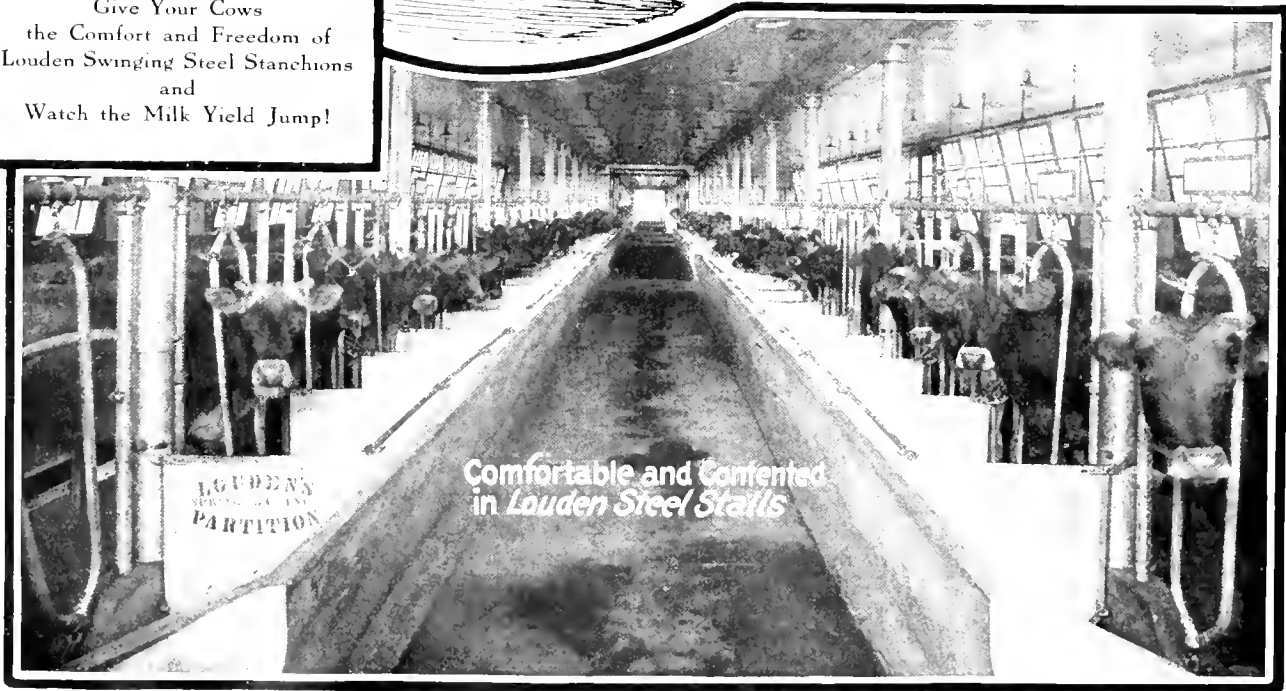

*Comfortable and Contented
in Louden Steel Stalls*

LOUDEN'S
PARTITION

We know our Dairy Barn Equipment is superior to anything else and we want you, as a prospective customer, to know it. Therefore, we wish to give you the fullest opportunity possible for a thorough investigation. If you have used our goods it would be unnecessary to say a word except to show you the improvements we have made since our last catalog was issued. We are sure that eventually you will use our equipments as many others are now doing who first tried something else. A dairyman having four barns, three of which are fitted with our equipments and the other one with an equipment of another make, being asked why he did not use the Louden Equipment in the other barn, replied, "This was the first barn we built and we profited on our other barns by our mistakes on this one." It is wise to profit by the mistakes of others.

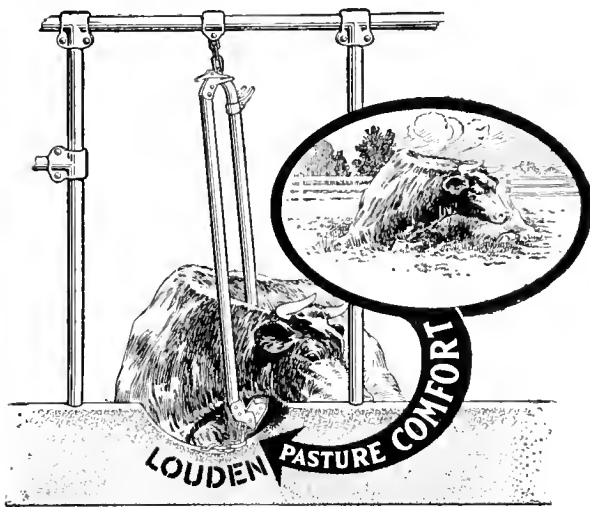

Two of the prime essentials in a dairy barn equipment are **cleanliness and comfort for the cow**. The cow should be made as comfortable in her stall as she is in the pasture. In short, "Pasture Comfort" is the condition to be sought for. While being securely held in place in the stall, she should be absolutely free to lie down to one side or the other, and to turn her head, or to lick her sides, without cramping her neck in the least, or straining herself in any way. A cow rarely lies down squarely in the middle of the stall, but nearly always at one side or the other. Therefore, the stanchion should always be anchored to the curb by a **single slack chain** that will permit its lower end to **swing in a circle of 8 to 10 inches**. No other arrangement will fill the bill.

A cow in getting up and lying down always pitches forward. Consequently the stanchion must be free to swing forward and back or she will be sure to jam her shoulders against it. When held by a stanchion too rigidly anchored the cow will sometimes make several attempts to rise before she succeeds and will jam her shoulders with each attempt. This condition should not exist. The lower end of a swiveled or swinging stanchion should always be **sloping or well rounded**, and **never anywhere near square or flat**; otherwise the cow will be liable to get her foot caught between the manger curb and the lower square end of the stanchion and have it severely injured. This cannot happen when the stanchion has sloping ends.

Cleanliness is equally as important as the comfort of the cow. "Sanitary" is the word generally used. Everything nowadays is "Sanitary," even "Sanitary" garbage cans. The word "Sanitary" being so badly overworked, we prefer to use the word "Cleanliness" which is said to be next to Godliness. The way to keep a dairy barn "Sanitary" is to make it so it will be **easy to clean and easy to keep clean**. It will not and it **cannot clean itself**. There should be no cracks or crevices anywhere to catch and hold dirt. Neither should there be any recesses or pockets in which dirt can collect, nor bars or pipes under which it can gather and be difficult to remove.

Especially is it necessary that the manger and the manger curb over which the cow has to eat should be constructed to afford **no refuge whatever for dirt**. Any attachments placed on the curb are liable to become "dirt catchers." In getting a new equipment be sure to avoid everything which may become a "dirt catcher."

Plainness, smoothness and simplicity are the things to strive for and not the addition of attachments which are frequently mere "talking points" having no

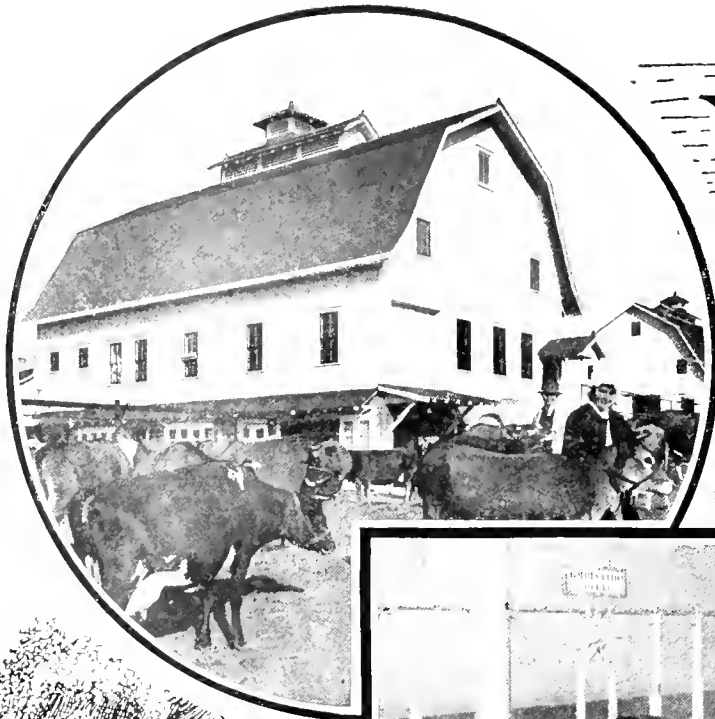

**J. H. BANNISTER'S LOUDEN
PLANNED AND EQUIPPED
BARN, KANSAS CITY, MO.**

Above: Dairy Barn and
Part of the Prize Herd.

Center: The Clean, Com-
fortable Milking Barn.

Below: Exterior, Showing Manure
Pit and Liquid Cistern.

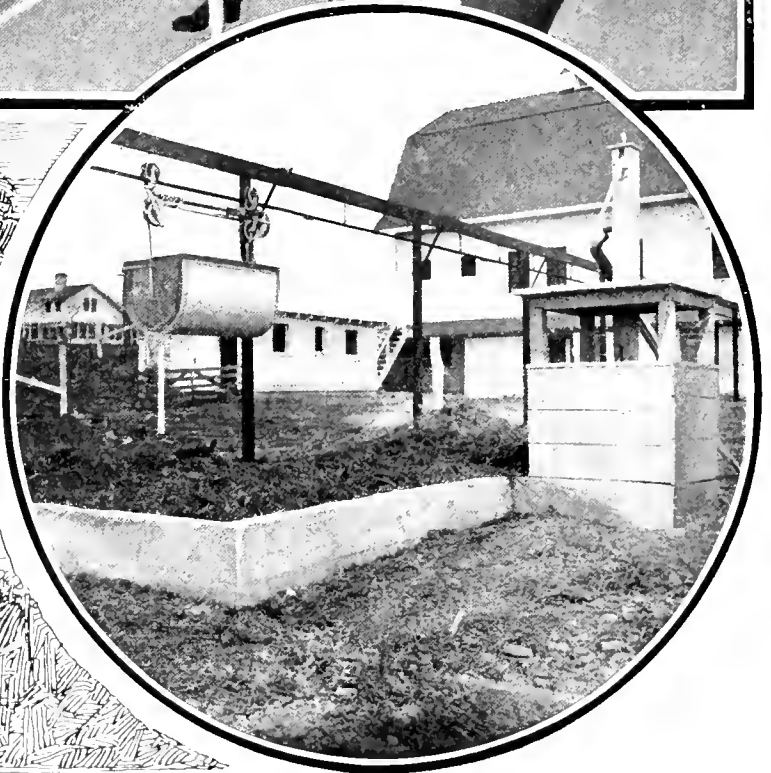
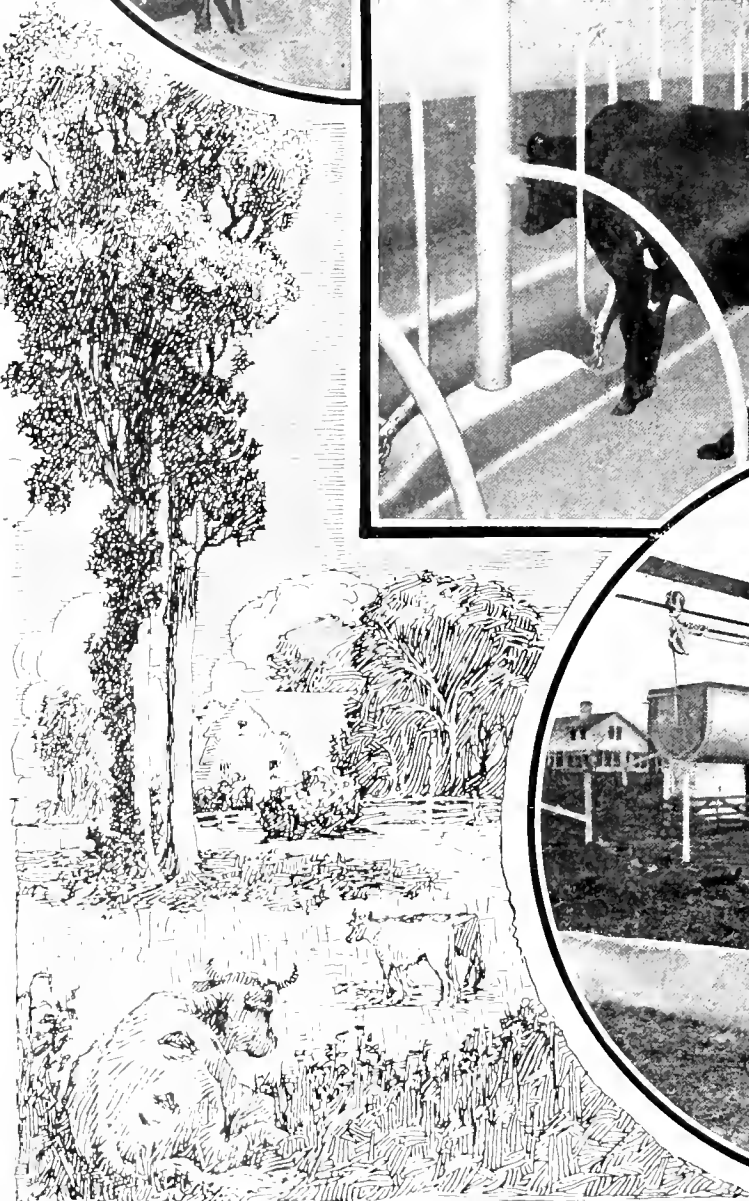
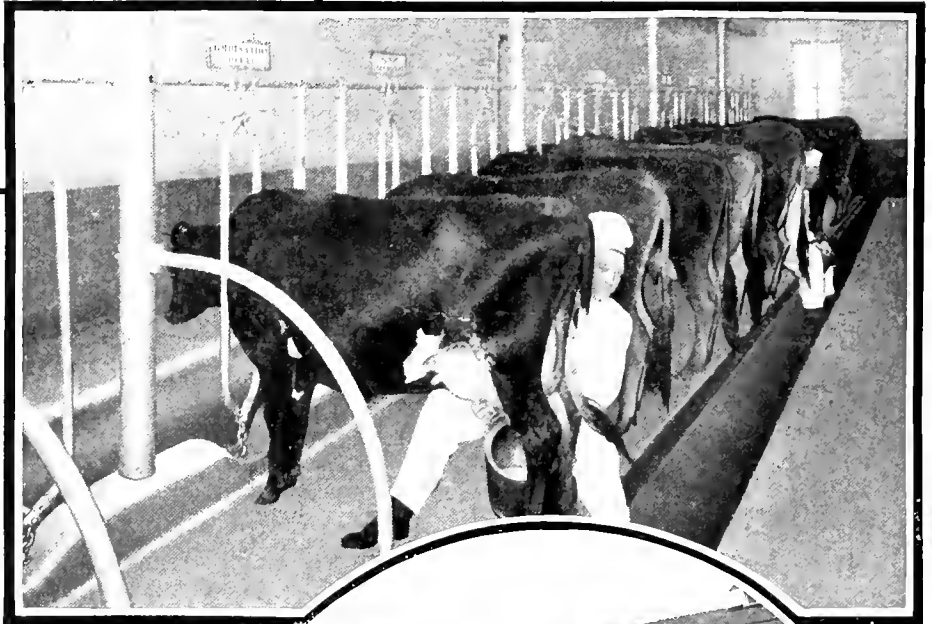

real value. In this way only can you have stalls and mangers which will be truly "Sanitary."

We have always made it a point to cut out attachments wherever possible and to make our stalls and stanchions, and pens and other equipments as plain and smooth as possible, and to have no sharp corners which might injure the animal. Also, to properly proportion the parts so attachments will not be needed. An examination of this catalog will show how well we have succeeded.

We have had the longest and largest experience in designing and manufacturing barn and stable equipments, our business being established nearly fifty years ago. We do not, however, rely on past achievements. We realize that the world moves and that an article which was good enough in the past may not be good enough for the present. We are always striving to make our goods better, and each year we spend thousands of dollars in improvements.

Our long experience teaches that every change is not an improvement. There are many illusions and delusions in this world. Sometimes the most "taking things"—things which for awhile will furnish the greatest selling points, do not **make good** when put to the test of time. We strive to avoid all such things no matter how alluring they may be, and spare neither time nor expense to **make sure** that our improvements are **genuine** and not merely fads or fancies which will soon pass away.

In conducting an extensive business, and with thousand of people to deal with, we find that there is apparently no end to the different ideas, and sometimes we have to make things just to please the purchaser. In so doing, our aim is to make the very best article of the kind that can be made and to always give **value received**. We do not wish to dictate or even seem to dictate, but we will always be frank in recommending what we think is best.

During the last few years we have given much time and study to the **standardization** of our goods. Our **Standardized Mangers** for cow stalls and our improved methods of constructing them are the greatest improvements made in dairy barn equipments during the last decade. Agricultural Colleges throughout this and other countries have adopted our Directions for the instruction of their classes in the proper method of making mangers for cow stalls.

Perhaps some who read this catalog and look at the elegant equipments shown will think they are "only for the rich." This is a mistaken idea. Louden Equipments are made for persons of moderate means as well as for those who have greater wealth and are **within the reach of every farmer**. Standardization enables us to produce better goods at less cost and we are always glad to give our customers their full share of the benefits resulting therefrom.

We do **not** say, nor wish to intimate, that if any one buys our equipment, he will "get rich quick" or immediately become a millionaire. Such claims would not interest sensible people. We **do** say that our equipment is, not only **the best that is made**, but that it will return **a good profit on the investment** whether the purchaser is rich or only in moderate circumstances.

We are particular to use the best material in the manufacture of our goods, and to have everything strong and durable. We have a thoroughly equipped, up-to-date factory and ample facilities to properly handle the business. We have our own galvanizing plant and malleable iron foundry and this catalog will show that we have the largest and most complete line of Dairy Barn Equipments in the world.

We have Branch Houses in several leading cities. Our goods are also carried in stock in various parts of the country. In every way we strive to give not only the very best goods which can be made, but also the very best possible service. Upon this basis we solicit your patronage.

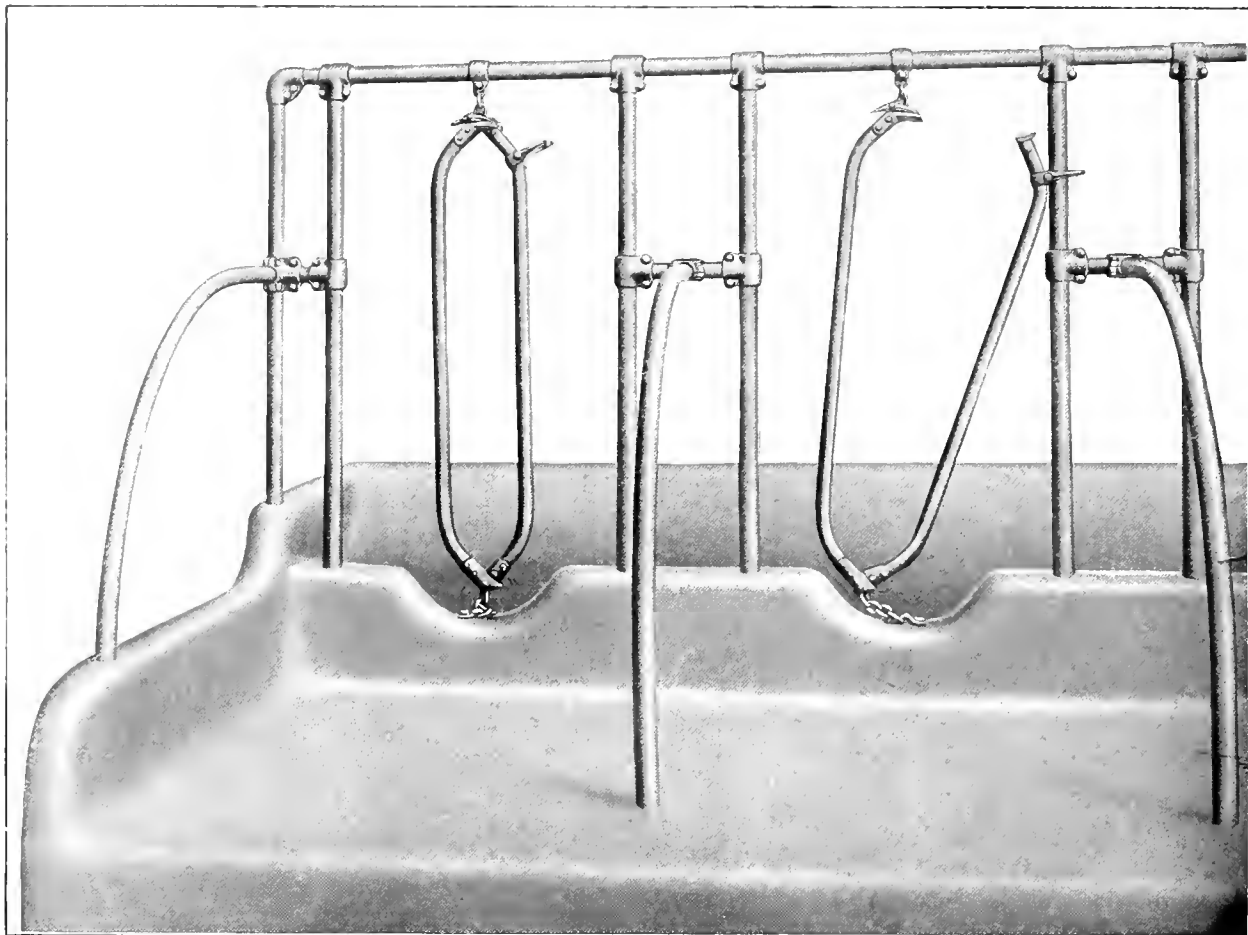

The Louden Cross Braced Double Post Cow Stall—Fig. 812

Patented, May 20, 1913

If we were to cease the manufacture of all other cow stalls and confine ourselves to a single pattern, it would be our **Cross Braced Double Post Stall, Fig. 812**. It is not only the best, but is also the most popular stall manufactured. The following are some of its most prominent features:

Perfectly Proportioned. The stall posts are so spaced that there is a good separation between the feed in the manger and the bedding on the stall floor, while, with our flexibly hung stanchions, there is ample room between the posts for the comfort of the cow. The posts are set the proper distance apart to let the stanchion open wide enough to receive the cow's head, and yet not so wide that the cow can walk right through it. This is one of the faults of single post stalls. It is entirely overcome in our 812 stall.

No Attachments Needed. With single post stalls the cow is liable to place her head in the space between the post and stanchion and to prevent this, attachments of different kinds are used to at least, partially remedy the defect. Nothing of the kind is needed with our 812 Stalls. While the posts are set wide enough apart to give the cow ample freedom to lie down at one side or the other, and to turn her head or lick her side without cramping, the space is not so wide that the cow is liable to get her head in the wrong place. There is just **one place** where the cow can put her head and that is in the **open stanchion**, and it will never be so wide open that she will be tempted to force her body through it.

Simplicity of Construction. There are no complicated parts about this stall to get out of order and cause trouble. In addition to the stanchion, it consists of the **continuous top-rail**, the vertical stall posts, the **cross brace**, and the bent stall partition with the necessary couplings to hold the parts together. The cross braces are made of different lengths to suit different widths of stalls, whereby the **proper proportions are always preserved**.

Louden Cross Braced Double Post Cow Stall—Fig. 812

Specifications of Standard Size

Size of Tubing. The stall posts, stall partition, top-rail and cross brace are all made of the best quality of $1\frac{5}{8}$ O. D. steel tubing—smooth and exceedingly strong. No second hand pipe or tubing is used in the construction of our stalls.

Width. The standard width of the stall is 3 feet 6 inches (42 in.) but this may be varied to suit requirements and the top-rail will be cut to suit.

Height. The total height above the stall floor is 5 feet, 3 inches (63 in.). The standard height of the manger curb at the sides is 11 inches and at the bottom of the cut-out where stanchion is anchored is 6 inches. Distance from stanchion anchor to the underside of top-rail, 4 feet 7 inches (55 in.).

Length of Posts. The stall posts are 5 feet 5 inches (65 in.) long and with the standard High Built-Up Curb they go 15 inches into the cement. The lower ends of posts and partitions are indented to insure a better hold.

Stall Partitions. The cut shows our No. 3 Single Bend Partition which we recommend and which we furnish unless otherwise specified. The lower end of the partition goes 5 inches in the cement. It stands 3 feet 6 inches (42 in.) above the stall floor at the inner end and the same distance out from center of curb at the bottom. Our No. 2 or No. 5 Partition, described on another page, will be substituted if preferred.

Stanchions. The cut shows our Tubular Steel Stanchions, Fig. 861, which we recommend and furnish with stalls unless otherwise specified. If preferred, we will furnish our Wood-Lined Stanchions, Fig. 937, at the same price, or our Five-in-One or Quick Adjustable Stanchion at an advance in price.

Finish. All the parts except the U bolts which are sherardized, are finished with our Special Dairy Barn Paint, or will be galvanized if ordered.

Illustration. The cut shows two stalls and one end section on the cross alley where the end curbs are located. When there is an alley at each end of a row of stalls, an extra end section is required for which an extra charge will be made.

812 Stall Complete includes: 2 Stall Posts; 1 Stall Partition; 42 inches of top-rail (more or less); 1 Cross Brace, 10 inches long (more or less); 5 Interlocking Dust-Proof

Couplings; 1 Tubular or Wood-Lined Stanchion; 1 Stanchion Holder; 1 Guide or "Hold-Open" for Stanchion, and 1 Standard Stanchion Anchor.

End Section Complete includes: 2 Stall Posts; 1 Stall Partition; 1 Cross Brace, 5 inches long (more or less); no top-rail; 2 Interlocking Dust-Proof Couplings; 1 Right Angle Corner Coupling, and 1 Single Piece Elbow.

Weights. The Standard 812 Stall complete with Tubular Stanchion and 42 inches of top-rail weighs 70 lbs. The Standard End Section, complete, no top-rail, weighs 45 lbs.

Note: Stalls wider or narrower than 42 inches and requiring longer or shorter top-rails will weigh a pound or two more or less. The Wood-Lined, Five-in-One or Quick Adjustable Stanchion will also add a little to the weight.

Note: When one end of a row of stalls is joined to a wall the end section at the other end will be counted as a part of the stalls, but if a wall flange or a partition next the wall is used, or a post is set between the stanchion and the wall or is extended up to the ceiling, an extra charge will be made for these parts.

Dennison, Minn., Sept. 12, 1916

Louden Machinery Co.,
St. Paul, Minn.

Gentlemen:

Have now had 46 cow stanchions and stalls, calf pens and litter carrier installed for nearly three years and cannot speak too highly of the equipment.

It is in just as good condition now as on the day it was installed. In addition to its strength and durability, it gives the cows a comfort, freedom from lice, light, airiness and ease that convince me I would not go back to the old fashioned wood stanchions for any price.

Several new barns have been built in this vicinity and they have also been equipped with Loudon Stanchions, which proves that they appeal to the farmer who is alive to his own interests.

Yours truly,
J. O. Lysne.

The Couplings, a transparent view of which is shown by Fig. 933, are interlocking and practically dust-proof, two bolts only being required to hold the parts together. The upper ends of the couplings on the top-rail, where dust is most likely to settle, are **perfectly smooth**; also the side ends on the stall posts are smooth where the cows are likely to rub. No other couplings begin to compare with these. They are the strongest and most durable, and are the easiest to clean and keep clean.

The Manger Construction. The cut shows one of our Standardized Mangers with High Built-Up Curb (standard height 11 inches) with a cut-out where the stanchion is anchored, so it will only be the standard height at this point. By this means the cow cannot nose her feed out on the stall floor and at the same time there will be plenty of throat space for her to lie with her head low down in the manger, or to turn her head to the side in the stall. The cut also shows our latest design of High Built-Up End Curbs for the manger and the stall floor, to prevent the feed and the bedding from getting out into the alley. These curbs and mangers with their corners so completely rounded, and all so smooth and perfectly molded, are positively the "last word" in manger construction.

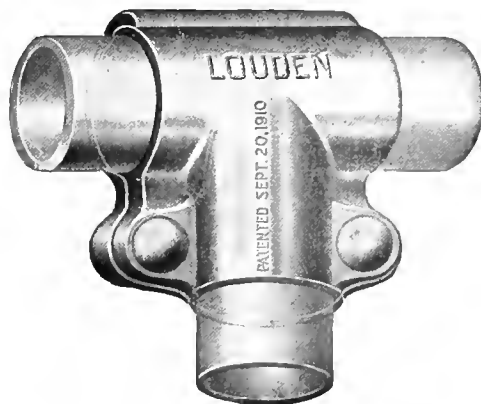

Fig. 933. Patented Sept. 20, 1910; July 25, 1916.

Strength and Durability. When this style of curb is used the stall posts will stand **15 inches in solid cement**—11 inches in the curb and 4 inches in the stall floor. We do not use sawed off posts held only by flimsy connections which can neither be lined up properly nor held in line. In addition to this, the posts are **braced together** a little over half way up between the curb and the top-rail. The cross braces are short pieces of tubing (the same size and quality as the posts, which are of the best high carbon tubular steel) and are connected thereto by our Interlocking Dust-Proof Couplings.

Strengthened Stall Partition. In addition to strengthening the posts, this arrangement strengthens the stall partitions more than **One Hundred per cent.** This may sound extravagant, but it is true, as will be readily seen by an inspection of Fig. 1147. The upper ends of stall partitions are usually clamped to the vertical stall posts, and no matter how tightly the clamping bolts may be drawn, a side strain on the partition will cause the clamp to slip on the post and permit the partition to give way sidewise. By clamping the end of the partition to the cross brace this cannot occur. The coupling would have to break or both stall posts would have to bend before the partition could give a particle. This is a valuable feature and is found only in our 812 Stall.

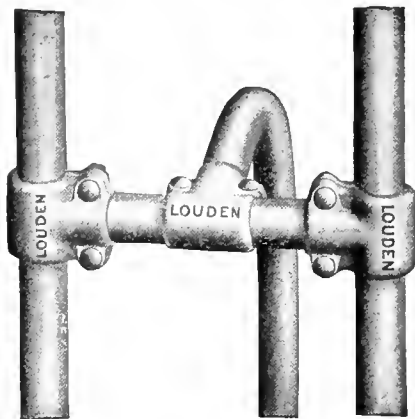

Fig. 1147

The Connection of End Partition. The end partition, while it is arranged to stand flush with the end post on the alley, is as **solidly connected** as the center partitions, as will be seen by Fig. 1148. A short cross brace is clamped to an adjacent post and then this brace and the upper end of the partition is clamped to the end post by one of our corner couplings, as plainly shown in the cut. In this way the end partition is solidly connected to both of the posts, making it as secure as if it was clamped to one of the center braces connected to two of the center posts.

A Popular Stall. This is an exceedingly popular stall and undoubtedly there are more of them in use giving the best of satisfaction than any other stall manufactured. The Dairy Division of the U. S. Department of Agriculture recommends this stall, and it is being used in a number of Government Barns. It is also used in a number of State Institutions and in the dairy barns of Agricultural Colleges, as well as by thousands of the most progressive up-to-date dairymen in this and other countries.

It Fills the Bill in Every Particular. It is well built, strong and durable, and of neat design. It is properly proportioned and is without any clap-trap attachments or objectionable frills of any kind. It is a thoroughly business stall. It insures the comfort of the cow. It is plain and smooth and simple in construction, and is easy to clean and easy to keep clean, thus filling all requirements of an up-to-date cow stall.

The Fittings. Our Tubular Steel Stanchion which is shown in the cut, is included in the fittings, but any of our flexibly hung stanchions with sloping or rounded lower ends may be used. The guide or "Hold-Open," secured to the upper end of the hinged side of the stanchion is also included, as well as the stanchion holder connected to the top-rail and the anchor set in the curb. Other fittings may be added, such as manger division, for separating the manger into compartments; water bowls, throat chains, and other things shown on other pages of the catalog, for which an extra charge will be made.

Beware of Infringements. We desire to call attention to our patents on this stall and on our stall couplings, and to warn all whom it may concern against infringements. The patent on the stall is dated May 20, 1913, No. 1,062,295, and on the coupling, September 20 1910, No. 970,737, and July 25, 1916, No. 1,192,216. These improvements are too valuable to let them go by default, and we do not propose to do so. We are amply prepared to supply these stalls and couplings in any quantities upon reasonable terms. Therefore, there is no necessity for buying infringing devices, which at best would **only be imitations** and would not possess the full measure of the valuable features of the Louden goods.

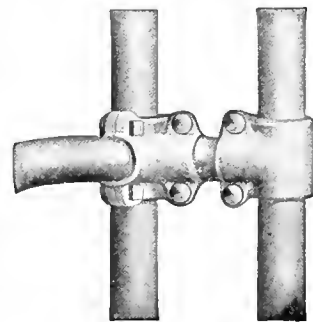

Fig. 1148

Complete Directions are furnished for setting up the stalls and constructing the mangers which will enable any person of average mechanical skill to do a first-class job. Also tools, for which see page 101.

Wood Will be Discarded. It will not be many years until **wood will be entirely discarded** in dairy barns for stalls, stanchions, mangers, animal pens or other similar purposes. During the recent outbreak of the foot-and-mouth disease, in a number of cases, government inspectors ordered the wooden parts of the equipment to be torn out and destroyed. The metal and concrete parts could be easily disinfected but it was difficult to disinfect the wood so as to kill the disease germs. This applies to the wood lining of stanchions as well as other wooden parts.

Louden Stall Partitions

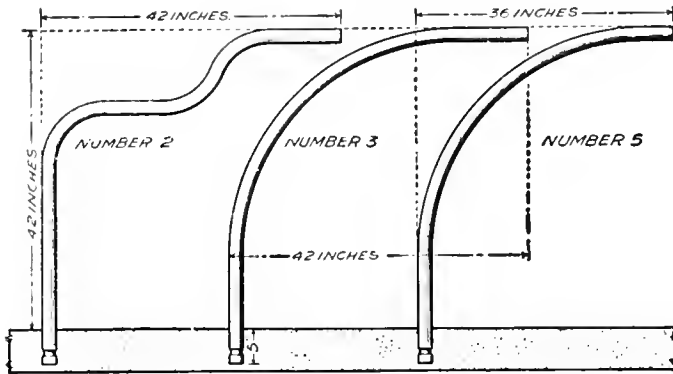

Fig. 994

Specifications

Standard, made of 1 $\frac{5}{8}$ O. D. high carbon steel tubing. Height and width given in cut. Lower ends go 5 inches in the concrete.

Fittings. When used with our complete stalls the fittings are included, except when the partitions are to be set on a floor. In that case 5 inches will be cut off the lower ends, and Floor Flanges will be used.

Weights. Standard size, No. 2, weighs about 14 lbs.; No. 3, 13 lbs.; No. 5, 12 lbs.

The Partition is an important part of a Cow Stall. It is necessary to prevent a cow from stepping on her neighbor and bruising her udder or crushing her teats when she is lying down. Also, to prevent her from turning sidewise and crowding an adjacent cow

without partitions and dairymen who have tried to do without them have finally been compelled to use them.

We make three different styles of partitions, as shown by Fig. 994. We recommend our No. 3 for large and medium size cows and No. 5 for small cows. Nos. 3 and 5 are alike except that No. 3 is 6 inches longer. By cutting off this extra 6 inches it will become a No. 5. No. 2 is fancied by some people, especially those who have not had the greatest experience. We are the original designers of the No. 2, but our experience has taught us that it is not as good as No. 3 or No. 5, for the following reasons:

1st. The triple bend makes it weaker than the single bend. 2d. It is harder to line up and will not line up at all when the view is quartering. 3d. There is a liability of the cow being crowded on to the flat part of the "Sway-Back" and hanging there so as to injure her udder. 4th. If the cow should happen to get down under the partition it would be more difficult for her to get up from under the No. 2 than the No. 3 or the No. 5.

However, this is a matter for purchasers to decide. If you prefer the triple bend (the "Goose-Neck" or the "Sway-Back" as it is sometimes called), to the plain Single Bend Partitions, we have nothing further to say. The No. 3 partition will be furnished with all Louden stalls except the Co-Right unless otherwise specified.

The Louden Machinery Co., Fairfield, Iowa.

Gentlemen:

I wish to state that the Barn Fixtures I bought from you in 1914 have given the very best of satisfaction and we can assure you that we are more than pleased with them.

Please send me your latest General Catalog.

Hayward, Wis., July 1, 1916

C. D. Benack, Prop.

Idlehurst Lodge Farm and Summer Resort on Round Lake.

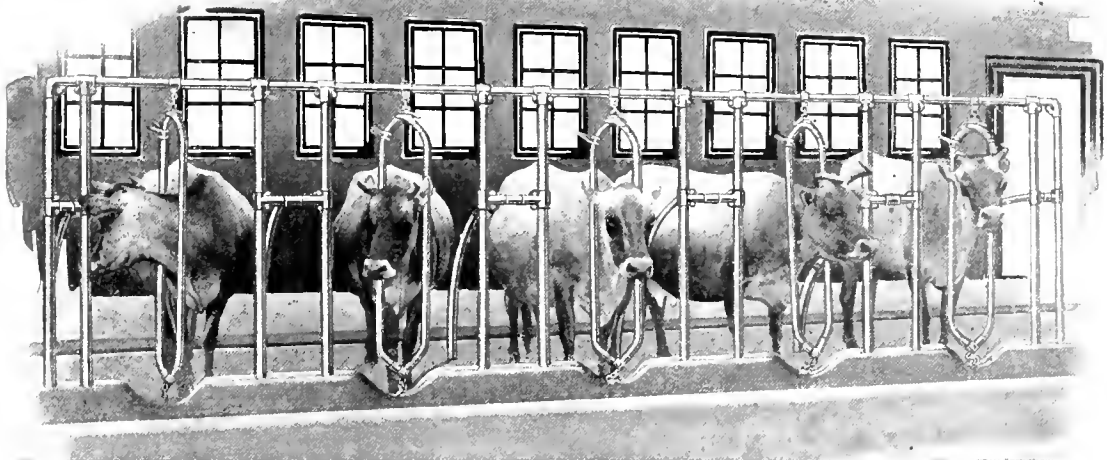

A section of a well-lighted dairy barn equipped with the Louden 812 Stalls, Tubular Steel Stanchions, and High Built-Up Manger Curb. The cows certainly look contented and comfortable.



Interior view of the new round barn of the Hershey Company of Hershey, Pa., manufacturers of the famous Hershey Milk Chocolates; fitted throughout with Loudon Equipments. See what the manager says on next page.

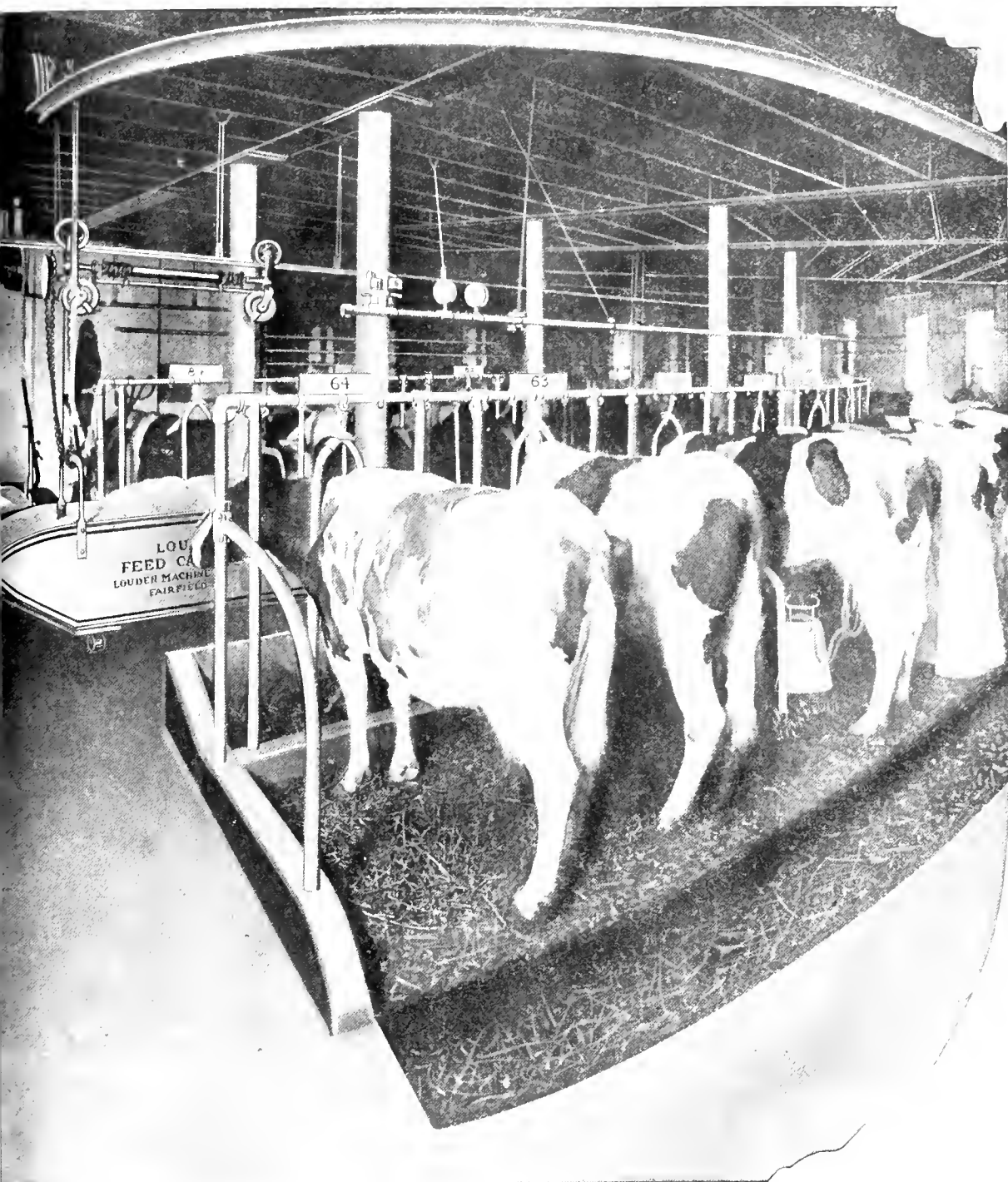

To Whom It May Concern:

Hershey, Pa., May 15, 1914

As one of the Hershey Farm managers I consider the Louden Stalls and Fixtures the best I have seen or tried. They are better made, simpler, and stronger than any barn equipment in the market that I have yet seen, and we have three different makes in use. I thoroughly recommend them.

F. B. Snively, Mgr. Hershey Farm Co.

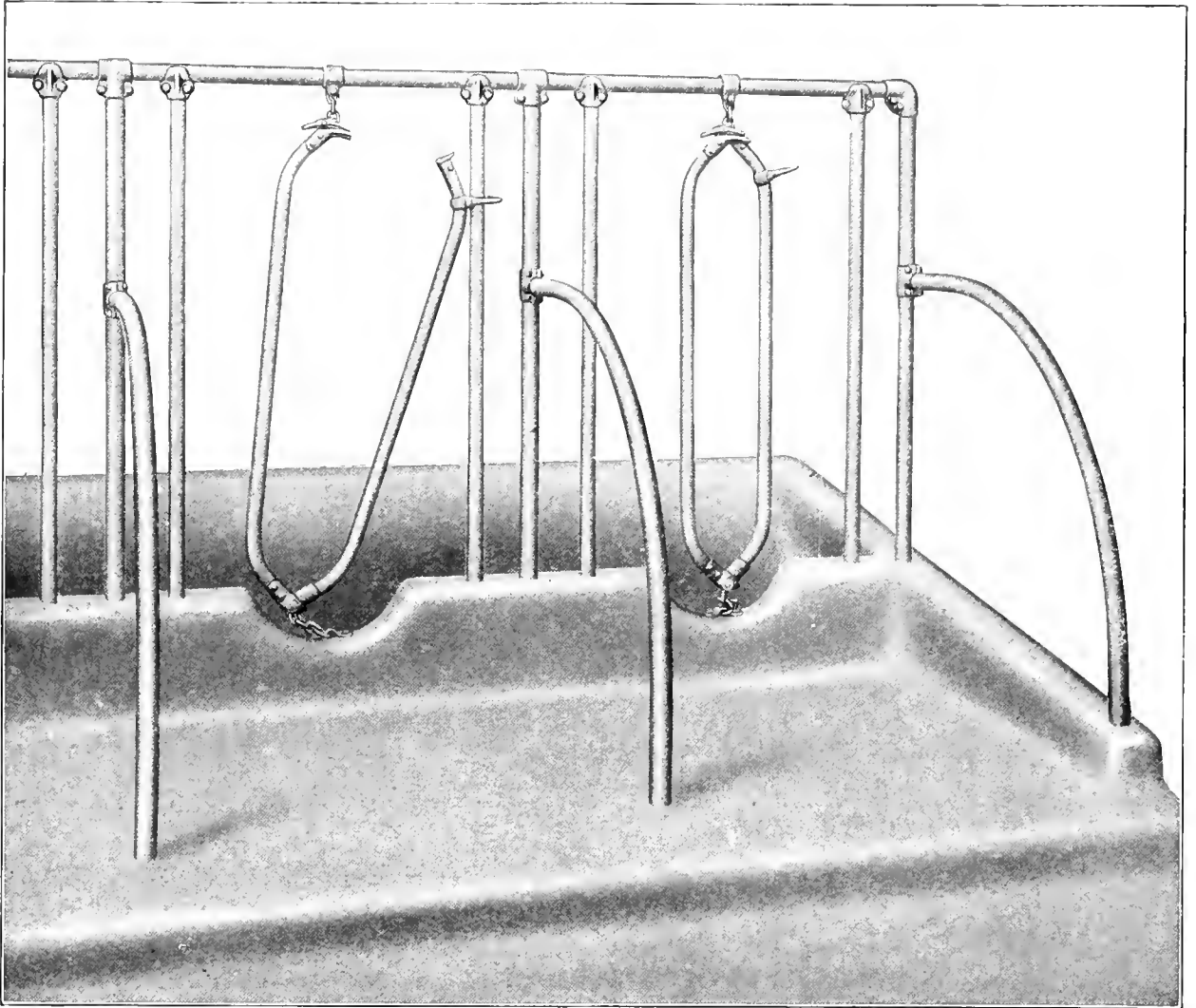

Louden Triple Post Cow Stall—Fig. 810

This is a good, substantial stall. It is well proportioned, and has most of the special Louden features, such as simplicity and smoothness of construction and the Interlocking Dust-Proof Couplings. The side posts can be set wider or narrower as may be required for wider or narrower stalls, thus **preserving the proper proportions** between the posts so the cow will not be liable to put her head in the space between the stanchion and the post.

Also, what is of even greater importance—the stanchion will not open so wide that the cow can walk right through it. Such being the case, no extra attachments will be required to cure defects. There is a good separation between the feed in the manger and the bedding on the stall floor. The manger construction shown in the cut is up-to-date in every respect, the corners all being completely rounded to prevent injury to the cow, and to avoid “Dirt Catchers” which are the bane of many dairy barns.

It has the Louden **High Built-Up Curb** at the sides of the stanchions, and also the end curb to prevent the feed and bedding from getting out into the alley. The cut shows the end curb is sloped from the top of the manger to within a few inches of the stall floor at the gutter, but if preferred, it may be made level from the top of the manger to the stall post and then level from the manger curb as shown by Fig. 812.

This stall is specially adapted to use with columns or large posts, as shown by Fig. 934, Page 134. The stall partitions are connected directly to the columns by our large post couplings, see N-14 and N-15, Plate 15, Page 136. When a large post or column is used and the stalls are narrow the side posts are generally dispensed with.

Louden Triple Post Cow Stall—Fig. 810

Specifications of Standard Size

Sizes of Tubing. We use $1\frac{5}{8}$ O. D. steel tubing for the center posts, stall partitions and top-rail. The side posts are $1\frac{1}{16}$ O. D. tubing.

Note: The width and the height of 810 Stalls, and the lengths of the posts, are the same as the 812 Stalls. See Specifications on Page 77. The stall partitions, the stanchions, and the finish are also the same.

Illustration. The cut shows two stalls and one end section on the cross alley where the end curbs are located. When there is an alley at each end of a row of stalls, an extra end section is required for which an extra charge will be made.

810 Stall Complete consists of 1 Center Stall Post; 2 Side Posts, 42 inches of Top Rail (more or less); 1 Stall Partition; 2 Interlocking Dust-Proof Couplings; 2 Grip Clamps for side posts (See N-19, Plate 15, page 136); 1 Tubular or Wood-Lined Stanchion; 1 Regular Stanchion Holder; 1 Guide or "Hold-Open" for Stanchion, and 1 Regular Stanchion Anchor.

810 End Section, consists of 1 Main Stall Post; 1 Partition; no top-rail; 1 Interlocking Dust-Proof Coupling; 1 Grip Clamp, and 1 Single Piece Elbow.

Weight. The Standard 810 Stall complete with Tubular Steel Stanchion and 42 inches of top-rail weighs $72\frac{1}{2}$ lbs. The Standard 810 End Section, no top-rail, weighs 37 lbs.

Note: Stalls wider or narrower than 42 inches and requiring longer or shorter top-rails will weigh a pound or

two more or less. The Wood-Lined, Five-in-One or Quick Adjustable Stanchion will also add a little to the weight.

Note: When one end of a row of stalls is joined to a wall the end section at the other end will be counted as a part of the stalls, but if a wall flange or a partition next the wall is used, or a post is set between the stanchion and the wall or is extended up to the ceiling, an extra charge will be made for these parts.

River Falls, Wis., Dec. 20, 1915

Louden Machinery Company

Fairfield, Iowa

Gentlemen:

I now have my fixtures installed complete and am very proud of the result. They lighten the work and make it a pleasure. My barn now presents an excellent example of what can be done with a somewhat old and not overly well-planned barn by a judicious use of modern fixtures. Should you ever care to direct visitors to view this transformation, I bid them hearty welcome. I am now a Louden Booster.

Thanking you most heartily for your courteous and considerate treatment, I am

D. E. Flower,

Flowercrest Herd.

Louden High Built-Up Curb and the Low Level Curb—Fig. 1187

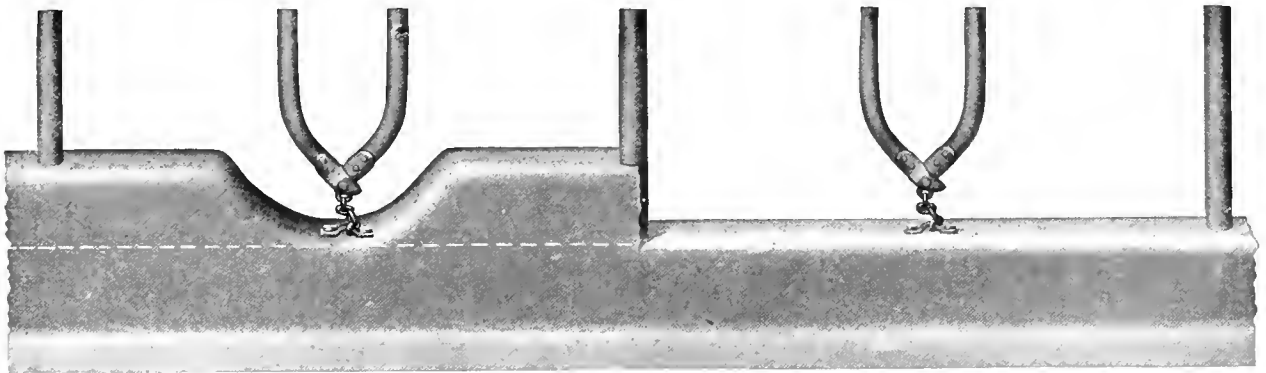

Fig. 1187

Fig. 1187 shows the difference between the ordinary level curb and the Louden High Built-Up Curb with cut-out for stanchion. The dotted line shows the difference in height.

The Louden stanchion has a distinct advantage over any other type, in that it can be used with either the Built-Up Curb or the low level curb. Double-chain-hung or square bottomed stanchions, or those that require wide, flat anchors cannot be used with a Built-Up Curb. They must be hung on a level curb not more than 6 inches high, to allow the cow to lie down comfortably when in the stanchion.

The lowest point in the "cut-out" of the Built-Up Curb is the same height as the top of the ordinary level curb. The top of the curb is 5 inches higher.

This design allows the stanchion to hang low enough for the comfort of the cow but does not permit her to nose her feed out of the manger. Feed is never thrown out of the manger directly behind the cow's nose, but always to one side or the other.

With the Louden tools it costs no more to put in the High Built-Up Curb than the low level type. Its handsome design improves the appearance of the stall row, and the saving of feed commends it.

We are prepared to furnish all forms for manger and curb construction.

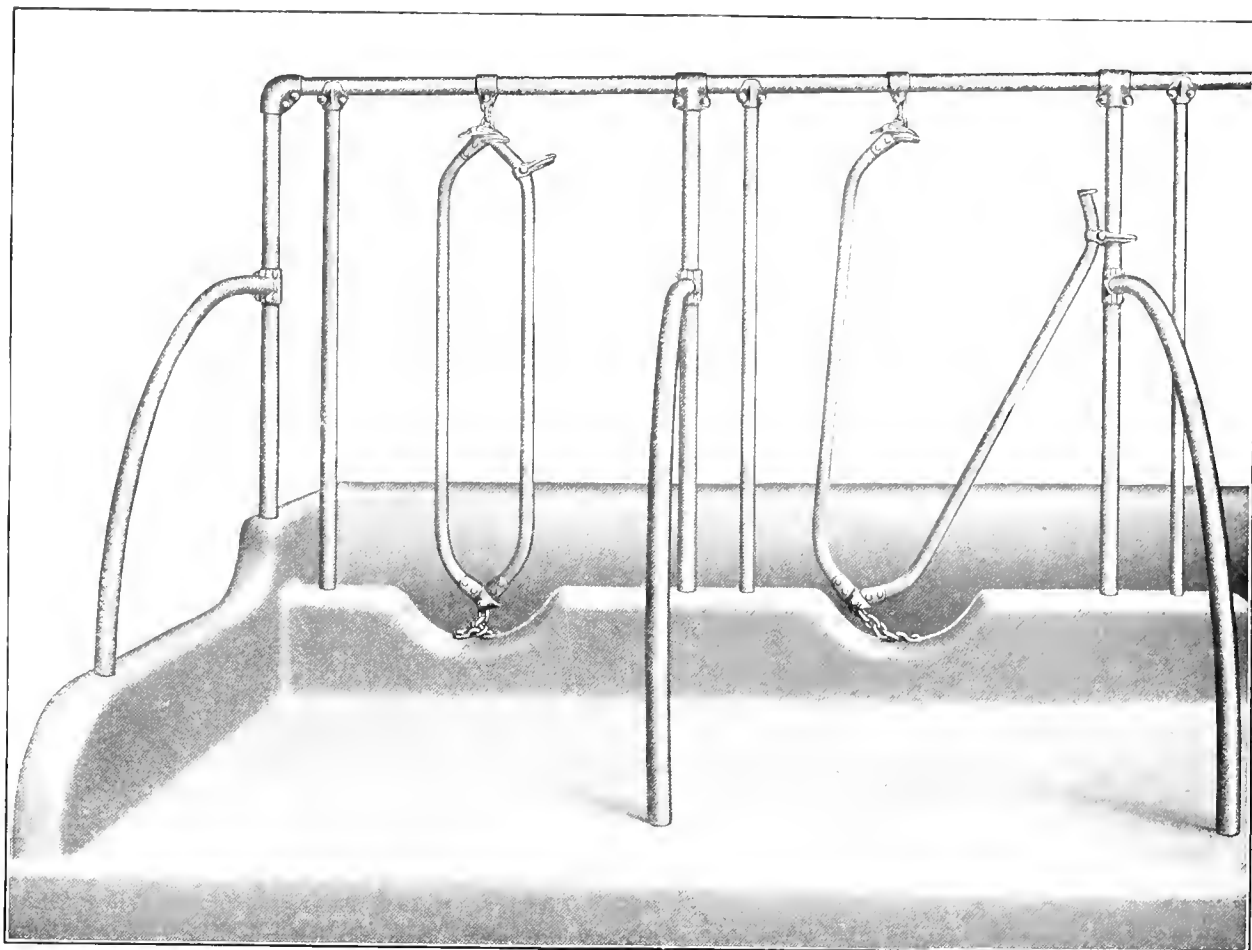

Louden Side Post Stall—Fig. 959

Our Side Post Stall is the same as our Triple Post Stall, Fig. 810, with the side post next the open side of the stanchion left off. It is a simple, neat appearing stall—exceedingly smooth and easy to clean and keep clean. It has our Interlocking Dust-Proof Couplings and other special Louden Features. Any dairyman or farmer who has small-sized cows, or who has to provide stabling for young stock, will find this a very satisfactory stall.

When a wider stall is required, the stanchion may be prevented from opening too wide by using our Stanchion Side Chain which is attached to the top-rail and to the open end of the stanchion, as shown by Fig. 1149. This chain takes the place of the guide or “Hold-Open” generally used to catch on the adjacent stall post and hold the stanchion in open position to receive the cow’s head. When the stanchion is closed the slack in the chain will permit it to turn freely, thus giving the cow the necessary freedom of movement.

The Louden Stanchion Side Chain is 11 inches long, and is fitted with a Pressed Steel Clip at each end (see N-24, Plate 15, page 136), the clip at the lower end being adapted to clamp on the open end of the stanchion, and the clip at the upper end to clamp on the top-rail as shown in cut. **Be sure to specify** the size of the top-rail so we can furnish clip to fit.

Fig. 1149 also shows our **Improved Throat Chains**, which are also fitted with our Pressed Steel Clips which may be adjustably attached to the posts of any of our stalls. There are a pair of chains each 27 inches long and each having a hook on its free end so they can be hooked together, high or low, as may be wanted. Dairymen will find our throat chains useful for a number of purposes. The clips are made for $1\frac{5}{8}$ and $1\frac{7}{8}$ O. D. tubing. **Be sure to specify size in ordering.**

Louden Side Post Cow Stall—Fig. 959—Continued

Specifications

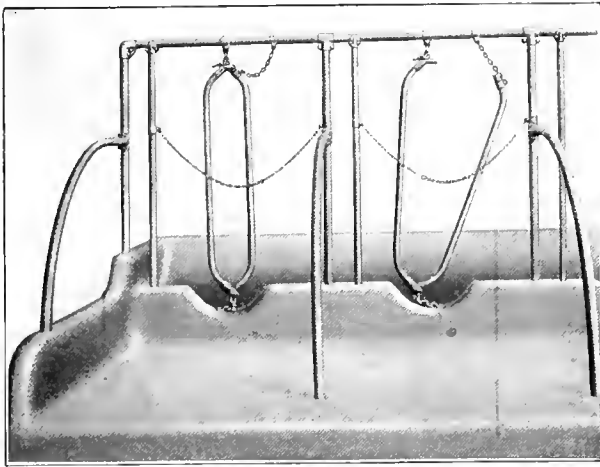

Fig. 1149

Standard Size. The top-rail, main posts and partitions are made of 1⁵/₈ O. D. best quality of steel tubing. The side posts are made of 1⁵/₁₆ steel tubing.

Note: The height of 959 Stalls and the lengths of the Posts are the same as the 812 Stalls. See specifications on page 77. The Stall Partitions, the Stanchions and the finish are the same.

Illustration. The cut shows two stalls and one End Section on the cross alley where the end curbs are located. When there is an alley at each end of a row of stalls, an extra end section is required for which an extra charge will be made.

Fig. 959 Stall Complete consists of 1 Main Post; 1 Side Post; 1 Stall Partition; 39 inches of Top-Rail (more or less); 2 Interlocking Dust-Proof Couplings; 1 Grip Clamp; 1 Tubular or Wood-Lined Stanchion; 1 Regular Stanchion Holder; 1 Guide or "Hold-Open" for Stanchion, and 1 Regular Stanchion Anchor.

End Section Complete consists of 1 Main Post; 1 Stall Partition; no Top-Rail; 1 Interlocking Dust-Proof Coupling; and 1 Single Piece Elbow.

Weight. 959 Stall complete with Tubular Steel Stanchion and 39 inches of top-rail, 62¹/₂ lbs.; End Section Complete (no top-rail), 29 lbs.

Note: When one end of a row of stalls is joined to a wall the end section at the other end will be counted as a part of the stalls, but if a wall flange or a partition next the wall is used, or a post is set between the stanchion and the wall or is extended up to the ceiling, an extra charge will be made for these parts.

St. Ansgar, Iowa, July 16, 1916.
Louden Machinery Co., Fairfield, Iowa.
Gentlemen:

In reply to yours of recent date wish to say that I am very well pleased with the equipment I bought from you two years ago and am satisfied that no man would go wrong in buying equipment from your Company. For the treatment I received was prompt and courteous and the workmanship and material are of the best. Will try to send you a photo of my barn at some future time should you wish it. And will be glad to have prospective buyers look over my equipment at any time and I will recommend it as being the best line of barn equipment that I know of.

Robt. Doscher.

Separate Stalls or a Continuous Top-Rail—Which?

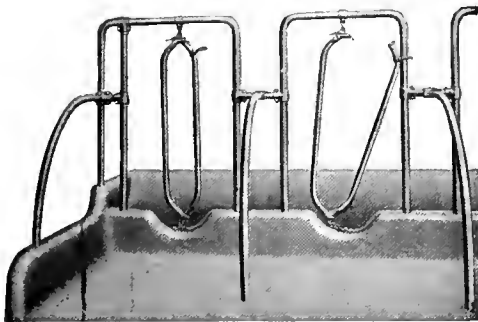

Fig. 1194

If preferred, we can furnish **Stalls Built Separately** (instead of having a **Continuous Top-Rail**), as represented by Fig. 1194, which shows the Louden 812 Stalls with the top-rail left off and the upper ends of the posts joined together over each stall, the only connection between them being the cross braces to which the upper ends of the stall partitions are connected. Notwithstanding our ability to furnish stalls of this kind, we **must condemn them**.

The **Continuous Top-Rail** is an important part of cow stalls, and when we discard it we **sacrifice strength and durability**. Stalls built separately are also **harder to line up and to hold in line**. In addition to this, it is **more difficult to adjust them to fit the barn**. With the **Continuous Top-Rail** all that is necessary is to adjust the couplings to make the

stalls any width desired or to make them different widths to accommodate the space in the barn. If the top-rail is too long, cut it off; if too short, add a piece to it.

With stalls built separate this cannot be done. In such cases the stalls have to be returned to the factory and other stalls built to take their place. Everybody knows that in "Union there is strength," while in "division there is weakness." Build your stalls with a **continuous top-rail and you make them strong**. Build them separate and you make them weak. It is also easier to add more stalls as they are needed when the Continuous Top-Rail is used. In every way the Continuous Top-Rail is superior to the separately-built stalls and we cannot help but think that this idea is a **passing fad**. Nevertheless, if our customers want stalls of this kind we will bow to their wishes and will give them the **best possible** under the circumstance.

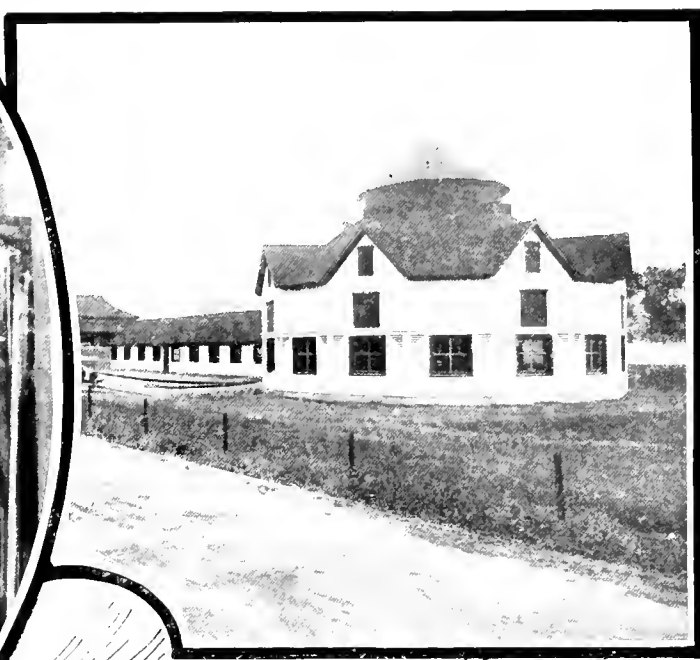
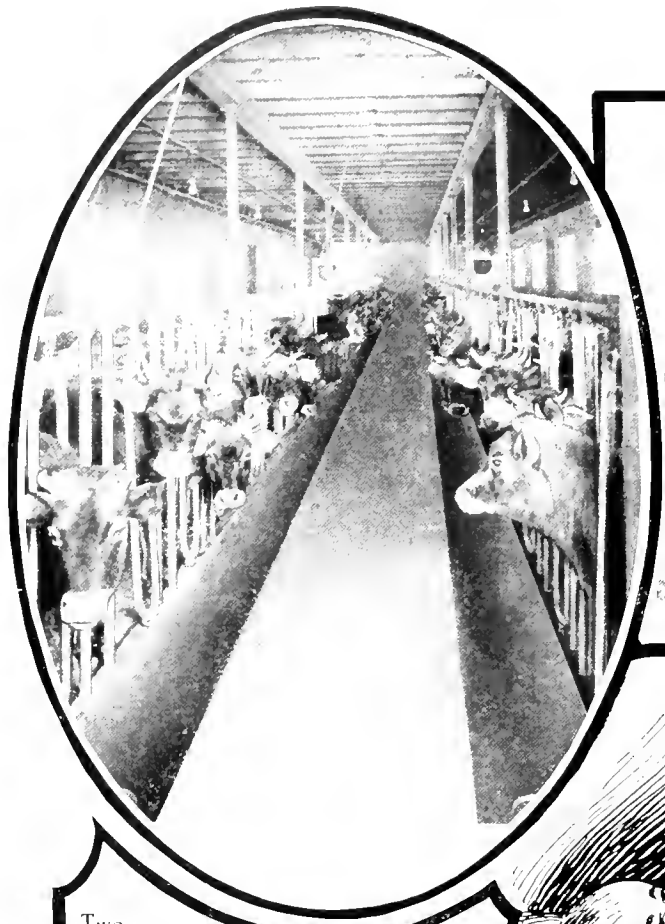

Two Louden Planned and Equipped Barns That Are Helping To "Save the Babies"

Above: Oriole Farms Barn, Youngstown, Ohio.

Below: Barn of Col. C. T. Lipscombe, Easton, Md.



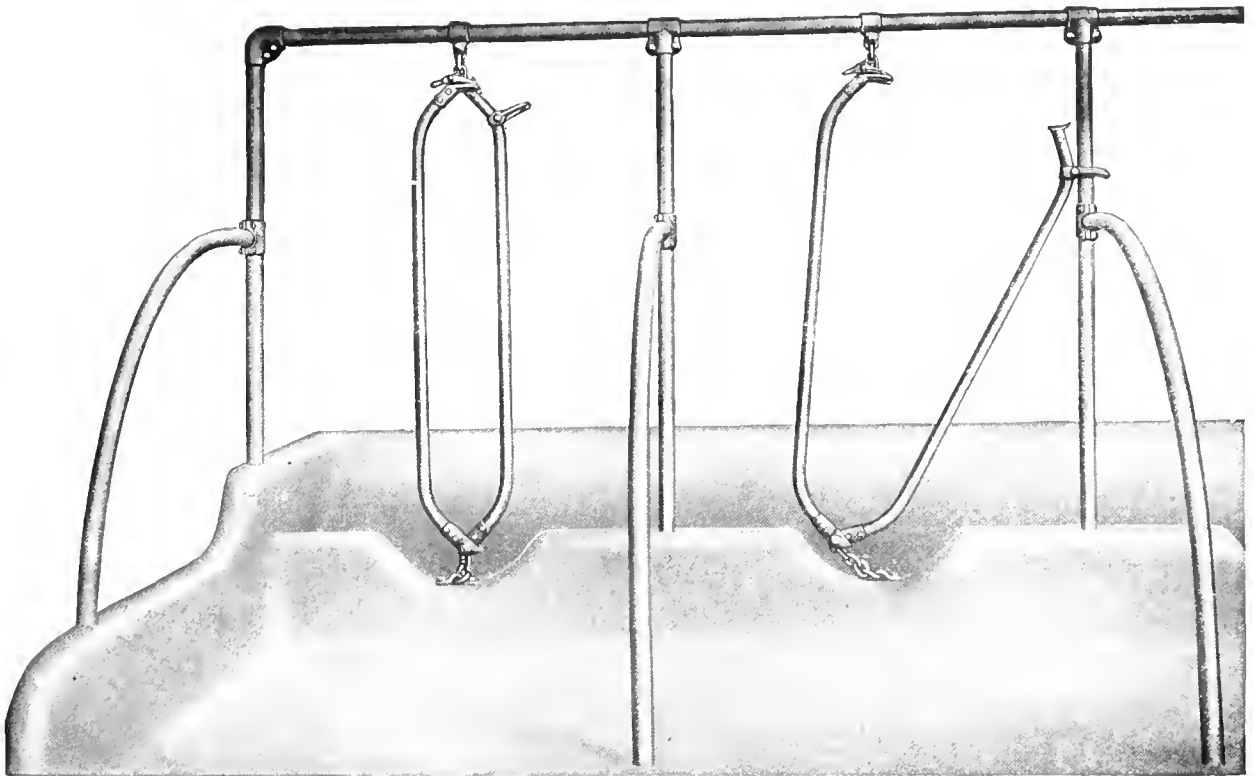

Louden Single Post Cow Stall—Fig. 796

Specifications

Standard Size. The top-rail, stall posts and stall partitions are made of $1\frac{5}{8}$ O. D. steel tubing.

Note: The height of the 796 Stall and the length of the posts are the same as our 812 Stall. See specifications on page 77. The stall partitions, the stanchions and finish are also the same.

Illustration. The cut shows two stalls and one end section on the cross alley where the end curbs are located. When there is an alley at each end of a row of stalls, an extra end section is required for which an extra charge will be made.

Fig. 796 Stall Complete, consists of 1 Stall Post; 1 Stall Partition; 36 inches of Top-Rail (more or less); 2 Interlocking Dust-Proof Couplings; 1 Tubular Steel or Wood-Lined Stanchion; 1 Regular Stanchion Holder; 1 Guide or Hold-Open for stanchion, and 1 Regular Stanchion Anchor.

End Section Complete consists of 1 Stall Post; 1 Stall Partition; 1 Interlocking Dust-Proof Coupling, and 1 Single Piece Elbow.

This is an excellent Stall for young stock or for small cows where it is not necessary to make the stalls over 3 feet wide. Many dairymen wish to provide for stabling young stock, especially heifers, until they are old enough to join the producing herd. These Stalls when equipped with our Narrow Stanchions are well adapted to this purpose. They are not recommended for cows requiring wider stalls because there would be too much space between the stall posts and stanchions, and the stanchions would open too wide unless stanchion side chains were used.

These stalls have our Interlocking Dust-Proof Couplings and other Louden features. The cut shows one of our Standardized Mangers with High Built-Up End and Manger Curbs—the best that has ever been made. Probably it is not necessary that so fine a manger be used with this inexpensive stall, but for all the difference there is in cost, hardly anyone would want to use the common manger.

Weights. Our Standard Size 796 stall complete, weighs 51 $\frac{1}{2}$ lbs.; Standard 796 End Section complete, weighs 27 lbs.

Note: When one end of a row of stalls is joined to a wall the end section at the other end will be counted as a part of the stalls, but if a wall flange or a partition next the wall is used, or a post is set between the stanchion and the wall or is extended up to the ceiling, an extra charge will be made for these parts.

Hazleton, No. Dak., July 12, 1916

Louden Machinery Co.,

St. Paul, Minn.

Gentlemen:

The "Louden Barn Equipment" I bought three years ago has given me very great satisfaction.

L. H. Koon,

Valley View Stock Farm.

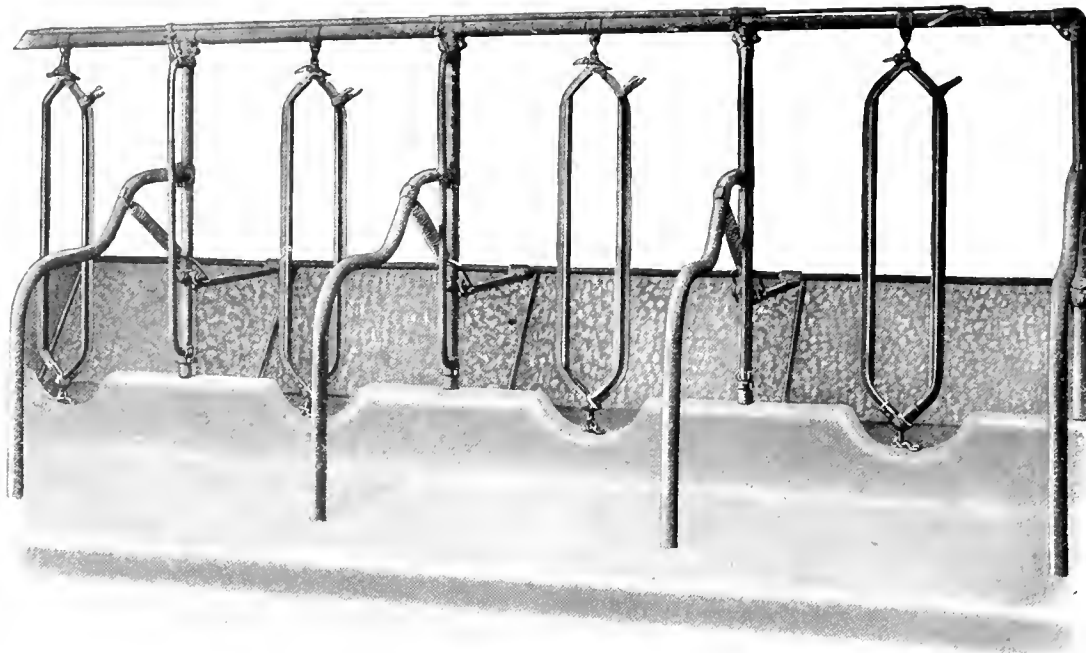

Louden Go-Right Cow Stall—Fig. 999

(Patented May 30, 1916)

This is an attachment to use with our Single-Post Stalls to close the space between the stall post and the stanchion when open and thus prevent the cow from putting her head in the wrong place. While not needed with our Double-Post and Triple-Post Stalls it is used with Single-Post Stalls when made wide enough to accommodate medium or large size cows. The Louden Go-Right is decidedly the best arrangement of the kind in the market, and we recommend it for the following reasons:

1st. As will be seen by Figs. 999 and 1000, which show the Go-Right in both open and closed position, it is extremely simple in construction and easy to keep clean. There are no sharp corners anywhere to injure the cow. Neither are there any cracks, crevices or pockets to catch and hold dirt or afford breeding places for disease germs.

2d. The swinging guard which prevents the cow from putting her head between the stanchion and the stall post does not have to be set in or on the curb where it would be liable to bind on the hay in the manger, or strike the cow's knees or pinch her feet, or—worst of all—form a “dirt catcher.” The lower ends of the guards which are made of $1\frac{5}{16}$ O. D. steel tubing, are rounded, and are hinged to the stall posts a sufficient distance above the curb to avoid any interference.

3d. The operating mechanism is both simple and effective. It consists of a shift rod made of $1\frac{1}{16}$ O. D. steel tubing extending over a row of stalls and connected by swivel malleable castings to the upper ends of the guards as shown in the cuts. At one end a shift lever which is connected to the shift rod, is pivoted to the top-rail of the row of stalls. By moving the lever in one direction the Go-Right Guards are swung into line with the stall posts, thus closing the space between the stall posts and the stanchions, and by moving the lever in the opposite direction the guards are swung out in line with the stall partitions, as shown in the cuts. At the same time and without additional mechanism, the guards are automatically locked in either position. When closed the guards cannot be opened and when opened they cannot be closed without moving the shift lever—a most valuable feature not found in other devices of this kind.

The illustrations show our Wood-Lined Stanchions, Triple Bend Stall Partitions, High Built-Up Manger Curbs, and Spring Balanced Mangers which are described on other pages. To make the stalls complete, the stanchions should be fitted with our Stanchion Side Chains (see Figure 1149, Page 85), to prevent them from opening too wide.

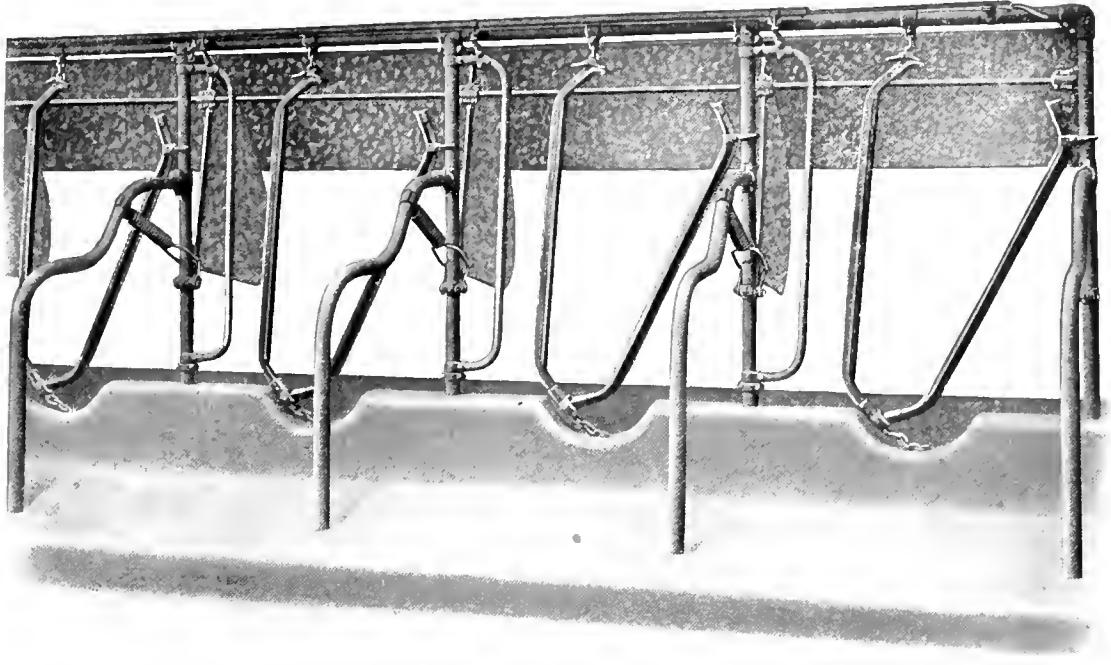

Louden Go-Right Cow Stall—Fig. 1000

Specifications

Size of Tubing. The top-rail, stall posts and stall partitions are made of $1\frac{5}{8}$ O. D. steel tubing.

Note: The width and the height of these Stalls and the lengths of the Posts are the same as the 812 Stalls. See specifications on page 77.

Go-Right Attachment. The guards are made of $1\frac{1}{16}$ O. D. steel tubing, having their upper and lower ends bent as shown, and hinged to the stall posts by malleable iron clamps which hold the ends of the guards securely, while they loosely encircle and rotate on the posts. The lower ends of the guards are held up from the curb by collars on the posts, as shown in the cuts.

Shift Rod. The Shift Rod which is connected to the upper ends of the guards to open and close them is of $1\frac{1}{16}$ O. D. steel tubing and is cut to suit the length of the section of stalls to which the Go-Right is applied. The lever and the clamp by which the lever is pivoted to the top-rail are malleable iron. The Pitman connecting the shift rod and the lever together is half-inch wrought iron.

Illustration. The cuts show three stalls and part of another and one End Section. When there is an alley at each end of a row of stalls, an extra End Section is required for which an extra charge will be made. The cuts also show our Spring Balanced Galvanized Mangers which are illustrated and specifications given on other pages.

Go-Right Stall Complete. (Without Manger shown in cut) consists of 1 Stall Post; 1 Stall Partition; 42 inches of Top-Rail (more or less); 2 Interlocking Dust-Proof Couplings;

1 Wood-Lined or Tubular Steel Stanchion; 1 Regular Stanchion Holder; 1 Guide or Hold-Open for Stanchion; 1 Regular Stanchion Anchor; 1 Go-Right Guard fitted with hinge castings for the stall posts; 1 Collar to support lower end of guard.

In addition to the above we furnish 1 Shift Lever; 1 Pivot Clamp for shift lever; 1 Tubular Shift Rod for each section of 2, 3 or more stalls, cut the proper length to connect to the upper ends of the hinge castings and to operate the guards, and one Pitman to connect the Shift Lever and Shift Rod together.

End Section Complete. Consists of 1 Stall Post; 1 Stall Partition; 1 Interlocking Dust-Proof Coupling; 1 Single-Piece Elbow.

Weight. Go-Right Stall complete, as specified, 63 lbs.; End Section complete (no top-rail), as specified, 27 lbs.

Note: When one end of a row of stalls is joined to a wall the end section at the other end will be counted as a part of the stalls, but if a wall flange or a partition next the wall is used, or a post is set between the stanchion and the wall or is extended up to the ceiling, an extra charge will be made for these parts.

The Louden Machinery Co., Mitchell, So. Dak., July 11-16
Fairfield, Iowa

Gentlemen: I am happy to state that the barn equipment which I purchased from you has given complete satisfaction.

I appreciate the kind, businesslike treatment which I have received at your hands, and will be sure to call upon you when I need goods in your line. I remain, very truly yours,

Frank Weller.

Bending Steel Tubing

High Carbon Tubular Steel is too stiff and strong to bend readily. The bending apparatus must be the very best and the curves must be not too sharp. The only tubing we bend in the manufacture of our Cow Stalls are the stall partitions, the sides for our Tubular Stanchions and the guards for our Go-Right Stalls. We believe that a piece of tubing is **stronger straight than bent** and only bend it when absolutely necessary, and certainly never to prove the quality of the tubing. The **quality of the tubing cannot be proved** in this way because a soft iron tube or a piece of lead pipe will bend more easily than high carbon tubular steel, but this does not prove that soft iron tubing or a piece of lead pipe is as good material for cow stalls as high carbon tubular steel. We get our tubing from the best mills in the country and warrant it equal to any tubing made.

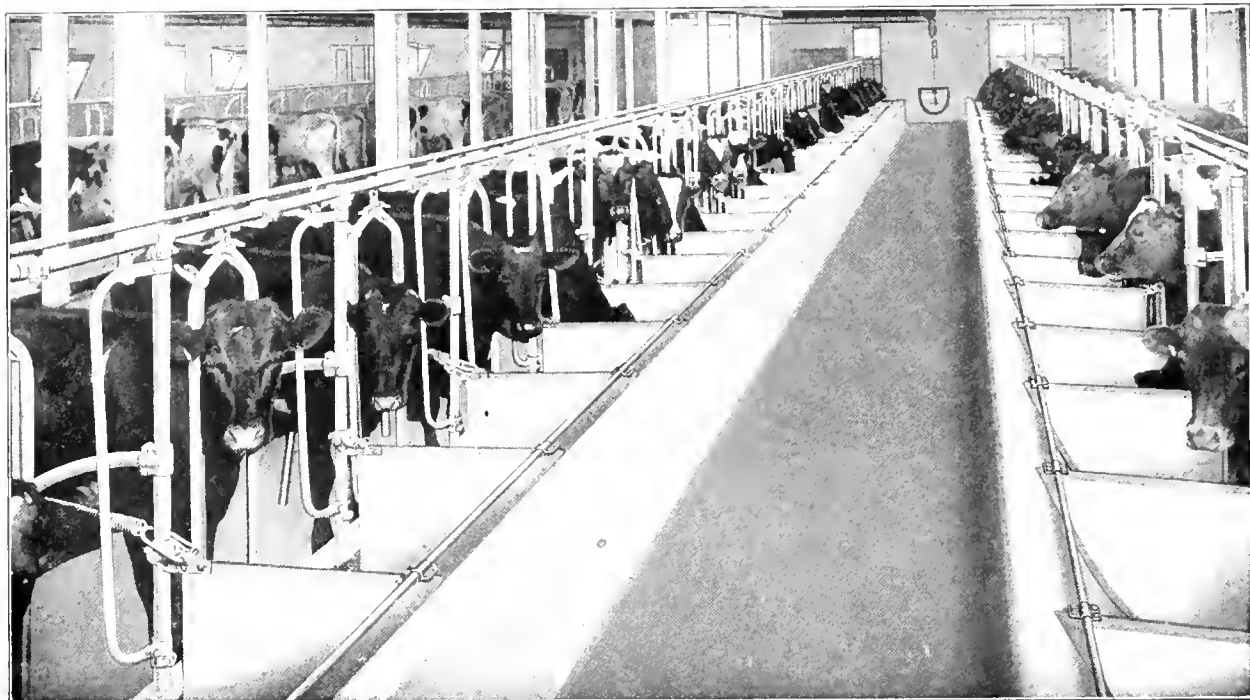

Louden Go-Right Stalls in a Government Dairy Barn

The illustration shows an interior view of the dairy barn of the Haskell Institute, the great Government Indian School at Lawrence, Kan. Eighty-one Louden Go-Right Stalls are used together with Louden Calf Pens, Cow Pens and Bull Pens, and Feed and Litter Carriers.

The following letter, written by Mr. McArthur, dairyman at Haskell Institute, gives the opinion of the users:

Gentlemen:

The Louden Equipment has been put to the test with inexperienced help. The Indian boys were inexperienced, had no training, which together with a herd of young cows, was very trying regarding strength and utility. I will confess that I had fears that our Indian boys would be too reckless and careless and would therefore cause considerable breakage, but to my surprise, the hard strain of a winter's use with 125 head of cattle, there is not the least repair needed in stanchions, bull, cow, or calf pens. You remember we hung up 96 feet of Go-Right to pull with one lever, which you were afraid would be too hard to handle. It works easily, and the boys handle it with one hand.

The High Curb with cut-out for stanchions is great from a standpoint of economy, as the cows can't possibly waste their feed by throwing it under their feet. We water the stock in the cement mangers during stormy weather. The dairy barn at Haskell is now a place of interest to visitors who pass constantly through the institution, and remarks of praise regarding Louden Equipment are constantly heard.

Very respectfully,
Donald McArthur.

The United States Government has been using Louden Equipment for many years, and the fact that it is specified for government buildings is one of the strongest recommendations that can be given.

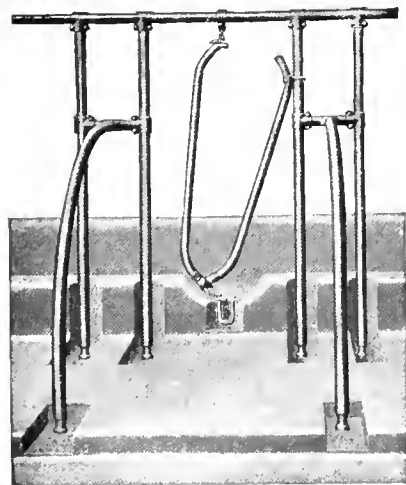
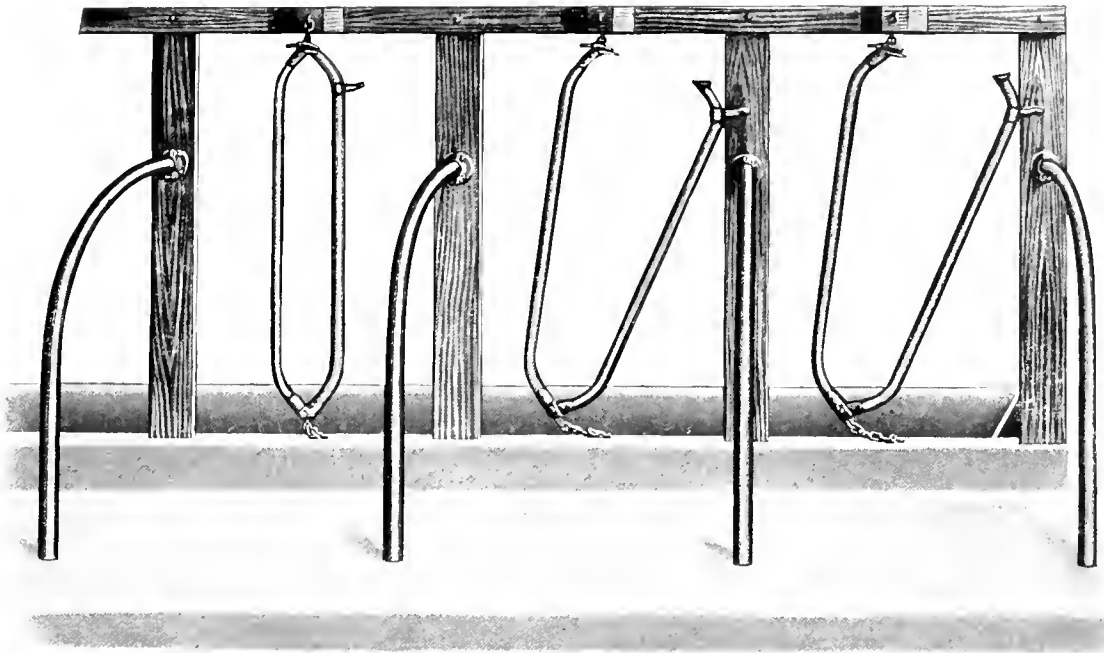

Fig. 1189

Fig. 1189 shows the concrete cut away around the lower ends of the stall posts and stall partitions and around the stanchion anchor which is sherardized so the nuts will not rust but may be taken off and replaced any time to change a stanchion. See how securely the parts are held in the concrete, particularly the stanchion anchor which reaches nearly to the bottom of the curb. The crimps in the lower ends of the tubing will effectually prevent them from pulling out. Also, note the absence of pockets or other "dirt catchers" at the bottoms of the stall posts or at the stanchion anchor.



Louden Simplicity Cow Stall — Fig. 951

We do not recommend any wood parts for cow stalls, especially since Government Inspectors in dealing with the recent outbreak of the foot-and-mouth disease have in some instances ordered the tearing out of all wood fixtures in dairy barns. Nevertheless, there may be some parties who have timber of their own which they can use and who can possibly save some money by so doing. To such parties our Simplicity Stall will appeal. It is inexpensive, and at the same time is in a certain measure, sanitary—easy to clean and easy to keep clean.

The posts are made of 2 x 6, and the top-rail of 2 x 4 timbers. They should be dressed and painted to make them easy to clean. The mangers and the curb should be of concrete, and if wood scantlings are used for the curb, the space between them should be filled with concrete to prevent it from filling with objectionable matter.

Specifications

Metal Parts. We furnish only the Metal Parts as follows: Stall Partitions; Flanges to connect upper ends of partitions to stall posts; Stanchions; Bolts to connect upper ends of stanchions to top-rail; Guides (or hold-open) for stanchions; Stanchion Anchors. When wood floors are used or cement floors are already in, Floor Flanges will be needed, also Anchor Bolts. We do not furnish the bolts to join the wood parts together as they can be procured at any hardware store. Directions are furnished for making and setting up stalls.

Illustration shows our No. 3 Stall Partition which we recommend and will furnish unless our No. 2 or No. 5 partitions are specified. (See Fig. 994, page 79.) Also, our Tubular Steel Stanchions which we recommend and will furnish unless otherwise specified. There will be an extra charge for either the Five-in-One or Quick Adjustable Stanchions, but no extra charge for our Wood-Lined Stanchions.

Finish. All the parts except the U bolts for stanchion anchors, which are sherardized, are coated with our Special Dairy Barn Paint or, if so ordered, will be galvanized at extra prices given.

Cut shows three stalls and one End Section. When there is an alley at each end of a row of stalls, an extra End Section will be required for which an extra charge will be made.

Simplicity Fittings, complete for each stall, consist of 1 Stall Partition; 1 Post Flange; 1 Tubular Steel or Wood-Lined Stanchion; 1 Bolt to connect stanchion to top-rail; 1 Guide or Hold-Open for stanchion; 1 Regular Stanchion Anchor.

Simplicity End Section, complete, consists of 1 Stall Partition and 1 Post Flange.

Weights. Fittings for stall weigh 31 lbs.; End Section, 18 lbs.

Special. When the stall is to be set on a wood floor or on a cement floor already in, the lower ends of the partition will have to be cut 5 inches shorter and floor flange will be required together with lag screws for the wood floor and anchor bolts for the cement floor.

Barron, Wis., July 11, 1916.

The Louden Machinery Company,
St. Paul, Minn.

Gentlemen:

I am very much pleased with the barn equipments I got from you and will certainly call on you again if I need more.

Dr. H. M. Coleman.

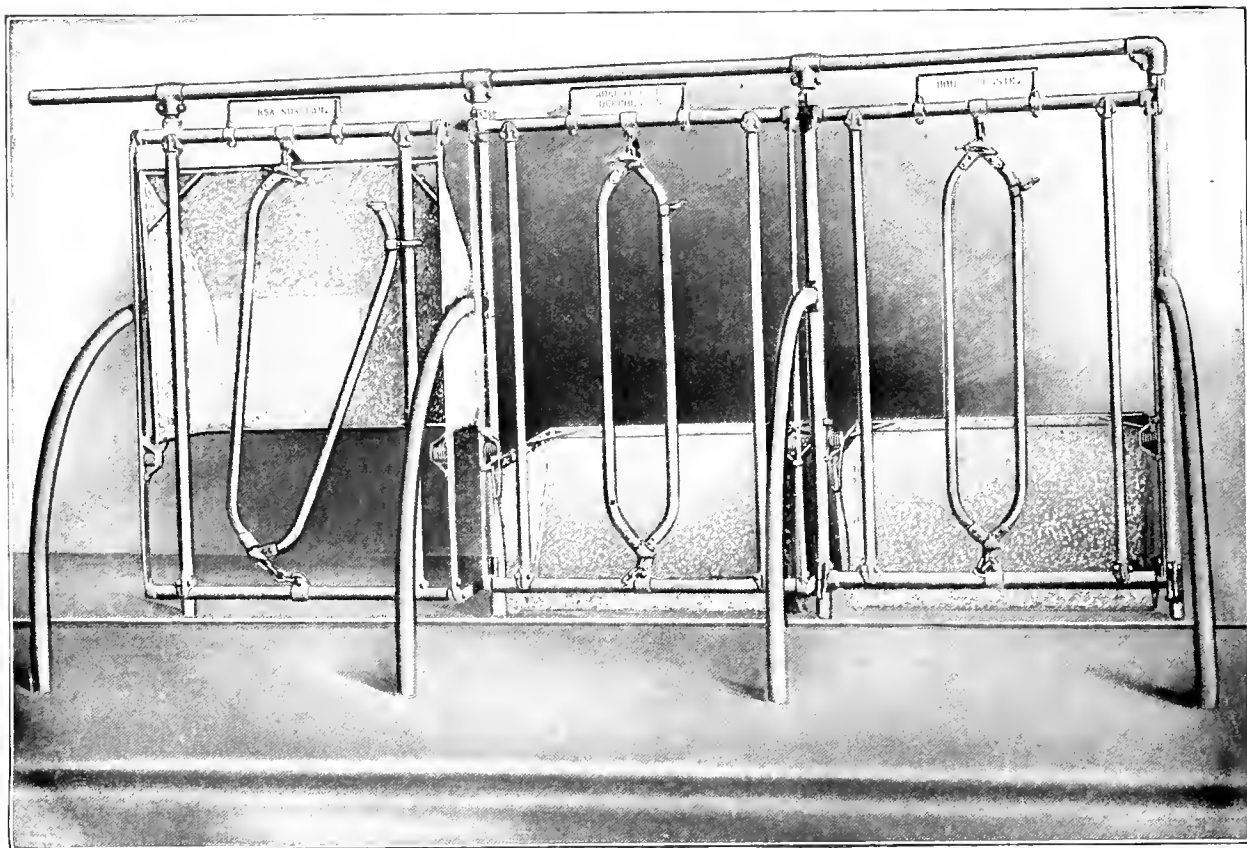

Louden (Patent Allowed) Adjustable Cow Stalls—Fig. 948

One of the important things in Cow Stalls is to get the stall floor the proper length to suit the cow. If made too short the cow will either stand with her hind feet in the gutter or be cramped too close against the manger. If made too long the droppings will fall on the rear end of the stall floor and soil the cows.

A number of things have been devised in the attempt to overcome this difficulty, but most of them have proved of little or no value except perhaps, to furnish "talking points" in making sales. The principal device used has been the so-called "Stanchion Alignment." It is claimed that by adjusting the stanchion backward or forward, long and short cows alike can be aligned on the gutter regardless of the distance from the manger to the gutter. This has seemed plausible and it is certainly "easy" if it will only do the work.

A few facts briefly stated will show the futility of this plan of alignment. In the first place, the cow will always align herself, if possible, on her feed in the manger, and the only sure way to align her on the gutter will be to make the **distance between the gutter and the manger to suit the length of the cow.** That it cannot be done by merely adjusting the stanchion backward or forward is evident from the fact that the cow's neck is from **15 to 20 inches long.** A long cow "aligned forward" will simply step back until her head comes in contact with the stanchion, and a short cow "aligned back" will simply move forward until her shoulders come against the stanchion. She always aligns herself on her feed.

A change of 5 to 10 inches in the location of the stanchion, will never do the business. The way to do it effectively is to **regulate the distance between the manger and the gutter** to suit the length of the cow. This is the plan we have adopted in our Adjustable Stalls. Individual mangers are attached to special frames which are adjustable on the permanent frame of the stall, so that the distance between the manger and the gutter can be adjusted back and forth 13 inches, or more if required to suit the length of each individual cow.

A good view of the arrangement is shown by Figs. 948 and 949, the latter being an end view, and the former a rear view showing one of the mangers raised for cleaning. The special frames to which the stanchions and mangers are attached, are provided with horizontal ends which are secured to the stall posts by clamps which are readily tightened to hold the mangers and stanchions in the proper positions, and loosened to adjust them to those positions. The adjustment is made by **loosening the upper bolts of the clamps, while the lower bolts remain tightened** to hold the clamps in their proper positions.

Louden Adjustable Stalls

Fig. 948—Continued

The mangers are hinged to the adjustable frames and are provided with springs to assist in raising them, and hooks to hold them in raised position while cleaning. The stall floor should be made from 6 to 8 inches longer than with stalls having non-adjustable mangers. Also, the longer stall partitions should be used. Louden Adjustable Stalls answer all requirements, and give good satisfaction wherever used.

Mangers. The Mangers are made of 18-gauge galvanized sheet steel reinforced at the ends and on the edges with heavy angle iron. They are 39 inches long, 34 inches wide and 21½ inches deep in the clear. They have rounded bottoms and the same general contour as our Standardized Cement Mangers. The feeding front, including lower rail, is 6½ inches above the floor.

Partitions, Stanchions, etc. The cut shows our No. 3 Stall Partitions and Tubular Steel Stanchions which will be furnished unless our other stanchions or our No. 2 partition is specified. The Name Plates are not included but will be furnished if specified. An extra charge will be made for the Five-in-One or Quick Adjustable Stanchions.

Louden Adjustable Stall complete consists of 1 Stall Post (6 feet, 1 inch long); 1 Stall Partition; 42 inches (more or less) of Top-Rail; 1 Upper and 1 Lower Stanchion Rail; 2 Side Guards; 2 Adjusting Bars with horizontal ends; 2 Interlocking Dust-Proof Couplings; 2 pair of Adjusting Clamps; 4 Corner Irons for adjustable frame; 4 Grip Clamps for side guards; 1 Galvanized Manger; 2 Hinges for manger; 2 Special Springs for manger; 1 Hook to hold up manger; 1 Regular Stanchion Holder; 1 Guide or Hold-Open for stanchion, and 1 Special Stanchion Anchor to attach to lower stanchion rail.

End Section consists of 1 Stall Post (6 feet 1 inch long); 1 Stall Partition; 1 Interlocking Dust-Proof Coupling, and 1 Single Piece Elbow. The adjusting clamps at the end of a row of stalls are single and the central clamps are double. Each double clamp is counted as two, or a pair.

Weight. Adjustable Stall complete with galvanized manger, weighs 183 lbs.; End section, 33½ lbs.

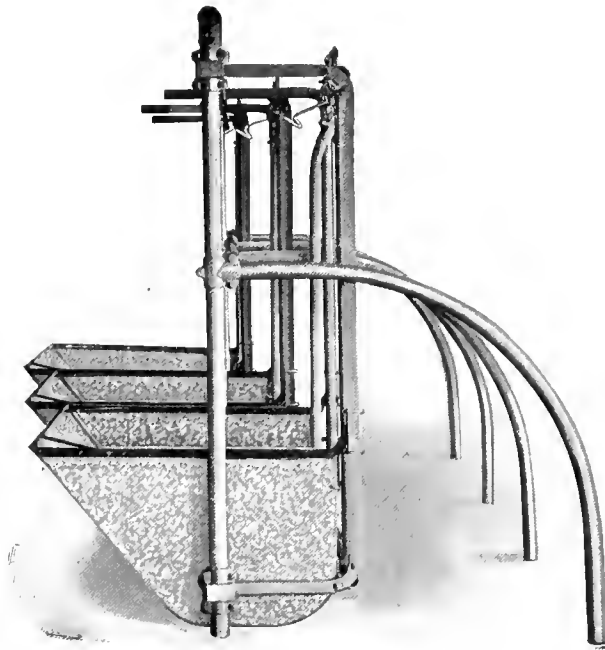

Fig. 949

Specifications

Size of Tubing. Stall posts, stall partitions and top-rail, 1½ inch O. D. steel tubing. Upper and lower horizontal rails to which stanchions are connected, 1½ O. D. steel tubing. Side guards adjustably attached to upper and lower horizontal rails by Louden Grip Clamps, 1½ O. D. steel tubing.

Other Dimensions. The Stall Posts are 6 feet 1 inch long and the Top-Rail is 5 feet 10 inches (70 inches) above the stall floor. This is 7 inches higher than our other stalls which is necessary to give room for the adjusting clamps, and have the horizontal rails 55 inches apart, the standard space required for Louden Stanchions. The Stall Posts and the stall partitions go 5 inches into the cement. The standard width of the stall is 3 feet 6 inches (42 inches). The bars on the sides of the adjustable frame having their horizontal ends clamped on the stall posts are of ¾x1½ inch iron.

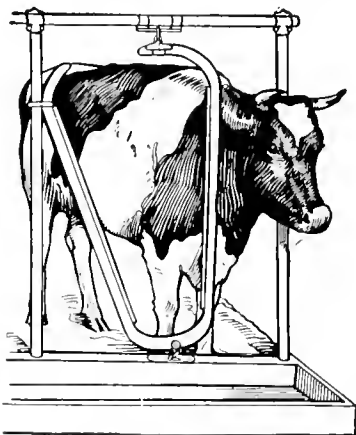

Fig. 1191

This is a portion of a cut which is used by others to show the need of a Stop Device to prevent a cow from putting her head between the stanchion and the stall post. The fact was overlooked that there is **twice as much room in the open stanchion as there is between the stall post and the stanchion.** Consequently, the liability of the cow walking through the stanchion is twice as great as putting her head in the wrong place. The point which the cut shows above everything else is, that in full-width, single post stalls the stanchions open too wide, and that **double or triple post stalls should be used to get the proper proportions** and do away with the necessity of using stop devices. The liability of the cow going through a wide-open stanchion is **three times greater** than putting her head in at the side. But if you want a single-post stall with stop device, we have the best one made—the "Louden Go-Right." Our Side Chains will also prevent the stanchions from opening too wide.

Louden Name Plates and Name Plate Holders

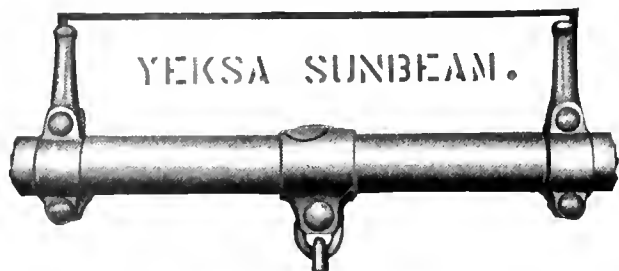

Fig. 935

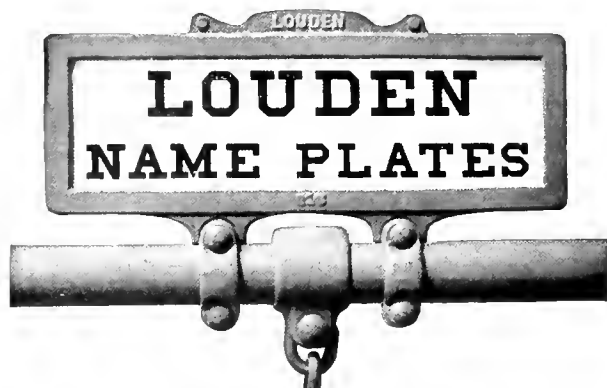

Fig. 1181

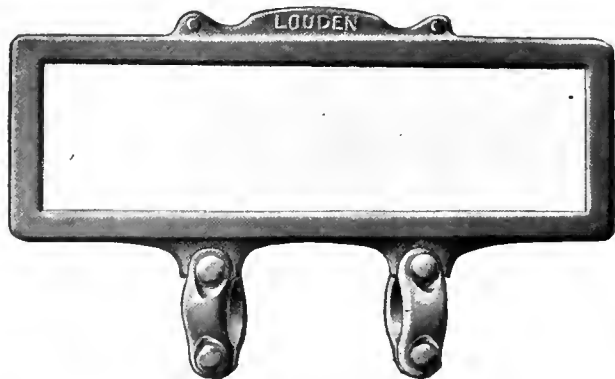

Fig. 1182

Fig. 935 is our original Name Plate with Holders. It is simply a sheet of galvanized steel, 4x15 inches, standard size, and a pair of clamps having upwardly extended ends to hold the plate between them. The size of the plate may be varied to suit requirements. Even as large as 24 inches square may be used to make a score card to keep a record of the cow's work, or for other purposes. In place of the sheet steel a heavy cardboard may be used.

This is the simplest name plate and holder ever devised and it is actually the best for all purposes. It is also the most durable. Cows with long horns cannot punch holes in the steel plate. The cow's name and any other information may be painted or stenciled on the plate, or it may be coated for use as a black-board. The cut shows the Holders clamped on the top-rail of a stall and the lower edge of the plate cut out to fit over the stanchion holder which shows in the cut.

Fig. 1181 is our New Name Plate Holder, also, mounted on the top-rail of a stall. It is provided with two sheets of isinglass, each 4 $\frac{1}{8}$ x12 $\frac{1}{2}$ inches, between which the name plate or card is inserted.

Fig. 1182 shows the holder detached with the isinglass in, but the name plate left out. The holder is clamped on the top-rail by collars shown in the cuts. This is the most artistic Name Plate Holder manufactured.

The presence of name plates on stalls adds to the appearance and identifies the cows in a manner that bespeaks the owner's consideration and high appreciation of their value. There is no doubt that buyers or patrons visiting your barn will be influenced more or less by neat and attractive name plates.

Holders are made for either 1 $\frac{3}{8}$ or 1 $\frac{7}{8}$ top-rail.
Be sure to specify size.

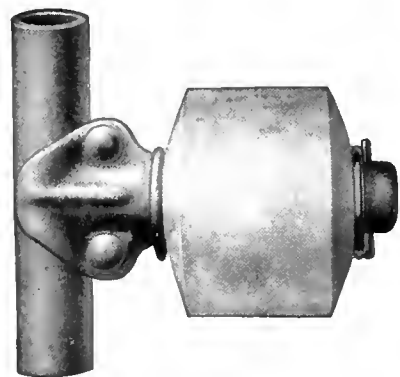

Fig. 1056
Patent Pending

Louden Salt Roll and Holder

The most convenient and economical, and altogether the **best way of salting cattle and horses.** The salt is formed by heavy pressure into cylindrical rolls about 5 inches in diameter and 4 $\frac{1}{2}$ inches long with convex ends and a hole through the center. The Roll is easily mounted on our Holders and will revolve when the animal licks it.

The Roll is extremely hard to chip or break and disintegrates very slowly, and is therefore the most economical way that stock can be salted. There is no danger of the animal getting too much salt at a time. Neither is there any danger of the salting being neglected. Special circular on application.

Fig. 1056 shows salt roll mounted on holder for vertical stall pipe. We also furnish holders for either vertical or horizontal wood stall timbers, to be attached with bolts or screws. (See page 210.)

Mr. R. B. Young, proprietor of The Chicago Stock Farms, Buffalo Center, Iowa, after using our Holders several months, writes: "The Salt Roll Holders are very satisfactory and please me in every way."

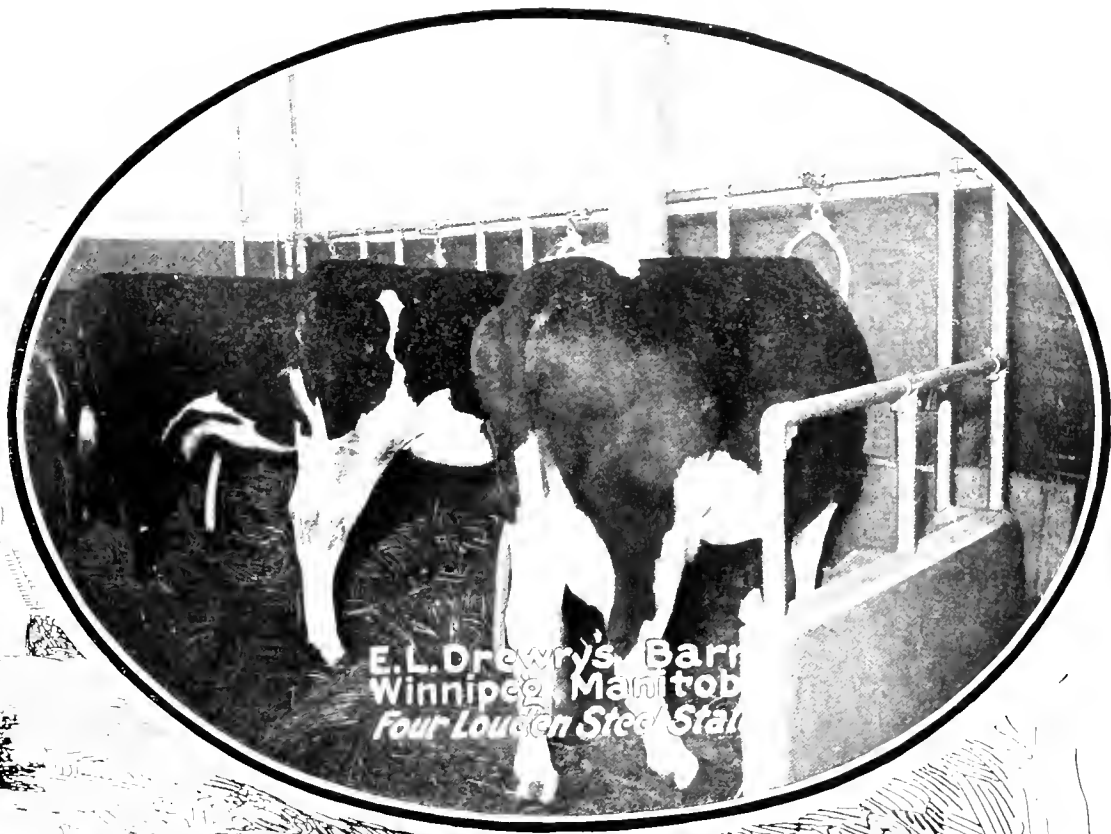

E.L. Drewry's Barn
Winnipeg, Manitoba
Four Louden Steel Stalls



FOR FOUR COWS OR
FOUR HUNDRED—

Louden Steel Stalls and Stanchions
Are Equally Profitable.

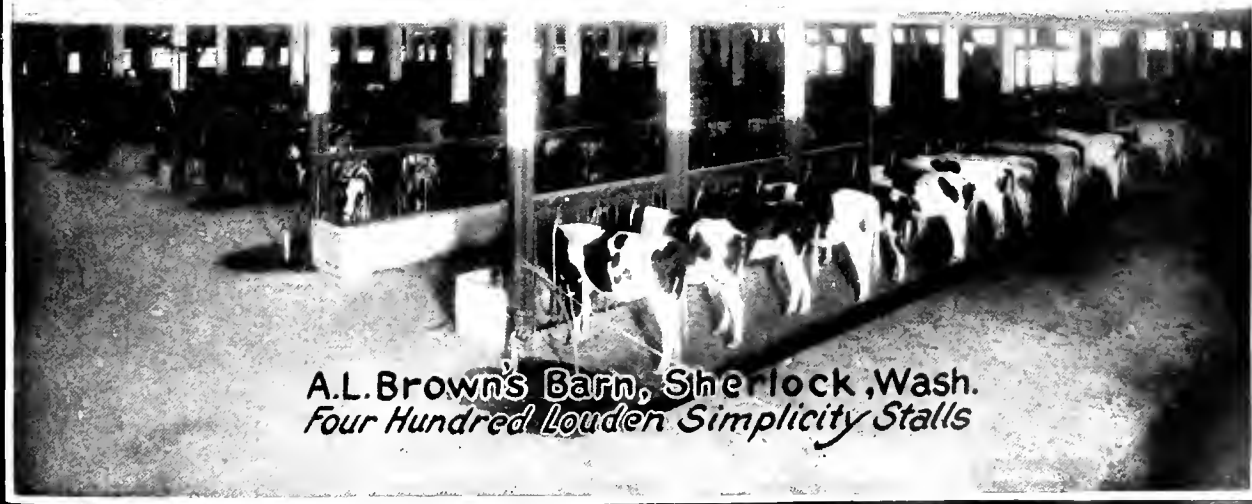

A.L. Brown's Barn, Sherlock, Wash.
Four Hundred Louden Simplicity Stalls

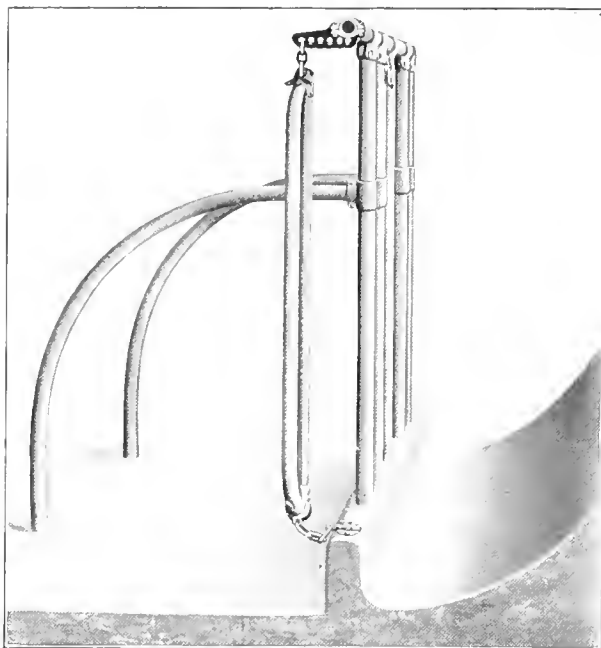

Fig. 938

The Alignment Problem

The Louden Adjustable Stalls, as explained on preceding pages, solve the Alignment Problem more completely than anything ever produced, but if other styles of stalls, having either concrete or other non-adjustable mangers should be used, the question arises as to the best way to secure the most practical alignment of the cows on the gutter with these stalls.

In the first place the stall floor should be long enough so the cow can stand with her front feet 6 to 8 inches away from the curb, so she will not jam her knees against it in lying down, and with her hind feet not more than 3 or 4 inches from the edge of the gutter. A good plan will be to measure the distance from out to out of the cow's feet when she is standing in a **natural position**, and then make the length of the stall floor from 9 to 12 inches longer in the clear from the side of the curb to the edge of the gutter.

To provide for different sizes of cows the best way is to make different sections of stalls with different lengths of floors — say, one section with the floor long enough for the longest cows, another for shorter cows, another for those still shorter, and then another for the shortest cows, or for young stock. Different widths

of stalls will probably be required, so take it all in all, this will be the very best arrangement that can be made when the barn is large enough for different sections of stalls. When the barn is small, the stall floors can be made longer at one end and shorter at the other, thus tapering the floor, so different lengths will be provided for the different sizes of cows.

Louden "Stanchion Alignment"

(Patented May 26, 1914)

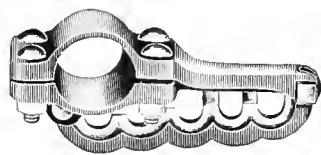

Upper Adjustable Stanchion Holder, Fig. 1298

Another method is the so-called "Stanchion Alignment" by which the stanchion is adjusted backward and forward closer to and farther from the gutter. This method has been largely advertised and is favored by some dairymen. In compliance with the demand for a "Stanchion Alignment" we have designed and patented what we believe to be the best device of the kind on the market, as shown by Fig. 938. The Adjustable Holder secured to the top-rail is arranged so the stanchion may be adjusted as much as 6½ inches to one side of the center of the top-rail. By reversing the holder

the stanchion may be placed as far in the opposite direction, thus making a total adjustment of 13 inches. The Adjustable Holder is clamped upon the top-rail by four heavy bolts.

The Alignment Anchor (Fig. 1299) is inserted in the curb when the cement is put in, thus making it as solid as the curb itself. The chain holder is adjustably clamped upon a central rib and has a total adjustment of 8 inches.

There are no bolt head pockets in the curb or any underneath spaces anywhere to catch and hold dirt. These adjustable or alignment anchors are frequently regular "dirt catchers," and do more harm in catching and holding dirt than they do good in the alignment of the cows. Our Stanchion Alignment is free from these faults, and is more practical than any other stanchion alignment made.



Lower Adjustable Stanchion Holder, Fig. 1299

Specifications

Weights. The Louden Adjustable Stanchion Holder with bolts complete weighs 4 lbs. The Louden Adjustable Anchor complete with bolts, 1¾ lbs.

Note: Be sure to specify size of top-rail. Sometimes the Adjustable Anchor is not used and for that reason we price the Holder and Anchor separately.

Louden Step-Back

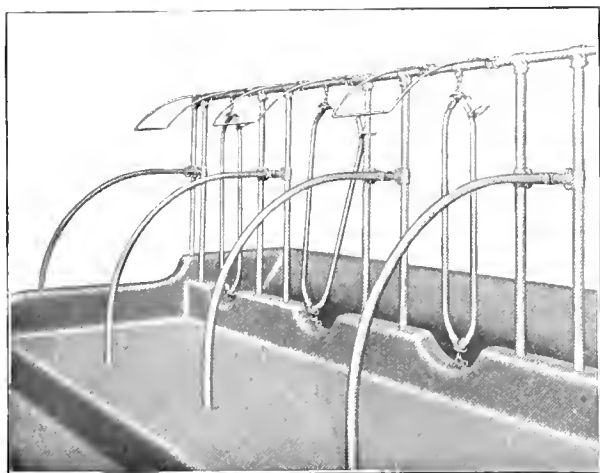

Fig. 1151
Patent Pending.

where the floor is a little long and when it is used the floor may be made 4 or 5 inches longer than the standard length thus giving the cow more room. The cut shows three of our Fig. 812 Stalls each fitted with a Step-Back. The Louden Step-Back is made for 1 $\frac{5}{8}$ and 1 $\frac{7}{8}$ O. D. top-rail, and with clamps complete weighs 4 $\frac{1}{2}$ lbs.

Fig. 1151 represents another arrangement to prevent the cow from leaving her droppings on the stall floor. It may be applied to any of our steel stalls. It is simply a large spring wire, $\frac{7}{16}$ -inch diameter, bent as shown in the cut, and adjustably clamped upon the top-rail directly above where the cow stands. It is adjusted so the lower end will be from 1 to 2 inches above the cow's back when she is standing in a natural position, and immediately behind her shoulders.

When the cow humps her back before evacuating, she will strike it against the wire and this will cause her to step back, so she will deposit her droppings in the gutter. Those who have used this device say it is just the thing and that it is so effective that after it has been used awhile the cow will form a habit of stepping back, when the device may be removed without changing the habit. It is a simple, inexpensive device and is certainly worthy of a trial.

This Step-Back is especially adapted for stalls

Note: Be sure to specify the size of the top-rail.

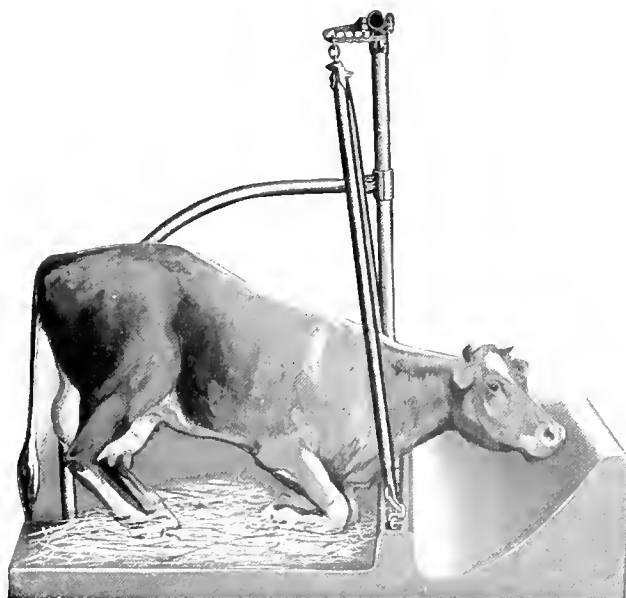

Fig. 940

Fig. 940 shows the position a cow assumes when getting up or lying down. She lowers her front end first in lying down and raises it last in getting up. She invariably pitches forward in either getting up or lying down—therefore, the necessity of having the stanchion flexibly anchored so it will swing enough to prevent jamming her shoulders.

The cut also shows why the cow does not have to strain or jam her knees against the curb to get her feed in our Standardized Mangers as she has to do with flat bottomed mangers. The feed rolls down toward the cow and if any should remain on the far side she will not have to strain to get it. The cut shows the feed-wasting, low-level curb. It should have our High Built-Up Curb to make it complete.

How to Securely Clamp Metal Parts Together

1. Put all the clamps on loosely so the parts can be easily racked to line them up properly.
2. After they are all in proper position draw the nuts tight with a wrench.
3. When tightly drawn, hit the heads of the bolts heavily with a hammer to set them.

4. Tighten up the nuts again with a wrench as much as can be safely done.

When treated this way the bolts will not be liable to get loose but without hammering their heads so as to solidly set them they will be liable to work loose under a strain and especially so under a jar. This is important in attaching clamps of any kind, especially splice clamps for overhead track, couplings and clamps for connecting the tubing of animal stalls and pens together, especially pens to hold vicious bulls and for other purposes requiring solidity and durability of structure.



Louden Standardized Mangers—Fig. 1152

One of the most important things in the construction of cow stalls is to make the manger the proper size and shape to suit the various requirements of the different kinds of cows and the different methods of feeding, and at the same time have them **standardized** so any needed metal work can be readily made to fit the manger. Heretofore there has been no recognized standard. Mangers have been built in almost every conceivable shape and style to suit the fancy, and without any effort to secure uniformity.

Louden Standardized Mangers have been devised to overcome the troubles resulting from this lack of uniformity. The designs presented are on **correct scientific lines**, and are believed to be the most complete ever offered. While substantially uniform in all their curves and lines they are readily adapted to be made different sizes to suit different sizes of cows and different methods of feeding.

The standard curb is made 5 inches thick and 11 inches high above the stall floor—10 inches above the lowest part of the manger bottom (5 inches higher than usual), and the **corners are rounded** so they cannot in any way injure the cow. Where the stanchion is anchored the curb has a semi-circular **Cut-Out** 5 inches deep and 15 inches wide at the top, which also has rounded corners.

This permits the stanchion to be **hung low** while the **curb is high**, thus giving the cow **perfect freedom** as well as **ample throat room** when lying with her head low down, and prevents her from nosing her feed out over the high curb at the sides. The side of the manger next to the curb instead of having the usual sharp corner which prevents the cow from cleaning up her feed and furnishing a place to catch and hold dirt, has a four-inch radius which **fits the cow's nose** nicely and makes it easy to keep the manger clean. The other side has a radius of 24 or 30 inches (according to size), centered from the same perpendicular line, which makes the lowest part of the manger within 5 inches of the curb. The far side of the manger raises on a gradual curve so the feed naturally rolls down toward the cow.

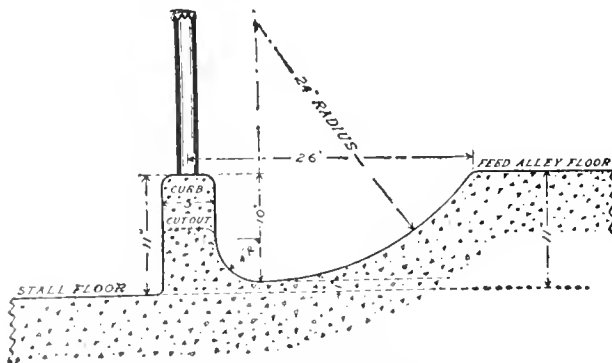

Fig. 1001 Louden Low Cement Manger, with Raised Feed Alley Floor

Louden Standardized Mangers—Continued

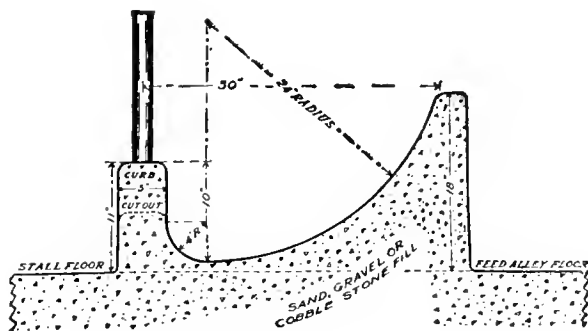

Fig. 1002

Louden High Cement Manger, Standard Size

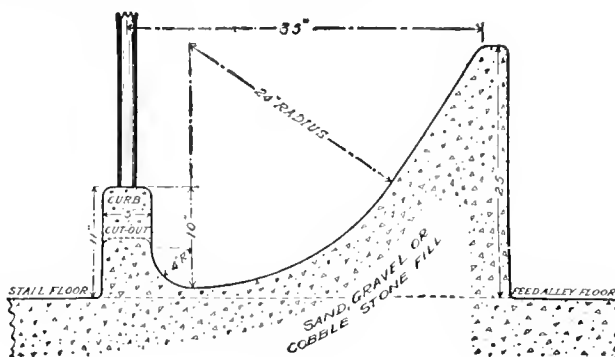

Fig. 1003

Louden Extra High Cement Manger, Standard Size

With our **Patent Cut-Out Forms** (see Fig. 970), our **High Cut-Out Curb** is made as easily as a low level curb and it is a hundred per cent better. It is in reality a "**High Built-Up Curb**," because it is the Standard Height where the stanchion is anchored and is **5 inches higher on the sides**.

There are no cracks or crevices or pockets anywhere in our mangers to catch and hold dirt and form breeding places for disease germs. **Beware of "dirt catchers" in your mangers.**

Sizes of Mangers. These mangers are made in five different sizes varying from 26 to 40 inches in width and the outside edge of the manger from 11 to 25 inches high.

Fig. 1001 is a cross-section view of our **Low Cement Manger** (radii 4 inches and 24 inches), with **Raised Feed Alley Floor**—a style well adapted for common use. Fig. 1002 is our **High Cement Manger**, standard size (radii 4 inches and 24 inches). Fig. 1003 is our **Extra High Cement Manger**, standard size (radii 4 inches and 24 inches). These sizes are well adapted for average cows.

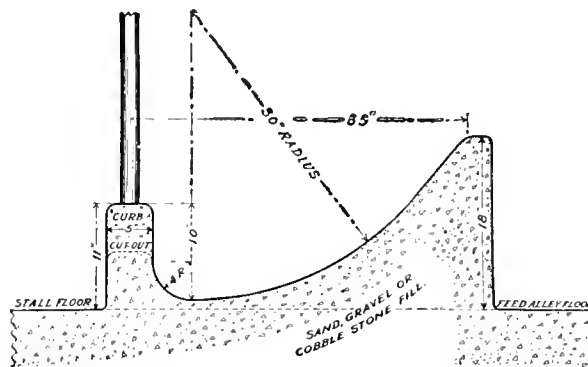

Fig. 1004

Louden High Cement Manger, Large Size

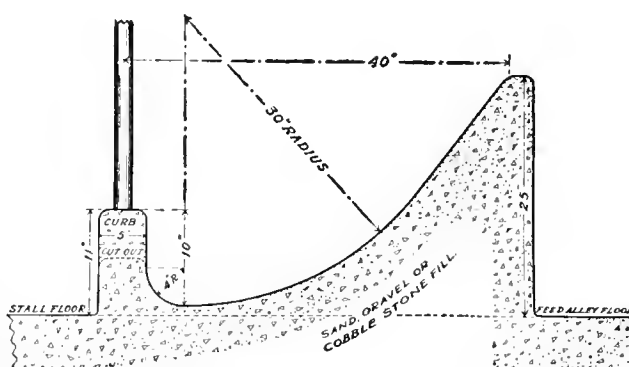

Fig. 1005

Louden Extra High Cement Manger, Large Size

Fig. 1004 is our **High Cement Manger**, large size (radii 4 inches and 30 inches), suitable for large cows. Fig. 1005 is our **Extra High Cement Manger**, large size (radii 4 inches and 30 inches), suitable for extra large cows.

Our Standardized Mangers and our improved methods of constructing them, are everywhere conceded to be the greatest improvements recently made in Dairy Barn Equipments. These improvements are so much ahead of former designs and methods that they mark a **distinct epoch** in the development of dairy equipments. Leading dairymen everywhere approve our Standardized Mangers and Agricultural Colleges in this and other countries have adopted our directions for the instruction of their classes.

We could fill this catalog with testimonials but have room only for the following:

"I am glad to see these improvements. They are certainly a credit to your Company, and will be of great value to dairymen as well as a benefit to mankind in general." Prof. T. L. Haecker, Chief of the Division of Dairy and Animal Husbandry, University of Minnesota.

"You have done distinct service to the dairy farmer by Standardizing the Concrete Mangers and making it possible for him to secure the exact measurements which are necessary for the proper construction." Prof. C. H. Eckles, Chief of the Department of Dairy Husbandry, University of Missouri.

Constructing Louden Standardized Mangers

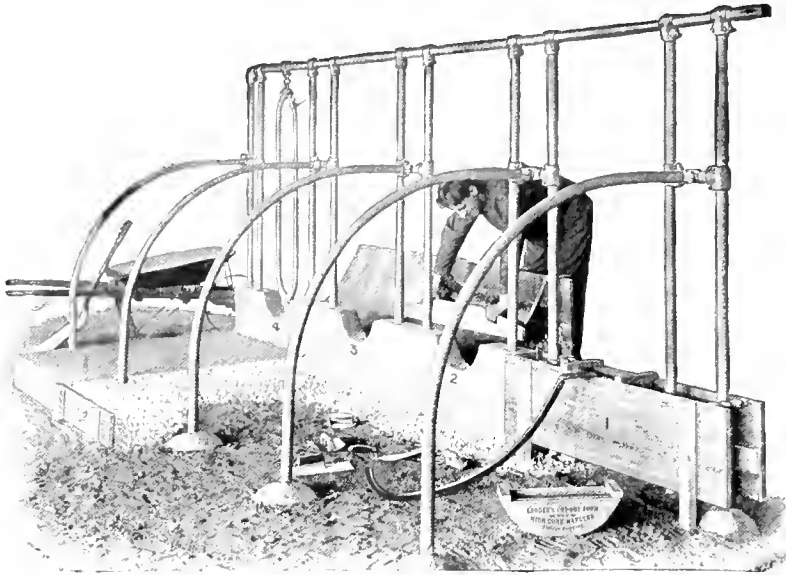

Fig. 1155

Fig. 1155 shows the different steps in the construction of Louden Standardized Mangers. 1st, the stalls are set up and lined up as true as line and level can make them. 2d, the form-boards for the curb are set up to correspond with the stalls and the cement is then put in, using our patent cut-out forms to make the cut-outs in the curb. 3d, the curb form-boards are removed, the corners of the curb are rounded and the form-boards for the manger are set up. 4th, the templets for the manger are set in place and the cement is then put in. 5th, after the cement has set sufficiently, the templets and form-boards are removed and the manger is smoothed up. After this the stall floors, the gutters, and the litter and feed alley floors are constructed in the order most convenient.

We furnish Complete Detailed Instructions for doing the work. Also, the necessary Tools and Appliances. (See page 101.)

Some parties advise putting in the concrete work first and setting up the stalls afterwards, connecting the stall posts and partitions to the curbs and floors by means of anchors set in the concrete.

We do not recommend the anchoring of stalls in this manner if it is possible to install them in the usual manner, with stall posts securely embedded in the concrete.

It is practically impossible to get a first class job when separate anchors are used. No matter how careful the concrete worker may be he cannot set the anchors accurately enough to make the stalls line up properly, and some of them will have to be sprung into line and held by the top rail and stall partitions. The stalls will not be as strong as those set in solid concrete, and the anchors offer a place for the accumulation of dirt.

The principal advantages of the anchors are, first, that they may be shipped ahead of the stalls and the concrete work put in before the stalls arrive; second, that anyone can set up the stalls without the aid of concrete workers after the anchors are in. Nevertheless, these advantages hardly offset the advantages of stalls set up in the manner shown by Fig. 1155, where the stall posts extend fifteen inches into the solid concrete.

Louden Improved Stall Anchor

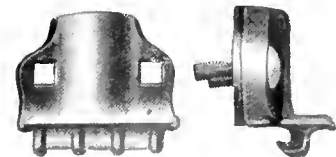

Fig. 1282

Front and Side Views of Malleable Clamp for Improved Stall Anchor



Fig. 1283

Anchor Iron for Improved Stall Anchor

Where the use of anchors is necessary, the Louden Improved Stall Anchor provides the most secure anchorage, and the simplest method of installation ever offered to barn owners.

The Louden Anchor is the strongest and heaviest made. It is the only anchor that is made as strong as the pipe it supports.

The lower part of the anchor—which is embedded in the concrete—is made of heavy strap iron. It is $3\frac{3}{4}$ inches wide at the top and $7\frac{1}{4}$ inches wide at the bottom, flared to make it hold securely.

The stall post is secured to the anchor by means of overlapping, dustproof, malleable castings, clamped on. There are no bolts through the anchor to break off or weaken the connection. A heavily ribbed hook or flange three inches in length grips the anchor iron securely on each side, making a connection that is almost unbreakable.

Fig. 1284 shows the parts assembled and clamped to the anchor iron; also a short section of the stall post. The top of the anchor iron is set level with the top of the curb, and the broad flanged base of the malleable connection rests flat against the concrete.



Fig. 1284

Showing Stall Anchor Assembled

Tools and Appliances for Constructing Louden Standardized Mangers

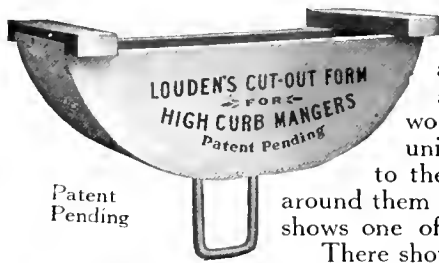

Fig. 970

Fig. 970 represents the Louden Cut-Out Form to make the cut-outs in the Louden High Built-Up Manger Curb. The forms are set in between the boards used in constructing the curb where the stanchions are to be anchored. No cutting of the boards nor extra work of any kind is required to make the cut-outs and they will all be uniform in size and shape. The anchors which connect the stanchions to the curb are easily attached to the forms and the cement being slushed around them will make a better bond than if they were set afterwards. The cut shows one of our large sherardized U bolt anchors connected to the form. There should be 4 to 6 forms for each installment according to the size of the barn and the speed required in doing the work.



Fig. 1074

Fig. 1074 is a top view of our Curb Gauge, by means of which the form-boards for the curb will be held the proper distance apart, and equal distances from the stall posts. No measuring or cutting of boards is required. There should be 8 to 12 gauges for each installment.

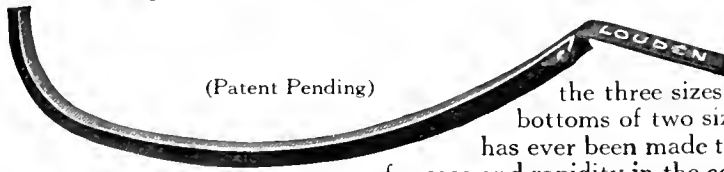

(Patent Pending)

Fig. 1013

Fig. 1013 is a perspective of one of the Louden Manger Templets. There are seven different sizes—one for each of the three sizes of concrete mangers and one for each of the bottoms of two sizes of galvanized mangers. No other device has ever been made that will begin to compare with these templets for ease and rapidity in the construction of cement mangers as well as for the excellence of the work.

There should be 5 to 8 templets for each installment.

Louden Cement Tools

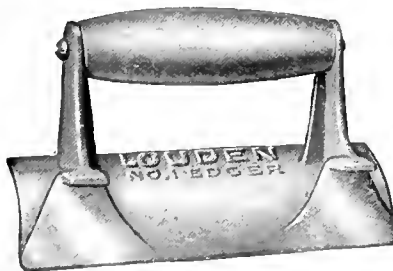

No. 1

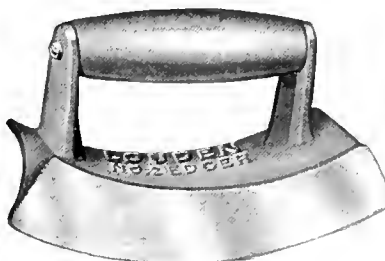

No. 2

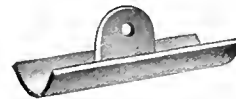

No. 4

No. 1 is our Straight Edger for rounding off the upper edge of the manger curbs, also the sharp edge of the gutter. No. 2 is our Curved Edger for rounding off the edges of the cut-out in the curb and other curved works.

No. 4 is a small tool to round out and smooth up the corners between the curbs and the stall floor. Also the corners between the manger and the feed alley floor and any similar corners liable to catch and hold dirt.



No. 5

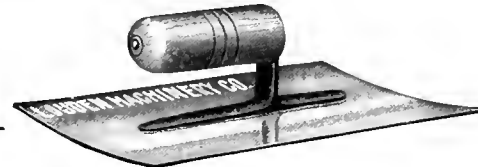

No. 6

No. 5 is our 4-inch radius Steel Trowel for rounding out and smoothing the corner of the manger next the curb. No. 6 is our 24-inch radius Steel Trowel for smoothing the bottom of the manger. The blades of these trowels are of the finest steel and they are light and easy to handle. No one can afford to be without a supply of these tools in doing the cement work in a dairy barn.



Fig. 1192

Star Drills. For drilling holes in brick, stone or concrete. We carry only the sizes necessary for the anchor shields we use and only in one length. Other sizes and lengths will be furnished on application, at market prices. Sizes— $\frac{1}{2}$ x8 inches, $\frac{5}{8}$ x8 inches, $\frac{3}{4}$ x8 inches, and $\frac{7}{8}$ x8 inches.

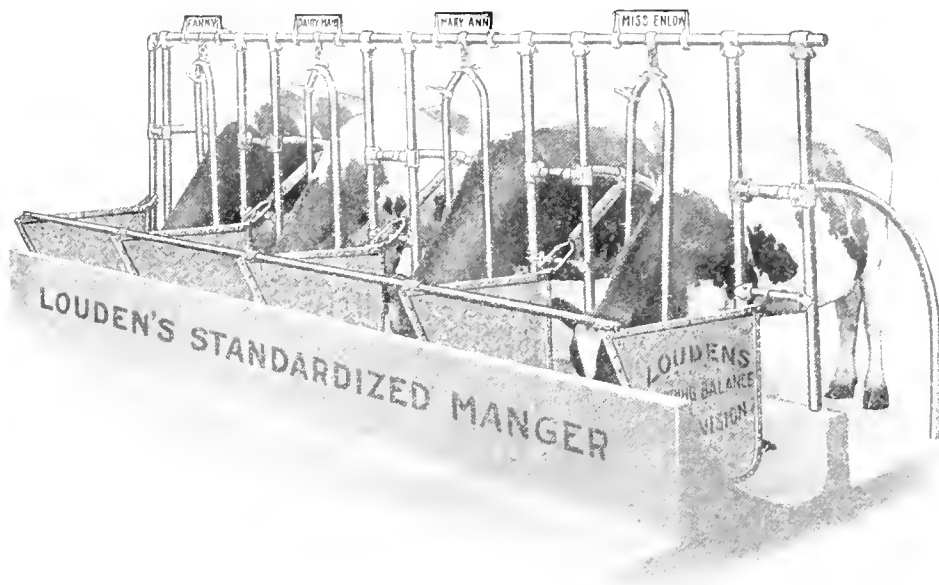

Louden Spring Balance Manger Divisions—Fig. 1018

(Patent Pending)

Fig. 1018 shows a Louden Standardized Manger fitted with a section of our Spring Balance Manger Divisions which are made to fit the manger. How comfortable the cows look, each eating her apportioned feed without interference from her neighbor — the shape of the manger bringing the feed close so she does not have to strain to get it, and the manger divisions preventing her from straining to get the feed belonging to her neighbor.

The Individual Manger is an advantage in a number of ways. It prevents the fast-eating cow from robbing the slow-eating cow — the one getting more than is good for her and the other not getting enough. The amount of feed can be varied to suit the individual cow and different kinds of feed can be given to different cows to suit their requirements. It prevents the cow from straining and injuring herself in trying to get the feed in the adjoining section. It helps to prevent one cow from infecting another. In short, it enables the dairyman to feed and handle his cows as his best judgment tells him they should be fed and handled, instead of each cow striving to help herself.

The Divisions are made of heavy galvanized sheet steel and are hinged to the stall posts so they can be raised for cleaning the manger. They are connected together in sections by means of a brace rod, as shown in the cut, so that all the divisions in the section can be raised at one operation instead of only one at a time.

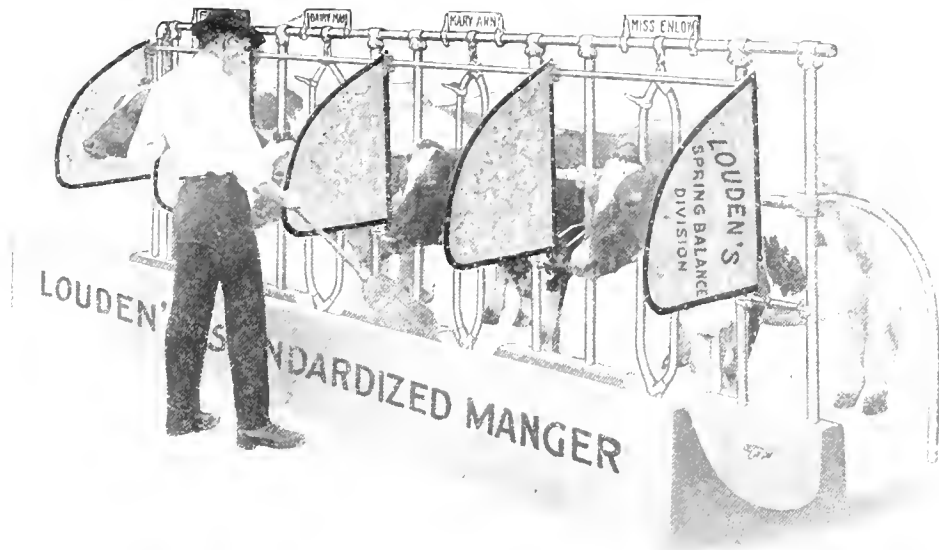

Fig. 1153

Malleable Iron Hinges are used as shown by Fig. 1153, pattern 926 being the single hinge used at the outer ends of the sections, and patterns 927 and 928 being the double hinges used on the central divisions. These hinges are connected to the stall posts by pivot clamps when used with stalls having central posts. With our Double Post Stalls the hinges are connected to pivot pins which are attached to the posts by our Grip Clamps, as shown in the cut.

To assist in raising the divisions and to hold them in elevated position, as shown in Fig. 1020, we use **Special Coil Springs** which are attached to some of the central hinges by means of clevises, the upper ends of the springs being adjustably connected to the stall partitions. Two sizes of springs are used, each having a working strength of from 300 to 500 pounds according to size and adjustment.

When the Divisions are raised halfway up they will be held in a **perfect balance** at any higher point without any additional assistance whatever. The attachment of the springs is such that they can be adjusted to help **hold the divisions down** when feeding and thus prevent the cows from nosing them out of position. With the different sizes of springs and with the complete and convenient adjustment any size or weight of Manger Division may be balanced to perfection.



Louden Spring Balance Manger Divisions—Fig. 1020

Specifications

The Dimensions. All of our Manger Divisions are 24 inches high where the hinges are placed. The other dimensions are given in Plate 14, page 104.

The Material. All the Divisions are made of No. 18 galvanized sheet steel. Each Division is reinforced entirely around the edge with heavy iron, giving it great strength and rigidity.

The Brace Rod is made of $1\frac{1}{8}$ O. D. steel tubing and is attached by malleable iron clamps which are bolted to the reinforcing irons so as to hold them rigidly in place.

The Springs. The lighter spring is made of $\frac{1}{4}$ inch and the heavier spring of $\frac{5}{16}$ high-grade spring wire—the best that can be procured. Generally two springs are used on a section of 4 divisions, 3 springs on a section of 5 divisions and so on. If the heavier springs are used a less number may be required.

The Finish. The sheet steel of which the divisions are made is galvanized, and then the whole is coated with our Special Dairy Barn Paint. If the fittings are to be

galvanized there will be an extra charge for this extra work.

Louden Spring Balance Manger Division complete consists of 1 Galvanized Division of the size specified, 42 inches (more or less) of $1\frac{1}{8}$ O. D. Tubular Brace Rod; 1 Keeper with Anchor Bolts to support lower corner of divisions; 1 Single Hinge for each end division; 1 Single Pivot Clamp for each single hinge; 1 Double Hinge for each central division; 1 Double Pivot Clamp for each double hinge, provided stalls with central posts are used. With the Louden Double Post Stalls, 1 Pivot Pin and 2 pair of Grip Clamps to attach the pivot pin to the stall posts are used in place of the double pivot clamp. **In ordering specify the size of posts.**

The Spring Outfit. Each Spring Outfit consists of 1 Louden Special Coil Spring of the size to suit requirements; 1 Clevis and 1 Holder for spring.

Weights. With hinges and their connections complete as specified are as follows: New No. 2 Division about $16\frac{3}{4}$ lbs.; No. 3 Division about $18\frac{1}{4}$ lbs.; No. 4 Division about 20 lbs. The weight of the spring outfit is about $3\frac{3}{4}$ lbs.

Louden Hold-Down Hook for Manger Divisions

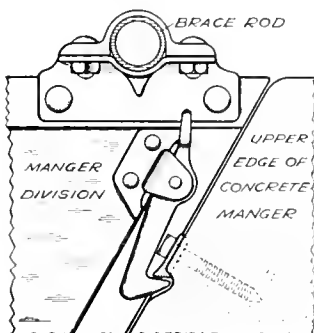

Fig. 1186

Fig. 1186 is a side view of our Hold-Down Hook for Manger Divisions. Usually this hook is not needed. The manger springs could be adjusted so it would be impossible to root up the divisions but it would make them heavy to lift for cleaning. By using our Hold-Down Hook the cows **cannot root up** the divisions, and at the same time they will be **easy to lift**. The hook catches automatically and is easily unlatched by pressing a finger on its upper end. The hook catches against a plate secured to the concrete by two anchor bolts.

Keepers like that shown by Fig. 1072 are secured to the inner side of the curb, as shown in Figs. 1018 and 1020 to support the lower corners of the divisions and prevent husky cows from pushing them out of place.

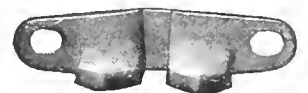

Fig. 1072

Louden Spring Balance Manger Divisions—Cont'd

We make three different sizes of Manger Divisions, as shown in Plate 14, which also shows the divisions fitted in the different sizes of our Standardized Concrete Mangers for which they are intended.

The new No. 2 division is for Fig. 1001 manger only. It is not fitted with springs or brace rod, and each division is raised and lowered separately. It is inexpensive, and is designed for barns where it is not desired to put in the more expensive divisions. All other manger divisions are fitted with springs and brace rod.

No. 3 division is intended for Figs. 1001 and 1002 mangers, and No. 4 for Figs. 1002 and 1003. See description of these mangers on pages 98 and 99.

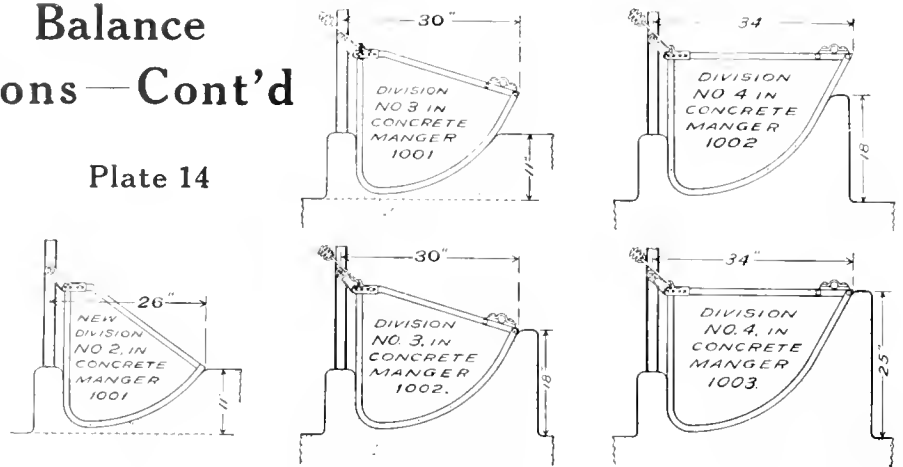

Louden Spring Balance Mangers

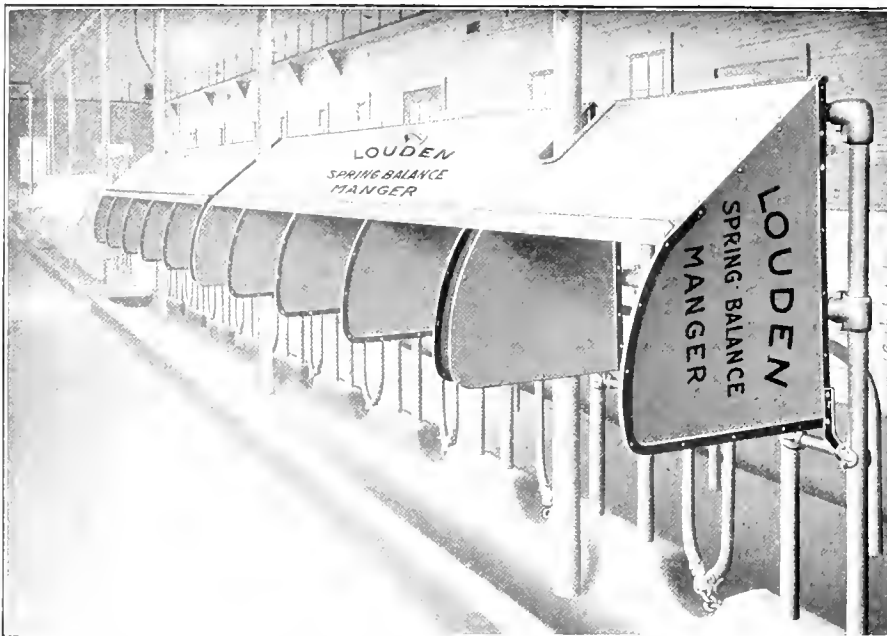

This illustration shows two sections of the **Louden Spring Balance Galvanized Mangers** in the dairy barn on the farm of the University of Minnesota, at St. Paul. See how perfectly they line up and how much higher they raise than the mangers shown in the rear which are not the Loudens. **The superiority of the Louden Equipment speaks for itself.** Louden Mangers are made regularly in sections of four.

This was a somewhat difficult job to install on account of the large posts which are in the manger. We found a way to get around the posts, as will be seen in the cut, without cutting the sections into single mangers as was done with the mangers in the rear, which is objectionable and should be avoided if possible. It is better to have the large posts or columns **in line with the stall posts** and then the mangers will not have to be cut to get around them.



Louden Spring Balance Galvanized Manger—Fig. 990

Patent Pending.

Specifications

Standard Size is 24 inches high from the manger bottom and extends out 36 inches from the center of the stall posts. The standard width is 42 inches but it will be made wider or narrower as specified, to suit the width of the stalls with which it is used. No 18 gauge galvanized sheet steel is used, reinforced entirely around the edge with heavy iron.

The Brace Rod is made of $1\frac{1}{8}$ O. D. steel tubing and is attached to the manger divisions by malleable iron clamps which are bolted to the reinforcing strips so as to hold them rigidly in place.

The Hinges are malleable castings, No. 741 being the pattern number of the end hinge, and No. 797 R. & L. the pattern numbers of the center hinges. With stalls having central posts the hinges are connected to them by pivot



Fig. 1154

clamps—single pivots being used on the end posts, and double pivots on the central posts. With our Double Post Fig. 812 Stall, shown in Fig. 990, the central hinges are connected to pivot pins made of $1\frac{1}{8}$ O. D. tubular steel, and connected to the stall posts by a pair of our Grip Clamps. If the springs have to be set vertically (which is seldom done) hinge castings, pattern Nos. 876 and 877 R. & L. (not illustrated) will be used.

The Springs. The lower ends of the Springs are connected to clevises having their ends fitted to hook in the eyes of the hinges, and the upper ends of the Springs are connected to holders (the same as our Regular Stanchion Holders) which are adjustably clamped on the stall partitions. Generally 2 Springs are used on a section of 3 mangers and 3 Springs on a section of 4 mangers. If heavier springs are used a less number may be required.

The Finish. The Sheet Steel of which the manger is made is galvanized, and then the entire manger is coated with our Special Dairy Barn Paint. If the fittings are to be galvanized there will be an extra charge.

Louden Spring Balance Manger Complete consists of 42 inches (more or less) of Galvanized Front (or back); 42 inches (more or less) of Brace-Rod; 1 Manger Division for each manger, and 1 End Division for each section of mangers; Clamps and Bolts to attach the Brace-Rod to the Divisions; 1 Single Hinge for each End Division; 1 Single Pivot Clamp for each Single Hinge; 1 Double Hinge for each Central Division; and 1 Double Pivot Clamp for each Double Hinge—provided stalls with central posts are used. With the Louden Double-Post Stalls, 1 Pivot Pin and 2 pairs of Grip Clamps to attach the Pivot Pin to the stall posts are used in place of the Double Pivot Clamp.

The Spring Outfit. Each Spring Outfit consists of 1 Louden Special Coil Spring of the size to suit requirements; 1 Clevis and 1 Holder for spring.

End Division complete, consists of 1 Galvanized Sheet Steel End; 1 End Clamp to attach Brace-Rod; 1 Single Hinge and 1 Single Pivot Clamp for hinge. The End Divisions are included in prices quoted.

Note: The Pivot Clamps for manger hinges on central post stalls, Grip Clamps to hold Pivot Pins for 812 Stalls, and the Spring Holders are all made to fit either $1\frac{5}{8}$ or $1\frac{7}{8}$ O. D. steel tubing. In ordering be sure to specify the size of tubing with which they are to be used.

Weights. Standard size Manger complete, as specified, with either Pivot Clamp or Pivot Pin and Grip Clamps for Hinges, but without End Division or Spring Outfit, about 47 lbs.; End Division complete, as specified, about 18 lbs.; Spring Outfit complete, as specified, about $5\frac{1}{2}$ lbs.

Note: There is a little variation in weights on account of the different sizes of the fittings for different sizes of tubing.

Large Size Manger. The dimensions are the same as the Standard Size except that it extends out from the stall posts 40 inches instead of 36 inches.

Weights of Large Size Mangers, complete, as specified, about 50 lbs.; End Division, as specified, about 21 lbs.

Louden Spring Balance Mangers—Continued

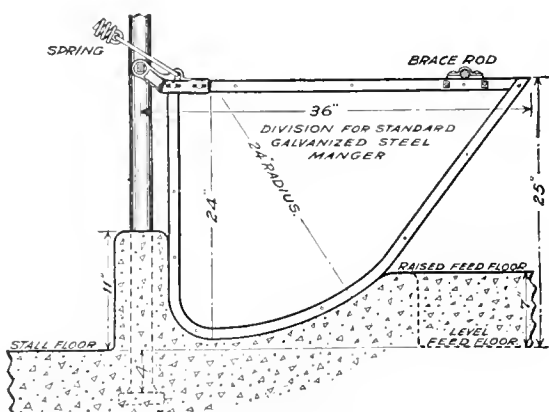

Fig. 1006 Standard Size

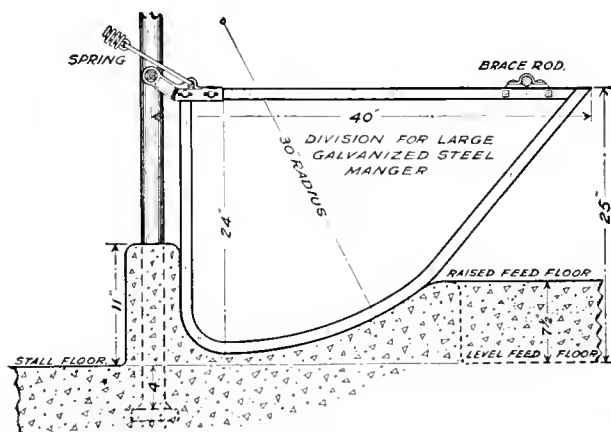

Fig. 1007 Large Size

The Louden Spring Balance Galvanized Manger is the most convenient as well as the strongest and most durable manger of the kind manufactured. The upper part which is made of heavy galvanized sheet steel is made to fit a concrete bottom, as shown in the cut. The divisions which convert the manger into compartments, or individual mangers, are reinforced by Spot Welded T-iron all around the edges. The back or front (whichever it may be called) is attached to the divisions by angle irons bolted thereto. The back (or front) is left off in shipping and the entire manger is packed flat to take a low rate of freight. In putting the manger together no punching or drilling of holes or riveting is required.

The manger is generally built in sections of 4 to 5 compartments and is further strengthened by a brace rod, running the entire length of the section, the brace rod being clamped on the upper edges of the divisions by malleable iron clamps. The brace rod also serves as a guard to hold the hay in the manger. The manger is hinged to the stall post by malleable hinge castings adjustably secured to the inner ends of the divisions. Pivots adjustably secured to the stall posts are used to hold the hinges in place and permit the raising and lowering of the manger. By this means it is readily adjusted up or down, or in or out, to make it fit the concrete bottom. With stalls having central posts, pivot clamps are used instead of the pivot pins required by our double-post stalls.

To assist in raising the manger and to hold it in elevated position for cleaning, heavy Special Coil Wire Springs are used, as shown by the cuts. Two different sizes of springs are used for lighter and heavier mangers, which are made of the best spring steel wire that can be procured. Many experiments were made and scores of sample springs from all the leading spring manufacturers in the country were tested before we decided upon the springs to use. As a result we have a Spring Balance Manger which cannot be equaled. Each spring has a working strength of from 400 to 600 pounds, according to size and adjustment, and after the mangers are raised one-half way up, they will be held by the springs in a perfect balance at any point and without any additional assistance whatever.

The attachment of the spring is such that when the mangers are down in feeding position the springs will help to hold them more securely in lowered position and to keep the cow from nosing them out of place. The upper ends of the springs are usually connected to the stall partitions by clamping holders similar to our standard stanchion holders which may be readily and easily adjusted back or forth thereon to increase or diminish the tension of the springs. With the two sizes of springs and the complete and convenient adjustments, any size or weight of manger may be balanced to perfection.

The mangers when raised stand 8 to 10 inches higher than any others in the market and there is ample room for the heads of the cows when the manger is raised. They are so rigid that a section of four to six can be raised or lowered at one end—something that cannot be done with any other manger without twisting it all out of shape. We do not know of any point that can be imagined but what has been taken care of in our Spring Balance Mangers.

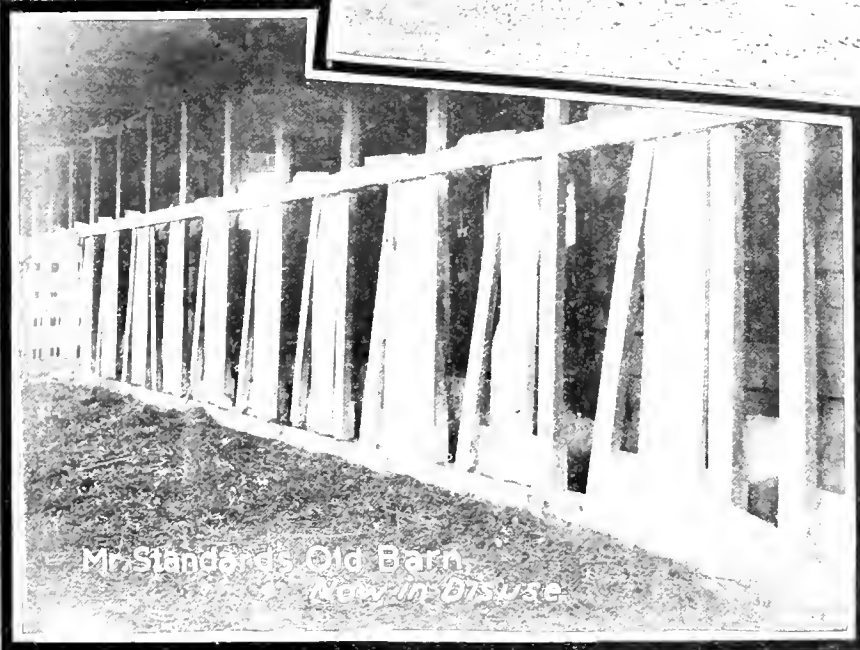

Mr. Standard's Old Barn
New in Disuse

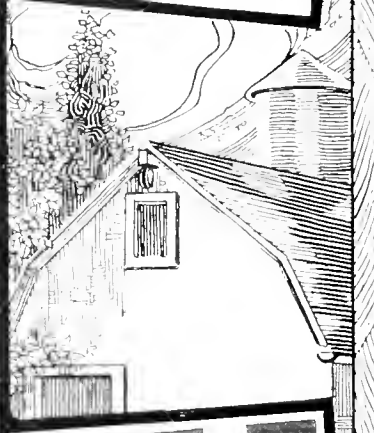

PASTURE COMFORT

Cows Are a Lot Like Humans
In the Way They Respond
To Kind Treatment and
Comfortable Surroundings.
Your Cows Will Pay for
Louden Steel Stalls and
Stanchions Within a Year.

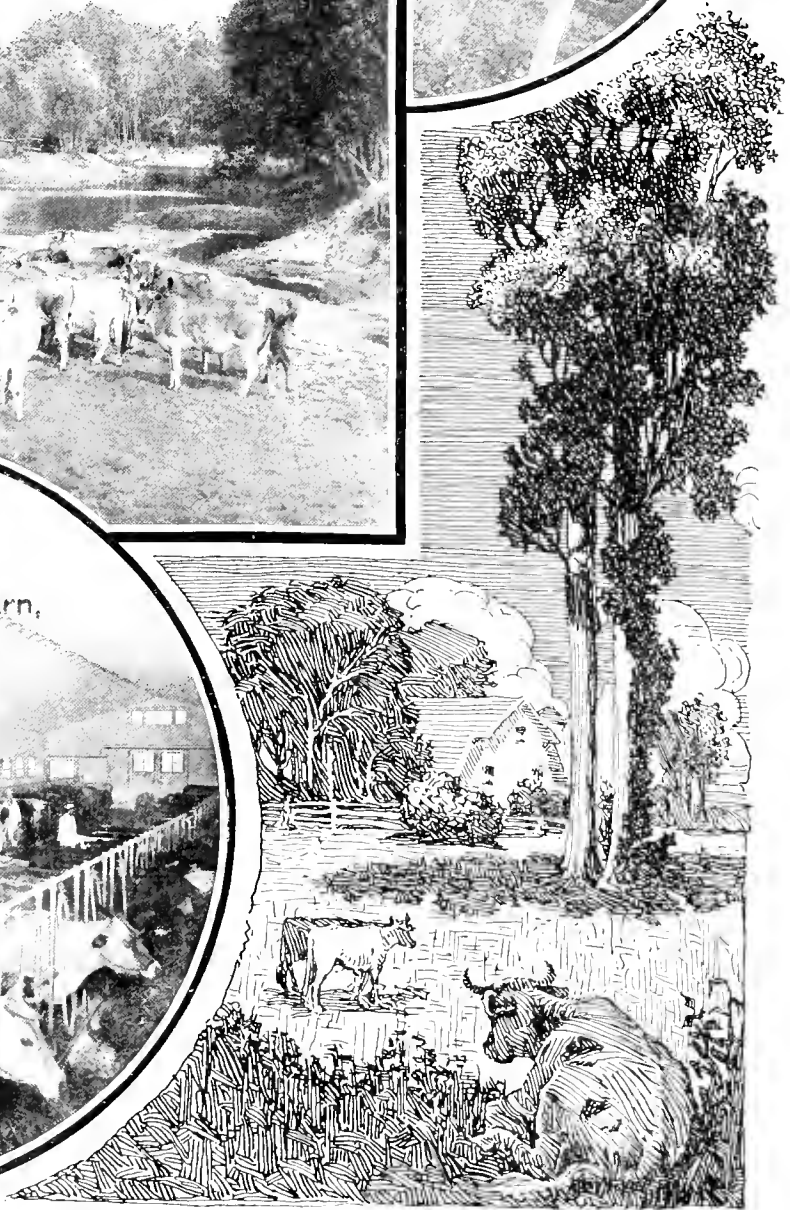
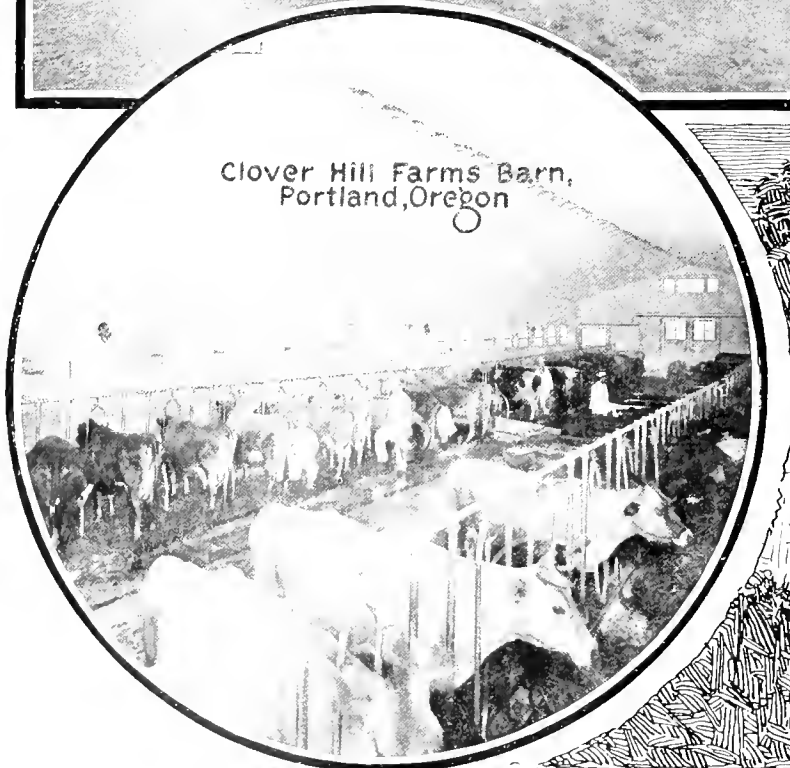
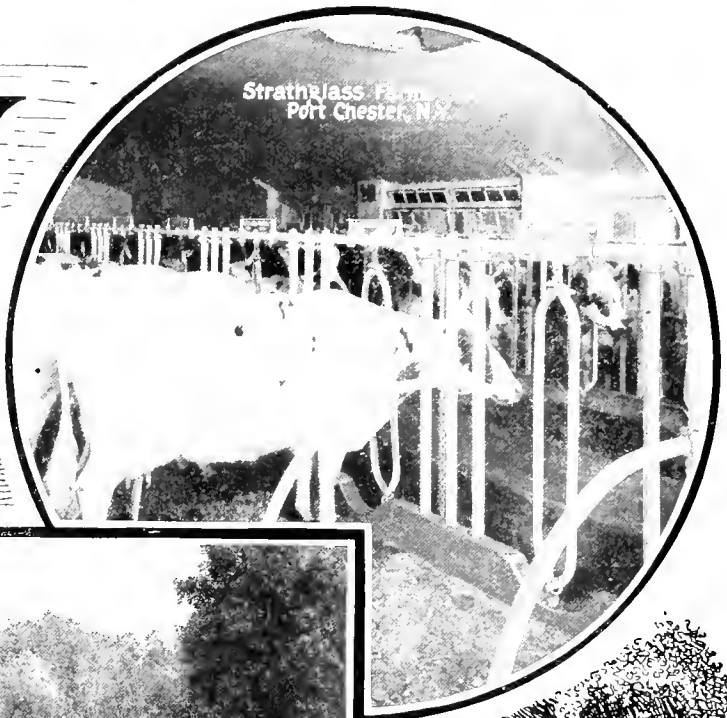

A Few Words About Stanchions

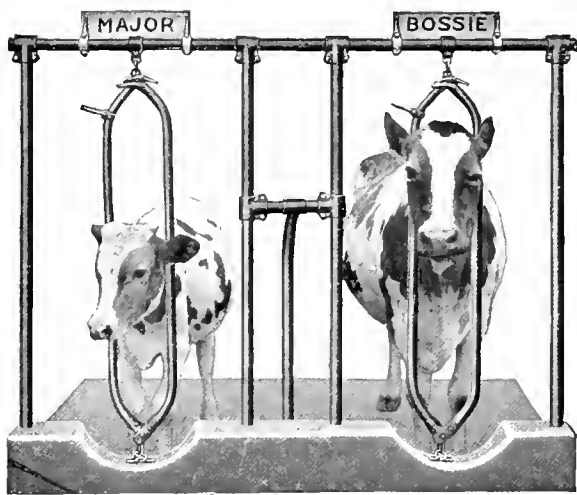

Fig. 1157

There is nothing of greater importance in Dairy Barn Equipment than the Stanchion by which the cow is held. It should be strong and durable to hold the cow securely and yet allow her all the **freedom of movement** necessary for her comfort. A rigidly hung stanchion should not be permitted, and if the law against cruelty to animals was strictly enforced it **would not** be permitted.

The cow must be made comfortable to produce the most milk and return to her owner **the largest profits**. Therefore the stanchion must be flexibly hung so its lower end will be free to swing in a circle of 8 to 10 inches. This is necessary to allow the cow to pitch forward in getting up and lying down without jamming her shoulders against the stanchion and to avoid cramping her neck in lying down at one side or the other of the stall.

The stanchion should be as smooth as it is possible to make it, so it will always be **easy to clean and easy to keep clean**. Also, to make it easily disinfected, no cracks or crevices anywhere to catch and hold dirt

infected when this is necessary. There should be no sharp corners or to furnish breeding places for disease germs.

There should be **no square corners** to rub against the cow's neck. This applies with greater force to the lower end of the stanchion than it does to the sides, because a cow when in her stall will be lying down half the time, and her neck will be in contact with the lower end of the stanchion.

The lower ends of the stanchion bars should always be **sloping or well rounded** and never flat nor have square or sharply rounded corners. This is necessary to prevent the cow from getting her front foot caught between the manger curb and the lower flat or square end of the stanchion and having it seriously injured. A number of cases have occurred in which valuable cows have been ruined in this way.

The hinges at the lower end should be exceedingly strong and be **laterally rigid** to prevent torsional displacement of the stanchion sides in which case the latch at the upper end will fail to register with the catch on the hinged side. There should be no flat surfaces on the hinge castings to catch and hold dirt nor sharp corners to injure the cow's neck.

The latch should be **strong and absolutely animal proof**, and at the same time, be easily unlatched. A "Push-Down" latch is better than a "Lift-Up" or a "Turn-Around" latch, because it can be opened with one hand, closed or mittened, which cannot be done with the other kinds of latches.

The Louden High Carbon Tubular Steel Stanchion shown on other pages, has all the good points enumerated and is, without any question, the best stanchion manufactured. It is decidedly the strongest stanchion in the market, the tubes of which it is made measuring $4\frac{1}{2}$ inches in circumferences as against $2\frac{3}{8}$ inches for the "T" steel of which many stanchions are made. It is also the neatest and smoothest, and has no "**dirt catchers**" or other objectionable features.

The Louden Tubular Steel Stanchions are made in three different widths— $5\frac{1}{2}$, 7 and $8\frac{1}{2}$ inches, (Narrow, Standard and Wide). These sizes will fit the smallest or largest cows. Some people have the mistaken idea that a stanchion, like a hat or a coat or a pair of shoes should fit closely. On the contrary **it should never fit closely**. The **looser the better** provided the cow cannot pull her head through. Fig. 1157 shows a large cow and a six-months old calf, each securely held by the same size Louden Tubular Steel Stanchion.

With the three sizes we make any cow, from the smallest to the largest, can be securely and comfortably held, 90 per cent of them requiring only the standard or 7-inch size. A large, beefy-neck cow will occasionally require the wide or $8\frac{1}{2}$ -inch size, and occasionally it would be better to have the narrow or $5\frac{1}{2}$ -inch size for an exceedingly small cow or heifer.

One size of stanchion can generally be taken out and a different size put in as easily and quickly as an adjustable stanchion can be adjusted, and you can buy Louden Tubular Steel Stanchions for 30 to 40 per cent less money than you will pay for adjustable stanchions.

The Louden Tubular Steel Stanchion has stood the **test of time** and is growing more popular every day. Half a million are already in use in all parts of the world and the sale is rapidly approaching the million mark. In the long run it is cheaper than a halter and is much more convenient. As a cow tie the Louden Stanchion is safer and better in every way.

Louden High Carbon Tubular Steel Stanchion—Continued

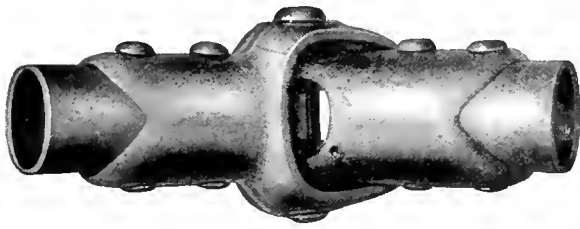

Fig. 1158

The great strength of the Louden Reinforced Stanchion Hinge is readily seen by an inspection of Fig. 1158. The hinge castings are made in our own foundry of the best high-grade malleable iron. The castings are shaped to practically encircle the lower ends of the stanchion sides which are made of $1\frac{5}{16}$ High Carbon Tubular Steel and are securely connected thereto by four heavy rivets.

The pivot end of the hinge is made twice as wide as the pivot ends of other stanchions and the looped end helps to support the other end. A large pivot pin

passes through four thicknesses of malleable iron spread apart to make them bracing. It is therefore of much greater strength than other stanchions, especially in the torsional or twisting strain where nearly all other stanchions are weak.

There are no flat surfaces on the Louden Stanchion Hinge where dirt will collect. The ends being sloping and rounded, debris will roll off and if any should get in the joint the opening in the center will let it pass through. If disease should get into the barn the stanchions can be dipped in a disinfecting solution which will reach every part, inside as well as outside, and will destroy every germ which may be making his dwelling place there.

The latch spring is especially reliable and is completely protected. If a new spring should ever be needed, which is seldom the case, it can be sent by mail for a few cents, and by removing one small bolt it can be quickly put in place.

If the barn should ever burn that will not necessarily put our Tubular Steel Stanchions out of commission. The barn of Mr. L. W. Putman of Frederick, Md., having a Louden Tubular Steel Stall Equipment recently burned and in two days he had a shed over the stalls and stanchions, and was using them the same as ever. There was nothing injured by the fire except the latch springs of the stanchions, and these we sent him free of charge by parcel post.

Mr. Putman, under date of April 20, 1915, writes as follows:

"Last fall my barn containing some 1200 bushels of grain and 100 tons of hay and provender caught fire and burned to the ground. The most remarkable thing about this fire was the condition of the Louden Stalls which were in the basement. The entire weight of the timbers and the heat of the fire went into these stalls. I thought they were ruined but after clearing the debris away I found they were absolutely intact. I built a temporary roof over them and in two days I was using them the same as before the barn was burned. I think this is a remarkable test of the quality of the Louden Stalls."

The best material of which a stanchion can be made is High Carbon Tubular Steel. It is the strongest as well as the lightest and is also the easiest to keep clean. It has no sharp corners to injure the cow's neck; no cracks or crevices to harbor disease germs, nor built-on strips to work loose and come off.

The chains by which the stanchions are hung and anchored to the curb are made of the best quality of steel wire approximately $\frac{3}{8}$ of an inch in diameter, and its tensile strength is 5000 pounds—strong enough to hang up three large cows by the necks. Why use a double chain at the lower end of your stanchion to restrict and hamper the freedom of the cow.

The Louden Tubular Stanchion is the essence of simplicity. It has no complicated trouble-making parts to get out of order. It can be used almost anywhere, in the smallest as well as the largest barn—for the largest or the smallest cows—in a common wood frame as well as the most up-to-date cow stall. No one who keeps cows, whether one or a hundred, can afford to do without Louden Stanchions.

We call attention to our patent No. 990,827, dated April 25, 1913, which covers the main features of our Stanchion, including the Hinge, the Latch and the Sloping Ends. Beware of infringements.

Specifications

Three Sizes. Narrow, having a width of $5\frac{1}{2}$ inches; Standard, 7 inches, and Wide, $8\frac{1}{2}$ inches, all in the clear and all having a length 45 inches in the clear, and $57\frac{1}{2}$ inches from end to end of the chains. Standard size will always be furnished unless otherwise specified. Space from top-rail to curb must be 4 feet 7 inches (55 in.) to hang stanchion properly.

Equipment. Stanchions are furnished in four ways as shown by cuts on opposite page. 1st, the Naked Stanchion; 2d, the Stanchion with Guide or Hold-Open; 3d, Stanchion with Holder and Anchor; 4th, Stanchion with Guide, Holder and Anchor. For convenience the Attachments are left off and packed separately in shipping.

Weights. The naked Stanchion, standard size, weighs 15 lbs.; with Guide, $15\frac{1}{2}$ lbs.; with Holder and Anchor 16 lbs.; with Guide, Holder and Anchor, 17 lbs. The Narrow Stanchion weighs a little less and the Wide Stanchion a little more.

The Holder is made to fit $1\frac{5}{8}$ and $1\frac{7}{8}$ O. D. tubing. Be sure to specify size in ordering.

Louden Tubular Steel Stanchions—Continued



Stanchion
Only

Fig. 861

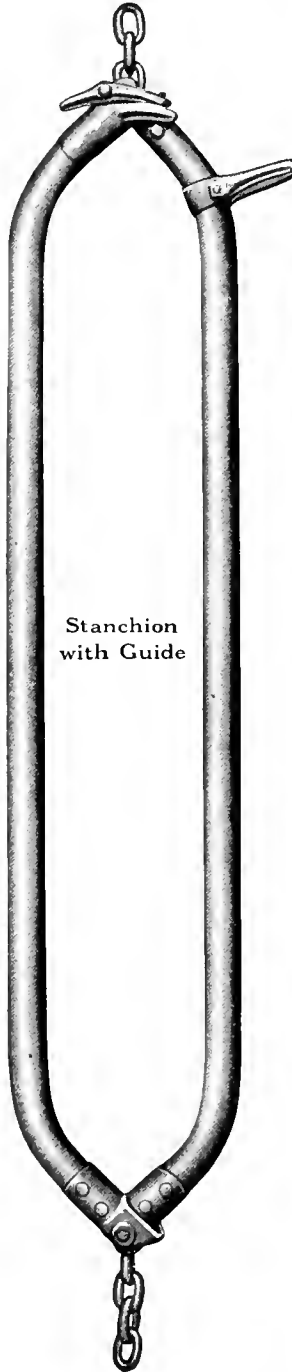

Stanchion
with Guide

Fig. 861-A

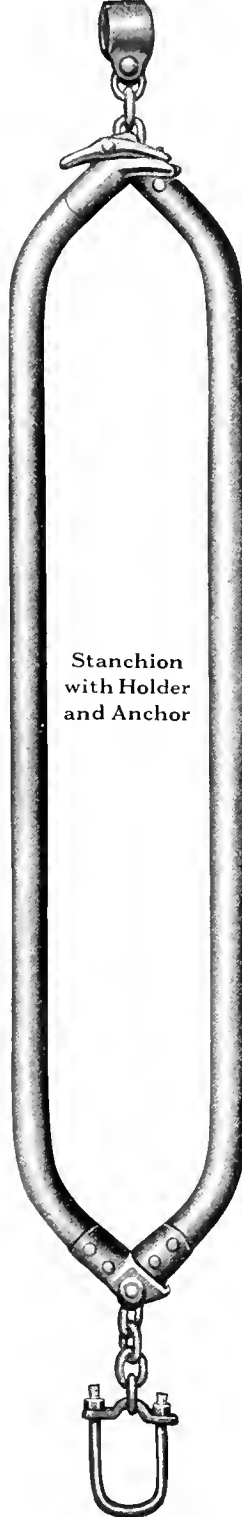

Stanchion
with Holder
and Anchor

Fig. 861-C

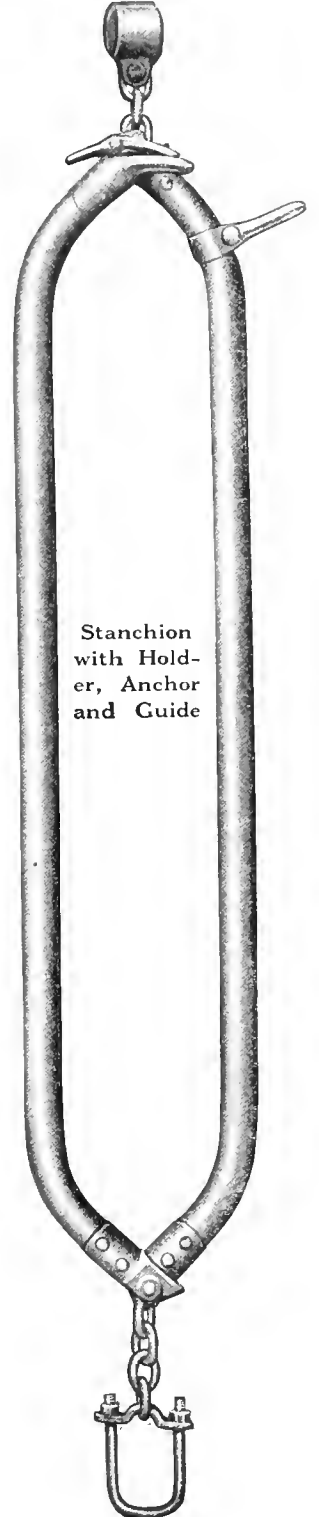

Stanchion
with Hold-
er, Anchor
and Guide

Fig. 861-B

Louden Tubular Steel Stanchions—Naked and with Attachments

Louden Wood-Lined Steel Stanchion—Fig. 937

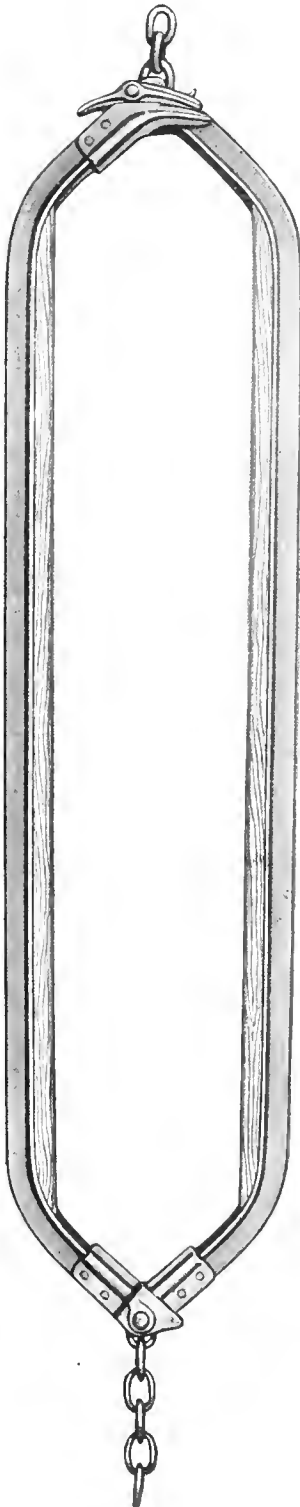

Fig. 937

Patented Aug. 1, 1916.

Some people think that steel is cold on the cow's neck and want the stanchion lined with wood to keep her neck warm. Our Wood-Lined Stanchion is in response to this demand. We do not think there is anything in this contention, or at least, not enough to overcome the objectional features of the wood lining.

We all know that metal is a more active conductor of heat and cold than wood, and that when metal is pressed against the naked skin in freezing weather it will have a greater chilling effect than wood. This fact is responsible for the belief that an all-metal stanchion is cold on the cow's neck.

The conditions, however, are not parallel. To make them so, the hair on the cow's neck would have to be shaved off and the metal bar would have to be pressed against her naked skin. A properly hung stanchion will not often more than merely touch the cow's neck, and the hair on her neck is certainly the equal of a mitten on the hand in resisting cold.

Put mittens on a man's hands, blindfold him, set up a well-oiled fork handle and a piece of tubular steel of the same size, let him loosely encircle them with his mittened hands, the same as the cow's neck touches the stanchion, and he cannot tell the one from the other by the difference in temperature. We have never had a single complaint on this point from the users of our half million Tubular Steel Stanchion—many of them in the coldest parts of Canada. It is always the person who has not used them who raises the objection.

A wood-lined stanchion is not as strong as the Tubular Steel. It is not as smooth and as easily kept clean. The crevice below the wood lining is objectionable on account of collecting dirt and harboring disease germs. No wood-lined stanchion has any lining at the lower end and as the cow will be lying down at least half the time her neck will be in direct contact with the "cold" steel. We will not, however, try to convert you.

If you want a Wood-Lined Stanchion we will furnish you the best one made. With the exception of the side bars, it has all the superior features of our famous Tubular Steel. It has the same extra strong hinge, the same convenient animal-proof latch, and the same sloping ends. It is also provided with the same chain of 5000-lb. tensile strength and is arranged to be flexibly hung to give freedom of movement and comfort to the cow.

In addition to this it has special features of its own. The "T" Bar which is heavier than that generally used in wood-lined stanchions has an extra rib on its inner side, as shown by Fig. 1026, which makes it still stronger. The wood lining strip has a groove on its inner face which fits over the rib on the bar and this makes it extremely difficult to knock the strip off, even with a hammer. It would have to be all broken up and split to pieces before it could be knocked off the bar. The wood linings of other stanchions are not half as strongly attached.

Another point, there are no sharp corners on the ends of the wood linings as there are on other wood-lined stanchions. They are beveled off and made entirely smooth as shown in the cut.

There are thousands of our Wood-Lined Stanchions in use giving good satisfaction. We are well equipped to manufacture this stanchion and from a manufacturing point of view, it makes no difference to us which stanchion you choose.

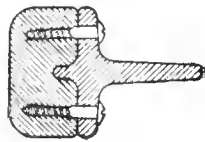

Fig. 1026

Specifications

The Louden Wood-Lined Stanchion is made one size only, 7 inches wide and 4 ft. long in the clear. The "T" Bar is high carbon steel $1 \times 1 \frac{3}{8}$, with $1 \frac{1}{4} \times \frac{3}{8}$ rib. The Wood Lining is $3 \frac{3}{4} \times 1$, seasoned hard maple.

It is furnished naked; or, with 1 Guide or Hold-Open; or, with 1 Guide, 1 Interlocking Stanchion Holder, and 1 Regular Stanchion Anchor.

Weight. Naked Stanchion, 20 lbs. With 1 Guide or Hold-Open, $20 \frac{3}{4}$ lbs. With 1 Guide, 1 Holder and 1 Anchor, 22 lbs.

Note: The Stanchion Holders are made for $1 \frac{5}{8}$ and $1 \frac{7}{8}$ O. D. tubing.

Be sure to state which size is wanted.

Clear Lake, Minn. June 8, 1916
The Louden Machinery Co.,
Fairfield, Iowa.

Gentlemen:

We installed 10 cow stalls and one bull pen and they have been thoroughly tested to their strength. We have another make of stanchions but we are going to throw them away and put in Loudens for they are the best.

Very truly yours, W. Bowers & Son.

Louden Quick Adjustable Stanchion

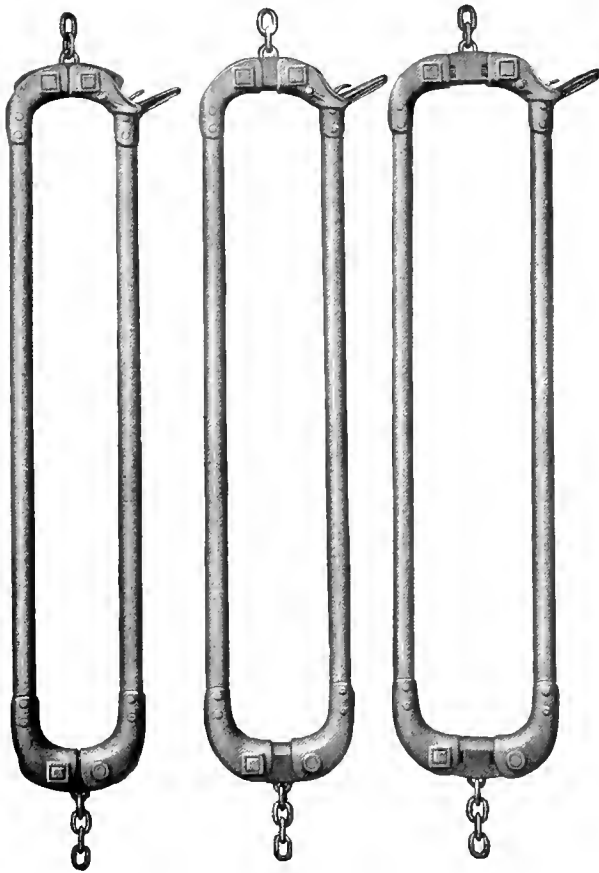

Fig. 1159

Patented July 6, 1915.

By applying the key, shown in Fig. 1160, to the square end of the screw, it can be easily and quickly turned in either direction, and will move the blocks, B, in or out in the slots of the heads, E, and carrying the corner plates, C and D, with them will adjust the sides, A, wider apart or closer together as desired. The lower end is the same except that the block on the opening side of the stanchion is pivoted to the corner plates, as shown by Fig. 1159. This is certainly the most perfect adjustable stanchion ever invented.

We offer our **Quick Adjustable Stanchion** to meet the demand which has, no doubt, been created largely by the advertising of adjustable stanchions. We have thought that with the different sizes of stanchions we make, and with the fact that a stanchion should always **fit loosely** on the cows' necks, there was no need for an adjustable stanchion.

The demand, however, exists and we herewith present the very best adjustable stanchion manufactured. It is made of high carbon tubular steel (the best material of which a stanchion can be made) and is provided with adjustable heads and bottoms of malleable iron which can be **instantly adjusted** from the narrowest to the widest size. They are each provided with large double ended right and left handed screws fitted in threaded blocks, B (see Fig. 1160), and by turning this screw with a key the sides of the stanchion will be instantly adjusted in or adjusted out.

There are no bolts or set screws to tighten or loosen and be liable to slip and spoil the adjustment. The change from the widest to the narrowest or to any intermediate size can be made by an expert in half a minute and by any one in less than a minute. When the stanchion is adjusted to a certain width it will **stay there** until the screw is turned by the key.

The adjusting mechanism cannot be equalled. As will be seen by Fig. 1160, which is an interior view of the head (the malleable plates on the front side being removed), the stanchion sides, A, are fitted with corner plates, C and D, to which the ends of the threaded blocks, B, are attached. The head plates, E (the plate on the near side being removed), which cover the adjusting mechanism are fitted with slots through which the threaded blocks, B, are passed to connect with the corner plates, C and D.

Specifications

The Louden Quick Adjustable Stanchion is made of $1\frac{1}{2}$ O. D. high carbon tubular steel. In the clear it is 45 inches long and is adjustable from $5\frac{1}{2}$ to 8 inches in width. Extreme length from end to end of chains, $57\frac{1}{2}$ inches. The space from top-rail to curb must be 55 inches to hang stanchion properly. A key will be furnished with each bundle of stanchions or with each single stanchion shipped alone.

Weights. The stanchion is furnished in two ways, naked or with Interlocking Holder and Regular Anchor. The Guide or Hold-Open is permanently connected to the Stanchion. The naked Stanchion weighs $23\frac{1}{2}$ lbs; with Holder and Anchor, $24\frac{3}{4}$ lbs.

The Holders are made for $1\frac{5}{8}$ and $1\frac{7}{8}$ O. D. top-rail. Be sure to specify which size is wanted.

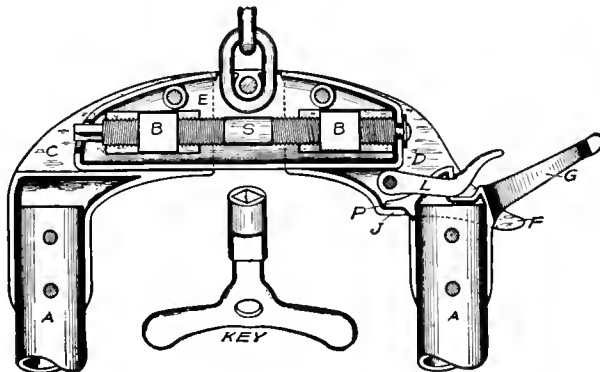
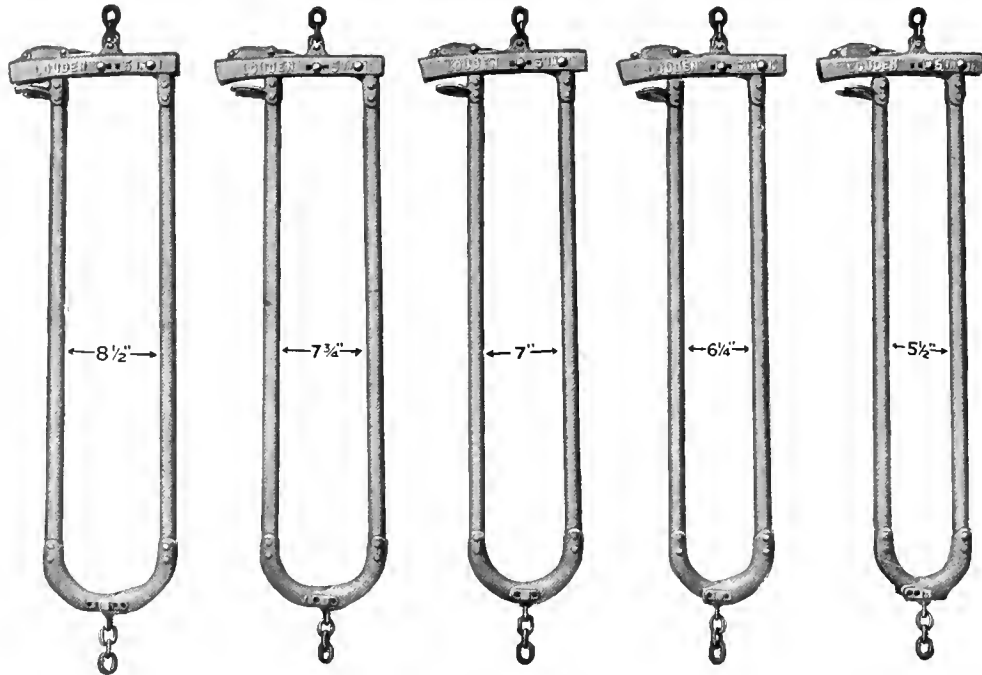

Fig. 1160



Louden 5-in-1 Stanchion—Fig. 1161

Patented Aug. 8, 1916.

The "Louden 5-in-1" may be called an "Adjustable Stanchion" but it is hardly that in the common acceptance of the term. It cannot be adjusted from one width to another by turning a screw or tightening and loosening a "slip-joint," like regular adjustable stanchions. Each of the hinge irons have **three separate holes**, in any one of which the hinge bolts may be placed. The head of the stanchion is made to set in three different positions on the rigid side, and the hinged side is arranged to latch in three separate positions by changing the central bolt, B. (See Fig. 1162).

By this means the stanchion may be set in five different widths $5\frac{1}{2}$, $6\frac{1}{4}$, 7, $7\frac{3}{4}$ and $8\frac{1}{2}$ inches wide in the clear. In whatever position it may be set it will **stay there** and will be just as solid and unchangeable as if that was its only width. In short it is a stanchion which may be set in five different widths, thus combining five different sizes in a single stanchion, hence its name "5-in-1."

The sides are straight pieces of high carbon tubular steel. The hinges of refined malleable iron are rounded as shown in the cuts so as to encircle the lower ends of the sides and are secured thereto by four rivets. Fig. 1162 is an interior view of the head, the front plate which is of malleable iron being removed to show the latch, L, and other interior parts. The rack, R, in which the latch works acts as a support to the upper end of the hinged side, retaining ribs, being formed on the inner sides of the end of the head plates, H, and on the ends of the rack, so they cannot be drawn past each other.

This arrangement prevents the side from being opened out too wide and does away with the need of a stop on the hinge. It has no top support and the hinge is fitted with a stop to prevent it from opening too wide. It has

a push-down latch which catches the rack automatically and is completely protected by the head plate so a cow cannot reach it with her horns. It is easily changed from one size to another.

Specifications

The Louden 5-in-1 Stanchion is 45 inches long in the clear. The sides are $1\frac{5}{16}$ O. D. high carbon tubular steel. From end to end of the chain is $57\frac{1}{2}$ inches. The space from the top-rail to the curb must be 55 inches.

Weights, etc. The Stanchion is furnished in two ways, either naked or with Interlocking Holder and regular Anchor. The Naked Stanchion weighs $23\frac{1}{2}$ lbs.; with Holder and Anchor it weighs $24\frac{3}{4}$ lbs.

The Holders are made for $1\frac{5}{8}$ or $1\frac{7}{8}$ O. D. 'op-rail.
Be sure to specify the size wanted.

Hoffman, Minn. June 8, 1916
The Louden Machinery Co., St. Paul, Minn.

Gentlemen:
I am using Louden Stanchions and find them very satisfactory.
Would be pleased to get your new catalog.

Chas. A. Willd.

Gravity Water Bowls—Fig. 1275

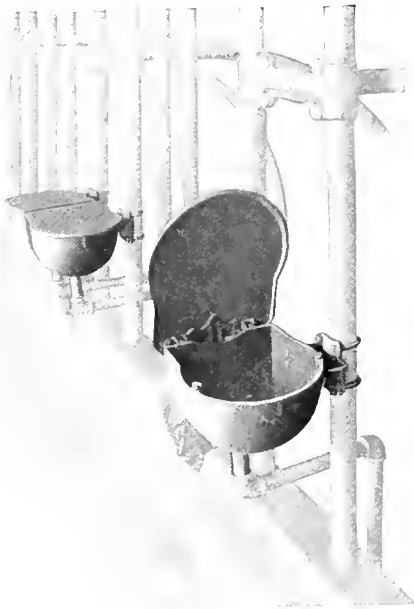

Fig. 1275
Patent Pending

Specifications

Operation: Cow pushes back lid with her nose when she drinks. As she drinks, the governing tank, by reason of gravity and the float, permits water to run into the bowl—keeping the water at the same level. Operation is simple and dependable. No labor and little attention is needed upon the part of the attendant.

Construction: Bowls are heavy cast iron of excellent quality, with brass and malleable iron fittings. Bowls are constructed to fit $\frac{3}{4}$ -inch supply pipe. No inlet or drain pipes are furnished. All pipes and fittings are stock sizes that may be secured from any plumber.

Capacity: About 6 quarts. Automatic action of governing tank keeps bowl filled to desired point while animal is drinking.

Dimensions: (Outside of Bowl) $8\frac{1}{2} \times 9$ by $5\frac{1}{2}$ inches deep.

Finish: Painted or galvanized.

Weight: 13 pounds.

Governing Tank

Fitted complete with Inlet Valve and Float and 3-inch section of pipe to which main supply is to be attached.

Construction: Heavy galvanized Sheet Steel with lid.

Capacity: 5 gallons.

Dimensions: Depth, 11 inches; diameter, 16 inches.

Weight: 11 pounds.

NOTE—The Gravity System of Watering Includes: The necessary number of bowls—one for each cow—an automatic governing tank, and sufficient pipe for carrying water from governing tank to each bowl. We furnish only the bowl—no part of the pipe or connections—and the governing tank. Bowls are priced singly, and governing tank separately.

The Louden Gravity Watering System is a simple, convenient, and reliable method of watering the cows.

The bowls are attached to the stall posts at a uniform distance from the floor, the top of the bowls being level with each other. At the end of a row of stalls, in a convenient position, is located the governing tank. As the animal drinks from the bowl, the float on the valve in the governing tank drops, permitting water to enter. The governing tank keeps the water in all bowls at a uniform depth at all times.

The principles of our gravity system have been used successfully for many years, and are known to be correct and unailing.

In our Gravity System only one main water pipe is necessary. At one end of row of stalls this pipe is attached to the governing tank while at the other end of row it is attached to a drain, or may be run into gutter if desired. When bowls are in use the cock next the drain should be kept closed, and the cock at the governing tank should be kept open. This will permit the governing tank to keep the bowls full. When it is desired to drain the pipes, the cock at the governing tank should be closed and the drain cock should be opened. This permits all water to drain off.

We furnish our Gravity Bowls either "right" or "left" so that they may be used on either right or left side of stalls. Figure 1275 shows how these "right" and "left" bowls may be arranged—either singly or in pairs.

Water bowls should be attached singly to single post stalls. Fittings for attaching two bowls to a single post are charged extra.

As different barns require different types of piping systems, we furnish no pipe with the bowl. All pipe, together with elbows, etc., are standard stock sizes that may be obtained from a plumber.

Gravity Bowls can be furnished either with or without lids. We recommend that lids be used, as they prevent dirt from gathering in the bowls. Cows readily learn to push back the lids to drink, and when through drinking the lid drops back into place. Lids are equipped with rubber bumpers to make their action noiseless.

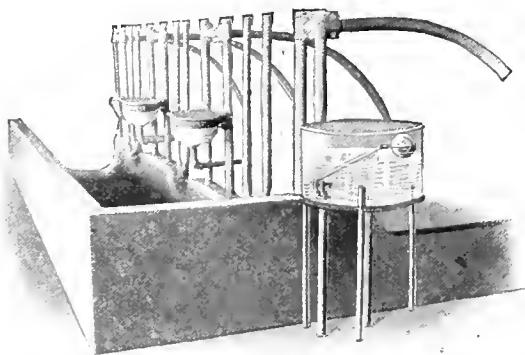

"Ghost View" of Governing Tank and Bowls.
The water in the tank and bowls is kept at the same level by means of the ball float.

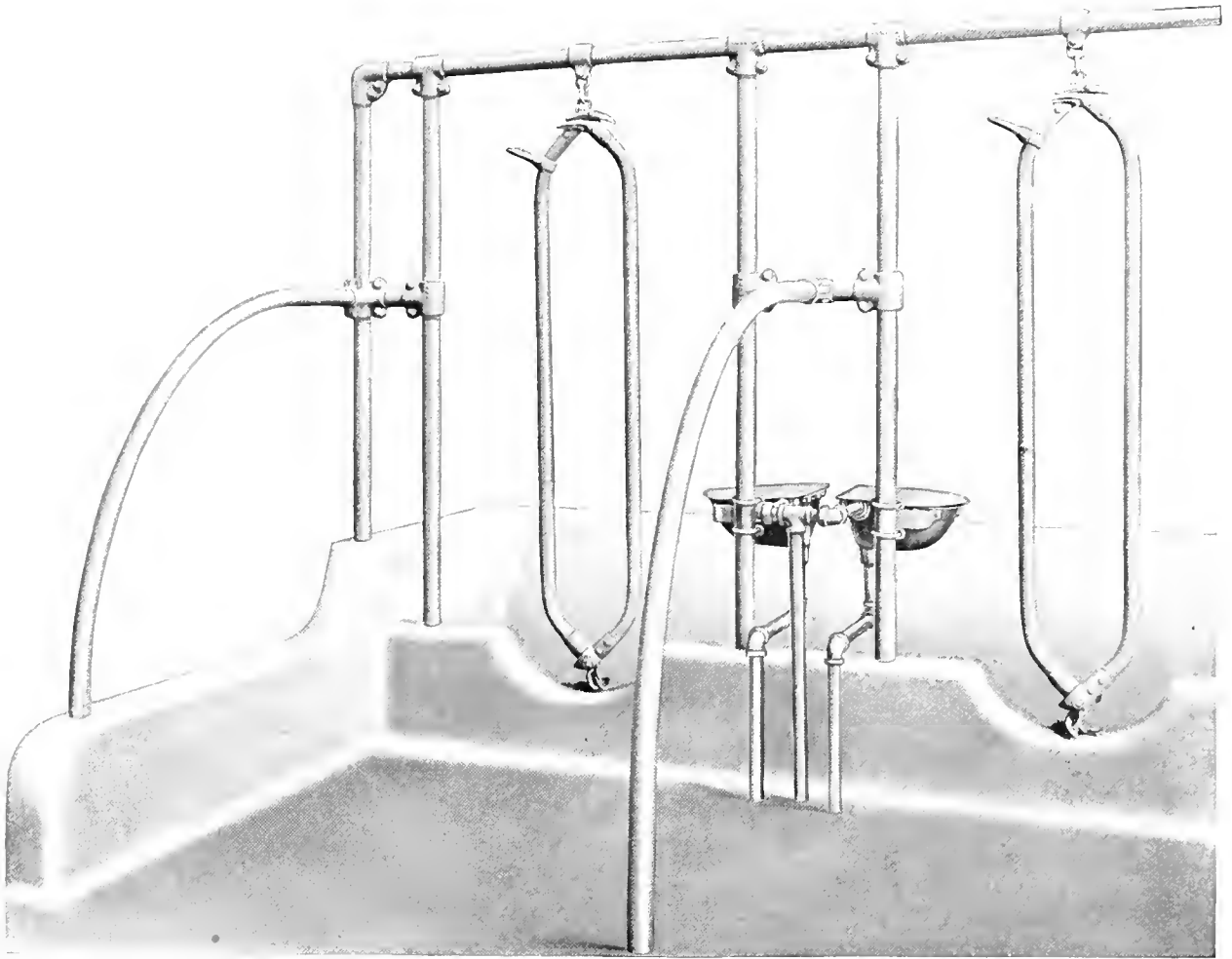

Louden Sanitary Automatic Drinking Bowls—Fig. 1274

Specifications

Double Bowl

The Double Bowl consists of two water bowls with all connections necessary for joining to stall posts. Pipes or Bowls do not interfere with the operation of Mangers or Manger Divisions.

No inlet or drain pipes are furnished. All pipes and fittings are stock sizes that may be secured from any plumber.

Operation: Cow pushes back lid with her nose when she drinks, automatically opening the supply pipe, thus admitting water to the bowl. The water is entering constantly as she drinks. When she finishes drinking the weight of lid dropping back into place closes supply pipe, and automatically opens drain, permitting all water to run out. Bowl has overflow connection with drain so that if water enters faster than the cow drinks, it will not run over on the floor.

Construction: Heavy malleable iron bowl with steel lid. All parts rounded edges. Sanitary construction throughout. Made to use with $\frac{3}{4}$ -inch supply pipe.

Capacity: Each bowl is so regulated that it holds about two quarts while cow is drinking. Entire capacity about 5 quarts.

Dimensions: (Outside of bowl) $8\frac{1}{2} \times 9\frac{1}{2}$ by $4\frac{1}{2}$ inches deep.

Finish: Painted or galvanized as specified.

Weight: (per pair complete with connections) $26\frac{1}{2}$ pounds.

Single Bowl

Single Bowl consists of one water bowl with all connections necessary for joining to stall posts.

Operation, Capacity, Dimensions, and Finish. Same as described under Double Bowls specifications.

Weight: One bowl complete with connections, $13\frac{1}{4}$ pounds.

NOTE: In warm climates or in barns where there is no danger of freezing it may be desired to run water supply pipe, parallel with stall top rail instead of under floor as is recommended. With this plan a supply of our Parallel Clamps should be ordered with the Bowls. There are four sizes of clamps. Be sure and give outside diameter of your stall top-rail and we will send Clamps to fit.

Points of Superiority in Louden Sanitary Automatic Water Bowls

It is the only really sanitary watering system. It is strictly individual. No cow ever comes in contact with water from which another cow drinks.

Each bowl has a separate inlet, connected directly to the main supply pipe, and a separate drain, connected with the main sewer. The refuse water does not run from one bowl to another.

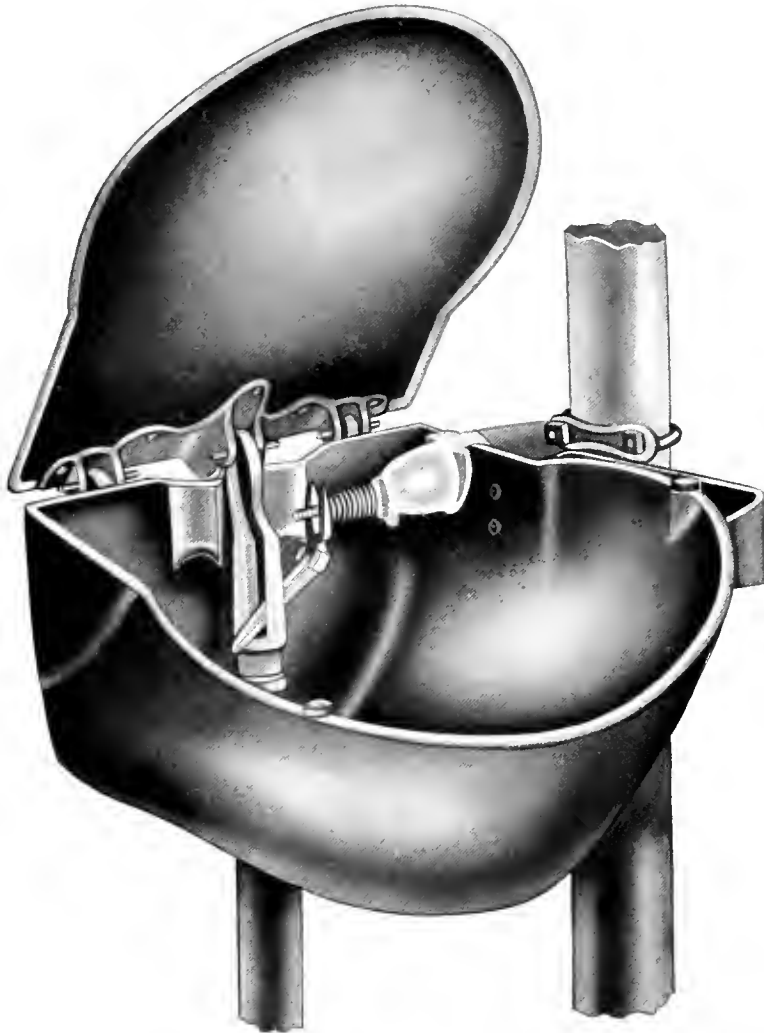

Fig. 1294—Inside View showing Simple Mechanism of Bowl.
It's always in "working order."

With the Louden Automatic Watering System the cow drinks as much as she likes as often as she desires, without any attention or labor upon the part of the attendants. There is very little wasted water and it is always pure and fresh.

With the ordinary watering system, water stands in the bowls till the cow is ready to drink—sometimes for hours—gathering impurities and becoming stale. With our Automatic Bowls no water is in

(Continued on page 119)

The cow waters herself. She has clear, fresh water, of the right temperature, always before her.

Water does not stand in the bowl. When the cow drops the lid all refuse water drains off.

There is only enough water in the bowl at one time to permit the cow to drink comfortably. Very little water is wasted.

The bowl is shaped to fit the cow's nose. There are no corners to catch dirt. It is easily kept clean.

The close-fitting lid keeps out all impurities. Rubber bumpers on each side of the bowl deaden the sound of the dropping lid.

The Louden Automatic Water Bowl System will save you valuable time. It will keep your cows in better condition and increase their milk yield.

It will begin paying for itself the day you put it in your barn.

ASK THE OWNERS

Of These Modern, Money
Making Barns How Much
The Louden Automatic Water
Bowls Have Increased the
Milk Yield.



Dudley E. Waters' Barn,
Grand Rapids, Mich.
Louden Planned and Equipped

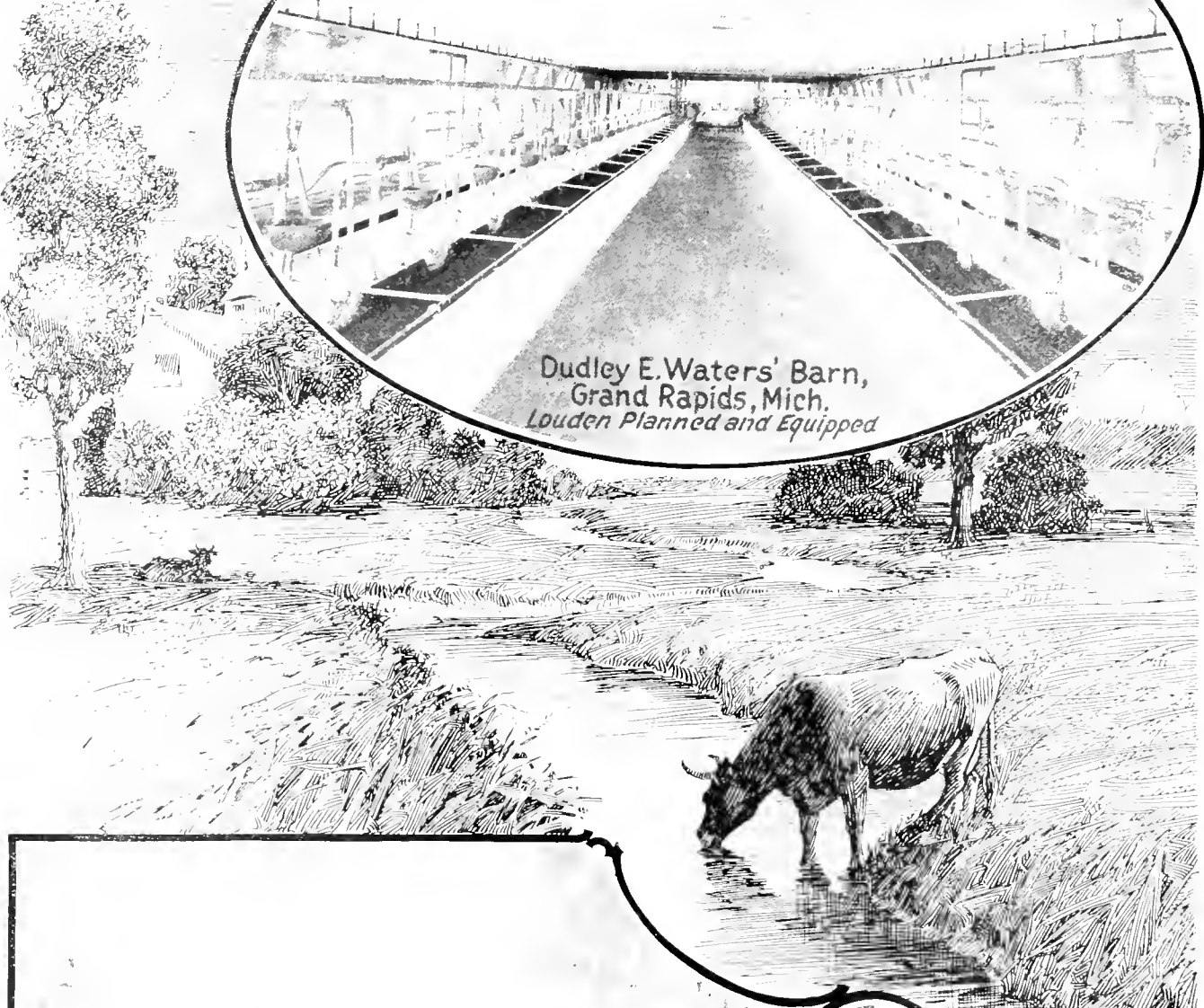

Louden Automatic Water Bowls—Continued

bowl except when the cow is drinking. Fresh water is admitted by the cow raising the lid of the bowl (as she will readily learn to do). This automatically opens the water valve, at the same time closing the drain. When the cow finishes drinking the lid drops into place, closing the water valve and opening the drain, so that the water will all run out through the drain pipe.

Louden Sanitary Water Bowls are individual which is the only safe way to prevent a diseased cow from infecting her neighbor, and while they may be placed singly, it is preferable to arrange them in pairs as shown in Figure 1274, one on each side of every other manger division, when divisions are used, which they should be. The bowls are made right and left to suit this arrangement, saving considerable in piping.

The bowls have no sharp corners anywhere to catch and hold dirt or to injure the cows. They are compactly built and arranged to occupy but little room, the top of the bowls being about 24 inches above the stall floor, which is the most convenient and natural location for the cow.

The bottom of the bowl is made rounding to fit the cow's nose, thus requiring the very smallest amount of water to enable her to drink. The outer edge of the bowl is fitted with two rubber bumpers which makes the dropping of the lid noiseless. By this means the cows are not induced to play with the lids. When the bowl is full the water will overflow through the drainage plug.

Every imaginable point has been looked after in the construction of these water bowls and we have decidedly the best ever made. The principle is correct and the construction is right.

Louden Sanitary Water Bowls are secured to the stall posts by means of brackets riveted to the sides of the bowls. These brackets are secured to the posts by clips. The brackets have an adjustment of several inches to suit posts set different widths apart, and may be connected to the posts of any of our stalls.

Bowls may be attached in pairs to single post stalls if necessary, but we do not recommend such an arrangement. They should be attached singly. Fittings for attaching two bowls to a single post are charged extra.

Installation

The water for the bowls may be drawn from a supply pipe laid in the cement in front of the cow's feet or pipe may be attached to and parallel with the top rail. We are prepared to furnish parallel clamps for this method, but recommend the other plan.

Where this watering system is to be installed at the time of new floor and manger construction, the curb and manger is made first, according to our directions, and the water bowls and pipes for same are put in place before putting in the stall floor. The supply pipe may either be on the ground below the cement or it may be placed near the top of the floor. If the cement is already in, a groove may be cut in the floor and the supply pipe laid in it so it will only be covered with the fresh cement used to fill the groove. Many of our customers, when putting in a concrete floor have found it desirable to lay a 4x4 where the pipes are to go in. This timber can be removed whenever it is desired to lay the pipes—whether it is in six days or six months.

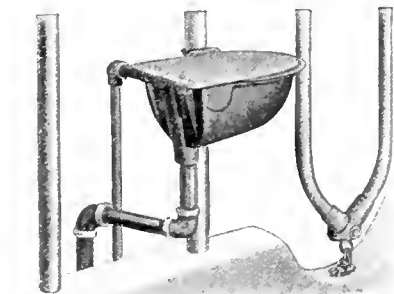

Fig. 1274-B
Single Bowls can be furnished for either right or left side of stall.

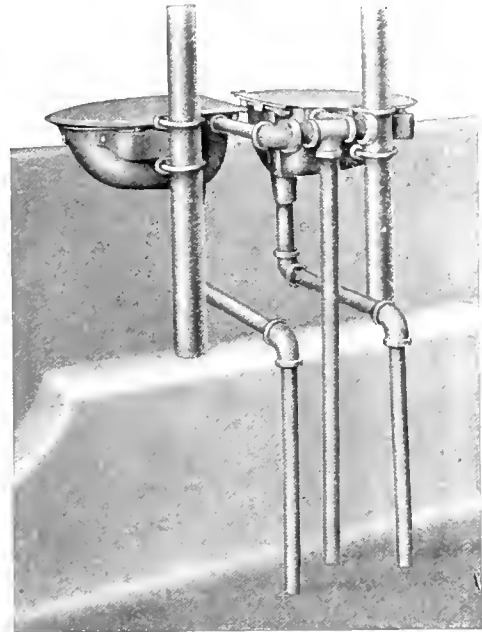
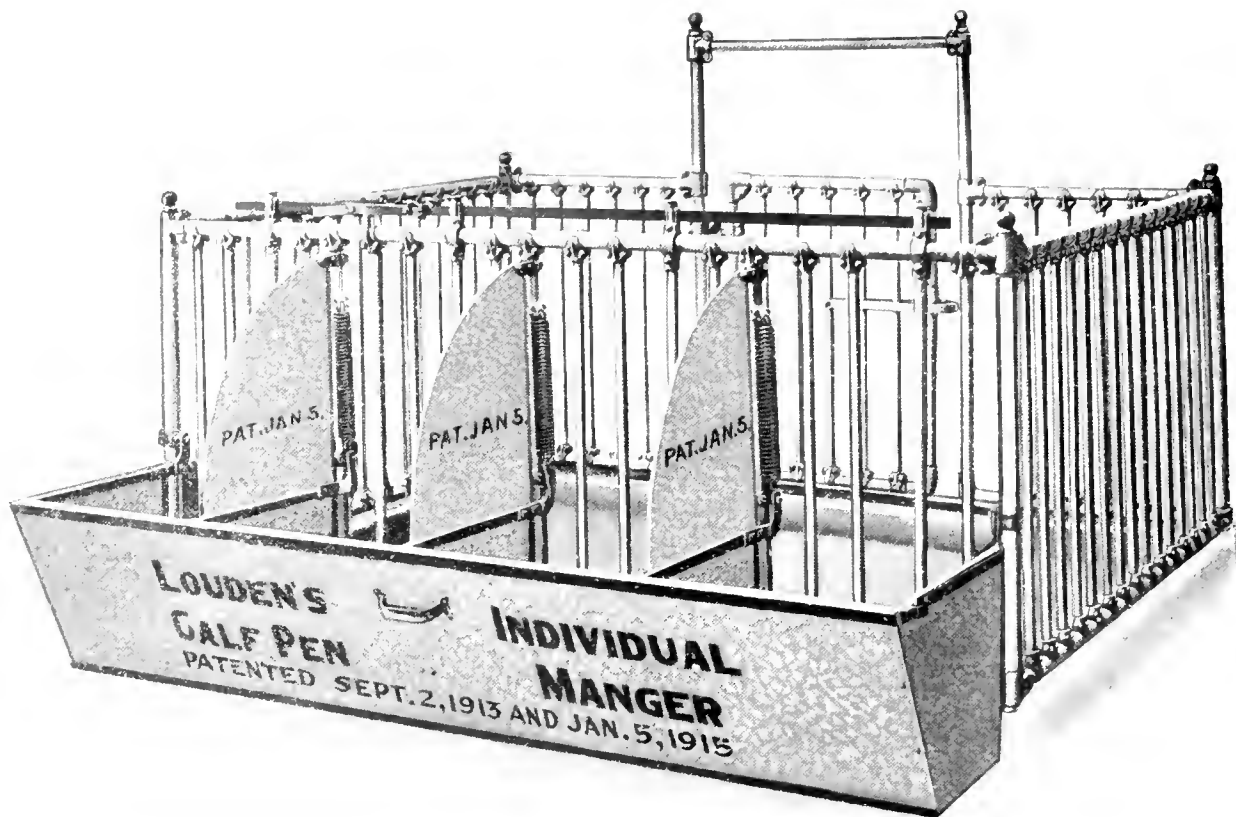

Fig. 1274-A

When the cow drinks she pushes back the lid of the bowl, automatically opening the supply pipe. When she finishes drinking, the lid drops back into place, closing supply pipe and opening drain.

When cork brick or creosoted blocks are used it is best to place the supply pipe immediately below them. Located in this position the supply pipe may be readily taken up and replaced if this should ever be necessary. By placing the supply pipe under the floor the water will be kept cooler in hot weather and will not be so liable to freeze in cold weather.



Louden Calf Pen with Individual Mangers—Fig. 1021

(Corner Couplings Patented Aug. 17, 1915.)

Here is something for your barn that will greatly improve it and will start your calves on the way to future productiveness and profit. The Louden Calf Pens are complete in every respect, being light, well ventilated and easy to keep clean. They are fitted with stanchions to hold the calves in place while feeding. They are provided with **individual mangers** which will prevent the calves from stealing each other's feed or upsetting their buckets. They have **Patented Stationary Up-Standing Shields** which completely overcome the harmful habit of sucking each others ears.

The stanchions can be opened all at once or only one at a time. The manger is **spring balanced** so that a boy can easily raise and lower it. When raised half-way up it will **stand at any point** without any hooks or latches or anything else to hold it in an elevated position. The manger divisions telescope with the stationary shields in raising and lowering. The springs can be **readily adjusted** to always perfectly balance the manger. The pen is securely enclosed by a **strong gate** hung on substantial hinges and has a **Hold-Shut Latch**, described on another page, which prevents the calves from getting out or other animals from getting in. The design is neat and artistic and besides its great usefulness, it is an ornament in any barn.

Calves will grow faster and will do better in a neat, light, well ventilated, thoroughly sanitary Louden Calf Pen than in the old, stuffy, dark, dirty, wooden boxes which are sometimes called pens and which are too often used to stow away little calves until they are able to shift for themselves. As the "twig is bent so the tree is inclined," is as true of baby calves as it is of other babies, and they should have the kindness and care that will make their wabby little legs grow straight and strong and which will best develop their vitality so they will be most efficient when they take their place in the world as producers. A Louden Calf Pen is one of the essentials in raising calves.

Fig. 1021 shows the manger in feeding position and Fig. 1022 on opposite page, shows it raised for cleaning. The manger divisions are hinged to the vertical tubing or fillers of the pen. The lower ends of the springs are **pivotaly** connected to the hinges and their upper ends are **adjustably** connected to the tubing as most plainly shown in Fig. 1021. The manger raises high enough to pass away above the calves' heads. The stanchions are easily adjusted to suit growing calves.

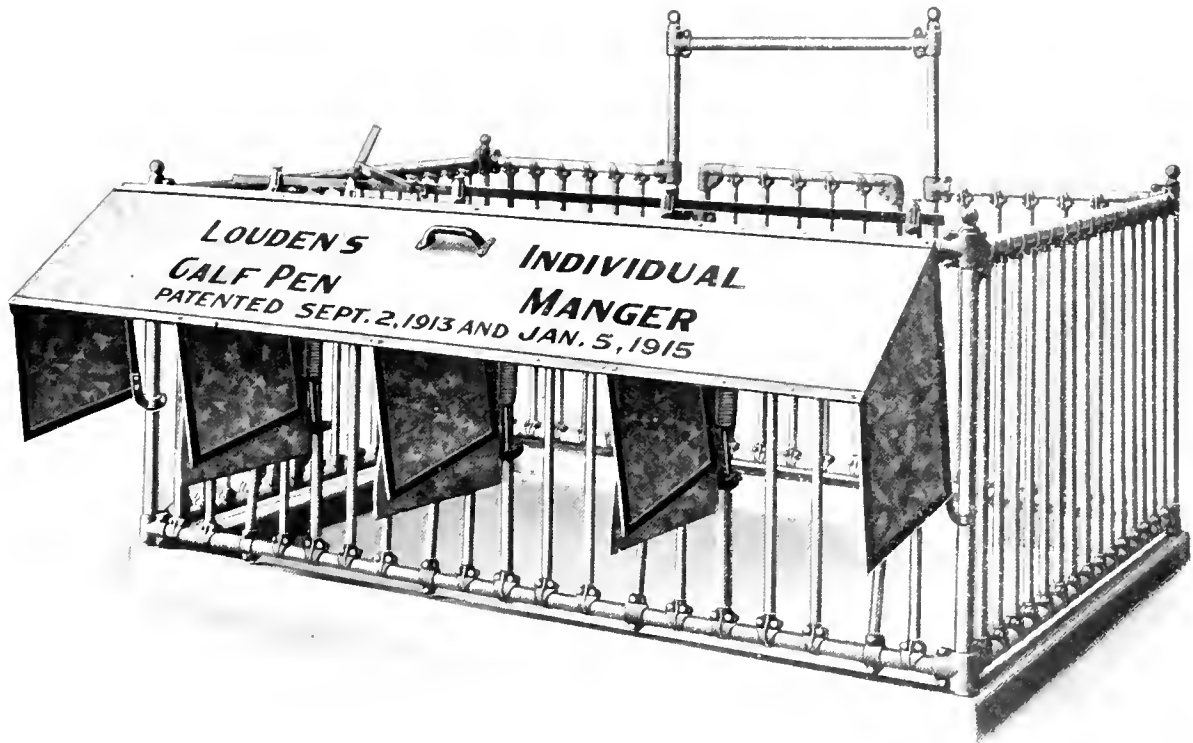

Louden Calf Pen with Individual Mangers—Fig. 1022

Specifications

Sizes of Tubing. The top and bottom rails, corner posts and gate posts and the arch-rail are $1\frac{3}{8}$ O. D. steel tubing. The vertical fillers and stanchion bars are $1\frac{1}{8}$ O. D. steel tubing.

Lengths of Tubing. The corner posts are 52 and the gate posts are 81 inches long. The fillers and stanchion bars are 36 inches long. The standard height of panel is 46 inches above the floor.

The Connections. The top and bottom rails are connected to the corner post by the Louden Corner Couplings. The fillers are set $4\frac{1}{2}$ inches apart on centers and are connected to the top and bottom rails by Louden Grip Clamps.

The Construction. The pens are built in panel sections extending from one corner post to another and from the corner posts to the gate posts. The fillers in the stanchion section are spaced to suit the stanchion bars. All the fillers are adjustable on the top and bottom rails.

The Stanchion Section. The standard width between the Stanchions is 2 feet. A section 8 feet long will have 4 stanchions; a 10-foot section, 5 stanchions, etc. The stanchion bars are hinged to the bottom rail and their upper ends have malleable castings which extend above and slide on the top-rail.

The Shift Bar. The upper ends of stanchion slide castings are connected to a Steel Shift Bar $\frac{1}{2}$ x 1 inch, and long enough to take in the row of stanchions. Near one end it is provided with a shift lever, which is pivoted to a casting on the top-rail so that by rocking the lever back and forth the shift bar will be moved and will open and close the stanchion bars.

Drop Pins. Each slide casting is fitted with a Drop Pin which drops in an adjacent notch in the shift bars and thus connects the slide casting to the shift bar. By lifting the drop pin the stanchion bar may be moved independently.

Manger Construction. The Manger, comprising the outside, the ends and the divisions are made of No. 18 galvanized sheet steel. The outside is reinforced at the top, and the ends and the divisions, are joined to the outside by $1 \times 1 \times \frac{1}{2}$ steel angles. The lower edge of the outside and the upper and lower and inner edges of the ends and divisions are reinforced by $\frac{1}{4}$ x 1 inch spot-welded steel strips. The standard dimensions of Manger are 25 inches out from panel at top, 16 inches out at bottom, 18 inches high and 2 feet wide.

The Stationary Shields are made of No. 18-gauge sheet steel, reinforced with $\frac{3}{16}$ x 1 inch spot-welded steel strips. They are 24 inches long and 20 inches wide at bottom.

Weights. Plain panels, per lineal foot, 15 lbs. Stanchion panels, per lineal foot, 16 lbs. Gate with hinges, 58 lbs. Arch-rail and gate posts above panel, $38\frac{1}{2}$ lbs. Manger, two compartments in section, $87\frac{1}{2}$ lbs.; three compartments in section, 124 lbs.; four in section, $154\frac{1}{2}$ lbs.; five in section, 181 lbs.; Stationary Shields with clamps, each 11 lbs.

Windom, Minn. June 6, 1916

Louden Machinery Co.,

St. Paul, Minn.

Gentlemen:

All of the barn equipment which I purchased from you has given the very best of satisfaction. I heartily recommend your goods to any farmer wishing to equip a barn up-to-date.

Yours truly,

Delbert U. Welch.

LOUDEN STEEL PENS
Keep the Animals Clean,
Healthy, and Contented, and
Protect Them From Injury.

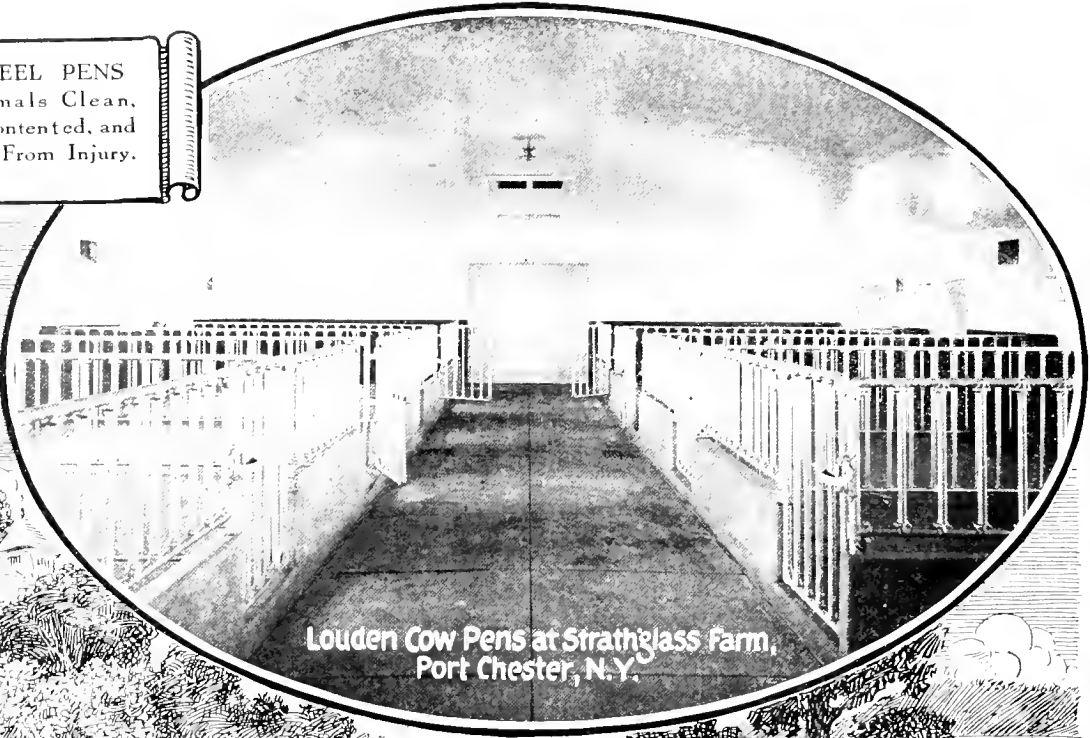

Louden Cow Pens at Strathglass Farm,
Port Chester, N.Y.

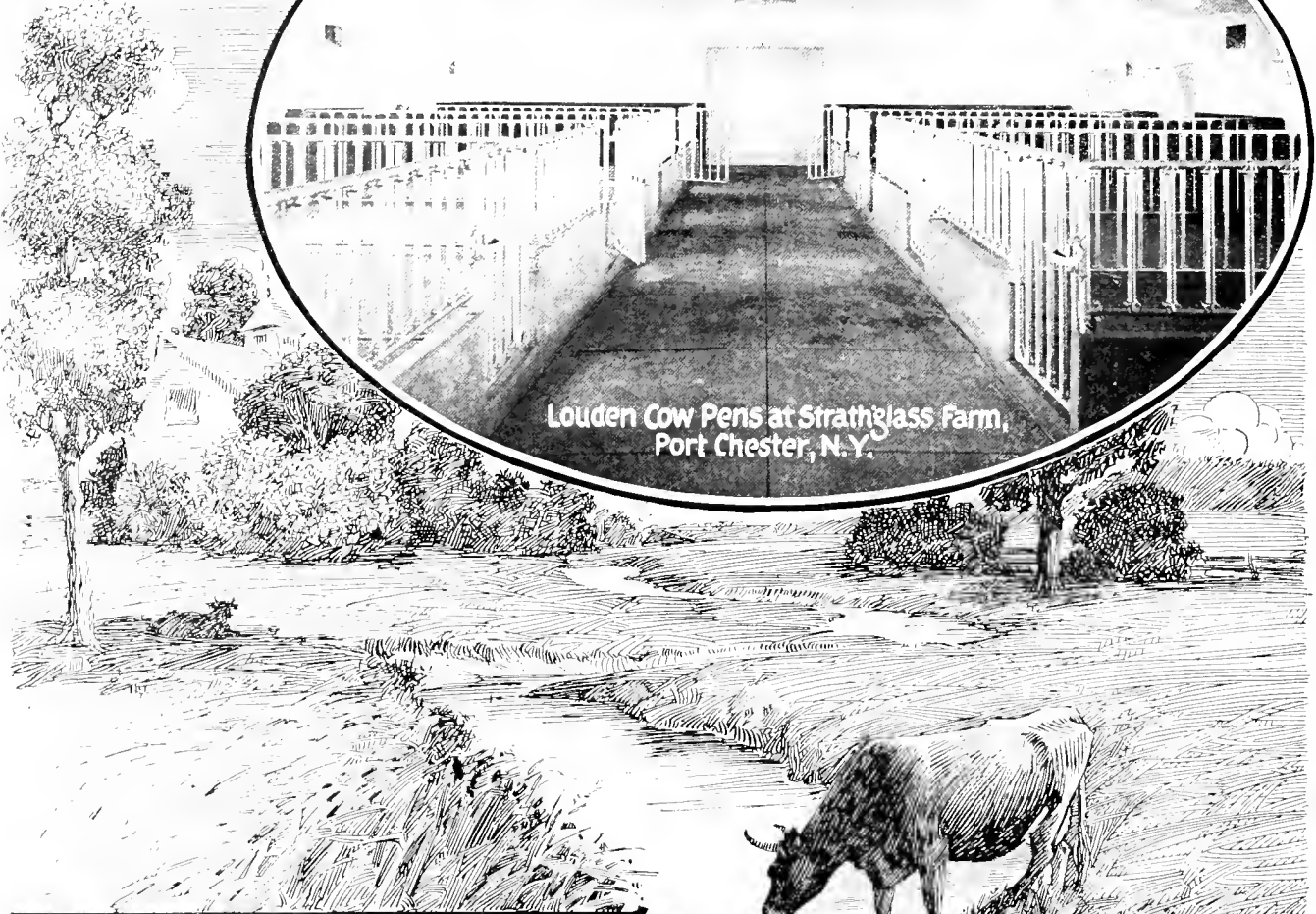

W.S. Moscrop's Prize Bull,
Lake Elm, Minn.

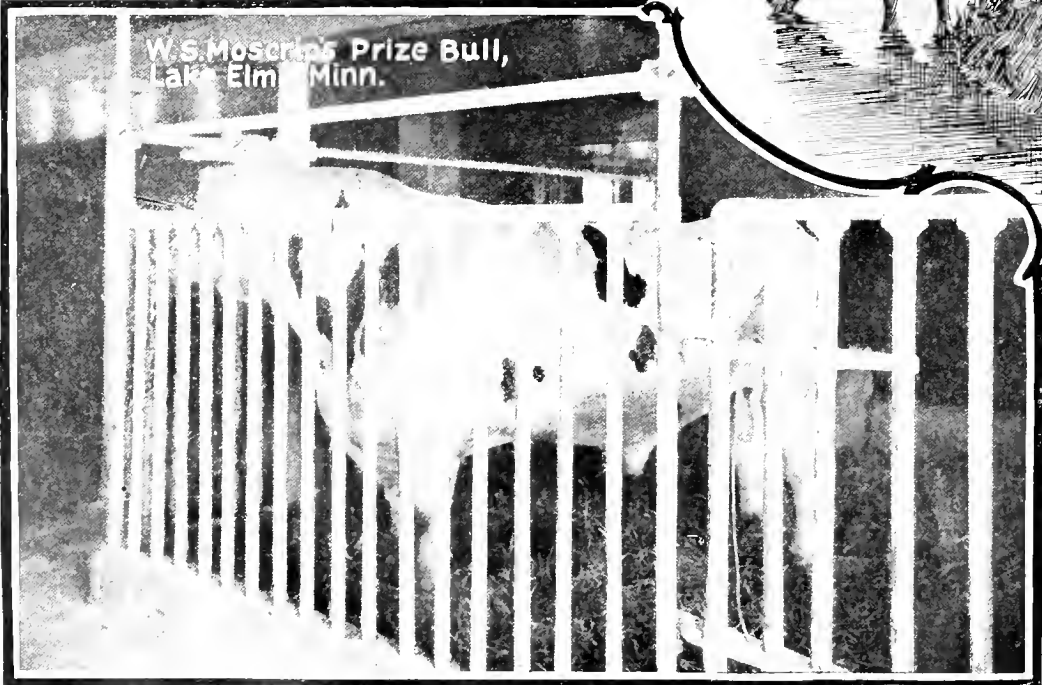

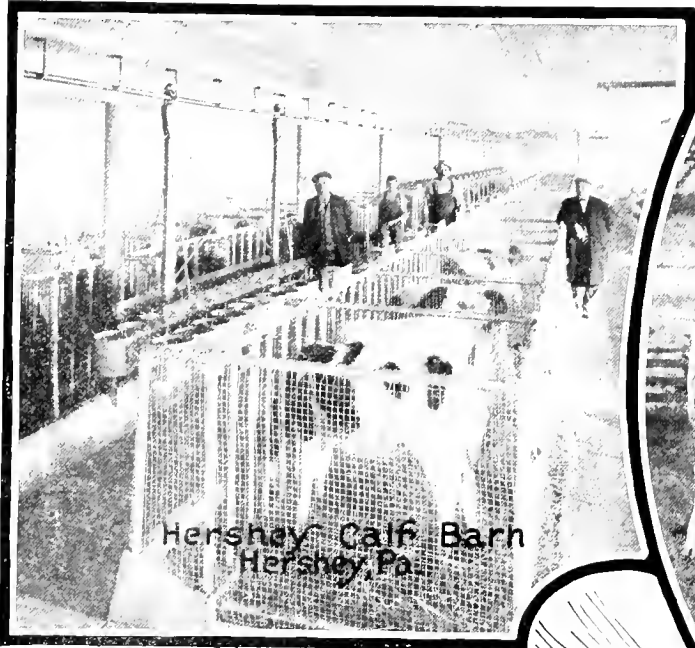

**SOME LOUDEN EQUIPPED
CALF BARN**

The Babies of the Herd, Like Human
Babies, Should Have a Right Start.

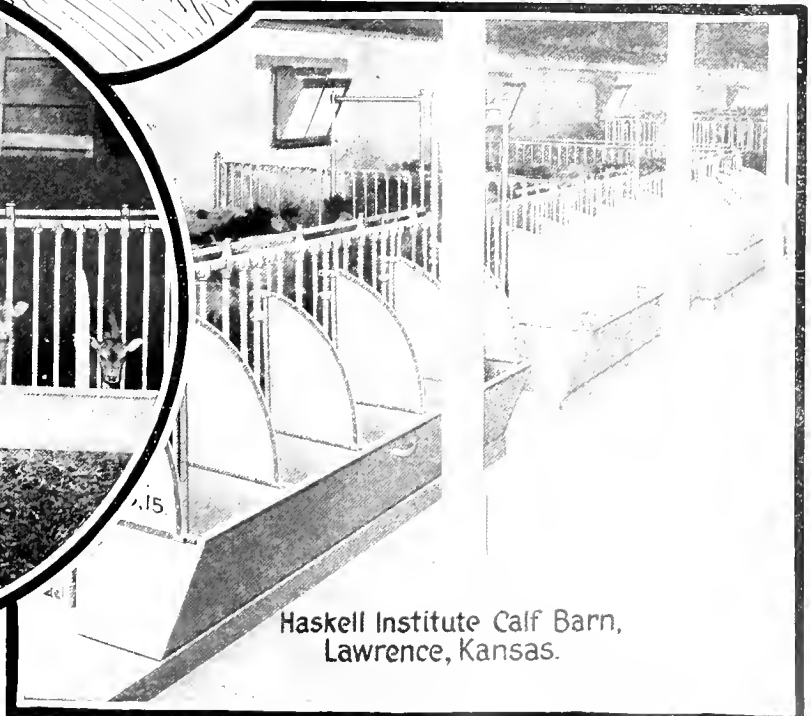
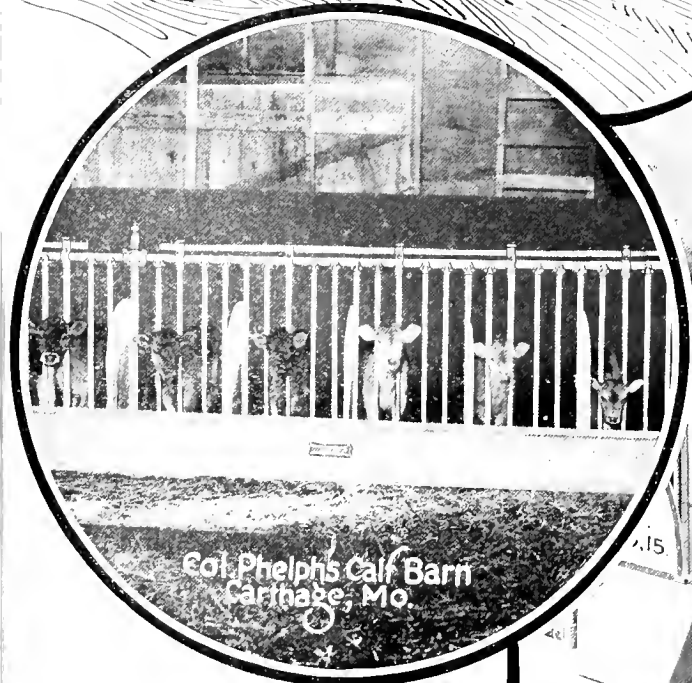

Corner Couplings Patented Aug. 17, 1915.
Tilting Manger Patented Jan. 25, 1916.

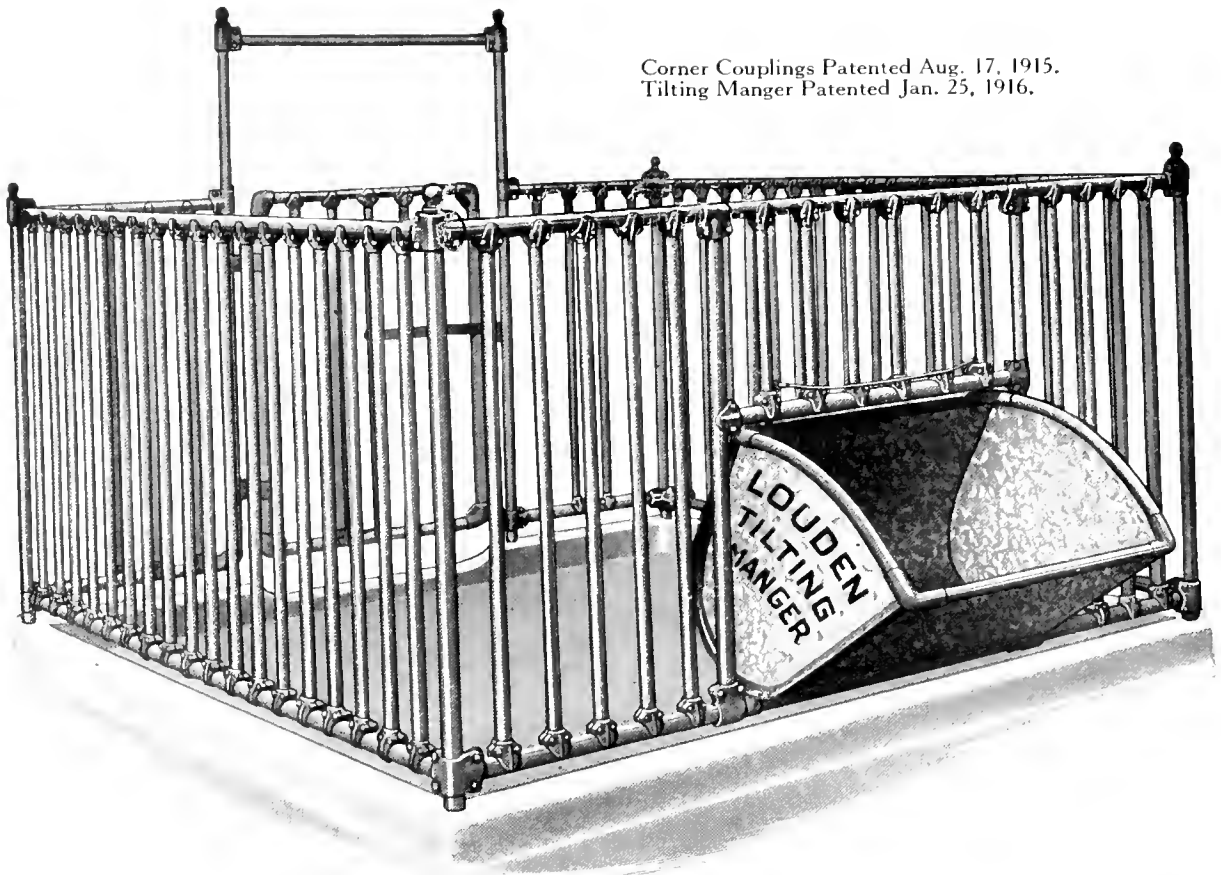

Louden Maternity Pen, Panel Construction—Fig. 996

Specifications

Size of Tubing. The corner and gate posts, the posts and rails adjoining the manger and the top and bottom rails (when the latter is used), as well as the gate frame, are $1\frac{5}{8}$ O. D. steel tubing. All the fillers, including those for the gate, are $1\frac{5}{16}$ steel tubing.

Length of Tubing. All the posts are set 5 inches in the concrete below the level of the floor. The corner posts are 5 feet long; the gate post 6 feet 9 inches long. The length of the main fillers for the curb construction is 57 inches, and for the panel construction, 44 inches. The fillers above the manger, $15\frac{1}{2}$ inches. The standard height of panel is 54 inches above the floor. The gate is 40 inches wide in the clear.

Connections. The horizontal rails are connected to the corner posts by our Corner Couplings, N-6, Plate 15. The horizontal rails are connected to the gate posts and the manger posts by our Interlocking Dust-Proof Couplings, Fig. 933. The fillers are set approximately 5 inches apart on centers and are connected to the horizontal rails with our Grip Clamps, Fig. 1050.

Dimensions of Manger. The Manger is 36 inches long and 28 inches wide at the top and 28 inches deep. The bottom is rounded on a radius of 9 inches. It is made of

18-gauge galvanized sheet steel, reinforced by steel angles on the ends and outside, and by a slotted $1\frac{5}{16}$ O. D. tube on the inside next the cow.

Other Features. The pen may be placed against a wall or in a corner of the building so the wall or walls will form one or two sides of the pen. A 4-inch concrete curb should be built under the panel to prevent bedding from being pushed out of the pen. The corner and gate posts are fitted with ornamental knobs.

Weights. Sides of pen, curb construction, per lineal foot, 22 lbs.; same, panel construction, 21 lbs.; Manger panel, with lower, rail $47\frac{1}{2}$ lbs. Gate, with hinges and latch, 84 lbs. Arch-rail and gate posts above panel, 40 lbs. Manger crated, 95 lbs.

Eau Claire, Wis. Dec. 13, 1915

The Louden Machinery Co.,
St. Paul, Minn.

Gentlemen:

Your goods were satisfactory in every way and you can feel free to refer any prospective buyer to me for an indorsement of your barn equipment.

Very truly yours, Dr. E. L. Mason.

Manger Handles

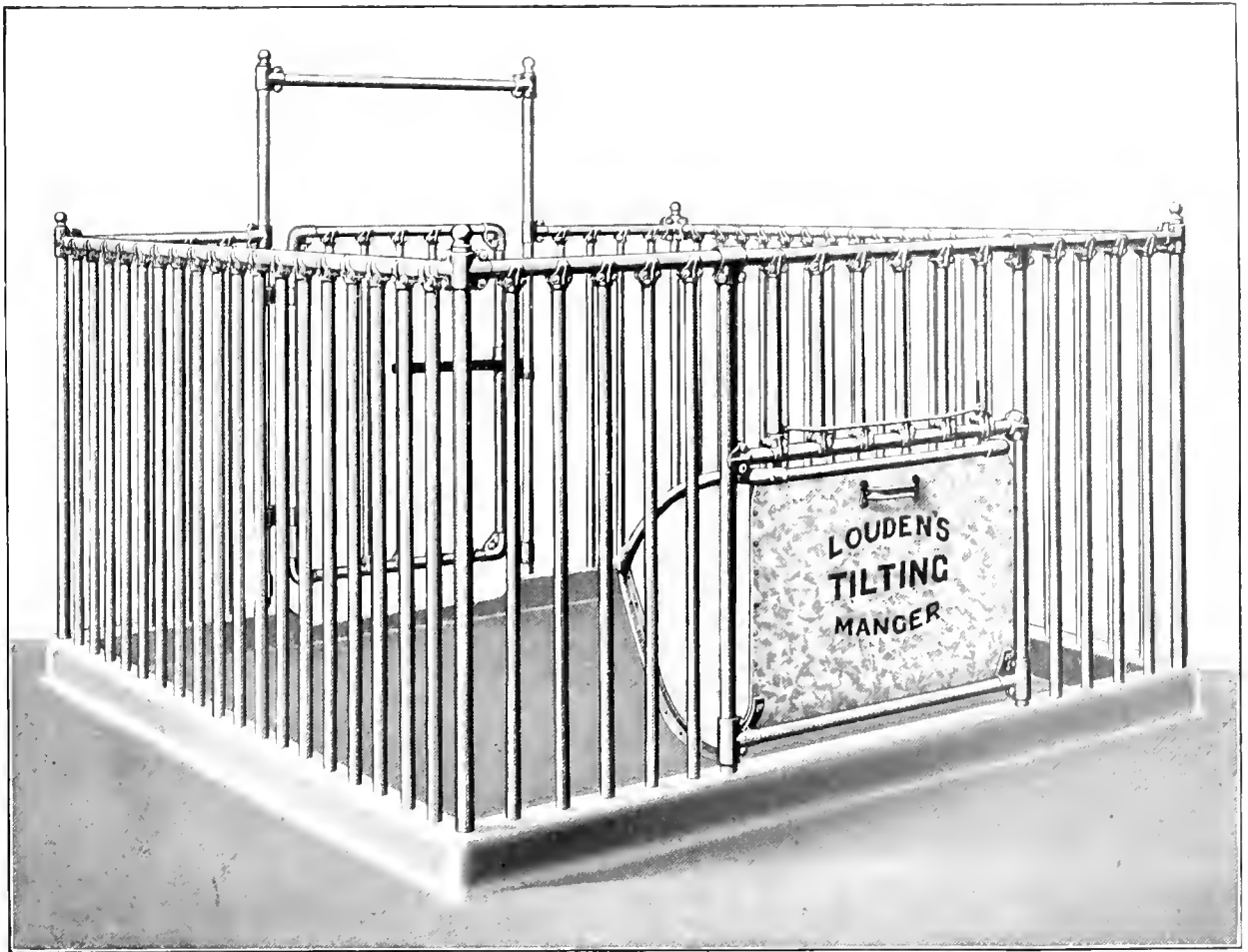

Fig. 1195



Fig. 1196

Fig. 1195 is our Malleable Iron Manger Handle and Fig. 1196 is a Handle made of $1\frac{5}{16}$ O. D. tubing. These handles are large and strong and are suitable for many purposes.



Louden Maternity Pen, Curb Construction—Fig. 995

Many cows have been injured and calves lost for the lack of suitable quarters in calving. The Louden Maternity Pen has been designed to supply this want and to save this loss to the dairy farmer. That it "fills the bill" in the most satisfactory manner is the verdict of all who have used it. It is so simple and will be so easily understood that any extended description is hardly necessary.

Suffice to say that it is composed of tubular steel uprights with corner posts set in a concrete curb and held at the upper ends on a tubular steel top-rail by means of our dust-proof malleable iron connections. It is provided with a **tubular steel gate** hung to the gate post by our **adjustable center pivot hinges**, and is held in closed position by one of our **safety hold-shut latches**, elsewhere described. The gate posts are extended above the top of the pen and are connected together by a tubular steel arch-rail.

It is also provided with a galvanized feed manger set on a pivot so it can be tilted in for feeding and tilted out for filling or cleaning, being held in either position by drop-pins mounted in the frame of the pen above the manger. By lifting these drop-pins the manger may be tilted out until it rests on the floor, where it will be easily washed or disinfected. The upper edge of the manger next the cow is bound with a slotted tube to make a round edge and thus avoid sharp corners to injure the cow's neck.

The Louden Maternity Pen may be constructed in two ways. 1st, by inserting the fillers as well as the posts in the concrete curb as shown by Fig. 995; and 2d, by connecting them to a bottom rail, as shown by Fig. 996. The former is much the best way as well as cheaper. It is considerably stronger and is more easily kept clean.

Two or more Louden Maternity Pens are a necessity in any dairy barn. They are ideal as hospitals during sickness in the herd. Besides, there is a **simple artistic beauty** about the Louden pens that helps to set off the appearance of the stock to the best advantage. Many breeders say they are a good investment for this feature alone.

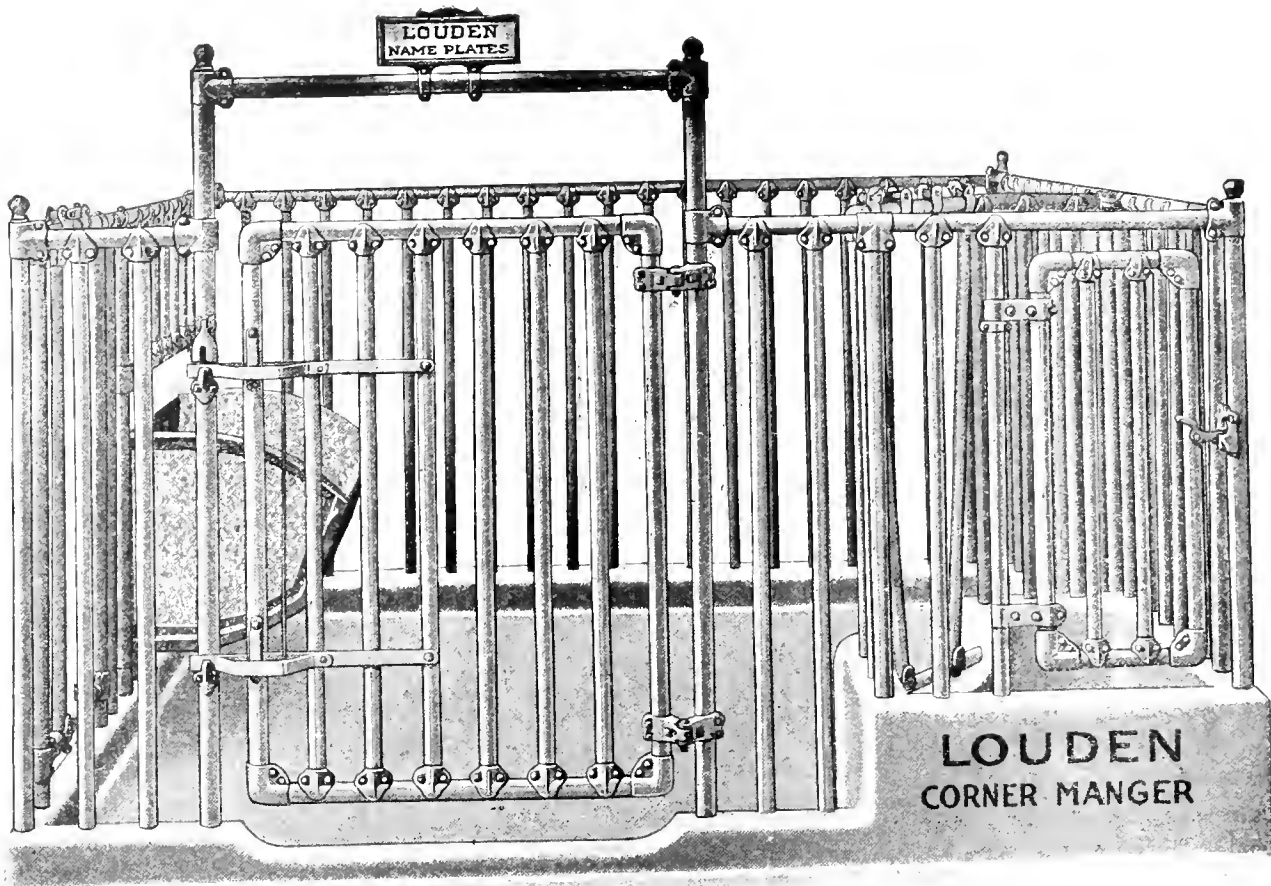

Louden Tubular Steel Bull Pen—Fig. 1164

Specifications

Size of Tubing. The corner posts of the pen and the manger, the posts and frame of the large gate, the top-rails of the pen and manger, the stanchion bars and the arch of the gate are all made of $1\frac{7}{8}$ O. D. steel tubing. The fillers of the pen and large gate, and the frame of the manger gate are of $1\frac{5}{8}$ O. D. steel tubing. The fillers of the manger gate are of $1\frac{1}{16}$ steel tubing.

Length of Tubing. The height of the pen above the floor is 5 feet 3 inches. The tubing goes 10 inches into the cement (6 inches in the curb and 4 inches into the floor) making all the posts and main fillers 5 feet 5 inches long, except the large gate posts which are 6 feet 7 inches long.

Size of Gates. The standard size of the Main Gate is 56 inches high and 41 inches wide, out to out. The gate opening is 4 feet wide, center to center of gate posts. The manger gate (or feed gate, as it is sometimes called), is 41 inches high and $16\frac{1}{2}$ inches wide, out to out.

Connections. The top-rails including the curved top-rail of the manger, are connected to the corner posts by our corner couplings (see N-6, Plate 15, page 136). The top-rails are

"A bull in a china shop" is not more to be dreaded than a bull "broke loose" in the barn yard. His giant strength will be sure to manifest itself in a way that will not be pleasant and may be dangerous. No matter how gentle a bull may seem you never can tell what may happen to arouse him to deeds of violence. Therefore, it is not safe to take chances in using a stanchion to hold a bull the same as a cow. A Louden Bull Pen should be used.

connected to the large gate posts by our Interlocking Dust-Proof Couplings (Fig. 933). The fillers are set approximately 6 inches apart and are connected to the top-rails by our Grip Clamps, Fig. 1050.

Size of Pens. The pens should be 10 to 12 feet square to give the bull sufficient freedom. It may be built against the wall or in a corner of the building in which case one or two of the sides will not be required, but wall flanges will be needed to join the top-rails to the wall.

Size of Mangers. The size of the Corner Manger has already been given. The size of the Tilting Manger is 39 inches long, 36 inches deep on the outside and 30 inches wide. It tilts into the pen 25 inches and out into the alley 22 inches. The stanchion bar can be adjusted wide enough apart for the largest bull and close enough together to hold a calf.

Approximate Weights. The material for the sides of the pen weighs $29\frac{1}{2}$ lbs. per foot. The standard size of gate with posts and arch rail, and the hinges and latches complete, weighs 177 lbs. The gate, with latches only, weighs 118 lbs. The tubing and fittings for the corner manger with stanchion complete weighs from $123\frac{1}{2}$ to 126 lbs., according to size. The tilting manger, crated, weighs 159 lbs.

Louden Tubular Steel Bull Pen Continued

In the Louden Bull Pen, "safety is first"—safety for the herd, safety for the bull and safety for human life. In its construction the best quality of heavy steel tubing is used—the lower ends set firmly in solid cement and the upper ends held securely together by the Louden Malleable Iron Connections described in this catalog. It is provided with a heavy bull-proof gate made of the same material and held shut by a pair of bull-proof latches, both of which have to be lifted out of the catches before the gate will open.

Fig. 1164 represents a Louden Bull Pen fitted with **two mangers**—a **tilting manger** made of wood with galvanized steel ends and the **Louden Corner Manger** made of concrete protected by bars of tubular steel. It will be understood, of course, that two mangers are not to be used at the same time, and the two are shown here to better enable the purchaser to decide which kind to use. The tilting manger is made of 2-inch planks securely held together by heavy steel angles secured to edges of the galvanized steel ends. It is mounted on a pivot bar set in one side of the pen so it may be easily tilted in for feeding, as shown in the cut, or tilted out for filling and cleaning.

The Louden Corner Manger is a new departure and we believe it is the best manger ever devised for a bull pen. It is **all inside** of the pen instead of being mounted in one of the sides where it will be out in the alley a part of the time. There is nothing loose for the bull to play with and keep up an incessant racket. It is stronger and more durable and is more easily kept clean than a wooden manger. It takes less room because it occupies only one of the corners instead of projecting into a central part of the pen.

Louden Bull Pen with Corner Manger

Bull Pen Stanchion Patented Dec. 7, 1915, and July 25, 1916

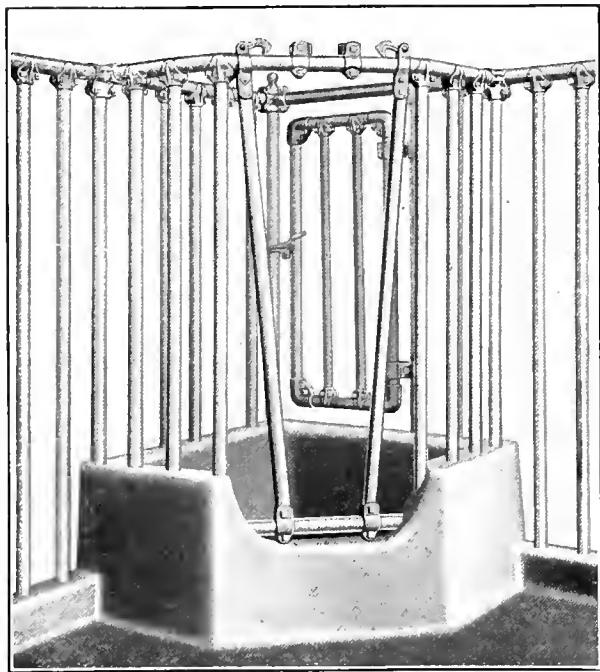

Fig. 1165

engage catches clamped on the top-rail, so as to hold the stanchion bars securely in closed position. The hinges below and the catches above can be **adjusted on the rails** so as to set the stanchion bars wider apart or closer together to suit bulls having different sizes of necks from the largest to the smallest. The latches are protected by guards so it is impossible for the bull to open them with his horns.

The manger gate is placed on the side of the pen next the alley for convenience in placing feed or a bucket of water in the manger, or for cleaning it while the bull is in the pen. The bull can be shut out from the manger by closing the stanchion bars. The latches of the stanchion can be easily reached from the outside of the pen. In every way it is convenient and easily managed. The corner manger also makes the pen stronger, while a tilting manger set in one of the sides tends to make it weaker.

Some one has said that the phrase "Sunny Disposition" was coined by a dairyman who observed the contentment of his bull in a clean, light, well-ventilated **Louden Bull Pen** after seeing another bull in

Bull Pen with Corner Manger — Cont'd

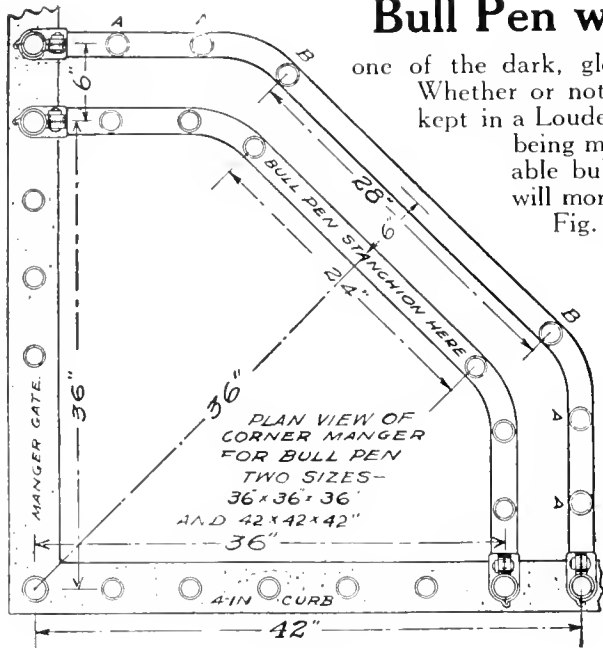

Fig. 1166

one of the dark, gloomy, foul places where bulls are sometimes kept. Whether or not this is correct, no one can doubt the fact that a bull kept in a Louden Pen will be always in the best condition and besides being more contented he will be a healthier and a more profitable bull, and that in addition to this, the element of safety, will more than pay for the pen.

Fig. 1166 is a top or plan view of the Curved Top-Rail used in the Louden Corner Manger. Also, a plan view of the outside curb of the manger, showing the location of the posts and fillers and the manger gate. The cut shows two sizes — 36x36x36 inches for medium and smaller size bulls, and 42x42x42 inches for larger bulls. The bottom of the manger should be 1 to 2 inches above the level of the floor of the pen and should be rounded to leave no sharp corners in the mangers. It should also be provided with means for drainage.

Two Other Types Of Bull Pen Mangers

Fig. 1300 and Fig. 1301 show two popular types of open bull pen mangers. Fig. 1300 shows a low manger built on the outside of the pen, 26 inches



Fig. 1301. Showing Regular Corner Manger with Low Railing Outside

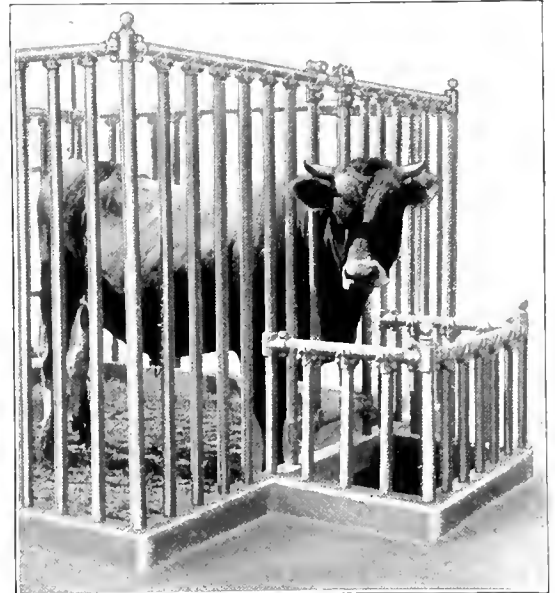

Fig. 1300. Bull Pen with Low Outside Manger

wide, 38 inches long, and 30 inches high, from the floor. Size may be varied if desired.

Fig. 1301 shows our regular corner manger with low outside railing. All measurement are the same as for regular corner manger except height of outside railing, which is 30 inches high from the floor.

Either of these mangers is suitable for a gentle bull, but for a vicious animal the completely enclosed manger is safest.

The open manger gives the animal a little more freedom, is more easily filled, and is cheaper than the enclosed type.

Our regular bull stanchion is used in both the mangers shown.

Louden Tubular Steel Hog Pens—Fig. 1167

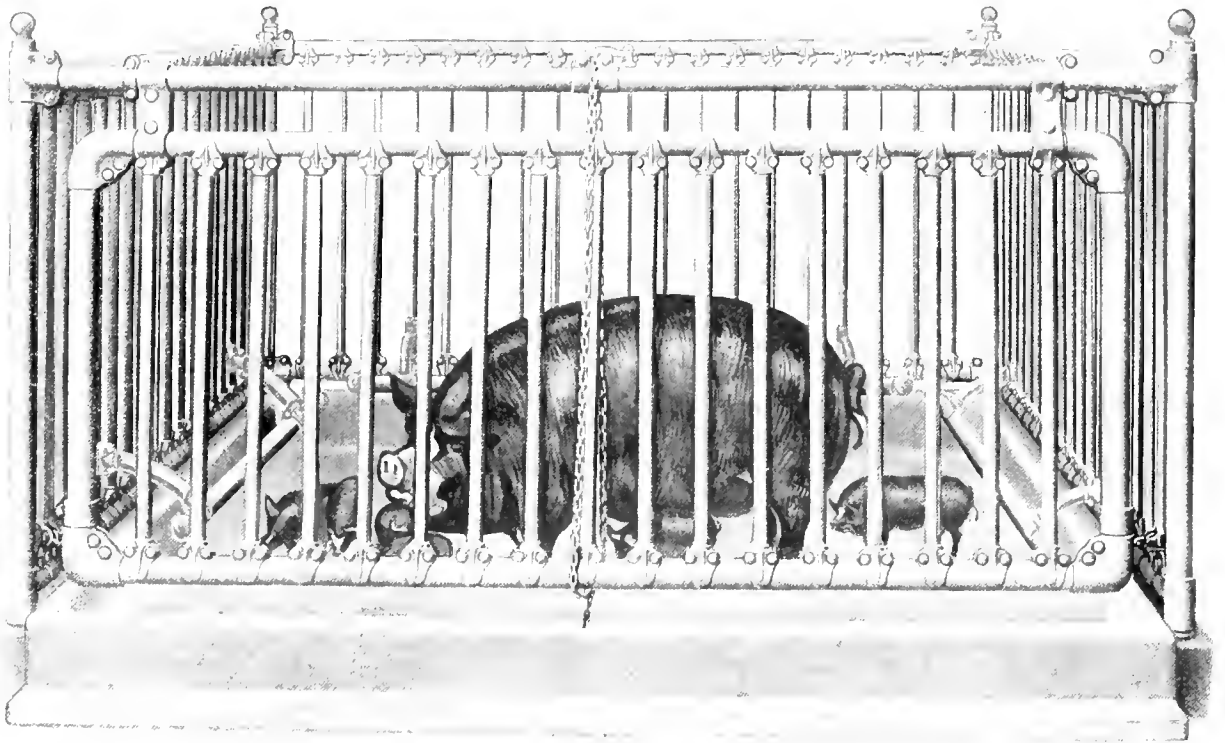

Fig. 1167—Hog Pen With Swinging Section and Concrete Trough

Specifications

Size of Tubing. Corner posts, top and bottom rails, frame of swinging panel, gate posts, guard rails, and uprights to which guard rails are clamped, are made of 1 $\frac{3}{8}$ " O. D. steel tubing. Fillers are made of 1 $\frac{1}{16}$ " O. D. steel tubing.

Length of Tubing. The height of the panel above the floor is 3'10". Fillers for main panel are 3 feet long. Fillers for swinging panel are 2'6" long. Corner posts are 4'4" long, and should be set 5" in the concrete.

Size of Gate. The standard size of gate is 3'4" high

over all, by 1'11" wide over all. The gate opening is 2'6" wide, center to center of gate posts.

Connections. The top rails are connected to the corner posts by corner couplings. They are connected to the gate posts by interlocking dust-proof couplings. (Fig. 933, page 77.) The fillers are spaced 2 $\frac{1}{2}$, 3, 3 $\frac{1}{2}$, or 4 inches apart on center, as ordered, and are connected to top and bottom rails by grip clamps. Price of panel varies according to spacing of fillers.

There is a rapidly growing demand for the Louden Tubular Steel Hog Pens. Farmers are learning that to make hogs **profitable** they must—like cows—be **kept clean and made comfortable**. The question is whether the hog will have to spend his energy in fighting filth and disease, or, by proper treatment, be free to devote it to the production of fat which the world wants and for which it is willing to pay a good price.

A hog to be profitable **must be a fat producer**, as a profitable cow must be a **milk producer**. The greater fat producer a hog becomes the more tender he will be, the more liable to contract disease and the more care and attention will he require. The "Razor Back" was a healthy hog and needed little or no care, but there was **no profit in him**. This is generally the case with things which do not require care. They do not increase the bank account.

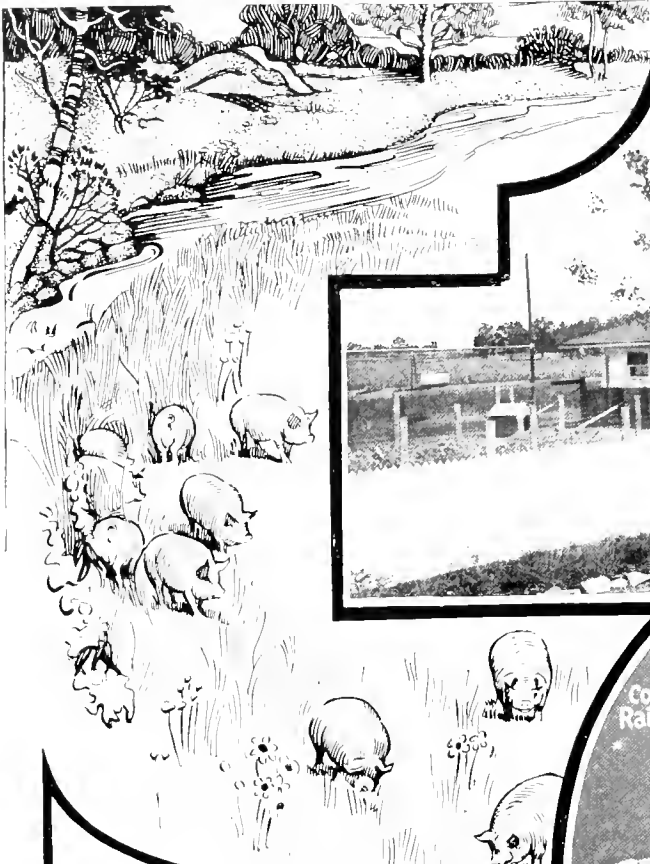

E.E. Lehmann's
Model Hog House
Lake Villa, Ill.



Cork Brick Bed With Steel Guard
Rail in the E.E. Lehmann Hog Barn

**RAISING HOGS
FOR PROFIT**
Three Views of E. E.
Lehmann's Loudon
Planned and Equipped
Hog House, Lake Villa,
Illinois.



Interior view of
E.E. Lehmann's Hog Barn



Louden Tubular Steel Hog Pens—Continued

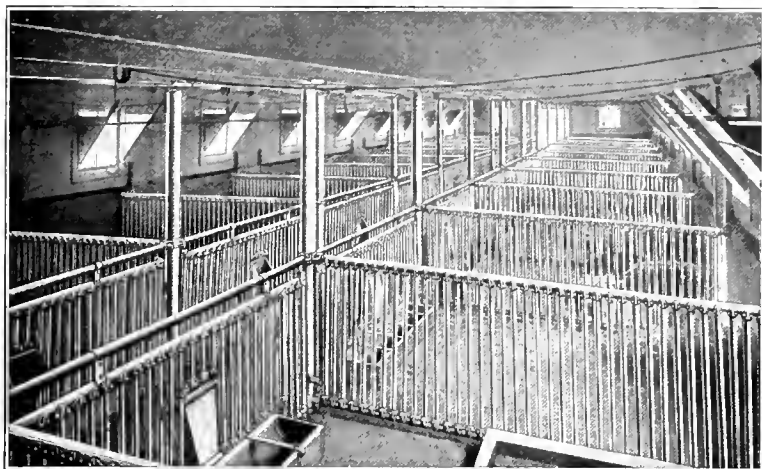

Hog House on Homewood Farms, Moline, Ill.—Louden Equipped hog houses in this country. It is fitted throughout with the Louden Tubular Steel Hog Pens. It is kept so clean and is so well ventilated that it is entirely free from the disagreeable odor common to hog pens.

If we will stop to consider we will find that the hog has been outrageously abused in many ways which it is not necessary to recount here. The hog is not irrevocably a filthy animal. It is largely the way he has had to live that has made him filthy. The fattening process is more or less a heating process, and the hog goes into the mud hole to cool the fever in his blood. The hog needs clean comfortable quarters and this can be secured by using the Louden Tubular Steel Hog Pens, set in a concrete floor, and supplied with plenty of pure water to keep him clean.

The illustration to the left shows a section of the Hog House on the Homewood Farms near Moline, Ill.—Owned by Wm. Butterworth, President of Deere & Co. This is one of the finest

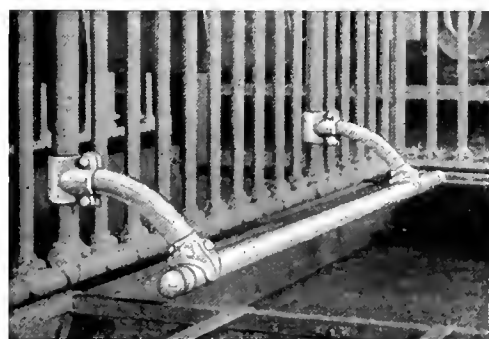

Fig. 1286. Panel With Guard Rail.

Fig. 1167 shows one of the Louden Pens fitted with a swinging panel set over a trough so that the panel can be swung either to the inside or to the outside of the trough and be locked in either position. The object is to swing the panel in to keep the hogs out of the trough while filling it and then swing the panel out to give the hogs the entire width of the trough while they are eating.

Fig. 1168 is a sectional view of the arrangement. The panel is hinged to the top-rail of the pen and is held in position by a chain, C, which is passed over the top-rail

and under the lower rail of the swinging panel, and is then fastened to opposite sides of the trough. The chain is passed through a locking piece, L, which is slidably mounted on the top-rail. This locking piece has an opening in its center large enough for the chain to pass through and let the panel swing to the sides as far as the dotted lines in Fig. 1168.

The ends of the locking piece have narrow slots and when slid to either one side or the other it will catch the links of the chain and will hold it in locked position. The arrangement is extremely simple and it is easily operated. It is also strong and reliable in its operation. Fig. 1168 shows a concrete trough.

The pens in which brood sows are housed should be provided with strong guard rails along each side to prevent the sows from lying on the young pigs.

The Louden Guard Rails are made of 1½ inch steel tubing, supported by short curved pieces of the same material clamped to extra heavy uprights in the panel. They are strong, durable, and ornamental. Fig. 1286 shows a section of a pen fitted with guard rails.

Our Tubular Steel Pens are also well suited for sheep and we are supplying them for this purpose. We are prepared to equip either hog houses or sheep houses, large or small, with pens to suit requirements, and will be pleased to furnish further information or mail blue prints showing different installments.

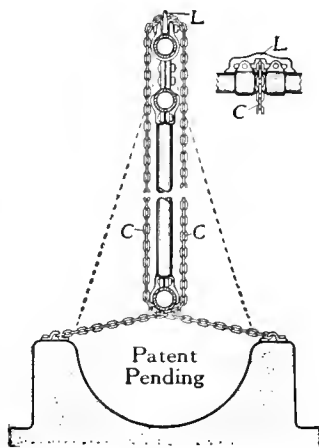

Fig. 1168

Louden Tubular Steel Gates

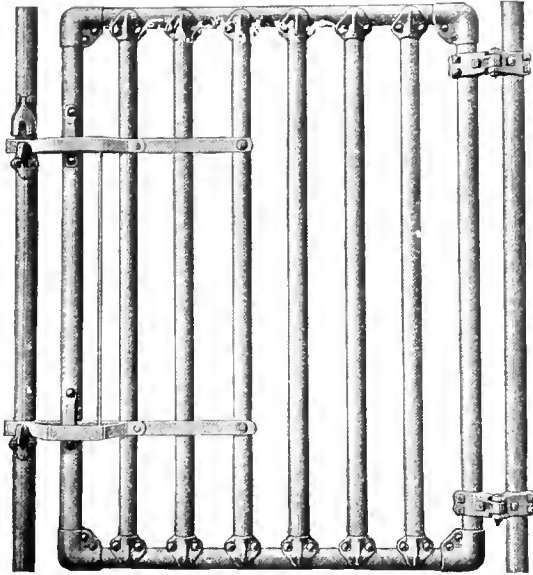

Fig. 1169

Fig. 1169 is the Louden Heavy Tubular Steel Gate with patent Adjustable Center Pivot Hinges and heavy Hold-Shut Twin Latches, suitable for bull pens and other places requiring great strength. Fig. 1170 is the Louden Standard Tubular Steel Gate with Adjustable

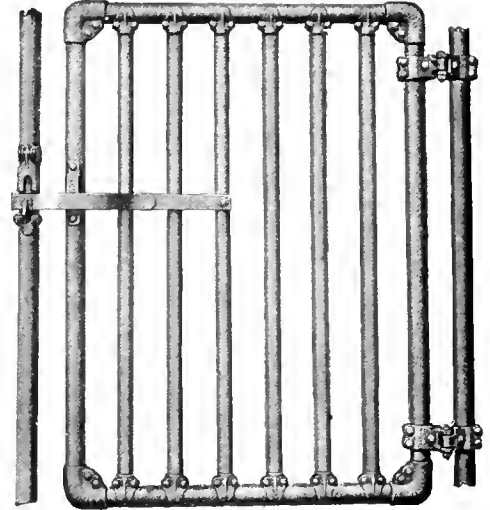

Fig. 1170

Center Pivot Hinges and a Single Hold-Shut Latch, suitable for maternity pens, calf pens and similar uses. These

gates are made of the best quality of steel tubing. For strength and durability as well as neatness, convenience and cleanliness, these gates have no equal.

Specifications

Sizes of Tubing. The frame of the Bull Pen Gate is made of $1\frac{7}{8}$ and the fillers of $1\frac{5}{8}$ O. D. steel tubing. The frame of the maternity pen gate is made of $1\frac{5}{8}$ and the fillers of $1\frac{5}{8}$ O. D. steel tubing. The frame of the calf pen gate is made of $1\frac{5}{8}$ and the fillers of $1\frac{1}{8}$ O. D. steel tubing.

Dimensions. The standard size of Bull Pen Gate is 3 feet 5 inches wide and 4 feet 8 inches high; Maternity Pen Gate, 2 feet 11 inches wide and 4 feet high, and Calf Pen Gate, 2 feet 5 inches wide and 3 feet 4 inches high. All measurements are from out to out of frame.

Hinges and Latches. The Hinges described on another page, will be furnished in the heavy size for the bull pen gates and in the standard size for the maternity and calf pen gates. The Latches for the bull pen gate are made of $\frac{5}{16} \times 1\frac{3}{8}$ steel bars doubled back as shown in the cut. For the maternity and calf pens the Latch is made of $\frac{3}{4} \times 1\frac{1}{4}$ steel bar, doubled back the same way.

Weight. The standard Bull Pen Gate complete with hinges, latches and hold-shut catches, weighs 128 lbs.; Gate for maternity pen with hinges, latch and catch, weighs 84 lbs.; Gate for calf pen, with same fittings, weighs 58 lbs.

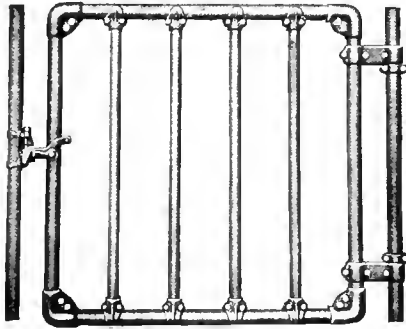

Fig. 1171

Louden Improved Alley Gate

Fig. 1171 is the Louden Improved Alley Gate with vertical fillers and a latch that will slam shut from either side and never swing past. This latch is absolutely stock-proof. No cow or horse can by any possibility open it. It is furnished with hinges which will swing both ways.

Specifications

The Standard Sizes of Alley Gates are 3 ft. 4 in. high and 2 feet 11 inches, 3 feet 5 inches, and 3 feet 11 inches wide, out to out. These sizes are suitable for alleys $3\frac{1}{2}$, 4 and $4\frac{1}{2}$ feet wide in the clear. Other sizes will be made to order.

Sizes of Tubing. The frames are made of $1\frac{5}{8}$ O. D. tubing and the fillers are $1\frac{5}{8}$ O. D. tubing. The fillers are spaced on centers 8 to 9 inches apart.

Weights. With latch and hinges and two collars, which go with the gate, the 2-foot 11-inch size weighs 57 lbs.; 3-foot 5-inch size, 65 lbs., and 3-foot 11-inch size, 73 lbs.

In ordering be sure to specify the outside diameter of posts. If different sizes are used, give size to which the gate is hinged and also size of post to which the latch is connected. If square posts are used so state in order.

Red Lake Falls, Minn., July 3, 1916.
Louden Machinery Co., St. Paul, Minn.

Gentlemen:
Your equipment that I put in my new barn has proved very satisfactory and my foreman is well pleased with it.

Yours truly, J. A. Duffy.

Louden Adjustable Center-Pivot Gate Hinges

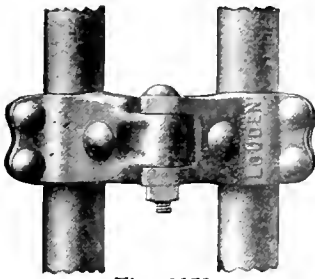

Fig. 1172

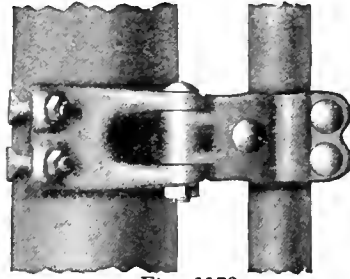

Fig. 1173 Pat'd Jan. 18, 1916.

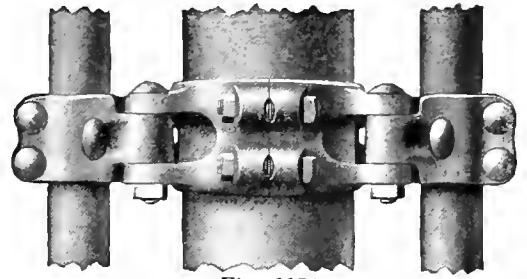

Fig. 1174

The above are views showing three different ways of using the Louden Adjustable Center-Pivot Gate Hinge. Fig. 1172 shows the use of the hinge with $1\frac{3}{8}$ or $1\frac{7}{8}$ O. D. tubing. Fig. 1173 shows the hinge attached to a large post or column, and Fig. 1174 shows a double hinge attached to a large post or column to hang a gate on each side of the column. For $1\frac{3}{8}$ or $1\frac{7}{8}$ O.D. tubing, four pieces of malleable castings are used which are rigidly clamped to the tubing by six heavy bolts.

The hinges can be clamped to the posts at different angles as shown by Figs. 1175 and 1176, to vary the distance between the gate frame and the post to which it is hinged, to suit requirements. This is an important feature. If the space between the gate posts should happen to be a little too wide or too narrow an adjustment of $2\frac{1}{2}$ inches can be made in setting the hinges, so the latch on the gate and the catch on the post will always be correctly adjusted.

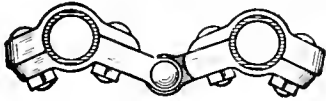

Fig. 1175

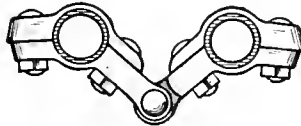

Fig. 1176

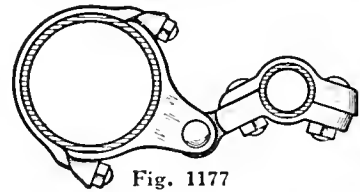

Fig. 1177

These figures are sectional views showing the adjustment of the hinges. Fig. 1175 shows the hinge extended or widened and Fig. 1176 shows it contracted or narrowed. Fig. 1177 shows the attachment to a large post by means of clip bolts which can also be adjusted as explained. (See Plate 16, page 138.) When a gate is hinged on each side of a large post, as shown by Fig. 1174, the hinge castings for the large post is bolted together as shown, and by using longer bolts on one side and shorter bolts on the other side, the castings may be adjusted on the post. The center pivot permits these adjustments and also **offsets** the hinge so the gate can be opened clear back against the panel of the pen which is another important feature not possessed by other kinds of hinges. Of all other gate hinges for tubular posts or columns, none are so strong or so convenient in use, or have the desirable adjusting features of the Louden Hinge.



Fig. 1178
Patented May 16, 1916

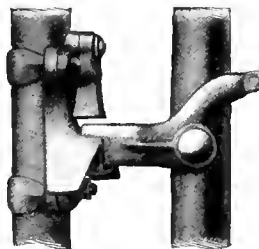

Fig. 1179
Pat'd April 18, 1916

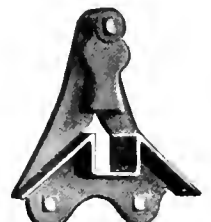
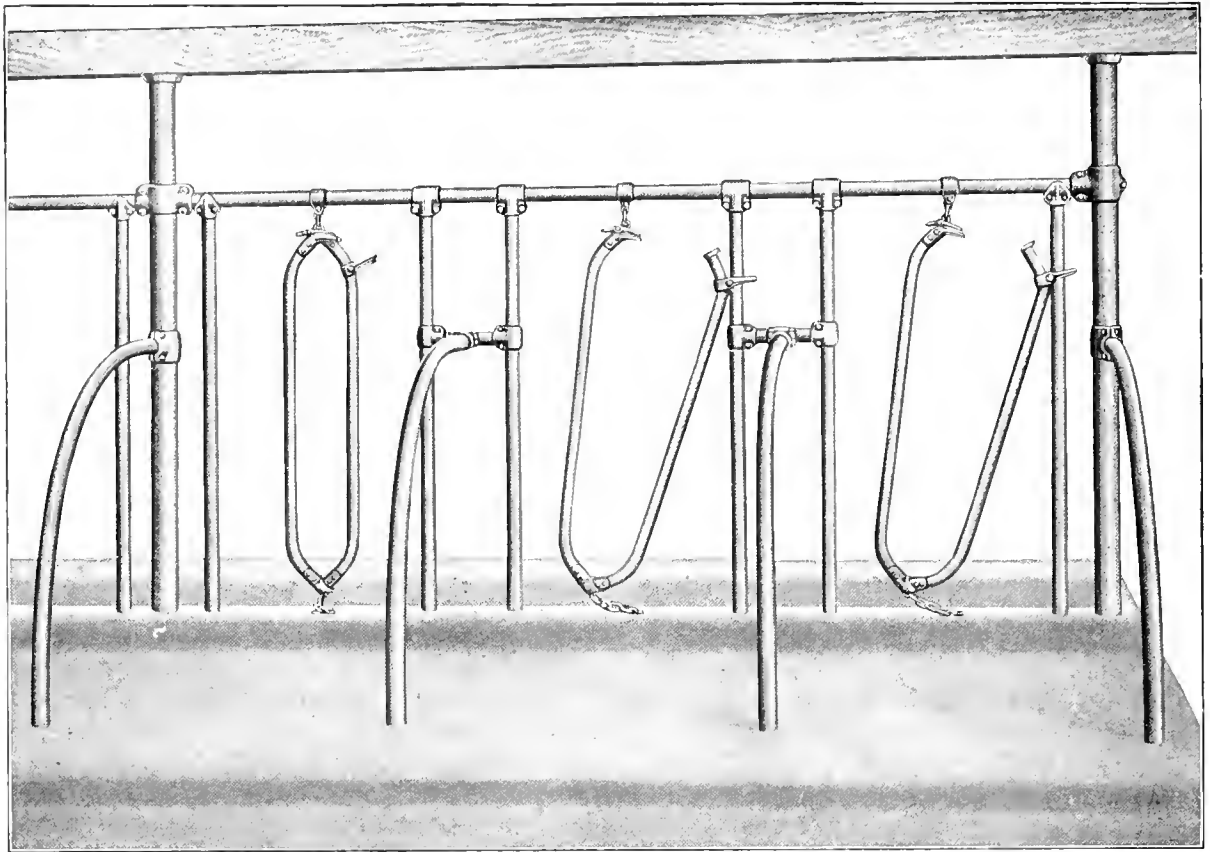

Fig. 1180
Patented April 18, 1916

Louden Safety Gate Latches

Fig 1178 is a detailed view of the Louden One-Way Safety Gate Latch used on our animal pens. It is provided with a Latch Guard which swings out over the latch as soon as it drops into the catch and prevents it from being lifted out of the catch until the keeper is pushed back out of the way. No animal can open the latch when it has this Latch Guard. Fig. 1179 is a detailed view of our Two-Way Safety Latch for alley gates which swing in both directions. The Latch Guard is pivoted above the notch and will swing to one side or the other enough to allow the latch to slide up the catch from either side and drop into the notch, but not enough to permit it to pass clear through. To unlatch the gate in either direction the keeper is pushed to the other side. Fig. 1180 is a Two-Way Safety Catch for a square wooden post or a wall.



Louden 812 Stalls with Column to Ceiling -- Fig. 934

Fig. 934 shows how the Louden Stalls may be connected to large posts or supporting columns in the barn. All that is necessary is to make the stalls the required width to fill the spaces between the columns, cut the top-rail to suit and use the proper size and style of clamps to make the necessary connections. The cut shows a combination of our 810 and 812 Stalls. If the stalls are narrow the side posts adjacent to the columns will be left off. If preferred, or if the columns do not come right to connect the stall partitions to them, the columns may be used in place of one of the 812 Double Posts. It is much better to have the stall posts in perfect line with the columns than to have the columns set either in the manger or on the stall floor.

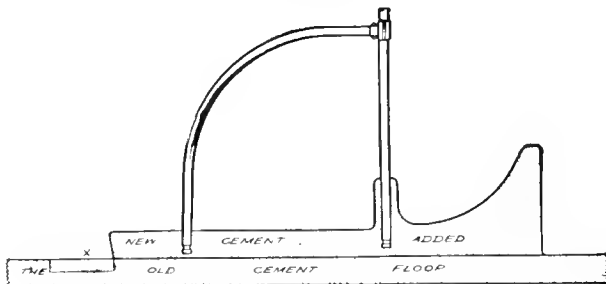

Fig. 1183

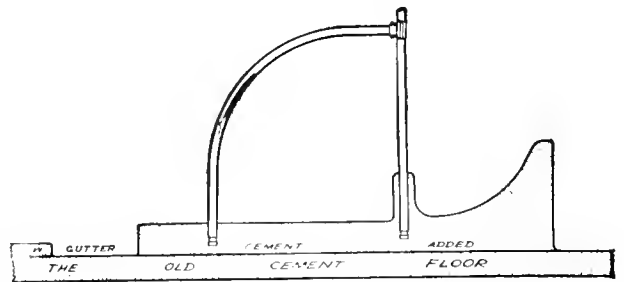
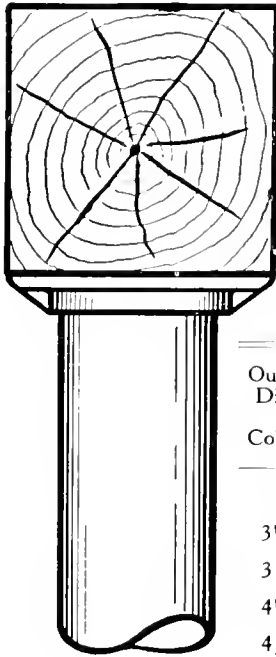

Fig. 1184

The Louden Stalls can be readily set up on floors that are already in without tearing out the old floors. Figs. 1183 and 1184 show the most approved plans. In Fig. 1183 a layer of new cement 6 inches thick is used for the stall floor and 2 or 3 inches is cut out of the old floor at "X" for the gutter.

In Fig. 1184 the layer of cement for the stall floor should be 8 or 9 inches thick. In this plan nothing has to be cut out of the old floor for the gutter. If thought best a layer 2 or 3 inches thick may be added for the litter alley floor which would then be that much higher than the feed alley floor.



Louden Reinforced Building Columns

The Louden Reinforced Building Columns are made of an outer shell or tube of steel compactly filled with concrete. They are the strongest and most durable building columns made. They are especially adapted for supports in farm buildings. Each column is fitted with a suitable metal Cap and Base. Gas pipe columns can be furnished, if desired, at the same prices—See second table.

Carrying Capacity in Tons—Reinforced Columns

Outside Diam. of Column	Weight in lbs. of Plain Col. Shaft per ft.	Length of Column in Feet											
		6'	7'	8'	9'	10'	11'	12'	13'	14'	15'	16'	
		Tons	Tons	Tons	Tons	Tons	Tons	Tons	Tons	Tons	Tons	Tons	
3"	9.64	6	6	5	
3½"	13.09	9	9	8	8	7	
4"	17.02	13	13	12	12	11	10	
4½"	21.05	14	14	13	13	12	11	10	
5"	25.90	20	20	19	19	18	18	17	17	16	
6"	36.82	28	28	27	27	26	26	25	24	23	23	22	

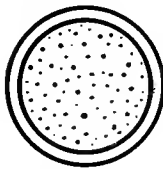

Carrying Capacity in Tons—Gas Pipe Columns

Outside Diam. of Column	Length of Column in Feet											
	6'	7'	8'	9'	10'	11'	12'	13'	14'	16'	18'	20'
3"	12.94	12.27	11.60	10.94	10.27	9.61	8.94	8.27	7.61	6.27
3½"	16.18	15.48	14.78	14.09	13.39	12.69	11.99	11.30	10.60	9.20	7.81	6.41
4"	19.73	19.00	18.27	17.54	16.81	16.07	15.34	14.61	13.88	12.42	10.95	9.49
4½"	23.45	22.69	21.93	21.17	20.40	19.64	18.88	18.11	17.35	15.83	14.30	12.78
5"	27.90	27.10	26.30	25.57	24.71	23.91	23.12	22.32	21.52	19.93	18.34	16.74
6"	37.23	36.36	35.50	34.63	33.77	32.90	32.04	31.17	30.31	28.58	26.85	25.12

In ordering be sure to give outside diameters.

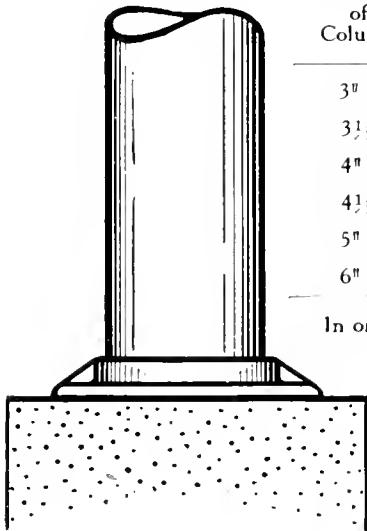
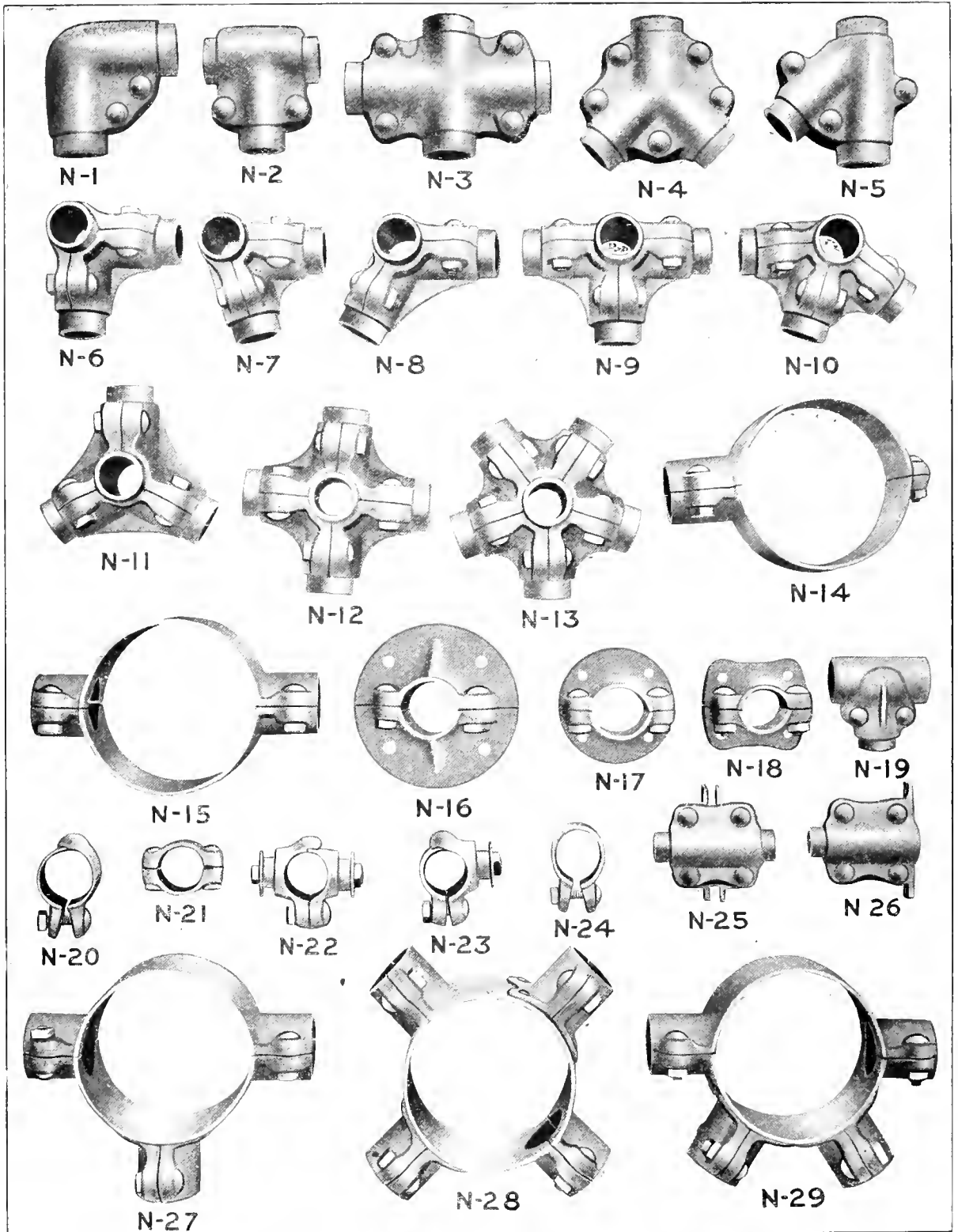

Fig. 1185

The Measurements of Tubing

There are two kinds of measurements used for tubing—the *inside* diameter, or pipe measurement, and the *outside* diameter (O. D.), or structural measurement. The following table gives the O. D. measurement of the different sizes of pipes from ¾-inch to 6-inch:

¾ inch pipe.....	1 1/8 inches, O. D.	3 inch pipe.....	3 1/2 inches, O. D.
1 inch pipe.....	1 1/4 inches, O. D.	3 1/2 inch pipe.....	4 inches, O. D.
1 1/4 inch pipe.....	1 5/8 inches, O. D.	4 inch pipe.....	4 1/2 inches, O. D.
1 1/2 inch pipe.....	1 7/8 inches, O. D.	4 1/2 inch pipe.....	5 inches, O. D.
2 inch pipe.....	2 3/8 inches, O. D.	5 inch pipe.....	5 5/8 inches, O. D.
2 1/2 inch pipe.....	2 7/8 inches, O. D.	6 inch pipe.....	6 5/8 inches, O. D.



A Few Louden Dairy Barn Fittings—Plate 15

We have over 1000 Barn Equipment Patterns and can equip any kind of barn
 Corner Couplings N-6 to N-13, Inclusive, Patented August 17, 1915

Some of the Louden Dairy Barn Fittings

Plate 15 on preceding page shows a few of the Louden Fittings for Dairy Barn Equipments. The letters and figures attached are neither figure numbers nor pattern numbers, but are intended to designate the parts only in connection with this plate. Pat'd Sept. 20, 1910 and Aug. 17, 1915.

In ordering, be sure to give the Plate Number (15) as well as the names and the letters and figures attached to the parts. Also, give size or sizes. All measurements are outside diameters. See table of diameters on another page.

Specifications

N-1, is our improved Single Piece Elbow. It is made in two sizes, standard, for $1\frac{5}{8}$ " and large, for $1\frac{7}{8}$ " O. D. tubing. In all couplings the $1\frac{7}{8}$ " size can be used for $1\frac{5}{8}$ " by bushing.

N-2, Improved Interlocking Tee-Coupling, made in three sizes, standard, for $1\frac{5}{8}$ ", and large, for $1\frac{7}{8}$ " O. D. tubing; also, for $1\frac{7}{8}$ " O. D. heads and $1\frac{5}{8}$ " O. D. Tees. See Fig. 933, page 77.

N-3, Improved Cross Coupling, made in three sizes, standard, large and small, for $1\frac{5}{8}$ ", $1\frac{7}{8}$ " and $1\frac{1}{16}$ " O. D. tubing.

N-4, Inverted Y-Coupling, one size, head tubing, $1\frac{7}{8}$ " O. D., legs, $1\frac{5}{8}$ " O. D.

N-5, Side or Angle Tee-Coupling (45 degrees), one size, head for $1\frac{7}{8}$ " and Tee for $1\frac{5}{8}$ " O. D. tubing.

N-6, Right Angle Corner Coupling, two sizes, standard, for $1\frac{5}{8}$ " O. D., and large, for $1\frac{7}{8}$ " O. D. tubing.

N-7, Seventy-two (72) degree Corner Coupling, two sizes, for $1\frac{5}{8}$ " and $1\frac{7}{8}$ " O. D. tubing.

N-8, One hundred and twenty (120) degree Corner Coupling, two sizes, for $1\frac{5}{8}$ " and $1\frac{7}{8}$ " O. D. tubing.

N-9, Straight Side Partition Coupling (90 degrees), two sizes, for $1\frac{5}{8}$ " and $1\frac{7}{8}$ " O. D. tubing.

N-10, Angle Side Partition Coupling, the sides being disposed at an angle of 144 degrees and the partition being set at an angle of 72 degrees to the sides, two sizes, for $1\frac{5}{8}$ " and $1\frac{7}{8}$ " O. D. tubing.

N-11, Three Piece Center Partition Coupling, each set at an angle of one hundred and twenty (120) degrees to the other, two sizes, for $1\frac{5}{8}$ " and $1\frac{7}{8}$ " O. D. tubing.

N-12, Four-Piece Center Partition Coupling, each set at an angle of 90 degrees (right angles) to the other, two sizes, for $1\frac{5}{8}$ " and $1\frac{7}{8}$ " O. D. tubing.

N-13, Five-Piece Center Partition Coupling, each set at an angle of seventy-two (72) degrees to the other, two sizes, for $1\frac{5}{8}$ " and $1\frac{7}{8}$ " O. D. tubing.

N-14, Tee-Coupling for large posts or columns, eighteen sizes. The smaller or Tee ends are made for $1\frac{5}{8}$ " and $1\frac{7}{8}$ " O. D. tubing. The larger or head ends are made for $2\frac{3}{8}$, $2\frac{7}{8}$ or 3 , $3\frac{1}{2}$, 4 , $4\frac{1}{2}$, 5 , $5\frac{1}{2}$ or $5\frac{5}{8}$, 6 and $6\frac{5}{8}$ " O. D. posts or columns. In ordering give sizes of all connections.

N-15, Cross Coupling for large posts or columns, eighteen sizes, smaller ends for $1\frac{5}{8}$ " or $1\frac{7}{8}$ " O. D. tubing, center for $2\frac{3}{8}$, $2\frac{7}{8}$ or 3 , $3\frac{1}{2}$, 4 , $4\frac{1}{2}$, 5 , $5\frac{1}{2}$ or $5\frac{5}{8}$, 6 and $6\frac{5}{8}$ " O. D. posts or columns. Give sizes of all connections.

N-16, Large Floor Flange for $1\frac{7}{8}$ " O. D. tubing; will fit $1\frac{5}{8}$ " O. D. tubing by bushing.

N-17, Wall or Flat Post Flange for $1\frac{7}{8}$ " O. D. tubing. Will fit $1\frac{5}{8}$ " O. D. tubing by bushing.

N-18, Wall or Flat Post Flange, two sizes, for $1\frac{5}{16}$ " and $1\frac{5}{8}$ " O. D. tubing.

N-19, Grip Clamp, made in eight sizes, the O. D. of the head tubing being given first and of the Tees, second. $1\frac{7}{8}$ x $1\frac{5}{8}$; $1\frac{7}{8}$ x $1\frac{5}{16}$; $1\frac{7}{8}$ x $1\frac{1}{16}$; $1\frac{5}{8}$ x $1\frac{5}{8}$; $1\frac{5}{8}$ x $1\frac{5}{16}$; $1\frac{5}{8}$ x $1\frac{1}{16}$; $1\frac{5}{16}$ x $1\frac{1}{16}$, and $1\frac{1}{16}$ x $1\frac{1}{16}$ " O. D. tubing. (For description of Grip Clamps, see page 139.)

N-20, Interlocking Stanchion Holder and Manger Spring Holder, two sizes, for $1\frac{5}{8}$ " and $1\frac{7}{8}$ " O. D. tubing.

N-21, Collar, two sizes, for $1\frac{5}{8}$ " and $1\frac{7}{8}$ " O. D. tubing.

N-22, Double or Center Pivot for Manger Hinges, two sizes, for $1\frac{5}{8}$ " and $1\frac{7}{8}$ " O. D. tubing.

N-23, Single or End Pivot for Manger Hinges, two sizes, for $1\frac{5}{8}$ " and $1\frac{7}{8}$ " O. D. tubing.

N-24, Pressed Steel Clip, for throat chains, stanchion side chains and "Hold Shut" for Gate Latch; three sizes, for $1\frac{5}{16}$ ", $1\frac{5}{8}$ " and $1\frac{7}{8}$ " O. D. tubing.

N-25, Center Brace Rod Clamp for Manger Divisions, for $1\frac{1}{16}$ " O. D. tubing.

N-26, End Brace Rod Clamp for Manger Division, for $1\frac{1}{16}$ " O. D. tubing.

N-27, Right Angle Side Partition Coupling for large posts or columns with built-on clamp; sixteen sizes, small ends for $1\frac{5}{8}$ " and $1\frac{7}{8}$ " O. D. tubing. Center for $2\frac{7}{8}$ or 3 , $3\frac{1}{2}$, 4 , $4\frac{1}{2}$, 5 , $5\frac{1}{2}$ or $5\frac{5}{8}$, 6 and $6\frac{5}{8}$ " posts or columns. This is the same as N-15 with a built-on clamp added.

N-28, Right Angle Center Partition Coupling for large posts or columns, with built-on clamps. Sizes the same as N-27. Give sizes of all the parts in ordering.

N-29, Acute Angle Cross Coupling for large posts or columns, with built-on clamps set at an acute angle to the Tee-Heads and to themselves. Sizes the same as N-27. Built-on clamps may be placed on the other side of coupling if desired, making as many as 6 small clamps, 2 integral and 4 built-on. If necessary, the angles of built-on clamps may be varied to some extent. In ordering, give sizes of all the parts and the angles of built-on clamps.

N-30, (Overlooked in Plate 15). Right Angle Corner Coupling for large posts or columns with built-on clamps for $1\frac{5}{8}$ " or $1\frac{7}{8}$ " O. D. tubing. It is like N-14 with one built-on clamp. Same size as N-27.

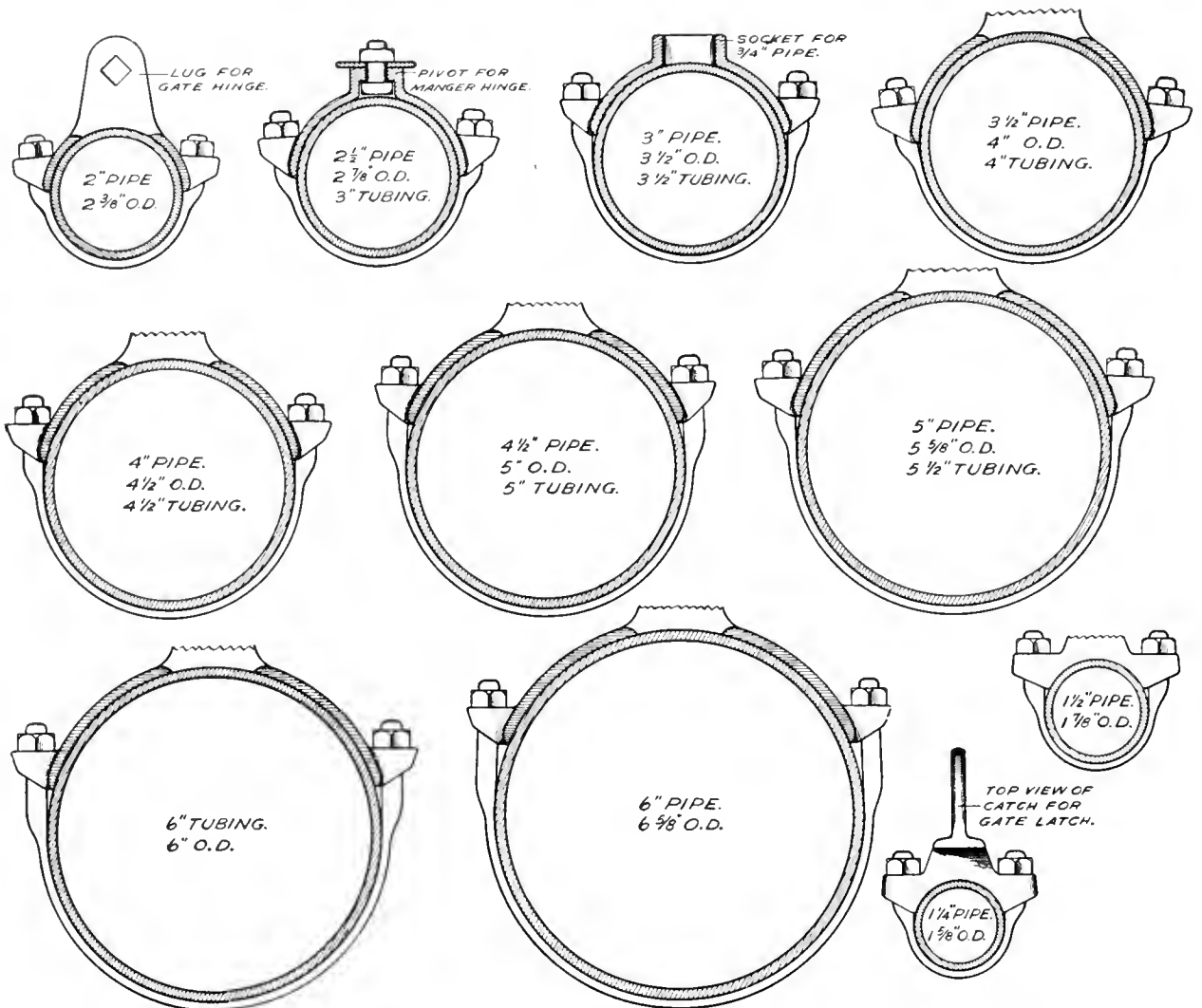

Louden Special Connections for Posts and Columns—Plate 16

Plate 16 shows horizontal sections of some of our Special Connections for posts and columns which are clamped thereon by clip-bolts. These connections may be used for a number of purposes, such as lugs for gate hinges, pivots for manger hinges, catches for gate latches, sockets for pipes or tubing, such as are used for pivot pins for manger hinges with our double post stalls, etc. Seven of the figures show the attaching parts of the connections broken away which means that these parts may be made for various purposes to suit requirements.

The object in presenting this plate is to show that the bodies of the connections and the clip-bolts which are used to clamp them on the various sizes of posts and columns are **standardized** so that no matter what use may be made of the connections, their bodies and the clip-bolts which go with them, will always be the same for each size of post and column.

The bodies of the connections are made of thin malleable iron which is easily sprung to suit the size of the post or column for which they are intended. For heavier work, such as gate hinges, etc., two clip-bolts are used with each connection which is made wider and is furnished with four bolt eyes instead of two. The plate shows 11 different sizes of posts or columns, the outside diameters of which are as follows: $1\frac{3}{8}$, $1\frac{7}{8}$, $2\frac{3}{8}$, $2\frac{7}{8}$ or 3", $3\frac{1}{2}$, 4", $4\frac{1}{2}$, 5", $5\frac{1}{2}$ or $5\frac{5}{8}$, 6" and $6\frac{5}{8}$. Sometimes common pipe is used, hence the inside measurements of pipe given in the plate.

There is a little variation in two of the sizes. This is caused by the difference in the outside diameters of the corresponding sizes of pipe and tubing. The outside diameter of a $2\frac{1}{2}$ -inch pipe is $2\frac{7}{8}$ or $\frac{1}{8}$ less than a 3-inch tube, while the outside diameter of a 5-inch pipe is $5\frac{5}{8}$ or $\frac{1}{8}$ more than a $5\frac{1}{2}$ -inch tube. The connections are made to allow for this variation.



Fig. 1150

Louden Grip Clamp

(Patented April 7, 1914)

Fig. 1150 is a good representation of our Grip Clamp referred to in the specifications of our Figs. 810 and 959 Cow Stalls, and extensively used in all of our animal pens, hundreds of thousands of them being used for this purpose. It is the smoothest, neatest and best clamp of the kind ever made. It requires no holes to be drilled in the tubing. Only two bolts are used which are so located that they will exert **equal pressure** on all the adjacent parts of the tubing — a feature that is fully covered by our patent.

We make 8 sizes, outside diameter of the head tubing being given first. The prices of the different sizes with bolts, coated with our Special Dairy Barn Paint and galvanized, are given in the accompanying price list.

	Size
No. 1.	$1\frac{7}{8} \times 1\frac{5}{8}$
No. 2.	$1\frac{7}{8} \times 1\frac{5}{8}$
No. 3.	$1\frac{7}{8} \times 1\frac{1}{8}$
No. 4.	$1\frac{5}{8} \times 1\frac{5}{8}$

	Size
No. 5.	$1\frac{5}{8} \times 1\frac{5}{8}$
No. 6.	$1\frac{5}{8} \times 1\frac{1}{8}$
No. 7.	$1\frac{5}{8} \times 1\frac{1}{8}$
No. 8.	$1\frac{1}{8} \times 1\frac{1}{8}$

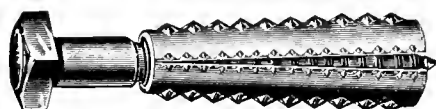

Fig. 879



Fig. 1073



Fig. 727

Anchor and Hook Bolts

Fig. 879 is an Expansion Bolt which we use to make attachments to brick and hardened cement work.

Fig. 1073 is a smaller view of an Anchor Bolt to make attachment to either green or hardened cement work. It is provided with a Helical Steel Lining and is set in a hole which is bored with a common auger bit in green cement or drilled with a star drill in hardened concrete, the hole and the lining being filled with soft cement before inserting. The bolt can be readily taken out or replaced when the cement hardens, the lining remaining.

Fig. 727 is a Hook Bolt to fasten stanchions to wood top-rails.

We furnish only the sizes necessary to attach the fittings used with our equipments.

Louden Parallel Clamps

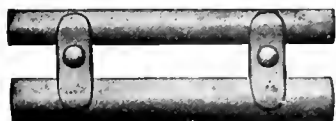

Fig. 1190

These Clamps are used for attaching water pipes or air pipes for milking machines, to the top-rails of stalls, or for any other purpose where two pipes or pieces of tubing are to run parallel with each other. There are four sizes, $1\frac{5}{8} \times 1\frac{5}{8}$ and $1\frac{7}{8}$ O. D., and $1\frac{1}{8} \times 1\frac{5}{8}$ and $1\frac{7}{8}$ O. D. The two former will connect an inch pipe with $1\frac{5}{8}$ or $1\frac{7}{8}$ tubing. The two latter will connect a $\frac{3}{4}$ -inch pipe with the same sizes of tubing.

Easy to Install

There is no troublesome or expensive installation with the Louden goods. The patterns are made to fit; the malleable castings are all "dropped" to straighten and make them uniform, and everything is made to go together easily and quickly. The most complete and specific directions are furnished for installing standard work and nothing is left for guesswork or to be figured out.



Barn of W.S. Moscrib, Lake Elmo, Minn.
Louden Equipped

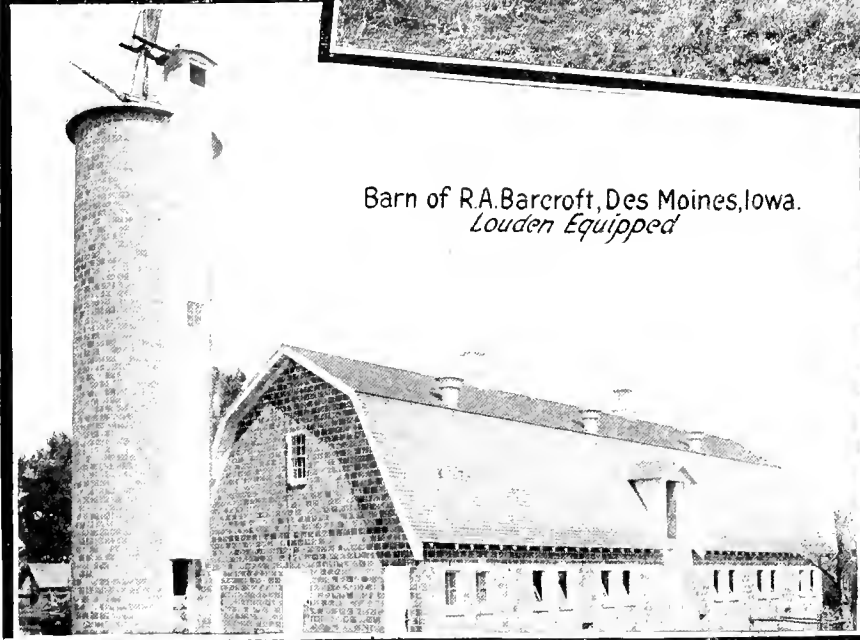

Barn of R.A. Barcroft, Des Moines, Iowa.
Louden Equipped

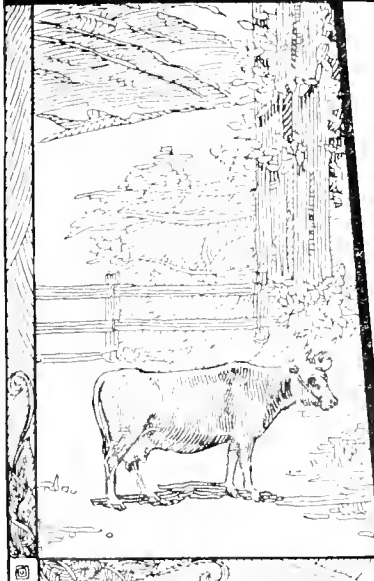
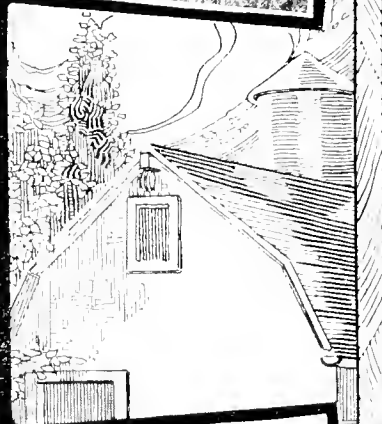

Barn of Stephen A. Bull, Racine, Wis.
Louden Equipped

Louden Cupola — Fig. 1269

Specifications

Sizes

	Size	Ventilating Flue	Base Moulding	Height
No. 4	Louden	20-inch	36x36 inches	9 feet
No. 3	Louden	24-inch	46x46 inches	11 feet
No. 2	Louden	27-inch	49x49 inches	12 feet
No. 1	Louden	30-inch	54x54 inches	13 feet
No. 100	Louden	36-inch	64x64 inches	14 feet

Weights and Estimate of Size of Cupola Wanted

Building 20x28, one No. 4 Louden Cupola; shipping weight, 160 lbs.
 Building 24x28, one No. 3 Louden Cupola; shipping weight, 180 lbs.
 Building 30x40, one No. 2 Louden Cupola; shipping weight, 200 lbs.
 Building 36x50, one No. 1 Louden Cupola; shipping weight, 220 lbs.
 Building 40x70, two No. 1 Louden Cupolas; shipping weight, 220 lbs.
 Building 60x60, one No. 100 Louden Cupola.

No charge for crating

The Louden Cupola is built along standard lines on principles that have been accepted by the leading ventilator authorities and most ventilator manufacturers.

It is a well-built, substantial cupola and will last a lifetime. As an ornament to the barn it is surpassed by no other ventilator. It is storm proof and bird proof. It is not how cheap but how good we can make the Louden Cupola. We do not spare any cost to make it lasting.

Have your carpenter figure on a wooden cupola, say 6x8 feet, which at its best is not as good a ventilator as the Louden. Do not overlook the cost of weather vane, which would be \$3.00 to \$5.00, and \$3.00 to \$5.00 for painting, which would have to be done every few years, and would be additional expense. Then compare with our price and we believe you will find that the Louden is much cheaper, and after all it is absolutely impossible to build a good ventilator out of wood.

You buy a cupola once in a lifetime and you want it as substantial as you can get it. Any ordinary mechanic can put it on the building in from two to four hours. Wherever a carpenter

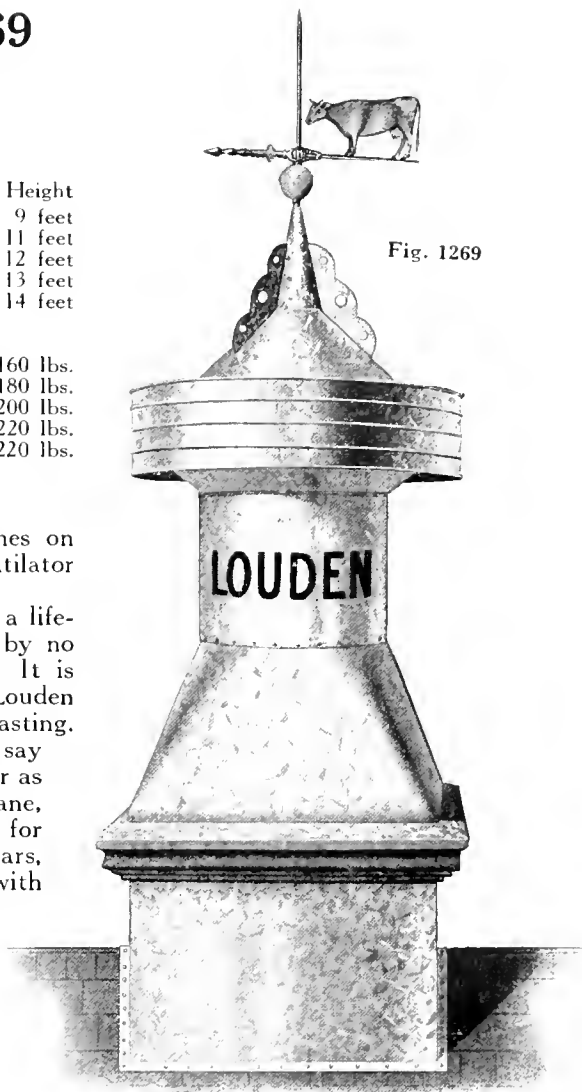

Fig. 1269

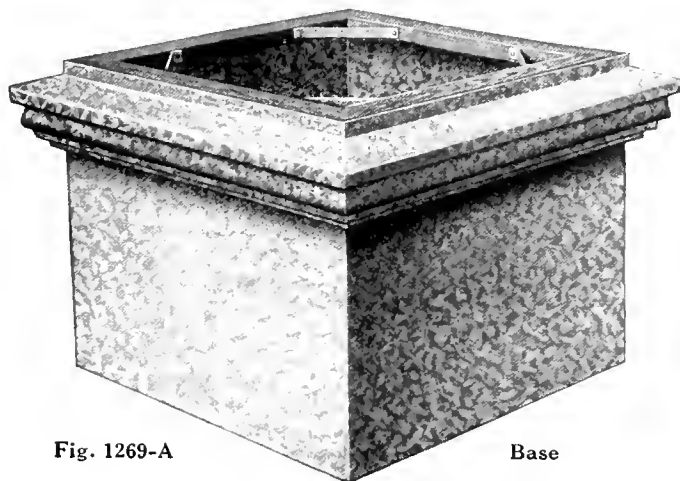

Fig. 1269-A

Base

puts a Louden Cupola on a barn he finds that he does not want to make one out of wood again, but will always recommend the Louden. He knows that he is saving money for the man that he is building the barn for and giving him a better cupola than can be built of wood.

The Louden Cupola's One-Piece Base

The Louden base requires no frame on the roof before putting it in place, as the base is made up complete in one solid piece of galvanized material.

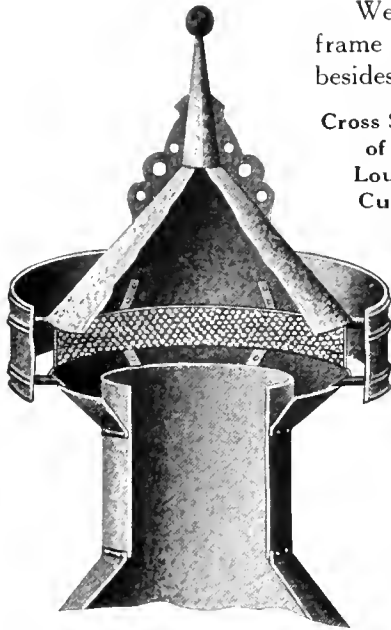

Cross Section
of the
Louden
Cupola

We also use our own specially designed moulding with angle-braced wood frame inside, which adds great strength to the moulding and base proper, besides being very artistic. We only use the best of galvanized material in their construction including all galvanized bolts and washers. They are built strong and will stand windstorms and will not get out of shape, and are also screened to keep out birds. They are built on scientific principles for ventilation and it does not matter which way the wind blows or what the surroundings are as the Louden Cupola will always have an up-draft within and will ventilate the building well. They require no painting and will last longer than the ordinary frame building. They do not weigh one-third as much as the old style wood cupola and will not sag the roof. The Louden Cupola is furnished with 30-inch Full Body Gold Leaf Weather Vane, the best that can be made, and one that will stay bright, in the following designs: Horse, Cow, Sheep, Pig or Rooster. In ordering always state the kind of weather vane you want.

Louden Ventilators Fig. 1268

Every living creature must have fresh air—none can live without it. When air enters the lungs and is breathed out, there has been removed from it the life-giving qualities. It has changed to poisonous gas.

The warmer and better a barn is constructed the more necessary is artificial ventilation. On thousands of farms there are "well built" barns where lack of pure air is sapping the vitality of the stock. Upon opening the doors of such a barn in the morning a man would almost be nauseated by the sickening, poisonous air were it not for other more noticeable but far less dangerous odors.

An average 1,000-pound animal will consume about 3,000 cubic feet of air in 24 hours. This "consumed" or used air must be removed from the barn and fresh air must be allowed to enter to take its place.

Most new barns have vent flues to carry off this impure air, but in many barns these outlets are not doing the work for which they are intended. In some cases this failure is due to a "cap" or "ventilator" that hinders rather than assists the ventilating system.

Note: We do not furnish bases with Louden Ventilators. Different roof pitches and different conditions for attaching make it impossible to do so.

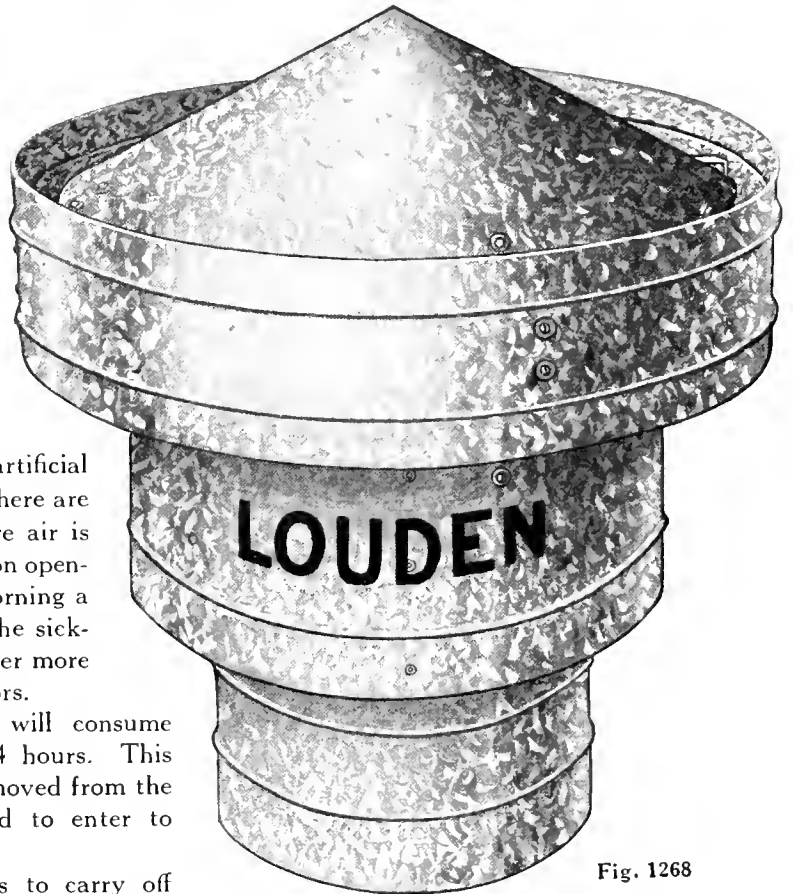

Fig. 1268

Size—Diameter of Throat in inches	Gauge Metal used	Specifications		
		Area in sq. inches	Weight without Base	Capacity in cu. ft. per Hour
12	24	113	26 lb.	36,500
18	24	254	65 lb.	82,000
24	22	452	124 lb.	145,900
30	22	707	195 lb.	231,000
36	20	1,017	245 lb.	304,000

The above capacities are based on a wind velocity of 9.3 miles per hour, which is the average for the entire country, a difference of 20 degrees between the inside and outside temperature and a straight flue 30 feet high. If you wish to know the capacity of any size ventilator under conditions different than the above consult our engineering department. The service is free.

When the Louden company decided to design and manufacture a ventilator we started planning from the "ground up." The fact that some big selling ventilators were made in a certain way did not influence our plans. Neither did we permit mere personal opinion to influence our decisions. We purchased and have used the most expensive and reliable instruments or machines (anemometers) for our tests and reached our conclusions through their records. The anemometers used are the official testing apparatus of the government.

It is a fact well known to ventilation engineers that the most efficient way to produce a draft in a flue is to pass a current of air across the top of the flue. Careful tests show that a plain flue projecting through the roof will give much better results than most so-called "ventilators" now in the market.

The ideal ventilator must depend upon correct scientific principles for its construction and operation. It must convert the largest possible per cent of the energy contained in the wind into a pumping or pulling force to draw the foul air up the flues and out of the building. At the same time there must be no air enter the ventilator from the outside to carry in rain and snow. Rain and snow entering the ventilator would run down the flue, necessitating gutters to catch it and drain it out. This would be undesirable as the openings would often clog up in the winter. Neither should there be any moving parts to get out of order and give trouble.

The Louden Ventilator fulfills all requirements. The exhaust openings are of ample area and they are all so placed that the wind blows **across**—never into—the openings. **Every opening in the Louden Ventilator is an exhaust opening. No air enters the ventilator at any point.** Even on the side exposed to the wind the air is constantly **coming out** of all openings. No matter how strong or light the wind may blow—from north, east, south, or west—in a March blizzard, in April shower, or on the sultriest days of August—there is always a strong, steady draft up the flue that will give ample ventilation. It will also do its duty regardless of the difference of temperature inside and outside the building.

The Louden Ventilator is absolutely storm proof.

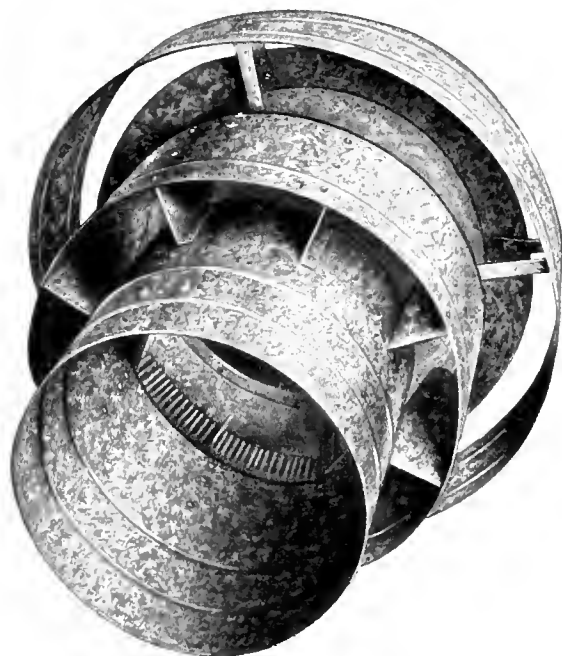

Fig. 1268A

Construction of Louden Ventilators

The appearance of Louden Ventilators is artistic and attractive in its simplicity.

The construction is heavy, rigid, and of the very best materials. Neither time nor expense was spared in designing this ventilator to have it accomplish the needed ventilating results and be time, storm, and rust resisting.

The lower band of Louden Ventilators is strongly braced inside, clear around, by eight braces. This gives the whole ventilator an exceptionally strong and rigid construction. The cone-shaped cap offers the least possible resistance to the wind and gives no opportunity for rain, snow, or sleet to collect.

The smaller sizes of the Louden Ventilator are made of 24-gauge steel, the 24 and 30 inch sizes of 22-gauge steel, and the larger sizes of 20-gauge steel. All parts are carefully riveted with special rust-resisting rivets or are electric welded, and at the joints the sheet metal is joined in the most scientific and substantial manner. Figure 1268A shows how the ventilator is constructed.

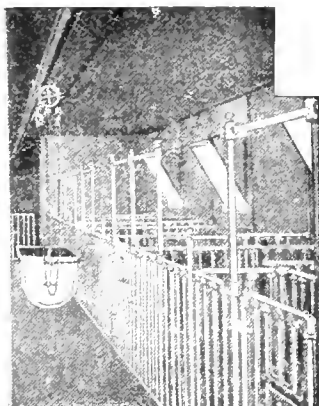
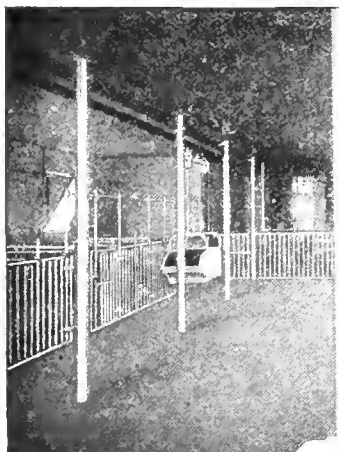

Calf Stable with exercise court in center at Homewood Farms

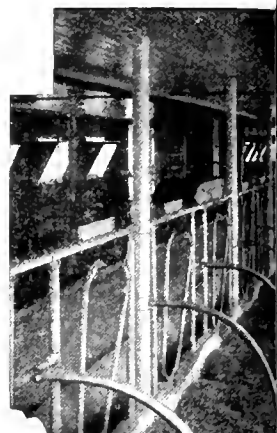

Main Dairy Barn, Homewood Farms, and 32 Louden Stalls, and



The great barns of the Homewood Farms, designed by the Louden Architectural Design, and used throughout the world. Owned by Wm. Butterworth, Jr.

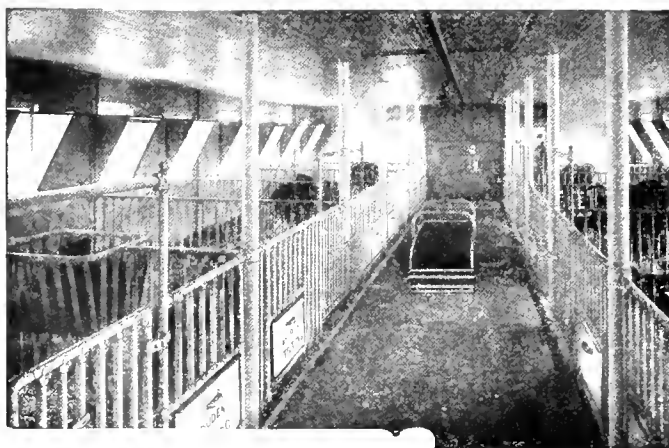

Test Barn at Homewood Farms. Louden Pens and Feed Carrier



Hospital Barn—Homewood Farms, used for Hospital Stalls and Bull Pens



Farms. In this building are Louden Box Stalls

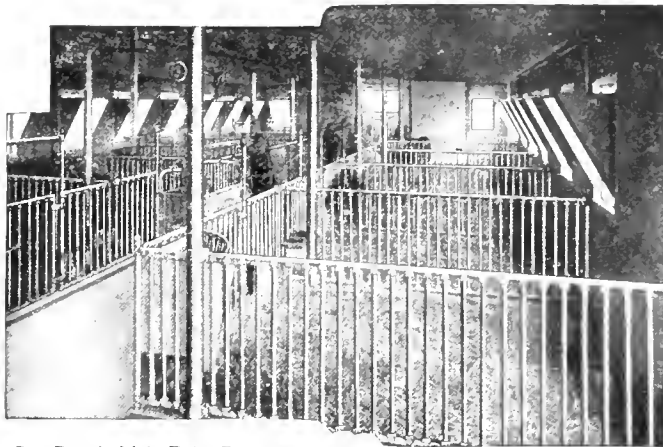

Cow Pens in Main Dairy Barn at Homewood Farms, Louden planned and equipped

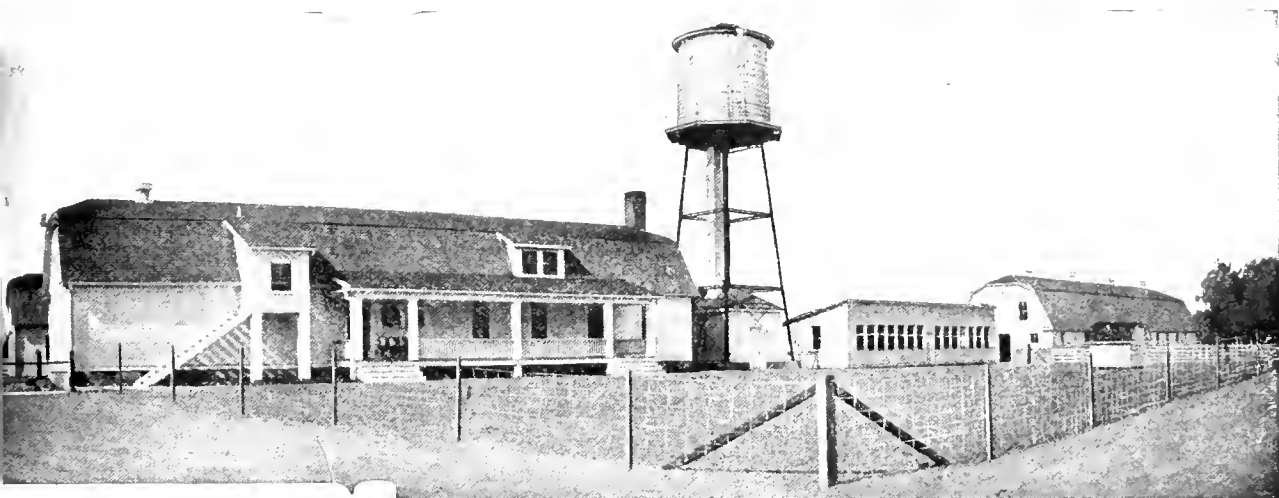

at Moline, Illinois, were planned by Louden, and were equipped with Louden goods.

ident of Deere and Company



farm showing roomy Pens and Maternity Pens. far end

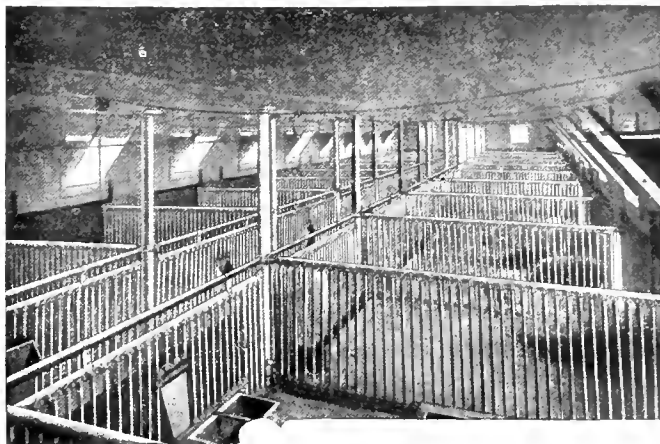

Louden planned and equipped Hog House at Homewood Farms

Louden Window Ventilator

Specifications

Size Window: Fits any window where sash does not exceed 48 inches in height. Special ventilators for higher windows can be furnished, at slight additional cost, on special orders.

Fixtures Include: 2 shields (one right and one left), two dogs, two braces, 1 catch and 1 keeper, 22 screws, and 2 rivets.

Finish: Galvanized.

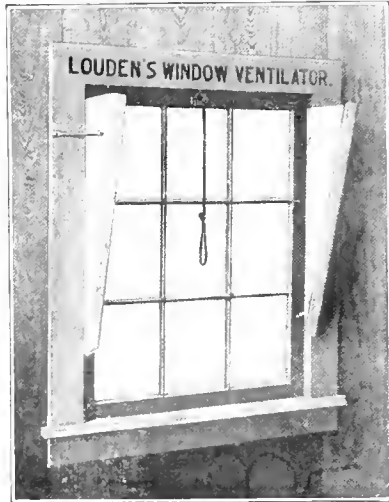

Fig. 986
Window Closed

Fresh air in the barn is as necessary for the comfort and health of the stock as fresh water and pure food. According to experts the average cow consumes more pounds of air than she does of either food or water. A 1,000 pound cow consumes about 224 pounds of air daily.

The Louden Window Ventilator makes possible an abundance of fresh air without injurious draughts. Instead of opening like an ordinary window the sash tilts inward from the top and rests against metal shields, as shown in Fig. 988-A. The cold air, instead of striking the stock directly, is thrown upward, and mingles with the warm air near the ceiling before it comes in contact with the animals.

When it is necessary to keep stock in the barn during warm weather the window may be opened and raised, as shown in Fig. 988-B, to give a direct and cooling circulation of air throughout the barn. This feature is a decided improvement over the hinged type of window, which cannot be raised. With the Louden Window

Ventilator the sash may easily be removed from the window if desired.

All photos shown are inside views.

Fig. 989 is a cross section of a window fitted with a Louden Window Ventilator. It shows the window open and slightly raised. The sash is held in the raised position by two locking dogs, one on each side.

The shields are made of galvanized sheet steel. They are secured to the casing by screws along the inner edges. Flanges along the outer edges, turned in, support the sash when open. The shields are stiffened by brace rods, riveted on.

The Louden Window Ventilator is made in different sizes to fit any window. To get the proper size, give height of sash. This measurement is absolutely necessary before we can make up the shields. No other is needed.

The Louden Window Ventilator is the most perfect window ventilator made. It is inexpensive and extremely simple. Specify it when you build or remodel your barn



Fig. 988-A
Window Open



Fig. 988-B
Pat'd Feb. 7, 1916
Window Open and Slightly
Raised

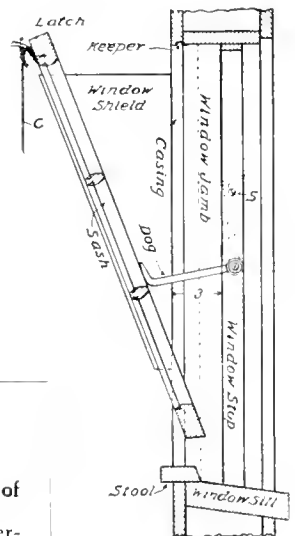

Fig. 989
Cross Section

Pigeon Falls, Wis., July 10, 1916.

The Louden Machinery Co.,
St. Paul, Minn.

Gentlemen:

A line or two of comment about the service of Louden Goods:

The Louden Equipment is the best and most perfect barn equipment that I have ever seen.

Ole Kolden, Kolden Stock Farm.

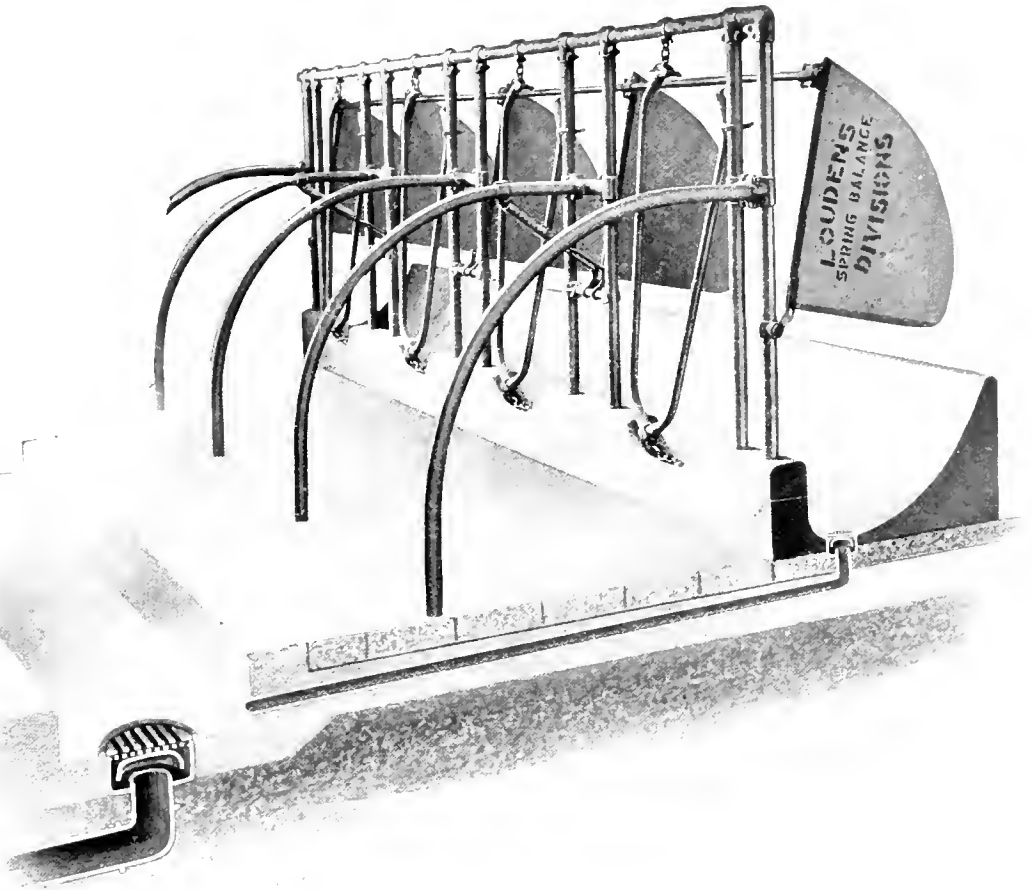

Louden Manger and Gutter Drains

Specifications

Manger Drains are $4\frac{1}{2}$ inches wide at top, and $4\frac{3}{4}$ inches deep, with outlet to fit either $1\frac{1}{2}$ -inch or 2-inch pipe, also 4-inch Cast Iron Soil Pipe or Sewer Tile, and are furnished with bell trap strainer and brass cover. Weight, $5\frac{1}{4}$ pounds.

Gutter or Floor Drains are 8 inches wide at top and 7 inches deep with outlet to fit either a 4-inch Cast Iron Soil Pipe, or Sewer Tile, and are furnished with bell trap strainer, grating, and with or without brass cover. Weight, 21 pounds.

Gutter Drain is always furnished with brass cover unless otherwise specified.

NOTE: For other types of Drains and Cess Pools, see page 212.

Proper drainage of the barn is second in importance only to proper lighting and ventilation. In many barns the drainage is so poor that it offsets to a great extent the advantages of proper ventilation facilities.

In addition to the sanitary advantages of proper drainage, the saving of the liquid manure makes the system an economy. Land to which liquid manure is applied will very shortly return in increased crops the entire cost of the installation.

Illustration shows an excellent method of barn drainage. In the gutter at the left of the picture is a cross section of our floor, or gutter drain.

As can be seen in the illustrations, on this and on the next page, both the gutter drains and the manger drains are

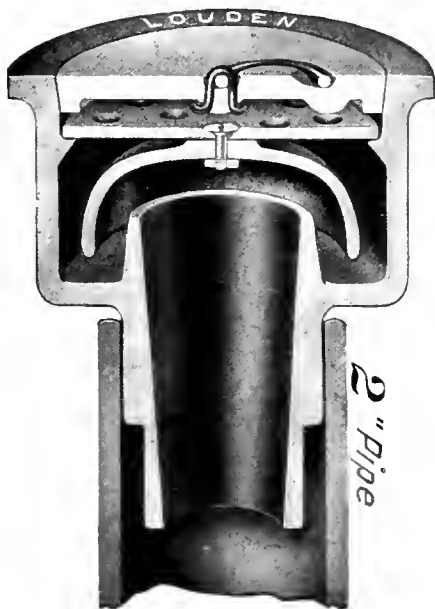

Fig. 1272

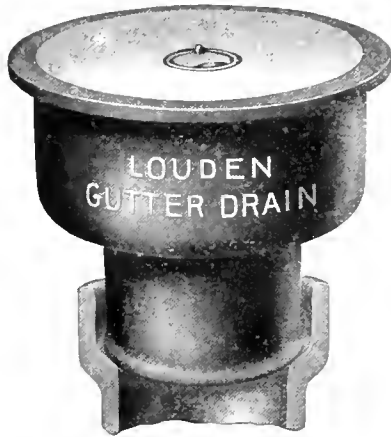

Fig. 1271
Gutter Drain fitted to 4-inch
Tile or Soil Pipe



Fig. 1270
Manger Drain in 1 1/2-inch Pipe



Fig. 1270 1/2
Manger Drain fitted to 4-inch
Drain Tile

equipped with bell trap so that no odors or gases can escape into the barn. Each is equipped with strainers which are a part of the bell trap. This prevents trash entering and clogging up the drain pipes.

Drains are made of cast iron throughout with the exception of the close-fitting, water-tight brass lid.

The brass lids have a perfectly milled seat, the same as found on valves of automobiles and gasoline engines, which are recognized standard. The lids, while easily removed, close the opening air tight by their own weight.

The lifting rings on the brass lids are counter sunk, so there is no danger of the lid being displaced by the animals stepping on it, or rooting with the nose. While fitting snugly, the lifting ring is so arranged that lid can be removed instantly with the fingers, no tools being required.

Manger Drain Installation

Figures 1270 and 1270 1/2 show how Louden Manger Drains fit different sizes of drain pipe. The manger drain pipe should never be less than 1 1/2-inch pipe, and our drain heads will fit that size; also a 2-inch pipe or 4-inch soil pipe or tile. Illustration shows how far below the manger floor level the drain pipe may rise to allow for proper installation.

The advantage of having a drain for the mangers is great. With the drain closed with the close-fitting cap, the animals may be watered conveniently, and the mangers scrubbed out as often as desired.

Gutter Drain Installation

Louden Gutter Drains are made to fit either a 4-inch Cast Soil Pipe or Sewer tile. Illustration shows proper installation. The inside wall of the Drain is 4 inches in diameter, the same as the 4-inch inside of the drain tile. Set the flange end of tile next to floor and Drain when set in it with cement will be absolutely rigid. Every barn should have a drainage system that will make it possible to save every bit of the liquid manure. Different conditions in the barn surroundings will make the installation of a liquid manure system a matter of personal choice, but the main point—save the liquids—can not be too strongly urged.

It is an easy matter to arrange cocks at the cistern so that the water from the mangers need not enter the cistern, but be carried to other places.

Let Our Experts Help You

We have a large corps of men who are experts on barn construction, barn arrangement, ventilation, drainage, and kindred subjects. These experts are at your service and advice is free. If you are going to build or remodel your barn do not hesitate to write us. Our suggestions may save you many dollars.

The Louden Guarantee

We guarantee all our products to be exactly as herein represented, and to perform the work for which they are intended in a satisfactory manner. Also, that the material and workmanship is free from defects, and we agree to replace without charge anything which may be defective.

This has been our practice during our fifty years of building Barn Equipments, and upon this policy our extensive, world-wide business has been built. Those who know the Louden Company or the Louden goods do not require any formal guarantee. They KNOW that everything made by us will be **FIRST CLASS IN EVERY RESPECT.**

Our most enthusiastic customers are those who have used other equipments and have **LEARNED FROM EXPERIENCE** the superior merits of ours. We want the prospective purchaser to ask the men who use our equipment and to find out for himself which is **THE BEST** from every point of practical service and genuine utility.

We invite a thorough investigation, and solicit a trial with other equipments, whenever practical, because we know that this is the best way to demonstrate the decided superiority of our goods. Our long established reputation for fair and honorable dealing, in addition to the established merits of our goods, is ample protection for every purchaser.

THE LOUDEN MACHINERY COMPANY

By



President

Coatings for Dairy Barn Equipments



After many years of scientific research and painstaking experiments, we have succeeded in producing an improved Coating for Dairy Barn Equipments, which will be known as "**Louden Tantite.**" It is a beautiful tan color, not too dark nor too light, but **just right** to harmonize with and satisfy all the requirements of an up-to-date dairy barn. It is made from our own formula which was worked out after years of patient investigation and consultations with the foremost experts in the manufacture of paints. Next to galvanizing it is the most durable coating made for barn equipment. In a well ventilated barn, where the moisture is properly taken care of, it will stand as well as galvanizing, and will cost considerably less.

All the metal work of our equipment will be coated with "**Tantite**" unless the order calls for galvanizing. The tubing and other metal parts are first carefully cleaned to free them from scale and dirt, and are then dipped in a heavy mixture of "**Tantite,**" which will run into all openings, thus coating the **inside** of the tubing and castings as well as the outside. After dipping, the parts are run on an overhead track into a large steam heated oven where the "**Tantite**" is thoroughly **baked on.** The result is a heavy coating of "**Tantite,**" both inside and outside, producing the very best finish—really an enamel—which will be as durable as the finish is excellent.

We strongly recommend the coating of stalls and stanchions, the metal parts of mangers, and all animal pens, at least **once a year**, in order to keep them in a strictly sanitary condition. This is necessary, whether galvanized or coated with paint, and when this is done the galvanizing will be but little advantage. Also, in view of the rough handling in shipping and while erecting, it will pay to give the material a coat of "**Tantite**" after it is erected and when the cement work is dry. No one would think of painting the material for a house before it was built and not painting the house afterward. The rough handling is sure to more or less damage the very best finish, and to make the equipment look strictly first class it should be coated after erecting.

We furnish free with each order a small can of "**Tantite,**" sufficient to touch up the scars which may be received in shipping and handling. We also put up "**Tantite**" in two sizes of self-sealing cans, labeled as shown in cut, to be used for additional coating. The larger can is a half gallon, and the smaller is a quart. When properly spread, a half gallon will coat 15 to 20 stalls, and other work in proportion.

All cracks and crevices, wherever they may be, should be filled with some durable filler, such as iron cement, or even good putty with white or red lead added to give it body. This is advisable to make the equipment completely sanitary.

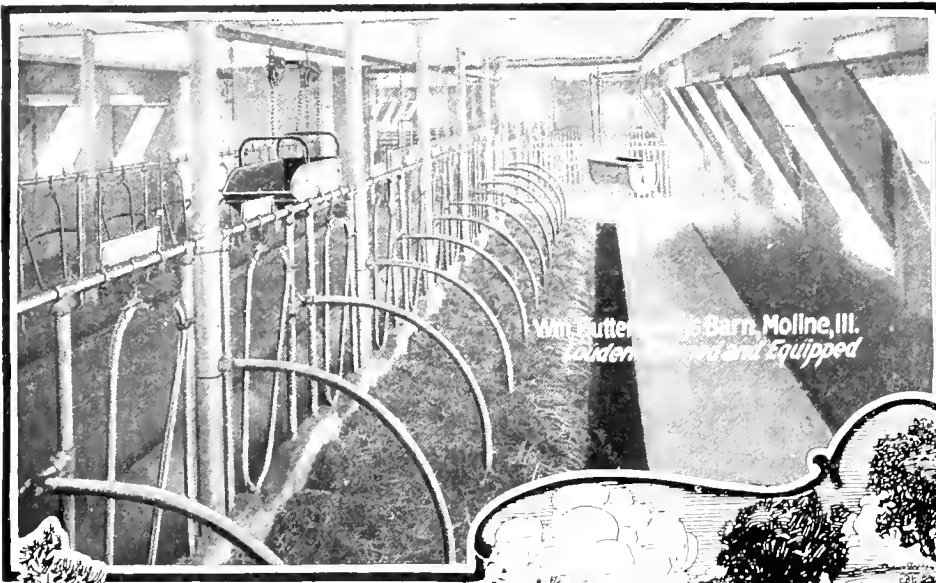

Will Butterfield's Barn, Moline, Ill.
Louden Litter Carriers and Equipped

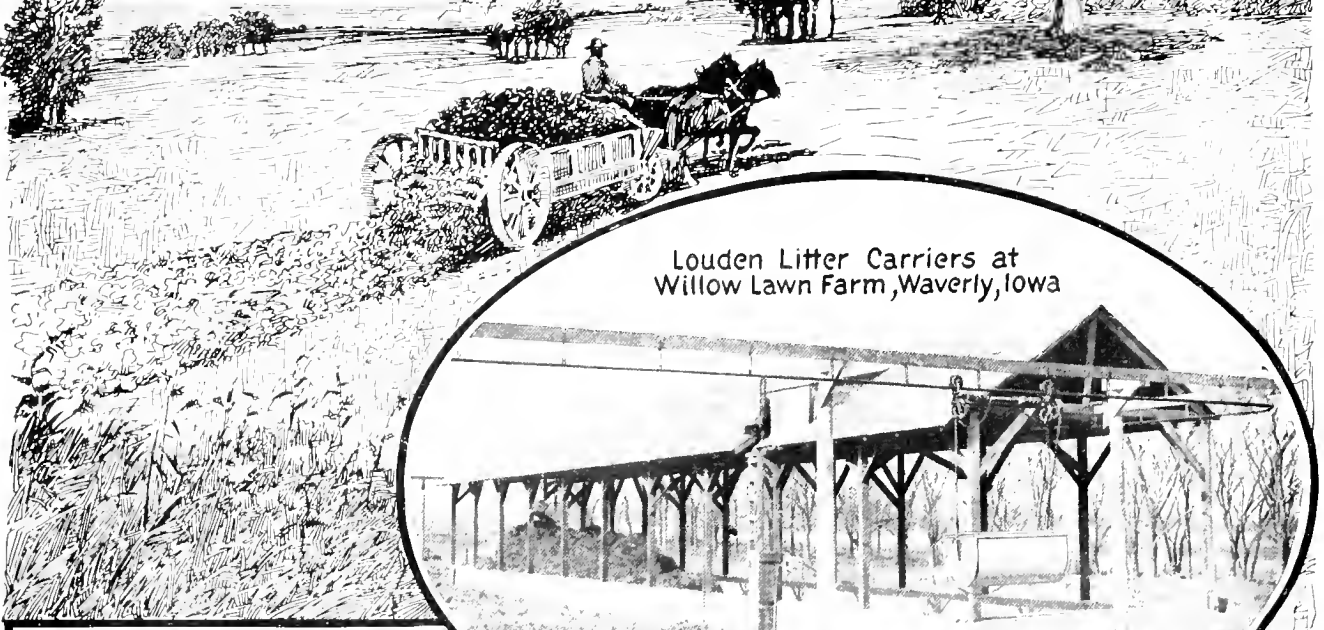

Louden Litter Carriers at
Willow Lawn Farm, Waverly, Iowa

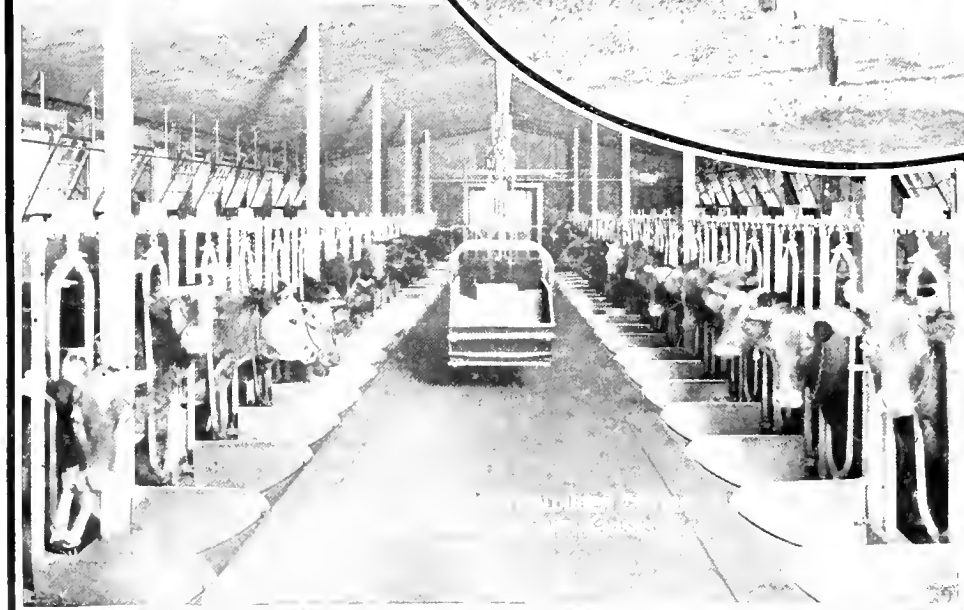

The Wheelbarrow and the
Bushel Basket Have No Place
In The Equipment of the
Modern, Money-Making
Barn.

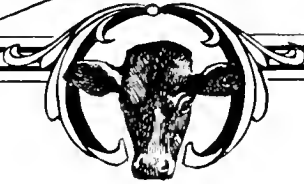
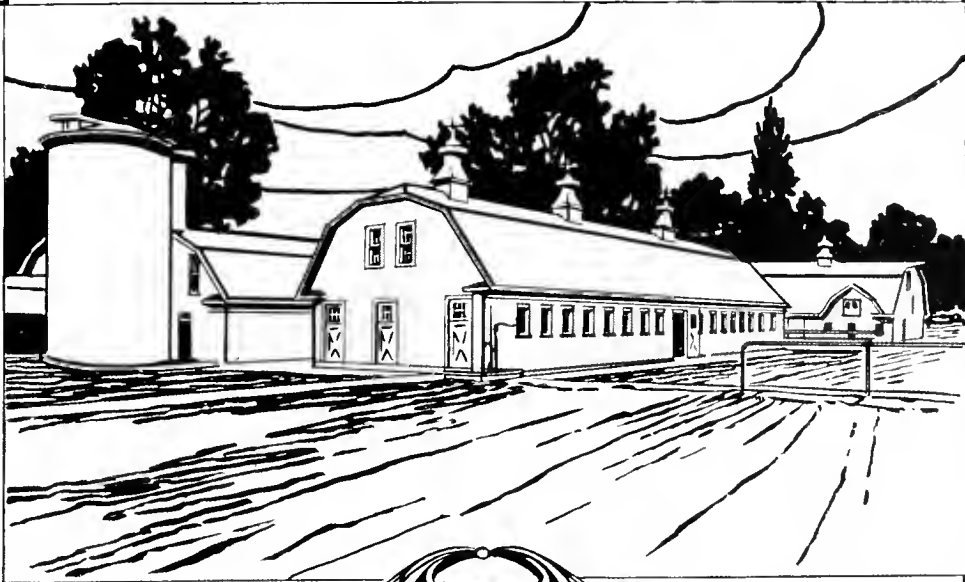

LOUDEN CARRIERS

LITTER, FEED, MILK CAN, HARNESS, AND
MERCHANDISE

	PAGE
Litter Carriers.....	154-166
Feed Carriers.....	167-170
Feed Trucks.....	171
Harness Carriers.....	171
Merchandise Carriers.....	172
Milk Can Carriers.....	173-174
Steel Track and Track Fittings.....	175-183
Swinging Cranes.....	185-186
Rod Track and Fittings.....	187-190
Plans of Installation.....	191-193

Profit and Loss on the Farm

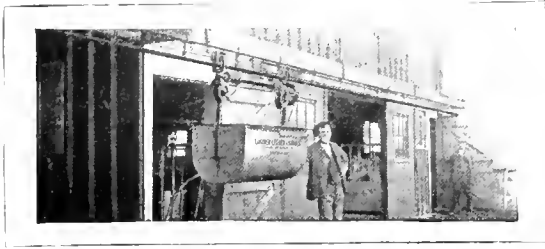

Losses on the farm result from exactly the same causes which make failures of mercantile establishments. The successful farmer must exercise the same care to prevent losses as must the superintendent of a great railway system.

called for by the old wheelbarrow method. The saving in time alone gained by the use of a litter and feed carrier will pay handsomely on the investment.

Waste Steals Profit

Whether it is of labor or of material, waste is the most persistent and insidious cause of loss.

The most valuable by-product of the farm is manure. The litter of the barn is the balance wheel of the farm. Every crop harvested, every blade of grass eaten by cattle uses just so much of your cash capital in soil fertility. You must replace it by fertilizing. Now comes the opportunity for waste. What method do you use for handling manure? All soil experts agree that manure used fresh and containing its full share of liquid is at least 50 per cent more valuable than old manure. Are you losing that 50 per cent through lack of facilities for handling it? A litter carrier installed in your barn will enable you to load fresh manure into a wagon or spreader and make the work mere child's play.

Cleanliness Next To Godliness

Just as much so in the barn as in the kitchen. A clean barn means healthy cattle, more and better dairy products. Removing the unpleasant feature of cleaning the barn by using a litter carrier will result in more frequent cleaning. The carrier places the litter either in your wagon or at any desired distance from your barn, insuring not only a clean barn, but a clean yard as well.

If you do not have our little booklet entitled "Some Interesting Facts on a Homely Subject," which treats of manure values and methods of caring for same, send for it—it is free.

Check Up the Profits

Count them on your fingers: The increase in the value of fresh, wet manure and consequent increase in the fertility of the farm; the saving of time in the handling; the improved health of your cattle; the increase both in quantity and quality of dairy products. Any one of these reasons should be sufficient to induce any farmer or dairyman to equip his barn with a Louden Litter Carrier. Many farmers say that by using a Louden Feed Carrier they are able to prevent a waste of feed that soon pays for a feed carrier—to say nothing of the time saved. If you could reduce each profit to figures, add them up for a year, setting down the answer in dollars and cents, you would very quickly, like everyone of your friends who have installed Louden Litter and Feed Carriers, come to the conclusion that you could not get along without them.

Stop Stable Drudgery

Labor costs money. Whether you clean your barn and feed your stock yourself or hire it done, you cannot afford to waste the time and energy



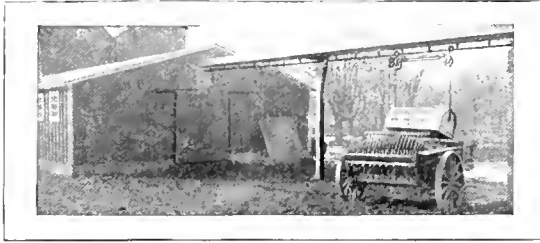

Why You Should Buy Louden Carriers

Because they are the best. This is a "look-you-square-in-the-eye" statement of facts. We know they are the best because we have made a life study of overhead carriers. We own the first patent issued by the United States Patent Office on Litter Carriers. We have studied and experimented constantly, with a full and complete knowledge of the requirements to make our carriers perfect. Whenever we find an improvement possible we make it. We discard undesirable features. Our patents to-day cover practically every valuable feature on litter carriers. They cover many special features which can only be had in Louden Carriers, and without which no carrier can be perfect.

Quality

Quality and workmanship have always been of first importance with us. Our policy of building the best goods possible, and selling them at the lowest prices consistent with good business methods, has built up an enormous trade for us; one which under no circumstances would we take any chance of jeopardizing by allowing goods of an inferior quality or workmanship to leave our factory.

Price

We have never been engaged in the wild scramble to build cheap goods. With us it never has been a question of "how cheap," but always "how good." In making up your mind to install a litter carrier in your barn, bear in mind that it is not for a day, a week or a month, but for years that you want this carrier to work at all times and

to give you good service. That once you have discarded the wheelbarrow you do not want to be compelled to go back to it, while making repairs on a carrier system which was built too cheaply to stand up under the work.

We build carriers of different styles, of different weights of materials, and at a wide variation in price to suit both the needs and the purse of all. But from the highest-price outfit to the lowest price, each one represents the highest standard of excellence—the Louden Standard—and is positively the best value that can be bought at the price.

We invite prospective purchasers to make comparison between Louden Litter Carriers and others. See them both work. Ask the man who is using them. When you have done this with a mind open to conviction, you will join us in saying—"None so good as Louden Carriers."

Let Us Help You

In this catalog we endeavor to make every detail of our different carriers, track and methods of installing, very clear and concise. If after careful reading you should feel at a loss as to the best carrier or the best method of installation to suit your purpose, write us, giving a floor plan of your barn, showing location of stalls, and indicating about where you would wish to run the litter carrier tracks. Upon receipt of this information we will submit a plan of installation suitable for the conditions existing at your barn and will give you an estimate of cost.

No matter how situated, nor how complicated the arrangement, we can install Louden Litter and Feed Carrier equipment to work and give you perfect satisfaction.

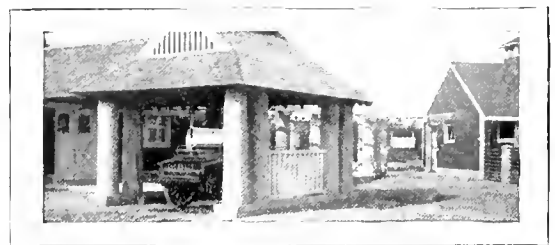
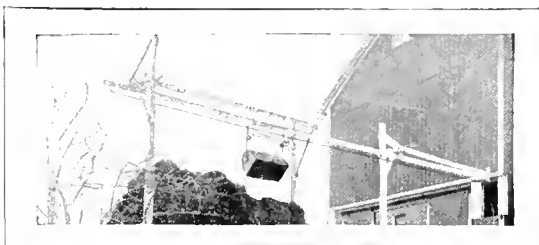

The Kind of Carrier for You

The kind of carrier you will need depends upon the arrangement of your barn, size of barn, number of cattle housed, and the disposition you wish to make of the litter.

In the great majority of cases, one of the carriers operating on a solid steel track will be found the most desirable, but the arrangement of some buildings allows the use of the lighter wire track outfits with satisfactory results.

If it is your intention to drop the litter into a wagon or spreader, or if it is necessary to use many curves or switches, the solid steel track carriers are the only practical kind for your use.

If, however, you simply wish to get the litter out of the barn quickly, running it into a dump some distance away, one of the wire track carriers will answer your purpose.

Following we give a brief summing up of the special features of our different carriers, which may help you to determine which outfit will best suit your purpose. All carriers are described in detail on the pages following.

Litter Carriers

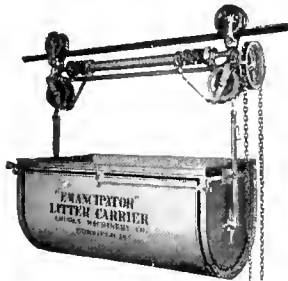

NEW IMPROVEMENT. All Louden Litter Carriers are now equipped with roller bearing track wheels.

EMANCIPATOR. The Emancipator Carrier is the final summing up of all the desirable features which can be incorporated into a Litter Carrier. It is the desirable carrier for use in large dairy barns where the work is heavy. It will stand up under all kinds of handling. Every part is built heavy. If you want the best litter carrier made, place your order for the Emancipator. It will not disappoint you. Full description, page 157.

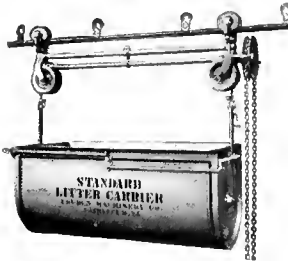

STANDARD. This is the old reliable, the first Litter Carrier placed on the market using a worm gear hoist. It is a little lighter than the Emancipator, uses cables for supporting the box instead of chain, and can only be raised a distance of $4\frac{1}{2}$ or 5 feet, so is not so desirable for buildings with high ceilings. Where ceilings do not exceed 8 or 9 feet in height, no better value can be bought than the Standard Carrier. See page 161.

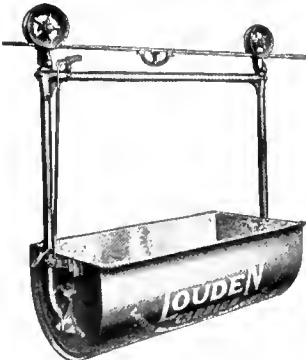

SELF-ACTING. The strongest, best behaved litter carrier ever built to run on a wire track. If you simply want manure conveyed from the barn to the yard and piled there, load it in this carrier and give it a shove. It will run out, empty itself and come back. This carrier can also be emptied into spreader or wagon, but requires a little more head room. This is a very popular carrier. See page 163.

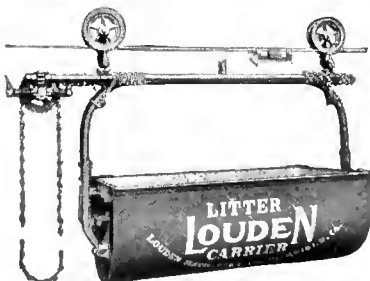

QUICK OUT. The Quick Out Carrier is a combination of many of the good points of the Emancipator and Standard Carrier with the automatic quick return of our Self-Acting Carrier. It runs on wire track and has improved raising and lowering device. Can be used to empty litter into wagon or spreader, or to be operated automatically. These carriers require no posts in the yard, unless track is over 100 feet long. This carrier described fully on page 162.

Feed Carriers

NEW IMPROVEMENT. All Louden Feed Carriers are now equipped with roller bearing track wheels.

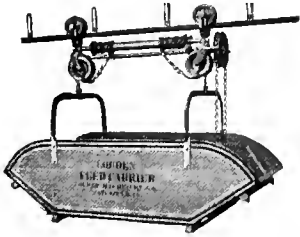

DOUBLE END FEED CARRIER. The largest feed carrier we make. It is built with sloping shovel board at each end so two men can work at the same time. It is the carrier for heavy work; is the best carrier for all barns, and particularly desirable where you are feeding more than twenty head of animals. The carrier is strongly reinforced in all parts. It is built to stand heavy work and give long service. See page 167.

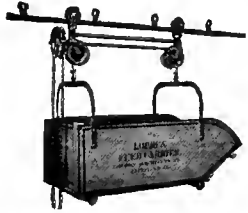

SINGLE END FEED CARRIER. If one man is doing the feeding, this carrier is the right one for all barns. It is easy to handle; can be furnished with any style of hoisting gear, and is a handy all-around feed car; is suitable for carrying silage from silo to feed alley, or for carrying corn or other grains to bunkers or feed troughs. Carrier is strongly built of the best materials. Description on page 168.

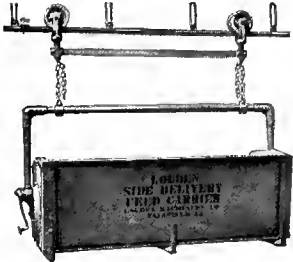

SIDE DELIVERY FEED CARRIER. This carrier was designed to meet the demand for a carrier to be used where feed is to be distributed in feed bunkers or on feeding floors. It is so arranged that the feed box can be tilted over sideways allowing feed to pour out a little at a time or feed can be scooped out easily. It is easily handled and is a great saver of time and labor. See page 170.

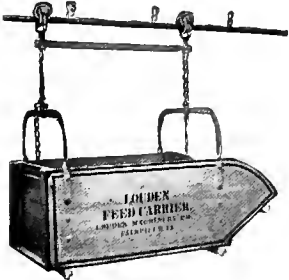

ADJUSTABLE FRAME FEED CARRIER. This carrier is attached to the truck with a chain and may be hung high or low as required. It fills every requirement where it is not necessary to raise or lower the box during feeding time. The materials used in the manufacture are the same as in other Louden Feed Carriers. The raising and lowering chains are quickly adjusted. See page 169.

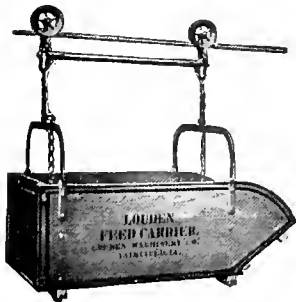

WIRE TRACK FEED CARRIER. This carrier has the chain adjustment for accommodating the carrier to the height of the ceiling, and is built for a wire track. No wire track carrier on the market is more satisfactory. The box is the same as those we use on our other carriers. Full description on page 169.



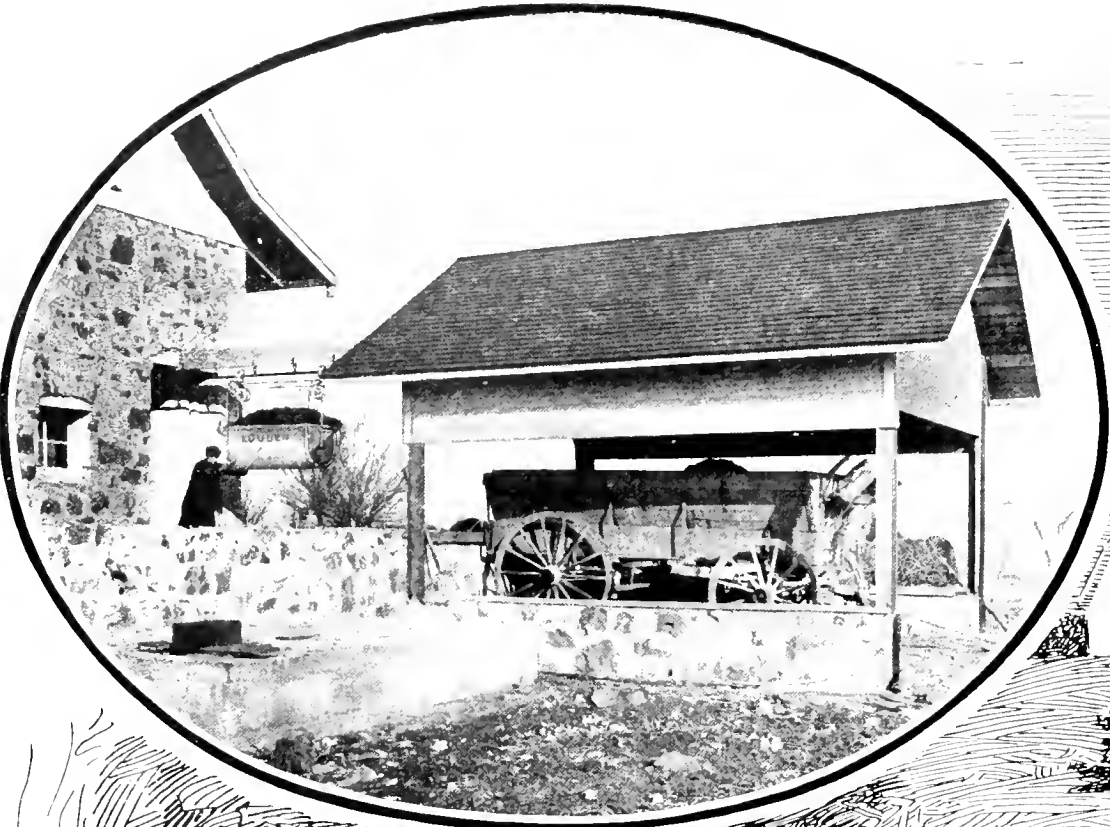

**TWO WAYS OF HANDLING
BARNYARD MANURE**
Above: No Waste, Less Labor, Only
One Handling with a Louden
Carrier.
Below: Wasteful, Unsightly, Insani-
tary.

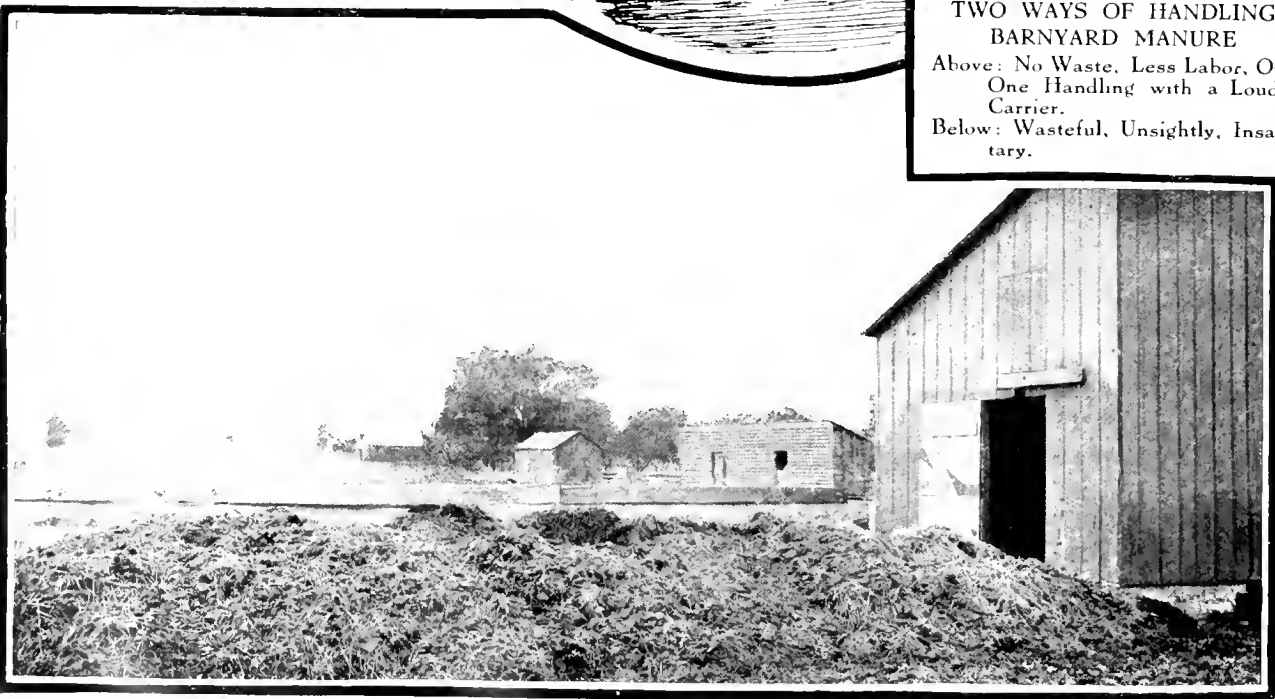

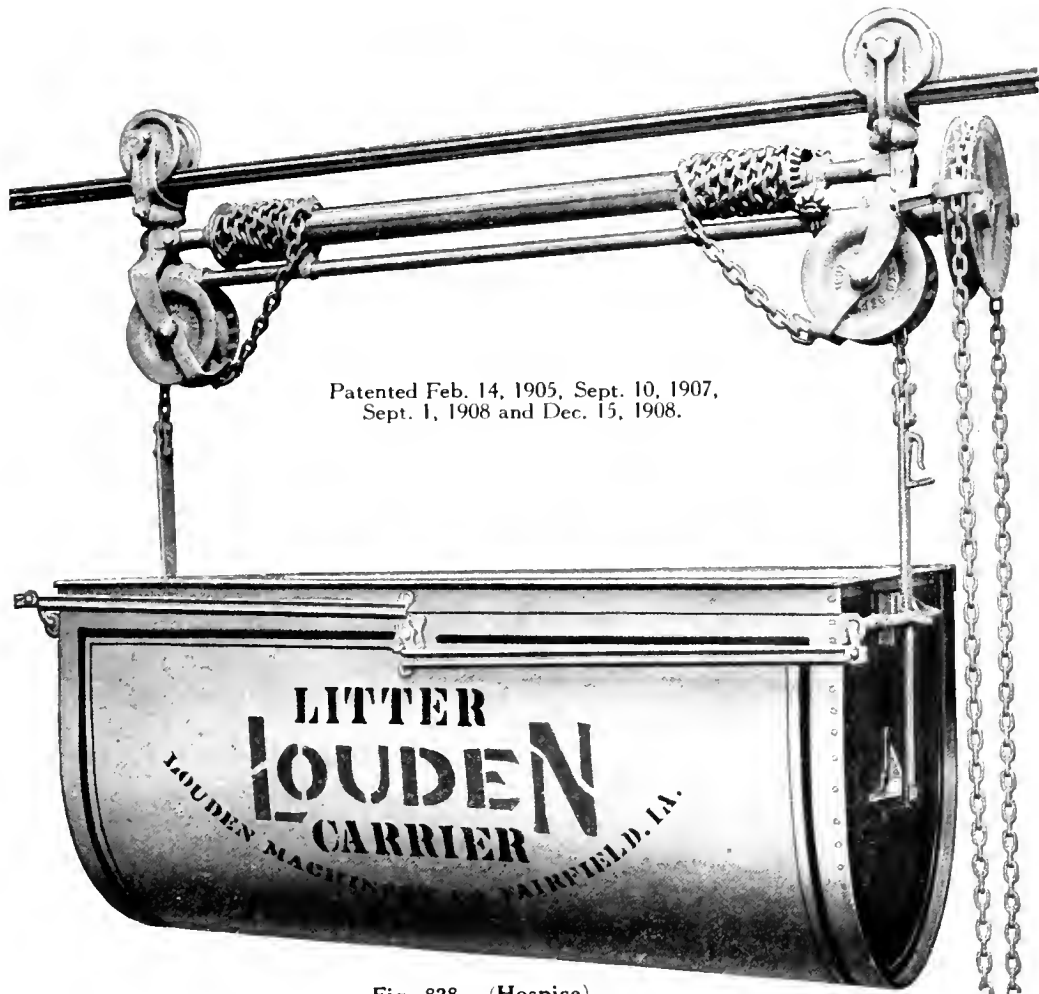

Patented Feb. 14, 1905, Sept. 10, 1907,
Sept. 1, 1908 and Dec. 15, 1908.

Fig. 828. (Hospice).

Emancipator Litter Carrier—Fig. 828

Specifications

Operates on Louden Double Bead steel track Fig. 571. (For track fittings see pages 175 to 183.)
 Body of box is made of 20 gauge galvanized sheet steel, reinforced with angle iron.
 Ends of box are made of 16 gauge galvanized sheet steel.
 Length of box, 48 inches; width, $27\frac{1}{8}$ inches; depth, 22 inches, outside measurements. Capacity, 10 bushels.
 Box is fitted regularly to raise and lower 7 feet; may be fitted to raise and lower as much as 20 feet at slight additional cost.
 Track wheels are roller bearing.
 Diameter of track wheels, 4 inches.
 Clearance necessary for track wheels, 5 inches.
 Total clearance necessary, box upright, 50 inches; box dumped, 56 inches.
 Length of hand chain, 11 feet, ends joined together. Where ceilings are high, longer chains can be furnished at slight additional cost.
 Shipping weight, 208 pounds.

In a litter carrier the demand should be for dependable, long continued service and safety, together with ease of operation and convenience as these features are essential. Study carefully the construction and design, then consider the factory which makes the carrier, and the reputation it bears for quality and square dealing.

The Louden Emancipator Litter Carrier is the acme of years of study and experiment; the result of Louden experience and Louden determination to manufacture the best barn equipment on earth.

It is made for the man who wants the best, who is satisfied with nothing short of perfection.

There is no other carrier like it; no other carrier that has the same strength, symmetry, lifting power, or ease of propellment along the track. No other carrier has the exclusive special features of the Emancipator, without which any litter carrier falls short of perfection.

As has often been said, "The best evidence of worth is the name of the maker." The Louden Machinery Company is too well established, too well known, and too proud of its reputation for quality and square dealing, to offer any product that is not satisfactory and SAFE.

Hoisting Device

We discarded all clutches, brakes and ratchets in connection with litter and feed carriers years ago. We own the first patents issued on litter carriers, but thorough tests so clearly proved the superiority of our present construction that we threw away all the old style models and are offering only those which we know to be absolutely trustworthy.

It makes the lowering and raising of the box so easy that with the same effort practically double as much can be raised as with any other hoisting device. A boy can raise a bigger load with this device than can a man with any other litter or feed carrier. A lifting chain of sufficient length to raise and lower the box seven feet is furnished regularly, but at small additional cost the carrier can be equipped to hoist twenty feet.

The wheel "A" (see illustration) is the wheel over which the hand chain passes. This chain is endless, like the chain on a bicycle, and the links fit snugly over the sprockets in the wheel. The axle of wheel "A" revolves with the wheel, and a thread—the worm—turns just as fast as you turn wheel "A" with the hand chain. Now examine wheel "B". It has lugs, or pins, all around, into which the worm threads fit, and when these threads begin to turn as a result of pulling on the hand chain the advantage you gain over the load is enormous. It permits a one pound pull on the chain to raise forty in the box. This is the greatest leverage giving principle ever discovered.

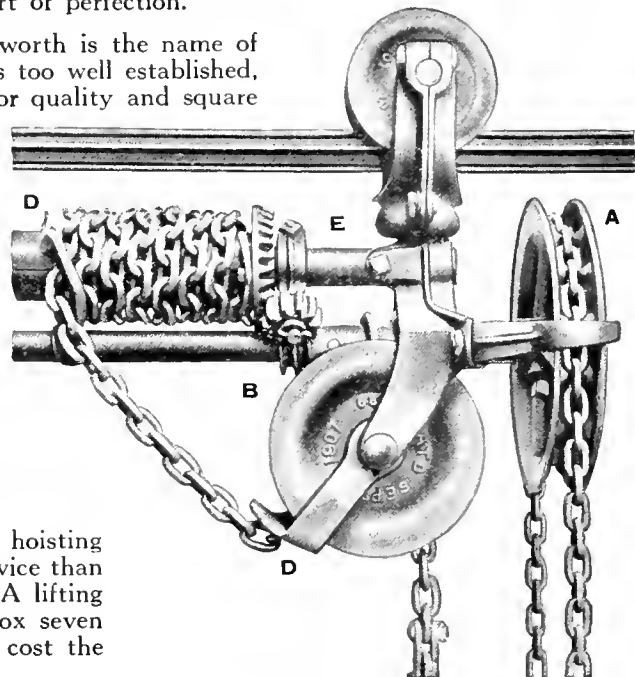

Fig. 881. The Emancipator Hoisting Gear.

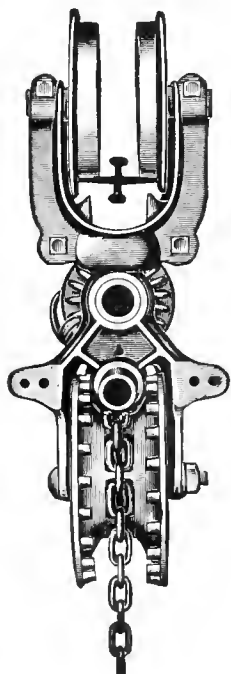

Fig. 885.

Another exclusive Louden feature is the way the lifting chain operates. This, like other Louden features, is the result of 48 years' study, and it eliminates all possibility of the carrier box dropping too quickly. It also does away with troublesome ratchets and brakes that would make its use by careless help a constant danger.

It will be seen in the illustration how the lifting chain is attached to the carrier box, how it runs over the pin wheel "B" and up to and around the drum. This lifting chain CANNOT run unless there is a pull on the hand chain. The lifting chain, the hand chain and the worm MUST work in unison.

The chain guides (or floats) "D" on both the wheel and the drum, work perfectly and always keep the chain even and fitting snugly. Everything is mechanically correct and is tested thoroughly before leaving the factory.

Still another exclusive Louden feature is the extra strong swivel joints "E" which connect the track wheels to the frame, and which support the weight of the load. Instead of using an ordinary bolt that bends and gets out of shape after a little usage, we use a heavy swivel knee joint, the bearing surface of which is $2\frac{1}{8}$ inches in diameter. This swivel joint permits the carrier to round curves as easily as it runs on a straight track. There is no sticking or binding or heavy friction to overcome.

The track wheels are set as far apart on the track as possible. This does away with the unsteadiness and "jerkiness." The wheels are large—four inches in diameter—are roller bearing and run smoothly on the track. The wheels turn on

special tempered steel axles $\frac{7}{8}$ inch in diameter. The axles are bolted into the supporting casting full size and no weak shoulders. The wheels are strong enough to carry tons more than will ever be required in a litter carrier. The flanges of Louden Track Wheels are made so that each flange has two bearings against the edge of the track, instead of one which ordinary wheel flanges have. This prevents the wheels from wobbling on the track. This is a valuable, patented and exclusive feature. The Louden Double Bead Steel Track (Page 175) used with the Emancipator Litter Carrier is made to stand great strains, and is strong enough to carry any load you can pile on the carrier box.

Carrier Box

The Emancipator Carrier Box is built of heavy galvanized steel, reinforced with angle iron. You can't overload it. Fill it full of sand or water, rush it over the track—you can't do it a bit of damage. The box is water tight and will hold every drop of liquid manure; no spilling of liquids along the walk. The most valuable part of the manure is saved. The box is built regularly 48 inches long, $27\frac{1}{8}$ inches wide and 22 inches deep.

Dumping Device

Here again is the Louden Carrier in the lead. This exclusive arrangement was adopted after thoroughly testing and discarding other plans.

The box is hung to the exact fraction of an inch to make the balance most perfect. The trip lock in the end of the box is adjusted so that it is impossible to dump the box unless it is so desired, yet makes it an easy matter to dump the box with a shovel or fork. This trip lock is also arranged so that the box may be dumped with a rope, where the track arrangement used will allow the carrier to run by gravity to manure pit or spreader. The rope can be used to return the carrier to the barn for reloading. The box, on account of its correct balance, can be righted with pitchfork or shovel. No touching with hands is necessary.

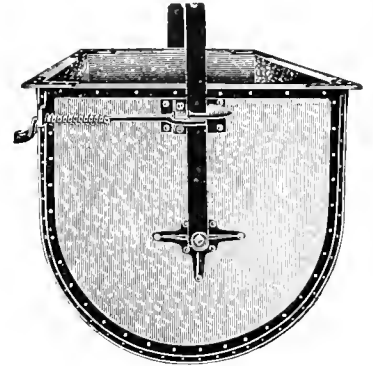
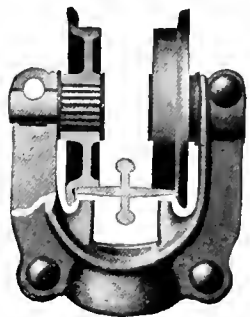

Fig. 723. The Emancipator Box.

The Best For You

If quality, workmanship, durability, and perfection of mechanism count with you, install the Emancipator Litter Carrier. There is none like it; none to compare with it; none that will give you that lasting satisfaction of having made a wise investment. It is tested and true. It is used the world over, and it is backed by the oldest, largest, and best known litter-carrier manufacturer in the world.



Roller Bearing Track Wheels

Each wheel used on our steel track litter carriers is fitted with 17 tempered steel roller bearings. Size of bearings for steel track carriers $\frac{3}{16} \times 1$ inch. These revolve around a $\frac{7}{8}$ -inch cold rolled steel axle or shaft. The ends of the steel roller bearings work against our special patented revoluble washer. This reduces friction to a minimum. Also eliminates excessive wear, prevents binding or grinding together of the rollers. The Louden Trolleys with roller bearings travel easily and outlast any other trolleys of this kind that are made.

Track

The Louden Double Bead Track, Fig. 571 (Page 175), is used with the Emancipator Carrier.

Louden track is stronger, more reliable in use, easier to put up, and is in every other way SUPERIOR to other styles of track used for this purpose. It will not buckle to one side or let the carrier run off as side-hitch tracks will do. We warrant all our goods to be SUPERIOR to anything of the kind on the market, and we do not ask purchasers to keep any article which will not fill the warranty.

A recent test in the Louden factory proved conclusively that, under exactly the same conditions, Louden tracks will carry almost double as much weight as other tracks. Every article bearing the name Louden is far stronger than necessary for practical use and is built that way to handle safely the unusual strain that might be placed upon it.

In speaking of Louden equipment, Walter J. Domes, Crescent Hill Ayrshire Farm, McCoy, Oregon, writes:

"I have been using Louden Stalls and Stanchions and Feed and Litter Carriers for several years and am more than pleased with them. Will install two more carriers this summer.

"Were it not for my Louden equipment I would not be able to keep my herd of 100 registered Ayrshires in the shape they are, nor would I receive the high score I do by the Dairy Inspectors.

"My two cow barns cost me over \$8,000.00 and have several hundred feet of Louden track."

**QUICK BARN CLEANING —
WITHOUT THE DRUDGERY**

Barn Cleaning Is a "SNAP"
With a Louden Litter
Carrier.

It Makes a Pleasant Task of
What Is Commonly the Most
Irkesome Job on the Farm.

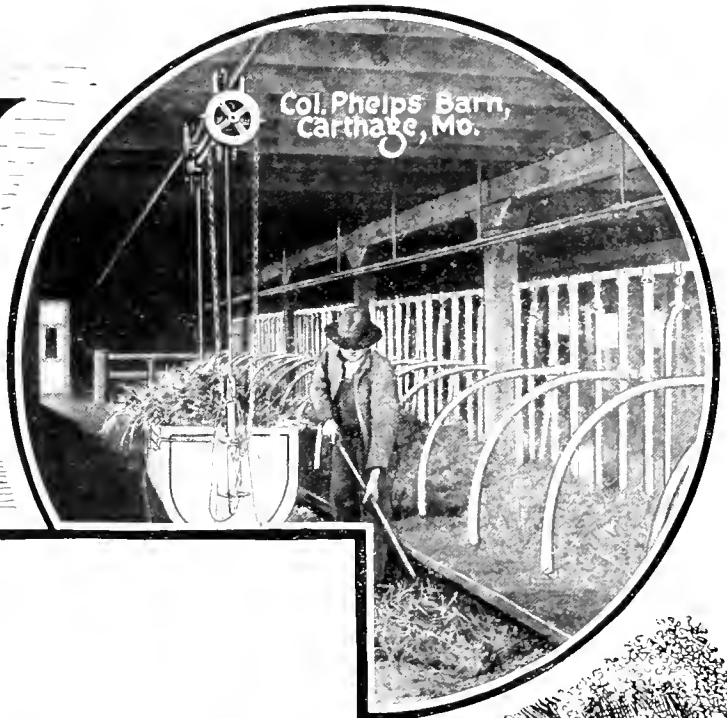

*The Cleaning of These Big Barns on Sedgely Farm, Hinsdale, Ill.,
is Simplified by the use of a*

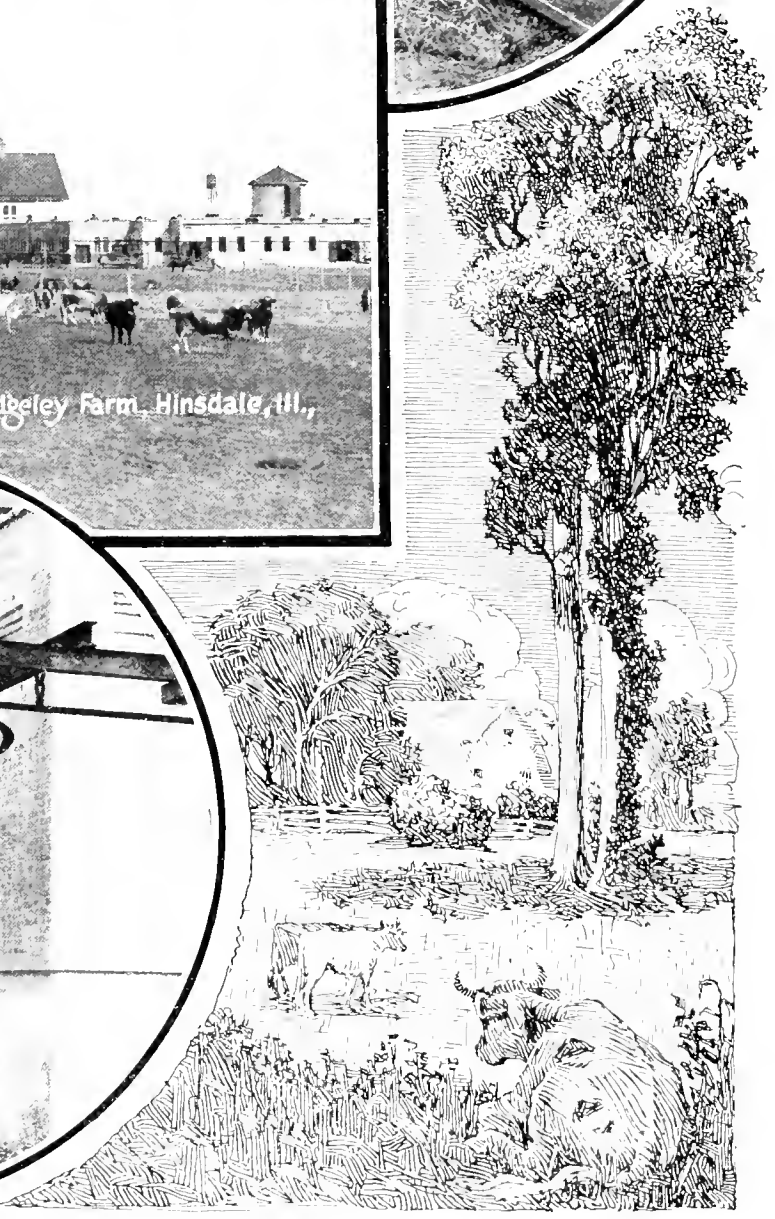
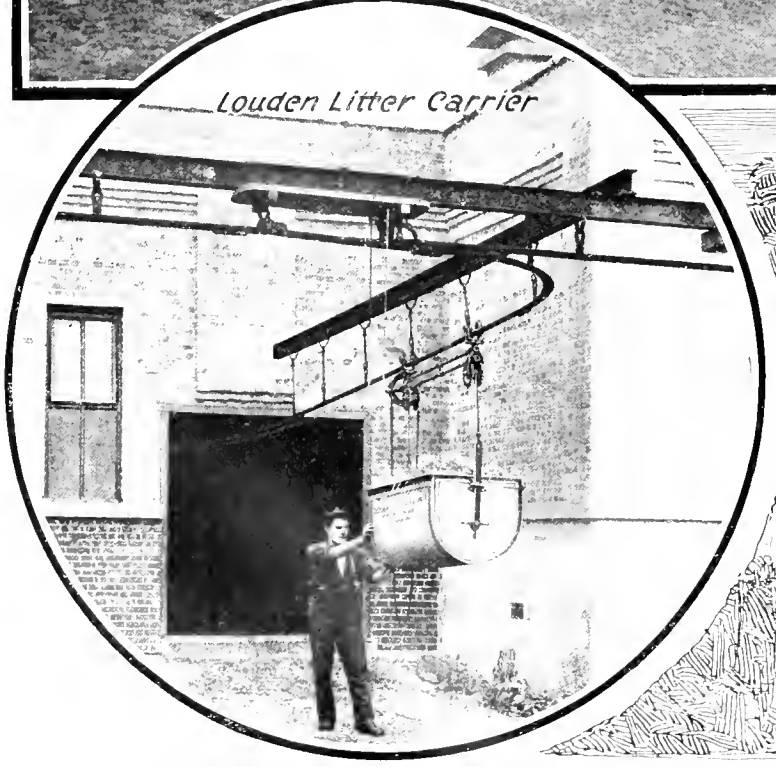

Louden Standard Litter Carrier—Fig. 720

Specifications

Operates on Louden Double Bead Steel Track, Fig. 571. (See pages 175 to 183, for Track and Track Fittings.)

Body of box made of 20-gauge galvanized sheet steel, reinforced with angle iron.

Ends of box are made of 16-gauge galvanized sheet steel.

Length of box, 48 inches; width, 27 $\frac{1}{8}$ inches; depth, 22 inches, outside measurements. Capacity, 10 bushels.

Box is fitted regularly to raise and lower 4 $\frac{1}{2}$ feet.

Track Wheels are roller bearing.

Diameter of Track Wheels, 4 inches.

Clearance necessary for Track Wheels, 5 inches.

Total clearance necessary, box upright, 48 inches; box dumped, 54 inches.

Length of hand chain, 11 feet, ends joined together.

Shipping weight, 185 pounds.

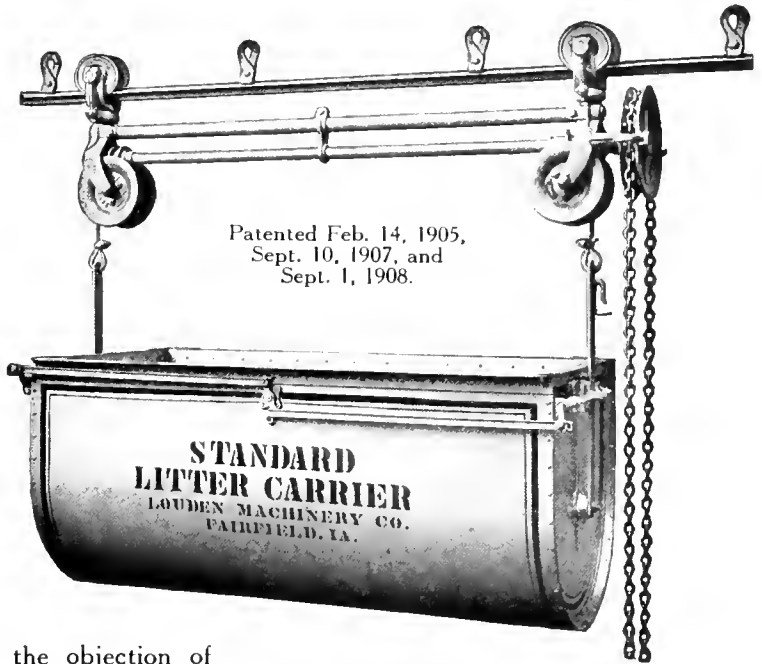

Patented Feb. 14, 1905,
Sept. 10, 1907, and
Sept. 1, 1908.

Fig. 720. (Merkens).

This was the first Litter Carrier manufactured using the worm gear hoisting device. Seeking to overcome the objection of ratchet and lever gear, we planned and perfected this standard carrier. It was the pioneer Litter Carrier in its class, and is today the most popular and best selling Litter Carrier in the United States. The Standard is built along the same lines as the Emancipator except that cables instead of chains are used for supporting the carrier box. These cables wind on drums which form the connection between the pin wheels at each end of the carrier. The drums will carry about five feet of cable, which limits the raising and lowering of the carrier to about 4 $\frac{1}{2}$ feet. (See detailed view, Fig. 722.)

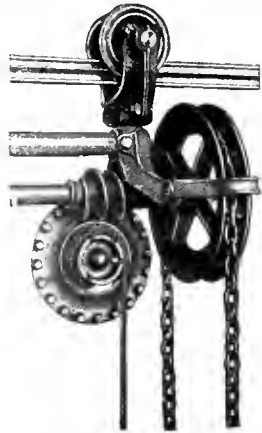

Fig. 722.

Using the worm gear, the same lifting power is secured as with the Emancipator. No ratchets or levers are used and it will stand at any point.

The material used in the construction of this carrier is the same as that used in the Emancipator Carrier. The difference in the two carriers being in the hoisting gear. It is built regularly for our Double Bead Steel Track. Track Wheels are roller bearing.

The same special steel axle with roller bearings for the wheels, the same strong swivel connections for joining the trucks to the main frame, the same connecting bars and the same latching parts as used in the Emancipator Carrier are also used in the Standard Carriers. In all of their vital parts the two carriers are alike in that they have ample strength for any work they will ever be called upon to do.

Louden Machinery Company, Fairfield, Iowa.

Murray, Iowa, May 8, 1913.

Dear Sirs:

The Litter Carrier I bought of you last fall is more than I expected. I have it installed in one of my horse barns which holds fifty head of horses, and it is the greatest labor-saving piece of machinery I have ever bought.

One morning I fed the fifty horses hay and grain and cleaned out the barn in one hour and twenty minutes by myself. If I had used a wheelbarrow to carry out the manure it would have taken me nearly two hours to clean out the barn, and some hired men have been half a day at the same job.

I looked at various other makes of carriers before I bought, but on account of having some of the Louden goods on my farm I was determined to see the Louden Litter Carrier before buying, and when I saw your outfit at the State Fair I was very anxious to buy one because I thought it was far better than any other I had seen. I don't know of any place it could be made better—it works fine.

I have showed the Carrier to a great many people and they have always had words of praise for it.

Yours truly,

Lewis Evans, Prop., Horse Exchange Stock Farm.

Louden Quick Out Litter Carrier—Fig. 882

Specifications

Operates on 0000 Basic Steel Wire Track. (See pages 187-190 for Track Fittings.) Body of box is made of 20-gauge galvanized sheet steel; ends of box are 16-gauge sheet steel strongly reinforced.

Length of box, 42 inches; width, 24 inches; depth, 15½ inches; capacity, 5 bushels.

Box is fitted to raise and lower 3½ feet.

Track Wheels are roller bearing.

Diameter of Track Wheels, 6 inches.

Clearance necessary for Track Wheels, 6 inches.

Total clearance necessary, box upright, 42 inches; box dumped, 47 inches.

Length of hand chain 8½ feet, ends joined together. Where ceilings are high, longer hand chains can be furnished at slight additional cost.

Shipping weight, 125 pounds.

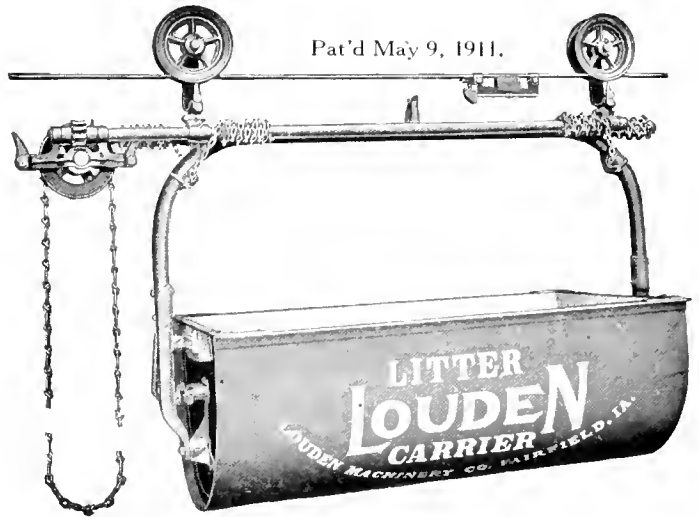

Fig. 882. (Quick).

The Quick Out Carrier is equipped with an improved raising and lowering device.

The lifting power is secured by a worm gear hoist on the same principle used with the Louden Carriers for solid steel track. The main frame consists of two ¾-inch pipe shafts held in position by two heavy malleable iron castings. These castings form heavy, substantial sockets for receiving the swivel yokes which carry the wheels. This forms the swivel knee joint connection between the trolleys and main frame of the carrier (where the entire weight of the load is carried) and is one of the important and exclusive points of superiority found on all Louden Litter and Feed Carriers.

The horizontal pipes stand parallel with each other and about three inches apart. When the carrier box is raised, the bail of the box, which is also of pipe, enters between the two horizontal bars interlocking with them, forming a rigid frame. This prevents any endwise swinging or rocking motion and permits the carrier to be operated automatically a much greater distance than other wire track carriers.

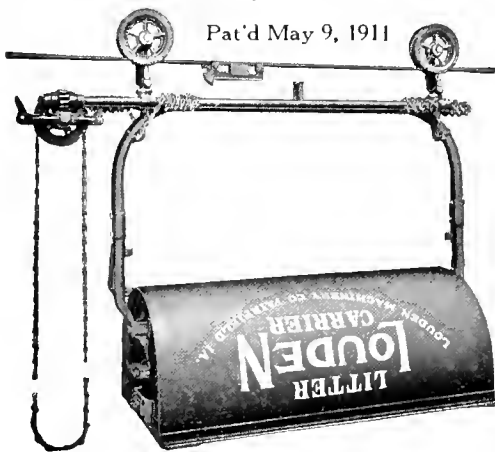

Fig. 883.

Hoisting Gear On Quick Out Carrier

The hoist on the Quick Out Carrier is built on the same principle as the hoisting gear on Louden Carriers for solid steel track. The worm gear gives ample lifting power for the heaviest loads. The box is supported by double chains. The upper ends of the chains are fastened to the two main shafts and the surplus chain winds up on these shafts as the carrier is elevated. Heavy loads can be elevated easily and the double chains give strong support.

Special Features of Louden Wire Track Carriers

The Quick Out Carrier and the Self-Acting Carrier (shown on next page) were designed for use in barns where the work is not so heavy and where the arrangement of track is very simple requiring few switches or curves. These carriers really operate best where the track runs in a straight line. When loaded, a good push will send the carriers out into the yard 60 to 80 feet, where they will empty themselves and return automatically to the barn. The carriers cannot be operated automatically around curves or over switches. Where curves and switches are necessary the carrier must always be followed until the last curve or switch is passed and from that point it can be sent out to the end of the track and will automatically return.

SWIVEL TRUCKS. Both the Quick Out and Self-Acting Carriers are fitted with swivel trucks. This truck frame or supporting frame for

(Continued on page 163)

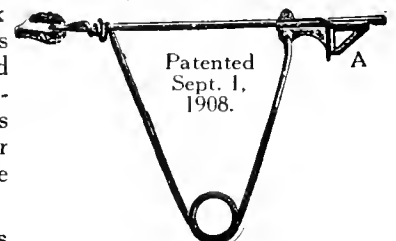

Fig. 753. (Hurl). Spring End Stop.

Louden Self-Acting Carrier—Fig. 721

Specifications

Operates on 0000 Basic Steel Wire Track. (See pages 187-190 for Track Fittings.)

Body of box is made of 20-gauge sheet steel; ends of 16-gauge sheet steel strongly reinforced.

Length of box, 42 inches; width, 24 inches; depth, 15½ inches, outside measurements. Capacity, 5 bushels.

Track Wheels are roller bearing.

Diameter of Track Wheels, 6 inches.

Clearance necessary for Track Wheels, 6 inches.

Total clearance necessary, box upright, 52 inches; box dumped, 57 inches.

Shipping weight, 93 pounds.

The Self-Acting Carrier is like the Quick Out Carrier except it is not fitted with a hoisting gear. Where it is not necessary to raise and lower the load this is the best litter carrier ever made to run on wire track. It will run the easiest and farthest, trip the most positive at any point along the track, and return to the barn without getting off the track.

Where the manure shed can be placed immediately opposite the stable door so the track may be run straight from the barn to the manure shed, or if the practice is followed of piling the manure out in the yard, the Self-Acting Carrier is handy and quick and can be installed at very small expense.

In handling the work you simply shovel the litter and manure into the carrier box and when the box is full get behind the carrier and give it a good strong push out into the yard. The trip which fastens to the track at point of unloading is adjustable and can be moved from place to place. When the loaded carrier reaches the trip the latch on the carrier box is released and the box turns over spilling its load. At the end of the track is the Spring End Stop. This prevents the carrier from running into the post or building at the end of the track and also gives the carrier a start on its return trip to the barn.

The outer end of the track should be elevated about 12 to 18 inches above the inside end—the carrier comes back quickly and smoothly. While the carrier is making the trip out to the shed or yard, the man in the barn is busy getting ready for another load. It makes quick, easy and satisfactory work.

THE FRAME. The frame of the carrier is solidly constructed of heavy inch pipe, held together at the ends by a double set of malleable iron corner clamps. These clamps form the swivel socket into which fit the lower end of the yokes carrying the wheels. This forms the strong, easy working swivel knee joint between the carrier trucks and the main frame where the weight of the load hangs, and which is found on all Loudon Carriers.

(Continued from page 162)

the carrier wheel is of heavy malleable iron. At the upper end of this casting is fitted the steel axle on which the wheels turn. At the lower end the truck is joined on to the main frame of the carrier by means of a swivel joint—one of the strong features in all Loudon Carriers. On the upper side of the truck there is a small keeper which prevents the wheels from getting off the track. These special swivel trucks allow the carriers to be operated around very short curves and over switches.

THE WHEELS. The wheels are made of best quality of gray iron. They are 6 inches in diameter. The wheels have deep wide grooves, turned perfectly true, and these are supplemented by a small groove in the middle to fit the wire. The small groove holds the wheels in line and prevents the wobbling motion which so greatly retards speed, and which is a serious objection in other makes of wire track litter carriers. The spokes in the wheel are heavy, and the wheels turn on roller bearings.

ROLLER BEARINGS. The wheels are fitted with our special case

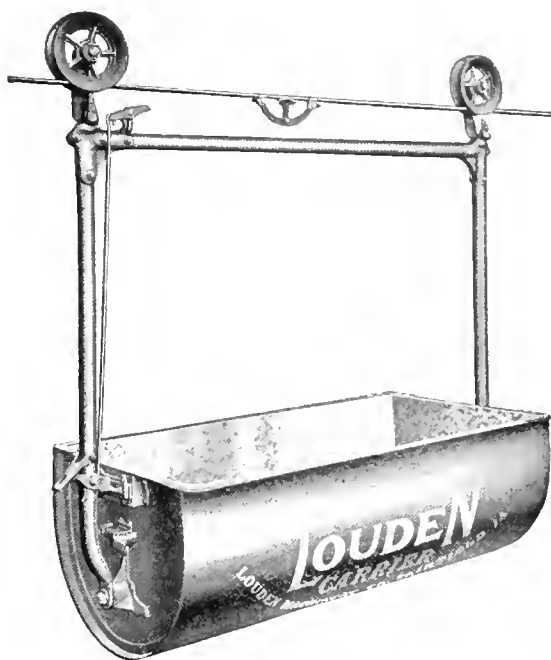

Fig. 721. (Hymn).
Patented Oct. 6, 1908.

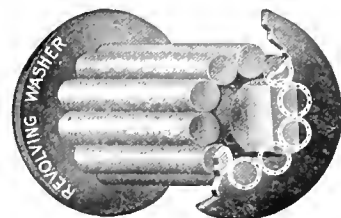

Fig. 19.

hardened steel roller bearings. These bearings are of the finest steel, turned perfectly true. Fifteen of them in each wheel revolve around a tempered steel axle. On each end of the axle (see Fig. 19, page 163) there is a revolving washer which prevents the friction that would be produced if the ends of the rollers were allowed to rub against the castings. This is one more important Louden improvement covered by our patents. Our wire track carriers can be operated a greater distance with less exertion than any other light carrier made.

THE BOX. The box for both the Quick Out and Self-Acting Carrier is made 42 inches long. It is 22 inches wide and 15½ inches deep. The ends, sides and bottom of the box are made of high-grade galvanized iron, reinforced by strong angle iron at the upper edges.

SPRING END STOP. An important improvement with our Wire Track Litter Carrier is the patent Spring End Stop. (See Fig. 753, page 162.) This end stop not only prevents the wheels from jumping the track no matter how hard the carrier may be running, but it also starts the carrier back on its return trip.

THE TRIP. The trip for both the Quick Out and Self-Acting Litter Carrier is adjustable. The trip can be placed on the track at any point, and can be moved from place to place on the track without removing any bolts. In fact the position of the trip may be shifted from the ground with a fork or shovel handle.

The trip for the carriers is so arranged that when carriers reach the trip the latch on the end of the box is released, allowing the box to turn over and empty its load. Another good feature of our tripping device on the wire track carriers is the fact that when tripped they stay tripped. After striking the trip on the track the carrier box will turn over and can not be latched in upright position until the latch is properly set. The setting of the latch is done without an instant's delay when the carrier comes back to the barn.

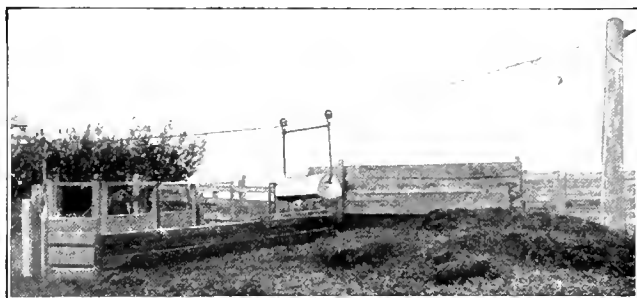

Goes—and Comes Back

Rochelle, Ill.
May 5, 1913.

Louden Machinery Company,
Fairfield, Iowa.

Gentlemen:

In regard to my Litter Carrier, which has been in daily use for 13 months now, I can say it has been a success from the start. It has never failed to dump when reaching trip, nor has it ever failed to come back to door of barn after dumping. A great machine.

M. Sullivan.

Combination Steel and Rod Track for Quick-Out and Self-Acting Carriers

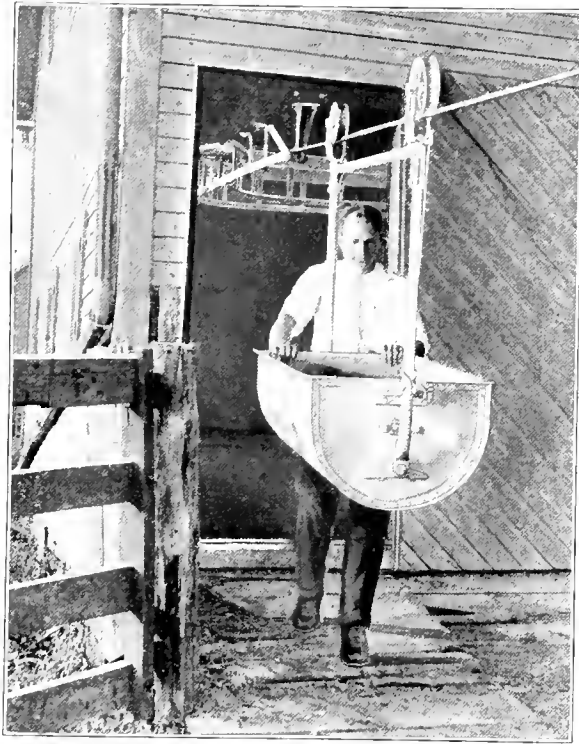

Fig. 1287—Using the Louden Self-Acting Carrier on the Louden Combination Steel and Rod Track

Specifications

Rigid Track

Made of 14 gauge steel, bent "C" shaped to give it great strength and rigidity. Depth, 13 $\frac{3}{4}$ inches; width, 1 $\frac{1}{2}$ inch. Weight per foot, 1 pound. Hangers of malleable iron and strap steel.

Rod Track

Made of 0000 basic steel wire. Diameter 1 $\frac{5}{32}$ inches; weight per foot, 6 $\frac{1}{2}$ ounces. The rod track is anchored to a post in the yard by means of a tension bolt in the same manner as for our regular rod track carriers.

Advantages of Combination Track

Our combination steel and rod track arrangement has many of the advantages of both the steel and the rod track outfits, and is ideal for small barns where a carrier of not more than five bushels capacity is needed.

Rod track is not satisfactory inside the barn where curves and switches are used. The steel track used in our combination track arrangement is more substantial and rigid, and does not subject the barn timbers to so great a strain as does the rod track.

With the advantages of the steel track in the barn this arrangement combines the advantages of the rod track in the yard.

It isn't necessary to follow the loaded carrier into the yard. A strong, steady shove will send it out from fifty to one hundred feet, where it dumps automatically at any desired point and returns to the barn by gravity. This feature saves time, and is especially appreciated in bad weather, or when the yard is muddy.

The Louden combination track arrangement does not require a special carrier or special track wheels. Either the Quick-Out Carrier, page 162, or the Self-Acting Carrier, page 163, may be used. If you already have one of these carriers installed in your barn with complete rod track arrangement, and wish to substitute the combination track, you may do so without making any change in the carrier.



Fig. 1293
Cross Section of Track
Exact Size

Construction and Installation of Track

The rigid track is made of 14 gauge steel, bent in the shape of a letter "C." This form gives it ample strength and rigidity for any load that can be placed in either of the carriers that operate on it. Fig. 1293 shows a cross section of the track, exact size.



Fig. 1288
Hanger for
Combination
Track

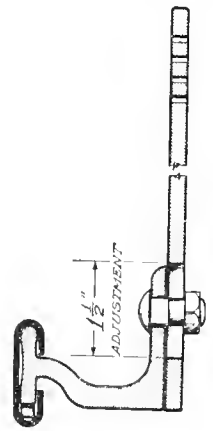

Fig. 1289
Cross Section of
Combination
Track and Hanger

Combination Steel and Rod Track—Continued

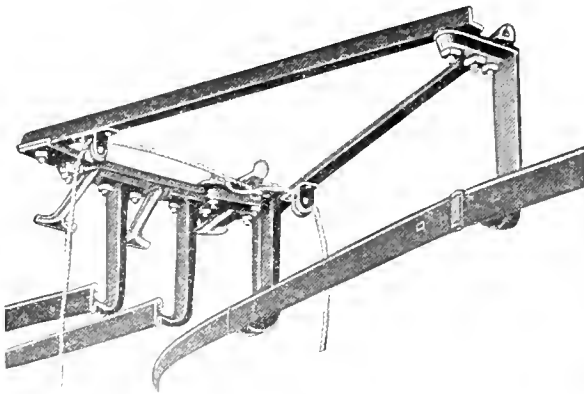

Fig. 1296
Three-Way Switch for Combination Track

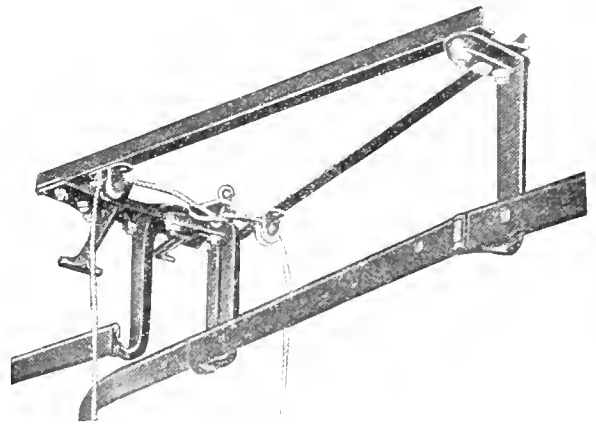

Fig. 1297
Two-Way Switch for Combination Track

The track hanger consists of two parts, connected by a short bolt, between which there is an adjustment of $1\frac{1}{2}$ inches to take care of any unevenness in the joists to which the track is hung. This adjustment is secured by means of a slot (Fig. 1289) in which the connecting bolt may be set at any point desired. The hanger provides eight inches clearance between track and joists when the adjustment is at center.

The lower part of the hanger fits inside the track, as shown in Fig. 1289. The support is immediately beneath the wheels of the carrier; no chance for the track to buckle with a heavy load. All the hangers required for each section of track are slid into the track from the end before it is hung. The hangers are small enough to work loosely inside the track, and are easily adjusted.



Fig. 1290
Brace for Combination Steel and Rod Track

A wedge-shaped key is furnished for each hanger. When the hanger is in place the key is dropped into the track and driven under it, as

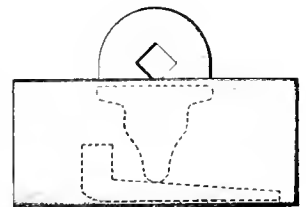

Fig. 1291
Showing How Hanger is Wedged

shown in Fig. 1291. This prevents rattling and allows no end play in the track. The keys are easily removed at any time.

The upper part of the hanger is made of $1\frac{1}{4} \times 1\frac{1}{2}$ inch steel. The lower part (which fits inside the track) is made of malleable iron. The hanger is secured to the joist by means of four nails or screws.

The rod track is connected to the rigid track just inside the door opening by means of a malleable clamp, $7\frac{1}{2}$ inches long, and is secured by bolts, as shown in Fig. 1292. Two of these bolts pass through the brace shown in Fig. 1290, bringing all of the strain from the wire track on the brace, and not on the rigid track.

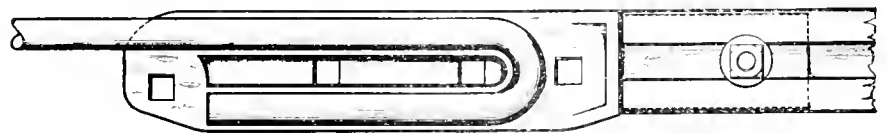

Fig. 1292—Side Removed To Show How Steel and Rod Tracks Are Joined.
No Chance To Pull Apart

The track is smooth at the point of transfer and does not jostle the carrier as it passes from the steel to the rod track.

The brace (Fig. 1290), is 64 inches long, and provides the most secure anchorage ever devised for a rod track. The heavy casting to which it is connected at the lower end is bolted through the door jamb, as illustrated. It allows 8 inches clearance between the jamb and the track.

The rod track is anchored to a post in the yard as described on page 188.

Louden Double End Feed Carrier—Fig. 845

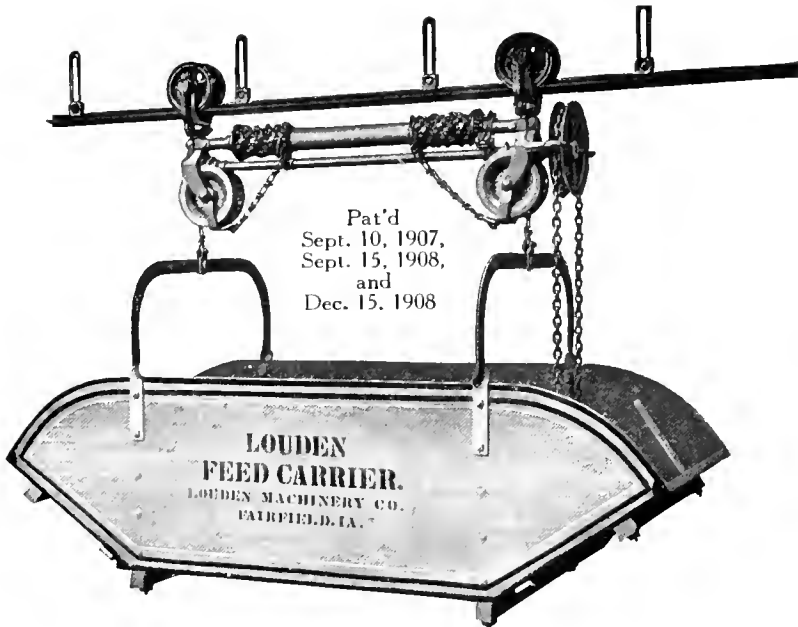

Fig. 845. (Turbin).

Specifications

Operates on Louden Double Bead Steel Track, Fig. 571. (See pages 175 to 183 for Track and Track Fittings.)

Box is made of wood, reinforced with strap iron.

Length of box, 76 inches; width, 29 inches; depth, 20 inches, outside measurements. Capacity, 14 bushels. Box is fitted regularly to raise and lower 7 feet; may be fitted to raise and lower as much as 20 feet at slight additional cost.

Track Wheels are roller bearing.

Diameter of Track Wheels, 4 inches.

Clearance necessary for Track Wheels, 5 inches.

Total clearance necessary, 56 inches.

Length of hand chain, 11 feet, ends joined together. Where ceilings are high, longer chains can be furnished at slight additional cost.

Shipping weight, 230 pounds.

Feed Carriers

There are a great many advantages in having a Feed Carrier. A carrier can be run under the silo chute or spout from grain bins, and enough feed loaded into the carrier to feed 20 or more cows or other stock. With a feed carrier operating on an overhead track you always have clear right of way, with no obstructions to hinder or take time in removing. You can run the carrier along the feed alley in your barn, or out over the feed bunks in the yard, distribute the feed and get through with that part of the work in less than half the time it would take you otherwise. If you are weighing your feed, attach your scales to the carrier frame and weigh out the feed as you go along. If you are feeding a balanced ration, partitions can be placed in the carrier at small extra cost, so two or more kinds of feed can be handled at the same time.

You will often find it convenient to have your feed track connected by means of switches with the track for the litter carrier. By doing this you can get your feed carrier to all parts of the stable, through narrow alleys, and where it would not be possible to operate a truck running on the floor. The tracks for Louden Feed Carrier and Litter Carrier are the same, and can be connected up to secure any sort of track arrangement your building may call for.

Louden Double End Feed Carrier

The Louden Double End Feed Carrier is a large carrier, built extra strong for heavy work. Each end of the carrier has a sloping shovel board, so two men can work at it handy. The carrier is furnished regular with the Louden Emancipator Worm Gear Hoisting Device. The carrier can be furnished and used, however, with any type of Louden Hoisting Gear and Trolley. The Emancipator Worm Gear Hoisting Device is the same as that used with the Louden Emancipator Litter Carrier, and is the most powerful lifting device used with any carrier. One man can easily raise and lower 600 or 800 pounds. The track wheels being large and roller bearing, the loaded carrier can be pushed along the track with scarcely an effort. There are no brakes or ratchets to bother with, and absolutely no danger of the carrier dropping down and smashing.

The Hoisting Device

The Worm Gear Hoisting Device, used with all Louden Carriers, is a marvel of efficiency and simplicity. The worm castings are riveted solid to the main shaft. These engage the pins or lugs on the special sprocket or pin-wheel, causing it to revolve. This gives a lifting power at the ratio of 40 to 1. One pound pull on the hand chain will lift 40 pounds in the carrier box. (See Fig. 881, page 158.)

Sprocket Wheel and Chain

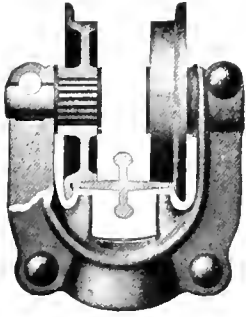

The carrier box is supported by chains. These chains operate over the special sprocket wheels, the surplus winding up on the storage drum. The carrier is fitted regular with chains 7 feet long. On special orders the carriers can be fitted with chains permitting the box to be raised and lowered any distance up to 20 feet. The chains are a special electric weld. Each link is true, they fit the sprocket perfectly, and there is no chance for the chain to slip or for anything to give way.

Trucks and Wheels

The wheels are 4 inches in diameter at the tread, and are reinforced and strengthened by heavy webs. The castings supporting the wheel are extra strong, and are attached to the main frame by heavy knee joint swivels. The bearing surface of this heavy swiveled joint is $2\frac{1}{8}$ inches in diameter. It is the strongest connection between the main frame and truck castings used on any carrier. The large track wheels cause the loaded carrier to travel along the track easily and smoothly. The trucks and wheels on the Double End Feed Carrier are fitted for Louden Double Bead Steel Track.

The Feed Box

The feed box is made with regular box straps, and the bottom is tongued and grooved like a wagon box. The corners are bound with iron and the upper edges have regular wagon box straps. They are well constructed throughout, and are warranted superior to anything of the kind on the market. The box is 76 inches long, 20 inches deep, 29 inches wide, and will hold 15 to 18 bushels of feed or grain.

Construction of Track Wheels

Each wheel used on our Steel Track Feed Carriers is fitted with 17 tempered steel roller bearings. Size of bearings for steel track Carriers, $\frac{3}{16} \times 1$ inch. These revolve around a $\frac{7}{8}$ -inch cold rolled steel axle or shaft. The ends of the steel roller bearings work against our special patented revolvable washer. This reduces friction to a minimum. Also eliminates excessive wear, prevents binding or grinding together of the rollers. The Louden Trolleys with roller bearings travel easily and outlast any other trolleys of this kind that are made.

Standard Feed Carrier

Fig. 763

Specifications

Operates on Louden Double Bead Steel Track, Fig. 571. (See pages 175 to 183 for Track and Track Fittings.)
 Box is made of wood, reinforced with strap iron.
 Length of box, 67 inches; width, 29 inches; depth, 20 inches, outside measurements. Capacity, 12 bushels.
 Box is fitted to raise and lower $4\frac{1}{2}$ feet.
 Track Wheels are roller bearing.
 Diameter of Track Wheels, 4 inches.
 Clearance necessary for Track Wheels, 5 inches.
 Total clearance necessary, 55 inches.
 Length of Hand Chain, 11 feet, ends joined together.
 Shipping weight, 210 pounds.

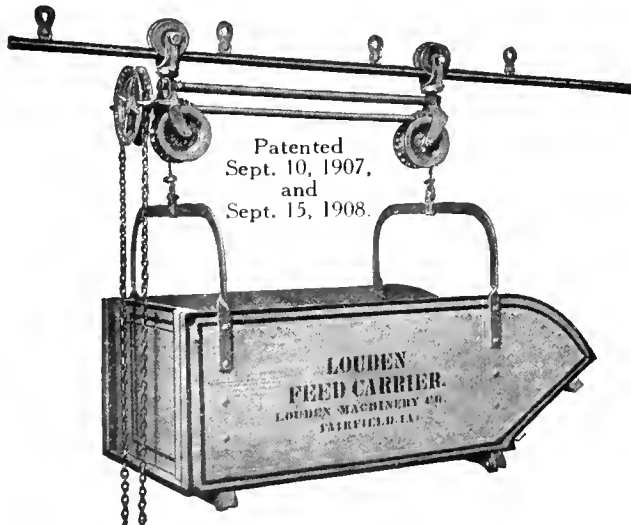

Fig. 763. (Halve).

The carrier is built for long service. The box is made of clear, straight grain, select lumber with heavy, strong reinforcements. The bails which support the box are made of $1\frac{5}{16} \times 1\frac{1}{2}$ -inch steel straps. In addition to offering ample strength for carrying heavy loads, these bails provide a stiff support to hold the sides of the box always in shape.

The carrier illustrated is one of our best sellers and it cannot be recommended too strongly. It is neat, serviceable, and no better single end carrier has ever been offered.

Single End Feed Carrier with Adjustable Chain—Fig. 886

Specifications

Operates on Louden Double Bead Steel Track, Fig. 571. (See pages 175 to 183 for Track and Track Fittings.)

Box is made of wood, reinforced with strap iron.
 Length of box, 67 inches; width, 29 inches; depth, 20 inches, outside measurements. Capacity, 12 bushels.
 Track Wheels are roller bearing.
 Diameter of Track Wheels, 4 inches.
 Clearance necessary for Track Wheels, 5 inches.
 Total clearance necessary, 52 inches.
 Shipping weight, 170 pounds.

Fig. 886 is the same as the Standard Feed Carrier, except that it is fitted with an adjustable, rigid frame, instead of the raising and lowering device, as in some buildings the feed and ensilage is located so it can be reached handily without raising and lowering the feed carrier. The box is supported by chains which permit adjustment for the high and low ceilings. The rigid frame carrier operates around curves and switches the same as the regular carrier and is cheaper.

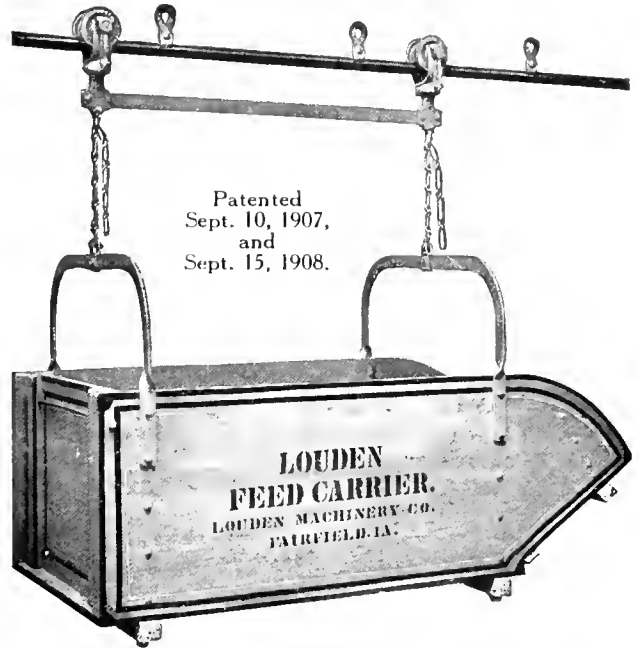

Fig. 886. (Hedge).

Wire Track Feed Carrier—Fig. 887

Specifications

Operates on 0000 Basic Steel Wire Track. (See pages 187-190 for Track and Track Fittings.)

Box is made of wood, reinforced with strap iron.
 Length of box, 67 inches; width, 29 inches; depth, 20 inches, outside measurements. Capacity, 12 bushels.
 Track Wheels are roller bearing.
 Diameter of Track Wheels, 6 inches.
 Clearance necessary for Track Wheels, 6 inches.
 Total clearance necessary, 54 inches.
 Shipping weight, 172 pounds.

Fig. 887 is the same as Fig. 886 except that it runs on wire track. It will run around our special curves and over our special switches for wire track and can be installed for practical work under any condition where a wire track carrier can be used at all. We can furnish special Spring End Stops with latches to catch and hold the carrier at each end, and the carrier can be operated automatically reasonable distances between the silo and the stable or the stable and the feed rooms. This carrier has the chain supports for the box, permitting adjustment for high and low tracks.

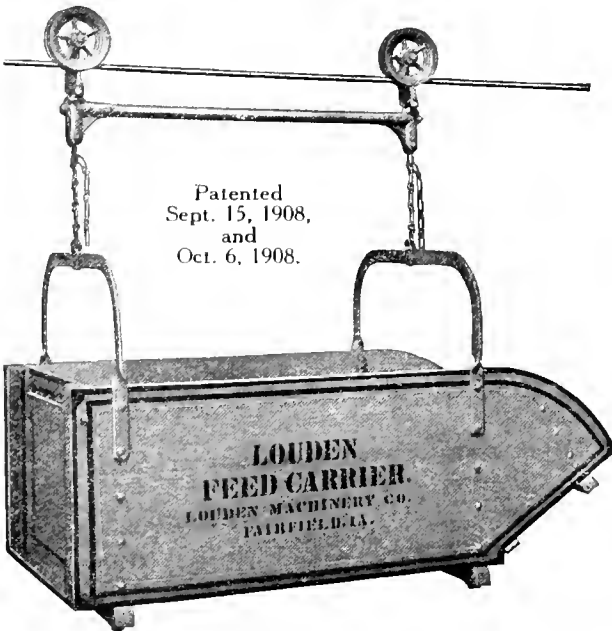

Fig. 887. (Hoard).

Louden Machinery Company,
 Fairfield, Iowa.

Dear Sirs:

I am more than pleased with the Feed Carrier I bought of you. It does all expected of it so far. We use it to carry mill feed and silage for a dairy of seventy cows, and it has never caused a minute's trouble. I consider it a great labor saver in a dairy.

Yours truly,

Geo. H. Keller,
 St. Charles, Ill.

Louden Improved Side Delivery Feed Carrier— Fig. 1042

Specifications

Operates on Louden Double Bead Steel Track, Fig. 571. (Page 175). On special orders can be fitted with any style of Louden Hoisting Gear.

Box made of wood, reinforced with strap iron.

Length of box, 60 inches; width, 31 $\frac{1}{4}$ inches; depth, 21 inches, outside measurements. Capacity, 15 bushels.

Track Wheels are roller bearing.

Diameter of Track Wheels, 4 inches.

Clearance necessary for Track Wheels, 5 inches.

Total clearance necessary, box upright, 53 inches; box dumped, 56 inches.

Shipping weight, 210 pounds.

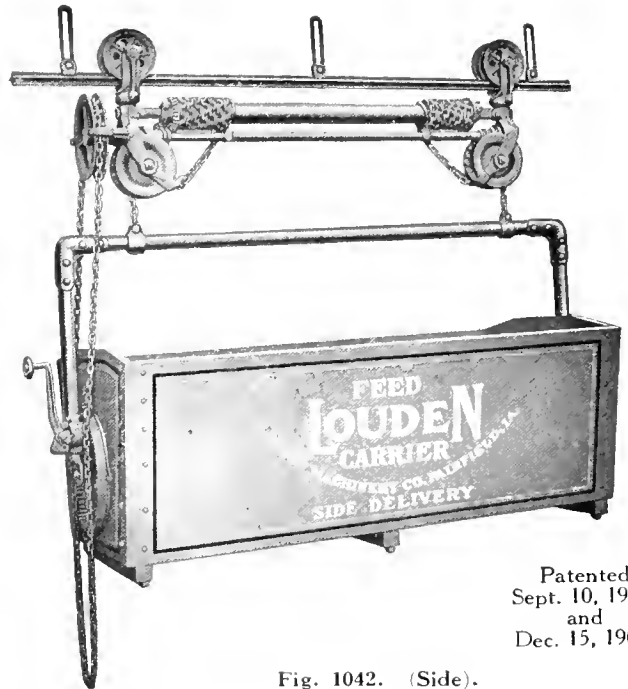

Patented
Sept. 10, 1907.
and
Dec. 15, 1908.

Fig. 1042. (Side).

A side delivery Feed Carrier is, in a number of respects, more convenient than shoveling the feed out of the end of the feed box. Where a large number of stock is to be fed, and it is practical to run the track close enough to the troughs or manger to dump directly from carrier, the Louden Improved Side Delivery Carrier will prove a great time and labor saver. This carrier is especially recommended for out door feeding where it is comparatively easy to arrange the troughs or bunks to accommodate a simple track arrangement.

The gearing is very simple and well arranged and a boy can tip the box when it is full of grain or silage, and do it as safely and satisfactorily as a man. One turn of the crank will tip the box one third way over as shown in Figure 1044, allowing a part of the feed to empty, and will stay there till crank is given another turn, throwing the box half over. Three turns and the box is bottom side up, and three more turns will revolve it all the way around. The crank is pivoted on the end of the axle which carries a small gear that meshes in the large gear secured to the end of the box, and is provided with a spur which springs into the pockets in the face of the castings on which it is mounted, holding the feed box in any desired position.

To rotate the box the handle of the crank is drawn out to release the spur from the pocket. When the operator lets go of the handle a spring throws it in as shown in the cuts, and forces the spur into the nearest pocket.

Like all products bearing the name of Louden, the Improved Side Delivery Feed Carrier is the result of years of study. Each piece of wood and each piece of metal that goes into its construction is the very best for the purpose that money can buy. Louden quality is evident throughout. If you feed a considerable number of stock, this carrier will pay for itself in a short time by labor and feed saved.

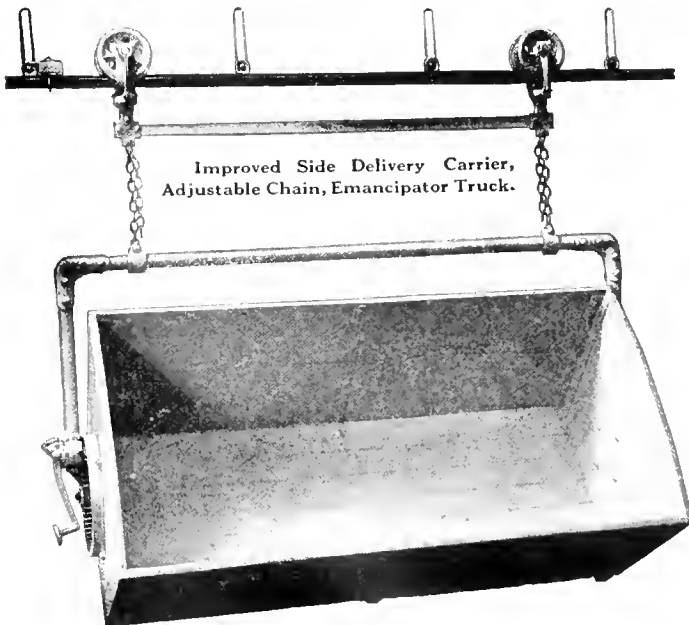

Fig. 1044.

Patented October 3, 1916

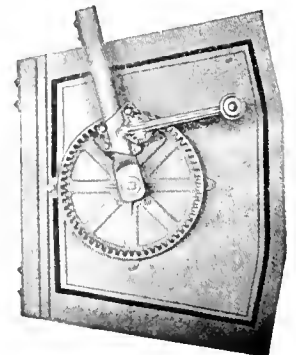

Fig. 1044-A.

Louden Feed Truck—Fig. 973

Specifications

Box made of wood, reinforced with strap iron.

20-bushel size: Length of Box, 86 inches; width, 28 inches; depth, 22 inches.

25-bushel size: Length of Box, 86 inches; width, 28 inches; depth, 26 inches.

The Louden Feed Truck, Fig. 973, is furnished regularly in two sizes, having a capacity of twenty and twenty-five bushels, respectively. This

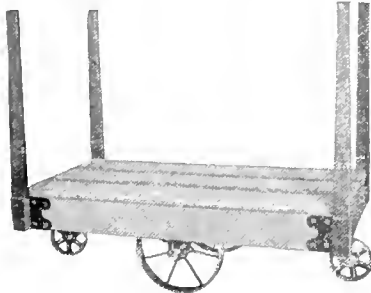

Fig. 1065.

is a thoroughly well built piece of equipment, and is designed to withstand rough usage.

The swiveled small wheels at either end and the large wheels in the center make the Louden Truck easy to handle. It may be moved about with little effort, even with a heavy load, and is so balanced that it can be turned within its own length. The sloping ends of the box make shoveling the feed out easy.

The body of the truck is removable, see Fig. 1065, and four stakes are supplied with each, making a very handy piece of equipment. Fitted with the stakes, it is suitable for handling sacked grain, ground feed, etc.

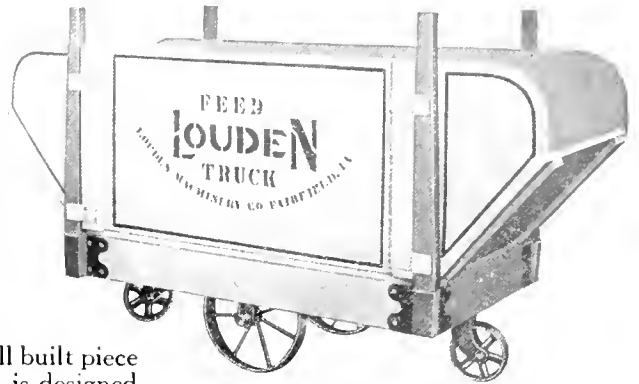
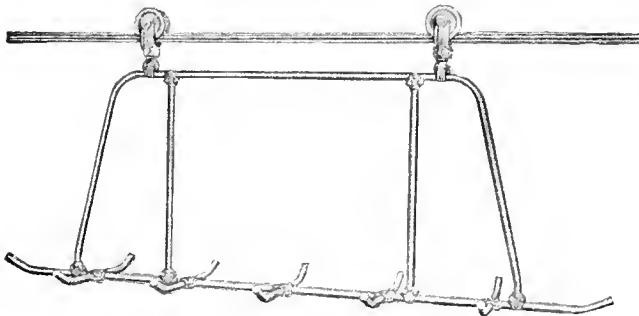

Fig. 973. (Hove).



Louden Harness Carriers

Fig. 1276—12-hook Carrier

Specifications

Length of Carrier, 7 feet.

Total clearance necessary (without harness), 38 inches.

Length of hooks (from tip to tip), 24 inches.

Track wheels are roller bearing.

Weight, 65 pounds.

Fig. 1048—4-hook Carrier

Total clearance necessary (without harness), 26 inches.

Length of hooks (from tip to tip), 24 inches.

Track wheels are roller bearing.

Weight, 16 pounds.

Figures 1276 and 1048 illustrate two inexpensive harness carriers. They operate on roller bearing trolleys like those used in our Emancipator Litter Carrier. The frame and hooks are of tubular steel.

It is desirable in every barn to have a harness room separated from the rest of the barn by solid partitions. The Louden Harness Carrier offers a convenient means of carrying the harness from the horse stalls to the harness room. The trolleys will operate on the same track as the litter carrier or feed carrier. Usually a short switch from the main line of the litter carrier track into the harness room is all the extra track needed in order to install the harness carrier

These carriers will be found handy and convenient in livery barns and in other stables where a number of horses are kept. In farm barns it has always been the custom to hang the harness on pegs or holders immediately back of the horses.

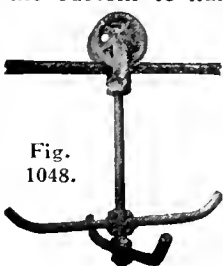

Fig. 1048.

The odors and ammonia fumes in stables are one of the greatest enemies of iron and leather. They attack the iron, causing it to corrode badly and also cause the leather to rot. If the practice was followed of carrying the harness into a separate room closed entirely by means of tight partitions, from the stables where the horses stand, it would stop one of the big leaks on a farm. There could be no easier or handier way of carrying the harness from the room than on a Louden Harness Carrier, and the expense of installing an outfit of this kind is so little that it amounts to practically nothing, in comparison with the saving effected.

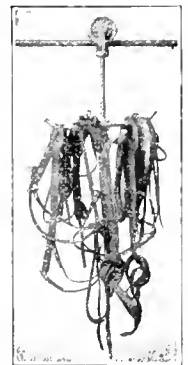

Fig. 1049.

Louden Merchandise Carrier—Fig. 888

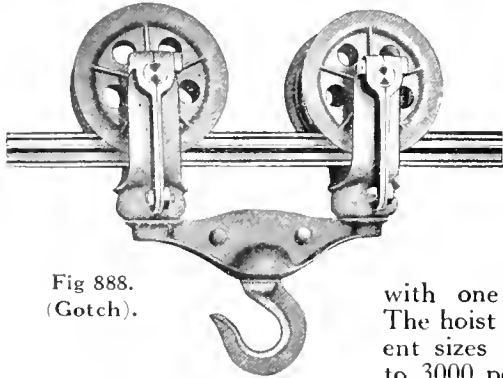

Fig 888.
(Gotch).

Specifications

Operates on Louden Double Bead Steel Track, Fig. 571. (See pages 175 to 183 for Track and Track Fittings.)
Length of Carrier, 15 inches
Track Wheels are roller bearing.
Diameter of wheels, 4 inches.
Clearance required above track, 5 inches.
Clearance from track to bottom of hook, 10 inches.
Shipping weight, 22 pounds.
Carrying capacity, 2000 pounds.
The Hoist and Barrel Grabs are not a part of the Merchandise Carrier, but are sold separately.

Fig. 888 is our new Merchandise Carrier. This carrier is suitable for use in warehouses, storerooms and factories, for moving heavy packages, such as boxes, barrels, machinery, or other heavy merchandise. The carrier is fitted with large track wheels, and heavy truck castings which make it easy to operate on the track while the strong swivel joints insure ample strength. It is built for our Double Bead Steel Track only.

Fig. 889 shows our Merchandise Carrier supporting a load. The barrel is lifted and held suspended at any height

with one of our Perfect Hoists. The hoist can be furnished in different sizes with capacity from 400 to 3000 pounds. Either screw eyes or brackets may be used for supporting the track.

Specifications

Perfect Hoist

Two sheaves above and below.
Diameter of sheaves, 4 inches.
Size of rope which may be used, $\frac{1}{2}$ inch to $\frac{5}{8}$ inch.
Capacity, 1500 pounds.
One man can lift 500 pounds.
Weight (without rope), $11\frac{1}{2}$ pounds.

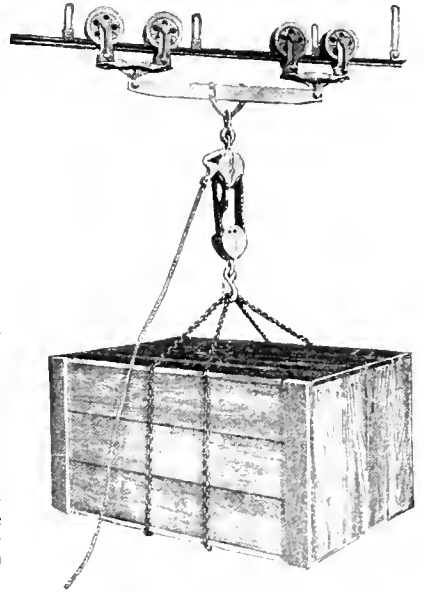

Fig. 890.

Note: The Perfect Hoist is made in 8 styles, having from 400 to 3000 pounds capacity.

Louden Double Truck Merchandise Carrier—Fig. 890

Specifications

Operates on Louden Double Bead Steel Track, Fig. 571. (See pages 175 to 183 for Track and Track Fittings.)
Length of Carrier, 28 inches.
Diameter of wheels, 4 inches.
Track wheels are roller bearing.
Clearance required above track, 5 inches.
Clearance from track to bottom of hook, 15 inches
Shipping weight, $55\frac{1}{2}$ pounds.
Carrying capacity, 4000 pounds.
Hoist and Chains are not a part of carrier, but are sold separately.

Fig. 890 is our Double Truck Merchandise Carrier. This is really two of the regular carriers joined together by a strong connecting bar. It is adapted for use in marble factories, stone quarries, heavy machinery factories, nursery warerooms. The trucks are swiveled, and the carrier can be operated around short curves and over switches and run to any part of building.

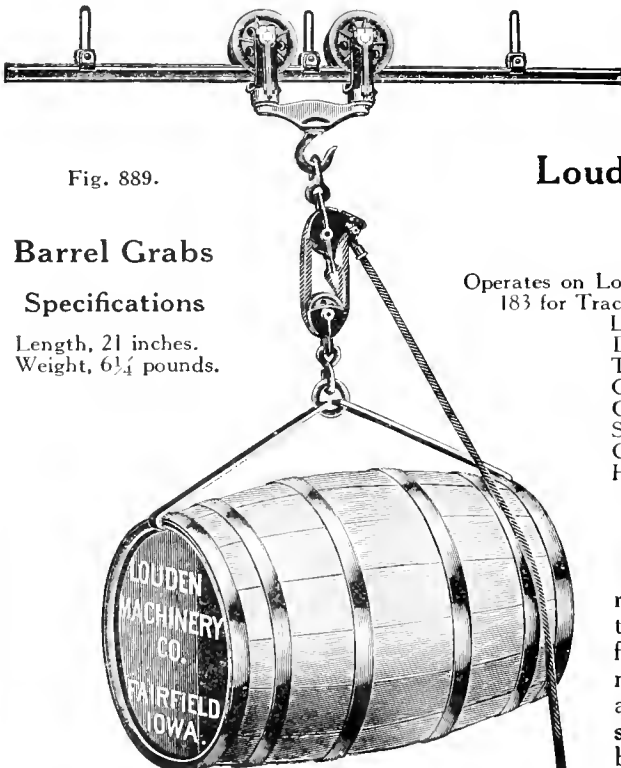

Fig. 889.

Barrel Grabs

Specifications

Length, 21 inches.
Weight, $6\frac{1}{4}$ pounds.

Platform Milk Can Carrier—Fig. 802

Specifications

Operates on Louden Double Bead Steel Track, Fig. 571. (See pages 175 to 183 for Track and Track Fittings.)
Platform made of wood, bound with angle iron.
Length of platform, 56 inches; width, 14 inches.
Capacity, four railroad milk cans.
Track Wheels are roller bearing.
Diameter of Track Wheels, 4 inches.
Clearance necessary for Track Wheels, 5 inches.
Total clearance necessary, 66 inches.
Shipping weight, 84 pounds.

Fig. 802 is our Platform Milk Can Carrier for use on our solid steel track of the Double Bead pattern. The carrier consists of a wooden platform braced across the bottom and reinforced around the edges with angle iron. The carrier is suspended from swivel trucks the same as are used with our regular litter carriers and feed carriers by means of a heavy steel frame or bail. This carrier is built regularly to hold four ordinary railroad milk cans, but can be built in special sizes.

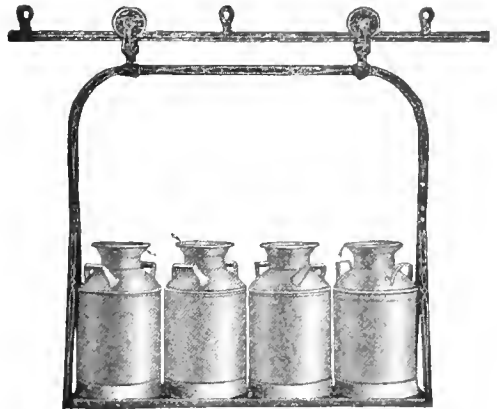

Fig. 802. (Hark).

Railroad Milk Can Carrier—Fig. 1045

Specifications

Operates on Louden Double Bead Steel Track, Fig. 571. (Page 175.)
Capacity, three railroad milk cans.
Fitted regularly to raise and lower 7 feet; may be fitted to raise and lower greater distance at slight additional cost.
Track Wheels are roller bearing.
Diameter of Track Wheels, 4 inches.
Clearance necessary for Track Wheels, 5 inches.
Total clearance necessary, loaded, 54 inches.
Length of Hand Chain, 11 feet, ends joined together. Where ceilings are high, longer chain may be furnished at slight additional cost.

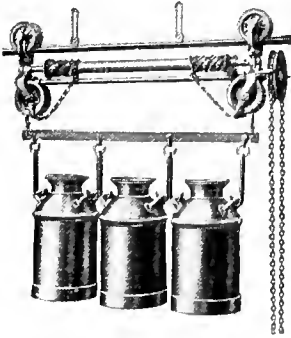

Fig. 1045. (Burlington).

This is a convenient, inexpensive device for handling the milk cans at milking time, and for transporting them from the cow barn to the dairy building. The carrier can be furnished with either Standard or Emancipator gear (Emancipator gear illustrated) to operate on Louden Double Bead Steel Track. With one of these gears the cans can be lowered to within a few inches of the floor and operated from one end of the building to the other. This keeps the cans up out of the dirt and at the same time within easy reach of the milkers. The carrier may be operated on the regular Litter or Feed Carrier tracks. It is built to handle three railroad milk cans.

Wire Track Milk Can Carrier—Fig. 766

Specifications

Operates on 0000 Basic Steel Wire Track. (See pages 187 to 190 for Track and Track Fittings.)
Platform made of wood, reinforced by 2x4 supports underneath.
Length of platform, 42 inches; width, 16 inches.
Capacity, three railroad milk cans.
Track Wheels are roller bearing.
Diameter of Track Wheels, 6 inches.
Clearance necessary for Track Wheels, 6 inches.
Total clearance necessary, 56 inches.
Shipping weight, 73½ pounds.

Fig. 766 is our Platform Milk Can Carrier to run on wire track. It carries three large railroad cans. It is fitted with the swivel trucks the same as our wire track litter carriers, and can be operated over switches and around curves.

By using our special Spring End Stops with latch to catch and hold the carrier and which we furnish on special orders, the man in the barn can safely send thirty gallons of milk to the milk house one hundred feet or more away. The latch will catch and hold the carrier until unloaded. The man at the milk house can take charge of the milk, unlock the latch and by a little push send the carrier back to the barn.

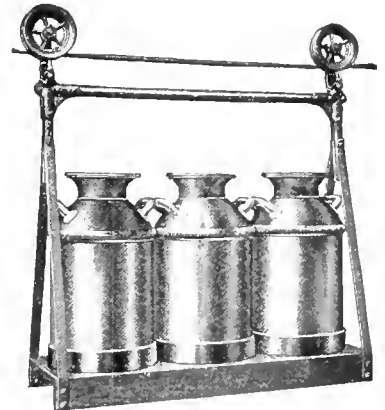

Fig. 766. (Hark).

Suspended Milk Can Carrier—Fig. 767

Specifications

Operates on 0000 Basic Steel Wire Track. (See pages 187 to 190 for Track and Track Fittings.)
 Capacity, five hand milk or cream cans.
 Track Wheels are roller bearing.
 Diameter of Track Wheels, 6 inches.
 Clearance necessary for Track Wheels, 6 inches.
 Total clearance necessary, loaded, 50 inches.
 Shipping weight, 45½ pounds.

Fig. 767 is our Suspended Milk Can Carrier for carrying five hand milk or cream cans. The hooks for attaching the cans to the carrier go with the carrier. This carrier is also fitted with the swivel wheels to run over curves and switches. We can furnish this carrier with trucks to run on our solid steel track when desired.

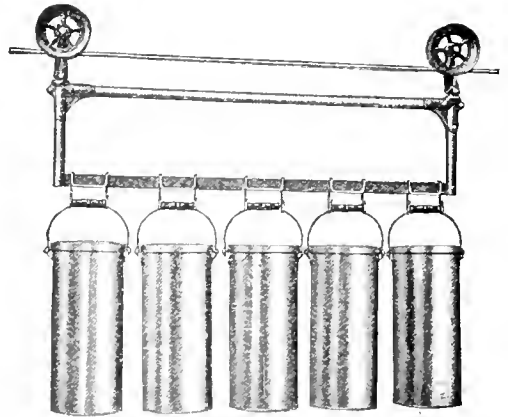

Fig. 767. (Harper)
 Patented
 Oct. 6, 1908

Railroad Milk Can Carrier for Wire Track—Fig. 1046

Specifications

Operates on 0000 Basic Steel Wire Track. (See pages 187 to 190 for Track and Track Fittings.)
 Capacity, three railroad milk cans.
 Fitted regularly to raise and lower 3½ feet.
 Track Wheels are roller bearing.
 Diameter of Track Wheels, 6 inches.
 Clearance necessary for Track Wheels, 6 inches.
 Total clearance necessary, loaded, 50 inches.
 Length of hand chain, 8½ feet, ends joined together.
 Shipping weight, 60 pounds.

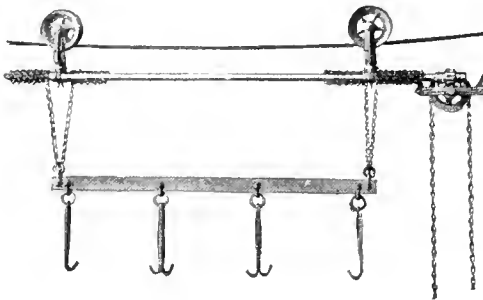

Fig. 1046. (Pacific)
 Patented
 May 9, 1911

This carrier operates on the same principle as the regular Railroad Milk Can Carrier, Fig. 1045. It has a different gear, however, built to run on wire track. It will handle three railroad milk cans. The cans can be raised and lowered for convenience at milking time, and for lifting in and out of cooling tanks. This carrier is often used where the dairy building stands some distance from the cow barn, wire track being stretched between the buildings. The track may also be continued to the inside of the cow barn, and the cans kept in the place most convenient for the milkers.

Louden Platform Hay Carrier—Fig. 809

Specifications

Operates on Loudon Double Bead Steel Track, Fig. 571. (See pages 175 to 183 for track and track fittings.)
 Platform made of wood, reinforced by 2x4 supports underneath.
 Length of platform, 72 inches; width, 30 inches.
 Track Wheels are roller bearing.
 Diameter of Track Wheels, 4 inches.
 Clearance necessary for track wheels, 5 inches.
 Total clearance necessary, 68 inches.
 Weight, 130 pounds.

Fig. 809 shows a Platform Hay Carrier for conveying either loose or baled hay into the feed alleys. The carrier consists of a wood platform supported by means of a steel bail or frame from the trolleys. On each side of the carrier there is a special tubular shaft, into which are fitted steel teeth. These teeth can be folded down to lie flat on the platform, and the carrier may be used for handling baled hay, milk cans, etc. When hauling hay the steel teeth are opened outward as shown in the illustration. A very large bunch of loose hay may be handled with this carrier.

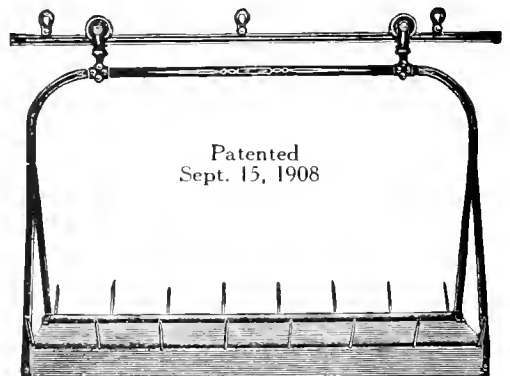

Fig. 809. (Troy).

Steel Track, Track Hangers, Rafter Brackets, Etc.

Louden tracks are made of the finest and strongest high carbon steel and are especially adapted to carrying heavy loads. The shape of Louden track eliminates all unnecessary friction, and much less power is necessary to operate a car than with the ordinary, cheaply constructed track. A thin, flat sided track will buckle over or become wavy, carrying half the load that Louden track will carry with ease.

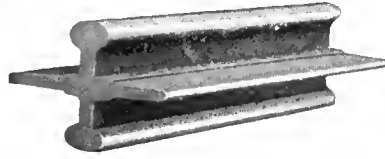
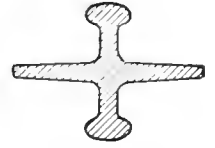

Fig. 571. (Clara).



No. 2.

Figure 571 is our Double Bead steel track. Number 2 is an end view. This track weighs 2 pounds to the foot. Width of track 2 inches; height, $1\frac{7}{16}$ inches.

Figure 832 is our link track hanger which we furnish in assorted odd inch lengths up to 61 inches. Link track hangers at least 5 inches in length should always be specified with Steel Track Litter Carriers. Longer lengths may be specified where track passes under beams. Five-inch length track hanger, weight per dozen, $7\frac{1}{2}$ pounds.

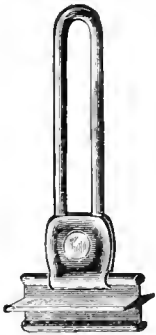

Fig. 832. (Trout).
Patented
Sept. 1, 1908

Figure 1066 is our Adjustable Link Track Hanger. Handy for use where joists are uneven. Weight (5-inch length) per dozen, $8\frac{1}{2}$ pounds.



Fig. 1066.

Patented
April 21, 1914

In specifying Link Track Hangers for Steel Track Carriers to permit track to pass under the girder or beams, the hanger should be 3 inches longer than the thickness of the timber under which the track is to pass. Example—For an 8-inch timber an 11-inch link hanger would be necessary.

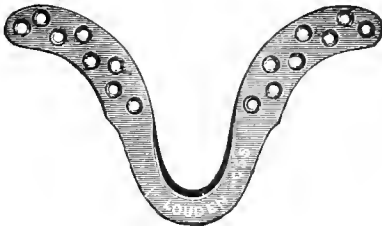

Fig. 424. (Casper).

Figure 424 is our Standard Rafter Bracket. This is the bracket to order for the litter carrier track where the track is supported from joists or beams running at right angles to the track. Weight per dozen, $4\frac{1}{2}$ pounds.

Figure 465 is our Ridge Pole Bracket which is used when the track is hung parallel to a joist or other 2-inch timber. Weight per dozen, 3 pounds.

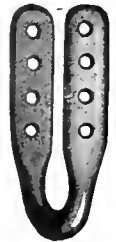

Fig. 465. (Cubeb).

Figure 675 is our Side Rafter Bracket, used where track is supported from sloping rafter running at right angles to the track. Weight per dozen, $5\frac{1}{4}$ pounds.

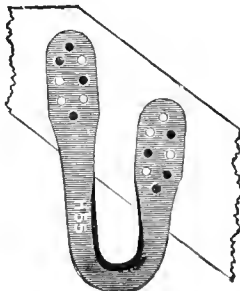

Fig. 675. (Cute).

Figure 725 is our Side Beam Bracket for hanging track to a timber running parallel with the track. Weight per dozen, 6 pounds.

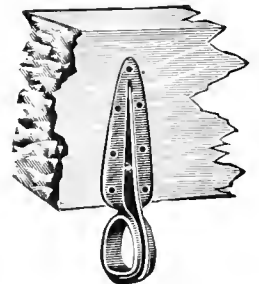

Fig. 725. (Beam).

Figure 726 is a Screw Eye used for supporting the track under ceilings, or this Screw Eye may be substituted anywhere for the brackets if preferred. Weight per dozen, 6 pounds.



Fig. 726. (Eli).

Figure 523 is an end stop block to clamp on the end of track to prevent carrier from running off the open rail. Weight, $\frac{3}{4}$ pound.

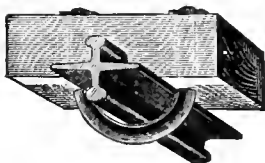

Fig. 523. Junior. (Cage).



Flock Company Barn, Williamsport, Pa.



Round Barn with Curved Track. J. A. Remy, Belleville, Wis., Owner.



Quick Barn Cleaning in Col. W.

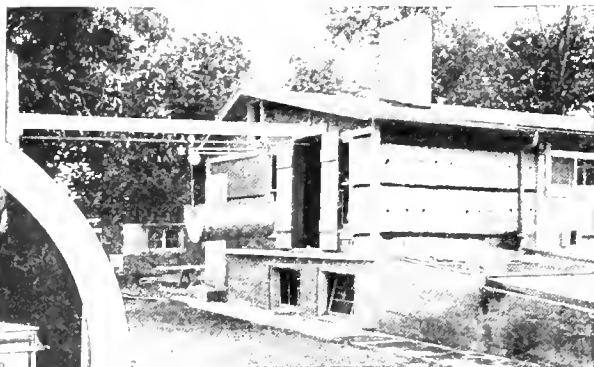

"The Louden Carrier in my Hatchery Saves a World of Labor." Wayne G. Barrows Poultry Farm, Crystal Lake, Ill.

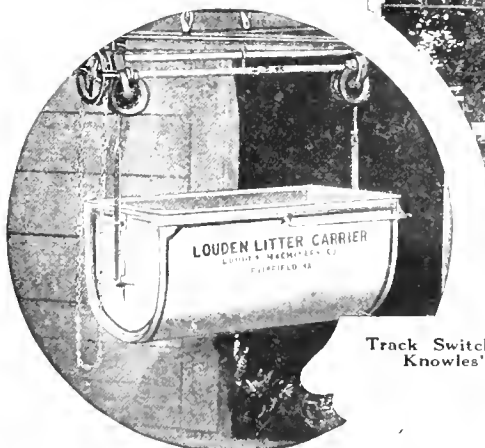

Track Switch at Doorway. James Knowles' Barn, Azalia, Mich.



"Empties Itself and Return" Salisbury, Mo., Uses L



The Great Homewood Farm Barns, Owned by Wil and Equipped Throughout by



Phelps' Barn at Carthage, Mo.

Overland Guernsey Farm, Kansas
City, Mo.

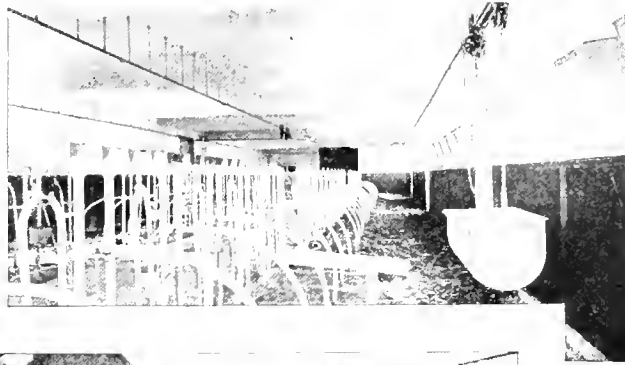
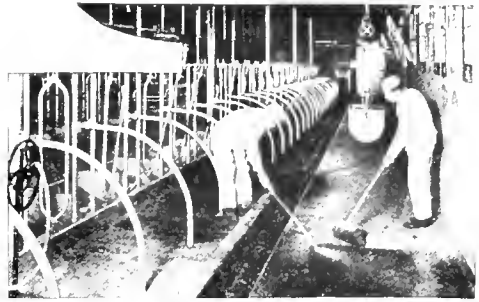

Louden Equipped
Barn of T. A.
Sperry, Osceola
Farms, Cranford,
N. J.



to the Barn." Chas. Ihm,
Wire Track Carrier.

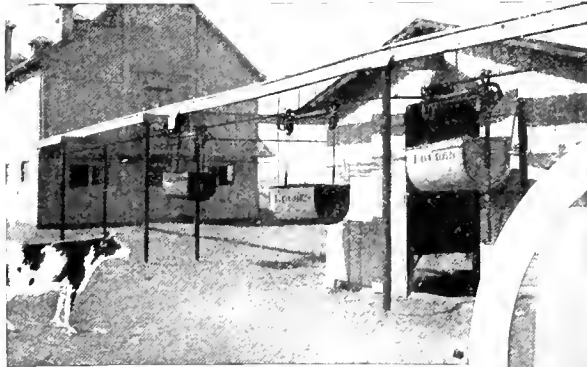

Six Louden Litter Carriers are Used at the
Iowana Farms, Davenport, Iowa.

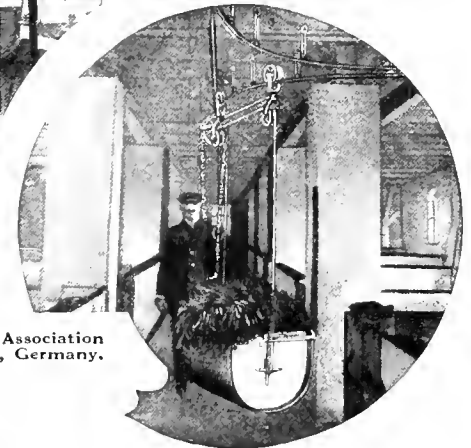

Louden Carrier at Dairy Association
Farm, Burg auf Fehmarn, Germany.

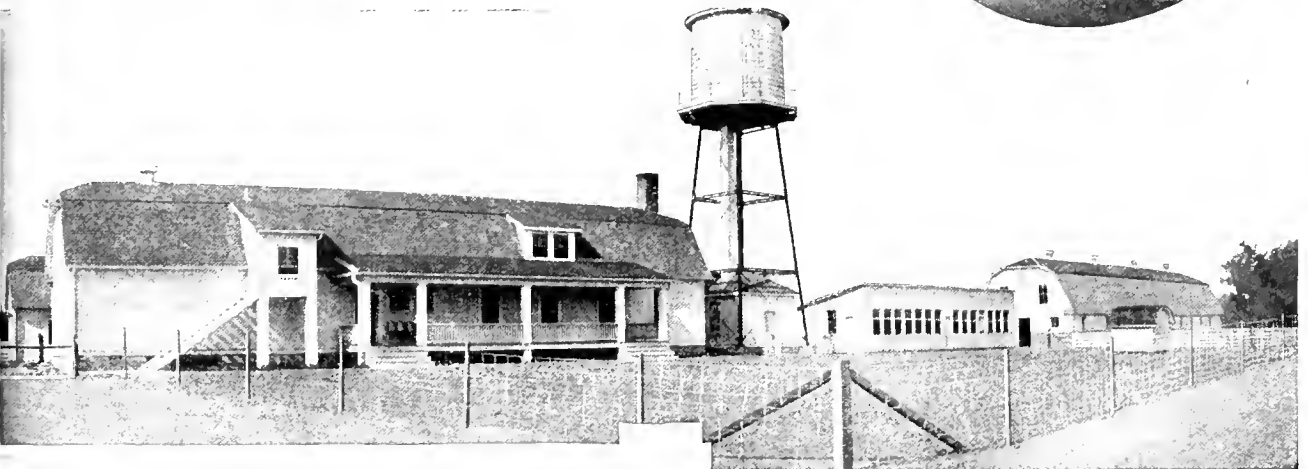

on Butterworth, Moline, Illinois. Buildings Planned
by the Louden Machinery Company.

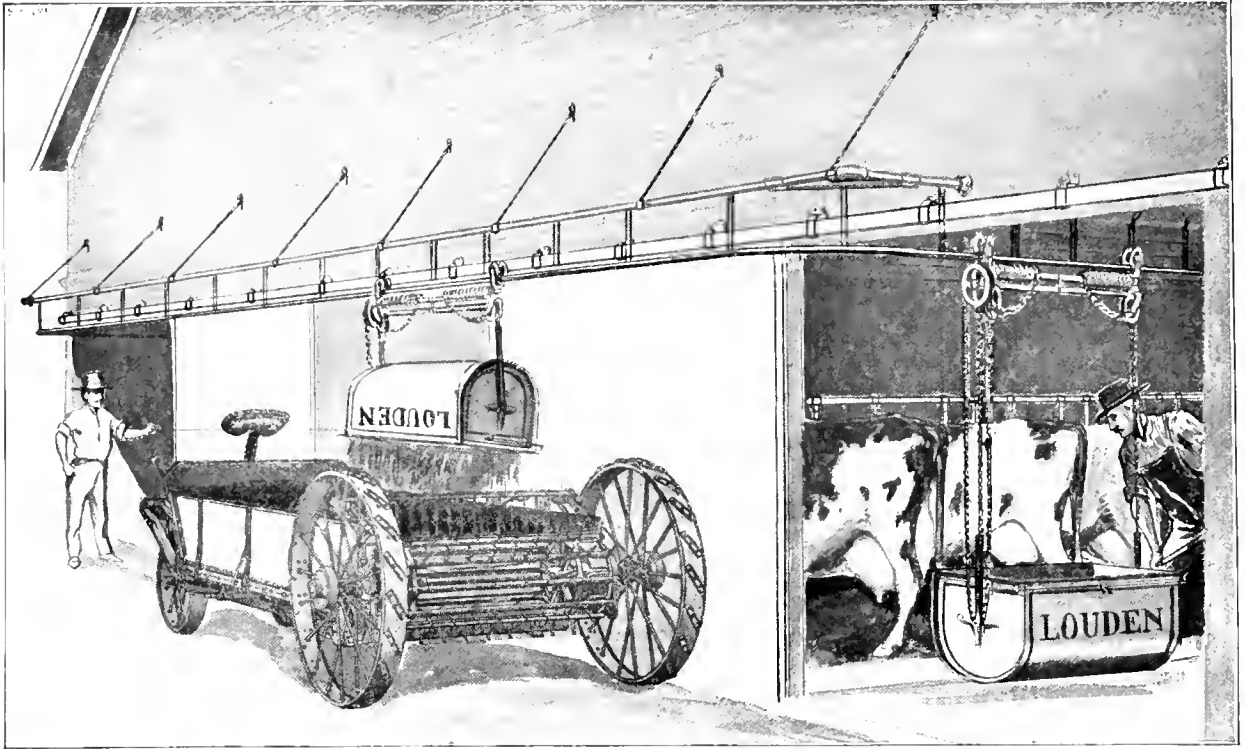

Outside Track Supports—Fig. 1277

Where the practice is followed of hauling manure to the field as fast as made the arrangement as shown in the accompanying illustration is handy and eliminates posts in the yard. The track is bracketed to the end of the barn far enough out to permit the manure to be dropped into the spreader or wagon. No switches are necessary and the arrangement is strong and neat looking. We furnish all of the metal parts as shown in the detailed view, Fig. 1277-A except the track and track hangers.

Where desired wood brackets may be used for supporting track at the end of barn and in which case all material would be arranged for on the ground.

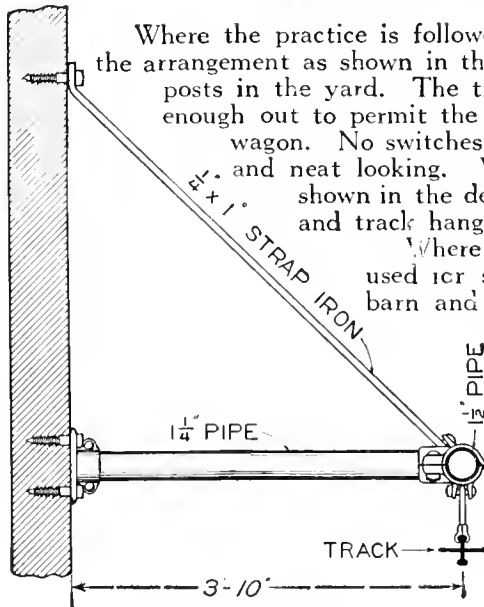

Fig. 1277-A

Specifications

Main frame or rail which supports the track 1 7/8-inch steel tubing. Braces holding same from the wall 1 5/8-inch steel tubing 3 feet 9 inches long.

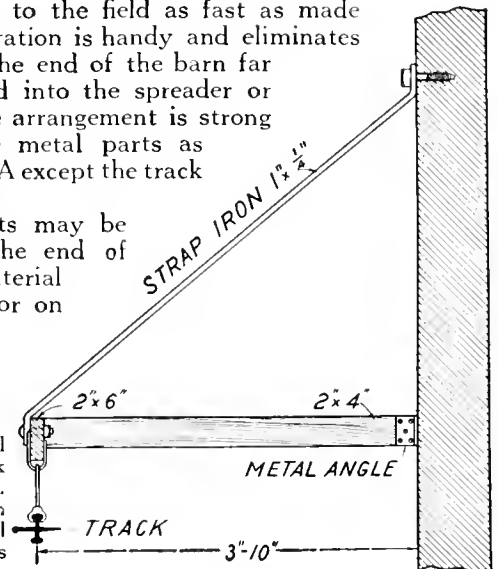

Fig. 1278.

Supporting straps 1/4 x 1 inch steel, 6 feet long. Connections are of malleable iron. Upper end of supporting straps are fastened by means of lag screws. Lower end of straps attach to main rail by means of special clamp holders. Heel of brace is held in place with wall flanges secured by lag screws.

Steel Support for Yard Track— Fig. 1279

Specifications

Standard lengths of post, 8, 10, 12, 14 and 16 ft.
Diameter of post 4½ inches, outside diameter.
Length of upper horizontal arm, 36 inches.
Length of brace, 44 inches.
Diameter of arm and brace, 17⅛ inches.
All connections are of malleable iron.

Fig. 1279 shows the best method of supporting litter carrier or milk can carrier track in the yard. A steel post is used, with strongly braced tubular steel arm. A 2x8 wood beam is hung beneath the supporting arm, and the track is attached to it in the same manner as in the barn.

Fig. 1279-A shows in detail the method of attaching beam to supporting arm.

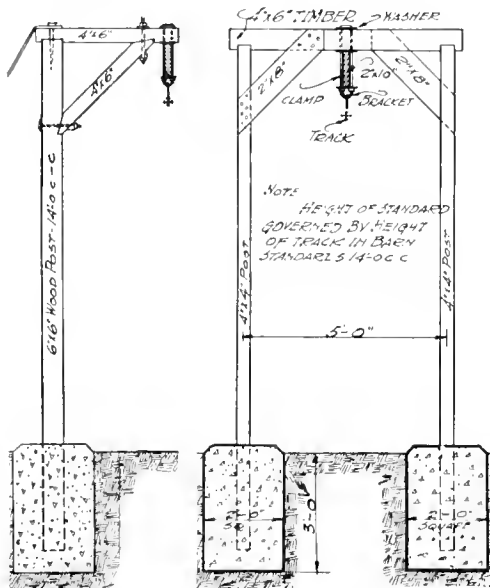

Fig. 1295—Two Good Methods of Supporting Track in Yard By Means of Wood Posts.

The posts should be set in concrete to make them rigid. This makes a permanent support that will not be affected by "soft" weather and that cannot be pushed out of line or broken.

Fig. 1295 shows two good methods of supporting the track in the yard by means of wood posts. The posts should be set in concrete to make them rigid and to prevent rotting off.

When a single post is used it should be well anchored by means of a guy rod or wire to offset the unbalanced strain put upon it by running a heavy load over the track. No anchor is necessary when two posts are used.

Any kind of wood posts may be used, but the steel posts are better and more lasting.

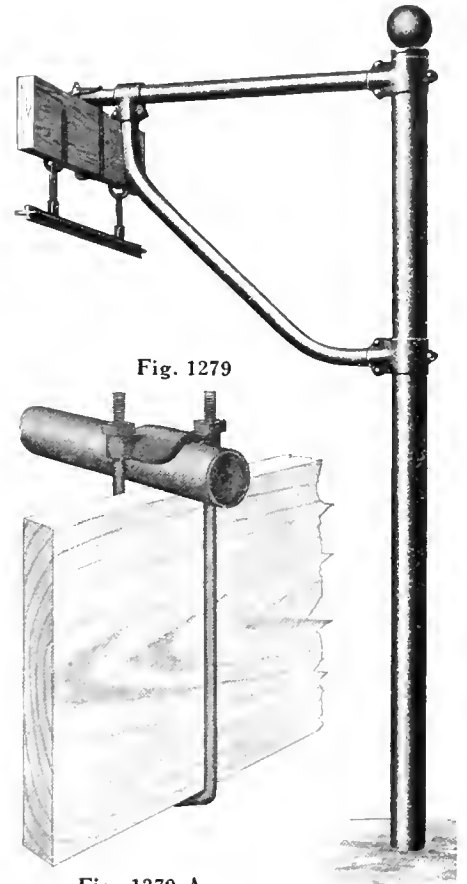

Fig. 1279-A

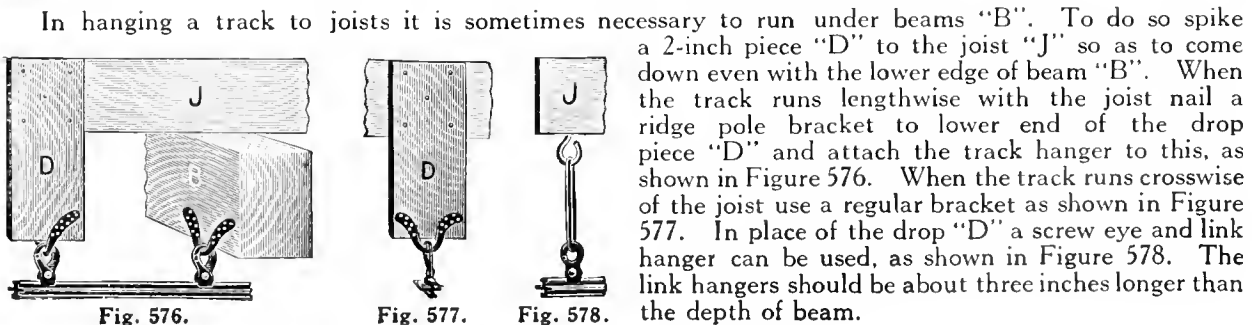
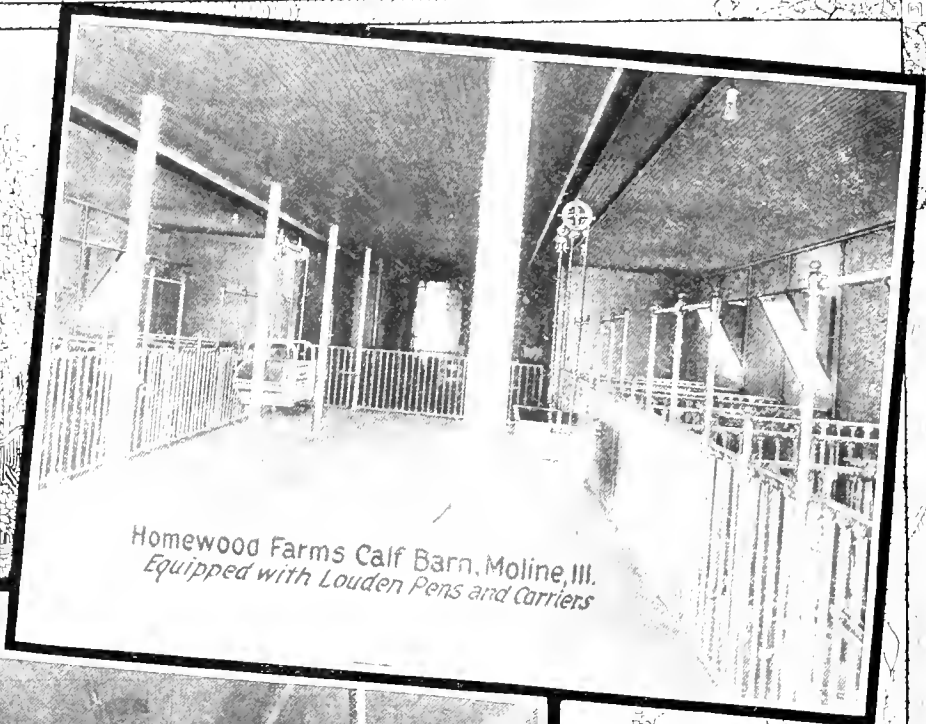

Fig. 576.

Fig. 577.

Fig. 578.

In hanging a track to joists it is sometimes necessary to run under beams "B". To do so spike a 2-inch piece "D" to the joist "J" so as to come down even with the lower edge of beam "B". When the track runs lengthwise with the joist nail a ridge pole bracket to lower end of the drop piece "D" and attach the track hanger to this, as shown in Figure 576. When the track runs crosswise of the joist use a regular bracket as shown in Figure 577. In place of the drop "D" a screw eye and link hanger can be used, as shown in Figure 578. The link hangers should be about three inches longer than the depth of beam.



Homewood Farms Calf Barn, Moline, Ill.
Equipped with Louden Pens and Carriers



University of Minnesota Dairy Barn
Louden Equipped

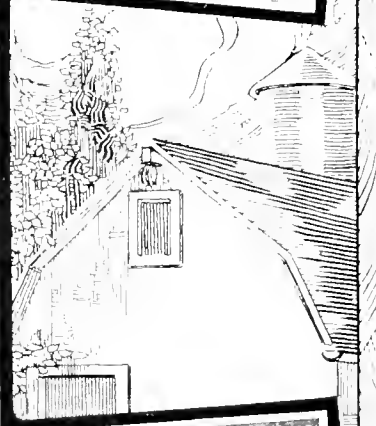

Gerald Goetz, Salisbury, Mo.
Uses a Louden Rod Track Litter Carrier

Louden Track Switches

Louden Track Switches are the easiest operated, strongest and altogether the most satisfactory on the market. When the switch cord is pulled, the track is thrown into the desired position, and an automatic safety catch makes it impossible for a car to run off the track.

Switches can be furnished unmounted on special orders, but mounted switches are recommended as they are much easier to install.

Fig. 849 shows our Cross Track Switch mounted on a board ready to attach to ceiling. It is often necessary or convenient to have two tracks cross at right angles. The central section of the cross track switch is thrown into position for either track as desired by pulling on the cords. The guards work automatically, dropping in place to guard the open rail and elevating to clear the carrier wheels when the central track is in place.

Switches take 2 feet of space in track. Switches should never be placed in doorway, especially when sliding doors are used.

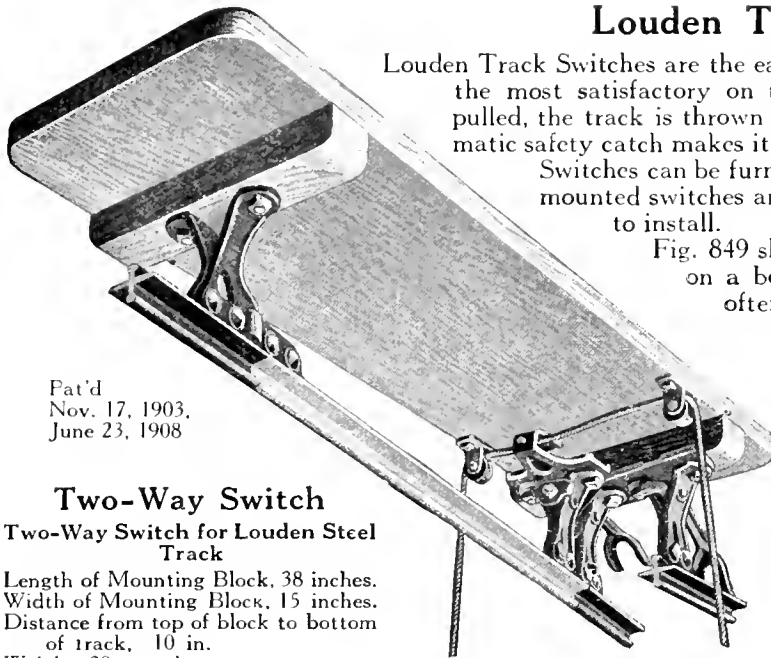

Fig. 736. Junior Two-Way. (Cat).

Pat'd
Nov. 17, 1903,
June 23, 1908

Two-Way Switch

Two-Way Switch for Louden Steel Track

Length of Mounting Block, 38 inches.
Width of Mounting Block, 15 inches.
Distance from top of block to bottom of track, 10 in.
Weight, 29 pounds.

This can nearly always be avoided by reversing the curve, placing the switch inside the building and making a back switch from the side line to the main line.

The illustration at right shows a Three-Way Track switch mounted on plank "B" ready to attach to the joist or ceiling of building. The Switch "S" is hinged to the main track "A" at "H." By pulling on the cords "C" and "D" the switch or hinged section will slide on the plate "E" and change from one track to the other, so that

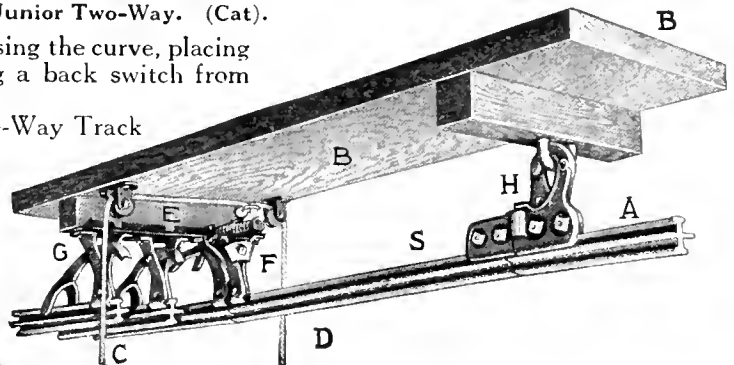

Fig. 795. Three-Way Switch. (Caboose).

Three-Way Switch for Louden Steel Track

Length of Mounting Block, 38 inches.
Width of Mounting Block, 15 inches.
Distance from top of block to bottom of track, 10 in.
Weight, 31 pounds.

the operator can use any one of the three tracks at will. The hinged track "S" is locked in place by latch "F." It can be operated from below no matter how high the track may be hung. A guard "G" which works automatically, is used to prevent carrier from running off track, should switch be left open. We furnish the switches Two-Way or Three-Way, and as many tracks or switches as are necessary can be used. The track can be run to any part of the barn.

Distance from top of Block to bottom of track, 10 inches.
Weight, 28 pounds.

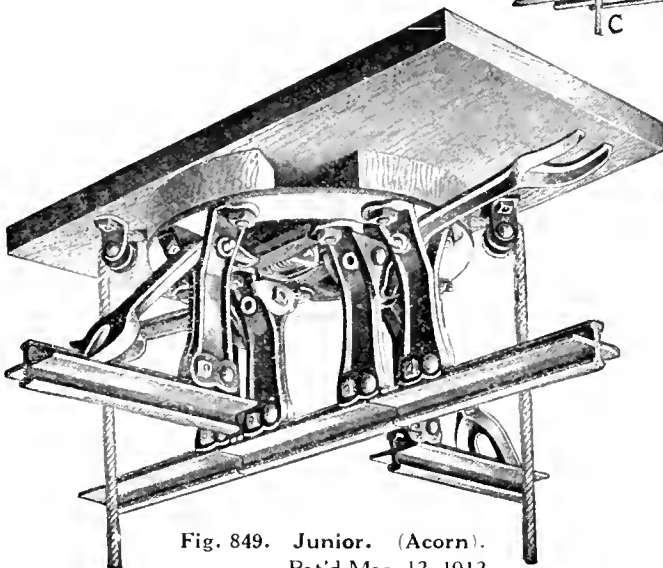

Fig. 849. Junior. (Acorn).
Pat'd Mar. 12, 1912

Cross Track Switch for Louden Steel Track
Length of Mounting Block, 24 inches. Width, 12 inches.

Track Brace

Standard length of brace 2 feet. Brace is made of $\frac{3}{16}$ x 1-inch steel. Clamp is of malleable iron.

Where extremely long link track hangers are used to permit track to be hung under beams or in suspending track from a very high ceiling, it is sometimes necessary to brace the track at the ends to prevent the track from swinging endwise and from creeping. Fig. 1209 shows two views of the Clamp and Brace attached to a link track hanger. The brace can be placed in any position, one end being clamped to the hanger and the other end attached to any convenient timber or wall where it can be secured with a lag screw or bolt. This brace is also used to prevent sidewise swinging of the track.

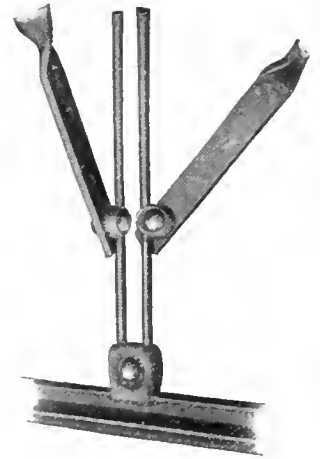

Fig. 1209.

Track Opener For Sliding Doors—Fig. 859

Specifications

Louden Automatic Track Opener
Fig. 859.

Includes section of Track, Splice Clamp, two Special Rigid Hangers, two special Straps for supporting timber and Operating Bar for attaching to door.
Length, 46 $\frac{3}{4}$ inches.
Weight, 13 $\frac{1}{2}$ pounds.

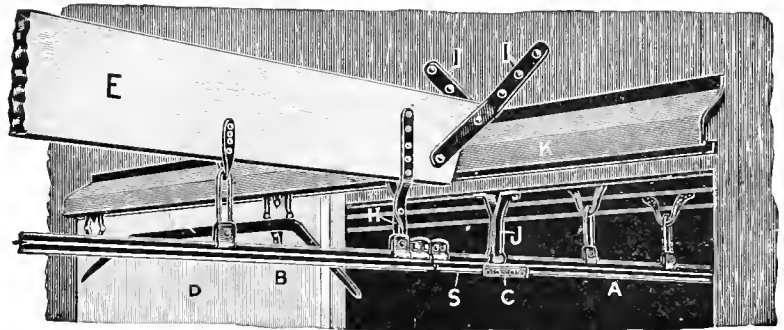

Fig. 859. Junior. (Gait).
Patented Nov. 13, 1909

Louden Track Openers are for use on sliding doors through which Litter and Feed Carriers pass. This device automatically opens a way through the track so the door may be opened or closed without a moment's delay. (See illustration Fig. 860.) A bar "T," having its ends downwardly inclined, slips under and lifts the section "S" when the door is closed. When the door is open the section "S" drops into place joining the two ends of the track, making the track continuous, ready for the carrier to pass over. (See illustration Fig. 859.) By having both ends of the bar "T" downwardly inclined it may be set at either edge of the door and will open the track from either side.

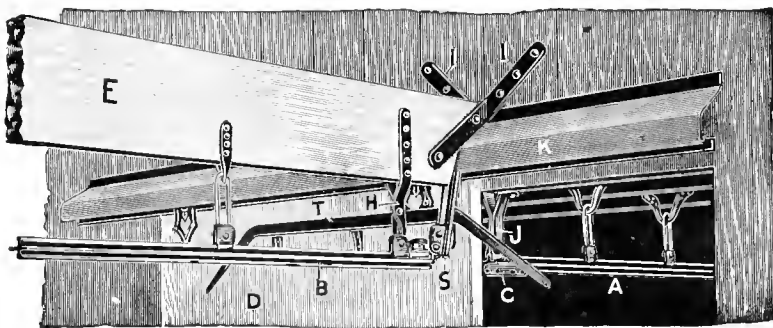
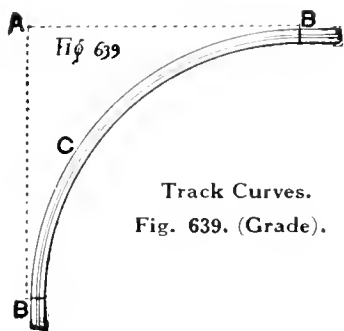

Fig. 860.

Special rigid hangers "H" and "J" are required to hold the adjoining ends of the track "A" and "B" in position so the section "S" will always drop into its place without missing, and so the bar "T" will always lift it instead of pushing it to one side; also special straps "I," bent at an angle to fit the side of the barn and the sides of the timber "E" and hold it clear of the door hanger and low enough to attach the hanger "H." When the door is hung on the inside of the barn, the section "S" is hinged to the track "A" and the support "C" is secured to the track "B."

This is a simple device, is easily fitted up and works perfectly. The outfit consists of the opener "T" with brackets to attach to the door, hangers "H" and "J," the section "S" with its hinged connection, the support "C" and the straps "I."



Curved Track

Figure 639 is a diagram for measuring a track around curves. Where a 6-foot Right Angle Curve "C" is used, it will make up for approximately 4 feet of straight track on each side from "A" to "B," or about 8 feet in all. When an 8-foot curve is used, it will make approximately 5 feet on each side, or 10 feet in all. Generally a 6-foot curve is long enough to turn a square corner.

Track Through Swinging Doors

Where the track is to pass through swinging door a nice way to arrange the door is as illustrated in Fig. 1208. The top of the door is sawed off and the space on each side of the track under the door jamb is built down to meet the door.

Another plan would be to place a hinged section on the top of the door. This could be dropped down when necessary to open the door. When the door is closed the hinged section on top of the door could be hooked up into place, fitting neatly around the track.

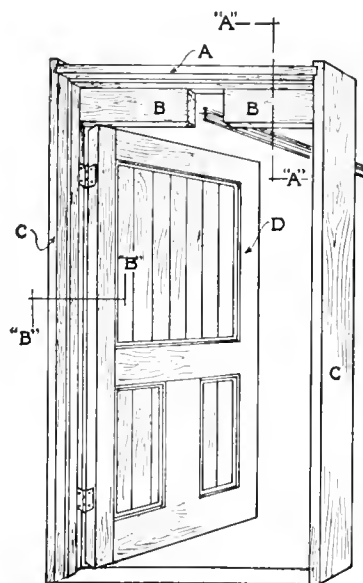

Fig. 1208.

Removable Section For Sliding Doors—Fig. 633

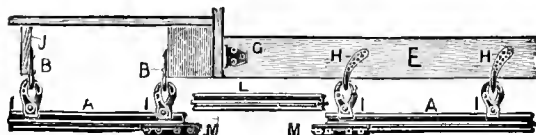

Fig. 633. (Craft).

Louden Removable Section.

Where the track passes through a door, a removable section "L," Fig. 633, may be used instead of the track opener described above. This is furnished with special splice clamps that bolt to the ends of the adjoining track sections "M, M." These clamps hold the loose piece firmly in place, but it can be easily lifted

out to allow the door to shut, or be replaced when the carrier is to be used.

"J" is a joist; "B" the brackets; "I" the hangers; "A" the track; "E" the ridge pole; "H" ridge pole brackets, and "G" a wall bracket to fasten ridge pole to barn. Where the door opening is too low for the track to run out level from the joists and a swinging door is used, it may be arranged as shown in Fig. 643. Removable sections are made in two and four foot lengths.

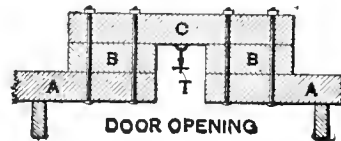

Fig. 643.

Louden Machinery Company,
Fairfield, Iowa.
Gentlemen:

Dec. 11, 1914.

In reply to your inquiry we wish to say that we began using your Overhead Track and carriers some five or six years ago and at the present time we have had about one-third of a mile of the iron track in use on our farm. We use it for carrying feed and grain and also for the manure carriers. The Track has given perfect satisfaction, as have the Feed Carriers, and we think the Manure Carriers are as good as can be had.

You also made for us a large Milk Vat that runs on a carrier and in which we carry the skimmed milk to the calves. This has been of much help to us.

Wishing you continued success, we remain,

Sincerely yours,

The Maplecrest Stock Farm Co.,
Kalamazoo, Mich.

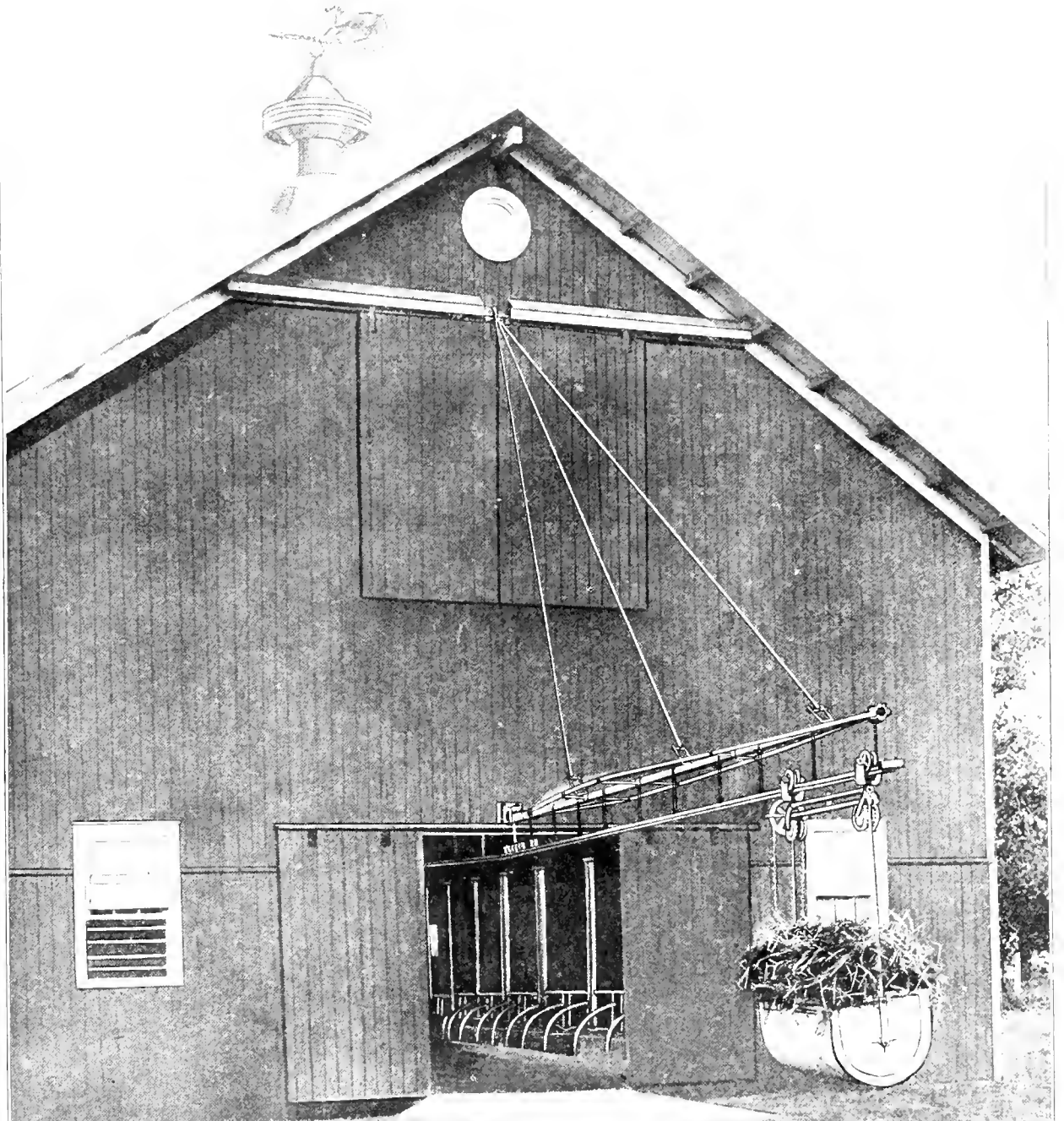

Barn of C.M. Hammond, West Chicago, Ill.
Louden Equipped

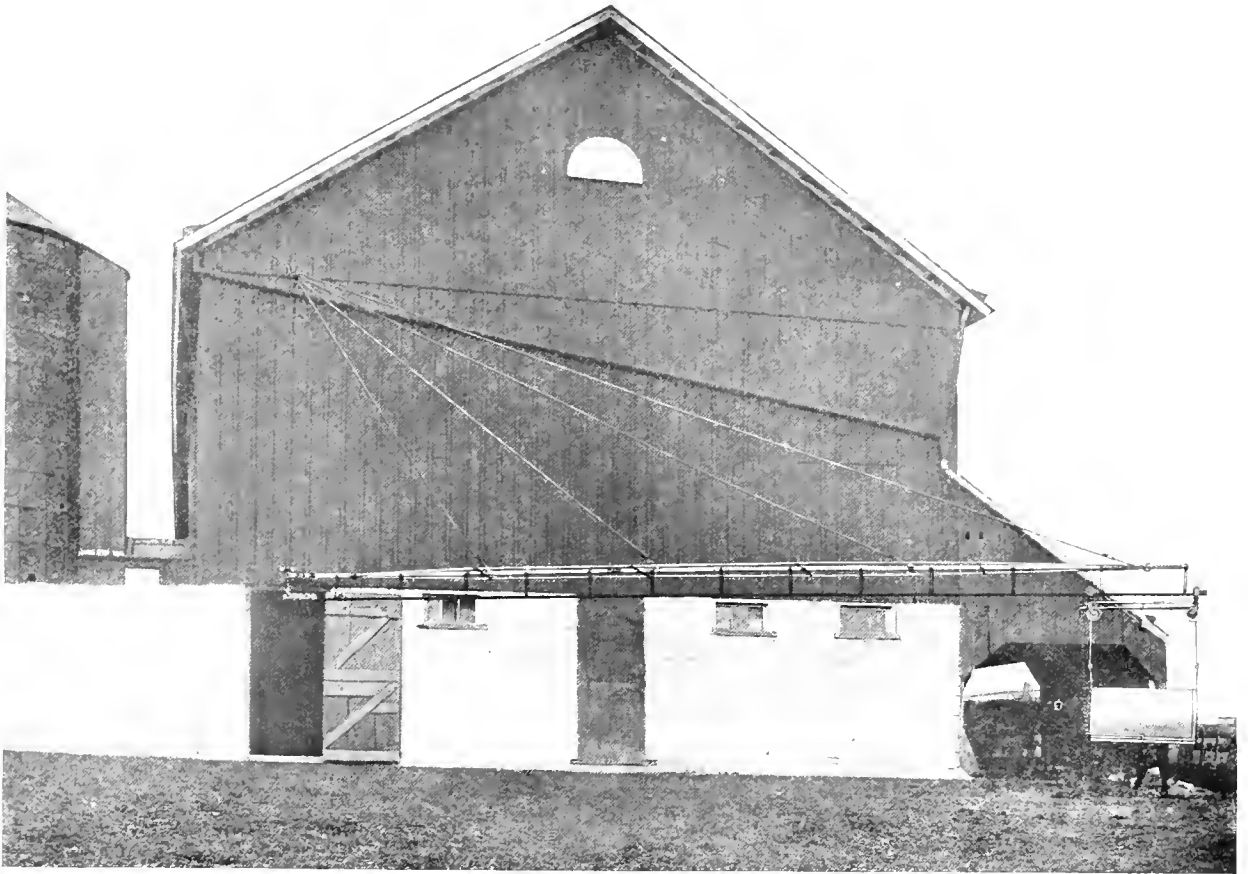

Louden Swinging Steel Crane Specifications

Main Boom made of 2 $\frac{3}{8}$ inch O. D. steel tubing.
 Cranes 30 feet long or over are side trussed.
 Cranes less than 30 feet long are not side trussed.
 Truss Rods made of 1 $\frac{1}{16}$ inch O. D. steel tubing.

Truss Stays made of 1 $\frac{1}{16}$ inch O. D. steel tubing.
 Guy Wires made of 0000 basic steel wire.
 Vertebra hinge of refined malleable iron.

Weight of	12-ft.	Crane complete,	Fig. 974	with track,	114 lbs.
" "	22 "	" "	" 976	" "	192 "
" "	30 "	" "	" 978	" "	348 "
" "	40 "	" "	" 980	" "	472 "

(NOTE: A Crane of any length up to 40 feet is practical that does not exceed in number of feet the distance from the point where the base of the Crane is to set to the plate on which the rafters rest, multiplied by 2 $\frac{1}{2}$. It is well to remember that there is the same inward pressure at the base of a Crane as outward pull where the guys are attached. This pressure and pull, however, comes at the barn's strongest points—the mow floor and the rafter plate, and a little bracing is all that is necessary to neutralize the strain on the end of the barn. See Figure 1067, page 186.

In erecting Crane see that the longest guy wire carries enough of the weight to pull it taut, intermediate guy wires may be slightly slack but the guy reaching to the end of the Crane should always be taut.)

A Louden Swinging Steel Crane is attached to the barn above the door in line with the Litter Carrier track, and extends out over the yard for a distance of 12 to 40 feet without posts or supports of any kind in the yard being necessary.

The use of the Swinging Crane not only makes unnecessary all posts and supports in the yard, but gives a far greater area in which manure may be dumped as the Crane may be swung around from left to right till it strikes the sides of the barn. To all practical purposes a Swinging Crane of 30-foot length gives a dumping area as great as a straight, rigid track running out a couple of hundred feet from the barn door. To empty the Litter Carrier direct into wagon or spreader, all that is necessary is to drive to any point within the Crane's radius.

The Swinging Crane is also a great convenience where litter is to be dumped on the opposite side of a yard fence or down a hillside from the barn, and, as it may be swung around close up against the barn when not in use, is entirely out of the way of passing stock or wagons.

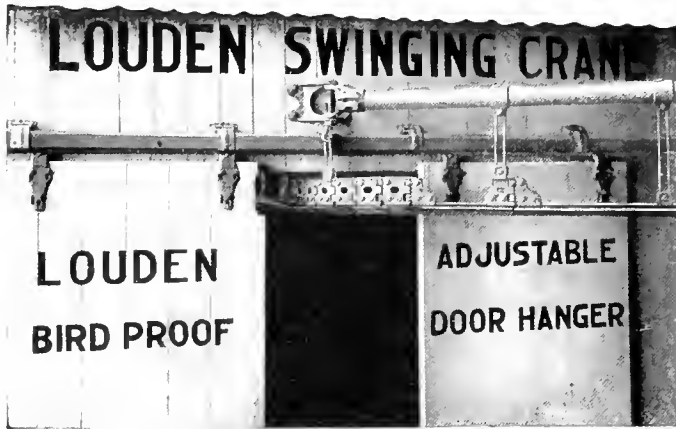

Fig. 1062.

(see Fig. 1067). It is built on the same scientific principle employed in steel bridges, and is 50 per cent stronger than a more cheaply constructed wire trussed Crane. It is absolutely impossible for it to buckle under the heaviest load, as the tubular steel truss will handle an enormous back pressure.

Cranes under 30 feet in length are not side trussed.

Figure 1062 shows the construction of the Crane at doorway. A special malleable iron vertebrac hinge made in our own factory insures the free, easy, and steady movement of the Crane. It will handle double the load that it will ever be called upon to handle.

Where swinging crane passes through sliding door and this hinge is used, the door should be made double. Doors can then be notched to fit closely around the hinge as shown in Fig. 1062. The type of hinge used is the best for the purpose.

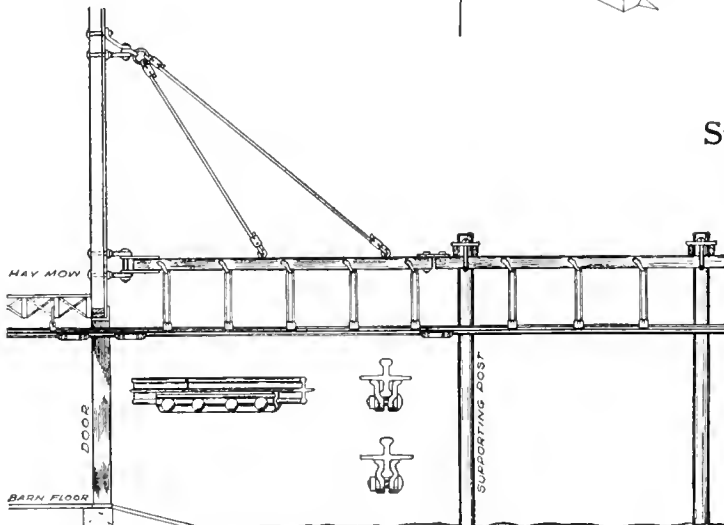

Fig. 791.

The Louden Crane is built regularly in lengths of 12 feet, 22 feet, 30 feet and 40 feet. Each Crane will carry many times any practical load. In factory test a 40-foot Crane was operated with a 1,500 pound weight at extreme end. It is absolutely guaranteed to handle 1,000 pound loads. For very heavy loads, however, care should be taken to see that the timbers of the barn, to which the Crane is anchored, are strong and well braced.

Construction

The Louden Swinging Steel Crane is guaranteed to be the strongest and most substantial Crane for Litter and Feed Carriers on the market. All Louden cranes 30 feet long or over, are side trussed. This is the only Crane made that is side trussed with tubular steel

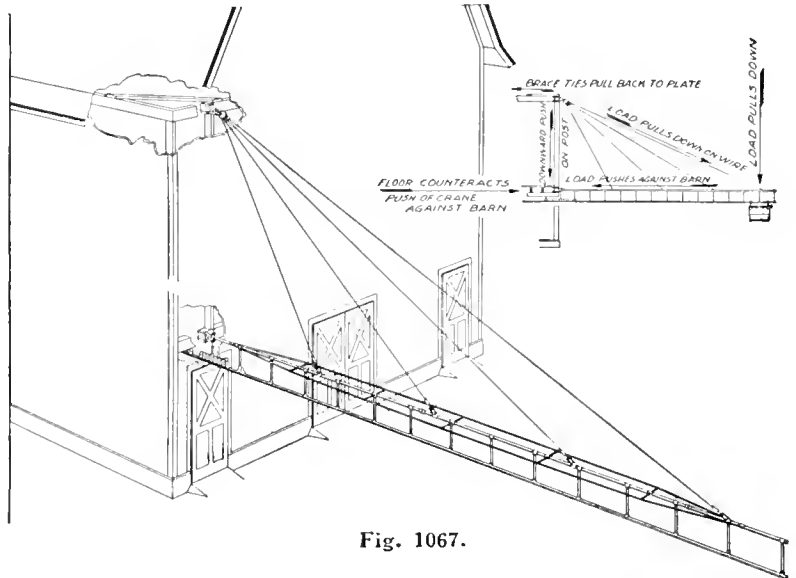

Fig. 1067.

Swinging Track at Door—Fig. 791 Specifications

One set of fittings consists of malleable hinge and bolts for attaching to barn, steel supporting rods and special clamps and fixtures for connecting to track at outer end.

In instances where the litter carrier track extends out of the barn at the end where the hay is taken up, it is sometimes desirable to have a section of track which will swing around out of the way or lift out. This plan is shown in Fig. 791.

Please remember that we have a solution for any problem that may come up in the installation of our goods.

Fixtures for Louden Wire Track Litter Carriers

The Track

The track is made of the finest grade of Basic Steel Wire and is manufactured expressly for us. Its tensile strength is remarkable, and while it makes a good spring it will bend double twice without breaking. We furnish the standard size, No. 0000 which is amply strong for all work. This size is 13-32-inch in diameter and runs 27 inches to the pound. The track can be run 100 feet or more without center supports (see Figure 1068, next page).

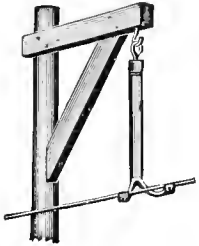

Fig. 746. (Horizon).

Specifications

Patent Spring Suspender.

Length, 17½ inches.
Weight, 4¼ pounds.

When longer lengths are required additional supports may be used by means of our Patent Spring Suspender, as shown in Figure 746, which supports the wire and permits the carrier to run past the post. The body of the suspender is of inch pipe fitted with a strong spring 10 inches long which supports the track and at the same time makes it flexible to suit the weight of the load and to let the carrier run easily over it.

A similar suspender made shorter may be used in connection with a pulley, as shown by Figure 747, to raise and lower the track in the stable as may be desirable, and to assist the loaded carrier to run out and the empty carrier to return. The outer end of the track should be set 15 to 18 inches higher by the level than the end in the barn for each 100 feet long. The cut shows the tension bolt passed through the wall below the sill to facilitate the raising and lowering of the track. Otherwise it should be passed through the sill. Common pulleys and hooks may be used to hold up the suspender. When a tackle block hoist is specified, extra charge is made.

Sometimes it is necessary to run one end of the track to one side of a straight line. This we do by means of our Angle Iron, as shown in Figure 750. The curved end of the iron has a groove in which the wire fits and the other end is held by a guy secured to a post or otherwise, so as to hold the track in proper position. The guy should be of sufficient length to freely raise and lower with the track. The carrier wheels will readily pass over the

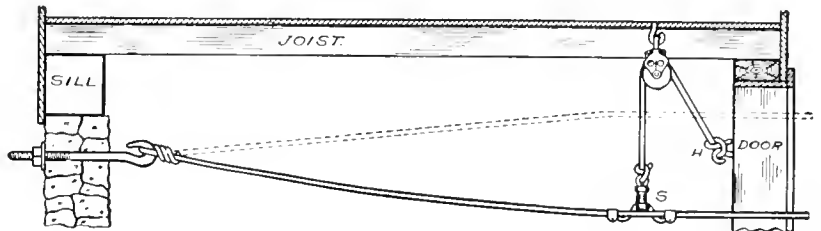

Fig. 747. Louden Tackle Block Suspender.
(Including pulley.)

Specifications

Weight, 6½ pounds.

curved end of the iron. We make two sizes, one 20 and the other a 35 degree curve.



Wire Track to Two Barns.

Roy L. Moyer of Maroa, Illinois, who has been using a Louden Litter Carrier says:

"The Louden Litter Carrier outfit that I purchased of you is all that you claim for it. This outfit has been in use now about two years and carries litter without any bother. Before installing this outfit the boys were a little careless about keeping the barn cleaned out, but now with the Carrier, we have a clean barn all the time."

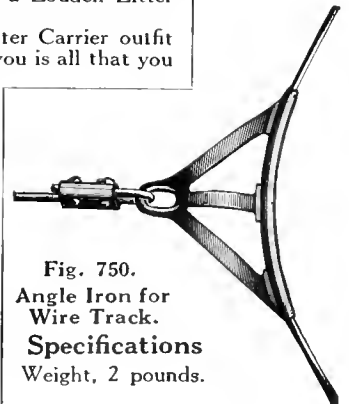

Fig. 750.
Angle Iron for
Wire Track.

Specifications
Weight, 2 pounds.

Anchoring Louden Wire Track

The anchoring of the track is an important matter. If it is securely anchored it is surprising what loads it will carry, but if not securely anchored, it will sag and get out of shape and cannot do good work. The post must be securely set in the ground. The other end of the track will most probably be anchored to the sill of the barn and the post should be made as solid as the sill.

A large flat stone or a good broad plank should be placed below the end of the post (see Figure 745). Unless the ground is as solid as a rock it will not stand the pressure of the post and it will settle, and keep settling every time the track is tightened. The next thing is to place a log or timber 8 to 10 inches, or more, in diameter and 5 to 6 feet long, not less than 4 feet in the ground. Our anchor bolts "A" are $\frac{3}{4}$ -inch in diameter by 6 feet long. They will stand a strain of at least 8 to 10 tons, and the log should be solid enough to stand that also.

Our anchoring device has no equal. It reaches clear to the top of the post, a heavy cross pin being used to prevent the loop "X" from slipping down on the tension bolt "T." The anchor bolt, which goes through the log, has a long threaded end above the ground (not below where it is of no use) and is arranged with a yoke "Y," so the anchor can be tightened as may be necessary to hold the post in proper position. We can use both the tension bolt and the anchor bolt to tighten up the track, whereas others can use the tension only. Extra heavy wire is used in our anchor to insure ample strength.

Another important precaution is to set the post slanting as shown in Figure 745. If set straight it will be much harder on the anchor wire than on the track wire. It is the anchor wire which generally gives way. If there is room, the longer the guy wires are the better. Also be sure the anchor wire is in direct lines with the track wire.

When you buy an article bearing the name Louden you may be sure that it is the best, and when a method of installation is recommended you may be sure that our recommendations are based upon actual tests. That is why Louden goods are known in every civilized country of the world.



Louden Tension Bolt
Fig. 1207

Louden Tension Bolts are made of steel. They are furnished in three sizes $\frac{3}{4}$ x 30 inches, $\frac{3}{4}$ x 15 inches and $\frac{7}{8}$ x 30 inches. The heavy bolt should be used for extreme long lengths of tracks or where the work is very heavy. The bolts have heavy deep threads and will not strip. Each Tension Bolt is furnished with large hexagon nut and washer. The $\frac{3}{4}$ x 30 inch bolt will always be furnished unless otherwise specified.

Fig. 1207.

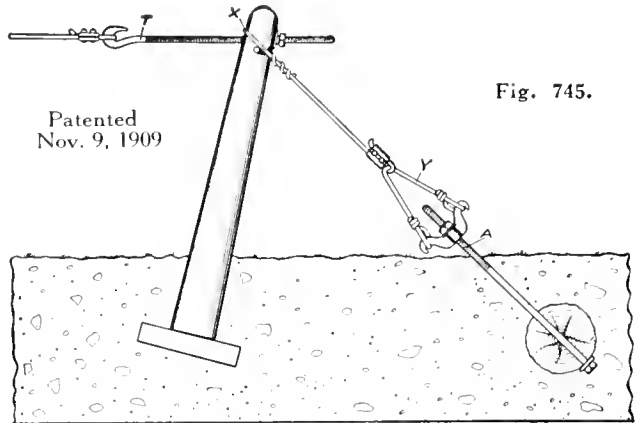

Fig. 745.

Patented
Nov. 9, 1909

Wire Track Anchor

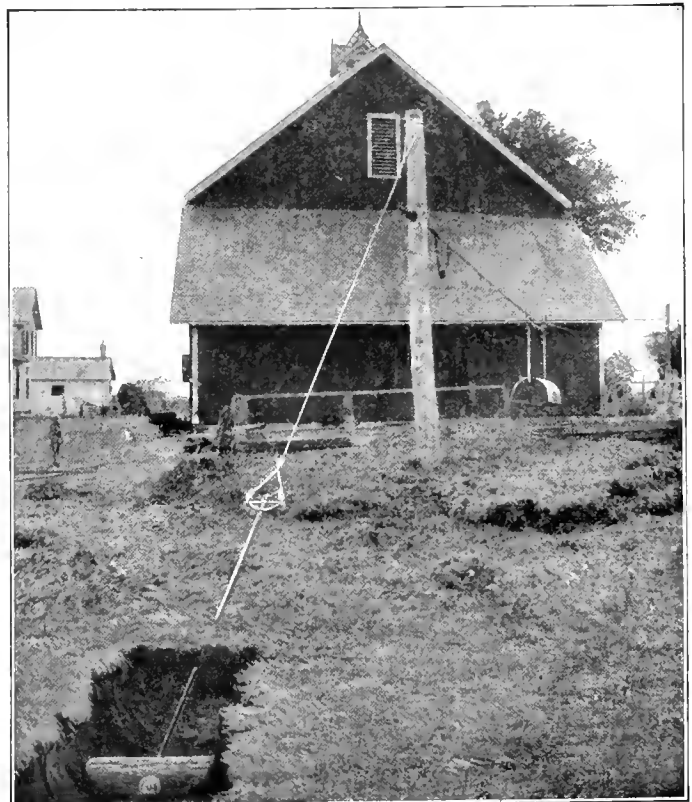

Fig. 1068.

Louden Wire Track Switches

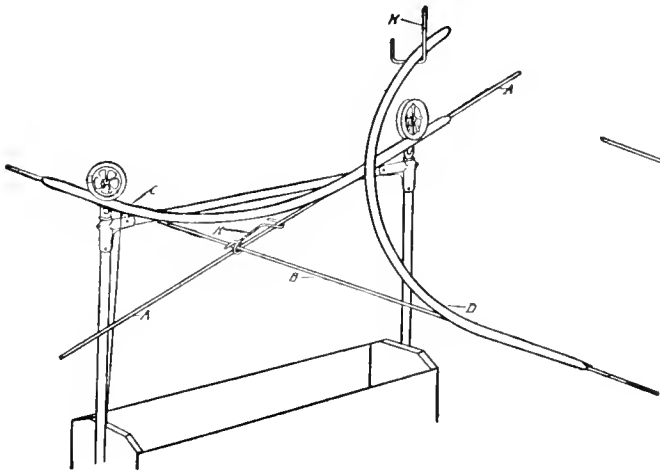

Fig. 892.

(Hurrah).

Patented Oct. 6, 1908

Specifications

Length, 72 inches.
Weight, 5 $\frac{3}{4}$ pounds.

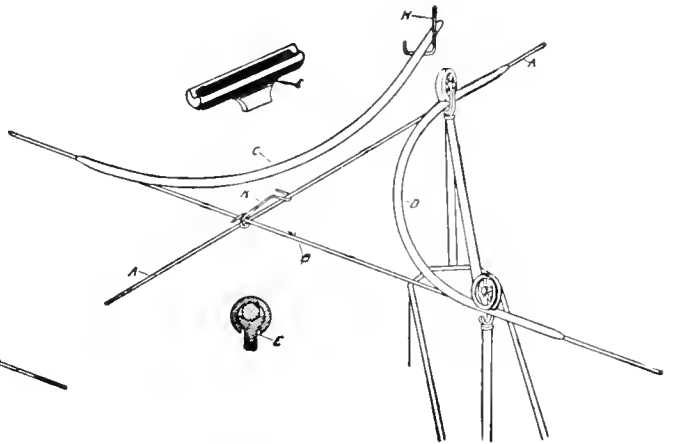

Fig. 893.

We have the most perfect switches ever devised for a wire track. They are made of pipe ("C" and "D") slotted on the lower side to fit over the wires and are held securely in place by specially fitted keys "E," which are readily driven in or out without kinking, or otherwise injuring the wire. The switches can be easily and quickly placed or removed and will run in both directions so as to form a Three-Way switch.

Figure 892 shows the switches set for carrier to pass from the main line "A" to the left hand line "B."

Figure 893 shows switches set for carrier to pass onto the right hand side line "B." To change the carrier to the opposite side, the wheels must be lifted from the track and swiveled around so the castings supporting the wheels will be on the same side of the main wire as the switch that is being used. This is easily and quickly done by lifting the entire carriage, one end at a time, and setting the wheel on the opposite side of the wire.

The switches are interchangeable and one switch instead of two may be used, changing the switch from side to side. Where it is desired to use the main line "A" and pass under the cross line "B," place the end of both switches in the hook "H" and remove the cross track holder. The sag of the main track "A" will easily let the carrier wheels pass under the cross track "B."

When two tracks cross and switches are used something is needed to hold the tracks together. This we accomplish by means of cross track holder, Figure 749. It is hooked on the wire "B" so the point "P" will pass under the wire "A" and then over the wire "B" on the opposite side. It is held in place by pressing the hook "C" up over the wire "A."

There is more strength and less friction in the Louden wire track switches than any others, and they are the easiest and quickest to change from one position to another.

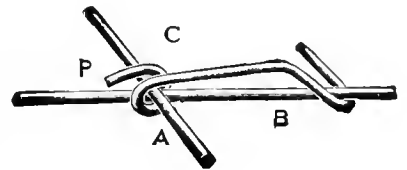

Cross Track Holder. Fig. 749. (Hopple).

Specifications

Weight, $\frac{1}{2}$ pound.

Louden Machinery Company, Fairfield, Iowa.

Dear Sirs:

Three years ago we had one of your carriers installed. Today I wouldn't have it taken out for five times what it cost. It is as good as new and has never cost us one cent for repairs. Can feed twenty-five head of cattle with one filling of carrier. We have had the stanchions, calf pen, bull pen and one box stall for two years and we are perfectly satisfied with them.

Oconomowoc, Wis.

Yours truly,
Miller Bros.

Louden Wire Track Reverse Curve

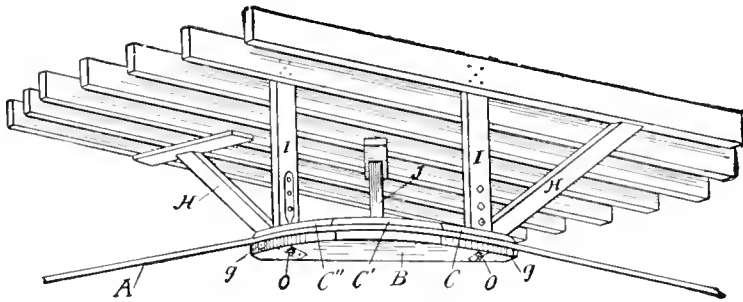

Fig. 797. (Tense.)
Patented Mar. 31, 1908

Specifications

Length, 41 inches.
Weight, 20 pounds

By the use of our reverse curves and switches the Wire Track Litter Carriers may be run around either inside or outside curves. Figure 797 shows our reverse curve as it appears when used inside of building, where it is attached to and supported by the joists or ceiling.

Sundry Wire Attachments

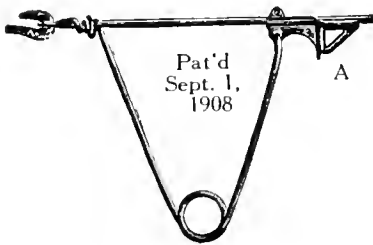

Fig. 753. (Hurl.)



Fig. 755.



Fig 757. (Hone.)



Fig. 756.

Specifications

Spring End Stop.

Distance from bottom of spring to track, 16 inches.
Weight, 4 pounds.

Anchor Loop.

Length, 14 inches
Weight, 2 pounds.

Improved Clamp Loop.

Weight, $\frac{3}{4}$ pound.

Anchor Yoke.

Length, 20 inches.
Weight, $4\frac{1}{8}$ pounds.

Figure 753 is a detail view of our Patent Spring End Stop, the most complete device of the kind ever invented. It is composed of two malleable iron pieces bolted together so as to slide freely on the track, and connected to a special spring as shown. The wheel yokes of the carrier straddle the pointed ends of these pieces and cannot run off. The spring eases off the momentum of the carrier and starts it back on its return trip. The spring and the pieces "A" can be easily removed from or replaced upon the track.

Figure 755 is a detailed view of our Improved Anchor Loop which goes over the top of the post as in Figures 745 and 1068 (page 188). It is made of 0000 wire, the same as the track, and will stand any strain that can be put upon it. Figure 756 is our Patent Anchor Yoke with malleable casting for anchor bolt, as shown in Figures 1068 and 745. It will stand a tremendous strain. Anchor Loop, Figure 755 and Anchor Yoke, Figure 756 are included with the Complete Anchor, Figure 745, page 188.

Figure 757 shows different ways of looping the track and guy wires. The upper is the common way of twisting the wire around itself. The lower is our Improved Clamp Loop. The first is good enough for a moderate strain, or where the wire is double, as in our anchor loops or anchor yokes; but when there is only a single loop the Clamp is much stronger and better, as well as easier made and attached and detached. All that is necessary is to remove the bolts which hold the clamps, and it can be hooked into an eye, which cannot be done with a twisted loop.

Louden Machinery Company, Fairfield, Iowa.
Gentlemen:

Kootenai, Idaho.

I have used your Stanchions and Manure Carriers since last fall and am well pleased with them. In fact, I don't know how I got along without them before. The manure I notice is far better this spring. The horse manure used to burn in the pile, and now I get it mixed with the cow manure and it improves them both.

Respectfully yours,
Matt Schmitt.

Plans for Installation

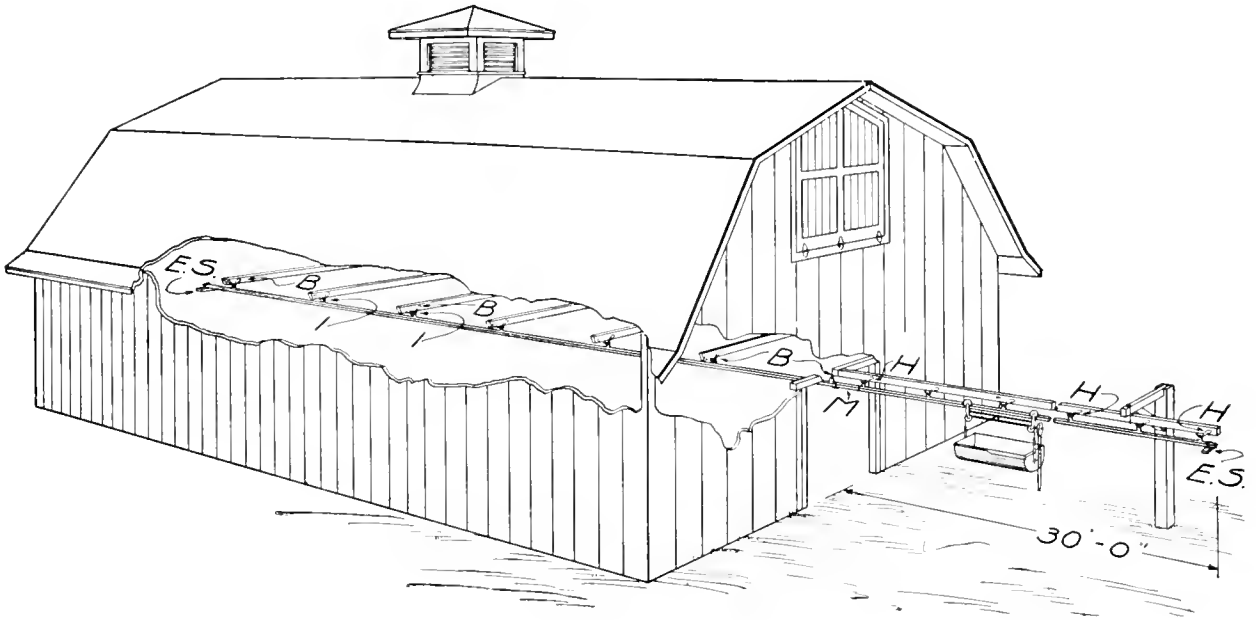

Plan No. 1.

We show here a few plans to illustrate some of the many ways in which Louden Carriers can be made to meet any plan, no matter what the seeming difficulties. The plans mean nothing so far as size and shape of buildings are concerned and the length and width are given that you may understand how to figure the number of feet of track and the number of other fixtures required.

Plan No. 1 shows a straight run of solid steel track extending from the rear of the building 30 feet out in the yard. For this arrangement the following would be required:

	Figure	Page
70 ft. Double Bead Steel Track.....	571	175
24 Link Track Hangers (5-inch length).....	832	175
14 Rafter Brackets "B".....	424	175
10 Ridge Pole Brackets "M".....	465	175
1 Automatic Track Opener.....	859	182
2 End Stop Blocks "ES".....	523	175
1 Emancipator Litter Carrier.....	828	157

In all of the plans where the Automatic Track Opener, Figure 859, is specified, the Removable Section, Figure 633, page 183, may be substituted if desired.

Joists are usually 18 inches on center. We recommend a supporting hanger and bracket every other joist or every 3 feet for the Double Bead steel. If the joists are 24 inches on center it would be well to use a hanger on every joist, as four feet is rather too wide a space between hangers, especially if the work is to be heavy.

Plans for Installation—Continued

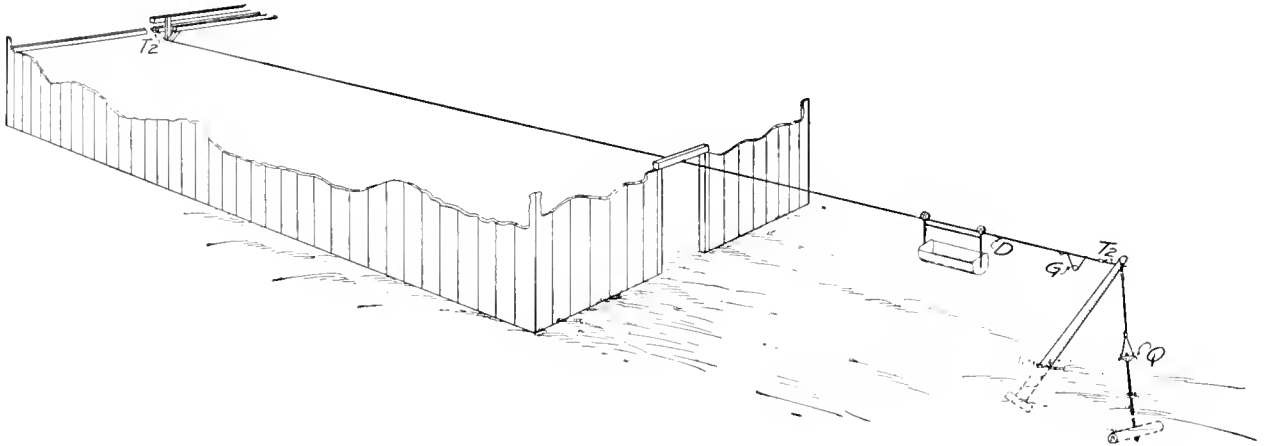

Plan No. 2.

Plan No. 2 shows the same plan as No. 1 but equipped with our wire track Litter Carrier System. This illustrates the use of the Self-Acting Carriers which can be loaded at any point along the track, given a push and they will run out and empty at the trip "D," strike the spring "G," and return to the building. For this plan the following would be required:

Self-Acting Carrier

	Figure	Page
1 Self-Acting Litter Carrier	721	163
70 ft. 0000 Basic Steel Wire	Top of	187
2 Tension Bolts, $\frac{3}{4}$ x 30 "T"	1207	188
1 Wire Track Anchor "Q"	745	188
1 Patent End Stop "G"	753	190
2 Loop Clamps "L"	757	190

One trip "D" is furnished free with each wire track Litter Carrier. Where two or more tracks are used or the carrier is to be unloaded at two different points extra trips "D" should be specified.

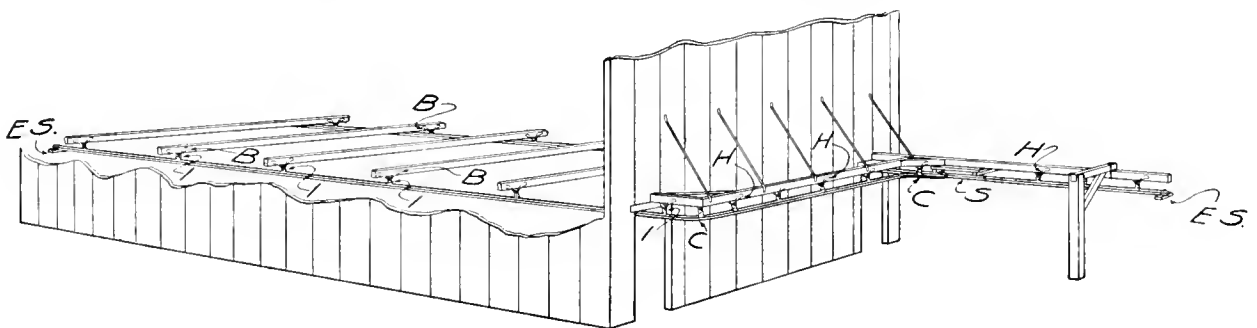

Plan No. 3.

Plan No. 3 shows a barn with a stable on each side and a solid steel track for litter carrier in each stable. One track runs in a straight line 40 feet out into the yard. The other track, after passing through the door, is curved and carried along the end of building, another curve is used before it joins on the switch and joined onto the straight track with a two-way switch.

Note.—When track runs at right angles to joists, Rafter Brackets, Figure 424, page 175, are used. When the track runs parallel with and is supported under a 2-inch joist or other timber the Ridge Pole Bracket, Figure 465, page 175, should be specified. Screw Eyes are used for smooth ceilings and may also be substituted for the brackets whenever desired.

Plans for Installation—Continued

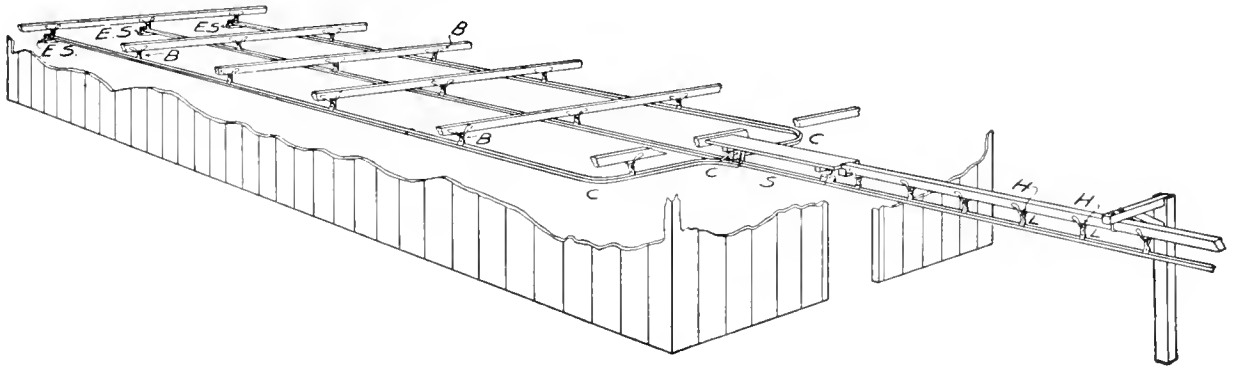

Plan No. 5.

Plan No. 5 shows a building with three tracks inside joined together by a three-way switch near the door and a single track continuing 40 feet out into the yard. For an arrangement of this kind the following items would be necessary:

Emancipator Carrier

	Figure	Page
216 ft. Double Bead Steel Track	571	175
4 Bent Sections "C" for Curves	639	183
80 Link Track Hangers (5-inch)	832	175
56 Rafter Brackets "B"	424	175
24 Ridge Pole Brackets "H"	465	175
1 Three-Way Switch "S"	795	181
1 Automatic Track Opener	859	182
4 End Stop Blocks	523	175
1 Emancipator Litter Carrier	828	157

If the arrangement of the building does not permit placing the switch inside, the three tracks may be joined on the outside by supporting the two side lines along the end of the building as shown in plan No. 3, page 192. If desired, one of the side lines of track can be run straight out from the building and the tracks connected by the use of two Two-Way Switches instead of one Three-Way Switch.

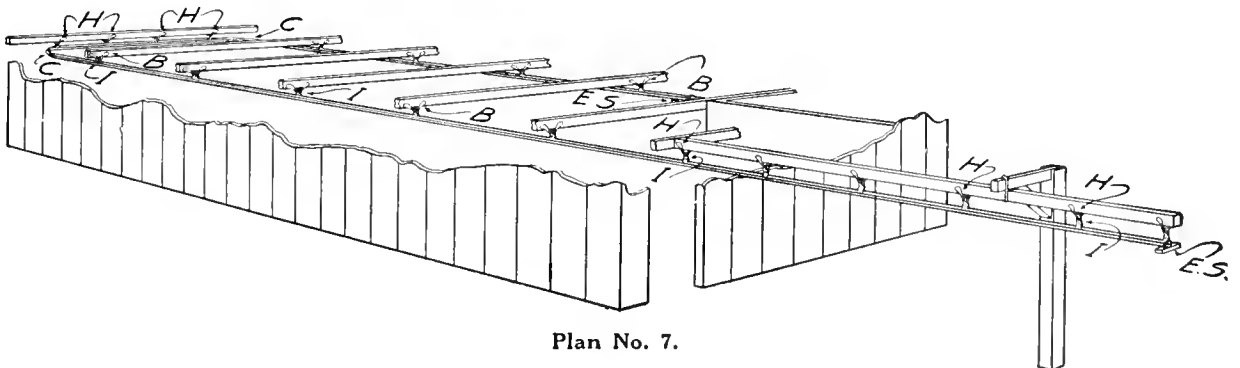

Plan No. 7.

Plan No. 7 shows an arrangement for solid steel track in a building with a double row of stalls and all of the litter to pass out at one door. At the rear of the building the track is curved, crosses the end of the building and continues in a straight line out into the yard. No switches are necessary.

A WELL EQUIPPED
HORSE BARN
Is a Source of Satisfaction to the Owner,
and a Profitable Investment.



Wm. Butterworth's Horse Barn, Moline, Ill.
Louden Planned and Equipped

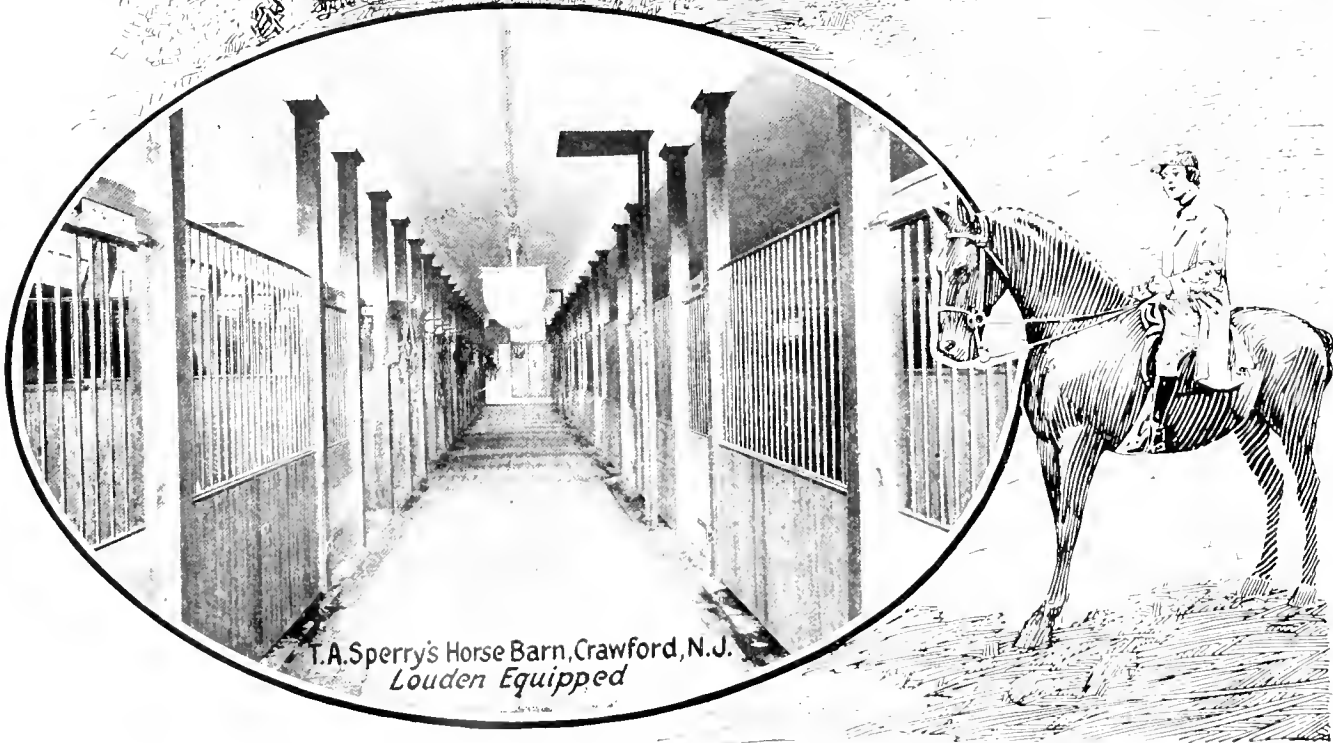
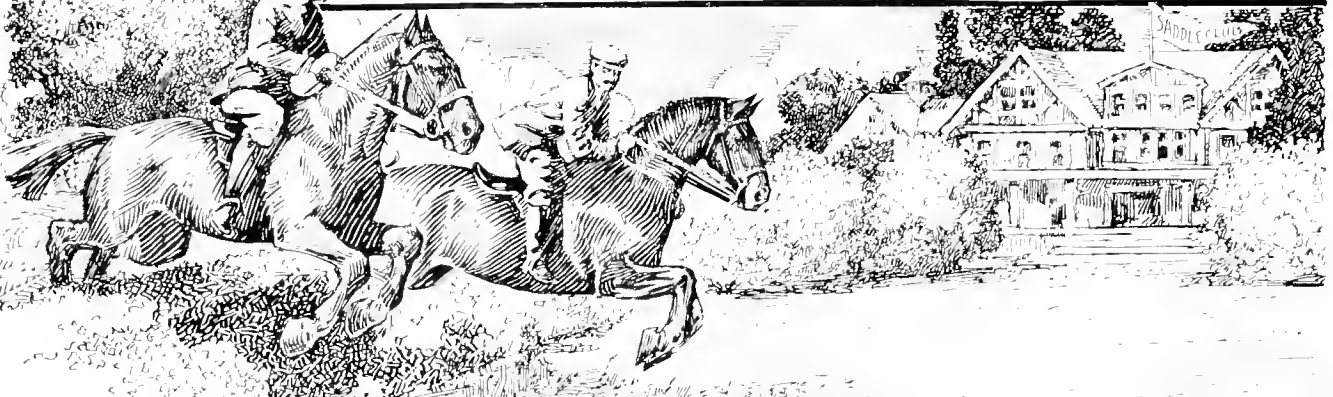

T. A. Sperry's Horse Barn, Crawford, N. J.
Louden Equipped

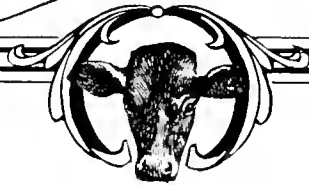
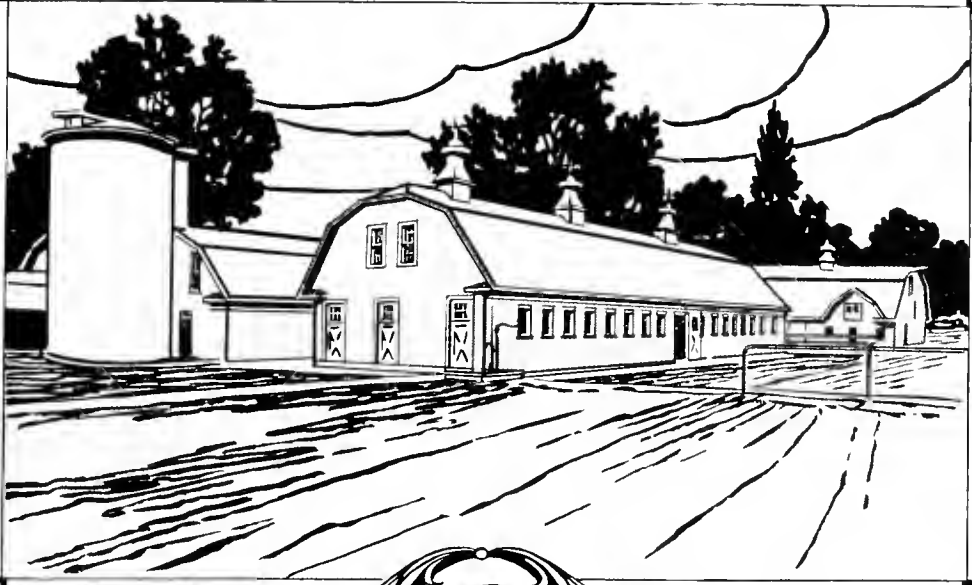

HORSE BARN EQUIPMENT

	PAGE
Hay Racks.....	198-203
Feed Boxes.....	204-206
Window Guards.....	207
Water Troughs.....	207
Stall Guards.....	208-210
Harness Hooks.....	210
Salt Rolls and Holders.....	210
Stall Posts.....	211
Cess Pools.....	212
Oats Cleaner.....	213

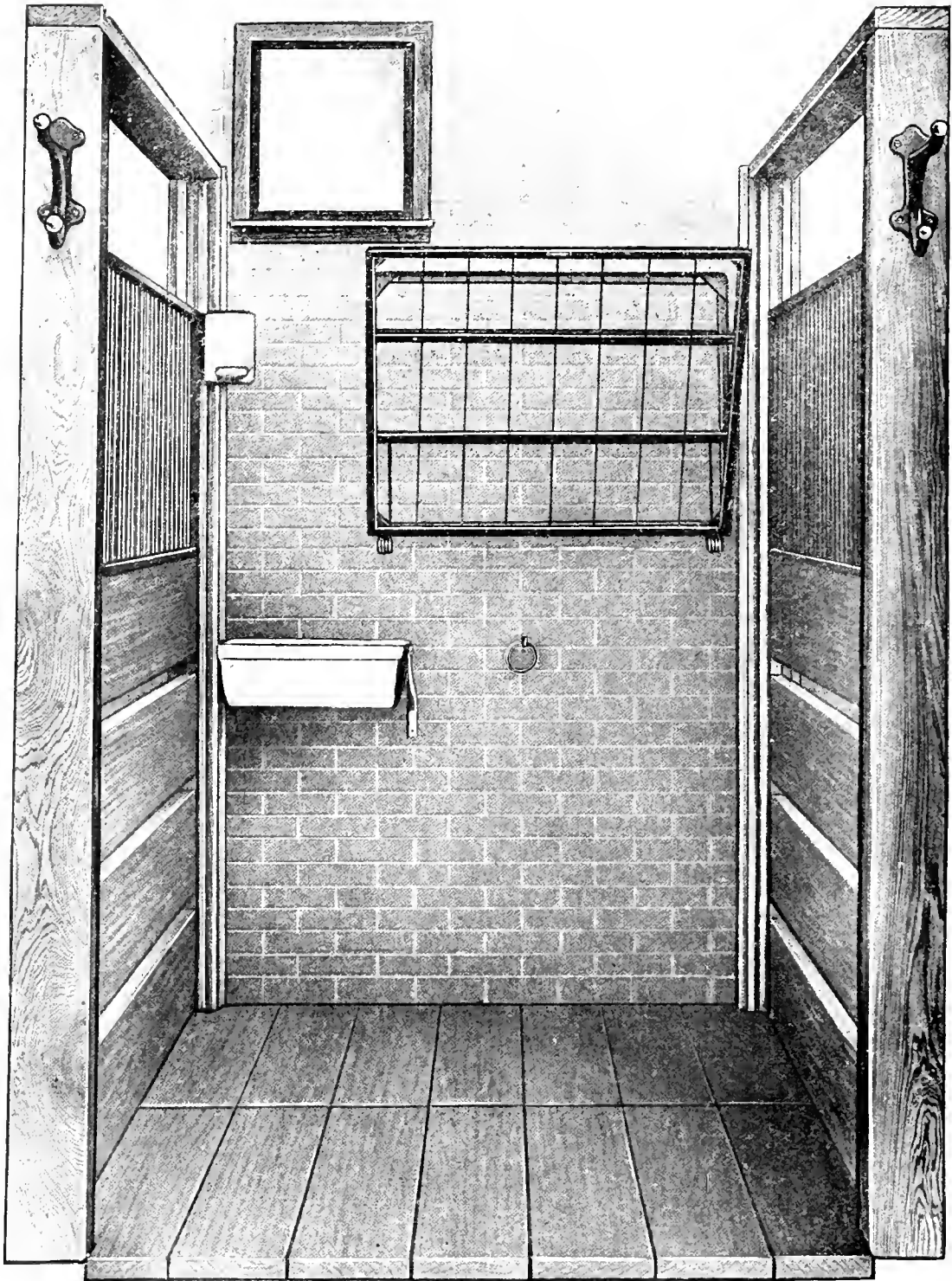

A modern, sanitary, economical, durable, and convenient type of horse stall
Complete in every detail

Horse Stable Equipment

You have noticed how a horse sticks his nose down to the bottom of the manger, roots around awhile, and then pulls out a hatful or so of hay onto the floor with his nose.

You have seen him when he was eating grain, push a handful or two over the side of the box in his earnest attempt to get a big mouthful.

You have noticed your horses do these things; but did you ever try to imagine the total expense in this waste?

Conservative estimates place this waste at 20% of the feed given the animals. Figured on this basis the average horse wastes something like \$15 or \$20 each year.

Louden Horse Stable Equipment was designed to prevent, and does prevent, this waste. It also gives to the barn a clean, up-to-date appearance, is more sanitary, and keeps the horses in better condition at all times.

The cost of the equipment is more than saved in a very few months. The purchase is good business judgment, whether the buyer is farmer or town man. For years the city big barn owners—stables where from 50 to 500 horses are fed—have realized the necessity of this feed-saving, money-making equipment, and now up-to-date, economical farmers everywhere are putting it in.

It costs no more to install modern, time-saving, sanitary steel and iron equipment than it does to build of lumber.

For nearly a half century we have been making a study of barn needs and have the most complete line ever offered.

Louden Horse Barn Equipment, Louden Dairy Barn Equipment, Louden Hay Unloading Tools, and Louden Litter and Feed Carriers are known for their high quality in every country. It is our aim to make the name Louden stand for all that is best in barn equipment.

THE LOUDEN MACHINERY COMPANY

Automatic Hay Racks Figs. 1210 to 1218

(Warren Patent)



Fig. 1210

Specifications

- Styles Made:** For horses; for cattle; for sheep. Each style in many different sizes to meet any ordinary requirement.
- Construction:** Neat, strong, rigid. Will stand hard usage. Main framework (Full Back construction) 1x1 inch high carbon steel angles. Corners are rounded and reinforced with steel plates. Frame is also braced by angle cross bars and upright $\frac{3}{4}$ -inch spring steel rods which will bend, but always spring back into place. Space between rods is varied to meet requirements of horses, cattle, sheep, and calves.
- Open Back Construction:** Same as Full Back, except the back does not have upright rods.
- Full Back construction is used where both front and back of rack must be utilized to hold in hay.
- Open Back construction is recommended where rack sets against solid wall, or on the outside of a pen.
- Automatic Action:** A special torsion coil spring which also acts as the hinge upon which rack operates.
- Spring:** 2 5-16 inches, outside diameter, made of $\frac{3}{8}$ -inch steel. Every spring given severe test before sold, and is guaranteed against defect or breakage.
- Locking Device:** Consists of two $1\frac{1}{4}$ -inch steel side arms operating in steel links. Links work in unison. Will allow rack to be locked when opened to widest point. Rack closes completely when unlocked, except when feed is in rack.
- Operation:** Pull rack open till it locks. Put in hay. Raise locking arm and rack closes against hay. Pressure is constant and hay is held firmly at all times. As the animal eats the hay, the rack closes, slowly and automatically.
- Rods:** Held securely by the angle steel.
- Finish:** Special quality black Japan.
- Installation:** Plain bolts for installing are furnished with each rack. Lag bolt expansion shields for brick or cement walls are extra.

Warren Automatic Hay Racks—Continued

Sizes, Weights

Figure	Height	Full Back			Open Back	
		Width	Weight	Figure	Weight	
1210	36 in.	42 in.	49 pounds	1210 ¹ / ₂	40 lbs.	
1211	36 in.	48 in.	54 pounds	1211 ¹ / ₂	45 lbs.	
1212	36 in.	36 in.	44 pounds	1212 ¹ / ₂	37 lbs.	
1213	42 in.	36 in.	51 pounds	1213 ¹ / ₂	41 lbs.	
1214	30 in.	54 in.	53 pounds	1214 ¹ / ₂	44 lbs.	
1215	36 in.	72 in.	85 pounds	1215 ¹ / ₂	74 lbs.	
1216	(Pony) 30 in.	30 in.	33 pounds	1216 ¹ / ₂	26 lbs.	
1217	(Sheep or Calf) 24 in.	54 in.	42 pounds	1217 ¹ / ₂	35 lbs.	
1218	(Cow Pen) 36 in.	36 in.	42 pounds	(Open Front only for Cow Pen)		

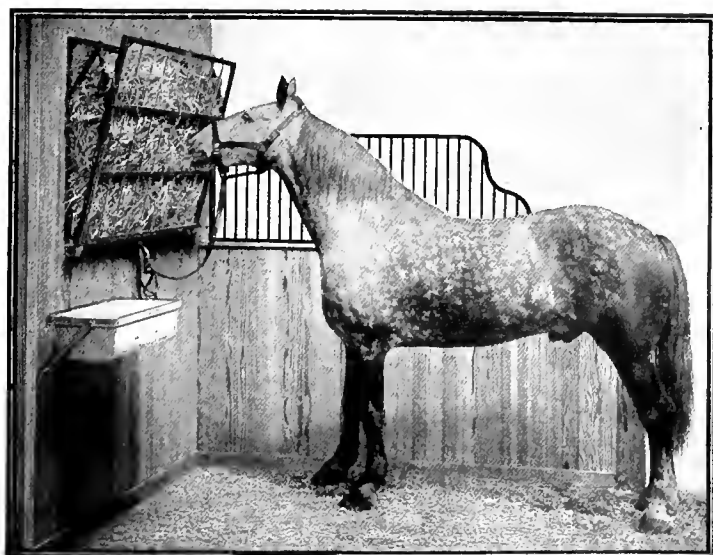

Rack in Feeding Position

No means of feeding hay has ever been devised that so totally eliminates all waste. The horse pulls out a mouthful at a time and the rack gradually closes as the hay is eaten out, the hay being held with sufficient firmness to keep it from falling out at the sides of the rack, but not so tightly that the horse cannot eat comfortably.

The value of this automatic closing feature cannot be over-estimated, for without it no rack can completely prevent the waste of hay. By means of the opening and closing device, the rack can be instantly locked open and conveniently filled. After being filled the catch is released, allowing the rack to close automatically against the hay by means of the springs.

The rack is practically self-cleaning, as dirt or chaff sifts through to the floor. In the old-fashioned type of manger this chaff and dirt settles to the bottom of the manger and is often breathed into the nostrils of the horse while eating. Failure to clean

out the old-fashioned manger also causes much hay to be spoiled by this chaff and dirt mixing with the hay.

Another advantage in the Automatic Hay Rack is the removal of danger to the animal's eyes. Under the old-fashioned feeding arrangements often a horse's eyes have been injured by straws while the animal was rooting in the manger. This cannot occur with the Automatic Rack.

There are no sharp corners or points on which an animal can injure itself. Still another advantage is the free circulation of air about the horse's head at all times. This feature can best be appreciated during hot weather.

The Automatic Hay Rack is constructed to withstand rough usage. The material used is the best steel, and as there are no "wearing points" the rack will last a lifetime.

The Automatic Hay Rack is made in many sizes and in different styles to meet every requirement, but the principle is the same in each. All styles have the same strong, almost indestructible steel construction with the automatic spring-press feature.

Open Back Construction

Warren Automatic Hay Racks with Open Back Construction, should be specified when to be attached to wood, cement, or brick surfaces.

The principal advantage of having these racks furnished without the upright wiring in the back is to eliminate the possibility of hay accumulating between the back of the rack and the wall. While the regular full-back rack can be used, the Open Back is preferable and can be furnished at a reduced cost.

When our racks are to be installed in stables where the windows have been set exceptionally low, our 22-inch Open Back, as illustrated in Fig. 1210¹/₂-A, can be used to advantage. This allows the rack to be installed flush with the under side of the window sill where it will not interfere with the opening and closing of the window.

Open Back Construction—Continued

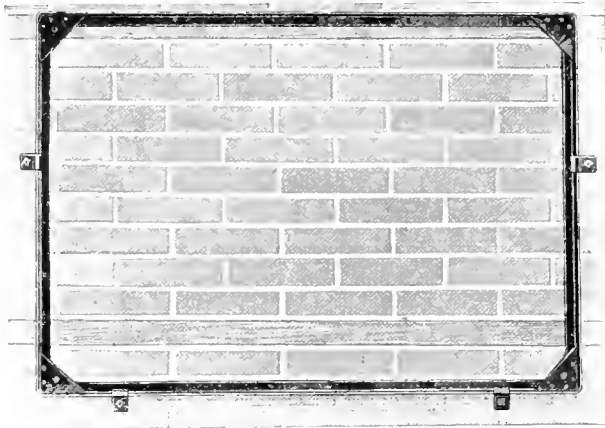

Fig. 1210¹/₂-A

Manner of Attachment to Brick Wall

Fig. 1210¹/₂-A illustrates our improved method of attaching Open Back Racks to brick or cement walls. This is done by means of steel clamps which are adjustable up and down between the angle iron uprights at either end of the frame.

In new construction bolts or 2 x 4s are usually set in the wall to which these clamps are attached. If bolts are used they must be spaced the proper distance apart lengthwise. Complete measurements with full information will be furnished upon request.

Where the walls are already constructed the frame may be as securely attached with expansion bolts.

The vertical adjustment of the clamps allows for any up-and-down variation in the spacing of either the 2 x 4s or bolts.

See page 199, for sizes in which the Open Back Racks can be furnished.

Operation of Racks and Feeding

Loft and Front Aisle Feeding

Filling the rack from front aisle is illustrated in Fig. 1221. Here the back is the movable portion and operates the same as the front in other installations. The locking open device and the releasing is the same as illustrated and described on foregoing pages. When filled and released it occupies but a small amount of the aisle space. The heavy spring pressure holds the hay to the front feeding surface and keeps it within easy reach of the animal until entirely consumed.



Fig. 1221

Filling from Front Aisle

In stables arranged for feeding the hay from the loft, our racks may be used with exceptional advantage and are very conveniently filled as shown in illustration. Chutes are not necessary as the opening of the rack is sufficiently wide to catch the hay. Where the ceilings are exceptionally high, we suggest the use of Special Hay Rack, which has greater height.

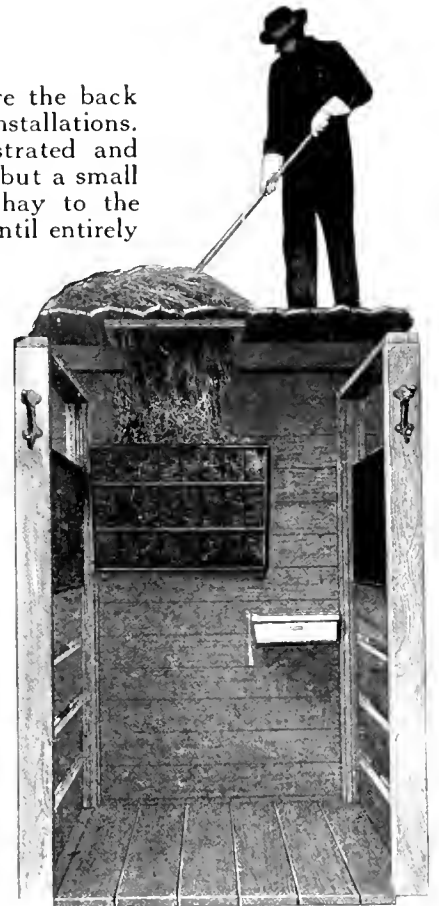

Filling Rack from Loft

Wrought Iron Center Hay Rack — Fig. 1225



Wrought iron Center Hay Rack

Specifications

No. 1225-A. Small Size: 24 in. wide by 30 in. high by 16 in. deep. Weight, 31 pounds.

No. 1225-B. Medium Size: 30 in. wide by 30 in. high by 16 in. deep. Weight, 37 pounds.

No. 1225-C. Large Size: 42 in. wide by 30 in. high by 16 in. deep. Weight, 44 pounds

Upright bars are $\frac{1}{2}$ -inch rods, set $3\frac{3}{4}$ inches apart.

Main frame and cross bars are $1 \times 1\frac{1}{4}$ inch size.

Where a heavy, strong hay rack is desired to attach to the wall, and the spring-press feature is not essential, this rack can be recommended. It is being used in thousands of barns and is giving complete satisfaction from the standpoint of convenience, sanitation, and durability.

The construction is such that the rack is almost indestructible. The upright rods are $\frac{1}{2}$ -inch size, spaced $3\frac{3}{4}$ inches apart—just the right distance to make feeding convenient, but not so far apart that the hay will work out. The cross rod near the top of the rack adds greatly to the strength and rigidity.

Wrought Iron Corner Hay Rack — Fig. 1226

Specifications

Height, 35 inches.

Projects out from corner, 24 inches.

Uprights are heavy $\frac{1}{2}$ -inch rods, spaced $3\frac{1}{2}$ inches apart.

Weight, 27 pounds.

Our Fig. 1226 Wrought Iron Corner Hay Rack is a strong, durable rack that will stand hard usage. It is suitable for either side of stall. The cross bar adds greatly to the strength and rigidity of rack. We recommend this rack for convenience, durability and sanitation. It is one of the biggest selling hay racks ever put on the market.

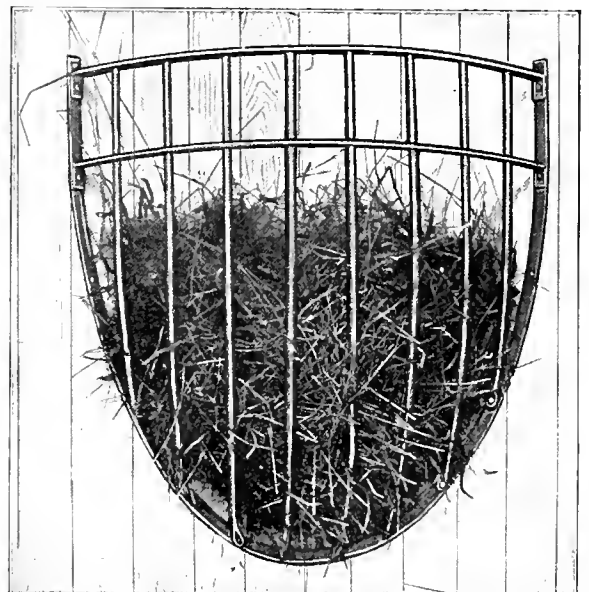

Wrought Iron Corner Hay Rack

Extended Hay Rack For Hay Chute—Fig. 1227

(Flat Wall)

Specifications

No. 1227. Height, 5 feet; width, 33 inches; extends 18 inches from wall.

Uprights are heavy $\frac{1}{2}$ -inch rods, spaced 4 inches apart.

Main frame and cross braces are of $1 \times \frac{1}{4}$ inch size.

Weight, 57 pounds.

No. 1227^{1/2}. Height, 5 feet 6 inches; width, 42 inches; extends 19 inches from wall.

Uprights are heavy $\frac{1}{2}$ -inch rods.

Main frame and cross brace, $1 \times \frac{1}{4}$ inch bars.

Weight, 67 pounds.

This rack is long enough to reach to the average mow, and where used, there is no opportunity for hay to be scattered on the stall floor while being filled. This advantage soon pays for the additional cost of this rack over lower racks in the average barn. More hay can be put into this rack at one feeding, thus saving some labor.

The rack is strong and substantial and adds greatly to the good appearance of the barn. It is cross braced and heavy.

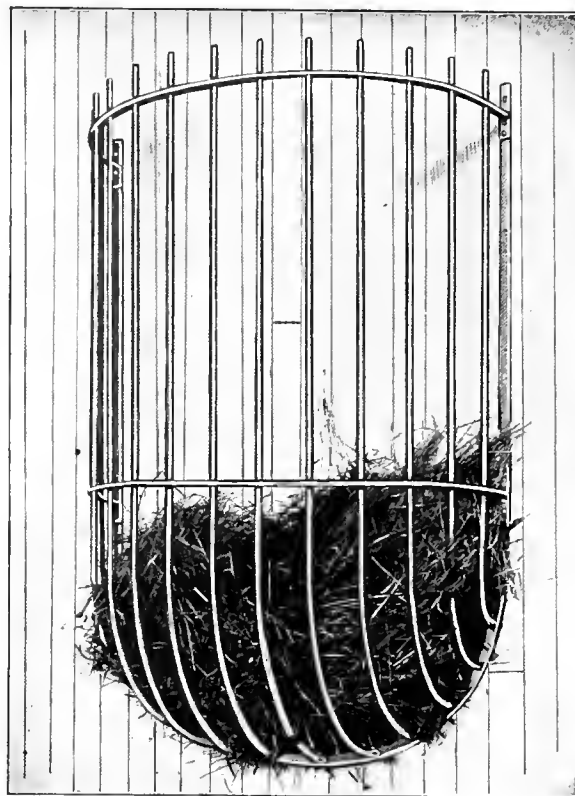

Fig. 1227

Extended Corner Hay Rack For Hay Chute—Fig. 1228

(Corner Rack)

Specifications

No. 1228. One size only.

Made either for right or left corner of stall. Cut shows left hand. (In ordering be sure and state whether rack is to be used in right or left hand corner of stall.)

Height, 5 ft. 6 inches.

Projects 20 inches from corner.

Uprights: Heavy $\frac{1}{2}$ -inch rods.

Main frame and cross brace, $1 \times \frac{1}{4}$ inch rods.

Weight, 38 pounds.

Like Fig. 1227 this rack is high enough to be filled from the mow without wasting any hay. It is made either for right or left corner of stall. Illustration shows left hand corner style.

The heavy cross-braced construction of this rack is a guarantee of its durability. It should outlast the barn.



Fig. 1228

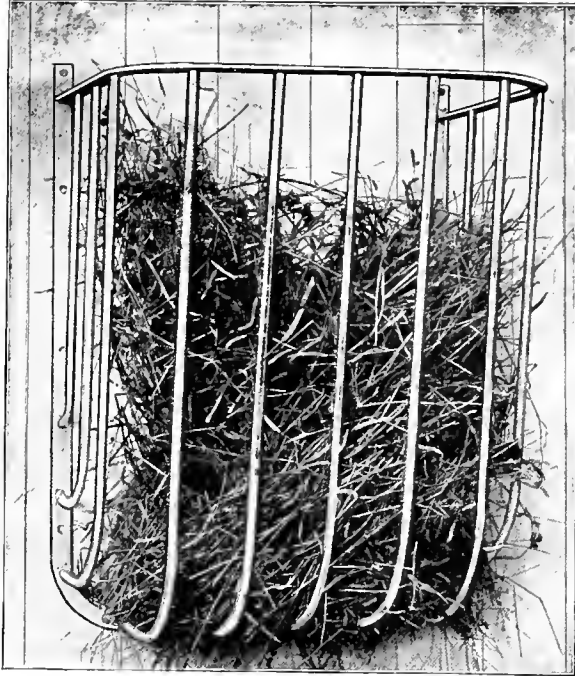

Fig. 1229

Wrought Iron Corner Hay Rack Fig. 1230

(Without Crossbar)

Specifications

One size only. Projects out from corner 24 inches. Height, 35 inches. Uprights, heavy $\frac{1}{2}$ -inch rods spaced $3\frac{1}{2}$ inches apart. Main frame, $1 \times \frac{1}{4}$ inch bars. Weight, 25 pounds.

This is a duplicate of our Fig. 1226, except that it does not have the extra bar near the top of the rack.

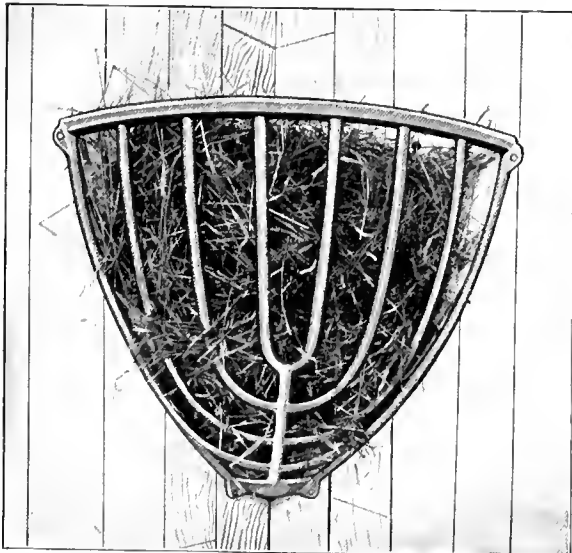

Fig. 1231

Wrought Iron Center Hay Rack — Fig. 1229

(Without Crossbar)

Specifications

No. 1229-A. Small Size: 24 in. wide by 30 in. high by 16 in. deep. Weight, 29 pounds.

No. 1229-B. Medium Size: 30 in. wide by 30 in. high by 16 in. deep. Weight, 36 pounds.

No. 1229-C. Large Size: 42 in. wide by 30 in. high by 16 in. deep. Weight, 40 pounds.

Upright bars are $\frac{1}{2}$ -inch rods set $3\frac{3}{4}$ inches apart. Main frame is $1 \times \frac{1}{4}$ in. bars.

This is a duplicate of our Fig. 1225 rack, except that it does not have the supporting cross bar below the top of the main frame. It is a strong, dependable rack, made in standard sizes.

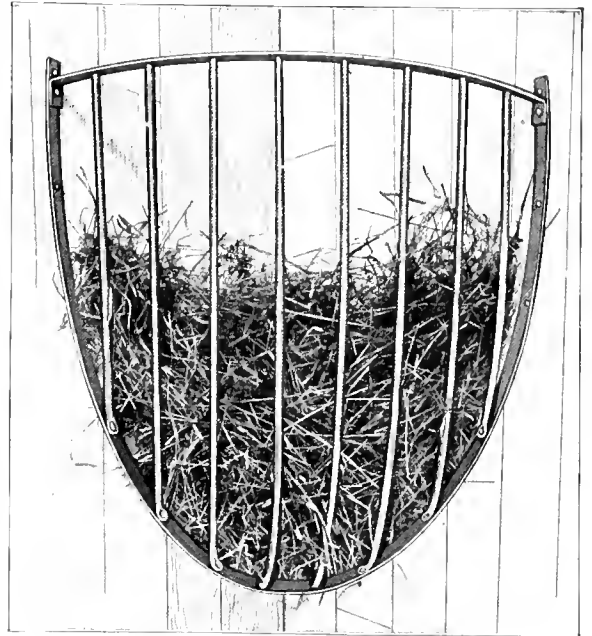

Fig. 1230

Cast Iron Corner Hay Rack Fig. 1231

Specifications

One size only. Projects out from corner 23 inches.

Width, 24 inches; height, 28 inches.

Uprights are spaced 4 inches apart.

Uprights are oval $\frac{1}{2} \times \frac{3}{4}$ inch bars.

Weight, 22 pounds.

This rack provides a very satisfactory corner feeding arrangement at a low price. Under ordinary conditions it should last a lifetime.

Sanitary Steel Feed Box—Fig. 1232

(Warren Patent)

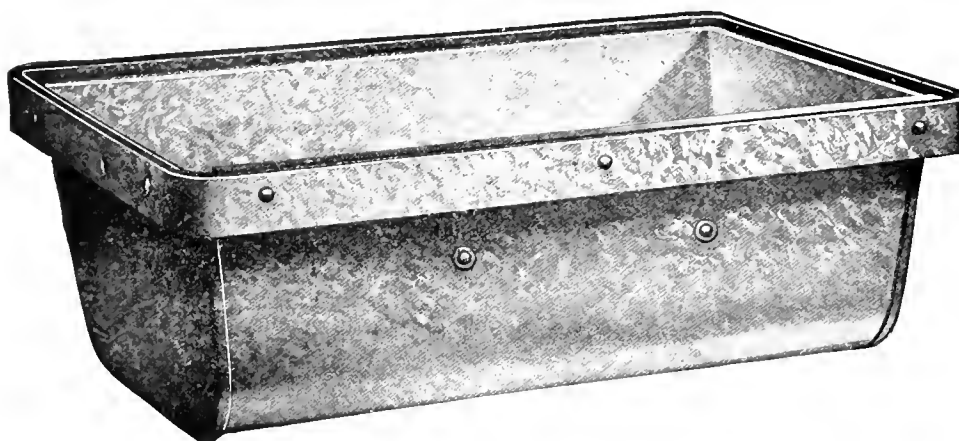
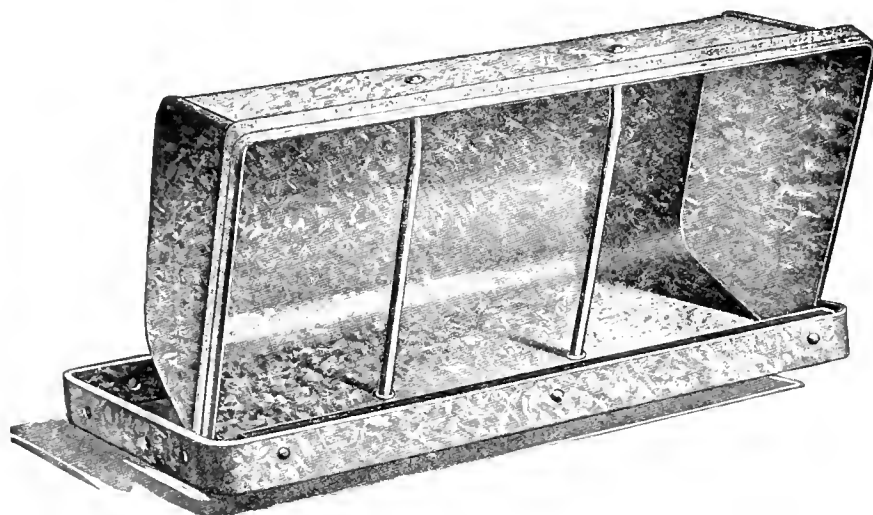

Fig. 1232

Specifications

Construction: Body of 18-gauge Wood's refined cold-rolled steel, reinforced around the top with a steel band. All corners are welded, making box rigid. All parts galvanized to make them rust proof. Two rods set across inside of box act as braces and prevent waste of feed.



Showing how box tips on pivots for cleaning; also shows cross rods which act as braces and prevent feed waste

Installation: Box sets in a heavy $1\frac{1}{2} \times 1\frac{1}{4}$ inch steel frame, to which it is attached at each end with heavy machine bolts which form pivots on which the box swings when it is tilted for cleaning. Cannot be tilted by horse.

Attachments: Steel clamps; one end brace, and lag bolts for installing are furnished with each box. If manger is to be set away from corner of stall, an extra supporting brace should be ordered. Where box is to be attached to brick or cement wall, expansion shields will be needed, for which a small extra charge will be made.

Sizes and Weights

(Box made in three sizes)

	Length	Width	Depth	Weight
No. 1232-A	20 in.	12 in.	7 in.	20 lbs.
No. 1232-B	20 in.	13 in.	9 in.	22 lbs.
No. 1232-C	14 in.	12 in.	7 in.	14 lbs.

Nos. A and B are recommended for horses. No. C is recommended for ponies.

Sanitary Steel Feed Boxes—Continued

(Warren Patent)

Our Sanitary Steel Feed Box was devised for the man who wants the best. It is more sanitary, more durable, more convenient, and of neater appearance than any other all-metal feed box on the market.

This box is practically indestructible. It is made of heavy material and in a most substantial manner. The body is constructed of 18-gauge Wood's refined cold-rolled steel, and is reinforced around the top with a steel band. No rivets are needed in the construction, as special double seaming machinery is used.

The most essential and exclusive feature in the feed box is the convenient arrangement for tilting. Near the front of the box on each end, a heavy machine bolt is attached to box and mounting frame. (See Illustration.) This bolt acts as a pivot, and the box can be turned entirely over and cleaned out before each feeding. As the rounded corners of the inside of the box make it difficult for dirt to accumulate, the box is always in a sanitary condition.

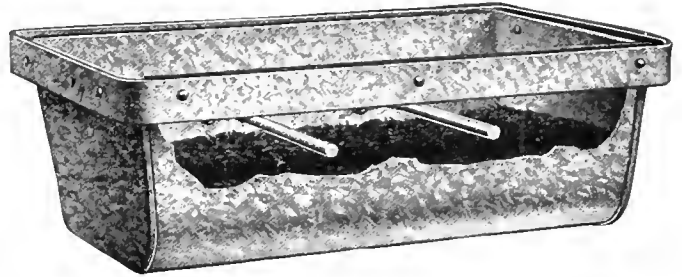

Showing amount of space an average feed occupies in the Standard Size Box

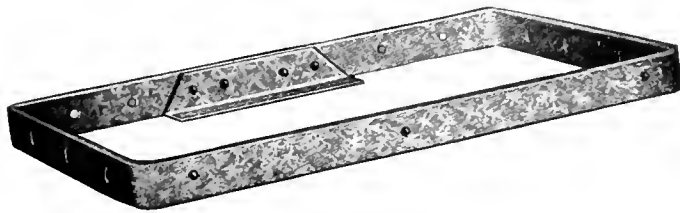

Frame in which box sets

All seams and pores are filled when the box is galvanized, thus creating a smooth surface, with no cracks or crevices to afford breeding places for disease germs.

The advantage in having such an easily cleaned feed box is self evident to the man who knows how quickly the ordinary feed box will accumulate dirt and dust, which, mixed with the slobberings of the horse makes a most unhealthful condition. Where bran mash and other quickly fermenting feeds are used, the need of an easily cleaned box is still more apparent.

Preventing Feed Waste

Illustration shows the space an average feed occupies in the box. It also shows position of the two rods or cross bars that prevent the animal from rooting out and wasting grain. It is estimated that a horse will root out and waste from 10 to 15 per cent of the grain when fed in an ordinary box. This saving alone would make the purchase a good investment, even without the sanitary features.

The round sloping bottom of box and the cross rods allow the grain to be well distributed, and provide a check on the too rapid eaters.

Sizes of Boxes

No. A box is considered standard for use in the average stable. It has a capacity of about $\frac{2}{3}$ bushel, and the average feed occupies the space below the cross bars.

No. B box has a total capacity of about a bushel, and where the feeding is very heavy, and bulky feed is used, it is recommended.

No. C is built exclusively for use in pony stables.

The Loudon Machinery Co.,
Fairfield, Iowa.

Gentlemen:

Yours of the 14th inst., received. Concerning barn equipment purchased of you last year, wish to say that so far as I can see it is very satisfactory and everything in smooth working condition on both farms. Certainly it has been a saving in labor to the tenants for with no more help they are caring for nearly twice the stock.

Kindly send me the catalog you mention as I may need some more equipment later on.

Arthur L. Olds.

Charles City, Iowa, July 15, 1916

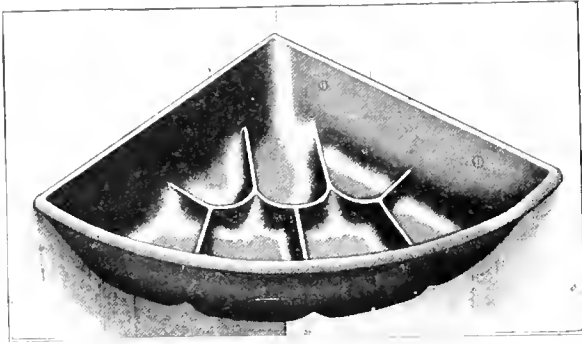

Fig. 1234

Patent Slow-Feed Corner Manger—Fig. 1234

Specifications

Size: 17x17x6 inches deep. Each manger has 7 cells, each holding one pint. Total capacity, 15 quarts.

Finish: Either japanned, galvanized, or enameled.

Weight, each, 32 pounds.

If you have a horse that eats too fast, here is the prevention. The illustration shows how the manger is divided into separate cells. These divisions make it difficult for a horse to bolt the grain. They also prevent the wasting of feed, as the animal cannot root grain over the edges of the box.

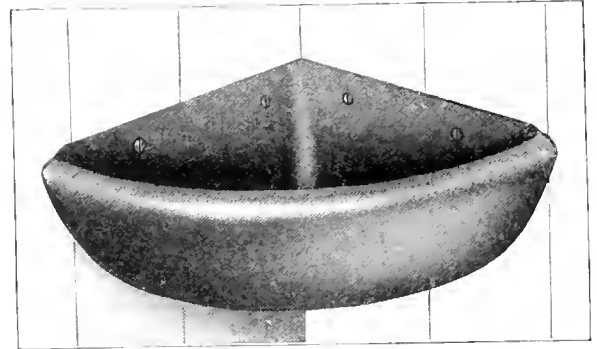

Fig. 1235

Roll Front Corner Manger Fig. 1235

Specifications

Dimensions: 17x17x10 inches deep.

Construction: Cast iron, with roll front as feed guard.

Installation: Attach to wall in corner with screws or nails.

Finish: Japanned, galvanized, or enameled.

Weight, 33 pounds.

This is a large, roomy, waste-preventing corner feed manger. The manger, being cast in one piece, is without seams or cracks and crevices to hold dirt.

The roll front, which extends over the front side of the bowl makes it impossible for the horse to drag the feed out.

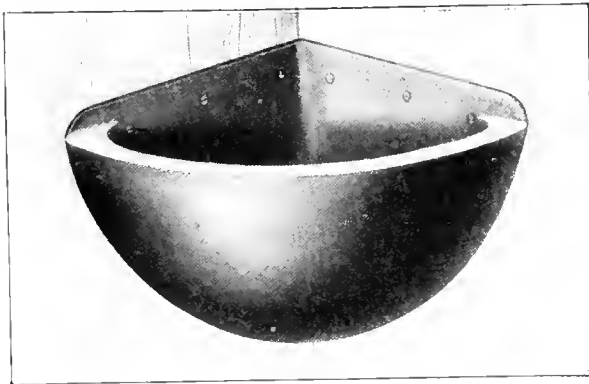

Fig. 1236

Flange Front Manger—Fig. 1236

Standard Size: 16x16x9½ inches deep.

Construction: Cast iron, with flange on inside of bowl to prevent feed waste.

Installation: Attach to corner walls with screws or nails.

Finish: Japanned, galvanized, or enameled.

Weight, 24 pounds.

Large Size: 17x17x10 inches deep. Weight, 28 pounds.

This is a very popular type of waste-preventing corner manger. The flange extends from one wall side to the other, and no grain can be dragged out with the nose.

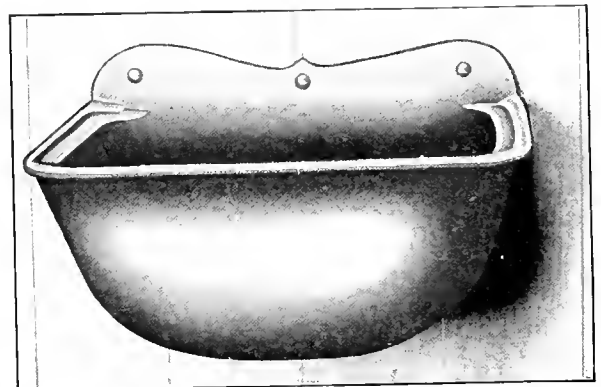

Fig. 1237

Wall Manger—Fig. 1237

Standard Size: 18x12x8 inches deep.

Construction: Cast iron, with feed flange on inside edges of front and two sides.

Installation: Attach to wall with screws or nails. Can be furnished on special orders with detachable wrought iron attachment to fasten to wall so manger can be removed at pleasure.

Finish: Japanned only.

Weight, 30 pounds.

Large Size: 24x14 by 11 inches deep.

Construction, installation, and finish same as Standard size. Weight, 40 pounds.

Wire Window Guards Fig. 1251

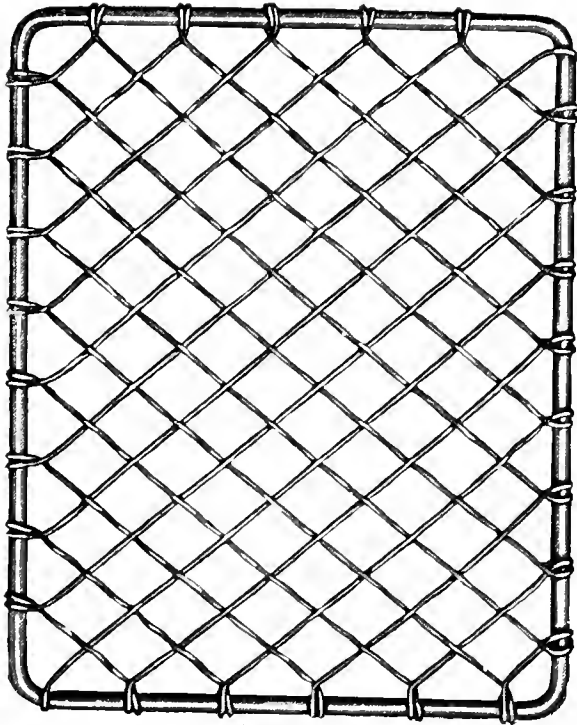

Fig. 1251

Louden Wire Window Guards will keep an animal from severely cutting itself in a broken window when excited. All windows near horses' heads should have guards. A Guard like the one illustrated is a complete protection. Factories, garages, and even private residences are often equipped with these guards as a measure of safety.

In ordering, always give exact overall size you want Guards made, *i. e.* extreme outside dimensions from out-to-out of wires clinching around the frame. **For "Diamond" Mesh Guards, please state which is the height.**

Our Wire Window Guard can be furnished in the diamond, diagonal, or square mesh. The illustration shows the diagonal mesh. All of the guards are well made, and strong. The usual size of the round rod frame is $\frac{5}{16}$ inches; $\frac{1}{4}$ -inch is sometimes used for small light guards and a $\frac{3}{8}$ -inch frame can be furnished for large ones.

Window guards are made in the following designs:

$\frac{3}{4}$ inch mesh, No. 14 wire
1 inch mesh, No. 14 wire
1 inch mesh, No. 13 wire
 $1\frac{1}{4}$ inch mesh, No. 13 wire
 $1\frac{1}{4}$ inch mesh, No. 12 wire

$1\frac{3}{4}$ inch mesh, No. 11 wire
 $1\frac{3}{4}$ inch mesh, No. 10 wire
 $1\frac{3}{4}$ inch mesh, No. 9 wire
2 inch mesh, No. 10 wire
2 inch mesh, No. 9 wire
2 inch mesh, No. 8 wire

$1\frac{1}{4}$ inch mesh, No. 11 wire
 $1\frac{1}{2}$ inch mesh, No. 13 wire
 $1\frac{1}{2}$ inch mesh, No. 12 wire
 $1\frac{1}{2}$ inch mesh, No. 11 wire
 $1\frac{1}{2}$ inch mesh, No. 10 wire

Iron Drinking Fountain Fig. 1238

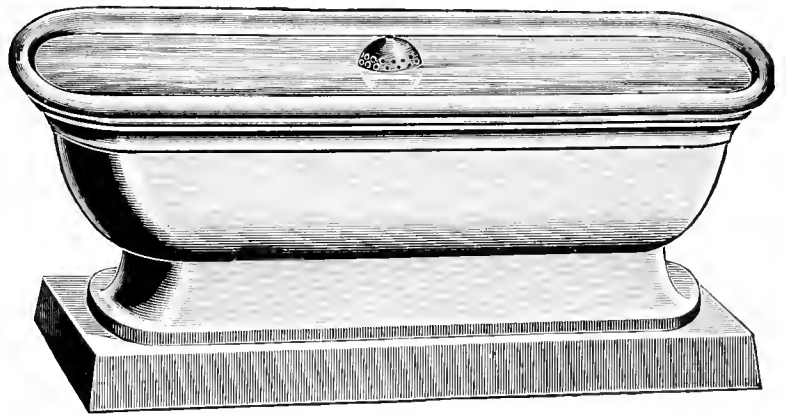

Fig. 1238

Specifications

Construction: Iron. Heavy, substantial, and sanitary. Equipped with overflow.
Dimensions: 1 foot 9 inches high by 3 feet 10 inches long by 2 feet 1 inch wide.
Base 3 feet 4 inches by 1 foot 6 inches.
Weight. 315 pounds.

Fig. 1238 shows a neat, artistic and convenient fountain for outdoor or indoor use. It is particularly desirable for a location where horses are to be watered from all sides. It is strong and heavy, and so constructed that when water is splashed over the edge it will run off the fountain quickly.

This fountain needs no bracing of any kind to insure its standing in place.

Louden Horse Stall Partition – Fig. 1241

The stall illustrated is an excellent type. The space between the planks, and the open steel partition permit free circulation of air, and the heavy plank and steel construction would make it extremely difficult for a horse to injure itself in any way.

The difference in cost of constructing a durable stall and a "makeshift" is very little. Horses are often badly injured by becoming frightened in a poorly constructed stall. The insurance alone is worth the investment, to say nothing of the pride a man enjoys in having a neat, attractive barn; and a Louden Stall is as cheap as lumber.

Figure 1241 shows an excellent method of constructing a horse stall.

Different requirements and personal opinions will vary the type of floor installed, so we will leave that to individual choice without recommendation or suggestions, except to say that a drainage should be provided to carry liquids into the gutter or pipe at the rear of the stall.

The Stall Partition above illustrated consists of:

- 4 Ten-inch Planks, 9 feet long. (We do not furnish planks.)
- 1 Extra Heavy Steel Stall Post, Fig. 1246-A, page 211.
- 1 Steel Stall Partition, Fig. 1242.

Any style of stall partition shown on following pages can be substituted for the one illustrated.

When desired the wood sides of stall may be constructed of upright boards, in which case our Cap Rail with groove for wood, should be used on the upper edge, and our grooved Base Rail should be used to hold lower end of boards firmly.

Where bottom of post is to be attached to floor, Fig. 1246 post may be substituted.

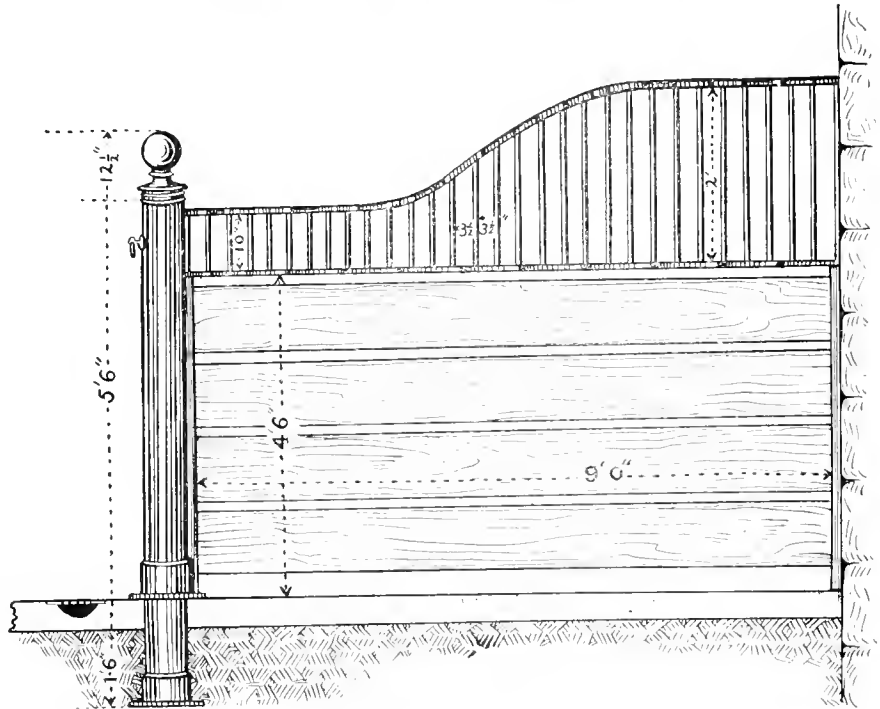
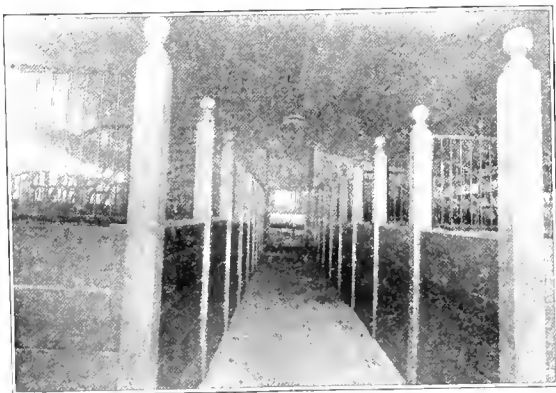

Fig. 1241



W. B. Ayer's Horse Barn, McMinnville, Oregon.
Louden Planned and Equipped.



Horse Barn at St. Charles Seminary, Carthage, Ohio. Louden Planned and Equipped.

Louden Horse Stall Guards

The construction and design of Louden Horse Stall Guards are in keeping with the durable, clean-cut simplicity of all Louden Goods. The plainer and simpler barn and stable equipments are made, the easier it will be to keep the stable sanitary.

Our Wrought Steel Guard is an excellent type of construction, and quite popular. The two styles shown on this page and top of next page are the same general construction, except that Figs. 1242-B and 1242-C have both ends square to attach to rear stall posts. The $\frac{1}{2}$ -inch round steel uprights are firmly set in the heavy channel steel frame, making substantial and durable guards.

All three forms of construction offered are very popular and will give satisfaction in every respect. All guards are carried in standard stock sizes, but any size may be had upon special order.

One end only
attaches to upright post

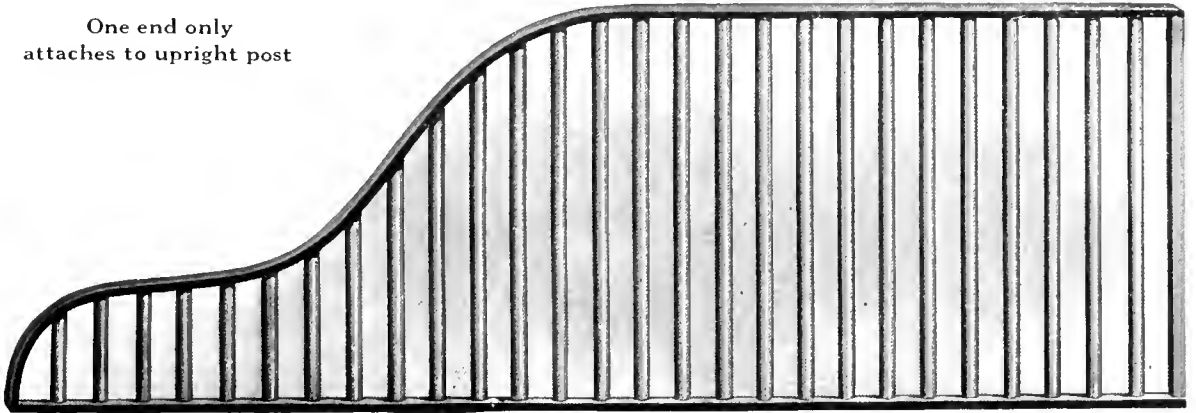

Fig. 1242-A

Specifications

Dimensions: 2 feet high by 6 feet long. Can be made any size upon special order.
Uprights: $\frac{1}{2}$ -inch round steel rods set apart $3\frac{1}{2}$ inches at centers, in steel channel frame.
Main Frame: $1\frac{1}{4} \times 1\frac{1}{2}$ inch channel steel, with steel plate top rail. Finish: Black enamel.
Weight: 37 pounds.

Both ends of this guard can
be attached to posts

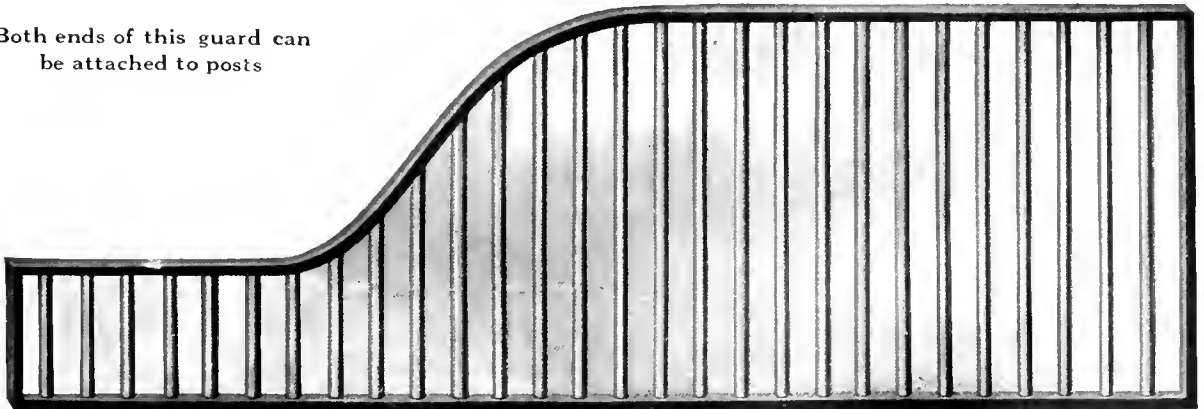

Fig. 1242-B

Specifications

Dimensions: 2 feet high. Can be made any length or size upon special order.
Main Frame: $1\frac{1}{4} \times 1\frac{1}{2}$ inch channel steel, with steel plate on top rail.
Uprights: $\frac{1}{2}$ -inch round steel rods set apart $3\frac{1}{2}$ inches at centers, in steel channel frame.

Louden Horse Stall Guards—Fig. 1242—Continued

Our Fig. 1242-C Stall Guard is used principally for box stalls. It is of the same general construction as the two guards described on previous page, but is made any length to order. A box stall can be made light and well ventilated by using this guard.

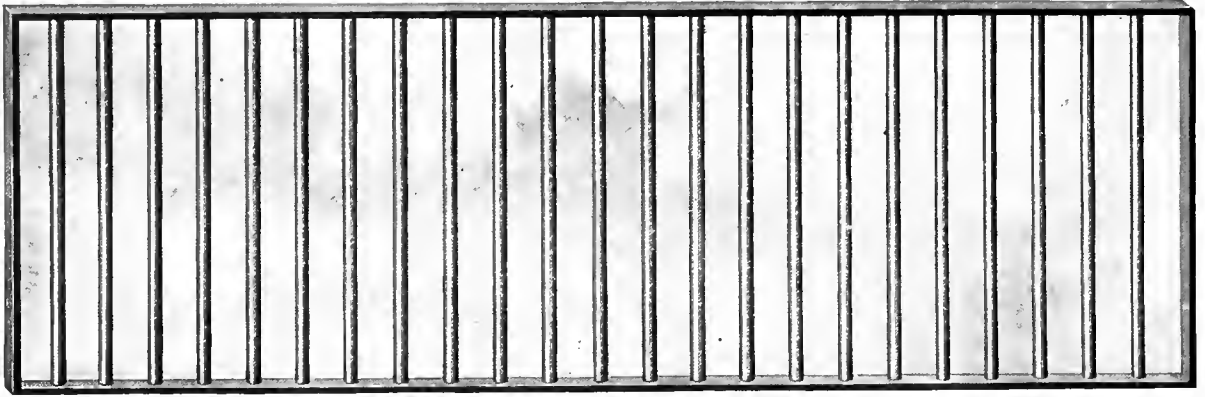

Fig. 1242-C

Specifications

Dimensions: 2 ft. high by any length desired.
Uprights: $\frac{1}{2}$ -inch round steel rods set apart $3\frac{1}{2}$ inches at centers, in steel channel frame.
Main frame; $1\frac{1}{4} \times 1\frac{1}{2}$ inch channel steel with steel plate on top rail.
Finish: Black Enamel.
Weight: 6 lbs. per lineal foot.

Louden Salt Rolls and Holders—Fig. 1061

Specifications

Size of Salt Roll: Length, 4 inches; diameter, 5 inches. Weight, $5\frac{1}{4}$ pounds.
Holders are fitted with grip clamps for use on tubular steel stalls, or with connections for attaching by means of screws or bolts to vertical timbers of wood stalls. Can be furnished, also, for horizontal timbers. (Fig. 1061.)

Louden Salt Rolls are the most convenient and economical, and altogether the best way of salting cattle and horses.

The Steel Holder is attached to the steel stall frame by means of a grip clamp or can be fastened to a wood stall frame with bolts or screws.

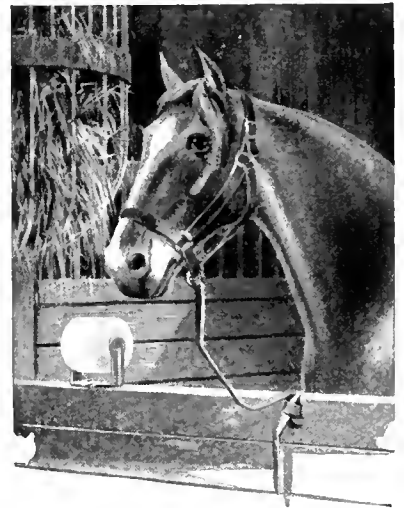

Fig. 1061
Salt Roll attached to wood manger

Heavy Harness Hook—Fig. 1260

Specifications

Dimensions: 13-inch extension from wall by 8-inch total up and down. Weight, each, 7 pounds.

Construction: Heavy iron. Diameter of round iron of hook, 1 inch. Will hold heaviest harness safely and securely.

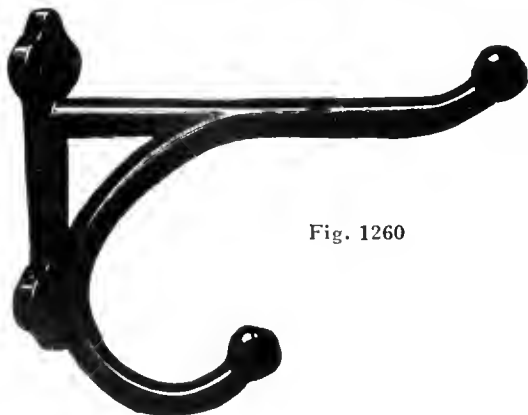

Fig. 1260

Heavy Harness Hooks are far superior to ordinary spikes or wood pegs to hold harness. When hung on one of these hooks the harness cannot slip off.

The 13-inch size is generally used, but we can furnish 8 and 10-inch lengths.

Stall Partition Top and Base Rails—Fig. 1245



Fig. 1245

Specifications

Dimensions: 3 inches diameter, with groove to hold 2-inch board. Any length furnished. Finish: Japanned. Weight, per lineal foot, $4\frac{3}{4}$ pounds.

In constructing a horse stall, rails for the top of the wooden partition to hold the stall guard in place are quite necessary to get a first-class job. A base rail is often necessary to hold bottom of partition lined up properly. Specifications on both cap and base rail are the same.

Stall Posts—Fig. 1246

Specifications

Construction: Heavy wrought steel tube. Cannot be broken like cast iron posts. Provided with grooved flange to receive stall boards.

NOTE: Heights given are to lower part of the cast top. In ordering, be sure to give exact dimensions; also size number.

No. 1. Heavy: 5 inches diameter, 5 feet 4 inches high. Weight, each, 160 pounds.

No. 2. Extra Heavy: $6\frac{3}{4}$ -inch diameter, 5 ft. 4 in. high.

Weight, each, 205 pounds.

Finish: Ball tops can be finished on special order in solid brass, bronze, or nickel plate at small extra cost.

This post is far superior to anything of its kind on the market, and makes the construction of a neat, sanitary stall partition an easy task.

The Improved Heavy Steel Post has a flanged groove to hold the ends of the boards in the stall partition, making it a simple matter to remove or replace boards when desired.

The post is neat and symmetrical, and greatly helps the appearance of any barn.

When desired, posts may be purchased long enough to reach the ceiling, thus combining stall post with building support.

Figure 1246 shows post to set on floor. Figure 1246-A shows the post with 6-inch extension to go into cement.

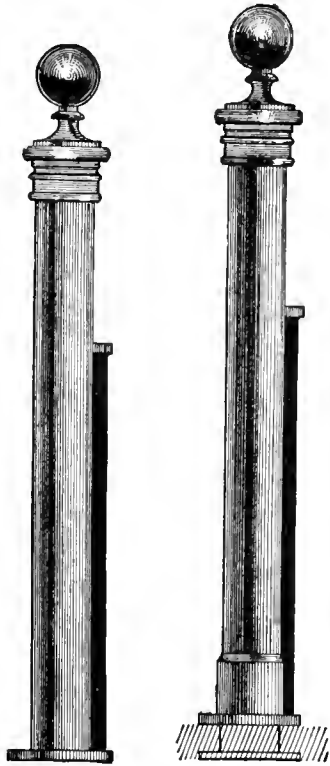

Fig. 1246

Fig. 1246-A

Heavy Post Socket—Fig. 1247

Specifications

For 6-inch wood posts. Construction: Heavy iron. Diameter of flange: $2\frac{1}{4}$ inches.

Height	Weight
$3\frac{1}{2}$ inches	15 pounds
$5\frac{1}{2}$ inches	21 pounds
8 inches	27 pounds



Fig. 1248

Fig. 1247

Figure 1247 shows a substantial, heavy, firm socket for a 6-inch wood post. It is made in three heights— $3\frac{1}{2}$, $5\frac{1}{2}$, and 8 inches. Wood posts rot at the bottom, and by using this socket the post will last longer, as well as keep in line all the time.

Socket Plate for Post—Fig. 1248

Specifications

For 6-inch wood post. Dimensions of plate: 6x12 inches. Attaches to floor with screws. Weight, each, 20 pounds.

Figure 1248 shows a type of socket used to hold 6-inch post firmly. It is, however, neither as firm nor sanitary as the Heavy Post Socket.

Cess Pools

The advantages and conveniences in having good sanitary drains for the stable can hardly be over-estimated, and most new barns that are being erected are now equipped with good drainage facilities.

We show but three types of Cess Pools on this page, but are prepared to furnish special curved heads for gutters, "T" gutter connections, and other supplies of like nature, upon special order. Manger and Gutter Drains are also shown on pages 148 and 149.

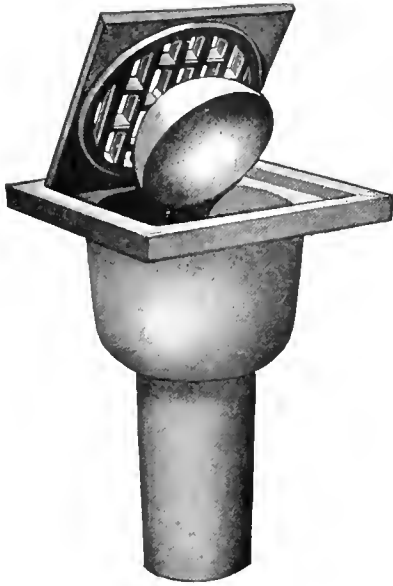

Fig. 1261

This is a type of Drain Head with Cess Pool especially designed for a carriage or automobile wash. It has an extra long Spigot Outlet. Fig. 1261 shows Drain Head raised to show Bell Trap. Fig. 1261-A shows same in closed position.

Heavy Carriage Wash Cess Pool — Fig. 1261

Specifications

Construction: Heavy iron. Spigot outlet extra long for calking.

Dimensions: Head, 10 inches square.

Outlet: 4 inches. Finish: Plain.

Weight: 43 pounds.

NOTE: Same Cess Pool can be furnished with short spigot.

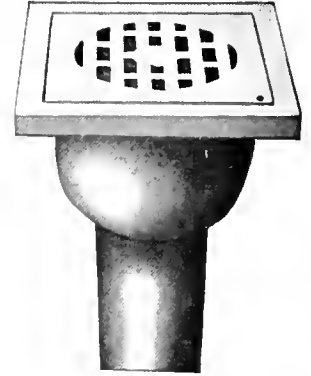

Fig. 1261-A

Heavy Stable Cess Pool — Fig. 1262

Specifications

Construction: Heavy iron. Has grating and bell trap. Made in three sizes.

Dimensions:	Weight
15½ inches square, with 4 inch square outlet	60 lbs.
Same size, with extra long spigot	70 lbs.
12 inch square, with 4-inch outlet	49 lbs.

This is a standard stable Cess Pool, and is considered the best of its type. It has the grating and Bell Trap shown in illustration.



Fig. 1262-A

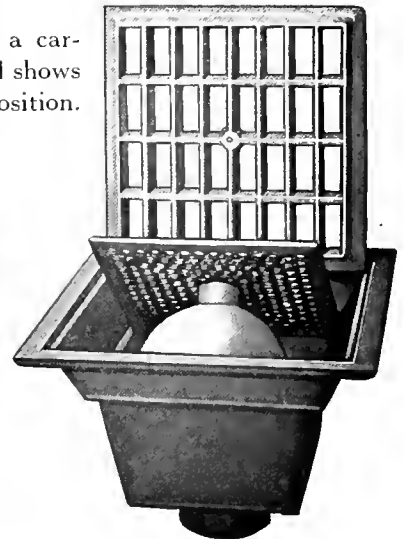

Fig. 1262

Basin Cess Pool — Fig. 1263

Specifications

Construction: Heavy iron, standard type, with bell trap.

Dimensions	Weight
4x 4 inches	3 pounds
6x 6 inches	5 pounds
8x 8 inches	10 pounds
9x 9 inches	16½ pounds (heavy)
12x12 inches	18 pounds (heavy)

Figure 1263 shows a very popular design. The rounding base of this Cess Pool makes installation very simple.

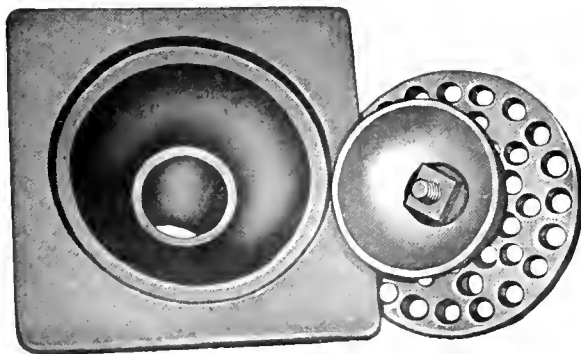

Fig. 1263

Self-Acting Oats Cleaner

Fig. 1250

(Higbie Patent)

Specifications

Construction: See general description.

Sizes: The Self-Acting Oats Cleaner is made in three sizes.

Styles: When ordering specify whether discharge of oats is to be on right or left side. Illustration shows right side delivery.

Construction and Finish: Made of kiln-dried whitewood, with brass trimmings, natural finish, and with two coats of varnish. When desired to have the finish correspond with the stable finish, specify kind of wood to be used, and ask for quotations.

No. A

Dimensions: 6 ft. 3 inches high by 15 inches wide by 8½ inches deep.

Capacity: 1½ bushel per minute.

Weight, each, 65 pounds.

No. B

Dimensions: 6 ft. 3 inches high by 16 inches wide by 11 inches deep.

Capacity: 1 bushel per minute.

Weight, each, 80 pounds.

No. C

Dimensions: 6 ft. 3 inches high by 16 inches wide by 12 inches deep.

Capacity: 2 bushels per minute.

Weight, each, 82 pounds.

Special sizes, suitable for any stable can be furnished on special order.

Clean oats aid in maintaining the normal health of the horse and the favorable results obtained by feeding oats that have been drawn through a self-acting oats cleaner are recognized by every veterinarian.

The Higbie Oats Cleaner is a valuable asset to the modern stable. It will remove one bushel of dirt and other foreign matter from every 25 to 30 bushels of oats.

This oats cleaner is hand built and assembled in the most durable manner possible. It is constructed of kiln-dried whitewood, with brass trimmings, natural finish, and with two coats of varnish.

Extending from top to bottom of the cleaner are eleven downwardly inclined screens, operating in pairs. Below each pair of screens is located a table elevated in the center, thus the oats fall alternately from the screens to the table; the object of these tables being to divide the oats and to give them a very rapid impetus before dashing to the next set of screens. This system has shown a great improvement over the old way of running the oats down a single set of screens all together.

The operating valve is located in the top of the cleaner; directly below this is a large coarse grate which permits the oats to pass through but throws off everything larger, such as stones, sticks, glass, or any coarse accumulations. Below this grate are the zig-zag screens and the tables extending through the entire cleaner to the discharge spout below. The dirt box is in the base of the cleaner and may be emptied through a hand-hole in the bottom.

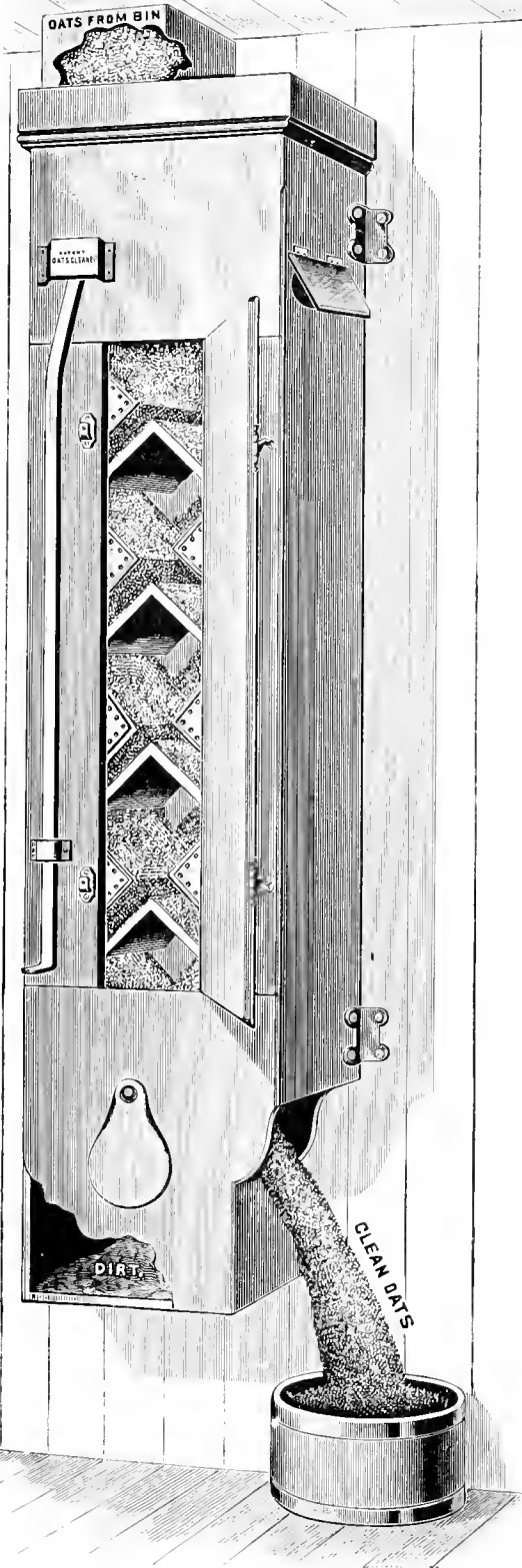

IT PAYS TO PLAN
 Louden Barn Plans Insure
 Convenience, Efficiency,
 Economy of Construction, and
 Architectural Beauty.

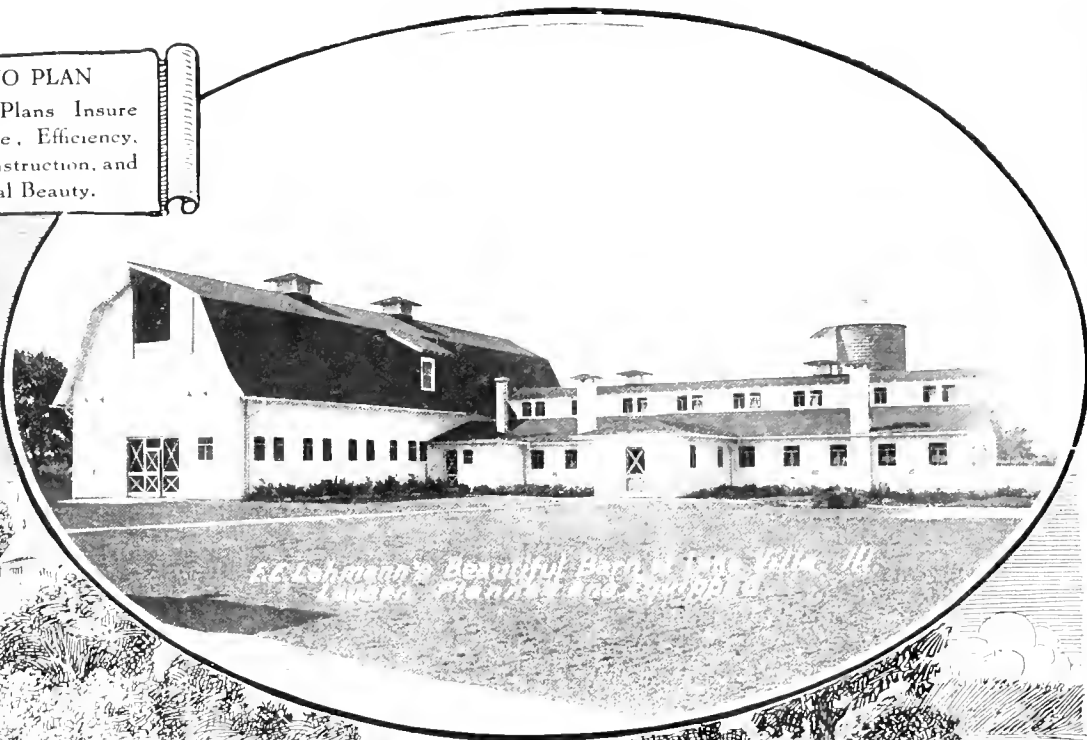

*R. C. Lehmann's Beautiful Barn at Fair Villa, Ill.
 Louden Planned and Equipped*

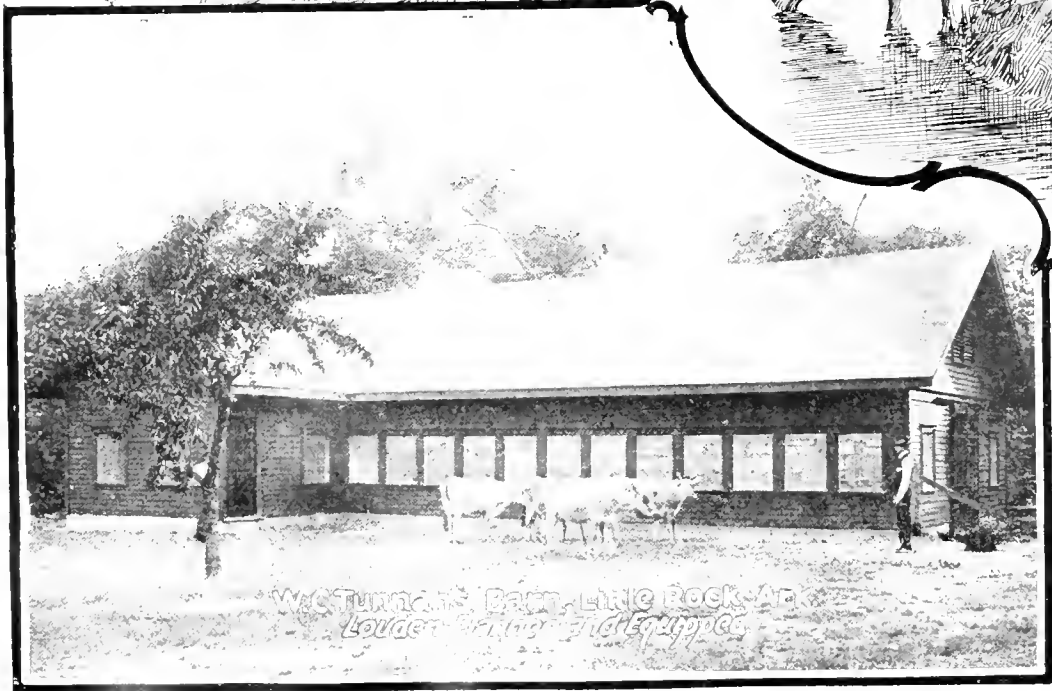
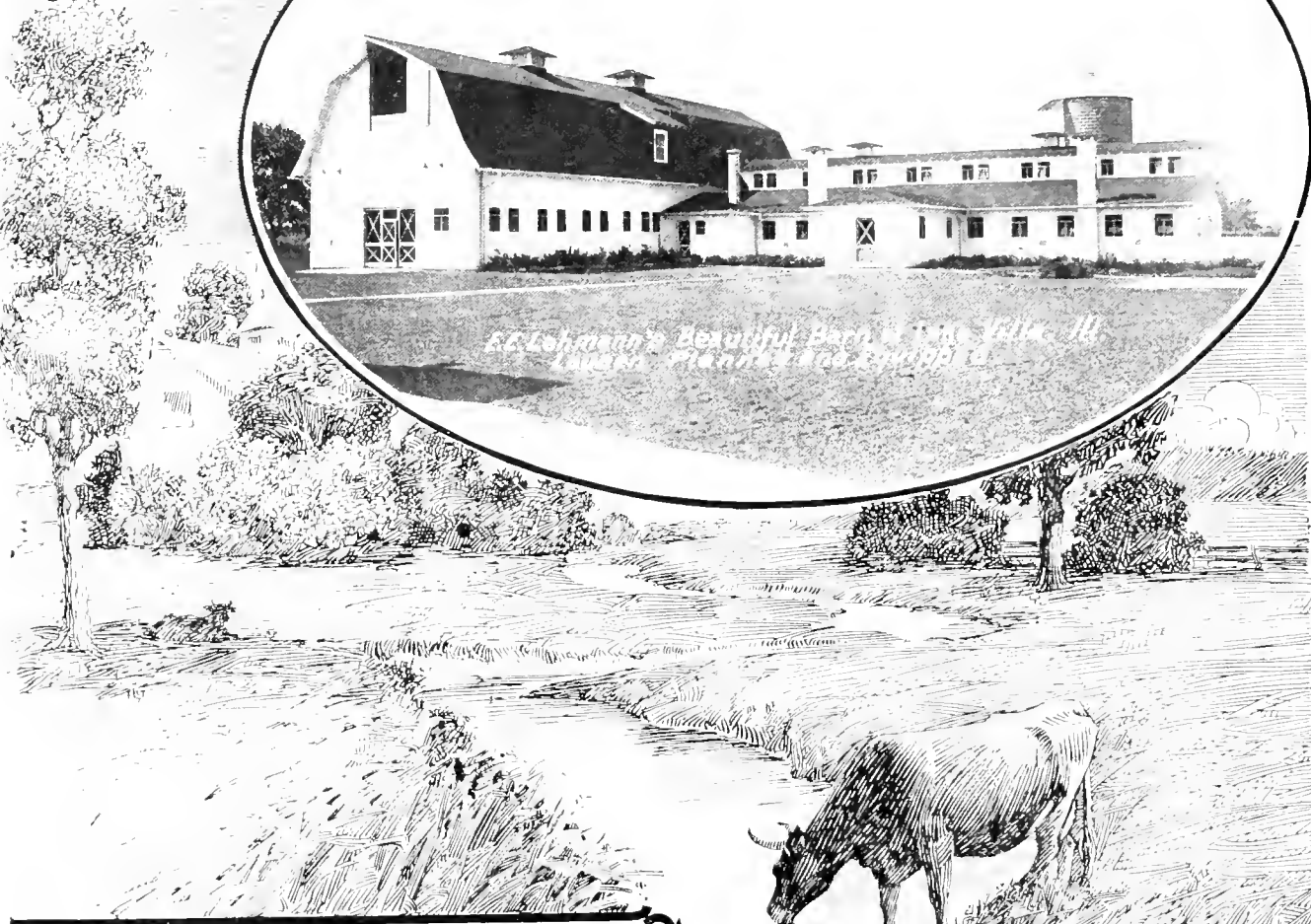

*W. C. Turner's Barn, Line Rock, Ark.
 Louden Planned and Equipped*



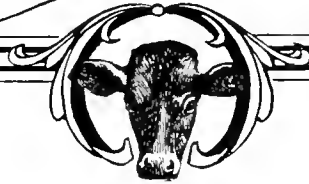

LOUDEN BARN PLANS

	PAGE
Get Plans Before You Build.....	217
Why Build From Plans?.....	217
Louden Plans.....	217
The Advantages of a Well Planned Barn.....	218
The Individual Plan.....	218
Our Complete Architectural Service.....	219
Our Charges	219
Louden Book of Barn Plans.....	220
Barn Designs.....	220-221



GEORGE L. EDICK
ARCHITECT



M. A. R. KELLEY
AGRICULTURAL ENGINEER



PAUL M. HASSLER
ARCHITECT



WM. SCHAEFER
ARCHITECT



E. C. PETERKE
MGR. SPECIFICATION DEPT.

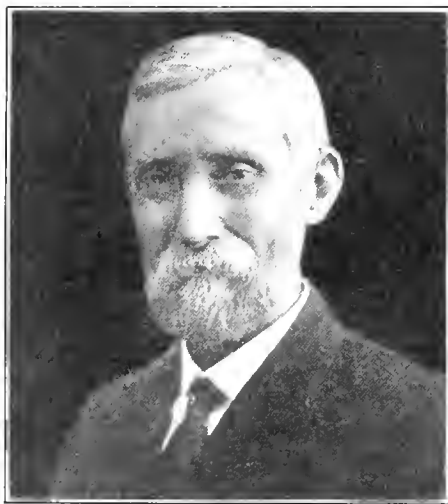

WM. LOUDEN
BARN SPECIALIST



H. H. NIEMANN
MANAGER OF ARCHITECTURAL DEPT



EARL J. SIMONS
ARCHITECT



F. O. JOHNSON
ARCHITECT



PAUL W. STANKEE
ARCHITECT



E. H. WAGNER
ARCHITECT

THE LOUDEN ARCHITECTURAL DEPARTMENT

GET PLANS BEFORE YOU BUILD

Guess work in building a barn is not only slow, wasteful and expensive, but it results in a barn that is a constant source of dissatisfaction as long as it stands.

You expect that barn you are planning to build to serve you the rest of your life—then why not get it right? The few days or weeks you spend getting ready for a right start will be regained by the time the building is completed, and the few dollars you spend for plans will be saved many times over during its construction.

But most important of all, you will have a barn that exactly meets your needs—convenient, labor-saving, properly lighted and ventilated, free from waste space—in fact, **the ideal barn for you**, and one you will take pleasure and pride in.

No other organization of architects is so well equipped to give you expert advisory service and practical barn plans as the Architectural Department of The Loudon Machinery Company.

Unlike most architectural concerns, its services are limited strictly to one line of work. Agricultural Architecture. Every man on the staff is a **Farm Building Specialist**. As a result they are more competent to advise you on your farm building problems than any organization of general practicing architects.

Our staff of skilled architects and builders is supplemented by an auxiliary of 75 practical field men who know barns from basement to ridgepole.

There is probably a field man in your territory. Write us about your building plans and we will have him see you, if possible, and talk the matter over with you. There's no expense—no obligation. We're glad to confer with you about the matter that's nearest our hearts—the building of better barns—and we sincerely believe we can benefit you.

Why Build From Plans?

Complete plans will protect you against waste of material due to guessing and working in the dark as to measurements.

They will protect you against waste of time, due to delay necessary in figuring our details of construction, while the work is in progress.

They will protect you against the misunderstandings which so often arise between owner and builder. Even the most reliable builder may misinterpret your desires, and go wrong, when no complete plans are followed.

They will help you to adjust your loss in case of fire.

Loudon Plans

will effect a valuable saving in material and labor. They will expedite your building operations. They will give you the advantage of the knowledge of experts, gained through many years of study and experience. They will correctly convey your wants to your builder. They will help him to give you efficient service.

Every plan we execute is of the highest order. Our great organization enables us to give you the very best service at a very moderate price.

The Loudon Machinery Company,
Fairfield, Iowa.

Guelph, North Dakota, Sept. 7, 1916.

Gentlemen:

You will remember I built a barn last Fall, following your Architectural Department's plan No. 3404, and will say I am so very well pleased with the barn, although it has been rather expensive to build in this country.

I am so well pleased with the ventilating system, and the barn is so light and pleasant, and the air so fresh and cool in summer, and so warm and dry in winter, that it has been pleasing to me to think I carried out your instructions in full.

Very truly yours,

Chas. B. Denison.

The Advantages of a Well Planned Barn

The primary feature of a well planned dairy barn is its provision for cow comfort. Practical tests have proved conclusively that the cow's physical comfort is a big factor in her milk yield.

The well planned dairy barn has a ventilating system that **ventilates**. The number and areas of vent-flues necessary are scientifically determined. The window area is carefully calculated, according to the number of animals to be housed. Floors, mangers, and gutters are designed for durability and cleanliness. The cows are provided with light, airy stalls that give them utmost freedom and comfort.

The well planned barn is convenient for the workmen, as well as comfortable for the cows and other livestock, an extremely important feature where help is scarce and high-priced.

It is so designed and equipped that no labor is lost. The silo is located where it is convenient for feeding, as well as for filling. The feed bins are located where they can be reached with the fewest number of steps. The manure pit is located, if possible, so that it is not necessary to push a load uphill. The barn is equipped with labor-saving appliances that increase the profits derived from it, and transform barn drudgery to pleasant labor.

Louden barn plans meet every requirement for the comfort of the stock and the convenience of the workman. Economy in construction is carefully sought, so far as it does not interfere with strength, durability, or sanitation.

Write us about your building plans. We can give you valuable suggestions.

The Individual Plan

When you build a barn you build for a definite purpose and that purpose should be kept constantly in mind. Whether you build for horses or cows, for dairying or feeding, for the storage of feed or farm implements, or for a combination of these, the correct amount of space should be allowed for each purpose, the total of which will determine the size of the building.

This rule seems simple enough, but becomes complicated when economy of construction is taken into consideration. A barn 40 feet square, with 1600 square feet of floor space, may meet your requirements satisfactorily. It may be found, however, that a barn 32x50, having the same floor area, will meet your requirements equally well, and will cost less on account of requiring lighter construction for a 32-foot span, than for a 40-foot span.

In such matters as this our trained architects and builders, thoroughly versed in the requirements of the modern barn, can be of real service to you.

Our Architects Make Every Plan an Individual Study

In working out a plan for **you**, they will make a study of your special requirements and shape the plan to meet your needs. They will take into consideration climatic conditions in your territory, current local prices of building materials, transportation problems, and labor conditions. If you so desire an architect will be sent to confer with you and look over the building site, in order to make more intelligent suggestions in regard to drainage, disposal of manure, and general arrangement of buildings.

We are prepared to work out complete plans for you, from the ground up, or we will take **your own** ideas and work them out in detail for your builder. In either case the services will be rendered free or at a very moderate cost.

The Loudon Machinery Company,
St. Paul, Minn.

Gentlemen:

Am pleased to acknowledge receipt of the book of Barn Plans. You are certainly doing a real service in assisting farmers to construct and equip for true economy.

University Farm, St. Paul, Minn., Dec. 29, 1915.

Yours truly,

R. M. Washburn,
Asso. Prof. of Dairy Husbandry

Our Complete Architectural Service

It is the purpose of The Loudon Architectural Department not only to prepare practical barn plans, but to assist barn owners in the solution of any problems that may arise in regard to farm buildings or equipment.

They will give you expert advice on lighting, ventilating, heating, concrete work, strength of materials, fire protection, drainage, disposal of manure, and upon all problems of sanitation or hygiene.

We employ a landscape architect whose work is principally upon large estates, so arranging the farm buildings that they will harmonize with one another and with their surroundings.

Whether your farm is large or small, the buildings should be arranged with due regard to landscape architecture and a general pleasing effect. Your farm buildings can display individuality and good architectural design, and at the same time be practical, modern and convenient, separately and collectively.

Do not hesitate to consult us on any question of Farm Mechanics.

What is the capacity of my silo?

What size silo will I need for my herd?

How much concrete will I need to build a water tank?

What size post will be necessary to support an overhead grain bin?

What size pulley will be required to run a cream-separator or a churn at proper speed?

What is a good formula for whitewash?

We can help you answer many such puzzling questions, and will be glad to do so without charge and without obligating you in any way.

Our Charges

The Loudon Architectural Department is in reality a Service Department of The Loudon Machinery Company. Consequently a large part of the valuable service it renders is free. We make no charge for:

Advisory service covering farm building or any branch of Agricultural Engineering.

Preliminary sketches and suggestions, including suggestive floor plans and complete explanation of each feature.

A personal visit from any Loudon field representative who may be within your territory.

For any of the following services we make a moderate charge, based on the amount of time and effort involved.

A special trip by one of our architects to confer with you on building problems or landscape architecture.

Complete building plans and specifications, including all information required for the completion of the building.

Bills of Material, on which prices are quoted separately.

Albion, Idaho, Sept. 1, 1916.

The Loudon Machinery Company,
Fairfield, Ia.

Gentlemen:

We wish to thank you for the helpful suggestions and plans you so kindly furnished in the building of our horse barn, and we honestly believe we have one of the best barns in the state of Idaho, and one that would be a credit to any community or farm.

Yours very truly,

Ervine Dewey & Sons.

By G. M. Dewey.

“Louden Barn Plans”

Louden Barn Plans is a 112-page book of practical barn plans and building information, compiled by the Loudon Architectural Department. It contains the best of the building ideas gathered in fifty years of specializing along this line by William Loudon and his able assistants.

It shows seventy-two representative designs for dairy and general purpose barns, and other farm buildings, with full description and estimated cost of each. It treats in a clear understandable way the subjects of grading, drainage, concrete work, framing, lighting, ventilating, strength of materials—every problem in fact that confronts the barn builder.

If you expect to build or remodel a barn, now or later, you need this book. We'll gladly mail you a copy on request.

Don't wait till you're ready to build—get it now!

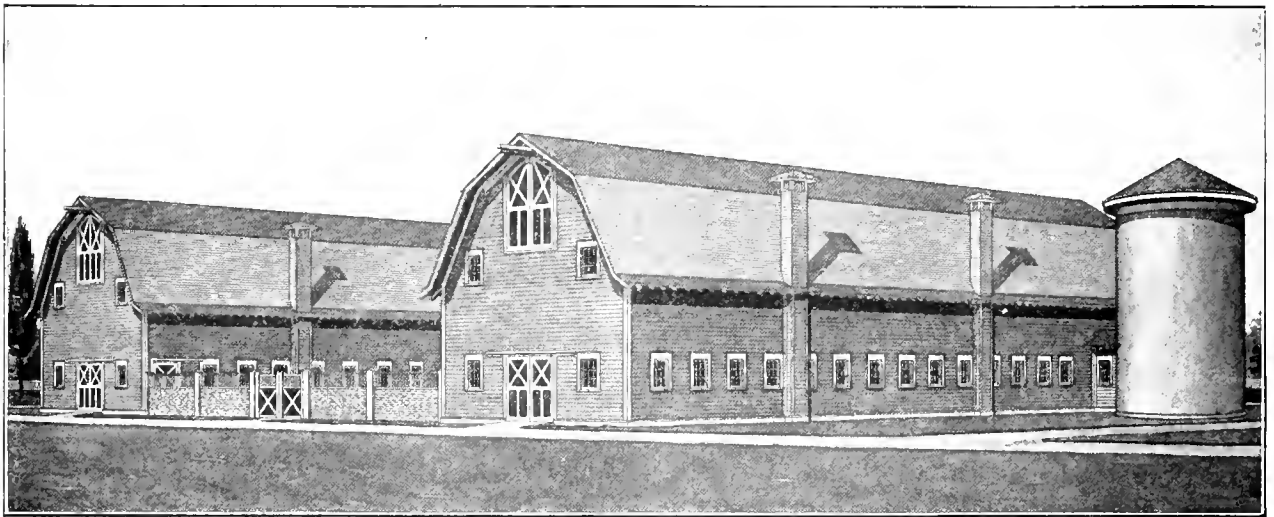

Design 1840—For Dairy Barn

Description

This barn is 126 ft. wide by 140 ft. long.

The foundation wall extends 18 inches above the ground and the frame sidewalls are 16 ft. high.

The lower story is 9½ ft. high, the hay mow is 22 ft. high from floor to hay carrier-track, the vertical sidewalls in the hay mow are 6 ft. high, and the ridge of roof is 36 ft. above the ground.

The foundation wall is of concrete construction, and the entire floor of the lower story is of concrete construction.

Capacity of mow, 315 tons loose hay.

The barn above the foundation is of plank-frame construction and has a clear hay mow without posts.

The cost is estimated to be \$9800.00.

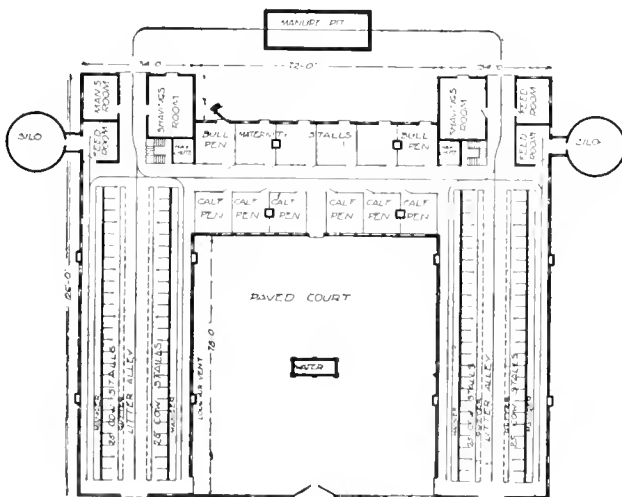

Price of Complete working plans and specifications for Design 1840 \$25.00

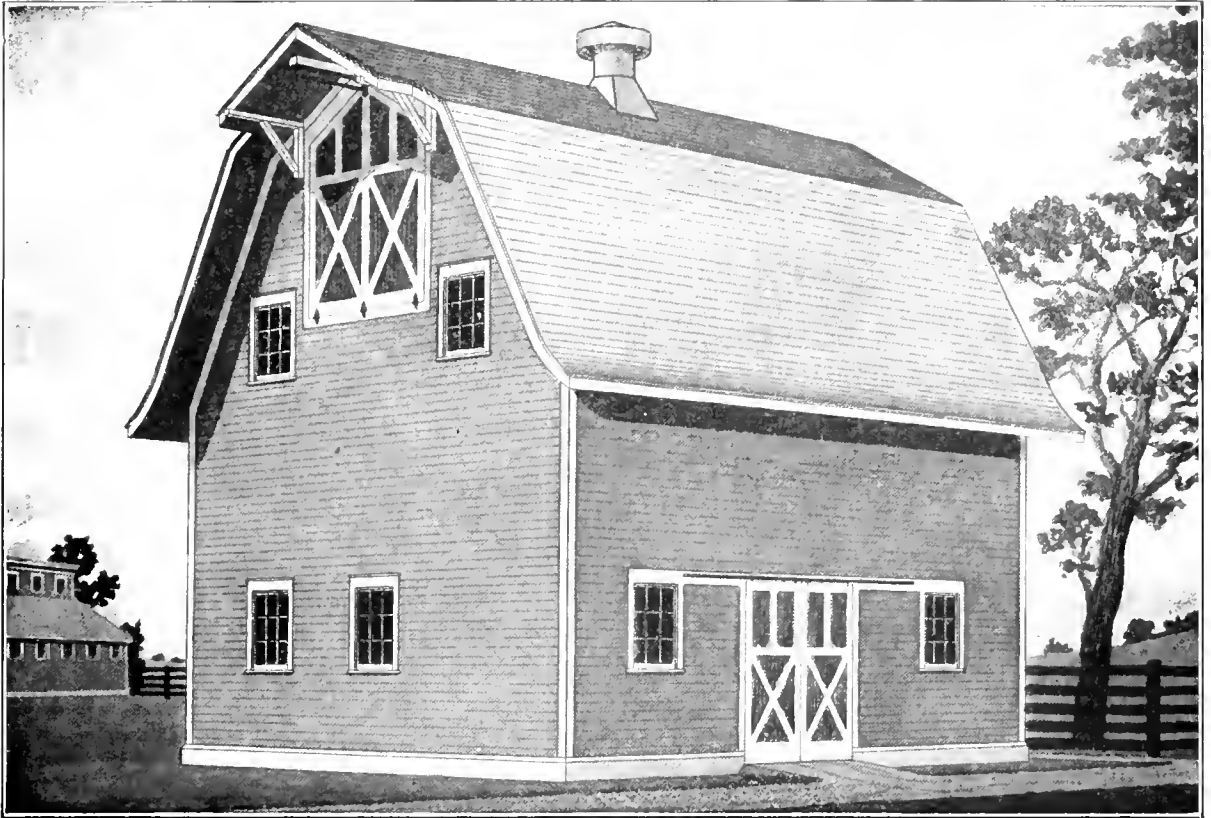

Design 1808—For 6 Cows and 4 Horses

Description

This barn is 26 ft. wide by 32 ft. long.

The foundation wall extends 12 inches above the ground, and the frame sidewalls are 16 ft. high.

The lower story is 10 ft. high, the hay mow is 19 ft. high from floor to hay carrier-track, the vertical sidewalls in the hay mow are 6 ft. high, and the ridge of roof is 33 ft. above the ground.

The foundation wall is of concrete construction, and the entire floor of the lower story is of concrete construction.

Mow capacity, 14 tons loose hay.

The barn above the foundation is of plank-frame construction and has a clear hay mow without posts.

The cost is estimated to be \$1000.00.

Price of Complete working plans and specifications for Design 1808 **\$5.00**

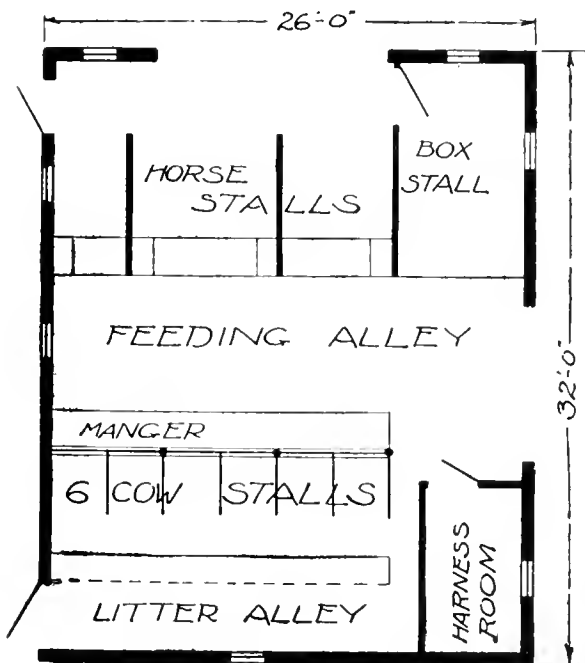

INDEX

Hay Tools

	Page		Page
Bracket Pulley Holder.....	52	Lightning Rope Hitch.....	52
Cable and Cable Fittings.....	29	Link Track Hangers.....	30
Cable Pulleys.....	50	Nails (Barbed).....	31
Check Pulley.....	51	Off-Set Hinge.....	53, 67
Comb Pulley.....	51	Power Hoist.....	33-35
Combination Rack Irons.....	55	Pulleys.....	49-51
End Stop Block (for Double Bead Track).....	8	Pulleys (Fork).....	51
Floor Hook.....	52	Pulleys (Guide) for Round Barn.....	27
Floor Pulley.....	50	Pulleys (Parallel Sling).....	48
		Pulleys (Self Locking Sling).....	46
		Pulleys (Sling Binding).....	45
		Pulley Holders (For Steel Track).....	52
Forks		Pulley Hooks.....	52
Balance Grapple (6 tine).....	38	Rack Irons.....	55
Balance Grapple (4 tine).....	39	Rafter Brackets.....	31
Balance Grapple (Extra Large 6 tine).....	39	Rafter Hooks.....	52
Harris Double Harpoon.....	40	Registering Heads.....	47
Nellis Single Harpoon.....	40	Ridgepole Brackets.....	31
Rocker-Bar.....	40	Rope (Wire).....	29
Triple Harpoon.....	40	Rope Hitch (Lightning).....	52
Fork Clevis.....	45	Rope Hook (Swivel).....	52
Fork Pulleys.....	51	Rope Hook (Cross Draft).....	24
Guide Pulley (for Round Barn).....	27	Rope Swivel (Junior Carrier).....	9
Handy Hay Sling Holder.....	44	Round Barn Outfit.....	25-27
Hang Hook (jointed) for Wood Track.....	31	Singletree (Hoisting).....	53
Hang Hook (Straight) for Wood Track.....	31		
		Slings	
Hay Carriers (Fork)		Carry-All.....	42
Louden Junior.....	8-9	Standard.....	43
Louden Senior.....	10-11	Three-Rope.....	43
Louden Junior for Wood Track.....	13	California.....	43
Louden Junior for Cable Track.....	28	Handy.....	44
		Sling Couplings.....	44
Hay Carriers (Sling)		Sling Holder (Side Trip).....	44
Carry-All.....	14-17	Sling Pulleys (Parallel).....	48
Iowa.....	18-19	Sling Pulleys (Self-Locking).....	46
Reversible, for Wood Track.....	21	Sling Binding Pulleys.....	45
Cross Draft (for Slings or Fork).....	22-24	Snatch Pulley Block.....	51
Cross Draft for Round Barn.....	25-27	Splice Clamps for Steel Track.....	30
		Spreader Attachment for Singletrees.....	53
		Stake Holders.....	55
Hay Rack Clamps.....	54	Track (Steel).....	30
Hoist (Power).....	33-35	Track (Cable).....	29
Hoisting Singletree.....	53	Track Hangers.....	30-31
Ice Tongs.....	55	Wire Stretcher.....	56

Door Hangers and Specialties

	Page		Page
Bird Proof (Non-Adjustable) Door Hanger.....	60-62	Double Strap Door Hanger.....	66
Bird Proof (Adjustable) Door Hanger.....	63	Double Tread Door Hanger.....	65
Bird Proof (Covered).....	64	Garage Door Hanger.....	59
Door Latch.....	67	Standard Jointed Door Hanger.....	66-67
Door Stop.....	67	Stay Rollers.....	67
Double Bracket for Bird Proof Track.....	63		

Stalls, Pens, Etc.

	Page		Page
Alley Gates.....	132	Cow Stalls (See Stalls)	
Anchor Bolts (Helical).....	139	Calf Pens.....	120-121
Building Columns (Reinforced).....	135	Cement Tools.....	101
Bull Pens.....	126-128	Chain (Stanchion Side).....	85

Stalls, Pens, Etc.—Continued

	Page		Page
Chain (Throat).....	85	Pens (Calf).....	120-121
Connections (for Posts and Columns).....	138	Pens (Cow).....	124-125
Cow Pens.....	124-125	Pens (Hog).....	129-131
Cupolas.....	141-142	Salt Rolls.....	94, 210
Curb Gauge.....	101	Salt Roll Holders.....	94, 210
Cut-Out Form.....	101	Spring Balance Mangers.....	104-106
Drills (Star).....	101	Spring Balance Manger Divisions.....	102-104
Drinking Bowls.....	115-119		
Expansion Bolts.....	139	Stalls (Cow)	
Fittings (Stall and Pen).....	136	Cross Braced Double Post.....	76-78
Gates (Alley).....	132	Triple Post.....	82-83
Gates (For Pen Gates, See Pens)		Side Post.....	84-85
Gauge (Curb).....	101	Single Post.....	87
Grip Clamps.....	136-139	Go-Right.....	88-90
Gutter Drains.....	148, 212	Simplicity.....	91
Hog Pens.....	129-131	Adjustable.....	92-93
Holder (Name Plate).....	94		
Holder (Salt Roll).....	94, 210	Stanchions	
Hook Bolts.....	139	Tubular Steel.....	109-111
Manger Divisions (Spring Balance).....	102-104	Wood-Lined.....	112
Manger Drains.....	147-148	Quick Adjustable.....	113
Mangers (Spring Balance).....	104-106	5-In-1.....	114
Mangers (Bull Pen).....	126-128	For Bull Pen.....	127
Mangers (Calf Pen).....	120-121	Stanchion Anchor (Adjustable).....	96
Mangers (Cow Pen).....	124-125	Stanchion Holder (Adjustable).....	96
Manger Templets.....	101	Step Back.....	97
Name Plate Holders.....	94	Throat Chains.....	85
Paint.....	149	Ventilators.....	142-143
Partitions (Stall).....	79	Water Bowls.....	115-119
Pens (Bull).....	126-128	Window Ventilators.....	146

Carriers

Litter, Feed, Milk Can, Merchandise, Etc.

	Page		Page
Anchors for Wire Track.....	188	Merchandise Carriers.....	172
Automatic Track Opener.....	182		
Brackets (Beam).....	175	Milk Can Carriers	
Brackets (Rafter).....	175	Platform Carrier (Steel Track).....	173
Brackets (Ridge Pole).....	175	Platform Carrier (Wire Track).....	173
Combination Track (For Quick Out and Self-Acting Carriers).....	165-166	Railroad Carrier (Steel Track).....	173
Curves (For Steel Track).....	183	Railroad Carrier (Wire Track).....	174
Curves (For Wire Track).....	189	Suspended Carrier (Wire Track).....	174
End Stop Block.....	175	Platform Hay Carrier.....	174
Feed Carriers		Posts For Supporting Track in Yard.....	179
Double End.....	167	Removable Section For Doors.....	183
Standard.....	168	Screw Eyes.....	175
Single End (Adjustable Frame).....	169	Swinging Crane.....	185-186
Single End (Wire Track).....	169	Switches (Steel Track).....	181
Side Delivery.....	170	Switches (Wire Track).....	189
Feed Truck (Floor).....	171	Tension Bolts.....	188
Harness Carrier.....	171	Track (Combination).....	165-166
Litter Carriers		Track (Steel).....	175
Emancipator.....	157-159	Track (Wire).....	187
Standard.....	161	Track Brace.....	182
Quick Out.....	162	Track Hangers.....	175
Self Acting.....	163-164	Track Plans.....	191-193
		Track Support (Outside).....	178

Horse Stable Equipment

	Page		Page
Cess Pools	212	Oats Cleaner (Higbie Patent)	213
Drinking Fountains	207	Partition Cap and Base Rails	211
Feed Boxes	204-206	Posts	211
Harness Carriers	171	Post Sockets	211
Harness Hooks	210	Salt Rolls and Holders	210
Hay Racks		Stall Guards	208-210
Automatic (Warren Patent)	198-200	Window Guards	207
Wrought Iron (Center and Corner)	201-203		
Cast Iron Corner Hay Rack	203		

The Louden Guarantee

Page 149

PRICE LIST LOUDEN PRODUCTS

Effective January 2, 1917

(All Prices Subject to Change Without Notice)

This Price List Applies to
Catalog No. 46 Only

The Louden Machinery Company,

Factory and General Office

Fairfield, Iowa

Branch Houses

1047-1053 Broadway,
Albany, N. Y.

1051-59 West 35th St.,
Chicago, Ill.

2288 University Ave.,
St. Paul, Minn.

PRICE LIST

Hay Tools

(Subject to Change Without Notice)

Goods marked "*" are trade goods and are not warranted by this company.

Page	Fig.		Price
8	430	Junior Steel Track Fork Carrier.....	each \$ 7.00
8	1123	Trip Block for Junior Steel Track Fork Carrier.....	each .50
8	523	Double Bead End Stop Block.....	each .24
9	C430-A	Rope Swivel for Junior Steel Track Fork Carrier.....	each .50
9	830	Junior Fork Carrier with Oscillating Engine Trucks.....	each 8.50
10	1100	Louden Senior Hay Fork Carrier	each 9.00
	1124	Louden Senior Hay Fork Carrier for Cable Draft Rope (not illustrated)	each 9.00
10	1123	Trip Block for Senior Hay Fork Carrier.....	each .50
10	523	Double Bead End Stop Block.....	each .24
13	441	Junior Fork Carrier for Wood Track.....	each 7.00
13	1127	Trip Block for Junior Fork Carrier for Wood Track.....	each .50
14	1103	Carry-All Hay Sling Carrier.....	each 15.25
14	1123	Trip Block for Carry-All Hay Sling Carrier.....	each .50
14	523	Double Bead End Stop Block.....	each .24
18	821	Iowa Hay Sling Carrier.....	each 13.00
18	1123	Trip Block for Iowa Hay Sling Carrier.....	each .50
18	1128	Adjustable Trip for Iowa Hay Sling Carrier.....	each .50
18	523	Double Bead End Stop Block.....	each .24
19	529	Louden Weight Return.....	each 1.50
20	315	Reversible Hay Sling Carrier for Wood Track.....	each 13.00
20	1130	Trip Block for Reversible Hay Sling Carrier.....	each 1.00
20	435	Comb Pulley	each .39
20	383	Rope Hook	per doz. 3.20
21	817	Cross Draft Hay Fork and Hay Sling Carrier (for slings).....	each 13.00
		Cross Draft Hay Fork and Hay Sling Carrier (for wood track)	each 13.00
21	1131	Release Block for Cross Draft Carrier.....	each 1.00
21	523	Double Bead End Stop Block.....	each .24
21	383	Rope Hook	per doz. 3.20
24	819	Three-part Rope Hitch for Cross Draft Carrier.....	each .90
25	1104	Round Barn Hay Sling Carrier.....	each 16.75
25	1131	Release Block for Round Barn Sling Carrier.....	each 1.00
25	523	Double Bead End Stop Block.....	each .24
25	383	Rope Hook	per doz. 3.20
27	1135	Guide Pulley for Round Barn.....	each 6.00
27	430½	Junior Round Barn Fork Carrier.....	each 10.00
28	621	Junior Hay Fork Carrier for Cable Track.....	each 7.00
28	801	Trip Block for Junior Carrier for Cable Track.....	each 1.00
28	C430-A	Rope Swivel for Junior Carrier.....	each .50
29	417	Galvanized Steel Wire Rope 5/8-inch diameter	} Market Price
29		Galvanized Steel Wire Rope 1/2-inch diameter	
29	418	Galvanized Steel Strand 1/2-inch diameter	
		Flexible Wire Draft Rope 5/8-inch diameter.....	
29	337	Wire Cable Loop Clamp	per doz. 4.00
29	337½	Wire Cable Stop Clamp	per doz. 3.00
30	571	Double Bead Steel Track.....	per 100 feet 20.00
30	550	Splice Clamp for Double Bead Steel Track.....	each .35
30	498	Standard Two-part Track Hanger.....	per doz. 1.60
30	500	Light Two-part Track Hanger.....	per doz. 1.40
30	832	5-inch Link Track Hangers.....	per doz. 1.60
31	780	Straight Wood Track Hang Hook, 14-inch	per doz. 1.20
31	781	Straight Wood Track Hang Hook, 16-inch	per doz. 1.30
31	372	Jointed Wood Track Hang Hook, 14-inch.....	per doz. 2.00
31	424	Improved Malleable Rafter Bracket.....	per doz. .70
31	425	Common Malleable Rafter Bracket.....	per doz. .60
31	465	Malleable Ridge Pole Bracket.....	per doz. 1.00

Hay Tools—Continued

Page	Fig.		Price
31	675	Side Rafter Bracket.....	per doz. \$ 1.20
31	725	Side Beam Bracket.....	per doz. 1.50
31	373	Barbed Chisel Point Steel Nail.....	per pound .16
34	965	Single Drum Power Hoist.....	each 62.50
35	1132	Triple Drum Power Hoist.....	each 122.50
38	351	6-tine Standard Size Balance Grapple Hay Fork.....	each 11.00
39	648	4-tine Balance Grapple Hay Fork.....	each 9.35
39	686	6-tine Extra Large Balance Grapple Hay Fork.....	each 15.00
40	1137	Louden Rocker Bar Hay Fork.....	each 3.75
40	350	Triple Harpoon Hay Fork.....	each 5.00
40*	353	Harris Double Harpoon Hay Fork.....	each 1.60
*	674	31-inch Harris Double Harpoon Hay Fork.....	each 2.00
*	676	Alfalfa Double Harpoon Hay Fork.....	each 3.70
40*	356	Nellis Single Harpoon Hay Fork.....	each 3.00
42	984	6-foot Carry-All Hay Sling.....	each 7.00
43	666	4-foot Standard Hay Sling.....	each 3.20
43	668	5-foot Standard Hay Sling.....	each 3.80
43	600	Three-rope Hay Sling.....	each 4.00
43	324	California Hay Sling.....	each 5.00
44	516	Louden Hay Sling Coupling.....	each 1.00
44	1106	Handy Hay Sling, 3 ropes.....	each 2.00
	717	Handy Hay Sling, 2 ropes.....	each 1.50
	1106A	Handy Hay Sling Holder.....	each 2.00
44	328	Side Trip Sling Holder.....	each 2.00
44	1106	Self Locking Sling Pulleys with Handy Hay Sling Holder At- tachment.....	per pair 3.00
45	652-653	Fork Clevis.....	each .50
45	332	Sling Binding Pulley.....	each 3.00
46	330-331	SelfLocking (right angle) Hay Sling Pulleys.....	per pair 3.00
47		All Registering Heads.....	each .50
48	649	Parallel Hay Sling Pulleys.....	per pair 2.00
48	650	Senior Parallel Hay Sling Pulleys for Wire Draft Rope.....	per pair 3.00
49	467	High Grade Knot Passing Pulley, Wood Sheave.....	per doz. 7.00
49	494	High Grade Knot Passing Pulley, Iron Sheave.....	per doz. 8.00
49	468	High Grade Draft Pulley, Wood Sheave.....	per doz. 5.60
49	495	High Grade Draft Pulley, Iron Sheave.....	per doz. 6.60
50	519	Mammoth Pulley.....	per doz. 10.00
50	651	Cable Pulley, 7-inch Iron Sheave.....	per doz. 18.00
50	579	Cable Pulley, 8-inch Sheave.....	per doz. 25.00
50	364	Upright Floor Pulley.....	per doz. 10.00
51	366	Standard Fork Pulley.....	each 1.00
51	1139	Senior Fork Pulley.....	each 1.50
51	359	Return Pulley.....	per doz. 3.00
51	435	Comb Pulley.....	per doz. 3.60
51	360	Check Pulley.....	per doz. 1.80
51	623	Snatch Pulley Block.....	per doz. 11.00
51*	729	Cast Frame Knot Passing Pulley.....	per doz. 4.00
51*	522	Cast Frame Draft Pulley.....	per doz. 3.20
51*	641	Wood Frame Reed Pulley with Hook.....	per doz. 4.00
51*	642	Wood Frame Reed Pulley with Eye.....	per doz. 4.00
52	389	Floor Hook, ¾x7 inches.....	per doz. 1.40
52	390	Rafter Hook, ¾x6 inches.....	per doz. 1.20
52	391	Small Hook, ½x3½ inches.....	per doz. 1.00
52	470	Double Bead Pulley Hook.....	each .30
52	348	Bracket Pulley Holder.....	each .60
52	367	Lightning Rope Hitch.....	per doz. 3.20
52	383	Swivel Rope Hook.....	per doz. 3.20
53	344	Hoisting Single Tree.....	each 1.60
53	345	Spreader Attachment.....	each 1.00
53	349	Offset Hinge.....	per pair .80
54	645	No. 1 Hay Rack Clamps, ¾x14.....	per doz. sets 18.00
54		No. 2 Hay Rack Clamps, ¾x16.....	per doz. sets 19.20
54		No. 3 Hay Rack Clamps, ¾x18.....	per doz. sets 20.40
55	593	Combination Rack Irons.....	per set 4.20

Hay Tools—Continued

Page	Fig.		Price
55	398	Louden Improved Stake Holder	per doz. \$ 4.20
55	398½	Louden Common Stake Holder	per doz. 2.50
55	624	Box Rack Stake Holder	per doz. 2.50
55	627	Pressed Steel Stake Holder	per doz. 1.50
55	426	Self-Opening Ice Tongs, 13-inch	per doz. 12.50
55	695	Self-Opening Ice Tongs, 17-inch	per doz. 13.00
55	696	Self-Opening Ice Tongs, 21-inch	per doz. 13.50
56	1268	Louden Stretcher Hoist	per doz. 14.00
59	1273	Special Garage Door Hangers	per set 6-foot door 5.00
59		Special Garage Door Hangers	per set 8-foot door 5.30
59		Special Garage Door Hangers	per set 10-foot door 5.60
59		Special Garage Door Hangers	per set 12-foot door 5.90
60	911	Bird Proof Barn Door Track	per 100 feet 20.00
60	902	Bird Proof Door Hangers	per doz. sets 20.00
61	961	Supporting Hangers and Brackets for Bird Proof Track, per doz.	1.50
63	1052	Adjustable Bird Proof Hangers	per doz. sets 24.00
63		Double Brackets for Bird Proof Track	per doz. sets 3.00
64	1200	Covered Bird Proof Door Track	per 100 feet 30.00
		Lag Screws for Covered Bird Proof Track	per 100 pieces 2.45
65	458	Double Tread Barn Door Hangers	per doz. 13.80
65	452	Double Tread Barn Door Track	per 100 feet 10.00
66	566	Covered Double Strap Barn Door Hangers	per doz. sets 12.00
66	487	Rigid Barn Door Track	per 100 feet 7.30
66	567	Covered Jointed Barn Door Hanger	per doz. 12.00
67	455	Sliding Barn Door Latch	per doz. 3.70
67	456	Screw Adjustable Stay Roller	per doz. 2.00
67	457	Slide Adjustable Stay Roller	per doz. 2.00
67	349	Off Set Hinges	per pair .80
67	1205	Steel Door Stop	per doz. 1.40
68		Louden Silent Salesman:	
		Fitted with Louden Junior Fork Carrier	each 13.60
		Fitted with Louden Senior Fork Carrier	each 15.40
		Fitted with Iowa Sling Carrier	each 19.40
		Fitted with Carry-All Sling Carrier	each 21.60

Stalls, Stanchions, Mangers, Animal Pens and Sundry Dairy Barn Fittings

Page	Fig.		Price
76-77-78	812	Louden Cross Braced Double Post Cow Stall: Standard 812 Stall complete, as specified	\$ 8.00
		Standard 812 End Section, as specified	4.00
79	994	Louden Stall Partitions: Standard Partition, either style, as specified	1.30
		Standard Partition as above, including one Floor Flange	1.60
		Standard Partition as above, including 1 Floor and 1 Wall Flange	1.90
82	810	Louden Triple Post Cow Stall: Standard 810 Stall complete, as specified	8.00
		Standard 810 End Section, as specified	3.00
84	959	Louden Side Post Stall: Standard 959 Stall complete, as specified	6.65
		Standard 959 End Section, as specified	3.00
85	1149	Louden Stanchion Side Chain25
85	1149	Throat Chains with Holders60
87	796	Louden Single Post Cow Stall: Standard 796 Stall complete, as specified	5.50
		Standard 796 End Section, as specified	2.60
88-89	999	Louden Go-Right Stall, without Manger: Go-Right Stall, complete as specified	7.75
	1000	Go-Right End Section, as specified	2.60
91	951	Louden Simplicity Cow Stall: Fittings for Simplicity Stall, as specified	\$ 3.80
		Fittings for Simplicity End Section	1.60
		Fittings for Simplicity Stall to set on Wood Floor, extra50
		Fittings for Simplicity End Section to set on Wood Floor, extra50
92	948-949	Louden Adjustable Stall, complete with Individual Manger, as specified	25.00
		End section for Adjustable Stall complete, as specified	4.00
94	935	Name Plate Holders, with Steel Plate 4x15 inches36
		Name Plate Holders without Steel Plate32
		For Larger Sheet, each square foot or fraction16
94	1182	Name Plate Holder with isinglass and blank card72
94	1056	Salt Roll Holder48
		Salt Rolls, sold in dozen lots only, f. o. b. St. Clair, Mich ..per doz.	2.00
96	1298	Adjustable or Alignment Stanchion Holder: For Top Rail, as specified60
96	1299	Adjustable Stanchion Anchor30
97	1151	Louden Step Back	1.25
101	970	Louden Cut-out Form15
101	1074	Louden Curb Gauge05
101	1013	Louden Manger Templet, any size specified25
101		Louden Cement Tools:	
		No. 1	each .60
		No. 2	each .60
		No. 4	each .32
		No. 5	each 1.00
		No. 6	each 1.20
101	1192	Star Drills:	
		1/2x8	each .50
		5/8x8	each .60
		3/4x8	each .70
		7/8x8	each .75
104 Plate 14		No. 2 Individual Manger Divisions, no springs	2.00
104 Plate 14		No. 3 Division, Spring Balance, as specified	3.05
104 Plate 14		No. 4 Division, Spring Balance, as specified	3.30
105	990	Louden Spring Balance Galvanized Mangers: Standard Size Mangers, as specified	each 6.50

For Galvanized Stalls and Parts Add 30% F. O. B. Cars, Fairfield, Iowa

Stalls, Stanchions, Mangers, Etc.—Continued

Page	Fig.		Price
105		Large Size Mangers, as specified	each \$ 7.30
		Extra per manger for fittings galvanized.....	.60
111	861	Louden Tubular Steel Stanchions, naked.....	each 1.85
	861A	Louden Tubular Steel Stanchion, with Guide.....	each 1.95
	861C	Louden Stanchion with Holder and Anchor.....	each 2.25
	861B	Louden Tubular Stanchion, with Guide, Holder and Anchor.....	2.35
		Guide or Hold-Open for Tubular Stanchion	each .10
		Upper or Lower Stanchion Holder.....	each .20
112	937	Louden Wood-lined Stanchion, naked	each 1.85
		Louden Wood-lined Stanchion with Guide	each 1.95
		Stanchion with Holder and Anchor.....	each 2.25
		Louden Wood-lined Stanchion with Guide, Holder and Anchor.....	each 2.35
		Guide or Hold-Open for Wood-lined Stanchion	each .10
113	1159	Louden Quick Adjustable Stanchion:	
		Stanchion, Naked.....	each 4.50
		Stanchion with Holder and Anchor.....	each 4.90
114	1161	Louden 5-in-1 Stanchion:	
		Stanchion, Naked.....	each 2.50
		Stanchion with Holder and Anchor.....	each 2.90
115	1275	Gravity Water Bowl with Cover and Stall Post Attachments.....	each 2.50
		Gravity Water Bowl without Cover, with Stall Post Attachments	each 2.00
		Governing Tank for Gravity Water Bowl, galvanized.....	each 6.60
116	1274	Automatic Sanitary Drinking Bowls, per Double Bowl complete	\$ 6.00
		Automatic Sanitary Drinking Bowls (right or left).....	each 3.00
		Clamps for Attaching Supply Pipe to Horizontal Top Rail.....	each .16
120	1021	Louden Calf Pens:	
121	1022	Plain Panel per lineal foot.....	1.80
		For each Calf Stanchion built in panel, extra.....	.50
		Fittings for Gate—Hinges, Latches, etc	4.00
		Pipe and Fittings for Arch Over Gate.....	2.25
		Mangers for Calf Pens, per manger.....	5.85
124-125	995-996	Louden Maternity Pens:	
		Curb Construction, per lineal foot	1.80
		Panel Construction, per lineal foot.....	2.05
		Fittings for Gate—Hinges, Latches, etc.....	4.00
		Pipe and Fittings for Arch Over Gate.....	2.25
		Tilting Manger	12.60
		Stanchions for Cow Pen Built into Panel.....	3.00
126	1164	Louden Tubular Steel Bull Pens:	
		Tubing and Fittings for sides of pen, per lineal foot.....	2.25
		Fittings for Gate—Hinges, Double Latch, etc.....	5.00
		Pipe and Fittings for Arch Over Gate	2.25
127	1165	Tubing and Fittings for Regular Corner Manger with Stanchion and Manger.....	21.50
128	1301	Special Corner Manger with Louden Outside Feed Manger	20.00
128	1300	Outside Manger for Bull Pen without Stanchion.....	4.50
		Tilting Manger	19.80
		Stanchion for Side of Bull Pen, not including top rail.....	3.00
129	1167	Louden Tubular Steel Hog Pens, Fillers spaced 4 inches:	
		Plain Panel, per foot.....	2.10
		Swinging Panel, 6-foot section.....	19.00
		Swinging Panel, 8-foot section.....	23.10
		Swinging Panel, 10-foot section.....	27.35
		Fittings for Gate—Latches, Hinges, etc.....	4.00
		Pipe and Fittings for Arch-Over Gate	2.25
		Intermediate length of swinging panel take prices for next longest sections.	

For Galvanized Stalls and Parts Add 30% F. O. B. Cars, Fairfield, Iowa

Stalls, Stanchions, Mangers, Etc.—Continued

Page	Fig.		Price
131	1286	Guard Rails for pens add 30c per foot to above price.	
132	1171	Louden Improved Alley Gate:	
		3 feet by 2 feet 11 inches.....	\$ 5.50
		3 feet by 3 feet 5 inches.....	6.10
		3 feet by 3 feet 11 inches.....	6.70
135	1185	Louden Reinforced Building Columns:	
		Prices given in table are f. o. b. Chicago, Ill., or Cambridge, Mass.	

Diam. of Column	Length of Columns in Feet, Including Caps and Bases						
	7'	7'-6"	8'	8'-6"	9'	9'-6"	10'
3"	\$ 2.85	\$ 3.10	\$ 3.50	\$ 3.65	\$ 4.00	\$ 4.35	\$ 4.55
3½"	3.30	3.40	3.80	4.10	4.50	5.00	5.40
4"	4.75	5.15	5.60	6.00	6.45	7.00	7.55
4½"	6.85	7.80	8.55	9.00	9.60	9.90	10.30
5"	11.00	12.10	12.85	13.65	14.65	15.60	16.60
6"	11.00	11.85	12.80	13.25	14.80	16.15	17.60

In ordering be sure to give outside diameters.

136 Plate 15 Louden Dairy Barn Fittings. All sizes given for outside diameter.

Plate No.	Price	Plate No.	Price
N-1	Single Piece Elbow:	N-13	Five-piece Center Partition Coupling:
	1½"		1½"
	1⅞"		1⅞"
N-2	Interlocking "T" Coupling:	N-14	"T" Coupling for Large Posts:
	1½"		1½" x 2¾"
	1⅞"		1½" x 2⅞" or 3"
N-3	Cross Coupling:		1½" x 3½"
	1⅞"		1½" x 4"
	1½"		1½" x 4½"
	1⅞"		1½" x 5"
N-4	Inverted "Y" Coupling:		1½" x 5½" or 5⅝"
	1½" x 1½"		1½" x 6"
N-5	Angle "T" Coupling:		1½" x 6⅝"
	1½" x 1½"		1⅞" x 2¾"
N-6	Right Angle Corner Coupling:		1⅞" x 2⅞" or 3"
	1½"		1⅞" x 3½"
	1⅞"		1⅞" x 4"
N-7	72-Degree Corner Coupling:		1⅞" x 4½"
	1½"		1⅞" x 5"
	1⅞"		1⅞" x 5½" or 5⅝"
N-8	120-Degree Corner Coupling:		1⅞" x 6"
	1½"		1⅞" x 6⅝"
	1⅞"	N-15	Cross Couplings for Large Posts:
N-9	Straight Side Partition Coupling:		1½" x 2¾"
	1½"		1½" x 2⅞" or 3"
	1⅞"		1½" x 3½"
N-10	Angle Side Partition Coupling:		1½" x 4"
	1½"		1½" x 4½"
	1⅞"		1½" x 5"
N-11	Three-piece Center Partition Coupling:		1½" x 5½" or 5⅝"
	1½"		1½" x 6"
	1⅞"		1½" x 6⅝"
N-12	Four-piece Center Partition Coupling:		1⅞" x 2¾"
	1½"		1⅞" x 2⅞" or 3"
	1⅞"		1⅞" x 3½"
			1⅞" x 4"

For Galvanized Stalls and Parts Add 30% F. O. B. Cars, Fairfield, Iowa

Stalls, Stanchions, Mangers, Etc.—Continued

Plate No.	Price	Plate No.	Price
	1 7/8 x 1 1/2 \$1.45		
	1 7/8 x 5 1.65		
	1 7/8 x 5 1/2 or 5% 1.85		
	1 7/8 x 6 2.00		
	1 7/8 x 6 5/8 2.20		
N-16	Large Floor Flange \$.60		
N-17	Wall Flange48		
N-18	Wall or Flat Post Flange:		
	1 1/8 \$.40		
	1%44		
N-20	Interlocking Stanchion Holder:		
	Either size specified \$.20		
N-21	Collar, either size specified... .20		
N-22	Double Pivot for Manger Hinges:		
	1% \$.36		
	1 7/840		
N-23	Single Pivot for Manger Hinge:		
	1% \$.24		
	1 7/832		
N-24	Pressed Steel Clip:		
	1 1/8 \$.12		
	1%14		
	1 7/816		
N-25	Center Brace Rod Clamp48		
N-26	End Brace Rod Clamp44		
N-27	Right Angle Side Partition Couplings for Large Posts or Columns with Built-on Clamps. Sixteen sizes as follows:		
	Small		
	End Center		
	1 5/8 2 7/8 or 3 \$1.15		
	1 5/8 3 1/2 1.35		
	1 5/8 4 1.50		
	1 5/8 4 1/2 1.65		
	1 5/8 5 1.90		
	1 5/8 5 1/2 or 5 5/8 2.05		
	1 5/8 6 2.20		
	1 5/8 6 5/8 2.45		
	1 7/8 2 7/8 or 3 1.15		
	1 7/8 3 1/2 1.45		
	1 7/8 4 1.65		
	1 7/8 4 1/2 1.85		
	1 7/8 5 2.00		
	1 7/8 5 1/2 or 5% 2.20		
	1 7/8 6 2.45		
	1 7/8 6 5/8 2.60		
N-28	Right Angle Center Partition Couplings for Large Posts or Columns with Built-on Clamps. Sixteen sizes as follows:		
	Small		
	End Center		
	1 5/8 2 7/8 or 3 \$1.55		
	1 5/8 3 1/2 1.70		
	1 5/8 4 1.90		
	1 5/8 4 1/2 2.05		
	Small		
	End Center		
	1 5/8 2 7/8 or 3 \$1.55		
	1 5/8 3 1/2 1.70		
	1 5/8 4 1.90		
	1 5/8 4 1/2 2.05		
	Small		
	End Large End		
	1 5/8 2 7/8 or 3 \$1.15		
	1 5/8 3 1/2 1.35		
	1 5/8 4 1.55		
	1 5/8 4 1/2 1.70		
	1 5/8 5 1.90		
	1 5/8 5 1/2 or 5% 2.05		
	1 5/8 6 2.20		
	1 5/8 6 5/8 2.45		
	1 7/8 2 7/8 or 3 1.30		
	1 7/8 3 1/2 1.45		
	1 7/8 4 1.65		
	1 7/8 4 1/2 1.85		
	1 7/8 5 2.00		
	1 7/8 5 1/2 or 5% 2.20		
	1 7/8 6 2.30		
	1 7/8 6 5/8 2.55		

Stalls, Stanchions, Mangers, Etc.—Continued

Page	Fig.		Price
139	1150	Louden Grip Clamps (Illustrated also on page 136.)	
		No. 1—1 $\frac{1}{8}$ "x1 $\frac{5}{8}$ "	\$.36
		No. 2—1 $\frac{3}{8}$ "x1 $\frac{5}{8}$ "36
		No. 3—1 $\frac{1}{2}$ "x1 $\frac{5}{8}$ "32
		No. 4—1 $\frac{5}{8}$ "x1 $\frac{5}{8}$ "32
		No. 5—1 $\frac{5}{8}$ "x1 $\frac{5}{8}$ "32
		No. 6—1 $\frac{5}{8}$ "x1 $\frac{5}{8}$ "28
		No. 7—1 $\frac{3}{8}$ "x1 $\frac{5}{8}$ "28
		No. 8—1 $\frac{1}{8}$ "x1 $\frac{5}{8}$ "24
139	727	Hook Bolt, $\frac{1}{2}$ "x712
	727	Hook Bolt, $\frac{3}{4}$ "x7 in lots of one dozen or more.....	1.12
139	879	Expansion Bolts, $\frac{3}{8}$ "x216
	879	Expansion Bolts, $\frac{1}{2}$ "x216
139	1073	Helical Anchor Bolt, $\frac{3}{8}$ "x2.....	.16
139	1190	Louden Parallel Clamps, four sizes as specified.....	.16
141	1269	Louden Cupola, No. 4 size, galvanized, 20" throat.....each	38.00
		Louden Cupola, No. 3 size, galvanized, 24" throat.....each	43.00
		Louden Cupola, No. 2 size, galvanized, 27" throat.....each	46.50
		Louden Cupola, No. 1 size, galvanized, 30" throat.....each	51.00
		Louden Cupola, No. 100 size, galvanized, 36" throat.....each	60.00
		Louden Cupola Lightning Rod Attachment, add \$1.65 net to above prices.	
		Lettering Louden Cupola Base in Zinc Letters 25c net per letter.	
		Stenciling name in black letters, \$1.00 net.	
142	1268	Louden Ventilator, throat diameter 12 inches, galvanized.....each	13.00
		Louden Ventilator, throat diameter 18 inches, galvanized.....each	20.00
		Louden Ventilator, throat diameter 24 inches, galvanized.....each	33.00
		Louden Ventilator, throat diameter 30 inches, galvanized.....each	46.00
146	988	Louden Window Ventilators	1.75
147	1272	Louden Manger Drain, complete.....	2.00
	1271	Louden Gutter Drain, complete with brass cover.....	5.00
		Louden Gutter Drain, complete, less brass cover.....	3.80

Litter Carriers, Feed Carriers, Merchandise Carriers, Steel Cranes, Tracks, Track Fittings, Etc.

Page	Fig.		Price
157	828	Louden Emancipator Litter Carrier.....	each \$35.00
161	720	Louden Standard Litter Carrier.....	each 32.00
162	882	Louden Quick-out Litter Carrier.....	each 26.00
163	721	Louden Self-Acting Litter Carrier.....	each 17.50
165	1287	Steel Track for Combination Litter Carrier.....	per foot .15
165	1288	Track Hangers for Combination Litter Carrier Track.....	per doz. 1.95
166	1297	Two-way Switch for Combination Track.....	each 4.00
166	1296	Three-way Switch for Combination Track.....	each 4.50
166	1290	Connecting Brace for Combination Steel and Rod Track.....	3.00
166		End Stop for Combination Carrier.....	.24
167	845	Louden Double End Feed Carrier.....	each 35.00
	804	Louden Double End Feed Carrier, Standard Hoisting Gear (not illustrated).....	each 32.00
	903	Louden Double End Feed Carrier with Adjustable Chain (not illustrated).....	each 29.50
168	763	Louden Standard Feed Carrier.....	each 29.00
	904	Louden Single End Feed Carrier, Emancipator Hoisting Gear (not illustrated).....	each 31.00
169	886	Louden Single End Feed Carrier with Adjustable Chain.....	each 26.00
169	887	Louden Wire Track Feed Carrier.....	each 25.00
170	1042	Louden Side Delivery Feed Carrier.....	each 33.50
	972	Louden Side Delivery Feed Carrier with Standard Hoisting Gear (not illustrated).....	32.00
170	1044	Louden Side Delivery Feed Carrier with Adjustable Chain.....	each 29.50
171	973	Louden Feed Truck (floor) 20 bushels.....	each 27.00
	1099	Louden Feed Truck (floor) 25 bushels (not illustrated).....	each 32.00
171	1276	Louden 12-hook Harness Carrier.....	each 15.00
171	1048	Louden 4-hook Harness Carrier.....	each 5.00
172	888	Louden Merchandise Carrier.....	each 6.50
172	890	Louden Double Truck Merchandise Carrier.....	each 16.60
172		Perfect Hoist No. 33 (no rope).....	each 5.00
172		Barrel Grabs.....	each 2.00
173	802	Louden Platform Milk Can Carrier (steel track).....	each 9.80
173	1045	Railroad Milk Can Carrier (steel track) emancipator Hoisting Gear.....	each 26.50
		Railroad Milk Can Carrier with Standard Hoisting Gear (not illustrated).....	each 23.00
173	766	Louden Wire Track Milk Can Carrier.....	each 9.80
174	767	Louden Suspended Milk Can Carrier (wire track).....	each 8.50
174	1046	Railroad Milk Can Carrier (wire track).....	each 17.00
174	809	Louden Platform Hay Carrier.....	each 15.00
175	571	Louden Double Bead Steel Track.....	per 100 feet 18.67
			Regular Adjustable
175	832	Link Track Hangers, 5-inch.....	per doz. \$1.50 \$1.90
	803	Link Track Hangers, 7-inch.....	per doz. 1.70 2.10
	833	Link Track Hangers, 9-inch.....	per doz. 1.90 2.30
	834	Link Track Hangers, 11-inch.....	per doz. 2.10 2.50
	835	Link Track Hangers, 13-inch.....	per doz. 2.30 2.70
	836	Link Track Hangers, 15-inch.....	per doz. 2.50 2.90
	837	Link Track Hangers, 17-inch.....	per doz. 2.70 3.10
	838	Link Track Hangers, 19-inch.....	per doz. 2.90 3.30
	839	Link Track Hangers, 21-inch.....	per doz. 3.10 3.50
	840	Link Track Hangers, 23-inch.....	per doz. 3.30 3.70
	841	Link Track Hangers, 25-inch.....	per doz. 3.50 3.90
	842	Link Track Hangers, 27-inch.....	per doz. 3.60 4.00
		Link Track Hangers, 29-inch.....	per doz. 3.70 4.10
		Link Track Hangers, 31-inch.....	per doz. 3.80 4.20
		Link Track Hangers, 33-inch.....	per doz. 3.90 4.30
		Link Track Hangers, 35-inch.....	per doz. 4.00 4.40
		Link Track Hangers, 37-inch.....	per doz. 4.10 4.50
175	424	Louden Rafter Brackets.....	per doz. .66
175	465	Louden Ridge Pole Bracket.....	per doz. .94

Litter Carriers, Feed Carriers, Etc.—Continued

Page	Fig.		Price
175	675	Louden Side Rafter Bracket..... per doz.	\$ 1.12
175	725	Louden Beam Bracket..... per doz.	1.40
175	726	Louden Screw Eye..... per doz.	1.12
175	523	Louden End Stop Block..... each	.24
178	1277	Track Support at End of Barn 24 feet long..... each	19.50
		Track Support at End of Barn 30 feet long..... each	23.40
		Track Support at End of Barn 36 feet long..... each	27.20
		Track Support at End of Barn 42 feet long..... each	31.10
		Track Support at End of Barn 48 feet long..... each	35.00
		Track Support at End of Barn 54 feet long..... each	38.90
		(For intermediate lengths, deduct 25c per foot from the next longest length upon which price is mentioned.)	
179	1279	Steel Post for Supporting Track in Yard, 8-foot post..... each	15.90
		Steel Post for Supporting Track in Yard, 10-foot post..... each	18.35
		Steel Post for Supporting Track in Yard, 12-foot post..... each	20.80
		Steel Post for Supporting Track in Yard, 14-foot post..... each	23.20
		Steel Post for Supporting Track in Yard, 16-foot post..... each	25.65
181	736	Louden Two-Way Switch..... each	4.45
181	795	Louden Three-Way Switch..... each	5.20
181	849	Louden Cross Track Switch..... each	5.20
182	1209	Louden Track Brace for Link Hangers..... each	.60
182	859	Louden Track Opener..... each	4.00
183	639	Louden Bent Section for Curve..... each	1.80
183	633	Louden Removable Section, 2 feet long..... each	1.00
		Louden Removable Section, 4 feet long..... each	1.40
185	974	Louden Swinging Steel Crane with Track, 12 feet..... each	18.50
185	976	Louden Swinging Steel Crane with Track, 22 feet..... each	25.00
185	978	Louden Swinging Steel Crane with Track, 30 feet..... each	37.50
185	980	Louden Swinging Steel Crane with Track, 40 feet..... each	45.00
		For Swinging Crane less the vertebra hinge, deduct.....	5.00
		(Prices on Steel Cranes include track and hangers.)	
186	791	Fittings for Swinging Section at Driveway..... each	6.00
187		No. 0000 Basic Steel Wire cut to length..... per 100 feet	4.50
187		No. 0000 Basic Steel Wire in unbroken coils..... per 100 feet	4.00
		(Coils average 450 feet)	
187	746	Louden Wire Track Suspender..... each	2.40
187	747	Louden Tackle Block Suspender, including pulley..... each	2.80
187	750	Louden Angle Iron for Wire Track..... each	1.25
188	745	Louden Wire Track Anchor (20 feet or under)..... each	3.20
	910	Louden Wire Track Anchor (over 20 feet)..... each	3.65
188	1207	Tension Bolts, $\frac{3}{4}$ x 30..... each	.70
		Tension Bolts, $\frac{3}{4}$ x 15..... each	.45
		Tension Bolts, $\frac{3}{4}$ x 8..... each	.30
		Tension Bolts, $\frac{7}{8}$ x 30..... each	.85
189	892-893	Louden Wire Track Switches..... each	2.65
189	749	Louden Cross Track Holder..... each	.20
190	797	Louden Wire Track Reverse Curve..... each	4.10
190	753	Louden Spring End Stop..... each	1.20
190	755	Anchor Loop..... each	.65
190	756	Anchor Yoke..... each	.75
190	757	Louden Clamp Loop..... per doz.	1.62
		Hoisting Gear for Emancipator Carrier with trucks, wheels, and 7-foot chains..... each	21.10
		For each added foot of lift, add per foot.....	1.10
		Hoisting Gear for Standard Litter Carrier with trucks, wheels and hoisting cables..... each	16.65
		Galvanized Box or Tub for Emancipator and Standard Litter Carriers..... each	20.00
		Double End Feed Box..... each	20.00
		Trolley for Feed Carrier, adjustable chains..... each	9.45
		Gear for Quick Out Litter Carrier, including trucks and wheels..... each	15.00
		Gear for Self-Acting Litter Carrier, including trucks and wheels..... each	8.90

Litter Carriers, Feed Carriers, Etc.—Continued

	Price
Box or Tub for Quick-Out Litter Carrier.....each	\$15.00
Box or Tub for Self Acting Litter Carrier..... each	13.30
Anchor Bolt, ¾-inch by 6 feet..... each	1.65
Trip for Self-Acting Carriereach	.40
Trip for Quick Out Litter Carrier.....each	.55
Removable Splice Clamp.....each	.30
Vertebra Hinge.....each	5.00
Hoisting Cables for Standard Litter Carrier each	.45
1 Single Truck only (½ set) for Litter Carrier.....each	3.05
1 Single Truck only (½ set) for Wire Track Litter Carrier each	1.65

Horse Stable Equipment

All Horse Stable Equipment f. o. b. Chicago.

Automatic Hay Racks (Warren Patent)

Page	Fig.	Full Back			Open Back	
		Height	Width	Price	Fig.	Price
198	1210	36 inches	42 inches	\$ 8.40	1210½	\$ 7.60
	1211	36 inches	48 inches	8.80	1211½	8.00
	1212	36 inches	36 inches	8.00	1212½	7.20
	1213	42 inches	36 inches	8.40	1213½	7.60
	1214	30 inches	54 inches	8.40	1214½	7.60
	1215	36 inches	72 inches	13.60	1215½	12.00
	1216 (Pony)	30 inches	30 inches	7.20	1216½	6.40
	1217 (Sheep or Calf)	24 inches	54 inches	8.40	1217½	7.60
	1218 (Cow Pen)	36 inches	36 inches	(Open front only for cow pen).....		7.60
201	1225A	Wrought Iron Center Hay Rack, 24 inches wide by 30 inches high by 16 inches deep.....				7.20
201	1225B	Wrought Iron Center Hay Rack, 30 inches wide by 30 inches high by 16 inches deep.....				7.70
201	1225C	Wrought Iron Center Hay Rack, 42 inches wide by 30 inches high by 16 inches deep.....				8.65
201	1226	Wrought Iron Corner Hay Rack.....				5.80
202	1227	Extended Hay Rack for Hay Chute, 5 feet high by 33 inches wide				13.00
202	1227-½	Extended Hay Rack for Hay Chute, 5 feet 6 inches high by 42 inches wide.....				16.80
202	1228	Extended Corner Hay Rack for Hay Chute, 5 feet 6 inches wide....				9.40
203	1229A	Wrought Iron Center Hay Rack, 24x30x16 inches.....				5.80
203	1229B	Wrought Iron Center Hay Rack, 30x30x16 inches.....				6.25
203	1229C	Wrought Iron Center Hay Rack, 42x30x16 inches.....				7.20
203	1230	Wrought Iron Corner Hay Rack.....				4.60
203	1231	Cast Iron Corner Hay Rack.....				7.90
204	1232A	Sanitary Steel Feed Box (Warren patent) 20x12x7 inches.....				5.60
204	1232B	Sanitary Steel Feed Box (Warren patent) 20x13x9 inches.....				6.00
204	1232C	Sanitary Steel Feed Box (Warren patent) 14x12x7 inches.....				5.00
206	1234	Patent Slow Feed Corner Manger, Japaned.....				2.65
206	1235	Roll Front Corner Manger, Japaned.....				2.65
206	1236	Flange Front Corner Manger, 16x16x9½ inches, Japaned.....				2.20
		Flange Front Corner Manger, 17x17x10 inches, Japaned.....				2.40
206	1237	Wall Manger, 18x12x8 inches, Japaned.....				2.90
206		Wall Manger, 24x14x11 inches, Japaned.....				5.55
		Detachable Mounting Attachment for Wall Manger (not illustrated).....				1.20
		Wire Window Guards will be furnished any size but in quoting prices no guard will be considered as containing less than 8 feet square.				
207	1251	Wire Window Guards, ¾-inch mesh, No. 14 wire, per square foot				.38
	1251	Wire Window Guards, 1 -inch mesh, No. 13 wire, per square foot				.30
	1251	Wire Window Guards, 1¼-inch mesh, No. 13 wire, per square foot				.28
	1251	Wire Window Guards, 1¼-inch mesh, No. 12 wire, per square foot				.30
	1251	Wire Window Guards, 1¼-inch mesh, No. 11 wire, per square foot				.34
207	1251	Wire Window Guards, 1½-inch mesh, No. 13 wire, per square foot				.24
	1251	Wire Window Guards, 1½-inch mesh, No. 12 wire, per square foot				.26
	1251	Wire Window Guards, 1½-inch mesh, No. 11 wire, per square foot				.30
	1251	Wire Window Guards, 1½-inch mesh, No. 10 wire, per square foot				.34
	1251	Wire Window Guards, 1¾-inch mesh, No. 11 wire, per square foot				.26
	1251	Wire Window Guards, 1¾-inch mesh, No. 10 wire, per square foot				.30
	1251	Wire Window Guards, 1¾-inch mesh, No. 9 wire, per square foot				.34
	1251	Wire Window Guards, 2 -inch mesh, No. 10 wire, per square foot				.26
	1251	Wire Window Guards, 2 -inch mesh, No. 9 wire, per square foot				.30
	1251	Wire Window Guards, 2 -inch mesh, No. 8 wire, per square foot				.34
207	1238	Iron Drinking Fountain.....				46.80
209	1242A	Wrought Steel Stall Guards, 2 feet high by 6 feet long.....				6.60
	1242A	Wrought Steel Stall Guards, 2 feet high by 5 feet long.....				5.40
	1242A	Wrought Steel Stall Guards, 2 feet high by 7 feet long.....				7.80
	1242A	Wrought Steel Stall Guards, special length to order, per lineal foot				1.32

Horse Stable Equipment—Continued

Page	Fig.		Price
	1242B	Wrought Steel Stall Guards, any length to order, per lineal foot....	\$ 1.32
210	1242C	Wrought Steel Stall Guards, any length to order, per lineal foot.....	1.20
210	1061	Louden Salt Rolls.....per doz.	2.00
210	1061	Louden Salt Roll Holders for attaching to horizontal timber...each	.48
210	1061	Louden Salt Roll Holders for attaching to vertical timbers...each	.48
210	1061	Louden Salt Roll Holders for attaching to tubular steel.....each	.48
210	1260	Heavy Harness Hook (13-inch) Japaned.....per doz.	10.80
211	1245	Stall Partition Top or Base Rail with groove to hold 2-inch board, per lineal foot.....	1.10
211	1245	Stall Partition Top or Base Rail with groove in top for Stall Guard, per lineal foot.....	1.30
211	1246	Stall Posts (No. 1) 5-inch diameter by 5 feet 4 inches high.....	25.72
		Additional height per inch.....	.20
		With 6-inch foundation base, extra.....	4.25
211	1246	Stall Posts (as above) with foundation base longer than 6 inches, add per inch.....	.20
211	1246	Stall Posts (No. 2) 6¾-inch diameter by 5 feet 4 inches high.....	32.86
		Price per inch of additional length.....	.26
211	1246	Stall Posts as above, with Foundation Base to go down in cement 6 inches, add.....	5.72
211	1246	Stall Posts as above, with Foundation Base to go down in cement more than 6 inches, add per inch.....	.26
211	1247	Heavy Post Socket for 6-inch wood post, 3½ inches high.....	2.86
211	1247	Heavy Post Socket for 6-inch wood post, 5½ inches high.....	3.25
211	1247	Heavy Post Socket for 6-inch wood post, 8 inches high.....	3.60
211	1248	Socket Plate for 6-inch post.....	2.20
212	1261	Heavy Carriage Wash Cess Pool, extra long spigot for calking, ea	7.00
212	1261A	Heavy Carriage Wash Cess Pool, with short spigot.....each	5.80
212	1262	Heavy Stable Cess Pool, 15½ inches square, with 4-inch outlet, ea.	5.30
212	1262	Heavy Stable Cess Pool, 15½ inches square, with extra long spigot.....each	6.35
212	1262	Heavy Stable Cess Pool, 12 inches square, 4-inch outlet.....each	4.80
212	1263	Basin Cess Pool, 4x 4.....each	.75
212	1263	Basin Cess Pool, 6x 6.....each	1.00
212	1263	Basin Cess Pool, 8x 8.....each	1.50
212	1263	Basin Cess Pool, 9x 9.....each	2.40
212	1263	Basin Cess Pool, 12x12.....each	3.20
213	1250	No. A Self-Acting Oats Cleaner (Higbie Patent), with ½ bu. capacity per minute.....	40.00
213	1250	No. B Self-Acting Oats Cleaner (Higbie Patent), with 1 bu. capacity per minute.....	40.00
213	1250	No. C Self-Acting Oats Cleaner (Higbie Patent), with 2 bu. capacity per minute.....	40.00

Page

210
210
210
210
210
210
211

211

211

211

211

211

211

211

21
21
21
21
21
21
21
21
21

2
2
2
2
2
2
2
2

2



