

LOUDEN

▼ Hay Unloading Tools ▼
Barn Door Hangers
Specialties

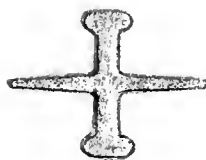

IMPORTANT

Because of the great change in the cost of all materials used in the manufacture of our goods, we are compelled to cancel all prices shown in this catalog.

See your Louden dealer or write to us for latest prices.

LOUDEN MACHINERY COMPANY

FAIRFIELD IOWA

ESTABLISHED 1887



JOHN A. SEAVERNS

LOUDEN

HAY UNLOADING TOOLS BARN DOOR HANGERS SPECIALTIES

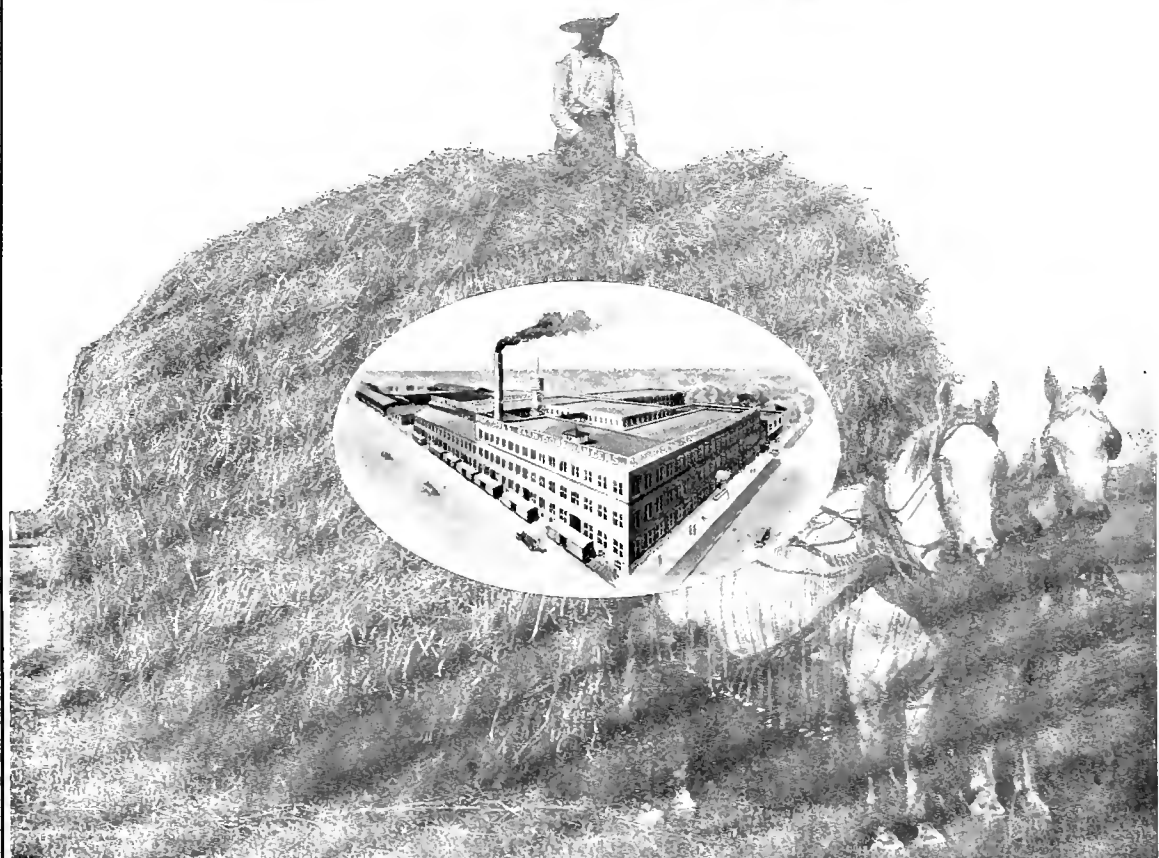

LOUDEN MACHINERY COMPANY
FAIRFIELD, IOWA
ESTABLISHED 1867

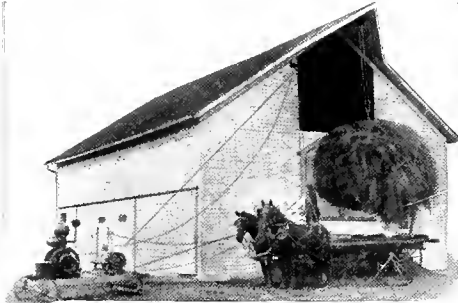

Louden Power Hoist and Carry-all Sling on an Iowa Farm. Louden Hay Tools save dollars in busy hay time

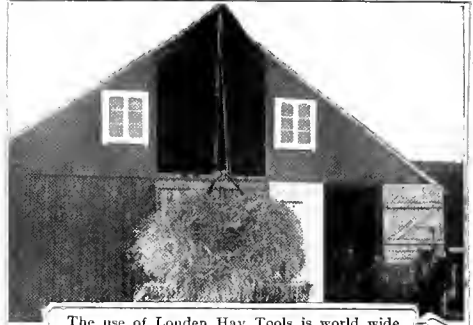

The use of Louden Hay Tools is world wide. This is the Rynke Farm, Långhybed, Sweden. This sling load weighs 1,700 lbs.

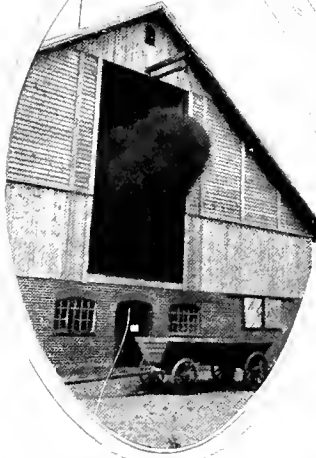

A big sling load going into a barn in Germany. Louden Hay Tools are used all over the world.

Waukesha, Wisconsin,
Aug. 11, 1914.
Louden Machinery Company,
Gentlemen:

We harvested 150 acres of alfalfa in 1913 and 1914, and are the largest alfalfa growers in Wisconsin. Our engine hoist, slings, horse forks, tracks, cars, and pulleys are all Louden hay tools. Goods of other makes were replaced by Louden make, because we found Louden goods to be more durable and convenient.

Durability of haying machinery means so much to us as we have so much hay to handle. Good reliable machinery is very important because one has extra help around, the weather is warm, and hay should be handled quickly and easily, and tools should be made to be handled by men conveniently, thus saving time, labor, expense, and worry in taking care of the hay crop when it is ready for mowing or stacking. No one can afford to spend the time for repairs or repairing poorly constructed or faulty in operation hay tools.

Yours very truly,
SWARTZ BROS.,
Per P. C. S.

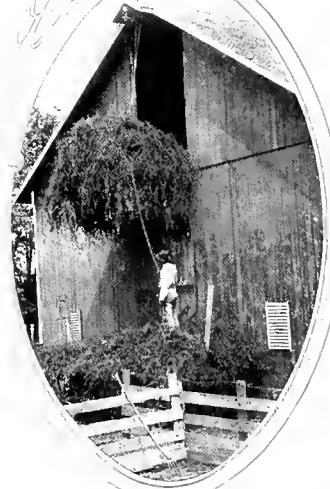

Louden Grapple Fork lifting a big load of hay. Louden Forks meet every requirement.



Louden Cable Rickers, Carriers and Grapple Forks are friends of the farmer when big, solid, water shedding stacks are desired.



The Cornalfalfa farms have Louden Hay Tools exclusively. Read the opinions expressed in a letter above and write for catalogs.

INTRODUCTORY

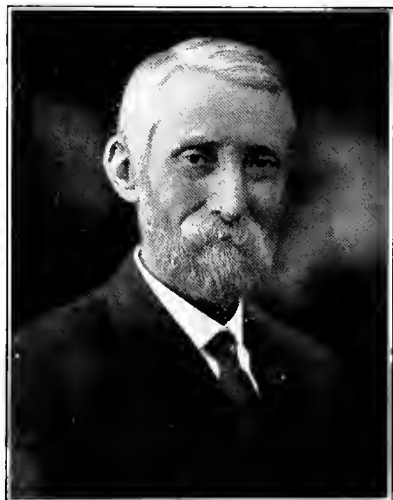

During nearly fifty years of hay tool manufacture, this company has held to one determination, and this determination is the foundation of its success.

We are determined that every Loudon product will go out in working order; that it will work easily; that it will work safely; that it will fulfill every claim made for it, and more.

It was forty-eight years ago that William Loudon made the first hay carriers, and they are still working.

That's quality!

Every day since 1866 — and most of these days many hours longer than the hardest working farmer puts in — William Loudon has given every detail of the manufacture his personal attention. He knows just as surely today that every Loudon product is properly constructed, as he did back in 1867 when he made Loudon carriers alone, by hand.

Our aim is to serve our customers in every way. With this in mind we established branch houses and distributing points in various parts of the country. This gives our customers the advantage of quick deliveries and low freight charges. The following are the names and addresses of the principal houses. Orders may be sent to them or direct to the factory at Fairfield, Iowa:

THE LOUDEN MACHINERY COMPANY, 2288 University Ave., St. Paul, Minn.

THE LOUDEN MACHINERY COMPANY, 344 Broadway, Albany, N. Y.

THE LOUDEN MACHINERY COMPANY, 303 East Columbia St., Fort Wayne, Ind.

THE LOUDEN MACHINERY COMPANY, Guelph, Ontario (Canadian Branch Factory).

HARBISON MANUFACTURING COMPANY, 1219-21 West Tenth St., Kansas City, Mo.

MILLER-CAHOON COMPANY, Salt Lake City (Murray Station), Utah.

ROYER IMPLEMENT COMPANY, 208 Front St., Portland, Ore.

SPOKANE SEED COMPANY, 906 First Ave., Spokane, Wash.

The number of barns equipped with Loudon products runs into millions and these goods have been sold — not as a result of advertising, not as a result of a superior selling organization, but as a result of the sterling worth of Loudon quality.

A purchase of Loudon hay tools is not an experiment; it is your best guarantee for satisfaction of service in hay-time — when time is precious.

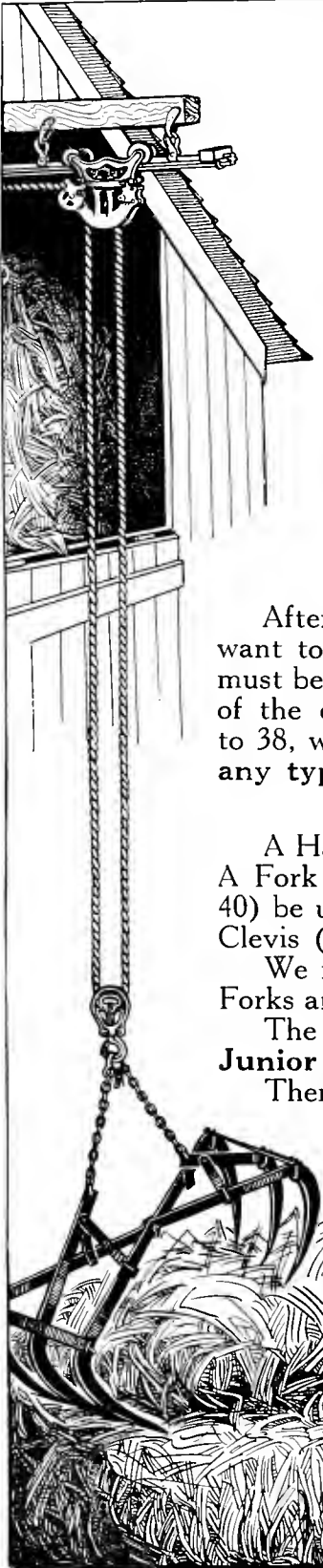

CHOOSING HAY UNLOADING TOOLS

While a majority of our friends who receive this catalog are posted on the subject of Hay Unloading Tools, we believe that a few words, outlining in a general way the different points to be considered in choosing an outfit, will be of interest to many.

Kinds of Barns

Barns may be divided into four classes:

1. **The Single End Hoist Barn.** In this type of barn the hay is taken into the mow at one end of the barn. (See page 54.)
2. **The Double End Hoist Barn.** Hay may be taken into this type of barn from either end of the building. (See page 55.)
3. **The Center Drive Barn.** This type has a driveway running through the center; hay is lifted up to the necessary height and carried into the left or right mow as desired. (See page 52.)
4. **The Round Barn.** This type of barn requires special equipment. (See pages 25, 26, 27, and 57 and 58.)

Forks or Slings?

After classifying your barn, the next point to consider is whether you want to use a Fork or Slings to remove the hay from the wagon. This must be very largely a matter of individual choice, and a careful reading of the descriptions of Forks, pages 32 to 34 and of Slings, pages 35 to 38, will help in the solution. Either Forks or Slings can be used in any type of barn.

The Carrier For You

A Hay Carrier is classified either as a Fork Carrier or Sling Carrier. A Fork Carrier can, by using our Self-Locking Sling Pulleys (see page 40) be used with Slings and a Sling Carrier can handle Forks, if a Fork Clevis (see page 39) is attached.

We recommend, that, insofar as possible, a choice be made between Forks and Slings before choosing a Carrier.

The following short descriptions give an idea of the different carriers:

Junior Fork Carrier

There are more Louden Junior Fork Carriers in use than any other carrier made. They meet all conditions and requirements for a fork carrier. They can be used in either center-drive or end-hoist barn. They can be depended upon to do their work at all times and under all reasonable conditions. (See page 6.)

Senior Fork Carrier

This is the strongest Fork Carrier made and is easy to operate. It can be used in Center Drive or End Hoist barns and is specially recommended where heavy loads are to be handled. (See page 8.)

Standard Fork Carrier

This Carrier can be used in any style of barn, but is especially recommended for use in barns where hay is taken up at one end of building, or where hay is carried in one direction only. (See page 10.)

Carry-All Sling Carrier

This Carrier is the heaviest, strongest and easiest working Sling Carrier manufactured. It is adapted for use in any style barn. For a large barn where there are large loads of hay to be mowed the Carry-All will handle half-ton loads safely, and will not cut or break the fibre of the rope, and will give satisfaction under all reasonable conditions. (See page 12.)

Iowa Sling Carrier

The Iowa Sling carrier is adapted for use in any style barn. It is not so heavily built as the Carry-All, but for all general work it gives entire satisfaction. (See page 14.)

Cross Draft Carrier

This carrier can be used in any type of barn but is recommended for barns where hay is taken up in the center. The carrier works on a new principle—the horse walks away from the barn to elevate the load and turns back toward the barn to pull the load back into the mow. This saves one half the travel of the horse. (See page 18.)

Round Barn Outfit

The special Round Barn Carrier operated with a Louden Triple Drum Power Hoist makes the most satisfactory outfit for unloading and mowing hay in a round barn. (See page 25.)

Carriers for Wood Track

Louden Junior Fork Carrier is recommended for use with forks. (See page 11.) Reversible Sling Carrier is recommended for use with slings. (See page 17.)

Louden Specialties

Louden Barn Door Hangers

Our line of barn door hangers is well known, and our leading hanger, the Bird-Proof, is the most popular made. (Page 60.)

Louden's Cable Ricker (pages 28-29) is an economical and satisfactory method of stacking hay in the field.

A Louden Power Hoist (pages 21 to 24) will save money during the haying season if there is a gasoline engine or other power on the farm, and will be of great service whenever a "powerful lift" is needed.

Louden's Hoisting Singletree is a great convenience wherever a horse is used for hoisting. (See page 47.)

Louden Hay Rack Clamps enable any farmer to build a strong, serviceable hay rack with little expense. (See page 48.)

Louden Combination Rack Irons are useful when an all-purpose rack is desired, as it is easily changed for hay, wood, or hogs. (See page 49.)

Louden Offset Hinge is the best solution for the gable-end mow door. (See page 47.)

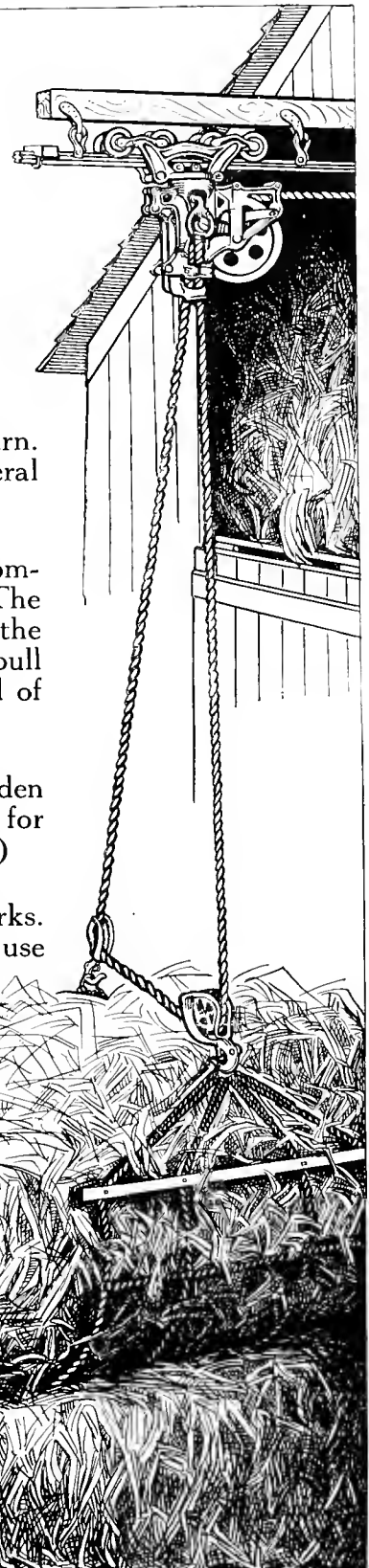

Louden Junior Hay Fork Carrier—Fig. 430

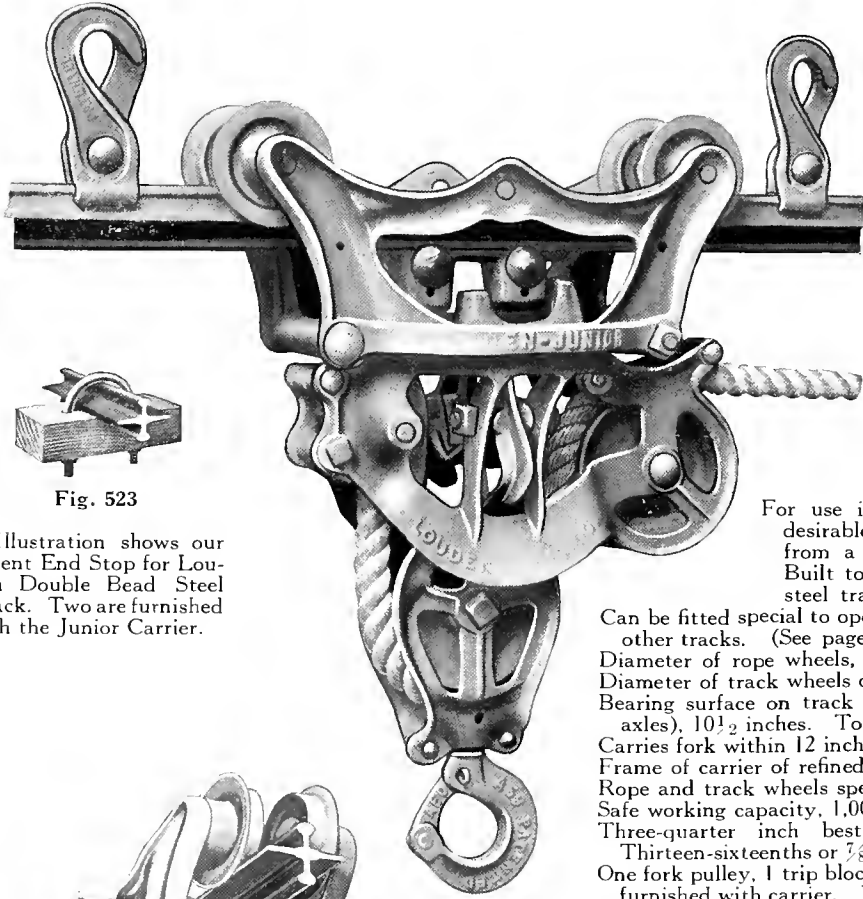

Fig. 523

Illustration shows our patent End Stop for Loudon Double Bead Steel Track. Two are furnished with the Junior Carrier.

Fig. 1123

Trip Block Furnished as Part of Carrier

Specifications

For use in any style of barn Especially desirable in barns where hay is unloaded from a center driveway or at both ends. Built to operate on Loudon Double Bead steel track.

Can be fitted special to operate on single bead steel track and other tracks. (See pages 30, 31.)

Diameter of rope wheels, 4 inches

Diameter of track wheels on tread, $2\frac{1}{4}$ inches.

Bearing surface on track (distance between front and rear axles), $10\frac{1}{2}$ inches. Total length of carrier, 13 inches.

Carries fork within 12 inches of track.

Frame of carrier of refined malleable iron.

Rope and track wheels special quality gray iron.

Safe working capacity, 1,000 pounds.

Three-quarter inch best manilla rope is recommended.

Thirteen-sixteenths or $\frac{7}{8}$ inch rope can be used.

One fork pulley, 1 trip block, 2 end stop blocks, 1 rope swivel furnished with carrier. Weight, 25 pounds. Price: \$4.33

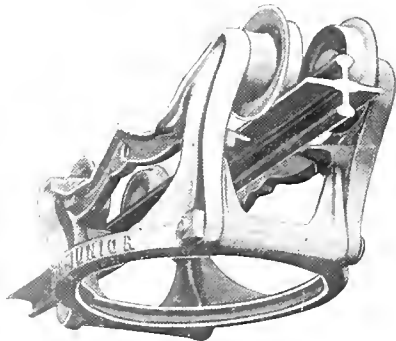

Fig. 7

Fig. 7 is an end view of the upper frame of all the Loudon Swivel Carriers, showing the great strength. The sides carrying the wheels are joined together by two end pieces. These end pieces have upwardly extending arms (as seen in cut), which are secured to the sides above while a bolt holds them together at the bottom, thus making the strongest possible frame, and at the same time saving space, as all the space taken up below the track is the thickness of the end pieces. This is a distinctive Loudon feature.

The wheel arms are thoroughly braced and will never spread with a heavy load and let the carrier off the track.

The Loudon Junior is the most popular and the biggest selling hay fork carrier. Its construction is simple and compact. More of these carriers are in use in the barns of the country than any other hay carrier made. For twenty years it has been standard and doing its work safely and surely on thousands of farms.

This carrier is suitable for use in any style of barn. Where hay is taken up at the end of building it works easily and smoothly as a one-way carrier. It is a "Louden swivel" carrier and where hay is unloaded from a center driveway it is quickly reversed. The pulley through which draft rope works in the end of the barn is changed from one end to the other. The carrier can then be swiveled around by giving a swinging pull on the draft rope. No climbing up to the carrier necessary. In long barns where hay is unloaded at both ends the carrier can be changed from one end to the other without changing a rope or pulley.

The carrier has the wide flaring mouth and the round topped fork pulley that have made all Loudon Carriers popular with hay growers. The fork pulley never fails to enter the carrier at the proper time. It is not necessary that the wagon should be directly under the carrier. The wide flaring mouth receives the round fork pulley no matter from what angle the fork is drawn and regardless of swinging load or twisting ropes. No failure, no backing up of the team to make the second trial.



Louden Junior Hay Fork Carrier—Continued



Cut A

The end of the rope is fastened in the Carrier with our patent swivel iron knot, as shown in A. The rope is placed through the tilting eye S (Fig. C 430), and the iron knot resting loosely thereon makes a complete, durable and simple swivel, which lets all kink and twist out of the rope.

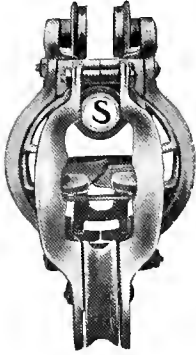

Fig. C, 430

Showing the wide flaring mouth.

The end of the rope is fastened in the carrier with our patent swivel iron knot. (See S in Fig. C 430.) The rope is placed through the tilting eye S and the iron knot, resting loosely on the eye, makes a complete, durable and simple swivel. This swivel allows all twists and kinks of the rope to escape. Many times when a new rope is first put in a carrier it will twist and kink so badly as to cause delays and annoyance. Sometimes it is necessary to take the rope out and turn it end for end. The swivel iron knot with the Louden Junior Carrier does away with all that trouble.

The rope wheels in the carrier and in the fork pulley are 4 inches in diameter and are heavy and strong. The wheels revolve on heavy malleable iron bushings recessed into the main frame. The short, heavy bushings sustain the weight of the load while the bolt passing through holds the frame of the carrier together. The wheels are perfectly formed and so smooth that the wear on the rope is reduced to a minimum.

The hook in the fork pulley which carries the fork is attached to the pulley by a strong swivel connection. Even should the load of hay turn around while being raised the ropes will not twist. This swivel hook in the fork pulley makes it practical to set the fork in the hay at any angle desired.

The grappling hooks in the carrier take a deep grip in the frame of the fork pulley. They grip the pulley securely, at the same time permitting the pulley to swing freely. This is of immense advantage as it permits filling the mow up to the track with no risk of breaking the carrier or the pulley. This also makes it practical to take a large forkful through a small door or over high beams.

The wheel arms are short and thick, reinforced by wide ribs. The wheels are equally strong; they are 2 1/4 inches in diameter on tread. The web is directly under the tread where the support is most needed. The track wheels operate on large, heavy axles, three-fourths of an inch in diameter, flared at the shoulders to give additional strength and prevent the wheels from binding on the frame. The track wheels and axles are milled true, insuring little wear. On special orders this carrier can be equipped with eight wheels and oscillating engine trucks, same as shown with Iowa Sling Carrier, Fig. 821, page 14. A small charge will be made for this change.

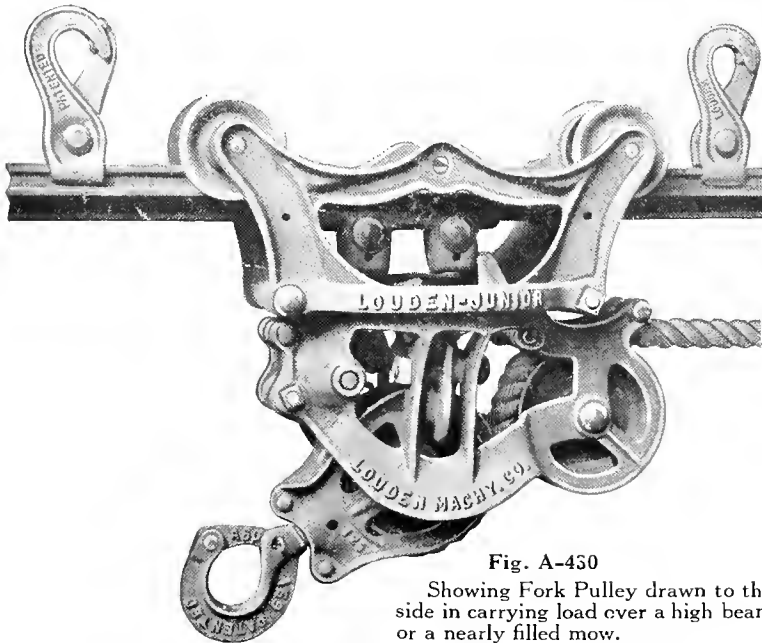
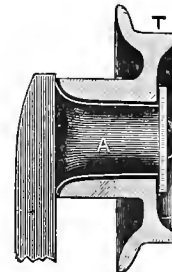
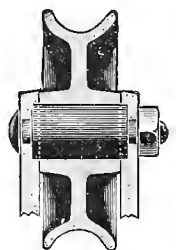

Fig. A-450

Showing Fork Pulley drawn to the side in carrying load over a high beam or a nearly filled mow.



Cut W



Cut B

Cut W, represents Louden's improved Track Wheel, having the web of the wheel directly under the tread T, which makes it strong and durable. It also shows the wheel axles, which are of solid malleable iron (more durable than steel) rounded out where it joins the carrier frame, so as to give it the greatest possible strength.

Cut B shows how the large rope wheels are protected by shields which makes it easy on the rope. The bearings are chilled and run on large malleable bushings recessed into the sides and bolted through. This feature is patented.



Louden Senior Hay Fork Carrier—Fig. 1100

Specifications

For use in any type or size of barn.

Built regularly to operate on Louden Double Bead Steel Track. (See pages 30 and 31 for Track and Track Fittings.)

Furnished regular with Rope Wheel for manilla rope.

Furnished on special order with Rope Wheel for wire draft rope.

Diameter of Rope Wheel in carrier and Fork pulley, 7 inches.

Rope Wheels are roller bearing.

Diameter of Track Wheels on treads 3 inches

Track wheels are not roller bearing.

Bearing surface on track (distance between front and rear axles), 15 inches.

Total length of carrier, 21 inches.

Carries fork within 20 inches of the track.

Frame of carrier of refined malleable iron.

Rope and Track Wheels special quality gray iron Safe working capacity, 1,500 pounds.

$\frac{3}{4}$ -inch best Manilla Rope is recommended.

Any size rope from $\frac{3}{4}$ -inch to 1 inch may be used.

One fork Pulley, 1 Trip Block, and two End Stop

Blocks are furnished with the carrier.

Weight, 34 pounds.

Price: \$5.33

Each year there are more and more large barns built, and each year there is an increasing demand and necessity for extra heavy hay-unloading outfits. Hay growers have been asking for a heavy fork carrier, a carrier that could be used for handling a hay fork in the usual way, and that could also be depended upon to handle extremely heavy loads when necessary. The needs and call for such a hay carrier led us to design and put on market the Senior Hay Fork Carrier.

This Carrier throughout is built strong and sturdy and in addition, its mechanism is simple and sure. It has the wide flaring mouth and the round-topped fork pulley that has been a distinctive feature of Louden Carriers for years. The fork pulley will never fail to register from whatever angle it may be drawn, and the grappling hooks take a deep, sure grip on the pulley.

The Louden Senior is a "Louden swivel" frame carrier and is equally efficient whether hay is taken up from the end of the barn or from a center driveway. When used in a barn having a center drive, when one end of the barn is filled the pulley at the end of the barn, through which the draft rope passes, is carried over and hung in place at the other end. When this is done a swinging jerk on the draft rope from the wagon or ground will reverse the carrier and it will be ready to work in the other end.

The Louden Senior has been tested in our factory under loads weighing 2,300 pounds. Operated vigorously under this load, the carrier showed no signs of weakness. We guarantee that it will handle a load weighing 1,500 lbs. continuously and with safety.

The bearing surface on the track—the distance from center to center between front and rear track wheels—is 15 inches. This wide bearing distributes the load along a greater surface, making it possible for the track to carry large loads without strain.

The Rope Wheels of the Senior carrier are roller bearing. This large wheel (7 inches in diameter), together with the roller bearing, 7-inch fork pulley, reduces friction to a minimum, and makes the hoisting of the load from wagon much easier than with an ordinary carrier.

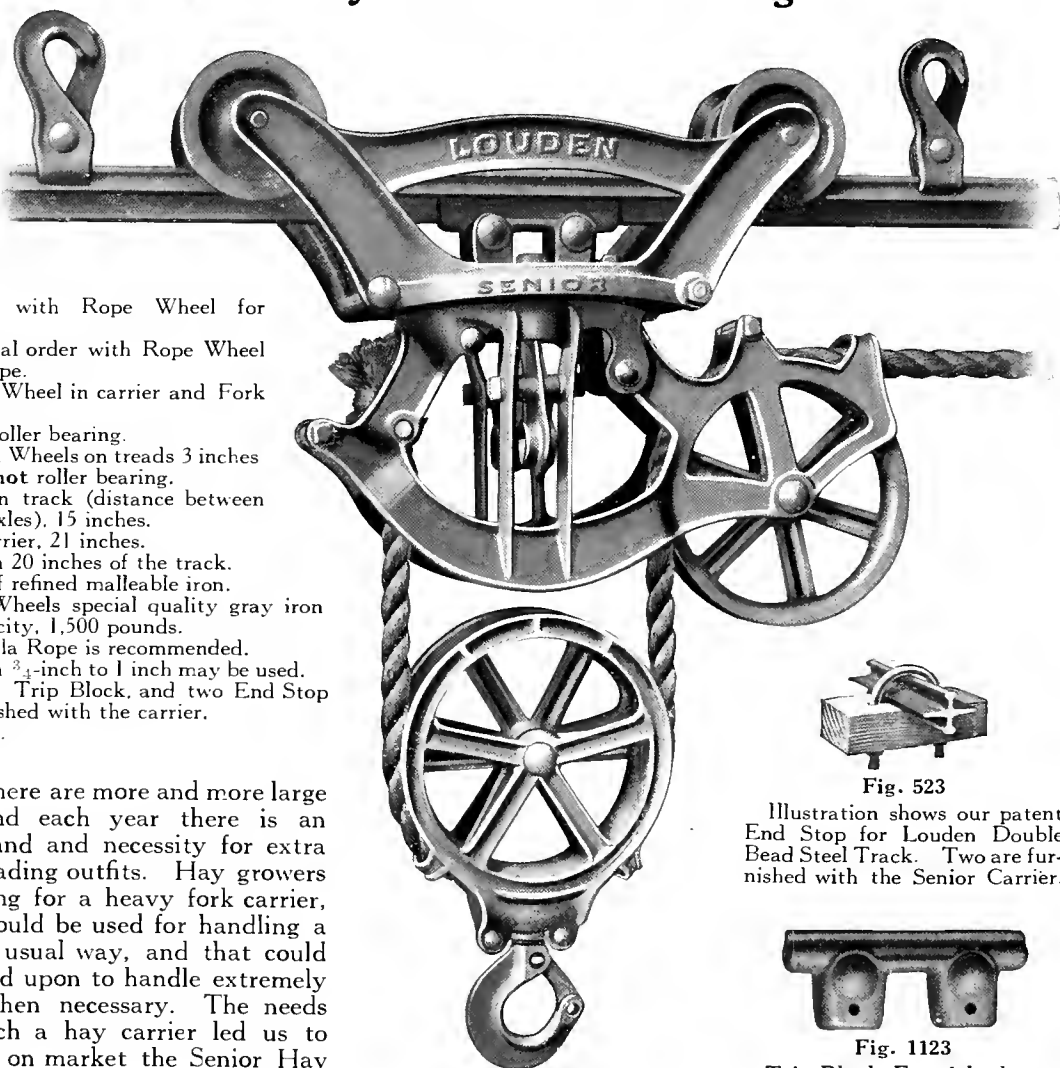

Fig. 1100

Fig. 523

Illustration shows our patent End Stop for Louden Double Bead Steel Track. Two are furnished with the Senior Carrier.

Fig. 1123

Trip Block Furnished as Part of Carrier



Louden Senior Hay Fork Carrier—Continued

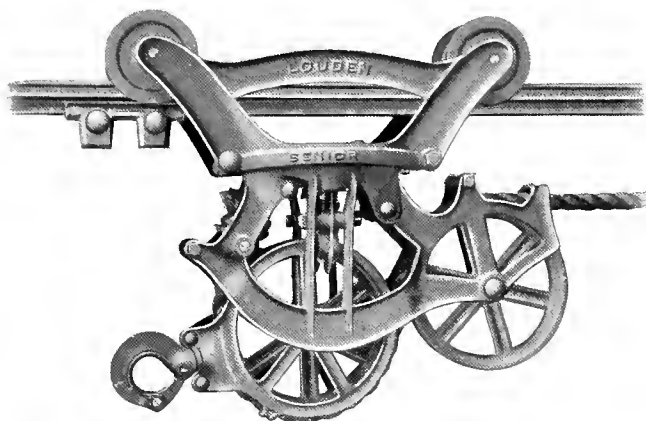

Showing Swinging Fork Pulley
 Loads can be dragged over beams or other obstructions
 without endangering carrier.

The Track Wheels are 3 inches in diameter on tread, are heavy and of great strength. They are not roller bearing, as it takes very little power to pull the carrier along the track compared with the power necessary to hoist the load. Too great an ease of propulsion would be a disadvantage through the tendency of the carrier to "run away" when leaving the trip block.

With the Louden Senior Track Carrier the barn can be filled clear to the track. There is no danger of breaking any part of the carrier, as the load can swing back directly behind carrier when necessary. This feature of the Swinging Fork Pulley also makes it easy to pull large forkfuls through small doors and over high beams without danger of breakage.

The round top of the Fork Pulley and the wide flaring mouth of the carrier is a big advantage in busy haytime. The wagon can be unloaded from any angle, not having to stand directly under the carrier, and the Fork Pulley will always register true. This feature, together with our patented rope swivel, which lets the kinks and twists run out of the rope while forkful is being hoisted, saves a world of time that is worth many dollars in haytime.

The rope swivel on this carrier is built into the carrier and is a big improvement over any rope swivel before offered. You simply pass the end of the rope through the swivel and tie a knot in the rope.

With a good, solid knot in the end of the rope, everything is sure to hold, and the swivel works free, permitting the twist to run out of the rope.

The Locking Dog has a new, distinctive feature, in that it is pivoted by means of a bolt. The Locking Dog may be easily taken out of the carrier without disturbing any of the other parts.

The Rope Wheel in the Fork pulley is 7 inches in diameter. The outer pulley casing is extra strong as it has four ribbed spokes and the outer circumference has two heavy ribs running parallel with each other. These, together with the cross ribs, make an exceedingly strong frame.

The carrier is built for use with any size of rope $\frac{3}{4}$ -inch to 1 inch. We recommend a $\frac{3}{4}$ -inch manilla rope as it is easier to handle, and costs less than a larger rope. Some users prefer, $\frac{1\frac{1}{8}}$, $\frac{7}{8}$, $\frac{1\frac{1}{4}}$, or 1 inch rope, and where a large rope is preferred the new carrier handles it perfectly.

Fig. 7 is an end view of the upper frame of all the Louden Swivel Carriers, showing the great strength. The sides carrying the wheels are joined together by two end pieces A. These end pieces have upwardly extending arms (as seen in cut), which are secured to the sides above while a bolt holds them together at the bottom, thus making the strongest possible frame, and at the same time saving space, as all the space taken up below the track is the thickness of the end pieces A.

The wheel arms are thoroughly braced and will never spread with a heavy load and let the carrier off the track.

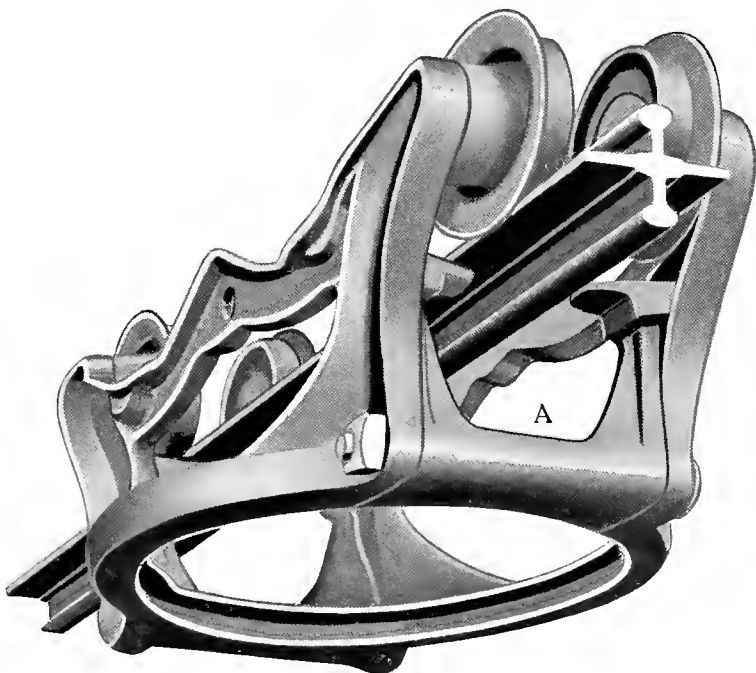

Fig. 7



Louden Standard Fork Carrier - Fig. 306

Specifications

For use in any type of barn. Especially desirable in barns where hay is unloaded at the end or is carried in one direction only. Built only to operate on Louden Single Bead Steel Track. Diameter of Rope Wheels, 4 inches. Diameter of Track Wheels on tread, $2\frac{1}{4}$ inches. Bearing surface on track (distance between rear and front axles) $10\frac{3}{4}$ inches. Total length of Carrier, $13\frac{1}{2}$ inches. Carries Fork within 10 inches of track. Frame of Carrier of refined malleable iron. Rope and Track Wheels special quality gray iron. Safe working capacity, 1,200 pounds. Three-Fourths inch best Manilla Rope is recommended; $\frac{1}{2}$ or $\frac{7}{8}$ inch rope can be used. One Fork Pulley, 1 Trip Block, 2 End Stop Blocks furnished with Carrier. Weight, 27 pounds. Price: \$4.33
 (See pages 30 and 31 for Track and Track Fittings.)

The Standard Carrier, Fig. 306, is our original Steel Track Fork Carrier. For many years this was our leading hay carrier. In many localities where this carrier is known it is still the popular hay carrier and is going into hundreds of barns every year. It is a carrier about which we never have a complaint. This is easily understood when the mechanism of the carrier is examined.

The frame of the carrier is compact and sturdy. The arms supporting the wheels are short and very strong. The grappling hooks which engage the fork pulley take a deep hold in the frame of the pulley and there is no chance for them to let go and allow the load to drop back.

With this carrier the fork is carried within 10 inches of the track. This feature is valuable when it comes to putting the last loads of hay in the mow or when taking the load through small doors or over high beams.

The lock is positive and holds the load securely. When leaving the trip there is no back-lash to make the carrier start with a jump and shake the hay loose.

This carrier has an adjustable stop which can be drawn up by a cord to let the carrier pass without unlocking. Several of these stops may be used on the same track and all can be drawn up out of the way except the one in use.

When leaving the factory the carrier is rigged as a one-way carrier for use where hay is carried in only one direction. By removing two small bolts in the carrier frame it is converted into a reversible carrier and can be reversed by pulling the draft rope through the carrier and hitching the horse to the opposite end.

The carrier has the wide flaring mouth and the round-top fork pulley—the big distinguishing feature found in all Louden Hay Carriers—and the pulley never fails to enter the carrier at the proper time.

Every part of the carrier has been built for service and wear and it can be depended upon to work right wherever put in service.

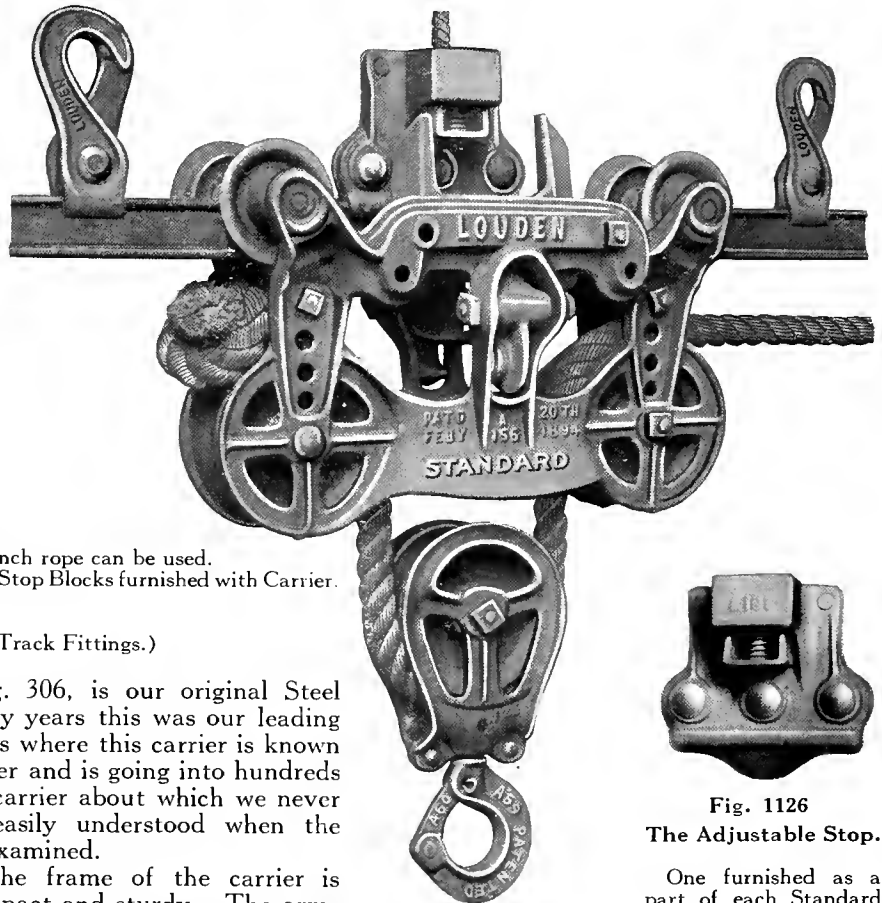

Fig. 306

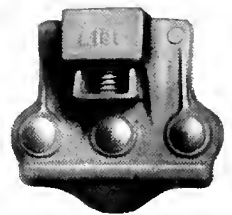

Fig. 1126
The Adjustable Stop.

One furnished as a part of each Standard Carrier.

Standard Carrier has an Adjustable Stop which can be drawn up by a cord to let the Carrier pass without unlocking. Several of these stops may be used on the same track and all can be drawn up out of the way, except the one in use.



Fig. 437 (Caddy)

Illustration shows our patent End Stop for Louden Single Bead Steel Track. Two are furnished with the Standard Carrier

taking the load through small doors or over high beams.

The lock is positive and holds the load securely. When leaving the trip there is no back-lash to make the carrier start with a jump and shake the hay loose.

This carrier has an adjustable stop which can be drawn up by a cord to let the carrier pass without unlocking. Several of these stops may be used on the same track and all can be drawn up out of the way except the one in use.

When leaving the factory the carrier is rigged as a one-way carrier for use where hay is carried in only one direction. By removing two small bolts in the carrier frame it is converted into a reversible carrier and can be reversed by pulling the draft rope through the carrier and hitching the horse to the opposite end.

The carrier has the wide flaring mouth and the round-top fork pulley—the big distinguishing feature found in all Louden Hay Carriers—and the pulley never fails to enter the carrier at the proper time.

Every part of the carrier has been built for service and wear and it can be depended upon to work right wherever put in service.



Louden Junior Hay Fork Carrier for Wood Track

Fig. 441

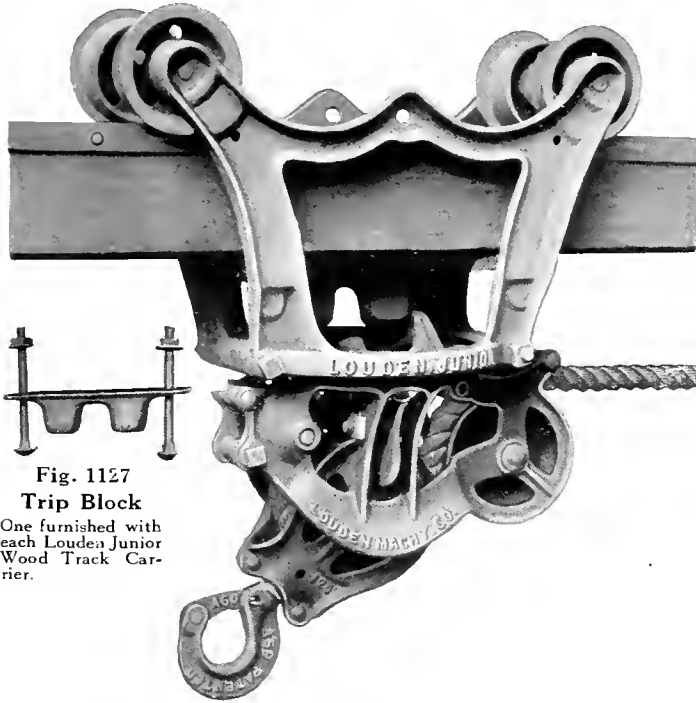

Fig. 441 (Capital)

Specifications

- Operates on 4x4 wood track.
- For use in any style of barn.
- Diameter of Rope Wheels 4 inches.
- Diameter of Track Wheel $3\frac{1}{4}$ inches.
- Bearing surface on track (distance between front and rear axles) $12\frac{3}{4}$ inches.
- Total length of carrier 16 inches.
- Carries fork within $13\frac{1}{2}$ inches of the track.
- Frame of carrier of refined malleable iron.
- Rope and Track Wheels special quality gray iron.
- Safe working capacity, 1,000 pounds.
- Three-fourths inch rope, best manilla is recommended.
- $\frac{13}{16}$ or $\frac{7}{8}$ inch rope can be used.
- One Fork Pulley, 1 Trip Block, 1 Rope Swivel furnished with Carrier.
- Weight, 28 pounds.
- Price: \$4.33

In the past 4x4 Wood Tracks for hay carriers were installed in a considerable number of barns. This was when wood was cheap and steel high in price. At the present time a wood hay track is rarely placed in a building. The steel tracks are as cheap as wood, they occupy less room and hay carriers work so much easier and smoother on the steel that it is a mistake to put wood track in a building.

Where track is already in the building or where for some special reason it is desired to use a Wood Track, no better carrier can be put into service than the Louden Junior Wood Track Carrier.

This carrier is built exactly like the Louden Junior Fork Carrier for steel track (Fig. 430, page 6), except it is built to operate on a 4x4 wood track instead of on steel track.

The carrier is suitable for use in any style of barn. Where hay is taken up at the end of building it works easily and smoothly as a One-Way Carrier. It is a Swivel Frame Carrier and in barns having a center driveway it is easily and quickly reversed to work on either side.

The carrier has the wide flaring mouth and the round top fork pulley of all Louden carriers. The fork pulley never fails to enter the carrier at the proper time. The wide flaring mouth of the carrier receives the pulley no matter from what angle the fork is drawn and regardless of swinging load or twisting ropes.

The grappling hooks in the carrier take a deep grip in the frame of the fork pulley. They grip the pulley securely, at the same time permitting the pulley to swing freely. This permits the mow to be filled clear up to the track without danger of breaking the pulley.

The frame of the carrier is of refined malleable iron built sturdy and strong to handle heavy loads. The members are clamped securely together with bolts; there is no possibility of the frame spreading or breaking under the strain of heavy loads.



Louden Carry-All Sling Carrier — Fig. 1103

Specifications

The heaviest and strongest Hay Sling Carrier made.

For use in any type or size of barn.

Built to operate on Louden Double Bead Steel Track.

Diameter of Rope Wheel in carrier, 10 inches.

Diameter of Rope Wheel in sling pulleys, 4 inches.

All Rope Wheels are roller bearing.

Diameter of Track Wheels on tread, 3 inches.

Track wheels are not roller bearing.

Bearing surface on track (distance between front and rear axles), 19½ inches.

Total length of carrier, 22½ inches.

Carries slings within 26 inches of the track.

Frame of carrier of refined malleable iron.

Rope and track wheels special quality gray iron.

Safe working capacity, 2,500 pounds.

Seven-eighths inch best manilla rope is recommended

Any size rope from ¾ inch to 1 inch can be used.

Two Sling Pulleys, 1 Trip Block, 2 End Stop Blocks furnished with each carrier.

Weight, 77 pounds.

Price: \$10.00

(See pages 30 and 31 for Track and Track Fittings.)

The Carry-All Hay Sling Carrier, as its name implies, was built to carry big loads of all kinds of hay. The importance of the hay crop and its increasing value from year to year is resulting in a larger acreage and more tons of hay in all the hay-growing regions. The necessity of being prepared to handle the hay with speed and safety when the weather is right and the hay is right has developed the need for heavier equipment.

In many of the heavy hay-growing sections farmers are building larger barns and with roof construction strong enough to permit an entire wagon load of hay to be handled at a single lift. With a desire to furnish a carrier that would do this work in the big hay barns and at the same time be suitable for use in the ordinary farm barn we designed the Carry-All Sling Carrier.

This carrier has been tested under loads weighing 3,200 pounds. It has been tried with horse power, engine power, and electric power. It has been tried out in barns of all sizes and under all kinds of conditions.

It is already making good in hundreds of barns and in every test the carrier proved its efficiency, its strength, and its perfect working mechanism.

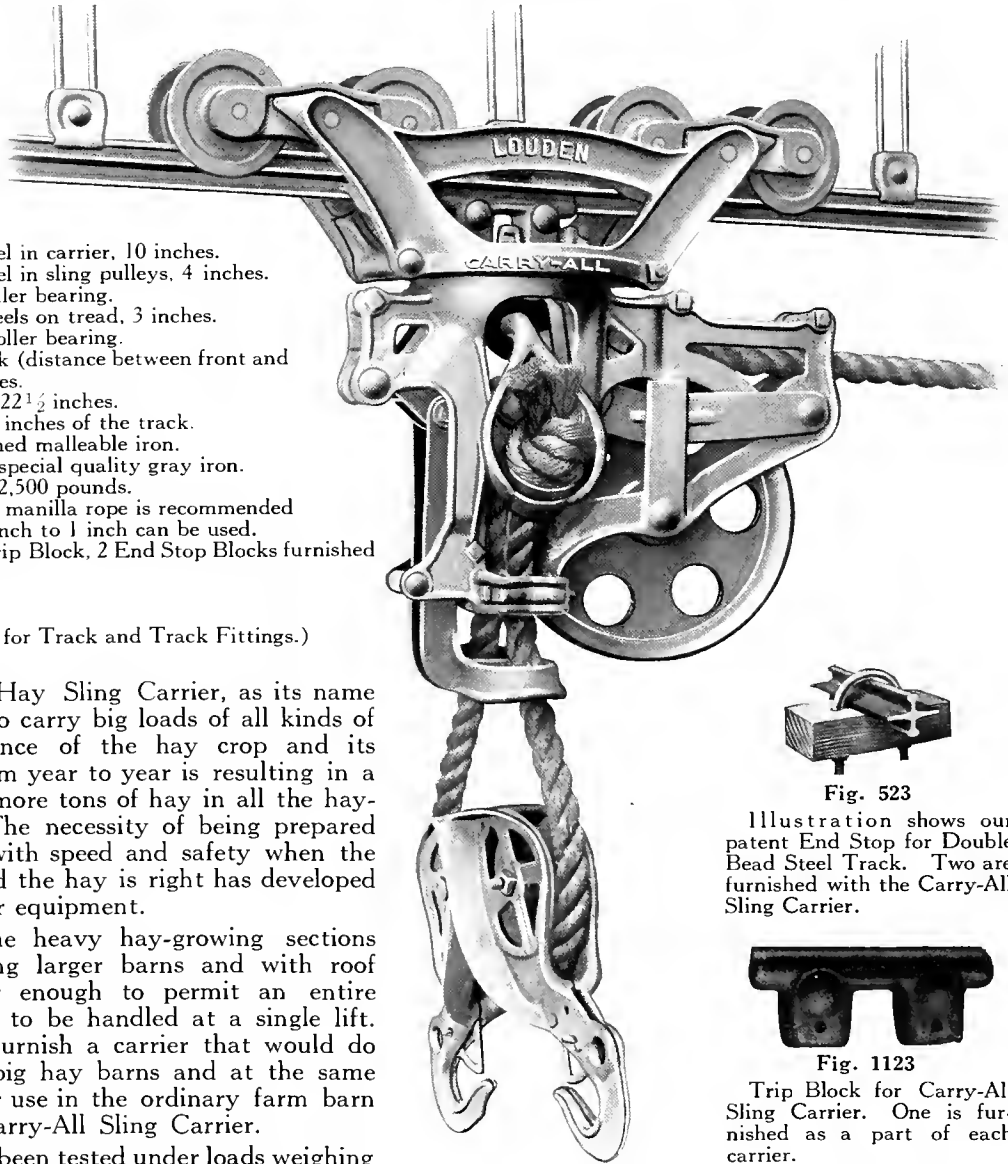

Fig. 1103 (Heavy)

Fig. 523

Illustration shows our patent End Stop for Double Bead Steel Track. Two are furnished with the Carry-All Sling Carrier.

Fig. 1123

Trip Block for Carry-All Sling Carrier. One is furnished as a part of each carrier.

Non-Wear Rope Lock

The Rope Lock in this carrier is positive and sure. There is no chance for the rope to slip. The lock will not wear the rope as it grips it evenly. The Rope Lock castings have a bearing of 9 inches on the rope. They conform to the diameter of the Rope Wheel and when the Rope Lock goes into action engaging the rope for a distance of 9 inches and bending it around the outside of the Rope Wheel the rope cannot slip. Handling a dead weight (steel pipe) of 3,200 pounds the rope did not slip the fraction of an inch.

The end of the draft rope is knotted into the cup-shaped rope swivel which rests in the fulcrum lever. The fulcrum lever exerts a direct pressure on the rope lock. When carrying a load the weight of the load is held on top of the rope lock. The heavier the load the more securely does the lock hold.



Non-Wear Rope Lock—Continued

The work of the Rope Lock is supplemented by a ratchet lock on the Rope Wheel. When the Rope Lock goes into action the ratchet lever drops into place and prevents the Rope Wheel from turning backward. This aids the Rope Lock and prevents wear on the rope.

Ten-Inch Roller-Bearing Rope Wheel

The Rope Wheel in the Carry-All Carrier is 10 inches in diameter and is roller bearing. This is the largest Rope Wheel used in any hay carrier and is an important improvement. The large roller-bearing wheel reduces friction and makes it possible to lift heavier loads with less power. Also the empty sling can be brought back to the wagon with less effort and pulling on the ropes than any other sling carrier.

The frame of the carrier is of the Louden Swivel Type. The same principle is used in the swivel as in use on all our swivel carriers. (See Fig. 7, page 9.) It will work with equal satisfaction and efficiency in barns having a center driveway or where hay is taken up at one end. In center-drive barns the change from one end to the other is easily and quickly made. The pulley in one end of the barn is changed over to the other end; the carrier can then be swiveled around from the barn floor. No climbing up to the carrier necessary.

The track wheels are 3 inches in diameter on tread and are heavy and of great strength. There are eight track wheels on each carrier working on oscillating "engine trucks". This distributes the load evenly on the track and insures that every wheel is going to run true and carry its share of the load.

The sling pulleys carry the load at right angles to the track. This is important as the hay is delivered into the mow just as it comes from the wagon. When the hay is dropped it spreads out broadly at right angles to the track, requiring less labor and time to mow it back.

The locking dog in the carrier has a square catch which engages the trip block bolted to the track. The carrier is held positively on the trip while the load is being elevated. When the load is pulled up and the sling pulleys strike the trip stirrup the carrier automatically releases from the trip, the rope lock is thrown into action holding the load so it cannot slip back. When the carrier leaves the trip it runs easily and steadily and after the hay is dropped in the mow the carrier is returned to the trip block with scarcely an effort. (We recommend using a weight return for returning the empty carrier. See Fig. 529, page 15.)

The Louden Carry-All Hay Sling Carrier, the Louden Carry-All Hay Sling (see Fig. 984, page 36), and a Louden Power Hoist (page 21), make the best hay-unloading outfit ever offered for handling big loads of hay.

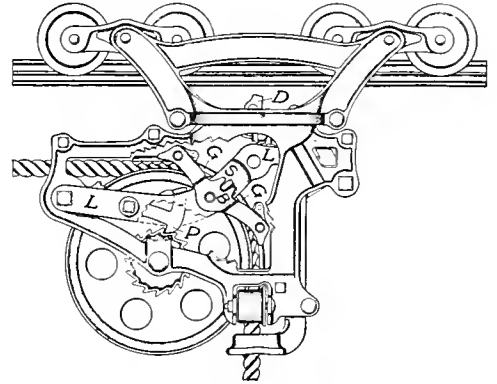

Cross Section View and Description of Locking Mechanism in Carry-All Hay Sling Carrier.

A portion of the frame is broken away to show the arrangement of the grip to hold the hoisting rope and prevent the sling load from dropping down while the carrier is running along the track.

The main things are the Flexible Twin Rope Grips G, which are centrally pivoted to opposite ends of a Rocking Bar B, which, in turn, is pivoted to Lock Lever L (lettered near each end). The rear end of this lever is pivoted to the rear end of the carrier frame and its front end is connected to the Locking Dog D. This dog is only partly shown and its lower end, which is forked and is pivoted to opposite sides of the carrier frame about opposite the Bar B, has its forked ends broken away to show the pivot arrangement of this bar. The Stop S prevents the bar from rocking too much.

When the carrier is latched to the stop on the track the front, or upper end, of the Lever L is raised, which in turn lifts the rocking Bar B, carrying the Twin Rope Grips G away from the rope to let the empty sling descend to the load. When the carrier is tripped or unlatched from the stop on the track the tilting of the Locking Dog D lets the upper end of the Lever L drop, and this lets the grips down on the rope. The weight of the load on the rope has a tendency to draw the rope wheel back which tightens the grip on the rope. The wheel, however, cannot move back enough to let the load drop on account of the grip on the rope and also the pawl and ratchet.

The advantages of this grip are that it is double and nearly twice as long as any other rope grip in use, which makes it easier on the rope. It is also doubly pivoted so that no matter what the size of the rope, or how uneven it may be, from wear or otherwise, it will always bear fully and evenly on all parts of the rope, instead of pinching at one point and being loose at another. This insures a firm grip on the rope and also that no part of the rope will be subject to any severe pinching which would wear it.



Louden Iowa Sling Carrier -- Fig. 821

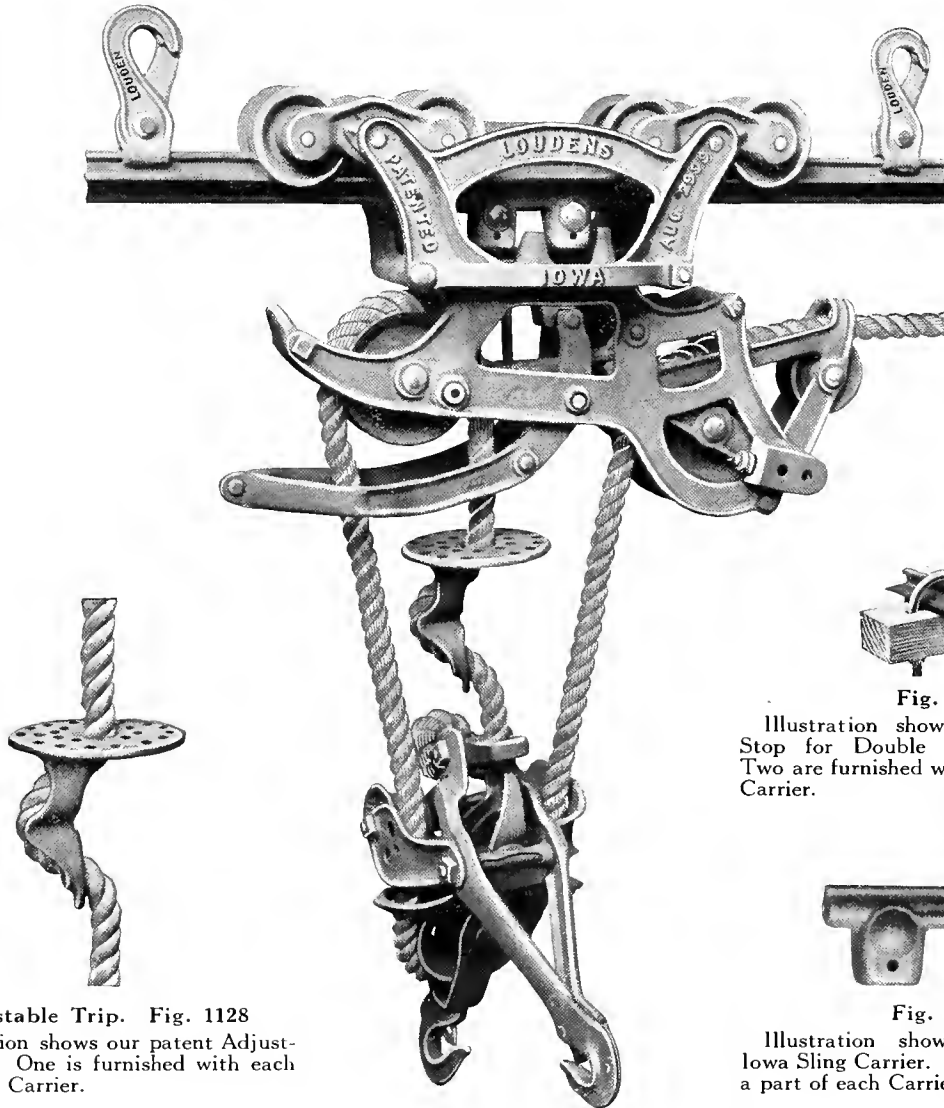

Adjustable Trip. Fig. 1128
 Illustration shows our patent Adjustable Trip. One is furnished with each Iowa Sling Carrier.



Fig. 523
 Illustration shows our patent End Stop for Double Bead Steel Track. Two are furnished with each Iowa Sling Carrier.



Fig. 1123
 Illustration shows Trip Block for Iowa Sling Carrier. One is furnished as a part of each Carrier.

Fig. 821 (Chariot) Specifications

For use in any style of barn.
 Built to operate on Loudens Double Bead Steel Track.
 Diameter of Rope Wheels in carrier and sling pulleys, 4 inches.
 Diameter of Track Wheels on tread, $2\frac{1}{4}$ inches.
 Bearing surface on track (distance between front and rear axles), $14\frac{1}{2}$ inches.
 Total length of carrier, $19\frac{1}{2}$ inches.
 Carries slings within 26 inches of track.
 Frame of carrier refined malleable iron.
 Rope and Track Wheels special quality gray iron.
 Safe working capacity, 2,000 pounds.

Rope Lock is adjustable to different size ropes.
 Three-quarter inch best manilla rope is recommended.
 Illustration shows carrier with Right-angle Sling Pulleys which we recommend.
 Parallel Sling Pulleys (Fig. 649, page 42) may be used if preferred.
 Two Sling Pulleys, 1 Trip Block, 1 Trip Adjuster, and 2 End Stop Blocks are furnished with each carrier.
 Weight, 47 pounds.
 Price: \$8.67
 (See pages 30 and 31 for Track and Track Fittings.)



Louden Iowa Sling Carrier Continued

For simplicity of design and mechanism and for positive, dependable action the Iowa Sling Carrier ranks with the foremost. It was designed for heavy, everyday work in the hay barn. It has gone through a dozen or more hay harvests; is doing satisfactory service in thousands of barns, and is pleasing its users.

The carrier is of the Louden swivel frame type. It can be used with perfect success in any type of barn and is particularly well adapted for use in barns having a center driveway. In center drive barns the carrier can be changed from one side to the other in a minute's time and without climbing up to the carrier or pulling the ropes through. The pulley in the end of the barn is changed from one end to the other and the carrier frame swiveled around on the stop from the barn floor by a swinging pull on the ropes.

The frame of the carrier is of refined malleable iron. Heavy strengthening webs are used where strength is necessary. At all points where heaviest strain is exerted castings are reinforced to give needed strength. The mechanism of the carrier (the rope lock and the latching dogs and parts) is extremely simple. There is nothing to get out of order and the parts are all easily accessible.

There are eight track wheels on each carrier operating on oscillating "engine trucks." This distributes the weight of the load evenly on the track and insures that every wheel will do its full share of the work. The wheels are bored smooth and true and turn on $\frac{3}{4}$ -inch milled axles and will not bind or run hard.

The rope lock has a long bearing surface on the rope. When the carrier is tripped the rope lock instantly grips the rope and holds it firmly. There is no slipping, nor wear on the rope. The rope lock is adjustable to different size ropes.

Each carrier is provided with an adjustable trip. This trip is placed on the draft rope (see illustration) and is adjustable to different heights. By this means the carrier may be released and the load carried into the mow at any height. Unless, on account of beams or hay already in the mow, it is not necessary to lift the load clear up to the track.

In operation, when the sling pulleys or the adjustable trip strikes the release lever, the locking device drops down and the carrier moves away from the stop smoothly and steadily. In the same operation the rope lock is thrown on and holds the load until the sling is tripped. When the carrier is brought back to the stop the rope lock is released and the weight of the pulleys and sling brings them down to the wagon.

Hay forks may be used with this carrier by using the fork clevis described on page 39, Fig. 653.

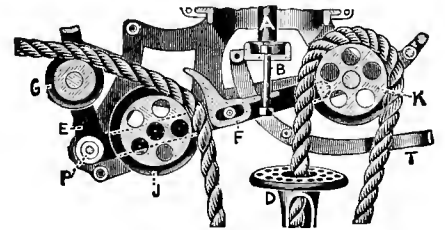
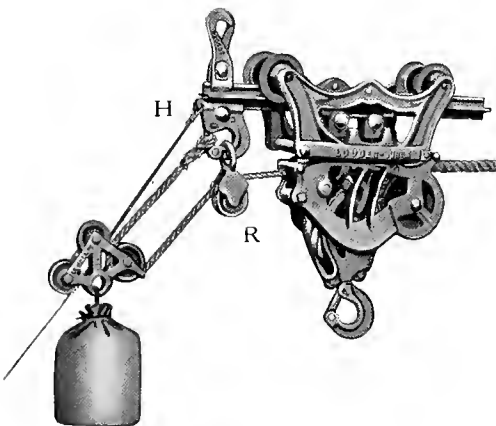

Fig. 528

Fig. 528 is a sectional view showing the locking mechanism in the Iowa Sling Carrier and also how the carrier is threaded. Pulleys G and J are mounted on Tilting Frame E pivoted at P. The Brake F is pivotly connected with the tilting frame, forming a knee joint, which grips the rope between the Brake F and Pulley J when the carrier is tripped. Brake F is held free from the rope while the load is being elevated by Bolt B attached to Locking Dog A, which operates with the track stop.

Louden Weight Return



Specifications

Weight, 3 pounds.
 Price: \$1.00

A Weight Return for returning the carrier to the trip block after the load has been deposited in the mow is desirable with all hay carriers, especially so in long or high barns.

The Weight Return brings the carrier back to the trip block promptly, and always with enough force to securely latch the carrier.

Fig. 529 shows End Weight Return attached to carrier and arranged for End Hoist barn. It shows our improved Return Pulley R on wire guy, Clamp Hook H and Pulley P. A wire guy is preferable to a rope guy.

In ordering, state kind of track used to get Hook H to fit it. A bag of sand is the best weight to use.

Fig. 529. Weight 3 pounds. Price \$1.00



Louden Automatic Hay Sling Carrier

Fig. 514

Specifications

For use in any style of barn.
 Operates on Louden Single-Bead Steel Track.
 Diameter of Rope Wheels in carrier, 4 inches.
 Diameter of Track Wheels on tread, 2 1/4 inches.
 Bearing surface on track (distance between front and rear axles) 14 1/2 inches.
 Total length of Carrier, 19 1/2 inches.
 Carries Slings within 26 inches of the track
 Frame of Carrier of refined malleable iron.
 Rope and Track Wheels special quality gray iron.
 Safe working capacity, 2000 pounds.
 Three-fourths inch best manilla rope is recommended.
 Illustration shows carrier with Right Angle Sling Pulleys.
 Parallel Sling Pulleys (Fig. 649, page 42) can be used if preferred.
 Two Sling Pulleys, 1 trip block, 1 trip adjuster, and 2 end stop blocks furnished with each carrier.
 Weight, 48 pounds.
 Price: \$8.67

The Automatic Sling Carrier is of the Louden Swivel Frame type. It can be used with perfect success either in barns having a center driveway or where hay is taken up at one end. In center drive barns the carrier can be changed from one end to the other in a minute's time and without climbing up to the carrier or pulling the ropes through, by swiveling the carrier and pulling a rope that has been placed in the center of the trip block and a pulley directly above trip block.

The frame of the carrier is of refined malleable iron. Heavy strengthening webs reinforce the heavy castings at all points where there is the heaviest strain.

There are eight track wheels on each carrier operating on oscillating engine trucks. This distributes the weight of the load evenly on the track and insures that every wheel will carry its share of the load. The wheels are bored out true and smooth and turn on 3/4-inch milled axles and will not bind or run hard.

The rope lock has a long bearing surface on the rope. When the carrier is tripped the rope lock instantly grips the rope and holds it firmly. There is no slipping and no wear on the rope. The rope lock is adjustable to different size ropes.

Each carrier is provided with an adjustable trip. This trip is placed on the draft rope (see illustration) and is adjustable to different heights. By this means the carrier may be released and the load carried into the mow at any height. Unless beams or hay already in the mow is in the way it is not necessary to lift the load clear up to the track.

In operation when the sling pulleys or the adjustable trip strikes the release lever, the locking device drops down and the carrier moves away from the stop smoothly and steadily. In the same operation the rope lock is thrown on and holds the load until the sling is tripped. When the carrier is brought back to the stop, the rope lock is released and the weight of the pulleys and sling brings them down to the wagon.

Hay forks may be used with this Carrier by using the Fork Clevis described on page 39, Fig. 653.

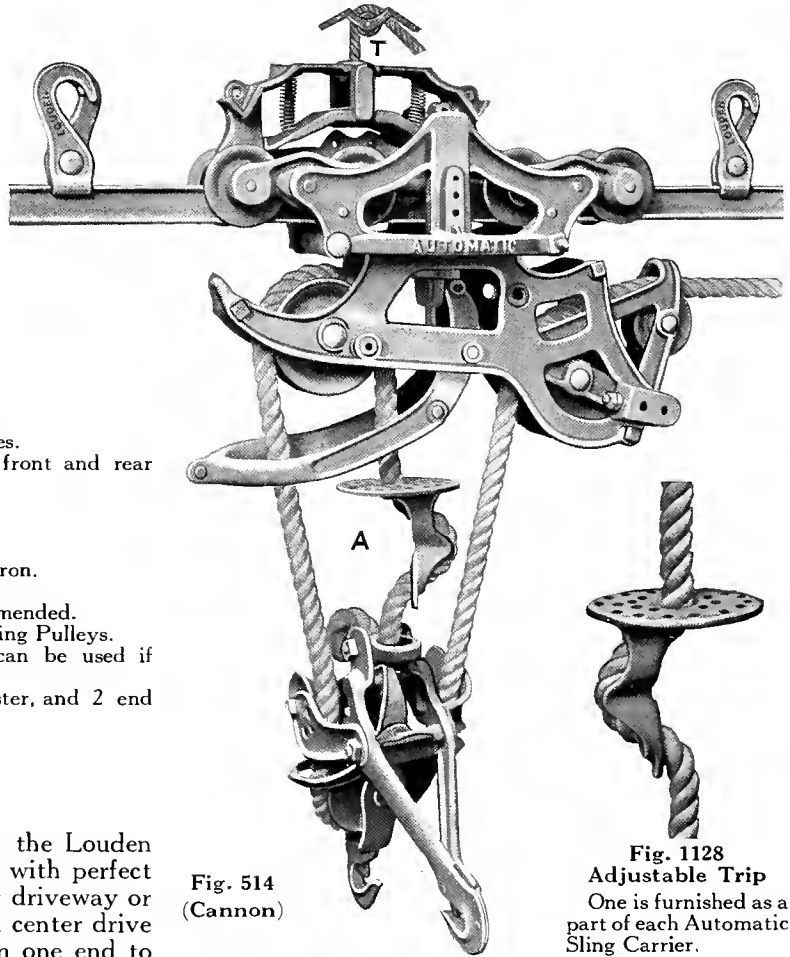

Fig. 514
(Cannon)



Fig. 1128
Adjustable Trip
One is furnished as a part of each Automatic Sling Carrier.



Fig. 437
End Stop Block
Two are furnished with each Automatic Carrier.

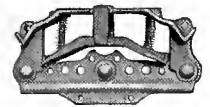

Fig. 1128
Adjustable Trip Block
One is furnished as a part of each Automatic Sling Carrier.



Louden Reversible Sling Carrier—Fig. 315 (For Wood Track)

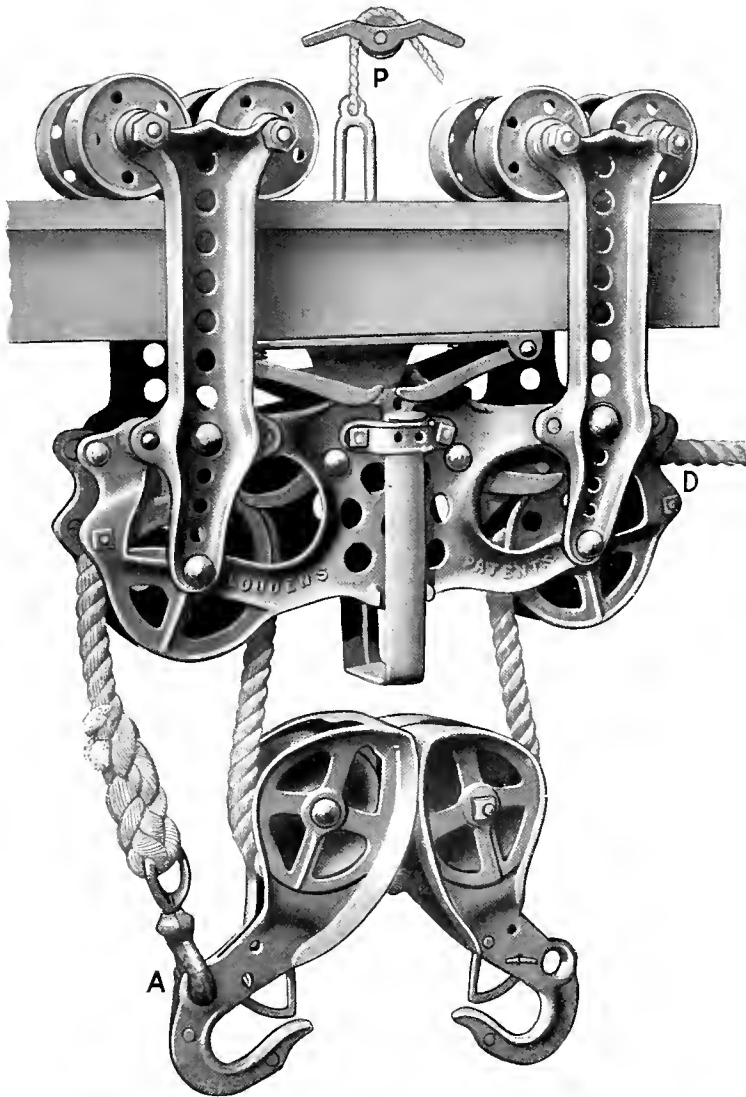

Fig. 315

Specifications

Operates on 4x4 wood track.
 For use in any style of barn.
 Diameter of Rope Wheels, $4\frac{5}{8}$ inches.
 Diameter of Track Wheels, 3 inches.
 Bearing surface on track (distance between front and rear axles), 15 inches.
 Total length of Carrier, 18 inches.
 Carries slings within 19 inches of the track.
 Frame of Carrier refined malleable iron.
 Rope and Track Wheels special quality gray iron.
 Safe working capacity, 2,000 pounds.
 Three-fourths inch best Manilla Rope is recommended.
 One pair Sling Pulleys, 1 Trip Block, 1 Rope Hook, 1 Comb Pulley,
 1 Lift Link furnished with Carrier.
 Weight, 52 pounds.
 Price: \$8.67

The Reversible Sling Carrier is a strong, dependable carrier built to operate on 4x4 wood track. In the illustration the carrier is shown with parallel sling pulleys rigged triple draft. The carrier can be used double draft if preferred.

The mechanism of the carrier is very simple and compact. There is a double rope lock, each lock having a long bearing surface on the rope. When the load is elevated, and the sling pulleys strike the trip stirrup, the rope locks go into action holding the load secure. There is no chance for the load to slip back and wear on the rope is reduced to a minimum.

The Carrier is fitted with eight track wheels. The wheel arms are heavy and strong and will not spread under the weight of heavy loads.

The Trip Blocks are adjustable. Two or more trips can be used on the same track and as many of them as desired can be lifted up to allow the carrier to pass through. The frame of the carrier is of the straight reversible (not swivel) type. To reverse the carrier for work in the opposite mow, the draft rope is pulled through the carrier. The end of the rope at D is carried through pulley at end of barn and from there, on down to the horse or team. The other end of the rope is fastened in the eye, A, in the sling pulley.

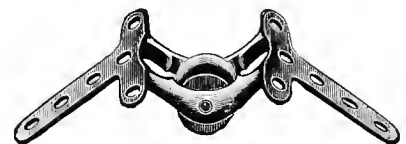

Fig. 435 (Perch)

One Comb Pulley Furnished with Each Reversible Wood Track Carrier.



Fig. 383 (Excelsior)
 One Rope Hook Furnished with Each Reversible Wood Track Carrier.

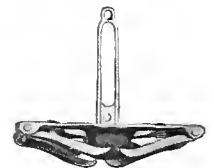

Fig. 1130
 One Trip Block Furnished with Each Reversible Wood Track Carrier.



Louden Cross Draft Hay Carrier Fig. 817

(For Sling or Fork)

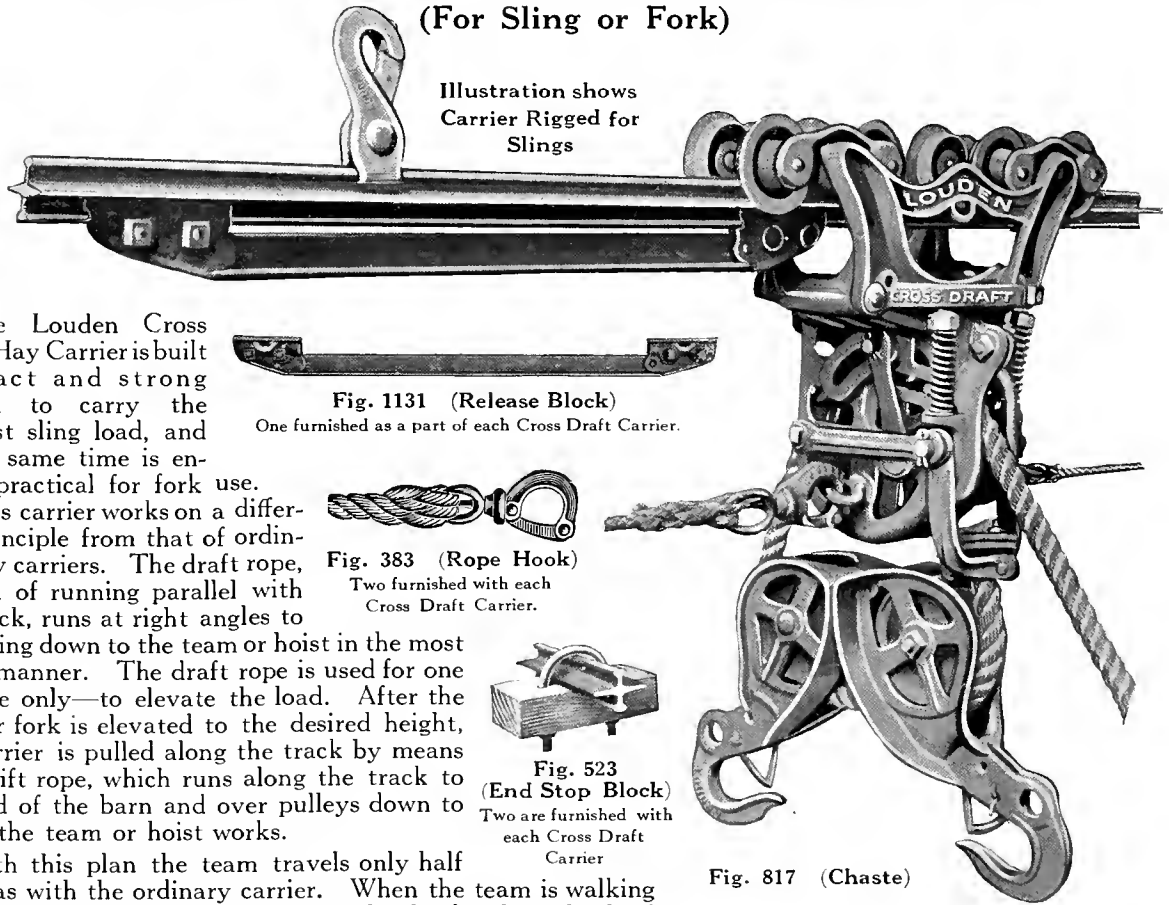

Illustration shows
Carrier Rigged for
Slings

The Louden Cross Draft Hay Carrier is built compact and strong enough to carry the heaviest sling load, and at the same time is entirely practical for fork use.

This carrier works on a different principle from that of ordinary hay carriers. The draft rope, instead of running parallel with the track, runs at right angles to it, passing down to the team or hoist in the most direct manner. The draft rope is used for one purpose only—to elevate the load. After the sling or fork is elevated to the desired height, the carrier is pulled along the track by means of a shift rope, which runs along the track to the end of the barn and over pulleys down to where the team or hoist works.

With this plan the team travels only half as far as with the ordinary carrier. When the team is walking out from the barn, it is hoisting the load; when the load reaches the proper height, the shift rope is hooked to the team and as the return to the barn is made the carrier is pulled along the track into the mow. As there is a shift rope on each side of the carrier, one is always ready to use to return the empty carrier, no matter into which mow the hay has been carried.

For handling slings the carrier should be rigged with sling pulleys, as shown in the illustration. For fork use the sling pulleys would be replaced with the Louden Fork Pulley (See Fig. 366, page 45). If a Louden Fork Pulley is not at hand, any common pulley can be used.

The carrier is provided with an automatic lock. This lock will hold the hay suspended at any height. When the load is elevated high enough to pass into the mow, the team is stopped and turned back toward the barn. The end of the idle shift rope is attached to the singletree and as the team returns to the starting place, the carrier is drawn along the track to the end of the barn.

The Cross Draft Carrier has many advantages over ordinary carriers. The draft is more direct, it requires about one-half less draft rope and as it passes over only one large sheave in the Carrier there is less friction, thus requiring less power to elevate the load. The horse has to walk only about half as far and gets back quicker, thus saving time and also space in

Fig. 1131 (Release Block)
One furnished as a part of each Cross Draft Carrier.



Fig. 383 (Rope Hook)
Two furnished with each Cross Draft Carrier.



Fig. 523 (End Stop Block)
Two are furnished with each Cross Draft Carrier

Fig. 817 (Chaste)

Specifications

Recommended for use in barns where hay is elevated from a center driveway
 Built to handle hay slings, but will handle hay fork with equal satisfaction.
 Operates on Louden Double Bead Steel Track.
 Diameter of the Rope Wheel in carrier, 6 inches.
 Diameter of the Rope Wheels in sling pulley or fork pulley, 4 inches.
 Diameter of Track Wheels on tread, 3 inches.
 Bearing surface on track (distance between front and rear axles), 16 inches.
 Total length of Carrier, 21 inches.
 Carries slings or fork within 21 inches of the track.
 Frame of the carrier of refined malleable iron.
 Rope and track wheels special quality gray iron.
 Safe working capacity, 2,000 pounds.
 $\frac{3}{4}$ -inch best Manilla Rope is recommended, and urged for use with this carrier.
 $\frac{1}{2}$ -inch rope can be used, but $\frac{3}{4}$ -inch is better.
 Two Sling Pulleys, 1 Release Block, 1 3-Part Rope Hitch, 2 Swivel Rope Hooks, 2 End Stop Blocks, furnished with each carrier. Unless otherwise specified sling pulleys will be furnished with the carrier.
 If Hay Fork is to be used, fork pulley (Fig. 366, page 45) will be furnished instead of sling pulleys.
 Weight for sling use, 49 pounds.
 Weight for fork use, 42 pounds.
 Price: \$8.67, with sling pulleys
 Price: \$7.67, with fork pulley



Louden Cross Draft Hay Carrier—Continued

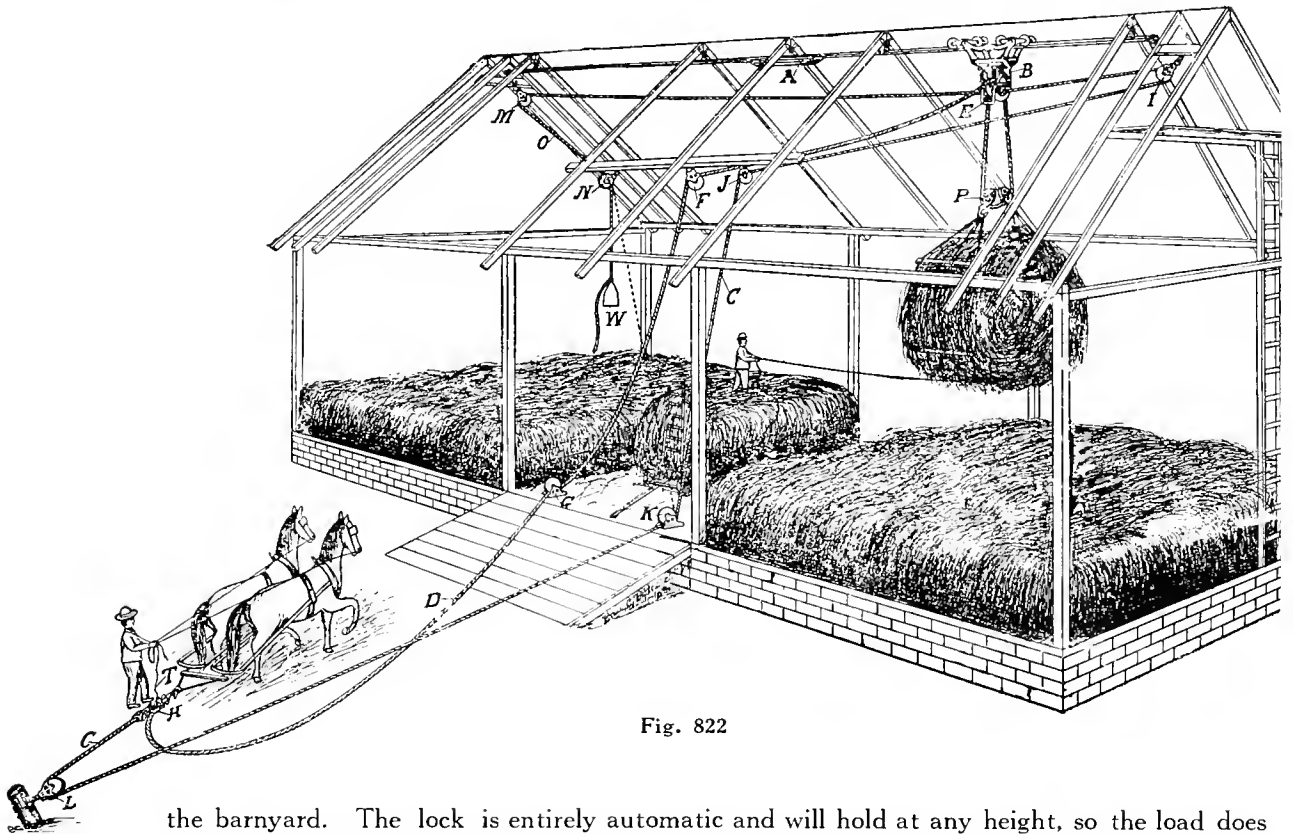

Fig. 822

the barnyard. The lock is entirely automatic and will hold at any height, so the load does not have to be elevated any higher than is necessary to let it pass into the mow. The empty Sling comes down easier and quicker than with ordinary sling carriers. It does not start into the mow with a jerk and cause loose hay to shake off, but goes in smoothly and steadily.

Cross Draft Carrier in Center Hoist Barn

Fig. 822 shows our Cross Draft Carrier at work in a center hoist barn. The sling load has been elevated by the Draft Rope D until it is high enough to pass into the mow, **the automatic lock in the carrier holding it at any desired height.** The Shift Rope C has been connected to the trip of the Rope Hook H, the horses have been turned back toward the barn and the Sling load is being drawn into the right-hand end of the barn and the operator is **ready to trip it** when it reaches the proper place. The draft rope is first secured to the Spring Clevis E of the Carrier B by means of **our patent swivel**, then passed down through the Sling Pulleys P, then up through the carrier and on through the Draft Pulleys F and G and is connected to the Rope Hook H. The Shift Rope C is fastened to one of the **swivel eyes on the carrier**, and is then passed through the Shift Pulleys I, J, K, and L.

In elevating the hay the team is driven from the Pulley G to or past the Pulley L, as may be required by the distance the hay is to be elevated, and in turning back, the shift rope is connected to the trip of the Rope Hook H which **draws the carrier with its load into the mow** as the team is driven to the barn. The shift rope is then tripped from the rope hook by means of the Trip Cord T, the carrier is drawn back to the Release Block A, by the Weight W, **when the empty sling will descend of its own gravity and when unhooked from the Pulleys P everything will be ready for another load.**

The instant the horses stop, or if a singletree or anything else should break, **the lock takes the weight of the load** and holds it securely without a particle of slipping. While loaded, the lock is **always in position** to hold the load at any point of elevation. The rope is **entirely free** to run forward but not backward, but when unloaded it is free to run **in both directions** unless held in locked position by the lock-latch when away from Release Block A to prevent the empty fork or sling from dropping down in the mow.

The carrier will work without the Release Block A by removing the lock-latch, but it works much better with it, as by this means **the empty sling or fork can not drop down in the mow.** This is a fault



Cross Draft Carrier in Center Hoist—Continued

that all other cross draft carriers have and we have entirely overcome it by the use of this lock-latch in the carrier and the Release Block A on the track. The carrier does not have to stand **over the release block** in elevating the load, notwithstanding this is its usual position. It may stand on either side or be drawn across it, **without any effect when loaded**, but it will **always release the lock when the carrier is empty**. In this way the empty fork or sling is prevented from dropping down in the mow, while the lock will **always be released** to permit them to descend at the proper place.

The stake to which Pulley L is fastened should be set far enough out in the yard to permit the team, after turning back, to draw the carrier **to the end of the mow** before getting too close to the Pulley G, and there should be 10 feet extra to connect the shift rope easily and quickly to the trip of the Hook H. The longer the barn, the **farther away** the Pulley L must be set.

To take the hay into the other end of the barn, remove the Weight W from the Shift Rope O which is connected to the swivel eye on the other side of the carrier and is passed through the Shift Pulleys M and N. **Withdraw the Shift Rope C** from the Pulleys K and L and attach to it the Weight W. Now run the Shift Rope O through the Pulley K (as shown by dotted line) and then through the Pulley L, and you are **ready for business** in the other end of the barn. It may be better to use a **separate rope** out in the barn yard, which may be done by using a hitch similar to A, Fig. 819. When this is done the Shift Ropes C and O will only have to be long enough to pass through the Pulley K.

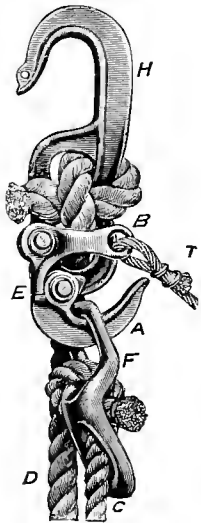

Fig. 819

Louden's Cross Draft Rope Hook

Fig. 819 represents our Cross Draft Rope Hook, which is an important part of the outfit, for upon its **convenience and quickness** of operation considerable depends. The Draft Rope D is secured, as shown, to the **main part of the Hook H**, while the Shift Rope C is fastened to the Hitch F, which in turn is hooked **in the Trip Hook A**. This is held in place and tripped by the Latch E, having an Eye B to which the Trip Cord T is connected. The shift rope is much more **easily and quickly connected to** and tripped from our rope hook than the devices used with other cross draft carriers.

When the hay reaches **the proper height** to pass into the mow, the team is turned back toward the barn and the Hitch F is **readily and quickly** slipped over the Trip Hook A; and when the hay has reached **the point of deposit** in the mow, a **slight pull** on the trip cord will disengage the Latch E, and release the Shift Rope C. In this way the hay **will not be drawn beyond** the proper place and **frequently** the hay will be discharged, the carrier returned and the empty sling or fork brought down to the load by the time **the team gets back to the barn**.

Louden's Cross Draft Hay Carrier

Outfit for 60-foot barn, 40-foot peak

	Fig.	Page	Unit Price	Total
1 Cross Draft Carrier	817	18	\$8.67 each	\$8.67
54 feet of Double Bead Steel Track	571	30	.12 per foot	6.48
7 High-Grade Draft Pulleys.....	468	43	3.67 per doz.	2.14
1 Upright Floor Pulley.....	364	44	6.67 per doz.	.56
30 Steel Track Hangers.....	498	30	1.00 per doz.	2.50
30 Rafter Brackets.....	424	31	.48 per doz.	1.20
5 Rafter Pulley Hooks.....	390	46	.80 per doz.	.33
1 Floor Pulley Hook.....	389	46	.93 per doz.	.08
2 Hoisting Singletrees	344	47	1.00 each	2.00
1 Rope Spreader Attachment.....	345	47	.67 each	.67
Total.....				\$24.63

Three slings are generally used, but in place of these, one sling and two harpoon forks or one grapple fork may be used.

To get correct length of draft rope, multiply distance from floor to peak of barn by 3 and add 20 feet. To get right amount of shift rope multiply length of barn by 2; also distance from floor to peak by 2 and add 20 feet. If extra rope is used out in yard make this the length of longest mow, with half the width of driveway added. If not, add this length to total length of shift rope.

Five-eighths is best for the shift rope. Three-quarters will answer, but is more expensive and being heavier makes the carrier harder to draw back. To get correct length of trip cord, take length of longest mow and add 25 feet. Set post for Pulley L out 10 feet further than half length of barn.



Louden Power Hoist



Above illustration shows Louden Single Drum Power Hoist and four horse power gasoline engine lifting 1,000 pounds of hay. The top of the load has been removed with hay fork; a sling is being used for the last load. Note how completely it cleans up the rack.

The clutch on Louden Power Hoists is simple, powerful, and dependable. The contact blocks are of hard maple and in operation are forced into the cone shaped metal drive. They are accessible by removing a single pin, and are mounted on eccentric benches, making them adjustable to take up the wear. One set of blocks will last several seasons and they can be replaced for a few cents and in ten minutes time.

When help is scarce and high priced, and all the horses are needed in the field, the Power Hoist comes to the rescue and does the work of both a team and man. Not only that, but it does the same work in about one-fourth the time.

Reduce these facts to figures and you will have the proof of our claim that a Power Hoist will easily pay for itself in a single season.

There is nothing complicated about it—no delicate mechanism. It is just a plain, common sense, sturdy machine built to handle big loads easily and to save time and labor in hay harvest.

There is as much difference between unloading hay with a hoist and with horse power as there is between handling it with horse power and with a pitchfork. Try one out this season.

How long a Power Hoist will last is still to be proved, for the first hoists placed on the market by the Louden Machinery Company, over ten years ago, though much inferior to the later models, are still giving efficient, and satisfactory service.

The convenience of the hoist is increased for general farm purposes by mounting it on the same truck with a portable engine. In this manner it is easily moved from place to place and will be handy for practically all of the heavy lifting about the farm and elsewhere, such as removing wagon boxes and hay racks from wagons, cleaning and digging wells, elevating roots from root cellars, and silage from underground silos. It can also be used successfully for storing ice and for elevating grain with a dump box.

While the Louden Power Hoist is designed primarily for unloading hay, it has been found exceedingly valuable for many other uses. Here is what a builder writes: "We used the Louden Power Hoist in building a concrete stack at the plant of the Iowa Malleable Iron Company. It was most satisfactory and proved a great saving in time and effort. It handled the cement in 800-pound lots as fast as the power mixers were able to deliver it. I am confident from the design and behavior of the hoist that it will handle a ton."

There is a great need for time and labor saving equipment in hay harvest, as the season is short and the crop is valuable. A delay of a few hours may mean a serious loss.

Louden Power Hoists are designed for quick, efficient work. They are so simple that anyone may quickly understand and operate them, and the great numbers in which they are manufactured enable us to put them on the market at a price within reach of every farmer.

The hoist may be used with any kind of power—steam, gasoline or electric. Under ordinary conditions three or four H. P. is sufficient, though five or six H. P. is better. Engine and hoist may be located in any convenient place.

The whole operation is extremely simple. Five minutes practice will put the operator in perfect control of the hoist and its load. Its action is positive and it always responds to the levers.



Louden Single Drum Power Hoist—Fig. 965

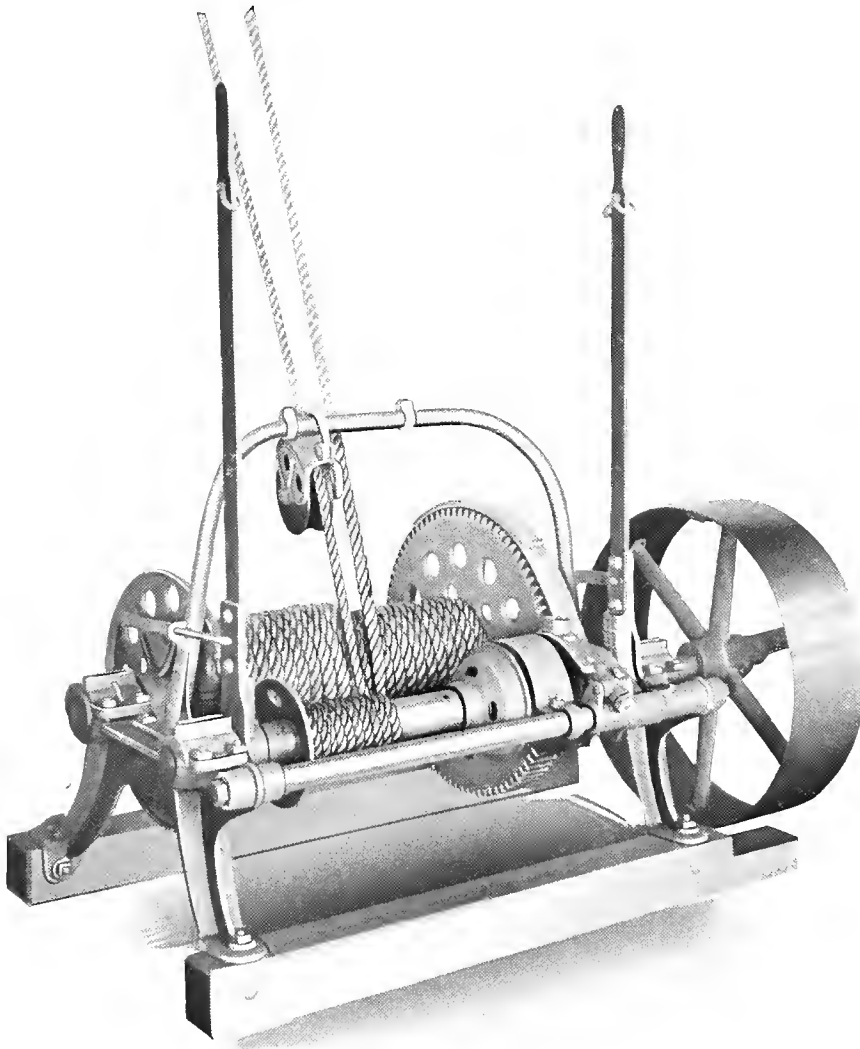

Fig. 965

Specifications

Operation: Load carried in one direction by use of large drum. Empty carrier returned by use of small drum.

Main Drum: Length, 20 inches; diameter, 6 inches; diameter of drum flanges, 15 inches. Capacity; 300 feet of $\frac{3}{4}$ -inch rope or 400 feet of $\frac{1}{2}$ -inch rope.

Return Drum: Length, 11 inches; capacity, 300 feet of $\frac{1}{2}$ -inch rope.

Belt Wheel, pressed steel; diameter, 20 inches; width of face, 6 inches.

Total width, 25 inches.

Total length, 43 inches.

Floor space necessary, 25x36 inches. (Note: Where hoist is mounted on truck, sufficient room for operator to stand should be allowed.)

Weight complete, 308 pounds (ready to ship).

Price: \$40.00

Where the load is to be carried in one direction only, as in an end hoist barn, the Single Drum Power Hoist is used. This hoist has one large drum for elevating the load and carrying it into the mow, and a smaller drum for returning the empty carrier. It is equipped with adjustable friction clutch and band brake.

One of the most valuable features of the Single Drum Hoist is the fact that it may be controlled from the load by means of ropes. There are only two ropes to handle—one to elevate the load and run it back into the mow, and one to operate the return drum and bring the empty carrier back to the wagon.

There is no time lost, no waiting, no changing of team from wagon to draft rope. All that is necessary is to set the fork in the load, or if slings are used, to attach the sling pulleys, then pull slightly on the main friction rope and the load goes up and into the mow. When the load is tripped, a slight pull on the return rope will bring the carrier back.



Louden Triple Drum Power Hoist—Fig. 1132

Specifications

Operation: Load hoisted to desired height by use of large drum. Load carried along track to the right by right hand small drum, or to the left by left hand small drum.

Main Drum: Length, 20 inches; diameter, 6 inches; diameter of drum flanges, 15 inches; capacity, 300 feet of $\frac{3}{4}$ -inch rope or 400 feet of $\frac{1}{2}$ -inch rope.

Small Drums (Each): Length, 8 inches; capacity, 175 feet of $\frac{1}{2}$ -inch rope.

Belt Wheel, pressed steel; diameter, 20 inches; width of face, 6 inches.

Total width, 48 inches.

Total length, 65 inches.

Floor space necessary for base, 38 x 65 inches. (Note: This is actual base.

Where hoist is mounted on truck, sufficient room for operator to stand should be allowed.)

Weight complete, 636 pounds.

Price: \$80.00

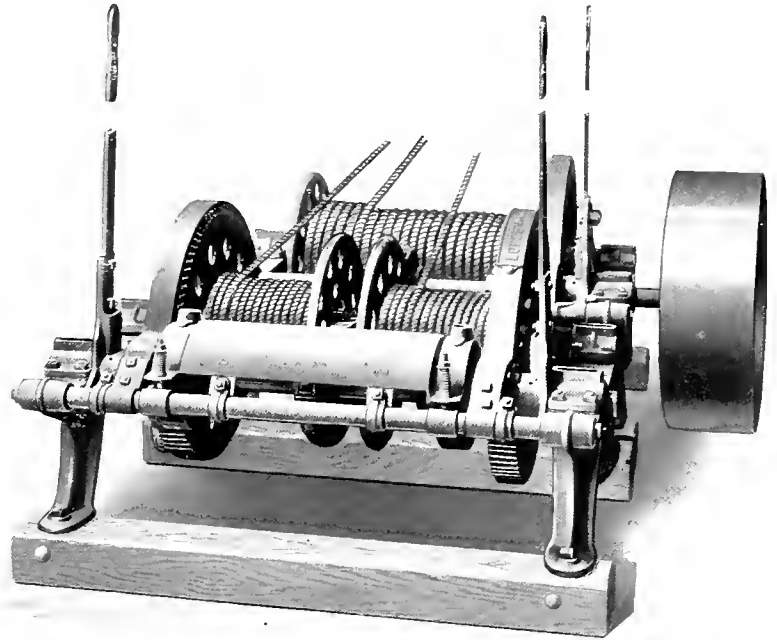

Fig. 1132

In a center drive barn, where the hay is to be stored in mows on both sides of the driveway, or in a Round barn, the Triple Drum Power Hoist should be used. With this hoist and a Cross Draft Sling Carrier, hay can be picked up and carried into either mow at the will of the operator. One load can be put in the right hand mow and the next in the left hand mow, if desired, without the changing of ropes or pulleys.

It is not necessary to carry the load clear up to the track. Unless cross timbers interfere, the hay may be run back into the mow at any height.

The Louden Triple Drum Power Hoist has three complete hoisting drums mounted in the same frame. They operate by friction clutch. Pull the levers to you and they force the clutch into contact; release them and the power is released automatically; push them from you and the brakes are applied.

Complete Power Rigs for Barns

The Power Hoist can be used successfully with any kind of a Hay Carrier. The following list of items are given as examples of complete outfits for center drive and end drive barn. The same specifications will apply for any length of barn with corresponding change in length of track and draft and return ropes. While we do not specify the rope, we are prepared to furnish it if desired; but as a rule rope can be purchased at a saving in local markets. (*Continued next page.*)

Louden Machinery Company, Fairfield, Iowa
 Gentlemen;

Redstone, Mont., May 23, 1913.

My barn is equipped with a Louden Hay Carrier and Slings which I bought of you the fall of 1910. The slings are the largest you sold. I can unload 1,000 lbs. at each pull, easy. I have a very large door, 9x12. I consider the outfit good in every way.

Yours truly,

John H. Schlag.



Louden Power Hoists—Continued

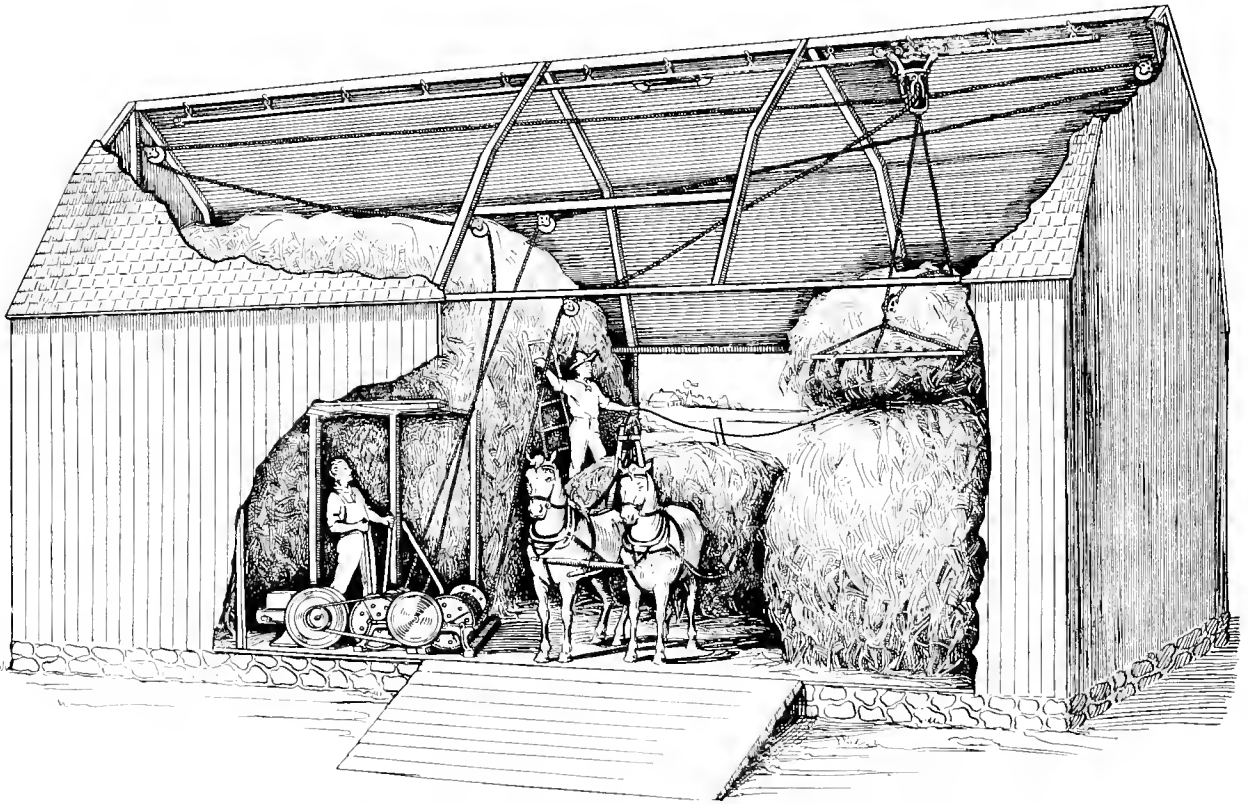

Louden Triple Drum Power Hoist in a Center Drive Barn

For Use with a Power Hoist Fifty-Foot End Hoist Barn

	Figure	Page	Unit Price	Total
1 Louden Senior Fork Carrier.....	1100	8	\$5.33 each	\$5.33
50 Ft. Louden Double Beaded Steel Track.....	571	30	.12 per ft.	6.00
26 Louden Standard Track Hangers.....	498	30	1.00 per doz.	2.16
26 Louden Rafter Brackets.....	424	31	.48 per doz.	1.04
1 Louden Balance Grapple Fork (6 tine).....	351	32	6.67 each	6.67
3 Louden High-Grade 6-inch Draft Pulleys.....	468	43	3.67 per doz.	.92
1 Louden Bracket Pulley Holder.....	348	46	.40 each	.40
1 Louden Steel Floor Pulley Hook.....	389	46	.93 per doz.	.08
1 Louden Steel Rafter Pulley Hook.....	390	46	.80 per doz.	.07
1 Louden Single Drum Power Hoist.....	965	22	40.00 each	40.00
Total.....				\$62.67

Eighty-Foot Center Hoist Barn

	Figure	Page	Unit Price	Total
1 Louden Cross Draft Carrier.....	817	18	\$ 8.67 each	\$ 8.67
76 Ft. Louden Double Beaded Steel Track.....	571	30	.12 per ft.	9.12
40 Louden Standard Track Hangers.....	498	30	1.00 per doz.	3.33
40 Louden Rafter Brackets.....	424	31	.48 per doz.	1.60
3 Louden Carry-All Slings.....	984	36	4.67 each	14.01
6 Louden High-Grade 6-inch Knot Pulleys.....	467	43	4.40 per doz.	2.20
4 Louden Rafter Pulley Hooks.....	390	46	.80 per doz.	.28
2 Louden Floor Pulley Hooks.....	389	46	.93 per doz.	.16
1 Triple Drum Power Hoist.....	1132	23	80.00 each	80.00
Total.....				\$119.37



Louden Round Barn Hay Unloading Outfits

Within recent years there has been much discussion regarding the advantages and disadvantages of round barns. It is not our purpose in this catalog to enter into a discussion of the merits of such buildings. We know that in certain localities round barns have come into favor and one of the problems in connection with these buildings has been the hay unloading outfit. Operating a hay carrier on a straight-away track and operating a hay carrier on a circle track are two entirely different propositions. It was our business to provide successful tools for unloading hay on the circle track. We have perfected hay unloading equipment to meet every condition in the round barn and with which hay may be handled and stored as quickly, as cheaply, as easily, and as safely as in rectangular barns.

Louden Round Barn Hay Carrier—Fig. 1104 (For Fork or Slings)

Specifications

The only successful hay fork and hay sling carrier made for circle track.

For use in round barns of all sizes.

Built to operate on Louden Double Bead steel track only.

Diameter of rope wheel in carrier, 6 inches.

Diameter of rope wheels in sling pulley and fork pulley, 4 inches.

Diameter of track wheels on tread, 3 inches.

Track wheels are supported on heavy truck castings attached to main frame of carrier by means of strong swivel connection.

Bearing surface on track (distance between front and rear axles), 16 inches.

Total length of carrier, 21 inches.

Carries slings or fork within 21 inches of the track.

Frame of carrier of refined malleable iron.

Rope and track wheels special quality gray iron.

Safe working capacity, 2,000 pounds.

Note: Five-inch link track hangers (Fig. 832, page 30) should always be ordered for circle track for round barns.

Three-quarter inch best manila rope is recommended and urged for use with this carrier.

Thirteen-sixteenths inch rope may be used but $\frac{3}{4}$ inch is better.

Two sling pulleys, 1 release block, 2 end stop blocks, 2 swivel rope hooks furnished with this carrier.

Unless otherwise specified, parallel sling pulleys will always be furnished with this carrier.

If hay fork is to be used fork pulley (Fig. 366, page 45) will be furnished instead of sling pulleys

Weight for sling use, 57 pounds.

Weight for fork use, 50 pounds.

Price, with sling pulleys: \$11.00

Price, with fork pulleys: \$10.00

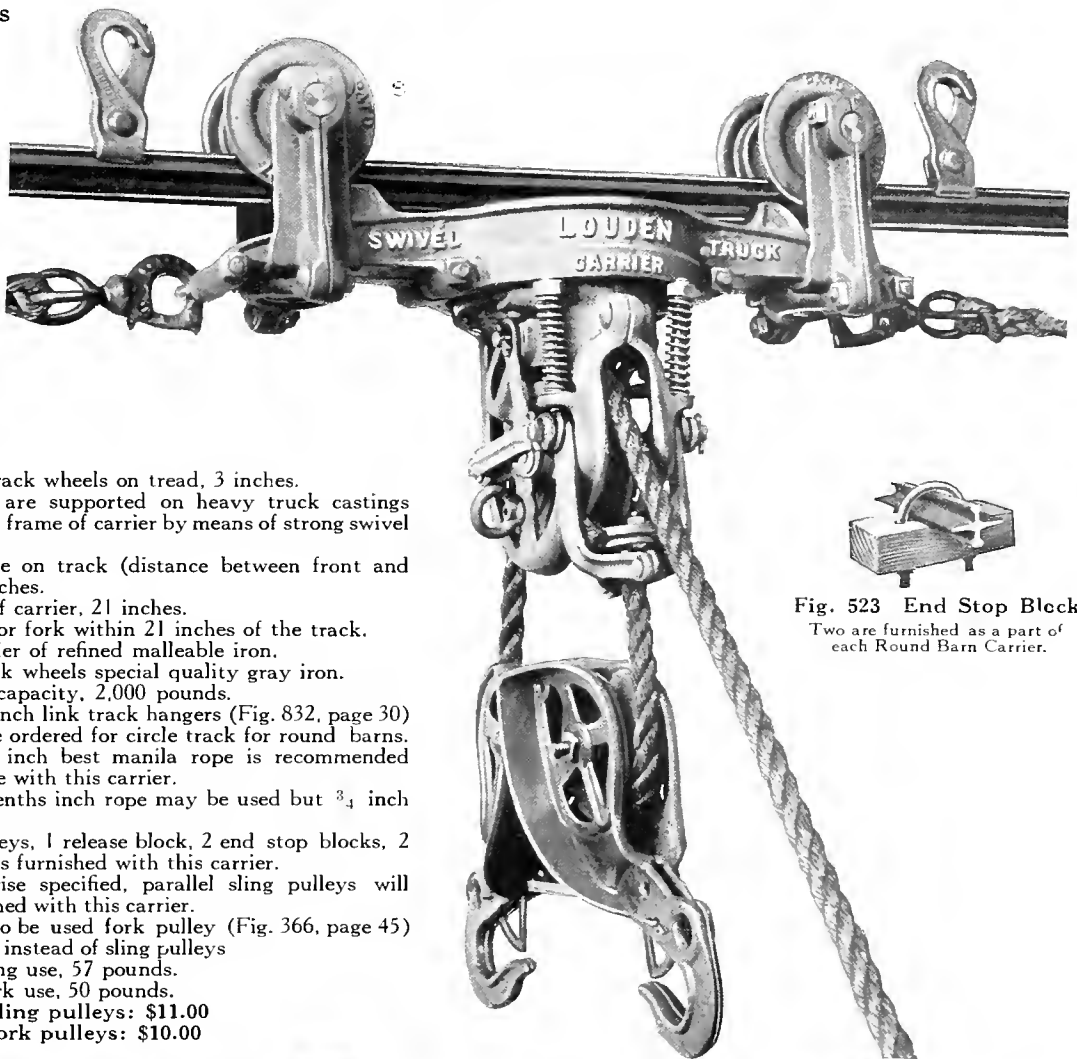

Fig. 1104
 (Round)



Fig. 1131 (Release Block)

One is furnished with each Round Barn Carrier.



Fig. 523 End Stop Block
 Two are furnished as a part of each Round Barn Carrier.



Fig. 383 (Excelsior)

Two Rope Hooks furnished with each Round Barn Carrier.

Louden Round Barn Hay Carrier—Continued

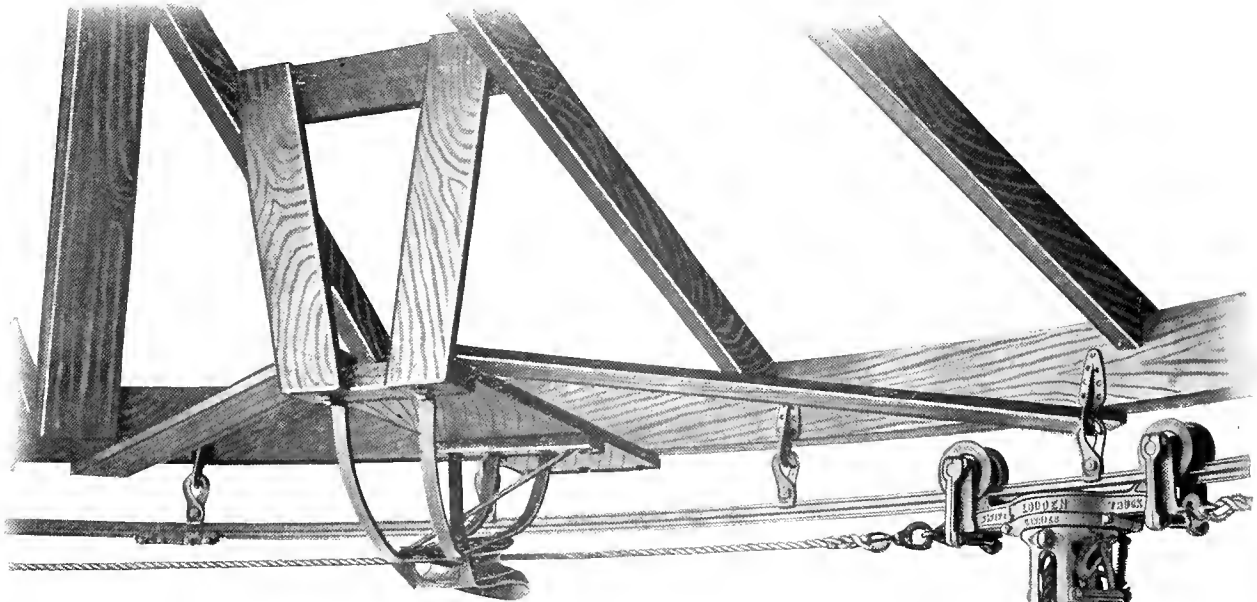

Fig. 1135-A

Illustration, Fig. 1135-A, shows a short section of track, a hay carrier, and a guide pulley for round barn. The guide pulleys are placed just far enough away from the track so the hay carrier will pass by. When the front shift rope pulls the carrier past the guide pulley, the following shift rope (the tail rope) is brought into position in the pulley ready to pull the carrier in the opposite direction.

The Round Barn Hay Carrier works on the same principle as the Cross Draft Hay Carrier described on page 18. The main draft rope, instead of running parallel with and along the track, runs at right angles to the track and passes down to the team or hoist in the most direct manner. The draft rope is used solely to elevate the hay and not to pull the carrier along the track. With the draft rope passing directly from the carrier to the team or hoist, only about half as much draft rope is required as with an ordinary hay carrier. This also greatly reduces friction, as the rope does not have to pass over so many pulleys, making it possible to lift heavier loads with less power.

Independent shift ropes are used for pulling the carrier along the track. Good quality $\frac{5}{8}$ -inch rope is suitable for shift ropes. Two of these ropes are necessary, one end of each rope being attached to opposite sides of the carrier, the other end passing around the guide pulleys and continuing to the hoist or to the team and weight return as the case may be.

Where engine or electric power is at hand, this outfit used in connection with a Louden Triple Drum Power Hoist (see Fig. 1132, page 23) makes the most complete and perfect hay unloading outfit ever installed in any barn. The lower end of the main draft rope is connected to the main drum of the hoist. The lower end of each of the shift ropes is attached to the respective two smaller drums of the hoist.

The main drum of the hoist is used to elevate the load. It is not necessary to raise the load up to the track unless beams or hay already in the mow interfere. The load can be stopped at any height and can be carried in either direction from the driveway at will. The instant the tension is released on the draft rope the rope lock goes into action and will catch and hold the load. If it is desired to carry the hay to the right, the right hand drum, and if to the left, the left hand drum, is brought into action. This pulls the carrier along the track and when the load is dropped the opposite drum is brought into play and the empty carrier is returned to the release block. The entire operation is extremely simple and the hoist can be handled by anyone.



Louden Round Barn Hay Carrier—Continued

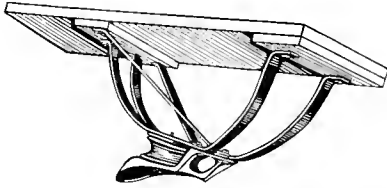

Fig. 1135
Guide Pulley
Specifications

Length of mounting block, 36 inches.
 Width of mounting block, 12 inches.
 Depth of mounting block, 12½ inches.
 Diameter of pulley, 6½ inches.
 Weight, complete, 26½ pounds.
 Price: \$4.00

We furnish the track bent to form a circle track of any diameter. Each section of the track is put through a bending machine, and is bent uniform and true, and without kinking the flange or injury to the track. We furnish suitable hangers for supporting the track from rafters or from purlin plate as desired. It should be remembered that the higher up in the building the track is placed the easier it will be to fill the mow full.

Special guide pulleys are used for holding the shift ropes in parallel position with the track. These pulleys are furnished mounted on a board (see Fig. 1135), and are easy to put in place. The pulley sheave or rope wheel is mounted in a malleable iron casing and supported by steel braces. The pulley is mounted in a slightly tilted position; also, the lower pulley casing extends beyond and slightly upward in front of the rope wheel, thus holding the shift ropes in position. Even should the ropes become very slack they will not fall out of the pulley.

Where a complete circle track is installed, seven or eight or more guide pulleys should be used. The purpose of the guide pulleys is to carry the shift rope as nearly parallel with the track as possible. The number of pulleys necessary is determined by the diameter of the track. Always enough pulleys should be used so the carrier will be pulled straight ahead, not sideways.

In illustration (Fig. 1206, page 57), the letter W represents the wagon and L the sling load of hay being carried into the mow. In this illustration the left-hand shift rope, LS, has been carried clear around and placed in position in all of the guide pulleys. This shows the ropes arranged to carry the hay to the left hand side. If it was desired to carry the hay to the right-hand side, the position of the shift rope would be reversed and the right-hand shift rope, RS, would be in position in the guide pulleys.

Where there is a silo in the center of the building, it would be necessary to detach one shift rope from the hoist and carry it around the silo when changing to work the carrier in the opposite mow. This change is easily made, requiring only two or three minutes time.

This rig can be used with horse power instead of the hoist and when so used the arrangement of ropes would be only slightly changed. Instead of one shift rope passing around the complete circle, as shown with hoist, both shift ropes would pass over pulleys and be arranged to correspond with the arrangement in rectangular barns. (See Fig. 822, page 19.)

This special unloading outfit for round barns will do satisfactory work in barns of all sizes. Hay forks or hay slings can be used and the rig will handle heavy loads of all kinds of hay.

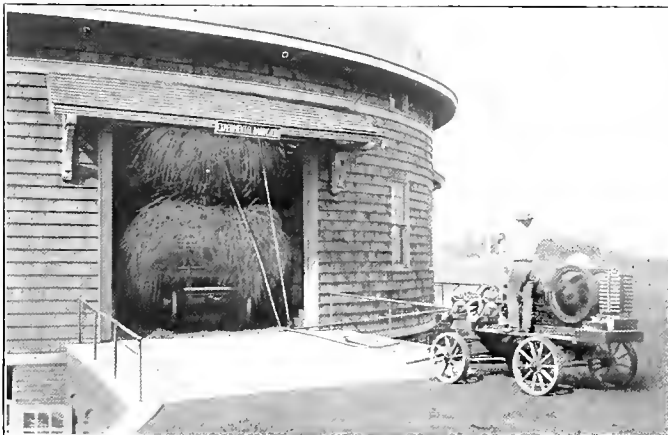

Louden Power Hoist and full equipment are used in the University of Illinois Round Barns

Edinboro, Pa., Dec. 11, 1914
 Louden Machinery Co., Fairfield, Iowa
 Dear Sirs:

In 1911 I purchased a 6-Tine Balance Grapple Fork of you with track and carrier. Since then I have bought more barn equipment from your factory. All have, and are giving, the very best of service and I shall always remember you when in need of anything in your line.

Very truly, N. L. Kingsley.

Cordell, Okla., May 28, 1914
 Louden Machinery Co., Fairfield, Iowa
 Gentlemen:

Without the Hay Handling Tools, including the Hoist, we could not have gotten our hay in dry between rains. We figure this outfit has paid for itself with the hay saved in good condition from this cutting.

It was a streak of good luck that led me to write for information after seeing your ad.

Faithfully yours, Geo. Bishop.

West Chester, Pa., Dec. 21, 1914
 Louden Machinery Co., Fairfield, Iowa
 Gentlemen:

I can't say too much for Louden Tools. The 6-Prong Hay Fork is a peach.

W. Robinson.



Louden Junior Hay Fork Carrier For Cable Track — Fig. 621

Specifications

For stacking hay in the field.
 Built to operate on $\frac{3}{8}$ inch or $\frac{1}{2}$ -inch cable.
 Diameter of rope wheels 4 inches.
 Diameter of track wheels on tread, $3\frac{1}{4}$ inches.
 Bearing surface on track (distance between front and rear axles), 10 inches.
 Total length of carrier, 14 inches.
 Carries fork within 13 inches of the track.
 Frame of carrier of refined malleable iron.
 Rope and Track Wheels special quality gray iron.
 $\frac{3}{4}$ inch best Manilla Rope is recommended.
 $\frac{1}{8}$ or $\frac{7}{8}$ inch rope may be used.
 Safe working capacity 1,000 pounds.
 One Fork Pulley, 1 Trip Block, 1 Rope Swivel, furnished with carrier.
 Weight, 24 pounds.
 Price: \$4.20

This Carrier was designed for use in connection with the Louden Cable Ricker for stacking hay. It operates on a wire cable track ($\frac{3}{8}$ inch or $\frac{1}{2}$ inch diameter) and does its work as nearly perfect as can be. It is built along the same general lines as the Louden Junior Carrier for steel track. It is compactly and stoutly built, its working parts are extremely simple and it never fails to work right.

The carrier has the wide flaring mouth and the round-top fork pulley of all Louden Carriers. The fork pulley will never fail to enter the carrier, no matter from what angle it may be drawn.

The lock has a square catch and cannot wedge fast. The trip block, at one end, clamps solidly to the cable. The remainder of the trip block is a loose sleeve which attaches to the stationary clamp by means of a swivel. The sleeve fits loosely around the cable so the trip block always stands in position under the cable to properly engage the locking dog in the carrier.

The end of the draft rope is fastened in the carrier by means of our patent swivel iron knot which prevents twisting and kinking of the rope.

Hay slings can be handled with this carrier by using the self-locking sling pulleys Fig. 330, page 40. The carrier was not built for sling use, and we recommend its use being confined to handling hay fork.

It is often necessary to stack hay in the field. Whether all of the hay, or only the overflow from buildings where the crop is heavy is to be stacked, the Louden Cable Ricker can be put into service with profit. The stacker works on the same principle as a hay carrier in a barn. The carrier travels on an overhead wire track that is supported by poles as shown in cut. The hay is carried on this track over the center of the stack and can be dropped at any point. This keeps the middle of the stack full, making a waterproof backbone. Much of the hay does not have to be moved after it is dropped on the rick. One man can stack more hay from a Louden Cable Ricker than two men can take care of when delivered by a stacker that delivers the hay at one place only.

The poles at the end and the cable track above also act as guides for building the stack. Stacks of any size up to 60 feet in length can be built with the cable ricker. We furnish the cable in any lengths desired. The cable should be allowed to extend to the ground, on the outside of the poles, at each end, thus forming guys. Forty feet of cable should be allowed outside of the poles at each end. Where 30-foot poles are used and a 50-foot stack is to be built, 140 feet of cable would be required. This allows room to drive the load of hay inside the poles and thus secure a straight lift up to the carrier. Where poles longer than 30 feet are used add 2 feet of cable for each added foot of pole length.

We do not furnish poles as they cannot conveniently be shipped by local freight. Poles should be 5 to 6 inches in diameter at the top and 30 feet or more in length.

This cable ricker is easy to set up, easy to move from place to place, and when not in use the metal parts can be stored in small space. With ordinary care the outfit will last many years.

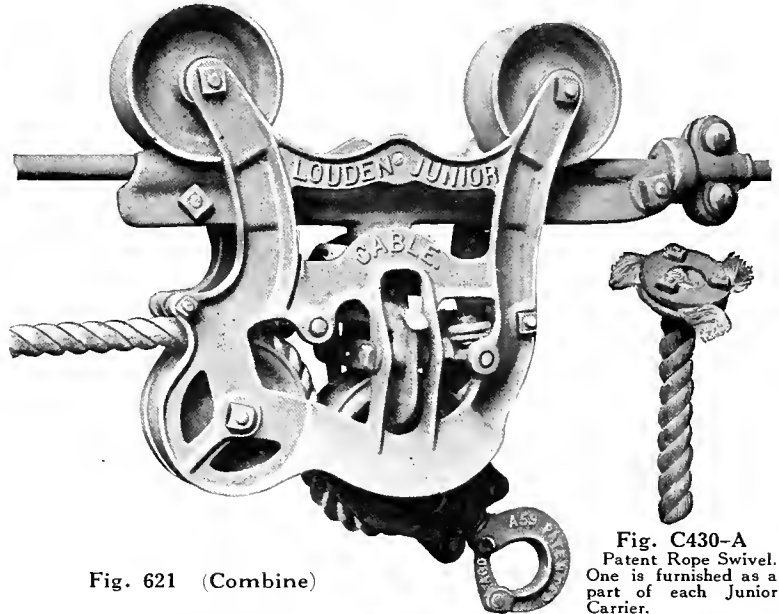

Fig. 621 (Combine)

Fig. C430-A
 Patent Rope Swivel.
 One is furnished as a part of each Junior Carrier.



Trip Block. Fig. 801 (March)
 One is furnished as a part of each Cable Carrier.





Louden Cable Ricker

(See Page 58 for Estimate of Outfit.)

Galvanized Steel Wire Rope

Fig. 417 is a Galvanized Steel Wire Rope. It is composed of six strands, seven wires to the strand, laid about a hemp center, thus forming a rope of 42 wires. It has a breaking strain of 8 tons. It is extremely durable and pliable enough to handle easily. We can furnish this wire rope in $\frac{1}{2}$ -inch or $\frac{5}{8}$ -inch size, as may be desired. We recommend the heavier size. Either Fig. 417 or Fig. 418 may be used as the track for the Carrier. Fig. 417 makes the best track, but is more expensive. Five-eighth inch size: Weight per 100 ft., 76 pounds. One-half inch size: Weight per hundred feet, 61 pounds.



Fig. 417 (May)

Price ($\frac{5}{8}$ -inch size): \$.06 $\frac{1}{2}$ per ft.

Price ($\frac{1}{2}$ -inch size): \$.05 $\frac{1}{2}$ per ft.

Galvanized Steel Strand, $\frac{1}{2}$ -in. Diameter

Fig. 418 is composed of seven No. 8 Wires. Estimated breaking strain about four tons. This makes a cheaper track than the Galvanized Steel Wire Rope and is used quite often. Weight per 100 feet, 50 pounds.

Price: \$.02 $\frac{2}{3}$ per ft.



Fig. 418 (June)

Cable Clamps

Fig. 337 is our Wire Cable Loop Clamp and is used to make a loop at the end of the cable. Two of these should be used with each stacker. Weight each, 1 $\frac{1}{4}$ pounds. Price: \$.22 each.

The Wire Cable Stop Clamp, Fig. 337 $\frac{1}{2}$, is placed on the wire cable track at either side of the poles at the end of the stack to hold the upper ends of the poles securely in position. Four of these Clamps are used for each stacker. Weight each, 1 pound. Price: \$.16 $\frac{2}{3}$ each.

These clamps are made of malleable iron and are held together with two good, strong bolts, which grip the cable firmly so that they will not slip. (See page 58 for estimate of outfit.)



Fig. 337 (Porto)



Fig. 337 $\frac{1}{2}$ (Rico)



Louden Steel Track and Track Fixtures For Hay Carriers

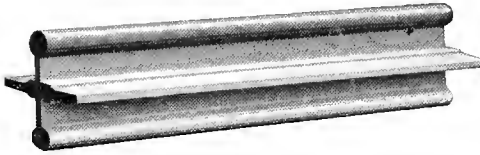

Fig. 571 (Clara)

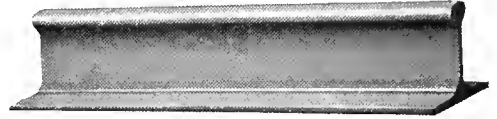

Fig. 584 (Cora)

Louden Double Bead Steel Track—Fig. 571

Fig. 571 shows a section of Louden Double Bead Steel Track. This track is a special quality high carbon steel. It is 2 inches wide, $1\frac{7}{16}$ inches high and, properly supported every 24 inches, it will safely carry a load of 3000 pounds. Weight, per foot, 2 pounds. Price: \$.12 per ft.

Louden Single Bead Steel Track

Fig. 584 shows a section of Louden Single Bead Steel Track. Like the Double Bead Track, this is a special quality high carbon steel. It is 2 inches wide, $1\frac{1}{4}$ inches high and, properly supported every 24 inches, will safely carry a load of 3000 pounds.

Weight, per foot, 2 pounds.

Price: \$.12 per ft.

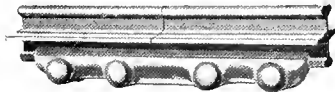

Fig. 550 (Mohler)

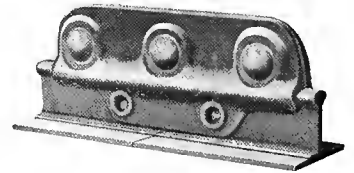

Fig. 436 (Mulkins)

Splice Clamp for Double Bead Steel—Fig. 550

Fig. 550 is the Splice Clamp for Louden Double Bead Steel Track. It is of malleable iron and is held firmly in place on the under side of the track by four bolts. It is easily attached, holds the flanges of the track level and makes it just as strong at the joint as at any other point. Care should be used to see that the nuts on the four bolts are drawn tight. After the nuts have apparently been made tight, the bolts should be set by striking them a heavy blow on the head with a hammer. After this is done it will be found the nuts can be drawn still tighter and the clamps will hold securely.

Enough clamps for the track are furnished with every shipment.

Weight, each, $1\frac{1}{8}$ pounds. Price: \$.20 each

Splice Clamp for Single Bead Track—Fig. 436

Our Splice Clamp for Single Bead Steel Track is shown in Fig. 436. Pins pass through holes in the track and hold the ends securely together. The coupling holds the flanges level and makes a smooth joint. The parts of the splice clamp are held firmly together by three heavy bolts.

Weight, 1 pound. Price: \$.20 each

Louden Track Hangers

Fig. 498. Louden Standard Track Hanger for Single or Double Bead Steel Track. Made of malleable iron, in two parts, securely clamped together by short, heavy bolt.

Weight, per dozen, 6 pounds. Price: \$1.00 per doz.

Fig. 500. Louden Light Track Hanger for Single and Double Bead Steel Track. Made of malleable iron, in two parts, securely clamped together by short, heavy bolt. The same style as the Louden Standard Hanger except not so heavy.

Weight, per dozen, $4\frac{1}{2}$ pounds. Price: \$.82 per doz.

Fig. 832. Link Track Hanger (5-inch) for Single and Double Bead Steel Track. The clamp is of malleable iron, the link of steel. This hanger is for use any place but is particularly adapted to uneven ceilings. Standard length of link, 4 inches. Can be furnished any length desired. (See condensed price list, page 76.)

Weight, 5-inch link, per dozen, 6 pounds.

Price: \$1.06 per doz.

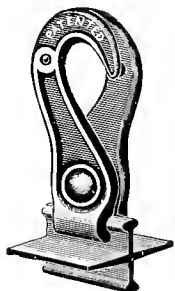

Fig. 498 (Carson)



Fig. 500 (Camp)



Fig. 832 (Trout)



Track and Track Fixtures—Continued



Fig. 780 14-inch (Canna)

Fig. 781 16-inch (Chestnut)

Fig. 780. Straight Hang Hook for wood track. Made of $\frac{1}{2}$ -inch steel rod and furnished in two lengths.

Weight, 14-inch size, per dozen, $10\frac{1}{2}$ pounds. Price: \$0.80 per dozen.



Fig. 372 (Cairo)

Jointed Hang Hook for Wood Track

Weight, 16-inch size, per dozen, 12 pounds. Price: \$0.90 per dozen.

Fig. 372. Jointed Hang Hook for wood track. Made of $\frac{1}{2}$ -inch steel rod. Total length, 14 inches. Weight, per dozen, $13\frac{1}{2}$ pounds. Price: \$1.33 per dozen.

Rafter and Ridgepole Brackets

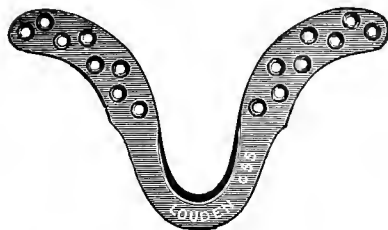

Fig. 424 (Casper)

Fig. 424. Improved Malleable Rafter Bracket, our strongest and best.

Weight, per dozen, $4\frac{1}{2}$ pounds.

Price: \$0.48 per dozen.

Fig. 425. Malleable Rafter Bracket, common pattern.

Weight, per dozen, 3 pounds.

Price: \$0.40 per dozen.

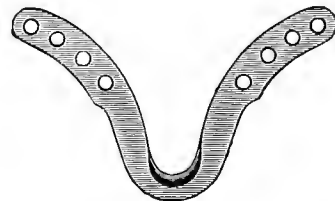

Fig. 425 (Caesar)

Malleable Ridgepole Bracket

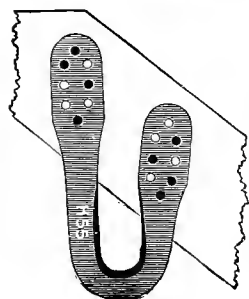

Fig. 465 (Cute)

Fig. 465. Malleable Ridgepole Bracket, used when the track is hung parallel to a joist or 2-inch timber.

Weight, per dozen, 3 pounds. Price: \$0.67 per dozen.

Fig. 675. Side Rafter Bracket, used for hanging track to rafters on one side of the roof.

Weight, per dozen, $5\frac{1}{4}$ pounds. Price: \$0.80 per dozen.

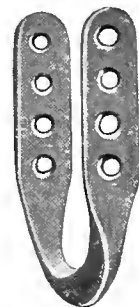

Fig. 675 (Cute)

Side Beam Bracket



Fig. 725 (Cement)

Fig. 725. Side Beam Bracket for hanging track parallel to the side of a timber.

Weight, per dozen, 6 pounds. Price: \$1.00 per dozen.

Barbed Chisel Point Steel Nail

Fig. 373. Barbed chisel-point Steel Nail for putting up rafter or ridgepole brackets. Cut shows actual size.

Price: \$0.10 per pound.

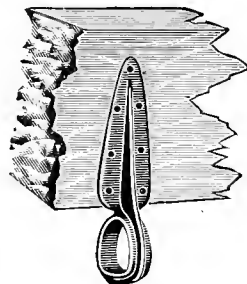
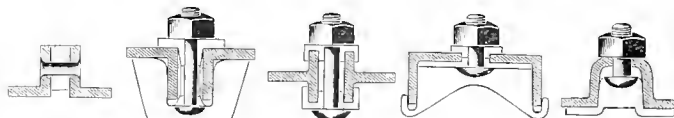

Fig. 725 (Beam)

Other Hay Carrier Tracks



No. 3

No. 4

No. 5

No. 6

No. 7

We do not furnish these tracks, but we fit our Junior Carrier to run on them. In ordering Carrier state the number and size of your track.

No. 3 is 2 inches wide; Nos. 4 and 5, $2\frac{1}{2}$; No. 6, $2\frac{5}{8}$, and No. 7, $2\frac{1}{4}$ inches wide.



Louden Balance Grapple Hay Forks

Louden Balance Grapple Hay Forks are in use in all parts of the United States and Canada and in all kinds of hay. Wherever the fork is known customers are enthusiastic in saying it cannot be beaten in any respect by any hay fork that has ever been made.

The arched support is covered by patents and is the greatest improvement ever made in grapple forks. It secures a perfect balance, by means of which the fork can be either opened or closed with the slightest touch. The fork is neat in design and perfectly balanced in all of its parts and adequately strong for any work it will ever be called upon to do.

The material used in the construction of the fork is a special high-grade steel. The steel is very stiff with just enough spring to it so it will not bend or break under the heaviest work. The tines of the cheaper constructed forks soon become bent and twisted out of shape and the fork is made useless. Be sure to get a Louden Fork. They are built of special steel that will hold its shape under the heaviest work.

For Timothy Hay

In long timothy hay, any kind of hay fork can be used with fairly good satisfaction. Much of the success in using a harpoon fork depends on the manner in which the hay is loaded on the wagon. If the man on the wagon knows how and has the time to load carefully, fairly good results are secured with a harpoon fork. The

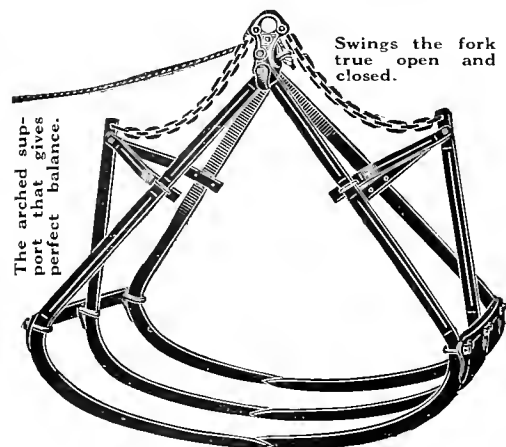
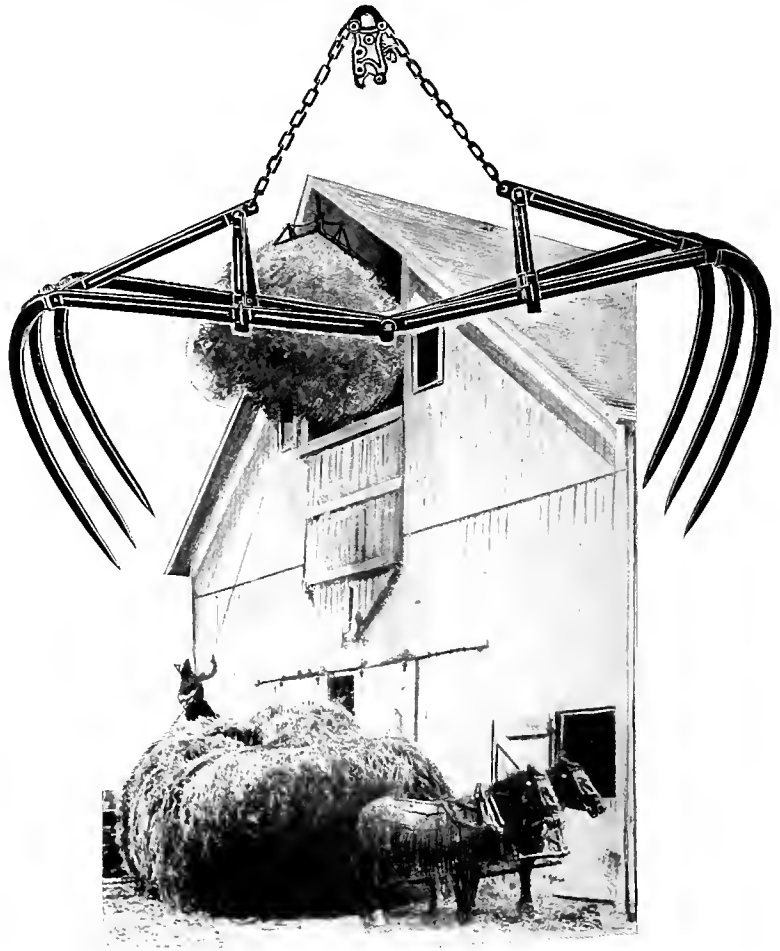

Fig. A-351 6-Tine Fork Closed



Louden Standard 6-Tine Balance Grapple Fork
 Fig. 351 (Planet)

Specifications

Spreads when open 58 inches.
 Width between outside tines, 19 inches.
 Tines go into hay 24 inches.
 Weight, 45 pounds.
 Price: \$6.67

best results, however, are always secured with the Louden Grapple Fork. No difference how the hay is loaded on the wagon, the Louden Balance Grapple Fork handles it right. When using a harpoon fork, there is always a lot of hay that will shake loose and fall back to the wagon or on the barn floor. All of this litter and extra work is saved by using a Louden Balance Grapple Fork.

For Clover Hay

It is annoying and expensive to try to use a harpoon fork for unloading clover hay, and especially so if the hay has become a little dry. As a rule, the fork will pull up through the hay and lift only a very small load. It takes about three



Louden Balance Grapple Hay Forks—Continued

times as long and requires about three times as much hard work to unload a load of clover hay with a harpoon fork as it does with a Louden Balance Grapple Fork. The fork puts its arms, so to speak, around a great bunch of hay and binds it in Nature's own way, just as you would pick it up and hold it in your arms. Working in clover hay, the grapple fork will pay for itself in two days' use and will save a lot of hard work.

Alfalfa Hay

The Louden Grapple Fork will make equally as good a showing in one kind of hay as it does in another. It handles them all as nearly the right way as any fork could possibly do. The Louden Grapple Fork, however, is exceptionally strong in alfalfa. It has an affinity for alfalfa hay. It will take alfalfa hay from the wagon and carry it into the hay mow or up on to the stack in such big bunches that users are astonished and delighted with its efficiency. Another thing, when the fork lets go of the hay it spreads it out and makes it easy to mow away.

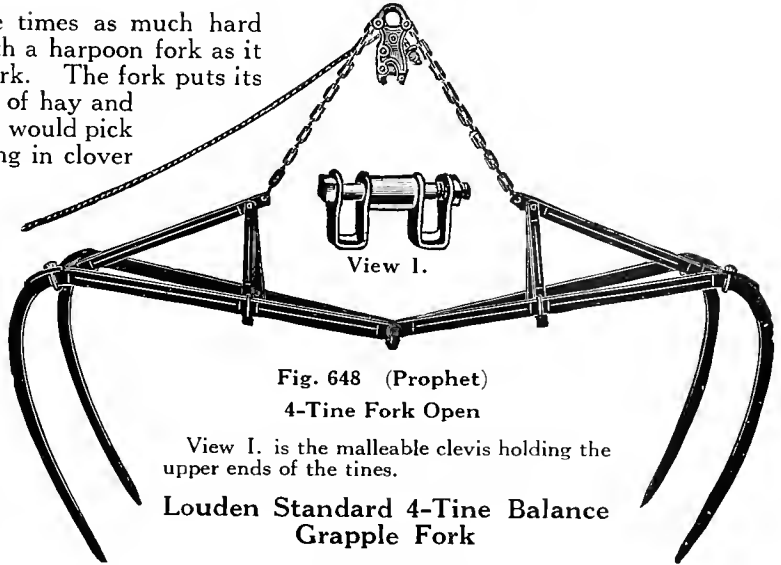

Fig. 648 (Prophet)
4-Tine Fork Open

View I. is the malleable clevis holding the upper ends of the tines.

Louden Standard 4-Tine Balance Grapple Fork

Specifications

Spreads when open, 58 inches.
 Width between outside tines, 19 inches.
 Tines go into hay 24 inches.
 Weight, 40 pounds.
 Price: \$5.33

It drops every straw and no hay is left clinging to the tines and bothering in that respect.

Other Hay

The Louden Balance Grapple Fork will handle any kind of hay. In the Far North where the Canada field pea flourishes and in the Far South where the cow pea blooms, the fork is handling the work successfully and growing in popularity each year. The grapple fork will successfully handle threshed straw. Many Michigan customers are using the fork for putting their bean crops into sheds preparatory to threshing. Where there is hay or forage of any kind to handle, the Louden Balance Grapple Fork will do it successfully.

At first thought it might seem a fork of this size would be hard to handle. On the contrary, it is easy to handle. When the hay carrier is returned to the trip block and the fork pulley is released, the fork will settle down to the wagon without any pulling or hauling. The fork goes down open all ready to set into the hay. The man on the load can grasp the fork as it comes down and swing it into position and set it into the hay just as easy and just as quickly as a harpoon fork.

The fork is furnished in three sizes. The Standard 6-tine size is the one most largely used. The 4-tine fork is exactly the same as the 6-tine fork except the center tine is left out on each side. The extra large 6-tine fork is built heavier throughout than the other forks. The Standard size 6-tine and 4-tine forks are large enough for practical use under average conditions. The extra large fork is desirable for clover and alfalfa where extremely heavy loads are to be handled.

Fig. 686 (Farmer)
Extra large 6-Tine Fork Closed

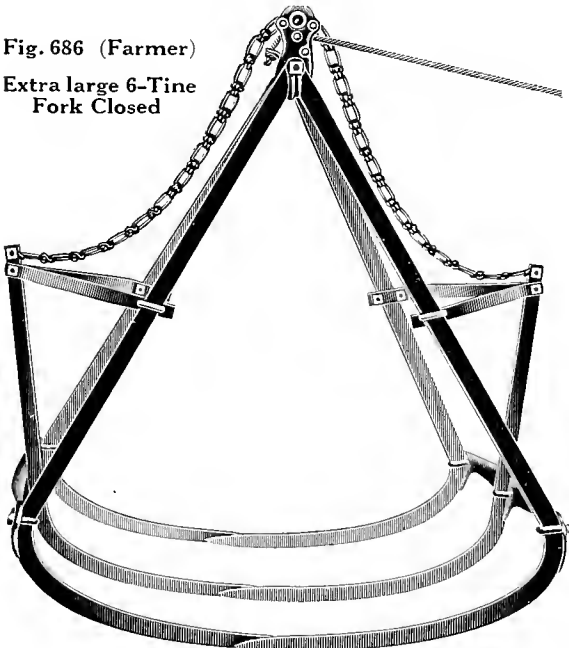

Louden Extra Large 6-Tine Balance Grapple Fork

Specifications

Spreads when open, 6 feet 7 inches.
 Width between outside tines, 25 inches.
 Tines go into hay 24 inches.
 Weight, 50 pounds.
 Price: \$8.00



Louden Rocker-Bar Hay Fork—Fig. 1137

The Louden Rocker-Bar Hay Fork is an extra strong fork constructed out of the best quality high carbon fork steel. The fork will enter the hay easily. The tines lock in position either open or closed and the toes cannot double back when entering green or tough hay.

The cross bar on the fork is placed near the top and it gathers the hay or grain from the end of the point instead of from two inches above the bottom. This fork, therefore, has a larger capacity and will carry bigger loads than the ordinary double harpoon fork. When the load is carried into the mow the fork trips easy and will drop its load clean.

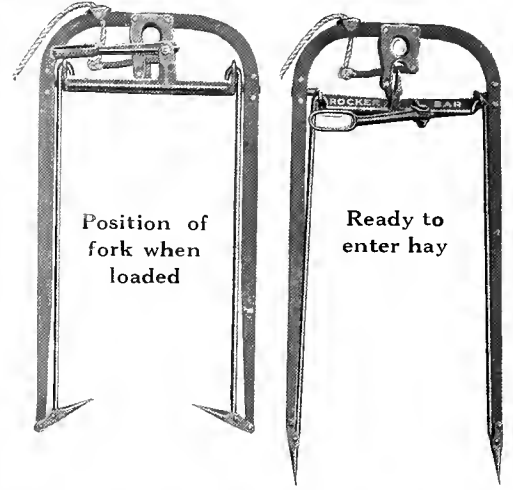
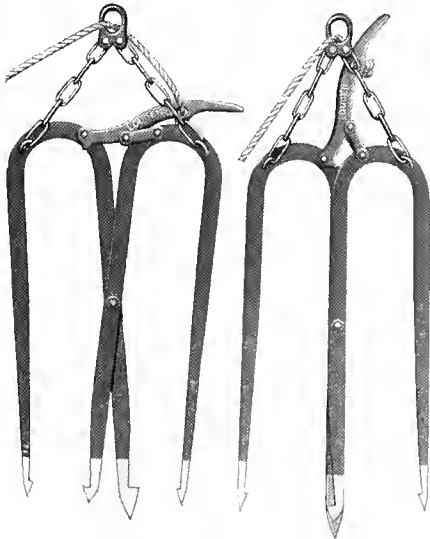

Fig. 1137 (Tuttle)

Specifications

For use in any style of barn.
 Can be used with any kind of hay carrier.
 Will handle any kind of hay.
 Length of tines under head (distance tines go in hay), 31 inches.
 The tines and main frame of the fork are of special high carbon fork steel.
 The rocker bar, toes and lock are malleable iron.
 Weight, 20 pounds. Price: \$2.50



View B View A

Fig. 350 (Peerless)

Specifications

For use in any type of barn.
 Can be used with any hay carrier.
 For use in all kinds of hay.
 Body and tines of special quality fork steel.
 Lock lever of malleable iron.
 Length of tines, 24 inches.
 Weight, 12 pounds. Price: \$3.33

Specifications

For use in any type of barn.
 Can be used with any hay carrier.
 Length of tine, 26 inches.
 Weight, 13 pounds.
 Price: \$2.00

Nellis Single Harpoon Fork Fig. 356

This is the old original type of hay fork. It will do good service in long, heavy timothy hay. Is not so successful in clover or alfalfa, especially if the hay is somewhat dry.



Fig. 356 (Poker)

Louden Triple Harpoon Fork Fig. 350

The Louden Triple Harpoon Fork is the lightest weight and at the same time the strongest harpoon fork made. The fork is all fork. It will go down into the hay clear out of sight, will lift a bigger load and carry the load closer to the track than any other harpoon fork made.

In Fig. 350, View A shows the fork open, ready to enter the hay. The small tapering tines will enter the hay easily. The lever is then pushed downward, forcing the tines into the position as shown in View B. In addition to lifting big loads, the triple harpoon fork will bind its load from top to bottom and prevent the hay from shaking loose and falling back.

This fork can be used with any make of hay carrier and is so strong and compactly built that it will give years of service.

Harris Double Harpoon Fork—Fig. 353

Specifications

For use in any type of barn.
 Can be used on any kind of hay carrier.
 Made in three sizes:

Standard size.

Length of tines under cross bar, 24½ inches.
 Width between tines, 15½ inches.
 Weight, 19 pounds. Price: \$1.07

Intermediate size.

Length of tines under cross bar, 31 inches.
 Width between tines, 15½ inches.
 Weight, 20 pounds. Price: \$1.33

Large size (Alfalfa).

Length of tines under cross bar, 32 inches.
 Width between tines, 21 inches.
 Weight, 32 pounds. Price: \$2.47

The Harris Double Harpoon is the original harpoon fork. It has been on the market for years and will do good work under all ordinary conditions.

It is built of genuine fork steel, for use in any barn, with any type of hay carrier and in any kind of hay.

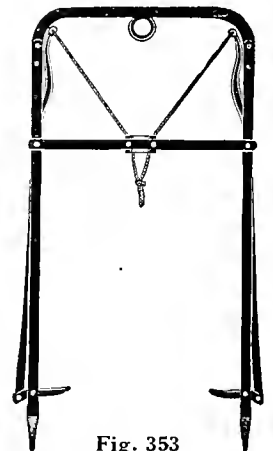

Fig. 353



Louden Hay Slings and Fittings

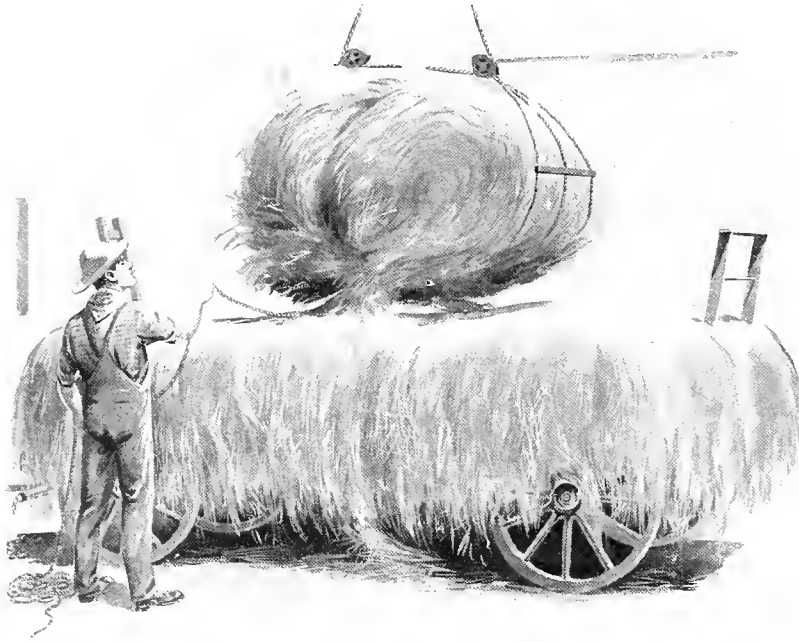

Fig. 319

large scale. Slings spread the full length of a fourteen to sixteen foot rack require about ten feet of space between the track and beams for the load to pass through.

Where a large amount of hay is to be handled, and there is sufficient clearance room through the hay door and in the mow for the large loads, there is no plan that equals the use of slings. Generally three slings are used to a wagon, taking the load into the mow at three drafts, and cleaning the rack perfectly with no shatterings to pick up.

The first sling is placed on the rack, using care to draw the ends out where they can be reached when the hay is piled on. One-third of the load is placed, another sling laid on, again using care to lay out the ends where they will be in reach. Another third of the hay is then loaded and the third sling laid on, when the loading is completed.

In unloading the hay, the sling pulleys are spread apart and one hooked into each end of the top sling. The power on the draft rope gradually brings them together and rolls the hay up as shown in Fig. 319. When the sling is tripped the spring of the hay causes it to unroll and spread in the mow evenly (See Fig. 320), and in practically the same shape it occupied on the wagon.

We were the originators of successful slings and sling carriers, and we warrant ours to be superior to any on the market. We have made a special study of slings and sling carriers, and during the past twenty-five years we have thoroughly tested and greatly improved them.

The Use of Slings

Like everything else, some judgment is required in using slings to obtain the best results. The power available, the length of rack, the size of wagon-loads, and the space above beams in the barn should all be considered and the number of slings estimated and their length adjusted accordingly.

Slings require more room over beams than forks, therefore it is unwise to purchase a sling outfit that hangs away down below the track. We have always watched this point carefully and our carriers and sling attachments have been made compactly so as to occupy the least possible space.

Our experience has been that the rack should not be over sixteen feet long (and fourteen feet is better) unless the barn, elevator and everything else are on a very

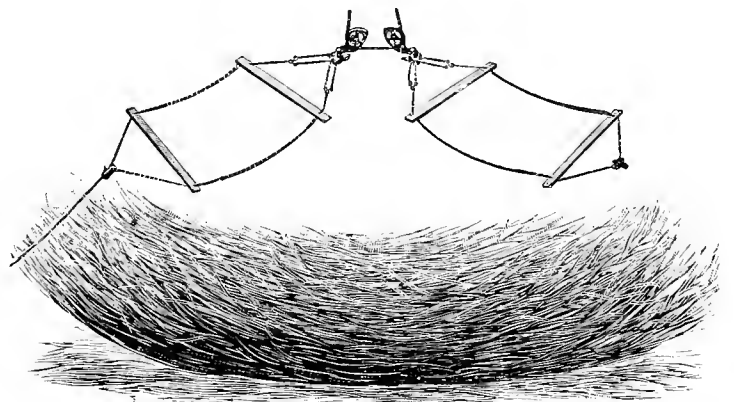

Fig. 320

See How it Spreads the Hay

It is tripped in the center below the hay and separates into two parts, letting hay drop out between them, perfectly clear, and without tilting it on edge, as side trip slings invariably do. The hay being first rolled up, as shown above, **UNROLLS** when discharged and spreads out in the mow or on the stack as wide as the length of the Sling, and in **EXACTLY THE SAME SHAPE** it lay on the load.



Louden Carry-All Hay Sling—Fig. 984

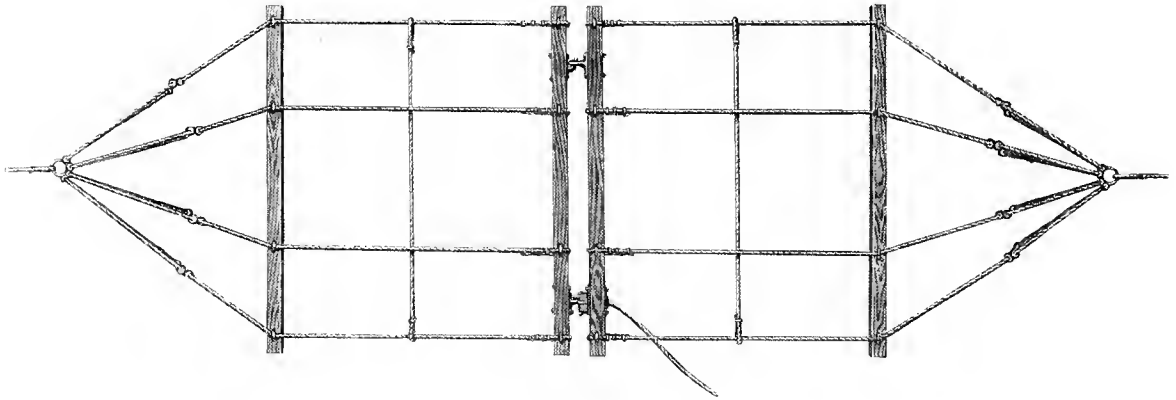

Fig. 984 (Entire)

Specifications

For use in any type of barn.
 Can be handled with any Sling Hay Carrier.
 Standard width of sling, 6 feet.
 Cross bars are of hard wood, 2"x2"x6'.
 Length of sling is adjustable from 15 to 21 feet.
 Main ropes $\frac{1}{2}$ inch.
 Center cross rope, $\frac{3}{8}$ inch.

Trip rope and search rope, $\frac{5}{16}$ inch.
 Ropes clamped to cross bars with steel hook bolts.
 Sling coupling of malleable iron.
 Safe working capacity, 2,000 pounds.
 Weight, 36 pounds.
 Price: \$4.67

The Carry-All is the popular leader of the widely known and widely used Loudon line of Hay Slings. It is designed for hard, heavy work and yet it works so perfectly and so easily that it is adapted for use anywhere that a hay sling can be used.

This sling is strong enough to permit unloading an ordinary load of hay at a single lift, and can safely be used to handle ton loads. The design of the sling is new. The two cross bars in the center are held close together and are connected by a strong double lock instead of one lock only, as generally used.

This is the ideal sling for handling short growths, such as threshed straw, headed grain, bound grain, dry or short clover and alfalfa. On account of its close construction and the fact that it is connected at two points in the middle, there is no chance for short hay or straw to shatter through or fall out. The sling is equally adapted for handling the long and heavy growths.

The double lock works easily and perfectly. The trip rope attaches to one lock only, the other lock being merely a hook and an eye. A slight pull on the single trip rope releases both locks simultaneously. The lock releases as easy under a heavy load as a light one. In coupling the sling together the hook is inserted in the eye and at the other end the catch is snapped into place. The connection is quickly made and will hold securely.

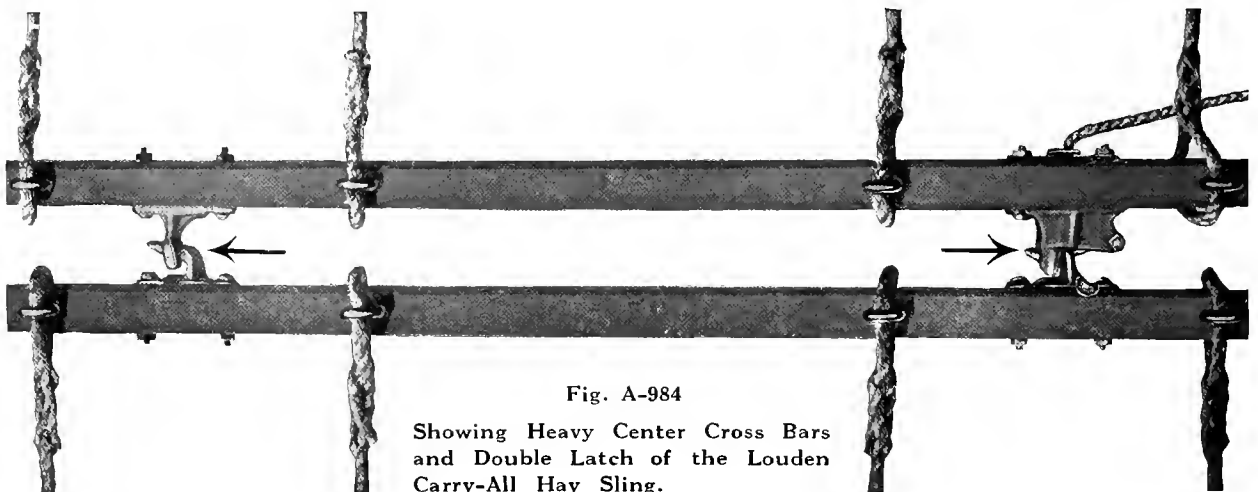

Fig. A-984

Showing Heavy Center Cross Bars
 and Double Latch of the Loudon
 Carry-All Hay Sling.



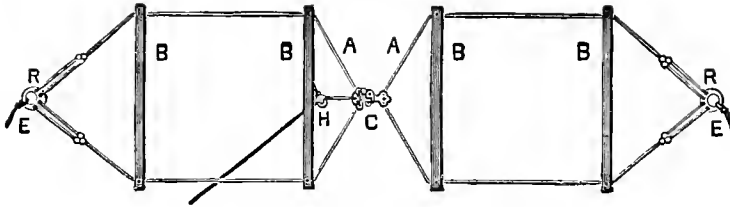

Fig. 666 (4-ft., Moon; 5-ft., Mars)

Specifications

For use wherever a sling can be used.
 Can be handled on any Sling Hay Carrier.
 Furnished in 4-ft. width and 5-ft. width.
 Cross bars are of 2-inch by 2-inch hard wood.
 Length of sling is adjustable from 15 feet to 21 feet.
 Main ropes $\frac{1}{2}$ inch.
 Trip rope $\frac{5}{16}$ inch.
 Ropes clamped to cross bars with Steel Hook Bolts.
 Sling coupling of malleable iron.
 Safe working capacity, 1,000 pounds.
 Weight, 4-ft. size, 16 $\frac{1}{2}$ pounds.
 Price: \$2.13 (4-ft. size).
 Weight, 5-ft. size, 27 pounds.
 Price: \$2.53 (5-ft. size).

Louden Three-Rope Sling

The Louden Three-Rope Sling is very strong and dependable. There are three main ropes on each side. This offers a close, compact construction and makes this a desirable sling for handling the shorter growths of hay or threshed straw.

The coupling in the center is made strong for heavy work. The latch holds securely until the proper time when an easy pull on the trip rope will cause the coupling to separate and sling to drop its load.

This sling is adapted for use anywhere that a sling can be used.

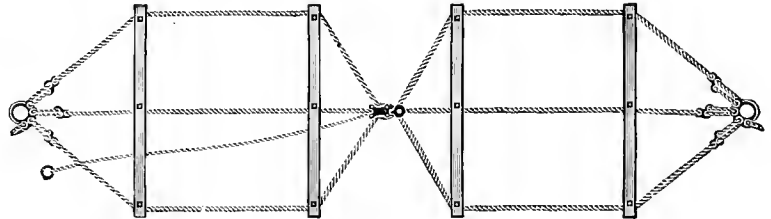

Fig. 600 (Modern)

Specifications

For use in any type of barn.
 Can be handled with any Sling Hay Carrier.
 Standard width of sling, 5 feet.
 Cross bars are of hard wood, 2 inches by 2 inches by 5 feet.
 Length of sling is adjustable from 15 to 21 feet.
 Main ropes $\frac{1}{2}$ inch.
 Trip rope, $\frac{5}{16}$ inch.
 Ropes clamped to cross bars with Steel Hook Bolts.
 Sling coupling of malleable iron.
 Safe working capacity, 1,400 pounds.
 Weight, 20 pounds. Price: \$2.67

Louden California Hay Sling

The California Hay Sling is designed for handling any kind of hay. It is especially recommended for very short hay or bound or headed grain. It is called the California Sling because of the great demand for it in the Golden State.

With the exception of the Carry-All it is the heaviest and most compact sling we make. The coupling in the center is extra heavy and has a strong catch that will hold securely until the proper time when it trips easily.

The sling is adjustable in length from 15 feet to 21 feet and by loosening the hook bolts the cross bars may be adjusted to fit any rack.

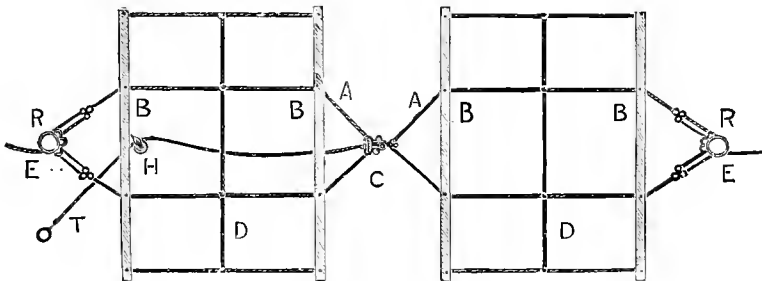

Fig. 324 (Moxie)

Specifications

For use in any type of barn. Can be handled with any Sling Hay Carrier.
 Will handle any kind of hay. Width of sling, 6 feet.
 Cross bars are of hard wood, 2 inches by 2 inches by 6 feet.
 Length of sling is adjustable from 15 feet to 21 feet.
 Main ropes, $\frac{1}{2}$ inch. Center cross ropes, $\frac{3}{8}$ inch.
 Trip rope and search rope, $\frac{5}{16}$ inch.
 Ropes clamped to cross bars with steel hook bolts.
 Sling coupling of malleable iron. Safe working capacity, 1,600 pounds.
 Weight, 28 pounds. Price: \$3.33



Sling Coupling—Fig. 516

The coupling used with all Louden Slings except the Carry-All. The coupling is made of malleable iron. The working parts are completely protected and the trip cord can be easily and quickly attached. While the catch is positive and secure, a slight pull on the trip rope will cause the coupling to unlatch. Weight, 2½ pounds. Price: \$.67

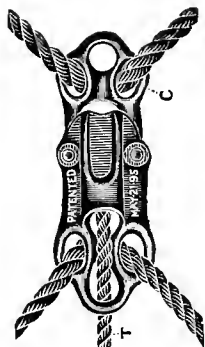

Fig. 516 (Mate)

Louden Handy Hay Sling and Holder Fig. 1106

(For Use With Sling Carrier Only)

Weight, Three-Rope Sling 4¾ pounds Price, Three-Rope Sling \$1.60
 Weight, Two-Rope Sling 3¼ pounds Price, Two-Rope Sling 1.17

The ease and convenience with which this all-rope sling can be handled has gained for it the appropriate name "Handy". As the sling has no spreaders it can more easily be carried and spread on the rack than slings having cross bars.

The sling trips at the end (or side) instead of in the center as do other slings. The sling can be made up of two ropes or three ropes as desired. The sling holder is provided with three latch hooks to carry either style sling.

The Louden Handy Hay Sling is the only sling of its kind that is made adjustable so it can be lengthened or shortened to fit any length rack. It will handle any kind of hay or forage. The sling is easily drawn out from under hay in the mow and can be used in filling the barn full up to the comb. Three slings are generally required for each wagon.

Only one holder is required for each carrier. The holder is made

of malleable iron. The holder is intended for use with right angle or parallel sling pulleys. The latch or trip in the holder is quickly set and is secure and will trip easily at the proper time.

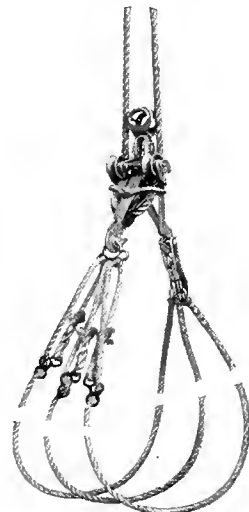

Fig. 1106 (Handy)



Fig. 1106-A
 Weight
 2 pounds
 Price, \$1.00

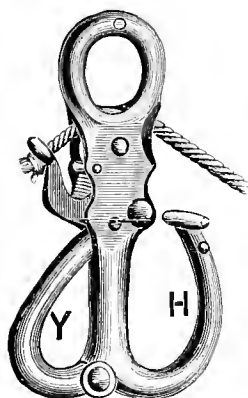

Fig. 328 (Martyr)



Fig. 329

Side Trip Sling Holder

(For Use With Fork Carrier Only)

Fig. 328 represents our Side Trip Sling Holder, and Fig. 329 is the same with ropes attached. The ropes are laid crosswise on the rack under hay to be elevated and the ends are drawn up by hand. The looped ends are slipped over the trip Y, which is then locked. The other ends are usually drawn through the hook H and tied in a bow knot. Four sets of ropes to a wagon are generally used.

Weight, 2¼ pounds.
 Price: \$1.00

How To Securely Clamp Metal Parts Together

- 1st. Put all the clamps on loosely so the parts can be easily racked to line them up properly.
- 2d. After they are all in proper position draw the nuts up tight with a wrench.
- 3d. When tightly drawn, hit the heads of the bolts heavily with a hammer to set them.
- 4th. Tighten up the nuts again with a wrench as much as can be safely done.

When treated this way the bolts will not be liable to get loose but without hammering their heads so as to solidly set them they will be liable to work loose under a strain and especially so under a jar. This is important in attaching clamps of any kind, especially splice clamps for overhead track, couplings and clamps for connecting the tubing of animal stalls and pens together, especially pens to hold vicious bulls and for other purposes requiring solidity and durability of structure.



Louden Fork Clevis—Fig. 652

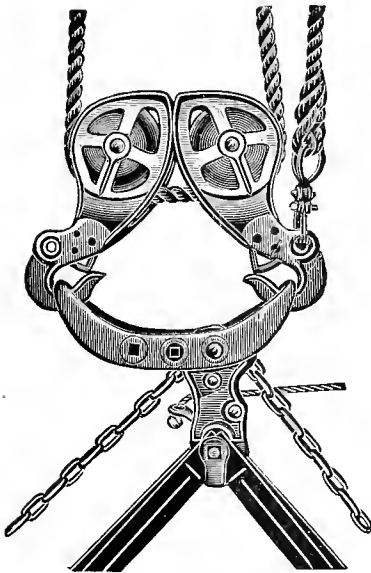

Fig. 652 (Maroon)

Specifications

Can be used with Parallel or Right-angle Sling Pulleys.
 Can be used with any style of fork.
 Made of malleable iron.
 Weight, 2 $\frac{1}{4}$ pounds.
 Price: \$.33

Figs. 652 and 653 represent our Fork Clevis attached to sling pulleys and by means of which a hay fork can be used with Louden Hay Sling Carriers. The Fork Clevis is attached to the top of the fork by means of a heavy bushing placed between the two sides of the clevis and held in place by a bolt. The clevis with the fork attached can be hooked on to the sling pulleys in a moment. There is no loss of time making the change from sling to fork.

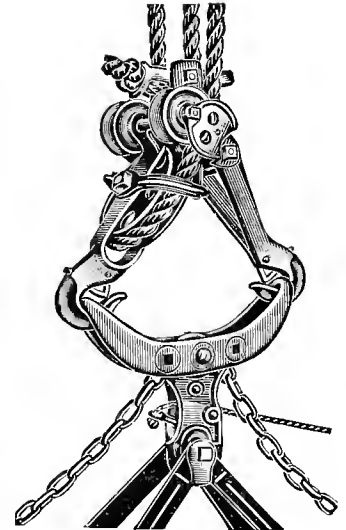

Fig. 653 (Maroon)

This clevis is largely used where a sling carrier is in the barn and the practice is followed of removing the top of the load with a fork and cleaning up the rack with a sling. The fork can be hung in the middle or one-third way from one end as may be necessary to balance it with double or triple draft. Fig. 652 shows the clevis in use with our Parallel pulleys and Fig. 653 with our Self-Locking Pulleys. The upper end of Louden Balance Grapple Fork is shown in the illustrations.

Louden Sling Binding Pulley—Fig. 332

Many farmers and hay growers follow the practice of removing the top of the load with a fork and cleaning up the rack with a sling. Or, sometimes, it is necessary to haul a load of dry, fine straw that cannot well be handled with a fork, and it is desired to use a sling.

The Louden Sling Binding Pulley is the tool to use for this work.

It can be used with any Hay Fork Carrier and without any change of rope or re-threading of carrier. In the illustration the Pulley A represents the regular fork pulley used with the carrier. The Pulley B is the Sling Binding pulley. The Fork Pulley A is slipped through the Sling Pulley B, the two pulleys are then spread apart and hooked into the two ends of the sling. When the load starts to lift, the Fork Pulley A slips back through the Sling Pulley B and registers in the carrier. This binds the load securely and the carrier supports the load as it is being carried back into the mow the same as in ordinary work. The Pulley B is the only extra part necessary to handle. This can be kept hanging within easy reach of the man on the load, so no time is lost in changing from fork to sling.

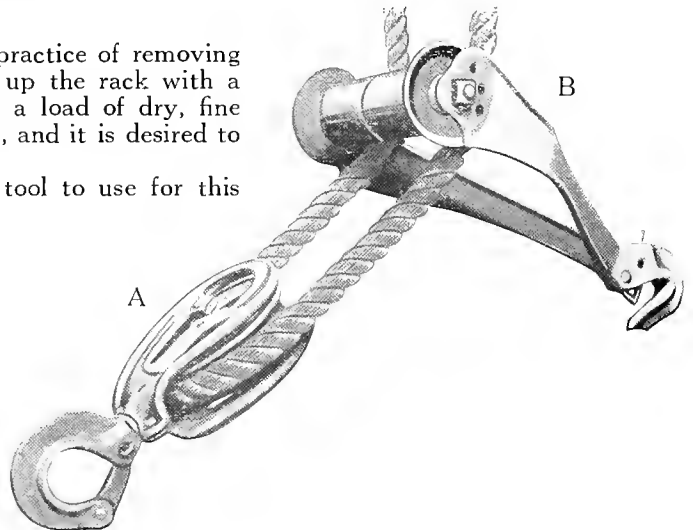

Fig. 332 (Mentor)

Specifications

Frame made of malleable iron.
 Wheels special quality gray iron.
 Weight (part B only), 5 pounds.
 Price: \$2.00 (part B only).



Louden Self-Locking Sling Pulleys Fig. 330

(Right Angle Sling Pulleys)

Specifications

Furnished with registering head to fit any Hay Carrier.
 Used with Louden Carriers, slings are carried within 20 inches of the track.
 Pulleys are of malleable iron except the wheels.
 Wheels are of special quality gray iron.
 Weight, 10 pounds.
 Price: \$2.00

It is sometimes desired to use Hay Slings in barns already equipped with Fork Carriers. If the track is good and the carrier is strong and sturdy, this can be done. Figs. 330-331 illustrate the Louden Self-Locking Sling Pulleys. With these pulleys slings can be handled with any hay carrier, using a registering head. We can furnish the pulleys fitted with any of the registering heads illustrated on opposite page and new heads are made to fit other carriers when there is sufficient call for them.

Our advice to customers who wish to use Hay Slings and who have a considerable amount of hay to handle, is to buy a regular sling carrier built for heavy work.

However, we sell thousands of these sling pulleys for use with fork carriers of all kinds and they always give good satisfaction so long as care is used not to overload the carriers.

Fig. 422 represents a set of Louden Self-Locking Sling Pulleys in use with our Standard Fork Carrier, Fig. 306. The pulleys are shown locked together but not yet registered in the carrier. Fig. 330 is a front view of the pulleys locked together and Fig. 331 is a side view of the pulleys spread apart to connect to the sling. As the load is elevated, the two parts of the sling pulley come together and lock as shown in Fig. 330. The registering head then enters the carrier and is engaged by the grappling hooks the same as the fork pulley when a fork is being used.

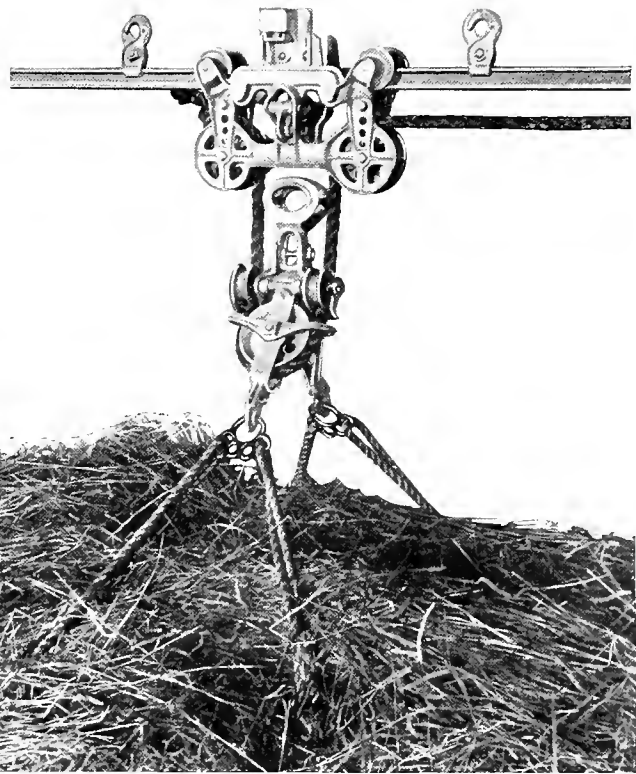

Fig. 422

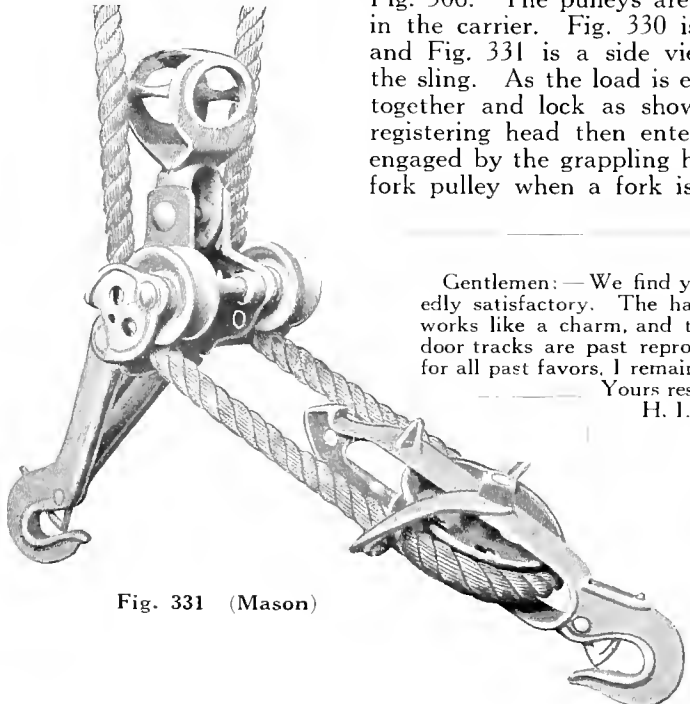

Fig. 331 (Mason)

July 30, 1914.
 Gentlemen:— We find your goods unexpectedly satisfactory. The hay track and carrier works like a charm, and the hanger and barn door tracks are past reproach. Thanking you for all past favors, I remain,
 Yours respectfully,
 H. I. Armour,
 Rising Sun, Md.



Fig. 330



Registering Heads for Louden Self-Locking Sling Pulleys

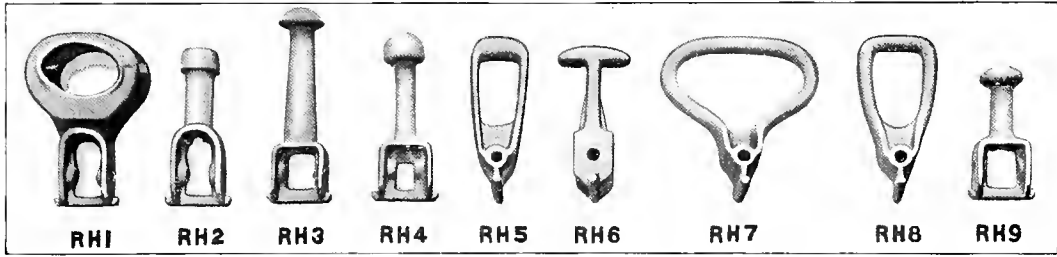

RH1 **RH2** **RH3** **RH4** **RH5** **RH6** **RH7** **RH8** **RH9**
 Louden Hall Star Leader Church Porter Milwaukee Reversible Milwaukee Swivel Burbanks Eclipse

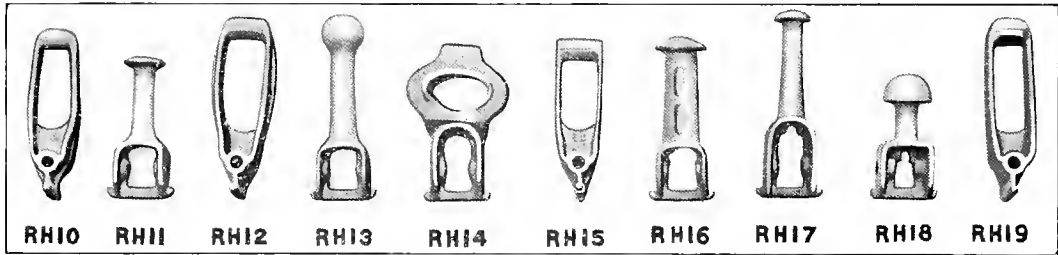

RH10 **RH11** **RH12** **RH13** **RH14** **RH15** **RH16** **RH17** **RH18** **RH19**
 New and Superior Osborn Jordan C., B. & Q. Myers O. K. Ashland Myers Combination Ideal and Jumbo Janesville Deadlock Haymaker or Imperial

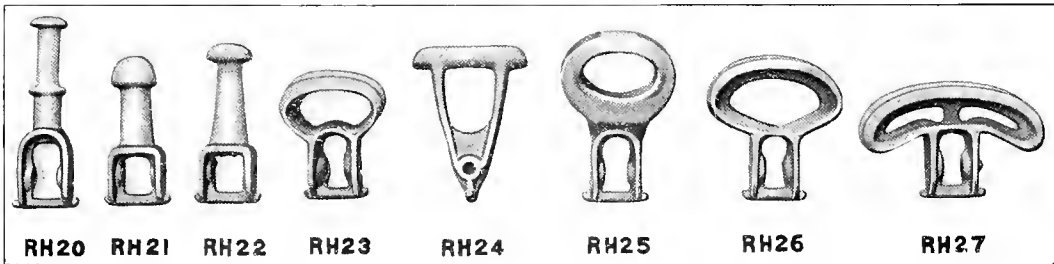

RH20 **RH21** **RH22** **RH23** **RH24** **RH25** **RH26** **RH27**
 Porter's Swivel Boyd Diamond New Diamond Boyd Reversible Unloader Clover Leaf W. B. Acme 1st Pattern W. B. Acme Improved

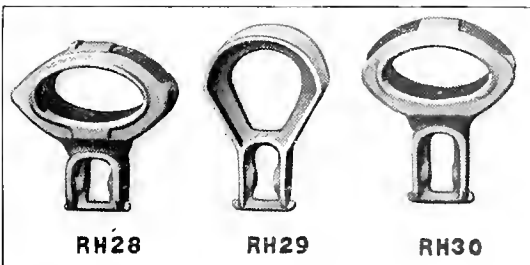

RH28 **RH29** **RH30**
 Louden Senior Meadow King Meyers Unloader 7-in. Sheave

The illustrations above show the Registering Heads which we make for our Self-Locking Sling Pulleys. These heads will fit the different carriers named.

When in doubt as to the head required, send the fork pulley of your carrier by express, prepaid, and we will fit the pulley with the proper head and return fork pulley with order.

Price: \$.33 each



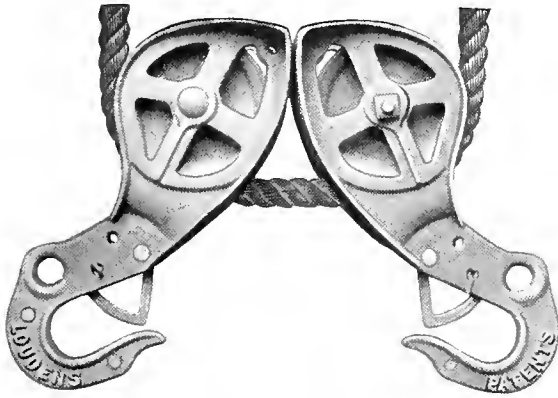

Fig. 649 (Mastiff)

Louden Parallel Sling Pulleys Fig. 649

Specifications

Can be used with any Louden Hay Sling Carrier.
 Can be used with any center-trip Hay Sling.
 Frame of pulley of refined malleable iron.
 Rope wheels of special quality gray iron.
 Diameter of Rope Wheels, 4 inches.
 Weight, per pair (2 pulleys), 10½ pounds.
 Price: \$1.67 per pair (2 pulleys).

The Louden Parallel Sling Pulleys are built for service and wear and for use wherever there is need for a sling pulley. The frame of the pulley is of malleable iron, with heavy reinforcing ribs at points where strength is needed.

The meeting edges of the pulleys are provided with wide flanges and the upper ends are closed so they cannot run into each other. The rope wheels and the pulley frames are made smooth and free from sharp corners so they will not wear the rope. The hooks are fitted with self-acting safety stops to prevent the slings from becoming detached. Eyes are provided in the lower end of the pulleys into which the end of draft rope can be fastened when it is desired to rig the pulleys triple draft.

Louden Senior Parallel Pulleys Fig. 650

Specifications

For use with cable draft rope.
 Can be used with any center-trip Hay Sling.
 Frame of pulley of refined malleable iron.
 Rope wheels of special quality gray iron.
 Diameter of Rope Wheels, 5 inches.
 Weight, per pair (2 pulleys), 15½ pounds.
 Price: \$2.33 per pair (2 pulleys).

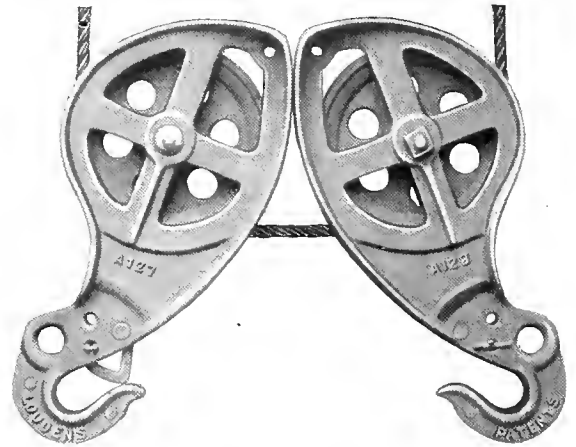

Fig. 650 (Miller)

The Louden Senior Parallel Sling Pulleys are of the same design as the regular parallel sling pulleys except they are larger and heavier and are fitted with sheaves or rope wheels for 3/8-inch cable draft rope instead of manila rope. The Senior pulleys are desirable where the work is extremely heavy.

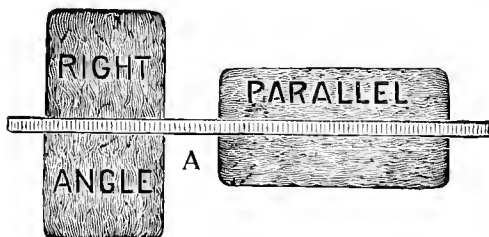

Fig. 412

Right Angle and Parallel Pulleys

Fig. 412 shows how the hay is deposited in the mow with respect to the Track A when Right Angle or Parallel Sling Pulleys are used. The Right Angle Pulleys spread the hay wider in the mow than the Parallel Pulleys, unless the latter are twisted quarter round before tripping the sling.



Louden High-Grade Pulleys

Use of Pulleys

Every article about a haying outfit should be first-class, strong and durable. When hay tools break in the haying season it means delay, loss of time, frequently loss and injury of hay, and occasionally serious accidents. Such breakages occur chiefly from the use of poor pulleys. It is therefore important that every user of Hay Tools should buy first-class pulleys.

We make a specialty of High-Grade Pulleys which we illustrate on the following pages. We have given special care and attention to the designing of our pulleys, taking into consideration every detail which would add to their merits. In making the eye and the frame we have placed the metal where the strength is needed, and cut it out where it is not needed, so that the pulley may have all the strength necessary, and at the same time be light and neat and not cumbersome to handle. The frame is made in two parts, held together by rivets and bolts. The wheel or sheave turns on a large malleable bushing, recessed into the frame of the pulley and held in position by a bolt. This gives the pulley great strength.

We handle the cheaper grade pulleys, but we cannot too strongly recommend the use of the best pulleys that can be purchased. Do not be persuaded to use cheap pulleys. The saving is only a trifle in the first cost, and the use of cheap pulleys may mean much damage and loss in harvest. The best is the cheapest in the end.

Louden High-Grade Pulleys have, through many years of continuous, satisfactory service, proved themselves superior in design, construction and durability. They have no sharp corners to wear the rope. The eyes are heavily ribbed and have tubular swivels, which add materially to their strength and efficiency.

The wood sheaves turn on large metallic bushings, recessed into the sides of the pulley frames, held in place by heavy bolts. The bearings in the iron sheaves also turn on large bushings which support the weight of the load and protect the connecting bolts from wear.

The sheaves in the four pulleys shown on this page are interchangeable. Fig. 553 is a sectional view of the Iron Sheave Pulley, showing the tubular eye, the projection in the frame which protects the rope from the edge of the sheave, the malleable bushings on which the sheave turns, the recess in the frame in which the bushing rests, and the bolt that holds it in place. This shows the sturdy construction which characterizes all Louden High-Grade Pulleys and gives them marked superiority over all others.

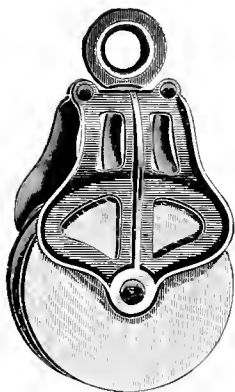

Fig. 467 (Paragon)
 Knot Passing Pulley. Malleable frame, swivel eye, 6-inch hard maple sheave seasoned in oil.
 Weight, 3 1/4 pounds.
 Price: \$4.40 per doz.

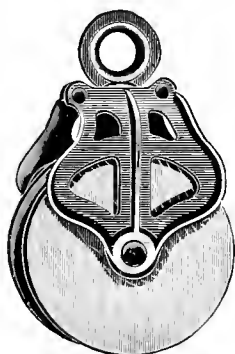

Fig. 468 (Prelude)
 Draft Pulley. Malleable frame, swivel eye, 6-inch hard maple sheave seasoned in oil.
 Weight, 3 pounds.
 Price: \$3.67 per doz.



Fig. 553
 Sectional View of Louden High-Grade Pulley.

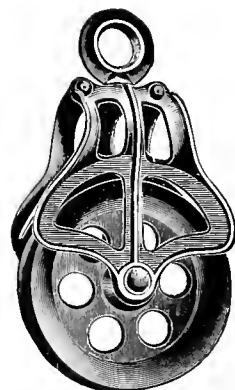

Fig. 494 (Passport)
 Knot Passing Pulley. Malleable frame, swivel eye, 6-inch diameter sheave. Sheave made of special quality gray iron.
 Weight, 5 1/2 pounds.
 Price: \$5.13 per doz.

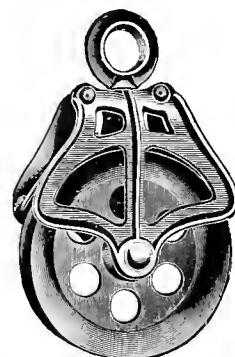

Fig. 495 (Password)
 Draft Pulley. Malleable frame, swivel eye, 6-inch diameter sheave. Sheave made of special quality gray iron.
 Weight, 5 1/8 pounds.
 Price: \$4.40 per doz.



Louden Mammoth Pulley—Fig. 519



Fig. 519 (Pencil)

Specifications

Weight, 5 $\frac{1}{4}$ pounds.
 Price: \$6.67 per doz.

The Mammoth Pulley is made for heavy work. It has a select 7-inch hard maple sheave, seasoned in oil. It has the tubular swivel eye, large malleable bushings on which the sheave turns, the guard over the edge of the sheave to prevent the rope from cutting,—in fact all of the good features of the pulleys previously described, and in addition is larger and stronger. The large sheave makes this pulley easy on the rope.

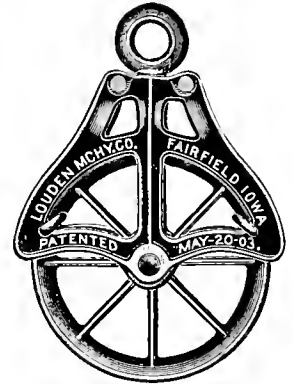

Fig. 579 (Perfect)

Specifications

Fig. 579. Cable Pulley. Malleable iron frame. Swivel eye. 8-inch diameter sheave. Sheave is made of special quality gray iron. Weight, 9 $\frac{1}{4}$ pounds.

Price: \$16.00 per doz.

Cable Pulleys—Figs. 579-651

Our Cable Pulleys are made with malleable iron frames and have all the good features of our Rope Pulleys—the tubular swivel eye, frame made in two parts, held together with bolts and rivets, large malleable bushing, held in recess in the pulley frame by a bolt, and projections or guards in the opening of the frame to protect the cable from the edge of the sheaves (see page 43, Fig. 553). We make them with iron wheels only, and the pulley throughout is made extra strong. The hole in the sheave is chilled and turns on a malleable bushing. The groove in the sheave is made suitable for $\frac{3}{8}$ -inch diameter wire cable.

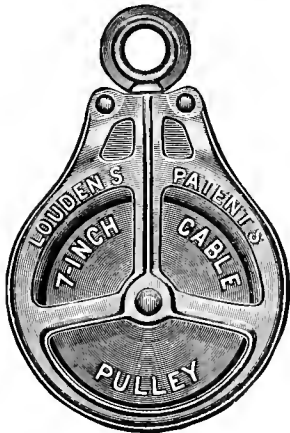

Fig. 651 (Kuroki)

Specifications

Fig. 651. Cable Pulley. Malleable iron frame. Swivel eye. 7-inch diameter sheave. Sheave made of special quality gray iron. Weight, 9 pounds.

Price: \$12.00 per doz.

Louden Upright Floor Pulley Fig. 364

This pulley is designed for use on the floor and in other places where common pulleys lop over when the rope is loosened, thus causing the rope to rub and bind in the pulleys. Every user of Hay Tools knows this is annoying and expensive.

Our upright Floor Pulley does not lop over or unhook, nor bind and hold the rope while the carrier is being drawn back. A slot in the bottom of the pulley slips over the head of the skein bolt, which is screwed into the floor and while holding the pulley upright, lets it turn freely in any direction. They may be used with as good results on a wall or a post in a vertical or inclined position, as in a horizontal position.

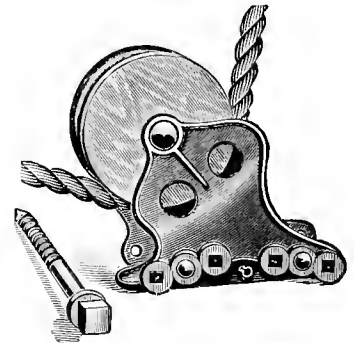

Fig. 364 (Palace)

Specifications

Fig. 364. Floor Pulley. Malleable iron frame. 4 $\frac{1}{2}$ -inch diameter sheave. Sheave made of hard maple seasoned in oil. Attaches to floor with lag screw. Weight, 5 $\frac{1}{2}$ pounds.

Price: \$6.67 per doz.

Louden Machinery Co., Fairfield, Iowa.
 Gentlemen:

I received the large Grapple Fork you shipped January 10th, which was in good condition. I am well satisfied with the fork. I have been handling short wheat straw. I was surprised to see the fork handle the loose straw so well, which means that I am more than satisfied with it.

Yours very truly,

Kelly E. Moye.

Ridgway, Ill. Feb. 9. 1914.



Some Special Pulleys

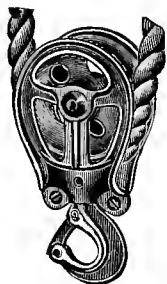

Fig. 366
(Togard)



Fig. 359
(Pointer)

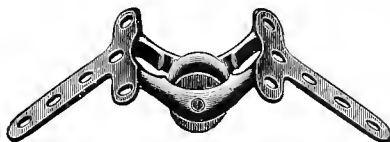

Fig. 435
(Perch)



Fig. 360
(Parasite)



Fig. 1139

Fig. 366 is our Fork Pulley used with all of our Fork Carriers except our Senior Carrier, Fig. 1100.

It has a 4-inch sheave and a strong malleable frame with safety hook that has the tubular swivel. Weight, $3\frac{3}{4}$ pounds. Price: \$.67

Fig. 359 is our Return Pulley with 3-in. wood sheave for $\frac{1}{2}$ -in. rope and smaller. Made the same as our High-grade pulleys on page 43. Weight, 1 pound. Price: \$2.00 per doz.

Fig. 435 is our Comb Pulley, for lifting cord to pass over, in the peak of barn. It has $1\frac{3}{4}$ -in. iron sheave. Weight, $\frac{1}{2}$ pound. Price: \$2.40 per doz.

Fig. 360 is our Malleable Case Check Pulley with $1\frac{1}{4}$ in. iron sheave. Built extra strong for $\frac{3}{8}$ -in. rope and smaller. Weight, 7 ounces. Price: \$1.20 per doz.

Fig. 1139 is our Fork Pulley used with our Senior Fork Carrier only. It has a 7-in. sheave made of special gray iron. Both Fork Pulleys are built on the same line as our high grade pulleys. Weight, $9\frac{1}{4}$ pounds. Price: \$1.00

Louden Snatch Pulley Block—Fig. 623

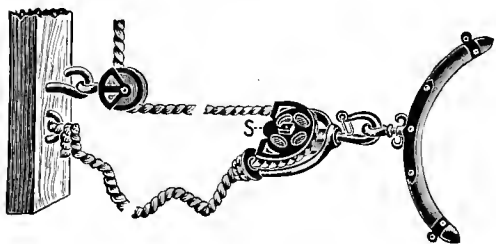

Fig. 623 (Pawn)

Specifications

Frame made of malleable iron.
 Rope wheel special quality gray iron.
 Rope wheel 4 inches diameter.
 Weight, $4\frac{1}{4}$ pounds. Price: \$6.67 per doz.

The Snatch Pulley Block shortens the distance the horse travels. After passing through the lower draft pulley, the end of the rope is made fast to the barn wall or a stake driven in the ground. Before making the end of the rope fast a washer should be slipped on and a knot tied in the rope, as shown in the illustration. The Snatch Pulley can then be put in place on the rope. One side of the pulley is open so the rope can be thrown off and on. When the load is pulled into the mow, the rope can be thrown off the pulley and the fork returned to the wagon without waiting for the return of the horse.

Cast Frame Pulleys

Fig. 522. Cast Frame Draft Pulley, 6-inch wood sheave, has large, loose pin, self-oiling axle. Weight, $3\frac{1}{4}$ pounds.

Price: \$2.13 per doz.

Fig. 729. Cast Frame Knot Passing Pulley, 6-inch wood sheave has large, loose pin, self-oiling axle. Weight, 4 pounds.

Price: \$2.67 per doz.

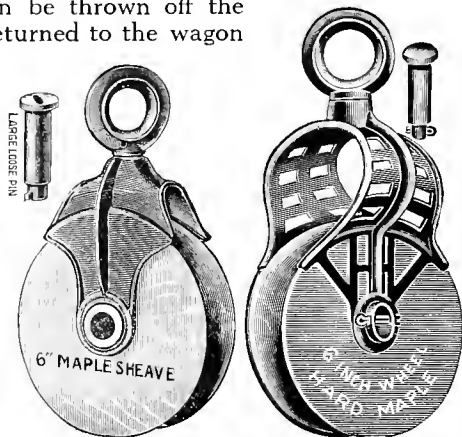

Fig. 522 (Presto) Fig. 729 (Peter)

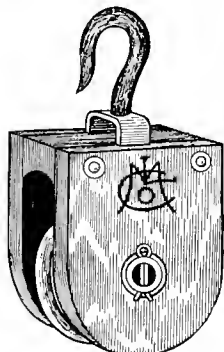

Fig. 641 (Ray)

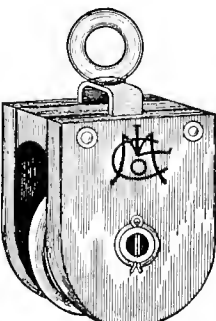

Fig. 642 (Frank)

Wood Frame Pulley—Reed Pattern

The frame is made of hard wood held together by rivets at the top. It is provided with wrought steel yoke to support the large, hollow, self-lubricating axle on which the sheave turns. Sheaves made of hard maple. A good strong pulley. Fig. 641 shows the pulley with steel hook. Fig. 642 shows pulley with malleable eye. Weight, $2\frac{3}{4}$ pounds. Price: \$2.67 per doz.



Louden Pulley Hooks, Etc.



Fig. 389 (Ensign) Fig. 390 (Envoy) Fig. 391 (Exile)

Fig. 389. Steel Floor Pulley Hook, $\frac{3}{4}$ x 7 inches.
 Weight, per dozen, 15 pounds. **Price: \$0.93 per dozen.**
 Fig. 390. Steel Rafter Pulley Hook, $\frac{5}{8}$ x 6 inches.
 Weight, per dozen, 10 $\frac{1}{2}$ pounds. **Price: \$0.80 per dozen.**
 Fig. 391. Steel Return Pulley Hook, $\frac{1}{2}$ x 3 $\frac{1}{2}$ inches.
 Weight, per dozen, 3 pounds. **Price: \$ 0.67 per dozen.**

Pulley Holders for Steel Track

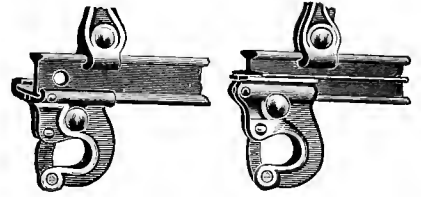

Fig. 469 (Province) Fig. 470 (Provost)

The Pulley Holders, Fig. 469 and Fig. 470, were designed for use with the Louden Weight Return, Fig. 529, page 15, and also at any other place where it is necessary to hang a pulley immediately underneath a Steel Hay Carrier Track.

Fig. 469 shows Pulley Holders for Single-Bead Steel Track.
 Weight, 1 $\frac{1}{4}$ pounds. **Price: \$0.17 each**
 Fig. 470 shows Pulley Holder for Double-Bead Steel Track.
 Weight, $\frac{7}{8}$ pounds. **Price: \$0.17 each.**

Both are made of refined malleable iron and are clamped to the steel track with heavy bolts.

How to Set Pulley Hooks

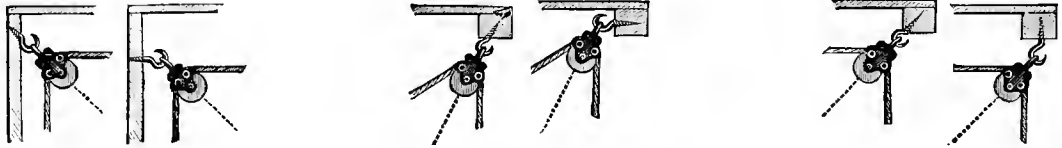

Pulley Hooks should always be set so they will stand straight with the line of draft, as shown by the dotted lines. When the pull is crossways it will bend the hook. Of the illustration above, the first, third and fifth are right; while second, fourth and sixth are wrong. It is the Cross Pull that bends or breaks the hook. A $\frac{5}{8}$ or $\frac{3}{4}$ hook put in right will stand more than a $\frac{7}{8}$ -inch hook put in wrong.

Louden Bracket Pulley Holder—Fig. 348

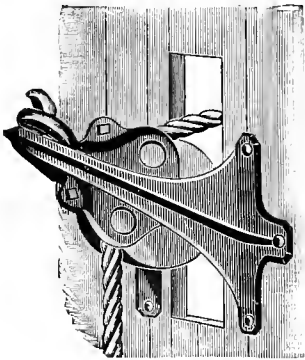

Fig. 348 (Pyramid)

Specifications

For supporting pulley for draft rope.
 Made of malleable iron.
 Will carry any common pulley.
 Weight, 3 pounds.
 Price: \$0.40 each.

Louden Bracket Pulley Holder is used to carry the draft rope out through the barn siding close to the eaves and carries the rope close to the mow so that the hay does not interfere with the rope or pulleys when the mow is full. The hole in the side of the barn is small and the pulley is up close to the eave and is always in the dry. Pulley can be put in or removed easily from inside of the barn. In barns where hay is taken in at one end or both ends, if the rope is run the nearest way to the ground from the end of the track, it reduces friction and requires less rope.

Please refer to Fig. 608, page 53, and Fig. 609, page 55, and note position of the Bracket Pulley Holder D. These show the proper use of the Bracket Pulley Holder. The holder supports the pulley and at the same time allows it to adjust itself in line with the draft. It also holds the rope free so it does not rub and wear on the timbers. To attach the holder, cut a hole in the barn siding 4 inches wide and 8 or 10 inches high. Bolt the holder in place as shown, so the hook will be even with the top of the hole. Bolts are furnished with the holder. This is an inexpensive article that should be included with every hay-unloading outfit for barns as described. The saving in the amount of draft rope required, the less amount of wear on the rope, and the reduced friction, make the Bracket Pulley Holder a profitable investment immediately.



Louden Hoisting Singletree—Fig. 344

Specifications

For use wherever hoisting is to be done with a horse.
 Body of hard wood.
 Trimmings of malleable iron.
 Weight, 6 pounds.
 Price: \$1.00 each.

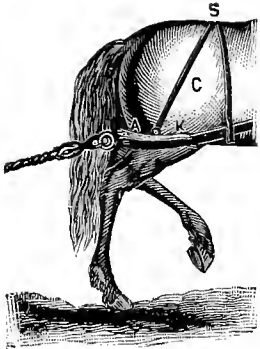

Fig. 344 (Prince)

The Louden Hoisting Singletree was designed for use anywhere that hoisting is to be done with a horse or team when the Singletree has no support. It is especially popular and desirable for use with the hay unloading rig at hay time. It is equally valuable for any kind of hoisting with horse power, plowing or cutting ice, plowing in orchards, vineyards or other places when the ends of the singletree is liable to injure the trees or vines.

The Singletree does not drag against the horse's legs, and the traces do not unhook or get under the horse's feet in backing or turning. The traces pass through keepers (K) and along back of singletree to hook in center. The Singletree being bent, this brings it close to the horse, like a breeching, without having to shorten the traces and it is held up by a cord (C), having a snap (S), which hooks into the trace carrier iron. The eye to which the draft rope is fastened is swiveled, which keeps it from kinking.

The Singletree saves much time. The horse can be turned short around and there is no chance for the horse to get over the traces. Also the rope is held up off the ground so the horse cannot step on it.

Louden's Spreader Attachment—Fig. 345

Fig. 345 shows our Spreader Attachment by which two Singletrees can be hitched together for use with a team. For ordinary hoisting purposes, we use a rope with a spreader and attach the hoisting rope to it at E, as shown by enlarged figure in center. For other work a chain may be used. There is no other rig equal to this for four or six horse teaming, as it does not strike the horses' legs and causes no weight whatever on the necks of the team behind. To attach Singletrees remove the hooks from ends of Spreader C, hook on Singletree and replace hooks and bolts. Weight, 5 pounds. Price: \$.67 each.

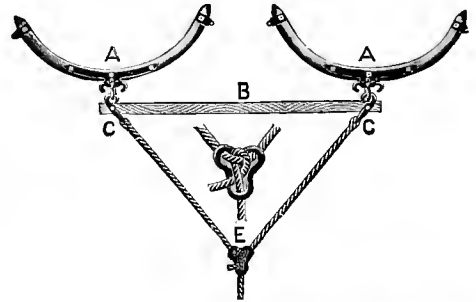

Fig. 345 (Pension)



Fig. 367 (Emery)

Louden Lightning Rope Hitch—Fig. 367

Made of Malleable Iron

For quickly connecting Singletrees or Doubletrees to draft rope. No time lost tying or untying knots in the rope. The rope is slipped through the hitch and the end bent around and slipped under itself. It can be

instantly attached or detached and will hold securely; also can be adjusted to lengthen or shorten the rope. It is provided with a safety hook which will not become unlatched. Weight, 1 1/8 pounds. Price: \$2.13 per doz.



Fig. 383 (Excelsior)
 Louden Swivel Rope Hook with safety latch.
 Weight 1/4 pound.
 Price: \$.17 each

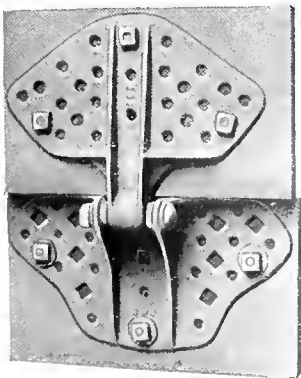

Louden Offset Hinges—Fig. 349

Specifications

For gable hay doors on barns. Weight (one hinge only), 2 pounds.
 Made of malleable iron. Price: \$.28 (one hinge only).
 Hinged together with heavy bolt.
 Weight full set fittings for gable door (2 hinges, 2 hooks and staples, 2 small hooks), 4 1/2 pounds.
 Price: \$1.33, full set fittings for gable door.

The Louden Offset Hinge was designed for use on the gable hay doors on barns. The hinge is made with an offset to allow the door to lap on the siding to shut out wind and rain. It is made of malleable iron and is very strong. Two hinges are sufficient for all ordinary doors. For extremely large, heavy doors three hinges should be used. The hinge is made wide to insure a solid bearing on the door and to give plenty of room for bolts and screws.

The gable hay door hung with our Offset Hinges, as shown in Fig. 349 is practical, cheap and easy to make. The door can be opened and closed with the hay carrier. This can be done from the ground either by hand or with a horse.



Louden Improved Hay Rack Clamps—Fig. 555

Specifications

For building Hay Racks of all sizes.
 U-shaped bolts are steel, $\frac{3}{8}$ inch diameter, 12, 14, 16,
 and 18 inches long.

Top washer and intermediate plate malleable iron.
 Clip washer of steel.

A set of clamps consists of the following:
 8 top washers "W"; 8 intermediate plates, "P";
 8 lower clip plates "C"; 8 U-shaped clamp bolts
 "B".

Weight, per set 12-inch bolts, 11 $\frac{1}{2}$ pounds.

Price: \$1.00 per set 12-inch bolts.

Weight, per set 14-inch bolts, 11 $\frac{3}{4}$ pounds.

Price: \$1.00 per set 14-inch bolts.

Weight, per set 16-inch bolts, 12 $\frac{3}{4}$ pounds.

Price: \$1.07 per set 16-inch bolts.

Weight, per set 18-inch bolts, 13 $\frac{1}{2}$ pounds.

Price: \$1.14 per set 18-inch bolts.

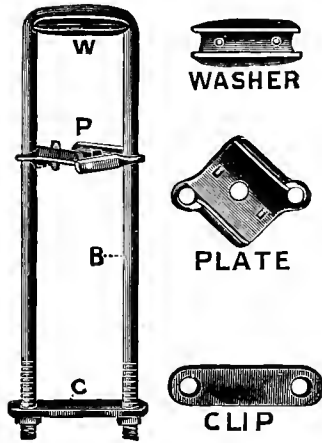

Fig. 645

By means of the Louden Hay Rack Clamps and Plates the timbers of the rack can be put together and securely held in position without having to bore holes in the sills or upper cross pieces. The rack can be built in one-half the time where the clamps are used and timbers are not weakened by having holes bored in them.

In illustration, Fig. 647, is shown a hay rack under course of construction, the main and cross sills having been clamped together. The washers are placed at the points "W", the intermediate plates at "P", and the clip plates at "C". There is no easier way or better place to build a hay rack than on the running gears of a wagon. No measuring will be necessary and the rack will always fit the bolsters.

Lengthen out reach until weight of the load will be evenly divided between front and rear axles; stand main sills on edge close up to standards; place cross sills in position and clamp the two together as shown in Figs. 646 and 647. The upper cross pieces should be set about two inches back from the ends of main sills in order that the intermediate plates may get a good, firm hold on the timbers. In this way any one can build a good rack in a short time, the only tools necessary being wrench and hammer. The rack will be about one-third stronger than if built in the old way, as the sills will not be weakened by holes, and the time saved will more than pay for the clamps.

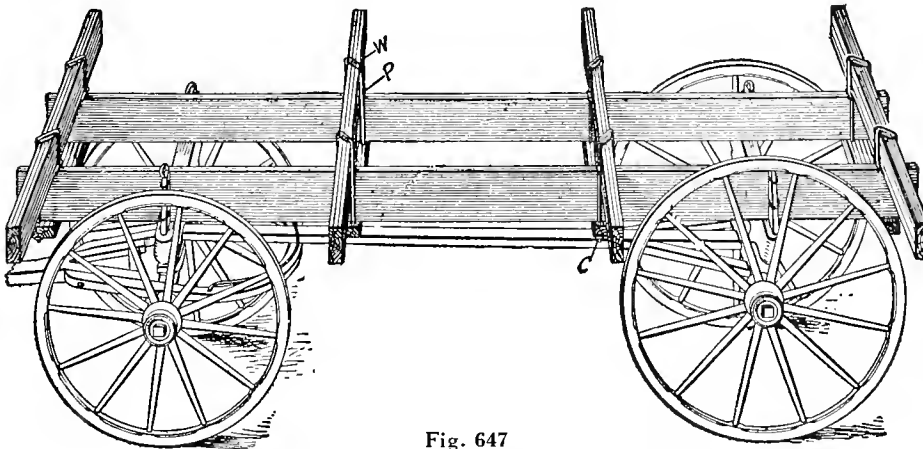

Fig. 647

Material Necessary for Sixteen-Foot Rack

- Two pieces 2x8, 16 ft. long for main sills.
- One piece 2x4, 16 ft long to be cut up for bottom pieces
- Four pieces 2x4, 7 ft. long for cross bars.
- Two pieces 2x4, 6 ft. long for front ladder.
- Four pieces 2x6, 6 ft. long for sides of rear wheel covering.
- Four boards 1x8, 16 ft. long for lengthwise pieces on sides.
- One board 1x6, 12 ft. long for tops of wheel coverings.
- Two boards 1x12, 16 ft. long for bottom of rack.

The above specifications cover material necessary for rack 7x16 feet to be used with our 14-inch clamps; but if it is desired to make a rack of different length or width the dimensions of the lumber must be changed accordingly. To build a rack with larger main or cross sills use the 16 or 18 inch clamps.

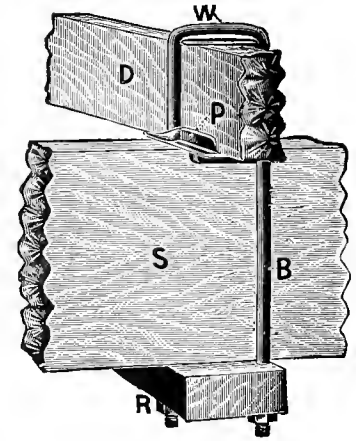

Fig. 646

The Intermediate Plates are of malleable iron and have heavy flanged edges or shoulders to fit over the edges of the main sills "S", and cross pieces "D", holding them firmly in position. These plates also have lugs or projections (two above and two below), that are driven into the timbers when the clamps are drawn down tight, thus preventing all rubbing or chafing and making it impossible for the sills or cross pieces to warp and get out of line.

The Top Washers are also of malleable iron and have a good, wide bearing surface to prevent them from cutting into the wood. The steel bottom plates are extra heavy and not only act as washers but prevent the bottom cross pieces from being split by a severe strain.



Louden Combination Rack Irons—Fig. 593

For Making Hay Racks, Hog Racks, and Wood Racks

Specifications

The castings D and H are of the best malleable iron. A set securely packed in a box consists of 8 holders D, 8 inside irons H, and 40 bolts; all $\frac{3}{8}$ diameter. They are packed with bolts for 8-inch side rails. The lower outside bolts are $5\frac{1}{2}$ and the lower inside bolts are 7 inches long. For 6-inch side rails change these bolts for bolts 2 inches shorter; and for 10-inch side rails, 2 inches longer. Weight, per set, 23 pounds. Price: \$2.33 per set.

They are most practical and serviceable rack irons. The iron D is a regular stake holder, provided with lugs or bars at the upper end between which the cross timber E of the rack is held by a bolt passing through the lugs and timber, as shown in Fig. 593. The castings are of the best malleable iron.

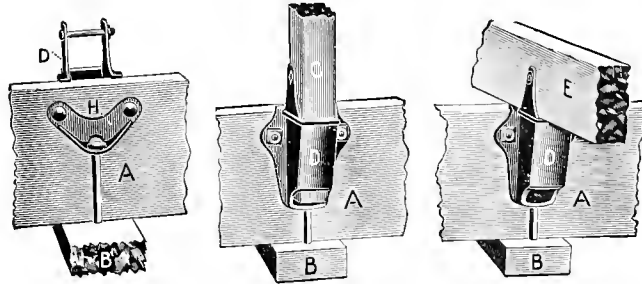

Fig. 593 (Fox)

Fig. 594

Fig. 595

In changing to a hog or wood rack the cross timber E is removed and the stake C inserted in the holder. It may be bolted there if desired, as shown by Fig. 594. The stake is set edgewise, which makes it much stronger than when set sidewise.

The bottom timber B, is held in place by two bolts, one on each side of the timber A. Figs. 593 and 594 show the outside bolt passed through the bottom of the holder D, and the timber B. Fig. 595 shows the inside bolt, supported by iron H. Castings D and H are clamped to opposite sides of the timber A by two common bolts. There is no chance for the timbers to spread apart.

Louden Stake Holders

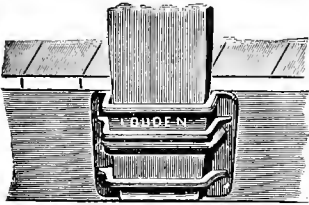

Fig. 398 (Santiago)

Fig. 398. Malleable iron. Rounded at the edges to prevent wear on the stake. Is held in place by a $\frac{1}{2}$ -inch clip bolt, furnished with each holder. Will receive stake $1\frac{5}{8} \times 3\frac{1}{8}$ inches. A very strong holder. Weight, $1\frac{1}{4}$ pounds. Price: \$2.67 per dozen.

Fig. 398 $\frac{1}{2}$. Malleable iron. Tapering and rounded at edges to prevent wear on the stake. Held in place by ordinary bolts (bolts not furnished with holder). Weight, $1\frac{1}{4}$ pounds. Price: \$1.60 per dozen.

Fig. 624. Steel stake holder. $2\frac{1}{2}$ inches wide, $\frac{1}{8}$ -inch thick. Will hold 2×3 or 2×4 inch stake, tapering at lower end. This holder is designed to bolt to the ends of the cross timbers on a hay rack, so the basket of the hay rack may be removed from the floor or attached to it at will. Weight, $1\frac{1}{2}$ pounds. Price: \$1.67 per dozen.

Fig. 627. Pressed steel stake holder. Is made from steel 3 inches wide and $\frac{1}{8}$ inch thick and holds stake $1\frac{1}{2} \times 3$ inches. The top is flaring and bent over to prevent wearing a notch into the stake. This is an inexpensive and durable stake holder. Weight, 1 pound. Price: \$1.00 per dozen.

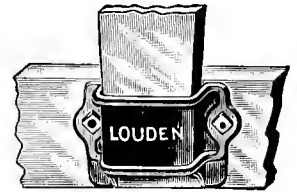

Fig. 398 $\frac{1}{2}$ (Tampa)

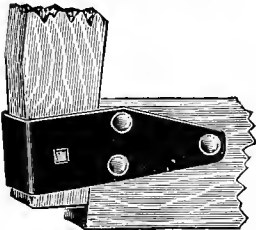

Fig. 624 (Bahama)

Pressed Steel Stake Holder



Fig. 627 (Beach)

Louden Self-Opening Ice Tongs

Specifications

Main body and tines are best crucible steel. Handle of refined malleable iron.

Riveted together with heavy non-rust rivets.

Points of tines tempered for sharpening.

Made in three sizes:

Fig. 426. 13-inch size. Weight, $2\frac{1}{2}$ pounds, Price: \$8.00 per doz.

Fig. 695. 17-inch size. Weight, $2\frac{3}{4}$ pounds, Price: \$8.50 per doz.

Fig. 696. 21-inch size. Weight, 3 pounds. Price: \$9.00 per doz.

The Louden Self Opening Tongs can be operated perfectly with one hand. When the hand is closed down on the handle the tongs open to their widest extent. When picking up a block of ice or other article, the weight of the article, when lifted, causes the tongs to hold fast and firm.



Fig. 426

13-inch. (Cardenas)



Fig. 695 17-inch (Mantanas)

Fig. 696 21-inch (Sharp)

The 13-inch tong is the popular size for household use, while the two larger sizes are used for heavier work. These tongs are excellent for moving small boxes, nail kegs, etc., in stores and warehouses.



Louden Wire Stretcher and Hoist

Specifications

Wire Stretcher—Fig. 448

Fitted with 16 feet of $\frac{3}{8}$ -inch sisal rope.

Weight, $5\frac{1}{4}$ pounds.

Price: \$9.33 per dozen.

Hoist—Fig. 806

Fitted with 16 feet of $\frac{3}{8}$ -inch sisal rope.

Weight, 3 pounds.

Price: \$9.33 per dozen.



Fig. 448
(Key West)



Fig. 806
(Mole)

The Loudon Wire Stretcher is the strongest tackle stretcher made. In stretching the wire the operator stands away from the wire, out of danger, while tightening the tension, instead of close up to it as with other stretchers.

The wire grips are fitted with raised flanges or guards which absolutely prevent wires from slipping under the eccentric grips. These grips are fitted with handle one-third longer than other stretchers, and have an offset curve, giving more convenience and greater power for setting the grip with the hand.

The rope grip is positive and will never slip, but will hold the wire at any tension, or a load at any height.

The wire grips never fail to hold. It is equally satisfactory for stretching barbed wire or woven wire. The frames of the pulley blocks are made of high-grade steel, and the fittings are the best malleable iron.

The iron rope sheaves are very smooth to prevent wear on the rope. They turn on special steel thimbles, insuring ease of operation and great strength. The stretcher is reeved with a full $\frac{3}{8}$ -inch rope, which is included with it.

A swivel at the end next the wire and away from the post lets the twist out of the wire but does not let the stretcher itself turn and tangle the ropes, as do stretchers having a swivel next to the post, or at both ends.

Fig. 448 shows the Loudon Perfect Wire Stretcher fitted with wire attachments.

Fig. 806 shows the same fitted with hooks for use as a hoist. This hoist has a 400-pound capacity. When in use the operator is away from the load instead of under it.

Fig. 807 shows Loudon's Perfect Wire Stretcher stretching and splicing barbed wire; while Fig. 808 shows same stretching woven wire fence, using two stretchers, one at the top and the other at the bottom of the fence.

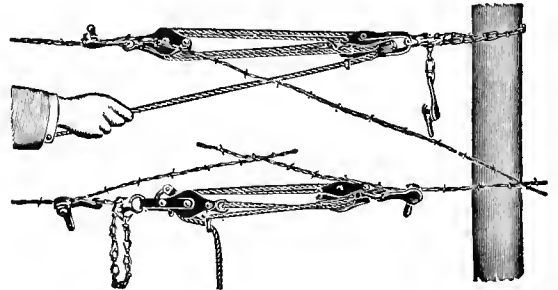

Fig. 807

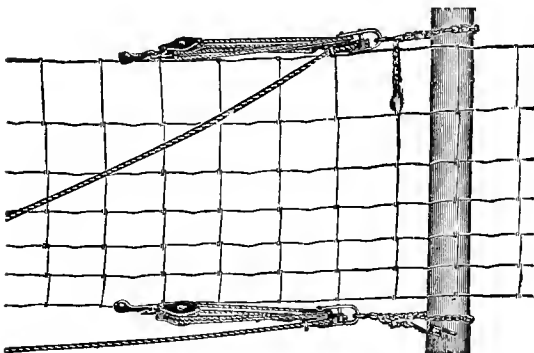

Fig. 808

Apison, Tenn., Aug. 1, 1914.

Louden Machinery Company, Fairfield, Iowa.
Gentlemen:

I beg leave to say that the outfit has given entire satisfaction and that I am much pleased with it. I have used other makes of hay forks but this is the best that I have ever seen.

It is the only fork in the community and has caused a lot of comment. The gentleman from whom I bought the farm came around to see it work. He had been handling over a hundred acres of hay every year with the back-breaking pitchfork method, and when he saw the fork work and the ease with which I filled my mow, he said, "That thing works like it had good sense." I told him that the man who made it had a good supply.

I shall always be ready to demonstrate the outfit to any of my neighbors, for I feel that it is the best hired man that a farmer can get. Thanking you for all favors, I am

Yours very truly, (Signed) J. L. Hinshaw.



Perfect Louden Hoists (Without Ropes)



Fig. 532 Single Sheave
 Weight, 16 $\frac{1}{4}$ pounds.
 Price: \$4.00



Fig. 533 Double Sheave
 Weight, 27 pounds.
 Price: \$4.67



Fig. 534 Triple Sheave
 Weight, 30 pounds.
 Price: \$5.33

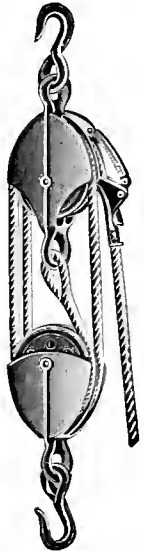

Fig. 449. Double Sheave Hoist Reeved or Roped Properly.

Perfect Hoist—Fig. 449

Fig. 449 shows our Perfect Hoist. It elevates, lowers, locks and unlocks with one rope only, giving the operator both hands to control the load. It works in any position—perpendicular, horizontal, or at right angle, and therefore can be used where others cannot. It is made in eight sizes, from 400 to 3,000 pounds capacity, as shown by the following table. Prices do not include rope.

No.	Sheaves Above	Sheaves Below	Diam. of Sheaves	Size of Rope	Lbs. Capacity	Lbs. 1 Man Can Lift	Code	Weight	Price
25	3	3	5-inch	$\frac{3}{4}$ to $\frac{7}{8}$	3000	700	Ruth	30 Pounds	\$5.33
27	2	2	5-inch	$\frac{3}{4}$ to $\frac{7}{8}$	1800	500	Eliza	27 Pounds	4.67
29	1	1	5-inch	$\frac{3}{4}$ to $\frac{7}{8}$	1400	400	Jennie	16 $\frac{1}{4}$ Pounds	4.00
31	3	3	4-inch	$\frac{1}{2}$ to $\frac{5}{8}$	2800	700	Emma	15 $\frac{3}{4}$ Pounds	4.00
33	2	2	4-inch	$\frac{1}{2}$ to $\frac{5}{8}$	1500	500	Elsie	11 $\frac{3}{4}$ Pounds	3.00
35	1	1	4-inch	$\frac{1}{2}$ to $\frac{5}{8}$	1200	350	Maude	9 $\frac{1}{2}$ Pounds	2.67
37	2	2	3-inch	$\frac{1}{2}$	800	400	Mabel	5 $\frac{1}{2}$ Pounds	2.13
39	1	1	3-inch	$\frac{1}{2}$	400	200	Bessie	4 Pounds	1.60



Barn Arrangements for Hay Tools

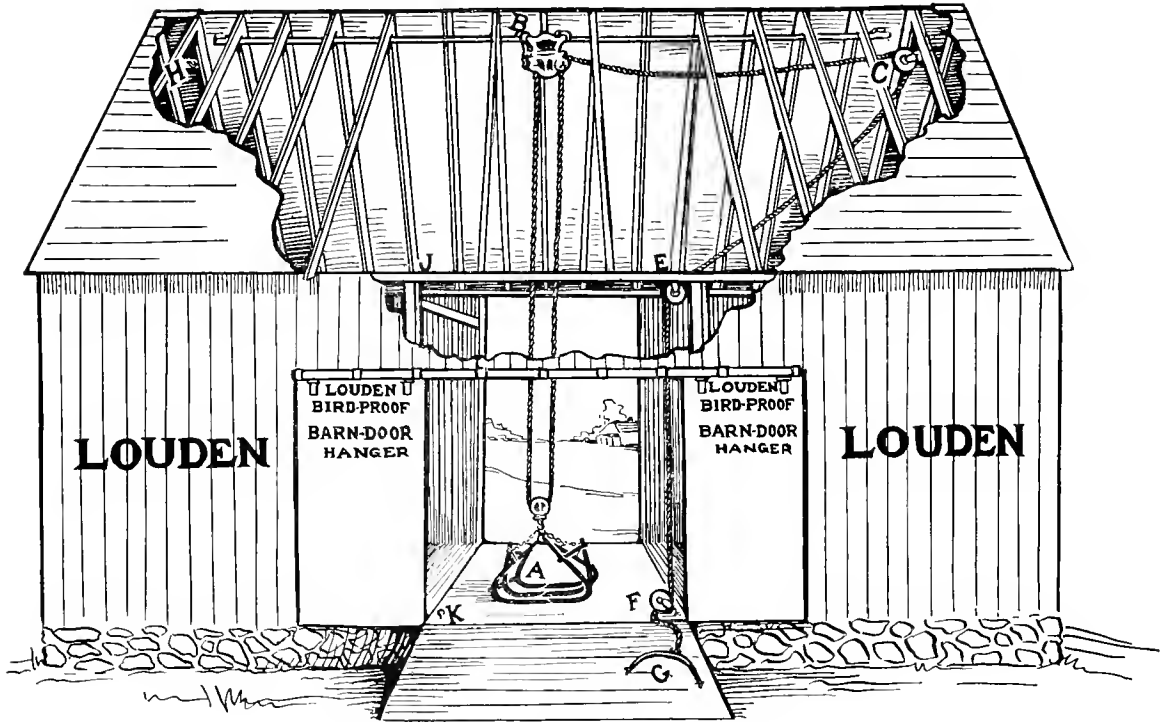

Fig. 607

Center Drive Barn

Fig. 607 shows how our Hay Tools are generally fitted up so as to take the hay from the driveway in the center and deposit it, first in one end of the barn and then in the other. The track should be 6 or 8 feet shorter than the barn. This will bring it within 3 or 4 feet of the ends of the barn, which is close enough. To make it good and strong, a hanger and bracket should be placed on each rafter, and for sling and other heavy work it is better to place them on both sides of the rafter, at the point where the hay is taken up.

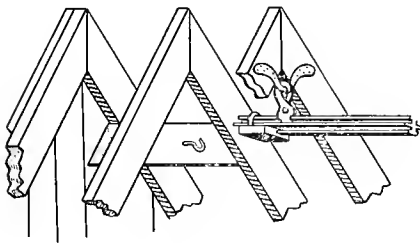

Fig. 617

A collar beam should be spiked to the second pair of rafters from each end, in which hooks are to be screwed for the Pulleys C and H, as shown in Fig. 617. This will bring the ends of the track within about a foot of the pulleys as shown in the cut. The collar beams may be 2x6, or 4x4—chamfered off thin at the ends so they can be properly spiked to the rafters. When a piece 2 inches thick is used, an inch piece should be nailed on the back of the center where the screw of the hook goes through, so as to make it 3 inches thick at this place. The collar beams should be about 4 feet long with the ends cut the slant of the rafters, or long enough so the pulley attached to it will let the rope run close to, but not rub on the under side of the track.

(Note—It is a poor plan to screw the hook into one of the rafters, as shown in some hay tool catalogs, because in heavy work it is liable to pull out a single rafter.)

To reverse the carrier, run the carrier into the trip lock at B, move the Pulley C to the other end of the barn at H, change pulley from E to J and pulley from F to K. A swinging pull on the rope leading down to the fork will swivel the lower frame of the carrier around and everything is then ready to work in the opposite mow. Only 3 pulleys are required, but it is well to always have an extra pulley or two on hand.

To get the length of the draft rope, double the distance from A to B when a Double Draft Carrier is used, then add the distances from B to C, C to E and E to F and allow 10 to 15 feet extra for the Singletree G. When a Triple Draft Carrier is used, treble the distance from A to B and add to it the distance from B to the Singletree G, and then add the length of the hay rack for Slings.



Barn Arrangements for Hay Tools—Continued

Specifications for Hay Fork Unloading Outfit with Swivel Connection for Center Hoist Barn, 60 feet Long

	Fig.	Page	Unit Price	Total
1 Louden Junior Fork Carrier	430	6	\$4.33 each	\$4.33
54 ft. Double Bead Steel Track	571	30	.12 per ft.	6.48
28 Standard Two-Part Hangers	498	30	1.00 per doz.	2.33
28 Standard Rafter Brackets	424	31	.48 per doz.	1.12
1 Standard 6-Tine Grapple Fork	351	32	6.67 each	6.67
3 High-Grade Knot Pulleys	467	43	4.40 per doz.	1.10
2 Floor Pulley Hooks	389	46	.93 per doz.	.16
4 Rafter Pulley Hooks	390	46	.80 per doz.	.26
*1 Hoisting Singletree	344	47	1.00 each	1.00
*1 Lightning Rope Hitch	367	47	2.13 per doz.	.18
Total				\$23.63

*The Hoisting Singletree and Lightning Rope Hitch may be omitted if desired, but they are handy and will soon pay for themselves in the convenience they add to the equipment.

We recommend the 6-tine Balance Grapple Fork as listed for all around work in all kinds of hay. Any other fork may be substituted if desired.

If a Wood Track outfit is wanted substitute a Louden Junior Wood Track Carrier (Fig. 441). Also substitute Wood Track Hanger Hooks (Fig. 780) for the Steel Track Hangers.

Specifications for Hay Sling Unloading Outfit for Center Hoist Barn 60 feet long

	Fig.	Page	Unit Price	Total
1 Cross Draft Hay Carrier	817	18	\$8.67 each	\$8.67
54 ft. Double Bead Steel Track	571	30	.12 per ft.	6.48
28 Standard Two-Part Hangers	498	30	1.00 per doz.	2.33
28 Standard Rafter Brackets	424	31	.48 per doz.	1.12
3 Carry-All Hay Slings	984	36	4.67 each	14.01
3 High-Grade Knot Pulleys	467	43	4.40 per doz.	1.10
2 Floor Pulley Hooks	389	46	.93 per doz.	.16
4 Rafter Pulley Hooks	390	46	.80 per doz.	.26
*2 Hoisting Singletrees	344	47	1.00 each	2.00
*1 Rope Spreader for Same	345	47	.67 each	.67
*1 Lightning Rope Hitch	367	47	2.13 per doz.	.18
Total				\$36.98

An End Hoist Barn

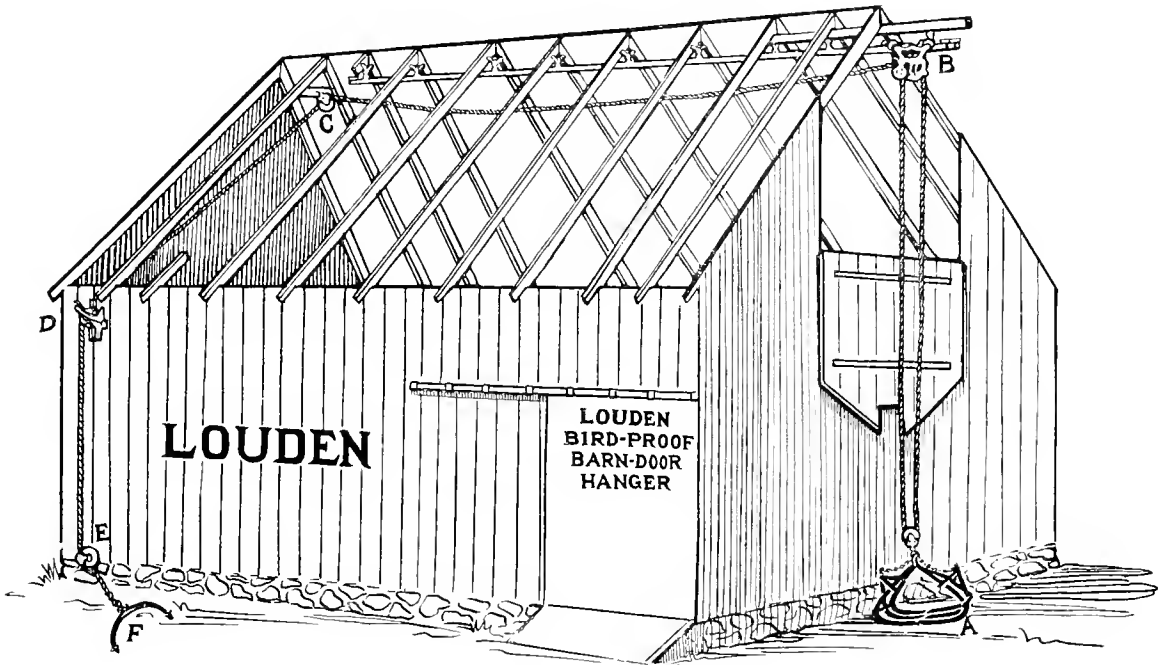

Fig. 608



An End Hoist Barn—Continued

Fig. 608 on preceding page shows a barn arranged to take the hay in at one end. The Hay Door, which is cut high up in the gable, should be large enough to take in the largest forkful or sling load without pulling off the loose hay to make litterings. When there is room it is well to make the door 8 to 10 feet wide and 10 to 12 feet high for a fork, and 10 to 12 feet wide and 12 to 15 feet high for Slings. Of course, doors a little smaller will do in a way, but the verdict of every one is "the bigger the better".

The track should extend out from three to four feet, according to the size of the barn and the door and whether a fork or slings are to be used. Generally the track should be about the same length as the barn, a pulley collar being used and the back end of the track running within three or four feet of the back end of the barn, as in Fig. 607. The extension support for the track should be good and strong according to the loads it has to carry and should extend out as far as the track, and back into the barn from two to four rafters, and be securely supported therein.

By using our Offset Hinges the door will effectually turn water at the bottom. It can be easily opened and closed with the carrier by removing the fork or sling and hitching the pulley to the looped rope secured by eye bolts to the top batten. A large door should have three hinges. This outfit requires three Draft Pulleys. A Bracket Pulley Holder should be used at D.

To get the length of Draft Rope double the distance A to B when a Double Draft Carrier is used, then the distance from B around by C and D to E, adding ten or fifteen feet more to the singletree F. For a Triple Draft Carrier treble the distance from A to B, and add the other distances as before, and the length of the hay rack for slings.

Fork Outfit for End Hoist

	Fig.	Page	Unit Price	Total
1 Louden Standard Steel Track Carrier	306	10	\$4.33 each	\$4.33
50 ft. Single Beaded Steel Track	584	30	.12 per ft.	6.00
26 Standard Two-Part Hangers	498	30	1.00 per doz.	2.17
26 Louden Rafter Brackets	424	31	.48 per doz.	1.04
1 Standard 6-Tine Grapple Fork	351	32	6.67 each	6.67
3 High-Grade 6-inch Draft Pulleys	468	43	3.67 per doz.	.92
1 Louden Bracket Pulley Holder	348	46	.40 each	.40
1 Steel Floor Pulley Hook	389	46	.93 per doz.	.08
1 Steel Rafter Pulley Hook	390	46	.80 per doz.	.07
*1 Louden Hoisting Singletree	344	47	1.00 each	1.00
*1 Louden Lightning Rope Hitch	367	47	2.13 per doz.	.18
Total				\$22.86

*The last two items may be omitted if desired, but we urge our customers to include them with the outfit as they are time and labor savers.

Any other hay fork may be substituted but we recommend the Grapple Fork for all kinds of hay.

Specifications for Hay Sling Unloading Outfit for End Hoist Barn 50 feet long

	Fig.	Page	Unit Price	Total
1 Iowa Sling Carrier	821	14	\$8.67 each	\$8.67
50 ft. Double Bead Steel Track	571	30	.12 per ft.	6.00
26 Standard Two-Part Hangers	498	30	1.00 per doz.	2.17
26 Standard Rafter Brackets	424	31	.48 per doz.	1.04
3 Standard 5-ft. Slings	666	37	2.53 each	7.59
3 High-Grade Knot Pulleys	467	43	4.40 per doz.	1.10
1 Bracket Pulley Holder	348	46	.40 each	.40
1 Floor Pulley Hook	389	46	.93 per doz.	.08
1 Rafter Pulley Hook	390	46	.80 per doz.	.07
*2 Hoisting Singletrees	344	47	1.00 each	2.00
*1 Rope Spreader	345	47	.67 each	.67
*1 Lightning Rope Hitch	367	47	2.13 per doz.	.18
Total				\$29.97

*The last three items specified, while not absolutely necessary, are handy time savers. They can be included or not as preferred.

Three slings, the number ordinarily used on each wagon, are specified. More slings should be ordered for more wagons. For heavy work we would recommend substituting the Carry-All Sling for the Standard Sling.



Double End Hoist Barn

Fig. 609 represents a long barn arranged to take the hay in at each end. It has hay door and track extensions at each end. The track runs continuously from one to the other. The track should be from 4 to 8 feet longer than the barn to provide for the extensions. The cut shows the Carrier and rope arranged to take the hay in at the right hand end.

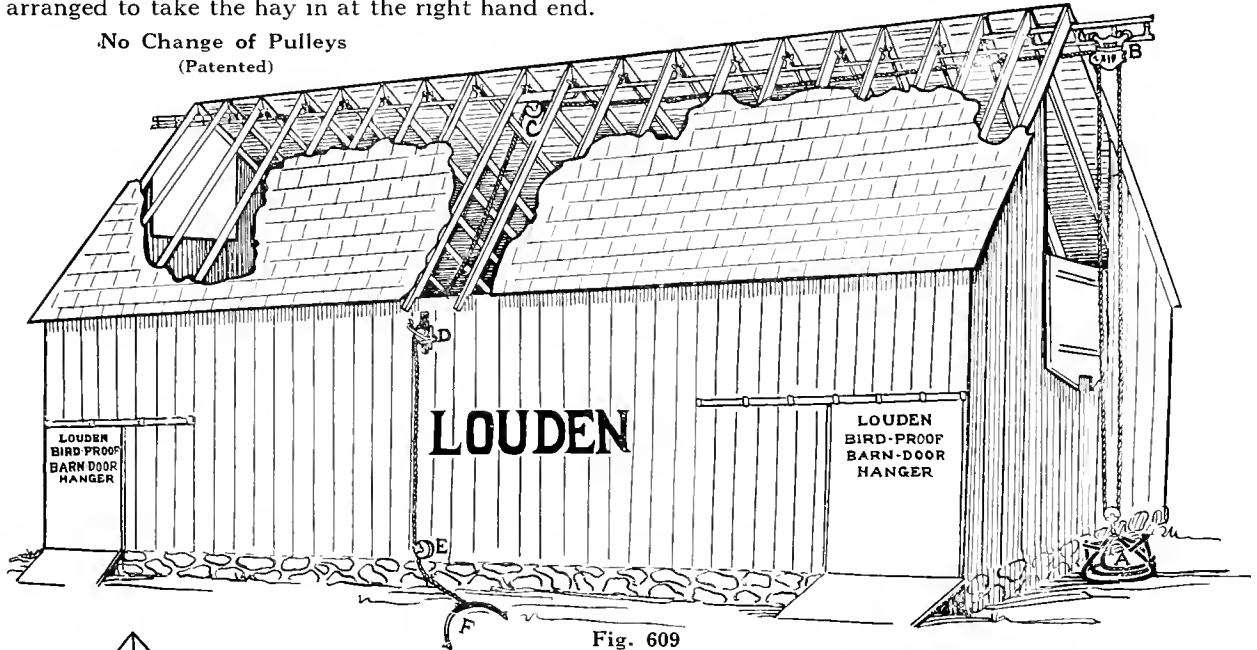

Fig. 609

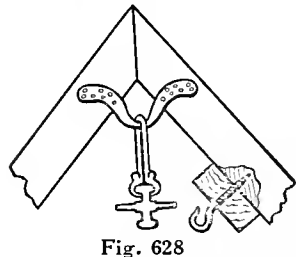

Fig. 628

When a Swivel Carrier is used all that is necessary to reverse it is to run the Carrier along the track from one end to the other and swivel it around. This can be easily and quickly done with the trip cord of the fork or sling. None of the pulleys have to be changed. This outfit requires three Draft Pulleys and is good for a barn 80 to 100 feet long. It is the easiest and quickest to reverse, requiring no change whatever of the rope or pulleys.

A Side Collar Beam is spiked to two or more of the rafters at one side of the track near the middle of the barn at C (more plainly shown by Fig. 628), so that the Carrier can run freely by it on the track. A hook for the pulley is screwed into this collar beam and the rope is run down to the side of the barn where it passes over the Pulley D hung on our Bracket Pulley Holder and then down to the Pulley E and Singletree F. A swivel carrier should be used and a track stop is required at each end.

To get the length of the draft rope double the distance from A to B and then add the distance from B to C, C to D, and D to E with 10 or 15 feet from the Pulley E to the Singletree F. For a Triple Draft Carrier treble the distance from A to B, adding the other distance to the Singletree F and the length of the hay rack for slings.

Specifications for Hay Fork Unloading Outfit for Double End Hoist Barn 80 Feet Long

	Fig.	Page	Unit Price	Total
1 Louden Junior Steel Track Carrier	430	6	\$4.33 each	\$ 4.33
86 ft. Double Beaded Steel Track	571	30	.12 per foot	10.32
44 Standard Two-Part Steel Track Hangers	498	30	1.00 per doz.	3.67
44 Rafter Brackets	424	31	.48 per doz.	1.76
1 Standard 6-Tine Grapple Fork	351	32	6.67 each	6.67
3 High-Grade 6-inch Draft Pulleys	468	43	3.67 per doz.	.92
1 Steel Floor Pulley Hook	389	46	.93 per doz.	.08
1 Steel Rafter Pulley Hook	390	46	.80 per doz.	.07
1 Louden Bracket Pulley Holder	348	46	.40 each	.40
1 Louden Hoisting Singletree	344	47	1.00 each	1.00
1 Louden Lightning Rope Hitch	367	47	2.13 per doz.	.18
1 Extra Track Stop for Carrier	1123	6	.33 each	.33
Total				\$29.73

If desired, substitutions can be made as set forth on previous pages, except that with this plan a Swivel Carrier must be used.



Double End Hoist Barn—Continued

	Fig.	Page	Unit Price	Total
1 Carry-All Sling Carrier	1103	12	\$10.00 each	\$10.00
88 ft. Double Bead Steel Track	571	30	.12 per ft.	10.56
45 Standard Two-Part Track Hangers	498	30	1.00 per doz.	3.75
45 Louden Rafter Brackets	424	31	.48 per doz.	1.80
3 Carry-All Slings	984	36	4.67 each	14.01
3 High-Grade 6-inch Draft Pulleys	468	43	3.67 per doz.	.92
1 Steel Floor Pulley Hook	389	46	.93 per doz.	.08
1 Steel Rafter Pulley Hook	390	46	.80 per doz.	.07
2 Louden Hoisting Singletrees	344	47	1.00 each	2.00
1 Rope Spreader for same	345	47	.67 each	.67
1 Louden Bracket Pulley Holder	348	46	.40 each	.40
1 Louden Lightning Rope Hitch	367	47	2.13 per doz.	.18
1 Extra Track Stop for Carrier	1123	12	.33 each	.33
Total				\$44.77

If more than one wagon is to be used put in additional slings.

Putting Up Hay Carrier Tracks

While a barn is being built and while the shingles or sheeting are within a couple of feet of the comb of the roof, is the best time to install a Hay Carrier Track. At this time it is an easy matter to do the work, as the sheeting forms all the scaffold necessary. To install a Hay Carrier Track after a barn is finished means doing the work from below by scaffold or ladder, depending on the height of the barn.

The track may be hung perfectly level or it may be given a slight incline, making it lower at the point where the track stop is attached and the hay is elevated. The track should always be hung straight and true, and close up to the peak of the barn, but allowing room enough below rafters for the Carrier to run freely. To do this stretch a line from one end of the barn to the other immediately below the peak of the rafters, and nail the Rafter Brackets to the rafters in a straight line.

The track should be taken up in sections and hung to the brackets and then spliced together. The Brackets and Track Hangers which support the track may be placed 4 feet apart for light work, but it is better to have a support from every rafter, and for heavy work a hanger and bracket should be put on each side of the rafters where the hay is taken up.

The bolts in the Hangers and Splice Clamps should be drawn up as tight as possible with a wrench, then strike the head of the bolt with a hammer so as to set it, and tighten up the nuts again. When this is done they will not get loose.

If the hay is to be taken in at end of barn, the track should be extended out $2\frac{1}{2}$ to 3 feet when Fork is used and 4 feet when Slings are used. In case the track is installed before the roof is finished, the best plan is to use a good 2x6 or 4x6 long enough to extend out as far as necessary and back in the barn to the third or fourth rafter. Let this extend between the rafters the same as a ridge pole. On this extension support or ridge pole, use our Ridge Pole Brackets.

The extension may be covered if desired. Cut a brace to reach from the outer end of the extension to a point on the rafters even with the side of the door and sheet and shingle over to this brace. This not only serves as a roof, but also as a brace for the extension.

About Rope

Many persons think they should use not less than 1-inch rope on a Hay Carrier. This is a mistake. Use the best grade of manilla rope and never use it heavier than $\frac{7}{8}$ -inch in diameter and $\frac{3}{4}$ -inch diameter rope is better. Do not be persuaded to use either a large or cheap grade of rope. Cheap rope is usually hard twisted and kinks badly. In our fifty years' experience with Hay Carriers we have learned that the $\frac{3}{4}$ -inch manilla rope is the best size to use and in no case should larger diameter than $\frac{7}{8}$ -inch be used. The Pulleys used with Hay Carriers are intended for these sizes of rope and larger will not work so well.

An inch rope should have not less than a 10-inch pulley, and when used on a smaller pulley the bend will be so short that the strands will wear themselves out rubbing on each other, besides it will cost nearly, if not fully, twice as much as three-quarter rope. According to government tests the following are the approximate weights and strength of new manilla rope:

	Pounds
Three-eighths inch trip rope	1,275
Half-inch rope, $12\frac{1}{2}$ feet weigh 1 pound; strength	1,760
Five-eighths rope, $7\frac{1}{2}$ feet weigh 1 pound; strength	3,140
Three-quarter rope, 6 feet weigh 1 pound; strength	3,970
Seven-eighths rope, $4\frac{1}{2}$ feet weigh 1 pound; strength	4,900
One-inch rope, $3\frac{1}{2}$ feet weigh 1 pound; strength	7,050



Round Barn—Fig. 1206

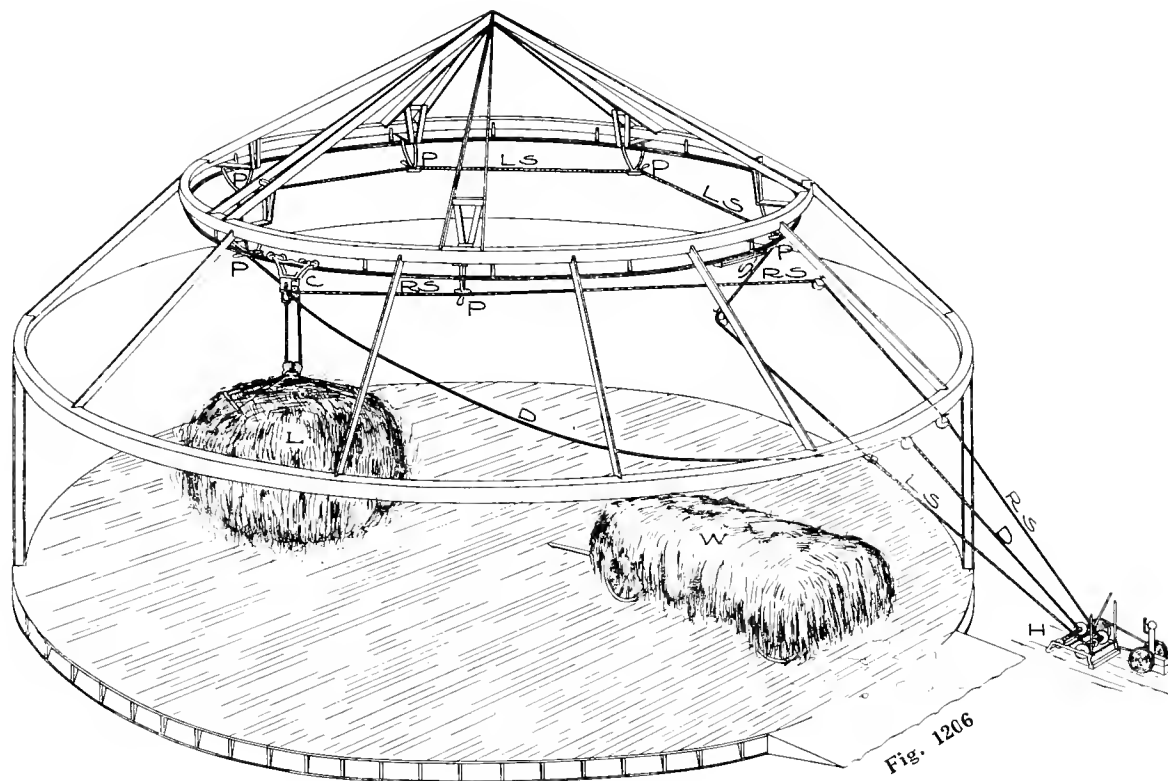

Fig. 1206 illustrates the common arrangement of track, guide pulleys, pulleys and ropes in a round barn and using gasoline engine and Louden Triple Drum Power Hoist for unloading. Also using the Louden Special Cross Draft Hay Carrier for Round Barn (see Fig. 1104, page 25).

The Draft rope D, on the Special Cross Draft Round Barn Carrier goes directly from the carrier to the hoist (or to the horse, if horse power is used). The draft rope D is used to elevate the load only and is *not* used to pull the carrier along the track. The carrier has an automatic rope lock. This lock will catch and hold the load at any height. It is not necessary to lift the load up to the carrier. As soon as the load is high enough to pass over hay already in the mow, the tension on the draft rope is released and the lock in the carrier will catch and hold the load suspended.

The carrier is then pulled along the track by means of the shift ropes LS and RS. In the illustration the ropes are arranged to carry the load to the left hand side of the wagon. The shift rope LS passes around parallel with the circle track and is held in place by the guide pulleys P and is finally carried through stationary pulleys to the left hand shift drum on the hoist. This shift rope is used for pulling the carrier to the left. When the sling load is tripped in the mow, the right hand shift rope RS is used to bring the carrier back to the release block S.

When the sling load is tripped in the mow the lock in the carrier does not release and the slings will not settle down until the carrier is brought back to the release block S. When the carrier strikes the release block, the rope lock is released and the slings come down to the wagon easily.

To reverse the carrier to carry the load to the right hand side, the position of the right and left shift ropes would be reversed and the right hand shift rope RS would be carried around in the guide pulleys parallel with the track.

In the illustration the hoist is shown just outside the building. The hoist can be located at any convenient place but preferably at some point where the man operating the hoist can watch the load of hay as it is being lifted and carried along the track.

In operating the rig with horse power, the arrangement of ropes would be practically the same as shown, except a weight would be attached to the return shift rope the same as in a rectangular barn. (See Fig. 822, page 19.)



Round Barn—Continued

Specifications for Hay Sling Unloading Outfit for Round Barn with Circle Track 30 feet in Diameter and Using Engine Power

	Fig.	Page	Unit Price	Total
1 Special Round Barn Hay Carrier	1104	25	\$11.00 each	\$11.00
94 ft. Double Bead Steel Track	571	30	.12 per ft.	11.28
(Bent to 30-ft. diameter circle)				
48 5-inch Link Track Hanger	832	30	1.06 per doz.	4.24
48 Beam Brackets	725	31	1.00 per doz.	4.00
3 Carry-All Hay Slings	984	36	4.67 each	14.01
6 Guide Pulleys	1135	26	4.00 per doz.	24.00
5 High-Grade Knot Pulleys	467	43	4.40 per doz.	1.83
5 Floor Pulley Hooks	389	46	.93 per doz.	.40
1 Triple Drum Hoist	1132	23	80.00 each	80.00
Extra charge for bending track			2.50 each	2.50
Total				\$153.26

Three slings are specified. This is the number of slings commonly used on one wagon. For more wagons more slings should be specified.

As a rule, round barns have large hay storage capacity and heavy equipment is desired for handling heavy loads. For that reason, we specify our best sling, the Carry-All. Any sling can be used with this rig and substitutions can be made to meet the ideas of the purchaser.

Specifications for Hay Fork Unloading Outfit for Round Barn having Circle Track 30 feet in diameter and Using Horse Power

	Fig.	Page	Unit Price	Total
1 Special Round Barn Hay Carrier	1104	25	\$6.67 each	\$6.67
94 ft. Double Bead Steel Track	571	30	.12 per ft.	11.28
48 5-inch Link Track Hangers	832	30	1.06 per doz.	4.24
48 Beam Brackets	725	31	1.00 per doz.	4.00
1 Standard 6-tine Grapple Fork	351	32	6.67 each	6.67
6 Guide Pulleys	1135	26	4.00 each	24.00
5 High-Grade Knot Pulleys	467	43	4.40 per doz.	1.83
5 Floor Pulley Hooks	389	46	.93 per doz.	.40
2 Hoisting Singletrees	344	47	1.00 each	2.00
1 Rope Spreader	345	47	.67 each	.67
1 Lightning Rope Hitch	367	47	2.13 per doz.	.18
Extra charge for bending track			2.50 per barn	2.50
Total				\$64.44

Other hay forks can be used, but we recommend the Grapple Fork as being well adapted for use with this outfit.

In the above lists, we specify the Beam Bracket, Fig. 725, for supporting track under purlin plate. If the track is to be suspended directly from rafters, the side rafter bracket, Fig. 675, should be specified.

Louden Cable Ricker Outfit

(See Pages 28 and 29)

For Stack 50 Feet Long

			Unit Price	Total
1 Louden Junior Cable Carrier	Fig. 621		\$4.20 each	\$4.20
1 Louden 6-Tine Balance Grapple Fork (page 32)	Fig. 351		6.67 each	6.67
140 feet $\frac{5}{8}$ -inch Galvanized Steel Wire Rope	Fig. 417		.61½ per ft.	9.10
2 High-Grade Draft Pulleys (page 43)	Fig. 468		.31 each	.62
2 Cable Loop Clamps	Fig. 337		.22 each	.44
4 Cable Stop Clamps	Fig. 337½		16.2½ each	.66
Total				\$21.69

The $\frac{1}{2}$ -inch size Galvanized Steel Wire Rope, Fig. 417 at 5½ cents per ft., or the $\frac{1}{2}$ -inch size Galvanized Wire Strand at 2⅔ cents per ft. may be substituted for the $\frac{5}{8}$ -inch size Wire Rope specified above if desired.

170 ft. $\frac{3}{4}$ -inch Manilla Draft Rope and 90 feet $\frac{3}{8}$ -inch Trip Rope would be required with this outfit. We can furnish highest quality rope at prices current when order is placed. As a rule rope can be purchased at a saving in local market.

We do not furnish poles.





(SECTION A)

LOUDEN BARN DOOR HANGERS



Louden Barn Door Hangers

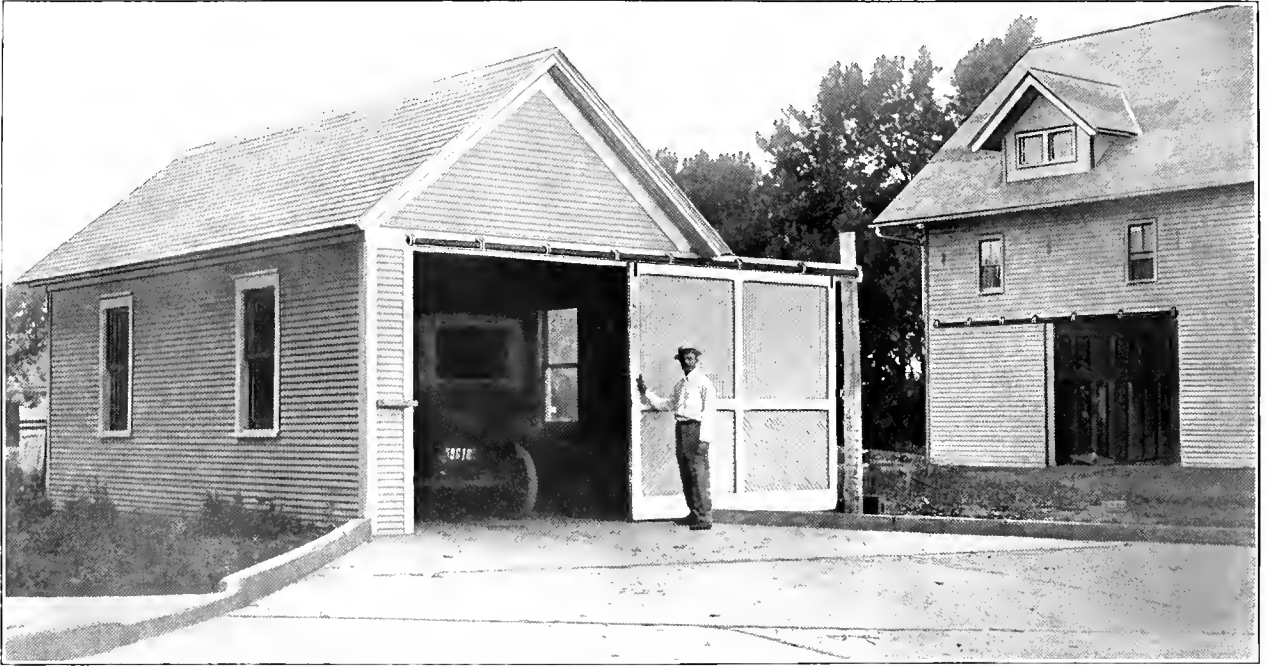

Louden Door Hangers are Ideal for Garage and Barn Doors

Louden Barn Door Hangers are for use with any door where it is desired to overcome the inconvenience and awkwardness of a swinging door. They are built to meet any requirements, no matter what size the door, or how essential it is to combine strength with neatness.

Exclusive features in Louden Barn Door Hangers make them desirable for barns, garages, outbuildings of all kinds, and for hanging factory or store fire curtains, or for "opening the whole side of the building," as is necessary for some air-dome theaters, band stands, freight houses, tobacco sheds, etc.

Doors hung with Louden Hangers open and close easily and with little noise. They will stand up under heavy, continuous work and will give complete satisfaction.



Louden Bird-Proof Barn Door Track and Hangers—Fig. 911

Specifications

For all kinds of doors, large and small.
 Track is tubular and trolleys travel inside.
 Trolley cannot get off the track.
 Track is made of No. 14-gauge special steel.
 Dimensions of track inside, $1\frac{5}{8}$ inches wide by $2\frac{1}{8}$ inches deep.
 Supporting brackets for track of steel with embossed reinforcements.
 Wall brackets of refined malleable iron.
 Supporting wall brackets may be placed 36 inches apart, for heavy doors, space 24 inches apart.
 End stops and splices for track packed with trolleys.
 Track is furnished in 6-ft., 8-ft., and 10-ft. lengths.
 Weight of track per foot, $1\frac{3}{4}$ pounds.
 Weight of supporting brackets per dozen pair, 9 pounds.
 Price of Track per 100 feet: \$13.33
 Price of Supporting Brackets for Track per dozen pair: \$1.00

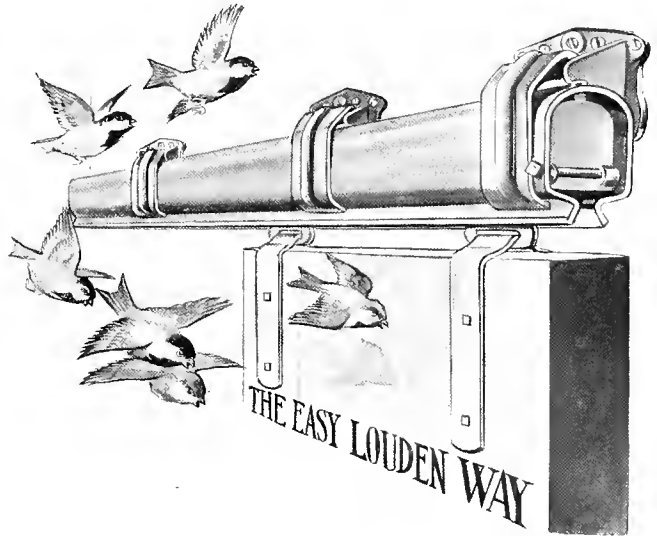

Fig. 911

Special Features

Trolleys Completely Enclosed. The only opening is the narrow slit beneath the track. There is no chance for the trolleys to be clogged or derailed. The track is absolutely proof against nesting birds, trash, rain, snow or sleet.

Flexible at Two Points. The joint in the hanger strap allows the door to swing out away from the building, frequently avoiding breakage by crowding stock. The joint in the track support permits the track itself to swing out from the building, making it possible to easily dislodge trash and dirt which may accumulate behind the track and rot out the siding. This double flexibility allows the door to fit snugly without sticking or binding.

Roller Bearing Tandem Trolleys. The Trolley Wheels revolve on hardened steel roller bearings around a tempered steel shaft. Always roll easily. A push will open or close the heaviest door.

Trolleys Run on Level Tread. The Bird-Proof Track is square, not oval. The level tread reduces friction to the minimum and overcomes the wedging tendency frequently found in oval tracks which support heavy doors.

Simple and Strong in Construction. The form of the Bird-Proof Track, and the special grade of steel used in its manufacture, combine to give it wonderful strength and rigidity. It is further strengthened by the curved lips on the under side of the track. Will not sag under the weight of heavy doors.

Door Hanger Trolleys—Fig. 902

Specifications

Frame of trolley of pressed steel with embossed reinforcements.
 Supporting loop for strap that carries door of refined malleable iron.
 Straps that carry door of No. 12 gauge steel, $1\frac{3}{4}$ inches wide.
 Straps are furnished regular for doors $1\frac{3}{4}$ inches thick.
 Track wheels are of special quality gray iron.
 Track wheels are 2 inches in diameter and are roller bearing. (See Fig. 19A and B, Page 63.)
 Bolts for attaching hangers to doors, also end stops and splices for track are packed with each set of trolleys.
 Each set of hangers packed in neat paper box.
 Weight per dozen sets, 72 pounds.
 Price: \$16.00 per Dozen Sets

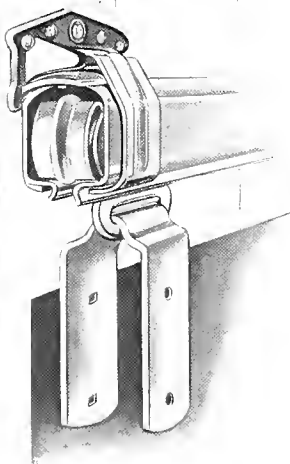
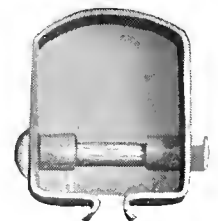

Fig. 961

Showing End View of Track with End Stop Removed



Metal End Stop Completely Closes Track



Louden Bird-Proof Barn Door Track and Hangers—Continued

We believe this to be the neatest, strongest, easiest operated, and most serviceable barn door hanger on the market. It has been in use on thousands of barns and we have heard nothing but good words spoken of it. You can make no mistake in choosing Bird-Proof. It will give you perfect service.

The Track

The track of the Bird-Proof Hanger is made from a solid sheet of steel pressed into shape. The ends are closed by special end stops, bolted in. The track is completely enclosed, with the exception of the narrow slit at the bottom for the hanger strap to work in.

The lips of the track on each side of the slit are curved downward and outward. This feature gives strength and stiffness to the track and insures an even surface on which the wheels run.

The track is made in standard sections of 6, 8, and 10 feet long. When two or more sections are used, the ends are held together by a steel splice. The splice is put on without rivets or bolts and holds the sections firmly so they can never spread apart. **No other track on the market has this feature.**

Support of the Track

The track is supported by heavy steel brackets bent to fit snugly around the track and close up to the lips on the under side. A heavy corrugated rib in the center reinforces them strongly—they will never spread and the track cannot sag under the weight of the heaviest doors.

The brackets are hung to heavy, malleable iron wall fixtures which are bolted to the wall and support the track in the proper position. The connection between the brackets and wall fixtures is flexible and allows the track to swing freely out sidewise—one of two points of flexibility in this hanger.

Fig. 961 shows how closely the brackets fit around the track, how the trolley wheel fits into the groove of the track and how the lips of this groove curve out.

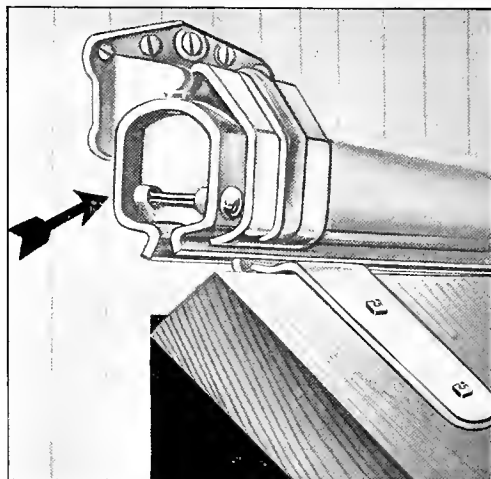

Fig. 918

Flexibility of Track

Fig. 918 shows the track hanging in normal position, but with the door swung partly out. This is the flexibility for which there is the most common need. It saves many a break from crowding stock and the free swing prevents the door from sticking and binding in sliding past an uneven wall.

The arrow points to the narrow space between the track and the barn siding which sometimes fills up with trash and dirt. With an enclosed track nailed or fastened solid to the wall the dirt cannot readily be cleaned out, and when wet will rust the track and rot the barn siding.

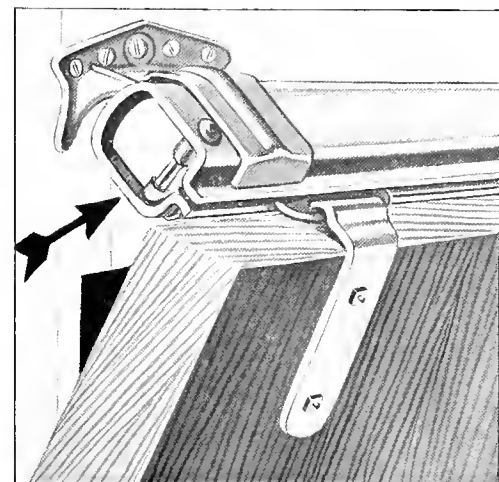

Fig. 683

The Louden Flexible Bird-Proof Hanger is the only one that perfectly overcomes this serious fault. Fig. 683 shows how, by simply pressing outward on the door from the inside, the track may be swung out to allow the trash and chaff to drop out. This may be done instantly and easily without gouging it out with a pitchfork or other tool.

The Splice for Louden Bird-Proof Track

In Fig. 895 is shown the splice clamp for holding the ends of the track, together. No. 1 shows the splice clamp standing on edge on top of the track and ready to be placed in position.

No. 2 shows the splice in position and the steel bracket pushed partly over it. It will be noted that in No. 1 and No. 2 the malleable bracket which attaches to the barn wall



Louden Bird-Proof Barn Door Track and Hangers—Continued

is turned away from the wall. In this position the bracket will easily slip over the splice.

In No. 3 the bracket is slipped entirely over the splice and is turned the other way and fastened to the wall. In this position the bracket binds down on the splice, holding it just as firm and solid as though it were riveted or bolted in place. This is a valuable and important feature, as the splice absolutely prevents the ends of the track from separating and making a rough place in the track, or possibly allowing the trolley to drop out. The Louden Bird-Proof Track is the only tubular track having this valuable feature.

Galvanizing

At a small additional cost the Bird-Proof Hanger may be furnished galvanized if desired. We have our own galvanizing plant. By this process steel or iron is covered with a heavy galvanized coating which protects the metal from rust and corrosion and gives it a longer life of service.

The Trolleys

The Louden Bird-Proof Hanger has a set of two tandem trolleys. Each trolley has two solid iron wheels, fitted with improved roller bearings and revolving on a tempered steel shaft. These wheels are carried in a heavy double truck frame of steel with a corrugated rib to strengthen it. The wheel shafts are riveted firmly into this frame at each end, and can never work loose or get out of order. Our patent revolving washer protects the bearings from wear, reduces friction and adds years of life to the service of the hanger.

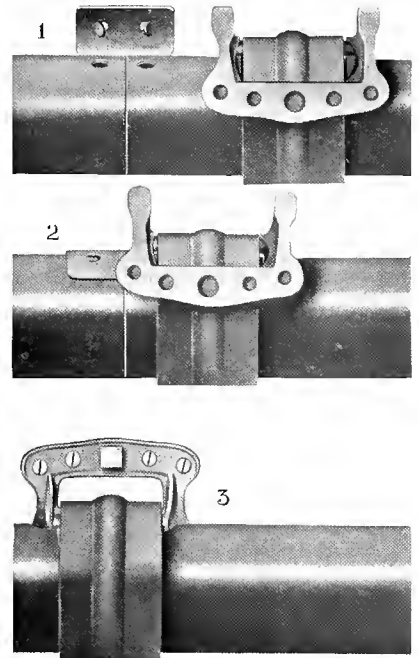

Fig. 895

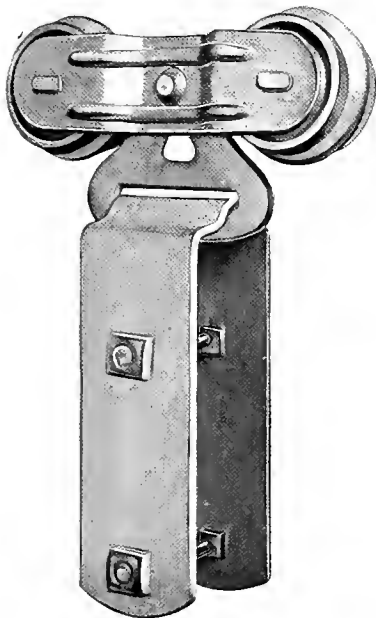

Fig. 902

Roller-Bearing Tandem Trolley

The supporting parts are of heavy malleable iron, riveted to the truck frame midway between the two wheels. This malleable support comes down just below the lips of the track and carries a broad steel strap which attaches to the door. This is the second point of flexibility in the Louden Bird-Proof Hanger, and allows the door to swing freely sidewise. (See Fig. 902.)

View B is an end or edgewise view of one wheel, showing the rib or bulge in the center of its face. This rib fits neatly into the slot in the track (See Fig. 961) and keeps the wheels always in perfect alignment; they can never wobble from side to side and bind or rub against the side of the track. View C shows the roller bearings of the wheels.

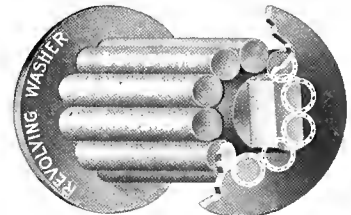
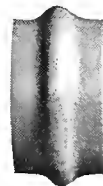
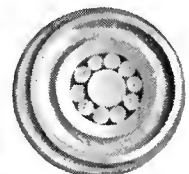

Fig. 19

Detail of Roller Bearing



View B



View C



Louden Bird-Proof Track Adjustable Trolleys

Fig. 1052

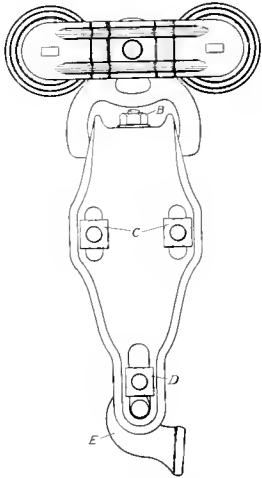

Fig. 1052

Adjustable hangers permit door to be adjusted $\frac{3}{4}$ inch both lateral and vertical.

Frame of trolley of pressed steel with embossed reinforcements.

Strap or casting that carries door of refined malleable iron.

Adjustable feature permits use of hangers on doors from $1\frac{1}{2}$ to 3 inches in thickness.

Track wheels are of special quality gray iron.

Track wheels are two inches in diameter and are roller bearing. (See Fig. 19 B and C, Page 63).

Bolts for attaching to doors, also end stops and splices for track are packed with each set of hangers. Each set of hangers packed in neat paper box. Weight, per set, $6\frac{3}{4}$ pounds. Price: \$16.00 per doz. sets

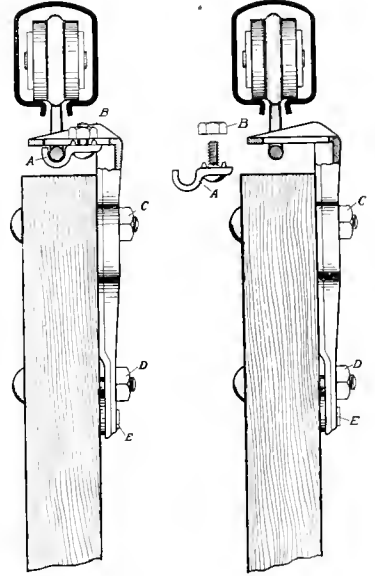

Fig. 1053

1053A

The Louden Adjustable Hanger for Bird-Proof Barn Door Hanger is without doubt superior to other hangers where conditions make an adjustable hanger necessary. One man with a monkey wrench can quickly and easily adjust the hangers so that the door will clear frost-swollen ground that would make the door rub at the bottom, or make the door hang true where the siding or joists have become warped out of shape. The Louden Adjustable Hanger makes it possible for one man to hang the heaviest door, as the trolleys are run into the track before being attached to the door.

Fig. 1052 shows front view of Adjustable Hanger. By turning the eccentric (E) with a wrench, the door may be raised or lowered as desired. The bolts (C and D, Figures 1052 and 1053) when nuts are loosened allow the door to be adjusted up and down, while the bolt (B) (Fig. 1053) permits the door to hang closer or farther from the barn as desired.

Fig. 1053A shows how the door is "hooked" into the trolley-strap. This is the feature that makes hanging a door an easy task.

Louden Bird-Proof Garage Door Hangers—Fig. 1202

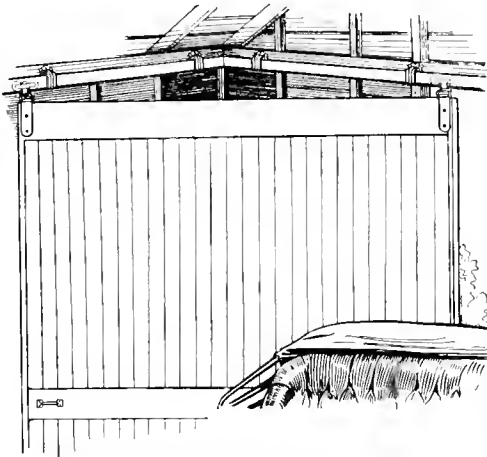

Fig. 1202

The Louden Garage Door Hanger is the same in every particular as the regular Bird-Proof Hanger, except that the trolleys are mounted on swivel trucks. The track is hung inside the door and a section the same length as the door is run along the inside side wall of the building.

Fig. 1202 shows the position of the door when it is half way open (or closed) at which time the door extends out into the garage the greatest distance. If the garage is very short, two doors can be used instead of one, thus reducing the space necessary for opening or closing doors.



Fig. 1202A

Swivel Trolleys for Garage Door Hangers
Price: \$16.00 per doz. sets

Double Bracket for Bird-Proof Track—Fig. 1204

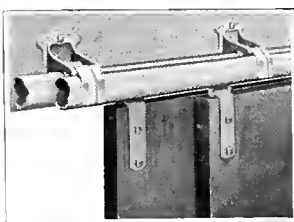

Fig. 1204

It is often necessary to hang doors in such a way that one can slide past the other. For such arrangements we furnish a double track support from which two tracks may be hung, one just outside the other. The doors hang true; there is no waste space.



Louden Covered Bird Proof Barn Door Track Fig. 1200

The Louden Covered Bird-Proof Door Hanger Track is the heaviest, strongest, and neatest barn door track made. The tube in which the trolleys travel is made from a single sheet of 14-gauge steel pressed into shape. The tube is $1\frac{5}{8}$ inches wide and $2\frac{1}{16}$ inches deep inside and is exactly the same as the regular bird-proof track described on page 61.

The track is completely enclosed except the narrow opening at the bottom for the hanger strap to work in. The lips of the track on the bottom bend downward and outward making a strong support for the trolleys and also preventing any dust or moisture from getting in the track. The trolleys travel on a level tread and there is no opportunity for the track to spread or bind on the trolleys.

The cover being attached to the top and side of track by a process of electric welding, makes it conform readily to its shape and renders it absolutely strong and rigid.

The cover has an embossed reinforcement every 9 inches which adds greatly to its strength. At the extreme upper edge of the cover the edge is bent sharply toward the building. When the track is made fast to the barn this upper edge presses into the barn siding, and no water or moisture can get behind the track. One inch of the upper edge of the cover lays flat against the barn wall and is provided with holes to receive the lag screws for making it fast.

The track is rigidly attached to the barn wall and in this respect it differs from the regular bird-proof track, which is flexibly hung. The lower edge of the cover extends below the upper edge of the door. All water and moisture is turned to the outside of the door and the track and the upper edge of the door are completely protected from the weather.

The back side of the main track has embossed knobs or buttons to hold the track away from the building. (See Fig. 1201.) This allows an air space between the track and the building, with no opportunity for moisture to accumulate and rust the track or rot the barn siding.

The ends of the track are closed with steel stops bolted in. (See Fig. 918, page 62.) There is no opportunity for trash, dirt or weather to reach the trolleys. The track is always clear and heavy or light

doors travel easy, smooth and true. To the man who desires practical utility, long and perfect service, a neat and attractive design in a barn door track, the slight extra cost of this track as compared with others on the market will always be remembered as a good investment.



Fig. 1200

Specifications

- For all kinds of doors, large and small.
- Track is tubular and trolleys travel inside.
- Trolleys cannot get off the track.
- The regular Bird-Proof Hanger, Fig. 902, or Bird-Proof Adjustable Hanger, Fig. 1052, operates in this track.
- Body of track is made of No. 14 gauge special steel.
- Dimensions of track inside, $1\frac{5}{8}$ inches wide by $2\frac{1}{16}$ inches deep.
- The tubular track has a steel cover made of No. 18 gauge steel, and being attached by an electric weld, forms a part of the track making it absolutely strong and rigid.
- Embossed reinforcements every nine inches give great strength to the cover.
- Cover is made fast to barn wall with lag screws.
- Upper edge of cover is provided with holes for lag screws for attaching to barn wall.
- Lag screws for attaching track to barn are furnished with the track.
- Lower edge of cover extends down beyond the upper edge of door so rain and snow cannot blow under.
- The extreme upper edge of cover bends sharply toward wall. When track is in place this edge presses into the barn wall preventing moisture from penetrating behind the track.
- The back side of the main tube is provided with embossed buttons which hold the track away and allow an air space between the track and the wall.
- Track is furnished in 4-ft., 6-ft., and 8-ft. lengths.
- Price of Track per 100 Feet (including lag screws): \$18.00

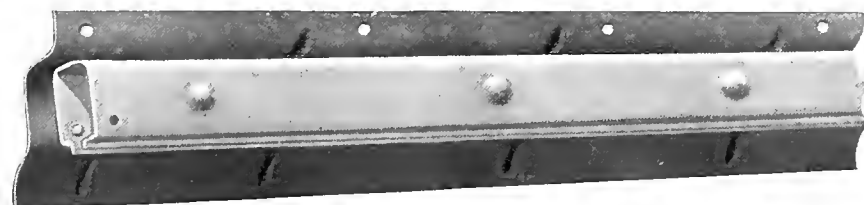

Fig. 1201. Rear View of Covered Bird-Proof Track



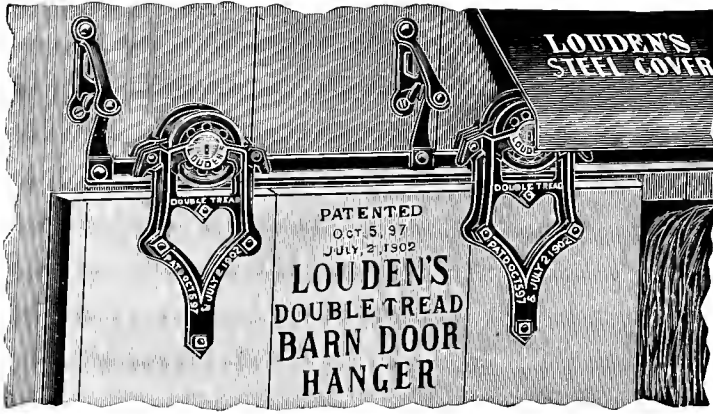

Fig. 458

Specifications

Track

For all kinds of doors, large or small.
 Track is an inverted steel T-rail.
 Width of track 1½ inches.
 Track hooks are of refined malleable iron and are riveted solid to the track.
 Wall brackets are of refined malleable iron.
 Track hooks engage eyes in the wall brackets making the track flexible, a very valuable feature.
 Wall brackets and track hooks are furnished with the track.
 A steel splice clamp is attached to one end of each section of track.
 The opposite end of track section is punched to receive splice and rivet.
 Rivets for splice clamps are packed in box with trolleys.
 Track is furnished in 6 ft., 8 ft., and 10 ft. lengths.
 Weight of track per foot (including track hooks and wall brackets), 1½ pounds.
 Price of track per 100 feet (including track hooks and wall brackets): \$8.00

and ready to go. There is an absolute center draft; no side hitch and throw the door out of plumb.

The four wheels which carry the weight of the door are fitted with turned and tempered steel roller bearings. Ten of these bearings revolve about a turned and tempered steel shaft.

Door Hanger Trolleys

Frame of trolleys of refined malleable iron.
 There are four trolleys with each set of hangers.
 Track wheels are of special quality gray iron.
 Track wheels are 2¾ inches in diameter and are roller bearing.
 Wheels travel on opposite sides of the inverted T-rail, giving a perfect center draft.
 Suitable for use on doors from 1½ to 2 inches in thickness.
 Bolts for attaching to doors packed with each set of hangers.
 Each set of hangers packed in neat paper box.
 Weight, per set, 6 pounds.
 Price: \$11.20 per dozen sets.

Track for Double-Tread Hanger

The track is a special T-rail of high carbon steel. Will not sag or break with the heaviest door. The hooks and brackets are of refined malleable iron.



Fig. 452 (Evans) Louden Double-Tread Track

The sections of track are securely spliced together; not simply butted together as is frequently the case with cheaper tracks. Cannot become uneven or spread apart at the joint. Made in 6, 8 and 10 foot lengths.

Louden Double-Tread Barn Door Track and Hanger Fig. 458

The Double-Tread was the pioneer Flexible Barn Door Hanger, and continues to be one of the leading hangers in the market. It is compact, durable, and serviceable, simple and strong in construction and sure in its operation. Thousands of these hangers which have been in constant use for many years are still rendering faithful, efficient service—never a hitch in their operation; not a cent paid out for repairs.

Construction

The Double-Tread is in reality two sets of hangers—a set on each side of the door fitted to run on opposite edges of an inverted T-rail. The track is flexibly hung to brackets secured to the wall, and will accommodate itself to the inequalities of the barn siding. The door can be closely fitted without danger of sticking or binding on account of the warping of door or siding. This feature gives it a decided advantage over all rigid hangers. The track, being a T-rail, takes up the least possible room, and the hanger frame is consequently shortened and straightened.

The parts of the hanger being clamped solidly together on both sides of the track makes it impossible for the trolleys to jump the track. The door is always in place

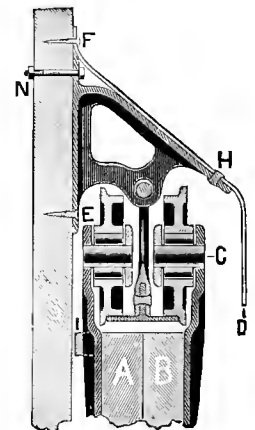

Fig. 453
 Sectional View



Louden Double-Strap Covered Jointed Barn Door Hanger—Fig. 566

Specifications

Frame of trolley of refined malleable iron.
 There are two trolleys with each set of hangers.
 Track wheels are of special quality gray iron.
 Track wheels are 3 inches in diameter and are roller bearing.
 Track wheels are protected from weather and trash by a heavy malleable iron hood.
 Straps which attach to the door are of No. 12 gauge steel, $1\frac{1}{8}$ inches wide.
 Bolts for attaching to doors packed with each set of hangers.
 Each set of hangers packed in neat paper box.
 Weight, per set or pair, $6\frac{1}{2}$ pounds.
 Price: \$8.53 per dozen set or pair

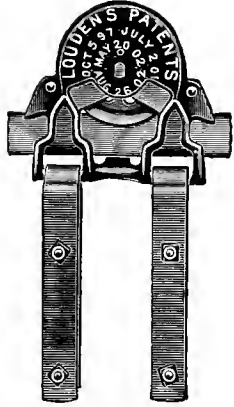

Fig. 566 (Reliance)

The Louden Double Strap Barn Door Hanger is giving complete satisfaction in thousands of barns. It is especially recommended for medium size doors.

This hanger, like all all others of Louden manufacture, is flexible; that is, it allows the door to swing freely away from the building. (See Fig. 483.)

The trolleys are fitted with tempered steel roller bearings; always roll smoothly and easily. Each wheel is protected by a malleable iron hood. (See Fig. 566.)

The two straps with four bolts make the Double Strap Hanger much stronger and more durable than similar hangers having but a single strap and two bolts. The wide frame with the double strap feature also serves to hold the hanger rigid lengthwise of the track and eliminates the end play found in hangers with a single bearing directly under the center of the wheel.

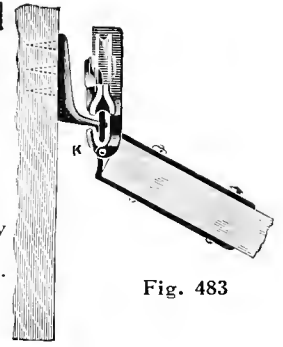

Fig. 483

Track for Jointed Hangers—Fig. 487

Specifications

Track is of high carbon steel $\frac{3}{16} \times 1\frac{1}{4}$ inches.
 Supporting wall brackets of refined malleable iron.
 Wall brackets are riveted solid to the track.
 A strong malleable iron splice is attached to each end of each section of track.

The opposite end is punched with hole to receive splice and the connection is easily made and secure.
 Track is furnished in 6-ft., 8-ft., and 10-ft. lengths.
 Weight of track, per foot, 1 pound (including supporting brackets and splices)

Price of Track per 100 Feet: \$5.28 (including supporting brackets and splices).

Fig. 487 is the track used for Louden Jointed Hangers. It is made of the best high carbon steel, $\frac{3}{16} \times 1\frac{1}{4}$ inches, and will stand twice the strain ordinarily required.

The ends of the sections are securely spliced together by a malleable iron splice riveted into the ends, and it is impossible for them to become separated, as do tracks that are simply butted together. This splice is riveted to one end of each section before leaving our factory, and the other end punched so the connection is easily and quickly made. This makes one solid rail of the whole track, no matter how many pieces have been used, and makes a continuous even tread for the hanger.



Fig. 487 (Marble)

We use a refined malleable iron bracket, mortised through the track and riveted on by hand—no machine work. These brackets have a heavy flange on each side and a brace below to hold the track in place. This adds materially to the stiffness of the track and gives it great strength. Made in 6, 8, and 10 foot lengths.

Standard Jointed Barn Door Hanger—Fig. 567

Specifications

Frame of trolleys of refined malleable iron.
 There are two trolleys with each set of hangers.
 Track wheels are of special quality gray iron.
 Track wheels are 3 inches in diameter and are roller bearing.
 Track wheels are protected from weather and trash by a heavy malleable iron hood.
 The strap which attaches to the door is of malleable iron with heavy reinforcing ribs.
 Suitable for use on doors of any thickness.
 Bolts for attaching to doors packed with each set of trolleys.
 Each set of trolleys packed in neat paper box.
 Weight, per set or pair, $6\frac{1}{4}$ pounds.

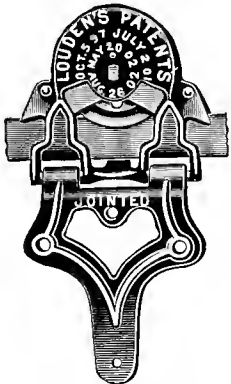

Fig. 567 (Shamrock) Price: \$8.53 per dozen set or pair

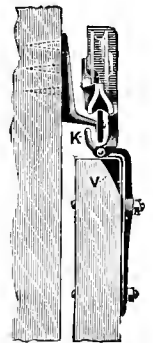

Fig. 485



Standard Jointed Barn Door Hanger—Continued

The Standard Covered Jointed Hanger, Fig. 567, is the same as the Double Strap Covered Hanger, Fig. 566, except the strap which attaches to the door is refined malleable iron instead of steel and bolts to one side of the door only. The trolley wheel is protected from weather by a malleable iron hood. It is provided with keeper lugs which prevent trolley from getting off the track. Also projections on each side of the trolley cleans trash or other obstructions off the track. Suitable for use on all kinds of barn doors.

Louden's Sliding Door Latch—Fig. 455

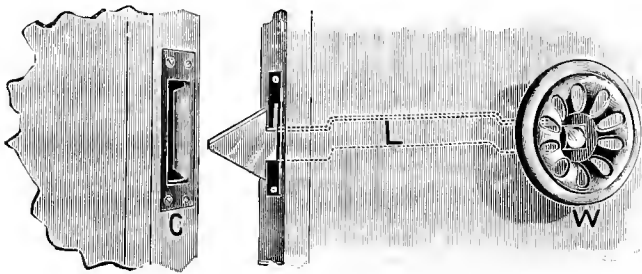

Fig. 455 (Manilla)

Specifications

Consists of 3 parts, viz: latch with knob; metal catch for latch; metal strip for door with slot in which latch works.
 Length of latch-point to center of knob, 8 inches.
 Length of catch, 4 inches.
 Diameter of knob, 3 inches.
 Weight, 1 pound 6 ounces.
 Price: \$2.40 per doz.

The latch is lifted and the door opened and closed by the hand wheel W, which is generally placed on the outside, while the central part (dotted lines L) is bent to form a hand hold on the inside. The catch C has flaring edges to

guide the latch into it. It is reversible and may be used for right or left hand doors. Made of malleable iron, is strong and durable and can be used on double or single doors.

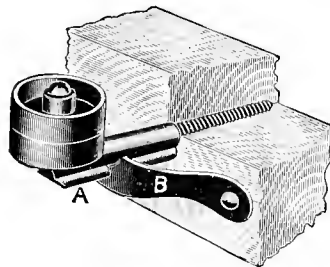

Fig. 456 (Cuba)

Specifications

Diameter of roller, 1 5/8 inches.
 Length of screw (to center of roller), 6 inches. Roller adjustable to suit thickness of door.
 Weight, 12 ounces.
 Price: \$1.33 per doz.

Louden's Stay Rollers

Fig. 456. This roller is screwed into the wall to suit the thickness of the door; and then the brace B is slipped over the rib A and fastened to the wall by screws or nails. This prevents it from turning and getting the roller out of place.

Fig. 457. This roller can be adjusted to the thickness of any door, either before or after fastening to the building, by setting one nut.

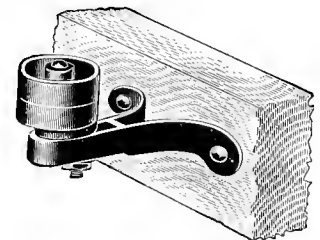

Fig. 457 (Havana)
Specifications

Diameter of roller, 1 5/8 inches.
 Length of bracket, 4 inches.
 Roller adjustable to suit thickness of door.
 Weight, 13 ounces.
 Price: \$1.33 per doz.

Louden Door Stop—Fig. 1205

Every sliding door should be provided with a stop; it prevents the continual wrenching of the track supports.

While any block of wood may be made to serve this purpose, a neat metal stop is desirable. The Louden Pressed Steel Bumper or Stop is the most satisfactory door stop made and costs but a trifle. Specify it in your barn door hanger order.

Louden Offset Hinge—Fig. 349

Louden Offset Hinges are unequalled for hanging gable-end doors. These hinges are made with an offset that allows the bottom of the door to lap on the siding and keep out the rain. When the door is open it drops down against the siding and hugs it so closely that it is out of the way of the load of hay and allows the wagon to be drawn close up to the barn. The wind does not interfere with a door hung with these hinges. Doors hung with Offset Hinges may be arranged to open either by hand

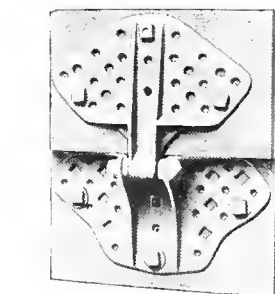

Fig. 349 (Puss)

Specifications

Width, 7 3/4 inches.
 Length, 8 1/2 inches.
 Offset, 1 inch.
 Weight, 2 pounds.
 Price: \$.28 each

or horse power, and the hinges are of sufficient strength to safely handle the largest doors. Bolts or screws may be used for hanging. Three Offset Hinges may be used for extra large doors.

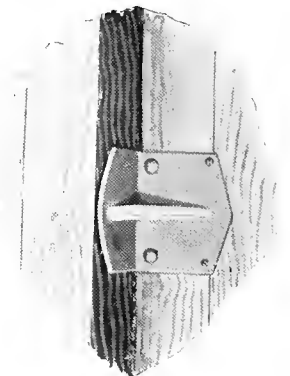

Fig. 1205
Specifications

Width, 3 1/2 inches.
 Bumping surface, 3 1/2 x 1 7/8 inches.
 Reinforced by rib.
 Weight, 8 ounces.
 Price: \$1.60 per doz.



What Others Say About Us

An attempt to choose the "best" letters from the thousands that we have received would take too long, so we print just a half dozen or so of hundreds that have come in since we began the preparation of this catalog. It would seem that Louden customers are truly Louden friends.

Pleasantville, N. Y., Dec., 1914

Louden Machinery Co.,
 Fairfield, Iowa.

Gentlemen:
 I bought my first hay carrier and track from you in 1892 or 1893, and three or four years after, another outfit for another barn as we found the first one so good, and still later a manure carrier outfit, all of which gave good service and are as good as ever now.

Yours truly, W. H. Foster.

Mechanicsville, N. Y., Dec. 14, 1914

Louden Machinery Co.,
 Fairfield, Iowa.

Dear Sirs:
 I made my first purchase of the Louden barn equipments in 1909 and built a large barn that year. In 1913 this barn was destroyed by fire. At this date I have barn No. 2 furnished with Louden equipments. I think this answers for itself whether I am pleased with your goods or not.

Yours truly, Guy L. Fitch.

Lima, Ill., Dec. 22, 1914

Louden Machinery Co.,
 Fairfield, Iowa.

Gentlemen:
 Six years ago I got a Louden track and hay carrier also a grapple fork for my hay barn. Three years ago my brother put a Louden outfit in his barn, and this year I built a new barn and put Louden equipment in it, so you see what I think of the Louden goods. The grapple fork will handle straw as well as all kinds of hay, and the twisting of the rope never balks a Louden carrier. It always works.

Yours truly, John Bolt.

Fairport, N. Y., Dec. 14, 1914

Louden Machinery Co.,
 Fairfield, Iowa.

Dear Sirs:
 I purchased a manure carrier of you in 1909 and it has been in perfect order and operation ever since. I use it every day and would not take three times its cost if I could not replace it. It's a great labor saver and convenience. I also purchased some door hangers of you at the same time which never give me any trouble. If you wish to refer anyone in this neighborhood to me regarding your goods, do so, I'll gladly show them.

Yours very truly,
 W. S. Ritter, R. D. 2.

Newark, N. J., Dec. 12, 1914

Louden Machinery Co.,
 Fairfield, Iowa.

Dear Sirs:
 Perfect satisfaction is the way I would describe my appreciation of your goods after years of service. Having occasion to advise a very close and dear friend about her new barn equipment, I am advising her to use Louden's goods because they are absolutely dependable and durable, and always exactly as represented.

With good wishes, Algernon T. Sweeney.

Hampton, Ill., Dec. 14, 1914

Dear Sirs:

In answer to your request will say I am very well pleased with all Louden goods purchased from you, and the litter carrier I purchased from you about six years ago is just as good as when I got it and I would not part with it for twice what it cost if I could not get another.

Yours very truly,
 J. F. Johnson, R. R. No. 1

West Alexander, Pa., Dec. 21, 1914

Louden barn equipments are the best I have ever seen. I have been using them for nearly five years. The Louden Carrier is the best tool on my farm. Wouldn't trade it for a grain binder if I couldn't get another one. I can't say too much for Louden tools. The six-prong hay fork is a peach. I have two friends living close to me that want carriers and I am in need of some hangers and some more track.

W. Robinson.

Hebron, Ohio, Dec. 11, 1914

Louden Machinery Co.,
 Fairfield, Iowa.

Dear Sirs:
 We equipped our barn (size 40x64 bank barn) with Louden tools seven years ago and have been well pleased with the service given. We have a sling carrier and equipment for handling hay and have never seen anything better, if as good. We also have the basement equipped with litter carrier and are fully satisfied with it, and were I to buy another one, would surely select a Louden. They do the work splendidly and are durable, as I have not had any expense on mine in seven years.

Yours respectfully, J. H. Myer.

Oriskany Falls, N. Y., Dec. 21, 1914

Louden Machinery Co.,
 Fairfield, Iowa.

Dear Sirs:
 We think it about six years ago we bought our first carrier of you. It has given good service up to date. We bought another last year, as we enlarged our barn and wanted two. They both give good satisfaction.

Respectfully Yours,
 John Anderson & Son.

Homer, La., Nov. 27, 1914

Louden Machinery Co.,
 Fairfield, Iowa.

Dear Sirs:
 It gives us real pleasure to bear testimony to the excellent efficiency of your equipment.

We had a crop of pea hay to harvest and were on the anxious seat lest the rain would catch it. But your carrier in facilitating our work saved the day for us. Hardly had the last load in when the rain came, and we feel, therefore, that the carrier saved us several times its cost.

Very truly,
 J. W. Allison,

Lake Placid, N. Y., December 14, 1914

We have eight Louden hay carriers, four litter carriers, and about one-hundred-and-fifty stanchions in use in our various barns and find them very convenient and durable, and quite satisfactory in every way. They have been in use from one to six years.

Lake Placid Club Farms.

Spring Lake Plantation



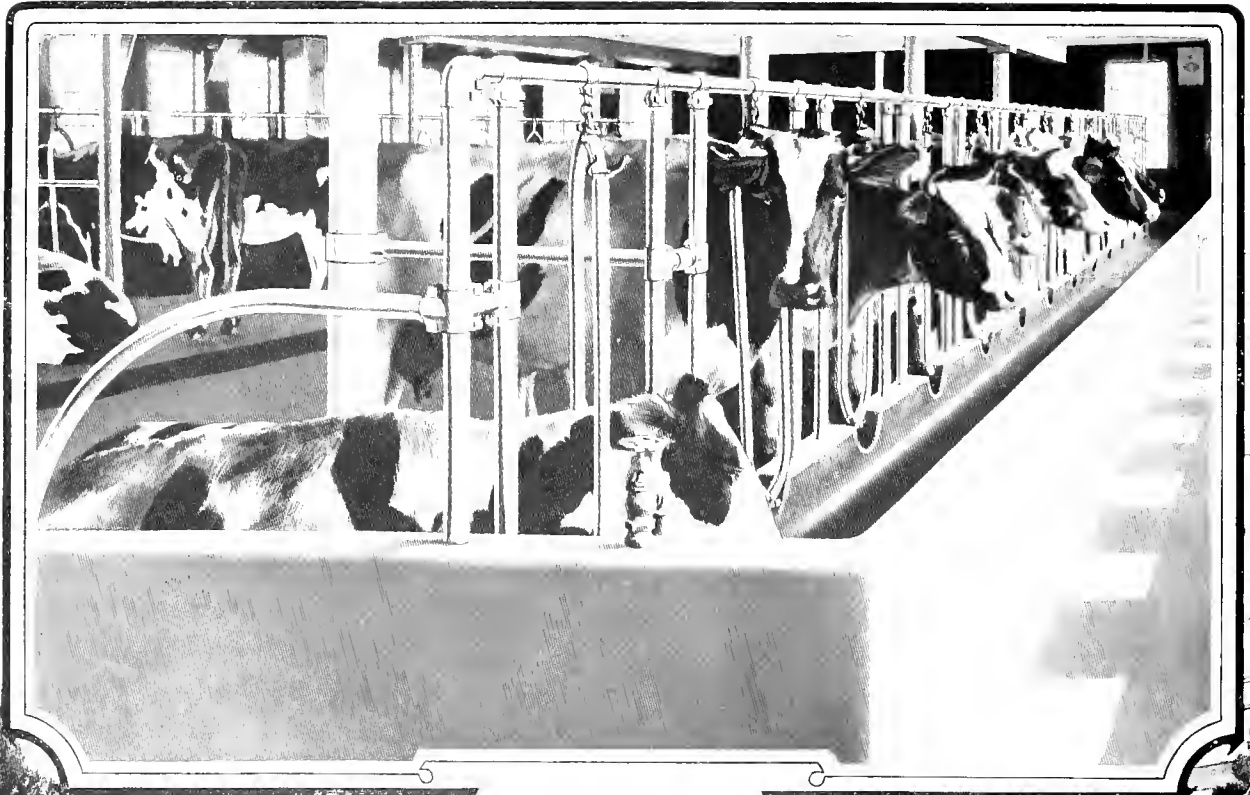

Louden Equipped Barns
are Sanitary and Economical, and the
Cows Enjoy True "Pasture Comfort."
Barn of W. S. Moscrip,
Lake Elmo, Minn.



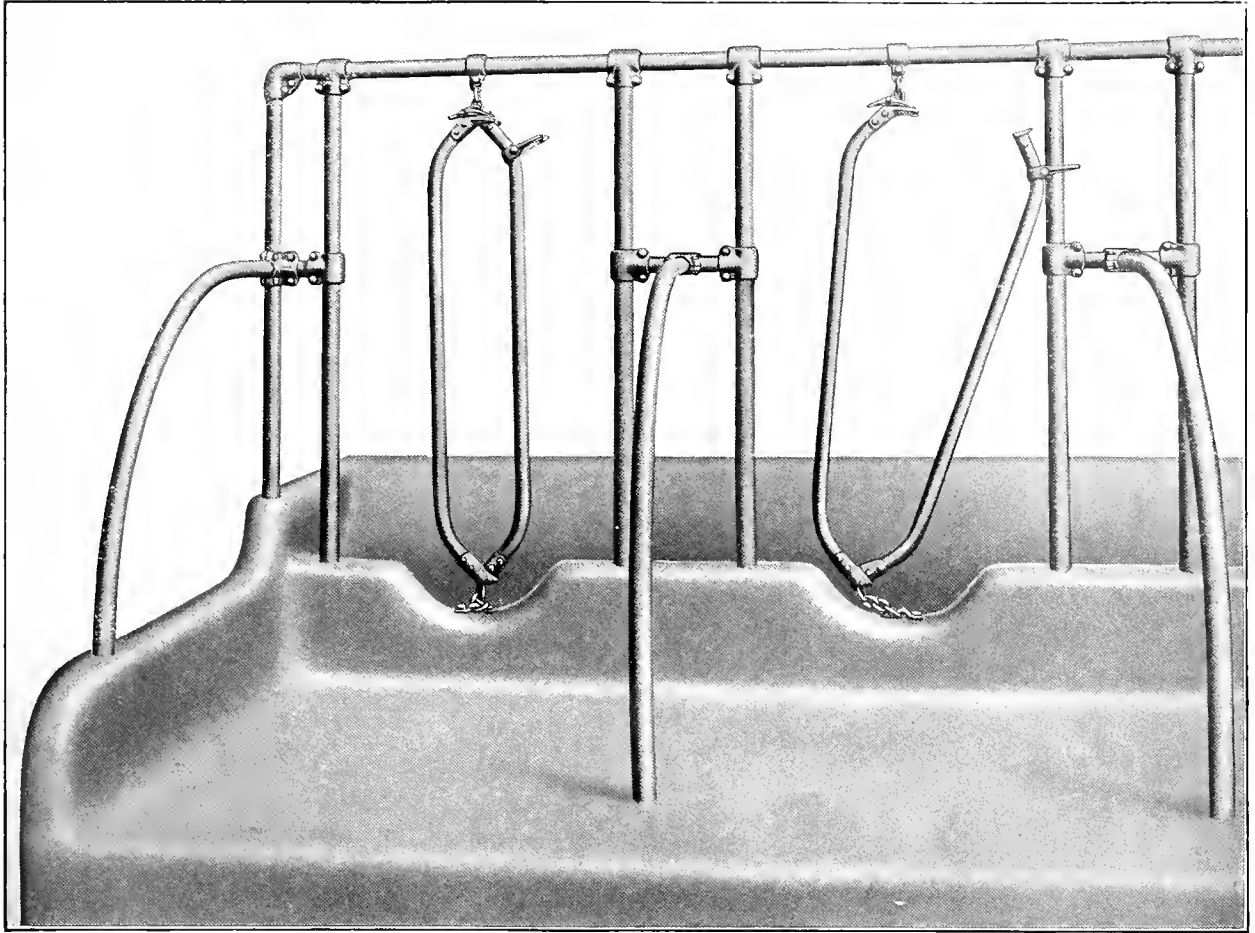

Louden Cow Stalls—Fig. 812

Of all the different designs and types of cow stalls on the market there is no type or design that so nearly meets all conditions in all kinds and sizes of barns and for all sorts of arrangements, as does the Loudon Fig. 812 cow stall.

Whenever a Loudon Fig. 812 cow stall is selected the owner can feel assured that he is putting in equipment that will last as long, look as well, give the cows as great comfort, and keep them as clean as any stall that can be purchased anywhere at any price.

The Loudon Double Braced cow stall, Fig. 812, is the most popular built. It was one of the first designs of metal cow stalls placed on the market, and is so practical and satisfactory that it has continually increased in popularity.

The Dairy Division of the United States Department of Agriculture early recognized this stall as having all desirable features, and has been recommending it ever since we designed it and put it on the market. Its extreme simplicity, together with its sturdy, well braced and strong construction, makes it solid as a rock and practically indestructible.

The main uprights are set deep in the cement at the bottom and at the top they join the horizontal rail, making a strong, rigid frame. In addition to this the frame is braced by means of a bent stall partition, the upper end of which is secured to the cross brace between the two uprights. The lower ends are set 4 inches into the cement floor.

There are no superfluous parts, clap-trap arrangements or attachments about this stall. The only movable part is the stanchion which is fastened by a 3-link chain at the top and a 5-link chain at the bottom, and swings just enough to give the cow comfort.

With this stall no other movable device is necessary. The uprights are spaced proper distance to give the cow ample head room and she can freely turn her head around to her side.

(Send for Complete Catalog of Loudon Dairy Barn Equipment.)



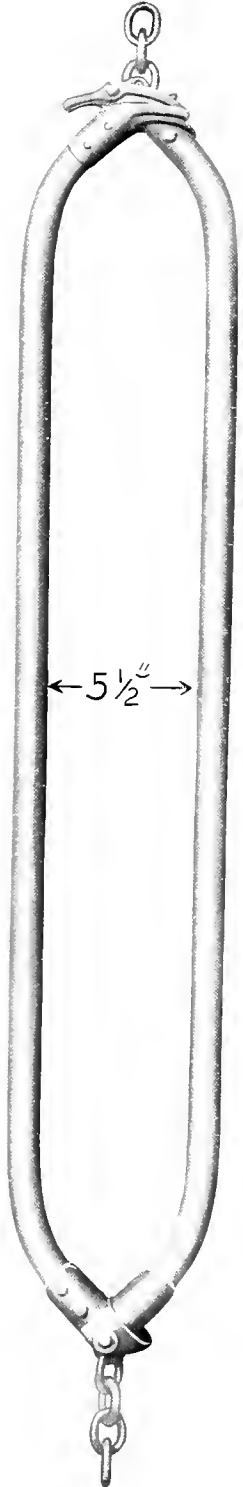

Fig. 861
(Narrow)

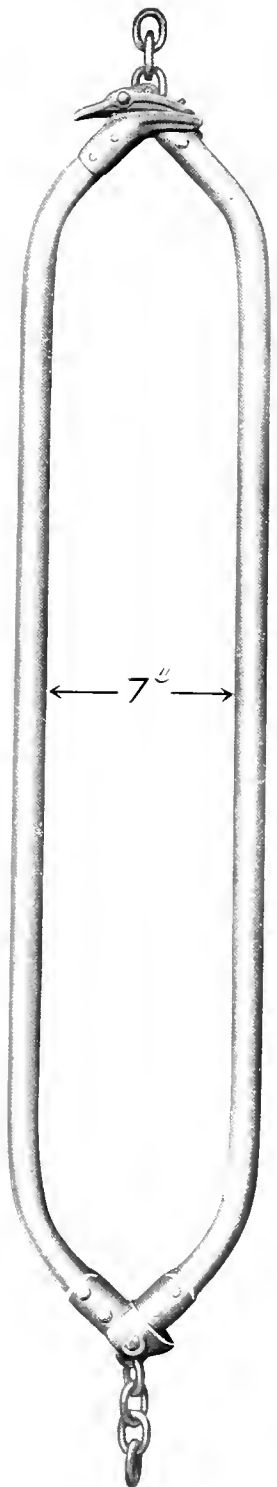

Fig. 861
(Standard)

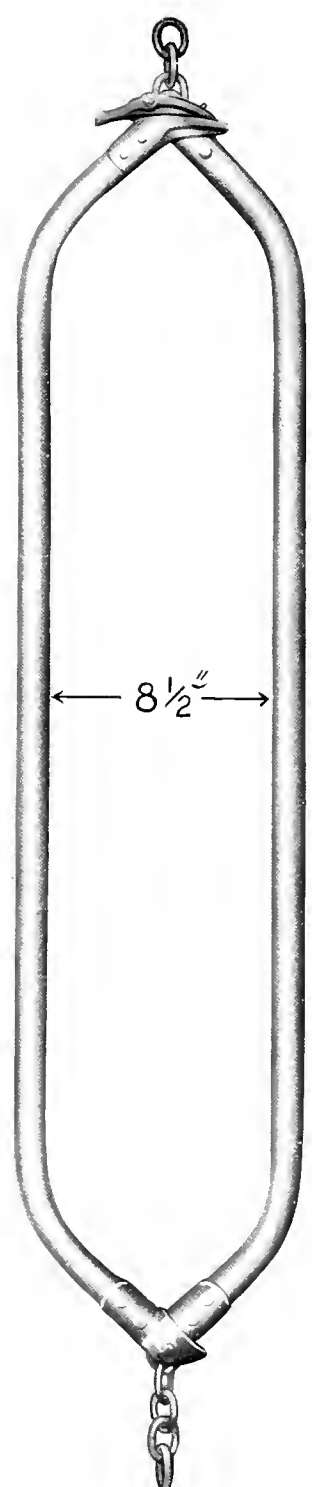
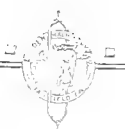

Fig. 861
(Wide)

Louden Tubular Steel Cow Stanchions are Made in Three Widths—for Calves, Cows and Bulls





Louden Stanchions

A Louden stanchion is the best way to tie the cow. It can be used in any kind of stall in any barn. Halters or ropes soon wear out and are more expensive, less comfortable, and less sanitary. It takes so long to tie or untie a row of cows that anything but stanchions is not economy for a barn that is run on a business basis.

The old-fashioned wood stanchions are being discarded rapidly. Dairy men have found that the extra comfort the cow enjoys in a Louden stanchion will cause a considerable increase in milk flow, and that the sanitary Louden stanchion offers no opportunity for germs to develop or to infect the milk and endanger the animal's health.

Cows, like persons, do their best when under the most favorable conditions. The contented cow is the best producer—and to be contented she must be comfortable.

All Louden tubular steel and wood-lined stanchions are designed for comfort. They are flexibly hung and allow the cows to eat, drink, lie down, rise, or card their flanks with utmost freedom. In fact, cows when tied in the Louden flexible steel stanchions have all the comfort that they do when standing or lying in the open pasture.

All Louden stanchions are hung with single chains, strong enough to hold a 2,000 pound bull, but slack enough so the animal will not be hampered in its natural movements. The lower end of the stanchion swings freely nine inches in any direction.

When a cow lies down she nearly always lies to one side of the stall. A Louden stanchion will adjust itself to her position so that she can rest in absolute comfort.

When arising she always lunges forward. A Louden stanchion swings forward with her movement. This is a most important feature. If the cow were fastened in a more rigid stanchion she would often slip back to her knees when attempting to rise. This slipping has caused many cases of abortion and enlarged knees. The striking against more rigid stanchions has caused many enlarged shoulders.

Louden stanchions are not expensive to install. The cost of one is about the same as that of a good halter, and the stanchion is stronger, safer, more sanitary, more convenient, and will last several times as long.

Louden Tubular Steel Stanchions

The Louden tubular steel stanchion is sanitary. It is comfortable for the cow. It has a strong hinge. It is simple in construction.

All Louden stanchions can be used anywhere that a place can be arranged for upper and lower fastenings. Hang them in any barn or stall.

The Louden Tubular Steel Stanchions are made in three sizes—for calves, $5\frac{1}{2}$ inches wide, for cows of average size, 7 inches wide, and for extra large cows, $8\frac{1}{2}$ inches wide. We furnish these three sizes at the same price.

The Louden tubular steel stanchion is the essence of simplicity. Two pieces of special carbon tubular steel, having the ends bent at an angle of about forty-five degrees are hinged together at the lower ends by two malleable iron castings. To the upper ends are attached malleable castings that form a catch or lock that holds the stanchion safely closed around the cow's neck.

The latch, or catch, to hold the stanchion closed is absolutely stock proof, but can be operated with the mittened hand. Even should you have a bucket in one hand and the other arm piled full of hay, you can open the stanchion by a touch with the tip of your elbow. An icy mitten, frozen stiff, is no inconvenience with Louden stanchions.

Like the lower end of the stanchion, a plate, riveted solidly in place fits over the end of each tube of the upper end of stanchion. One of these plates has a spur over which the latch catches. There is no side play or looseness on either end. A row of stanchions may be opened or closed with one hand—and quickly—as the catch works automatically like the catch on a door. A man can operate a row of stanchions while walking quite rapidly down the feeding alley.

The U shape of the upper and lower ends of Louden stanchions is one of the very desirable features—and is covered by patents. The U shape not only conforms nicely to the shape of the cow's neck but makes it impossible for her to get her foot caught between stanchion and manger curb. It also makes it possible to use the built up, cut-out manger which is a great feed saver. To eliminate all danger to the animals we have always avoided manufacturing a flat bottomed stanchion or fastening the stanchion at the lower end with a double chain or swivel. The single chain gives the cow far greater freedom.



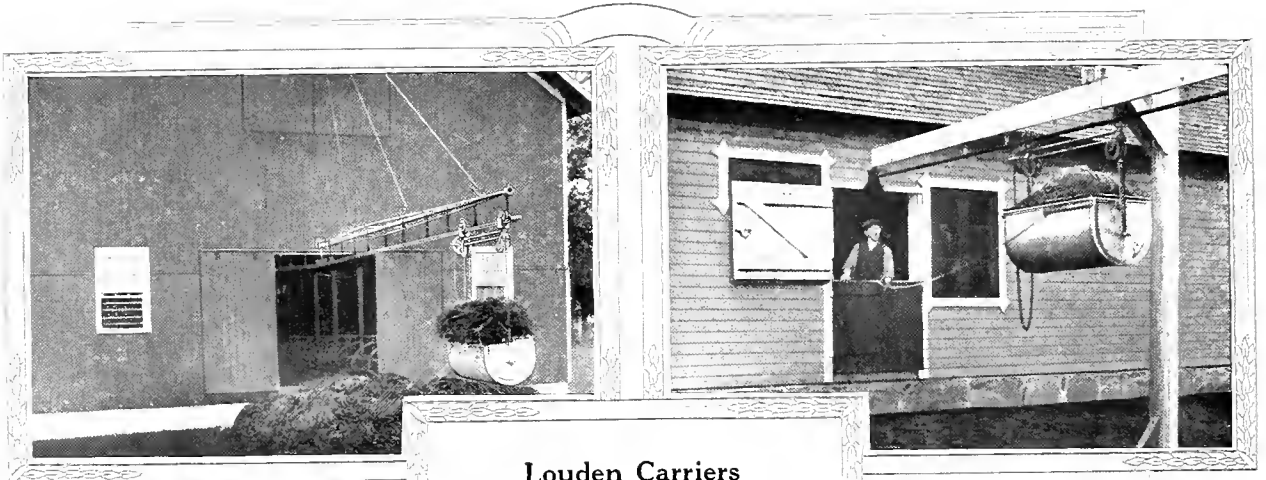

Louden Swinging Cranes are Hinged at barn, making possible a large dumping area, and doing away with posts in the yard.

Louden Carriers

Louden Litter Carriers are great time and labor savers. With a Louden Litter Carrier barn cleaning is made easy and pleasant work. Every farm needs this equipment. Manure may be taken directly from the stalls to the spreader or manure pit with but one handling and in half the time necessary by the old-fashioned method. Loaded cars may be raised and lowered to any height by a small boy, and run out and emptied anywhere desired. Write today for detailed information and catalogs and less-en your winter barn work. Louden Carriers are made in several different styles both for Steel and Wire Track.

Track arranged with slight incline so carrier may be emptied with trip rope and returned to barn. A barn in Sweden.

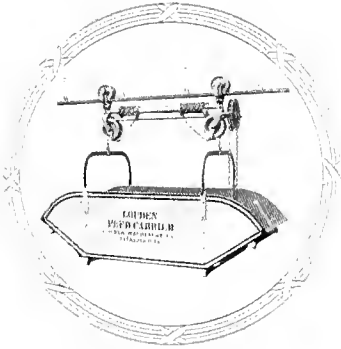

Louden Feed Carriers are relief from the bucket, the wheelbarrow and the bushel basket, and the waste resulting from those old-fashioned methods of handling feed. The Louden Feed Carriers are a necessity on any farm where a dozen or more head of stock are to be fed. A boy of ten years can operate the carrier from a feed bin or silo to mangers or feed racks, and do the work with less effort than it takes you to run a loaded wheelbarrow. Write us, giving outline of your feeding conditions, and we will gladly furnish estimates free. Louden Feed Carriers are made in many styles.

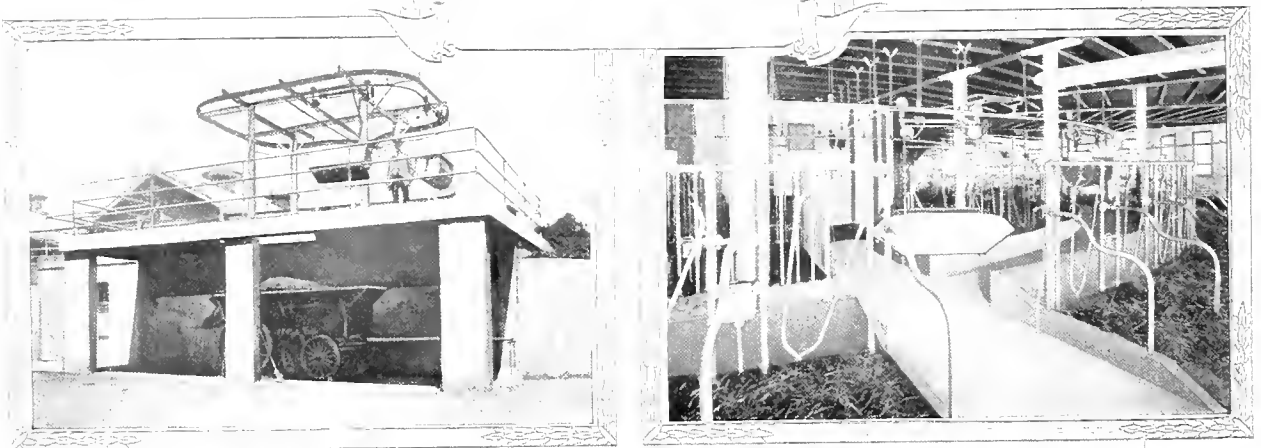
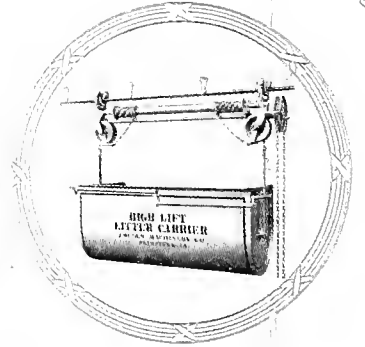

An intricate but successful track arrangement at the Soldiers' Home, Washington, D. C. Louden track can be furnished on special order for any degree curve.

Louden Feed and Litter Carriers, and Louden Stalls and Stanchions are used in this modern round barn at the Hershey Farms, Hershey, Pa.

Profit and Loss on the Farm

Losses on the farm result from exactly the same causes which make failures of mercantile establishments. The successful farmer must exercise the same care to prevent losses as must the superintendent of a great railway system.

Waste Steals Profit

Whether it is of labor or of material, waste is the most persistent and insidious cause of loss.

The most valuable by-product of the farm is manure. The litter of the barn is the balance wheel of the farm. Every crop harvested, every blade of grass eaten by cattle uses just so much of your cash capital in soil fertility. You must replace it by fertilizing. Now comes the opportunity for waste. What method do you use for handling manure? All soil experts agree that manure used fresh and containing its full share of liquid is at least 50 per cent more valuable than old manure. Are you losing that 50 per cent through lack of facilities for handling it? A litter carrier installed in your barn will enable you to load fresh manure into a wagon or spreader and make the work mere child's play.

If you do not have out little booklet entitled "Some Interesting Facts on a Homely Subject," which treats of manure values and methods of caring for same, send for it—it is free.

Stop Stable Drudgery

Labor costs money. Whether you clean your barn and feed your stock yourself or hire it done, you cannot afford to waste the time and energy called for by the old wheelbarrow method. The saving in time alone gained by the use of a litter and feed carrier will pay handsomely on the investment.

Cleanliness Next To Godliness

Just as much so in the barn as in the kitchen. A clean barn means healthy cattle, more and better dairy products. Removing the unpleasant feature of cleaning the barn by using a litter carrier will result in more frequent cleaning. The carrier places the litter either in your wagon or at any desired distance from your barn, insuring not only a clean barn, but a clean yard as well.

Check Up The Profits

Count them on your fingers: the increase in the value of fresh, wet manure and consequent

increase in the fertility of the farm; the saving of time in the handling; the improved health of your cattle; the increase both in quantity and quality of dairy products. Any one of these reasons should be sufficient to induce any farmer or dairyman to equip his barn with a Louden Litter Carrier. Many farmers say that by using a Louden Feed Carrier they are able to prevent a waste of feed that soon pays for a feed carrier—to say nothing of the time saved. If you could reduce each profit to figures, add them up for a year, setting down the answer in dollars and cents, you would very quickly, like every one of your friends who have installed Louden Litter and Feed Carriers, come to the conclusion that you could not get along without them.

Why You Should Buy Louden Carriers

Because they are the best. This is a "look-you-square-in-the-eye" statement of facts. We know they are the best because we have made a life study of overhead carriers. We own the second patent issued by the United States Patent Office on Litter Carriers. We have studied and experimented constantly, with a full and complete knowledge of the requirements to make our carriers perfect. Whenever we find an improvement possible we make it. We discard undesirable features. Our patents to-day cover practically every valuable feature on litter carriers.

Price

In making up your mind to install a litter carrier in your barn, bear in mind that it is not for a day, a week or a month, but for years that you want this carrier to work at all times and to give you good service. That once you have discarded the wheelbarrow you do not want to be compelled to go back to it, while making repairs on a carrier system which was built too cheaply to stand up under the work.

We build carriers of different styles, of different weights of materials, and at a wide variation in price to suit both the needs and the purse of all. But from the highest-price outfit to the lowest price, each one represents the highest standard of excellence—the Louden Standard—and is positively the best value that can be bought at the price.

Write for our complete catalog of Litter and Feed Carriers.



Price List

(Subject to Change Without Notice)

Goods Marked "*" are Trade Goods and are not Warranted by this Company

Page	Fig.		Price	Code
6	430	Junior Steel Track Fork Carrier.....	each \$ 4.33	Consul
	830	Junior Steel Track Fork Carrier, 8 wheels (not illustrated).....	each 5.00	Chaise
		Junior Steel Track Fork Carrier fitted with Swivel Trucks for Round Barns (not Illustrated).....	each 6.66	
6	1123	Trip Block for Junior Steel Track Fork Carriers.....	each .33	
6	523	Double Bead End Stop Block.....	each .17	Cage
7	C430-A	Rope Swivel for Junior Steel Track Fork Carrier.....	each .33	
8	1100	Louden Senior Hay Fork Carrier.....	each 5.33	
	1124	Louden Senior Hay Fork Carrier for Cable Draft Rope (not illustrated).....	each 5.33	
8	1123	Trip Block for Senior Hay Fork Carriers.....	each .33	
8	523	Double Bead End Stop Block.....	each .17	Cage
10	306	Standard Hay Fork Carrier.....	each 4.33	Captain
	1126	Trip Block for Louden Standard Hay Fork Carrier.....	each .75	
10	437	Single Bead End Stop Block.....	each .17	Caddy
11	441	Junior Fork Carrier for Wood Track.....	each 4.33	Capital
11	1127	Trip Block for Junior Fork Carrier for Wood Track.....	each .33	
12	1103	Carry-All Hay Sling Carrier.....	each 10.00	Heavy
12	1123	Trip Block for Carry-All Hay Sling Carrier.....	each .33	
12	523	Double Bead End Stop Block.....	each .17	Cage
14	821	Iowa Hay Sling Carrier.....	each 8.67	Chariot
		Iowa Sling Carrier fitted with Swivel Trucks for Round Barn.....	each 11.00	
14	1123	Trip Block for Iowa Hay Sling Carrier.....	each .33	
14	1128	Adjustable Trip for Iowa Hay Sling Carrier.....	each .33	
14	523	Double Bead End Stop Block.....	each .17	Cage
15	529	Louden Weight Return.....	each 1.00	
16	514	Automatic Hay Sling Carrier.....	each 8.67	Cannon
16	1129	Trip Block for Automatic Hay Sling Carrier.....	each .90	
16	1128	Adjustable Trip for Automatic Hay Sling Carrier.....	each .33	
16	437	Single Bead End Stop Block.....	each .17	Caddy
17	315	Reversible Hay Sling Carrier for Wood Track.....	each 8.67	Champion
17	1130	Trip Block for Reversible Hay Sling Carrier.....	each .67	
17	435	Comb Pulley.....	each .20	Perch
17	383	Rope Hook.....	each .17	Excelsior
18	817	Cross Draft Hay Fork and Hay Sling Carrier (For Slings).....	each 8.67	Chaste
		Cross-Draft Hay Fork and Hay Sling Carrier (For Fork).....	each 7.67	
18	1131	Release Block for Cross Draft Carrier.....	each .67	
18	523	Double Bead End Stop Block.....	each .17	Cage
18	383	Rope Hook.....	each .17	Excelsior
20	819	Three Part Rope Hitch for Cross Draft Carrier.....	each .60	
22	965	Single Drum Power Hoist.....	each 40.00	
23	1132	Triple Drum Power Hoist.....	each 80.00	
25	1104	Round Barn Hay Sling Carrier.....	each 11.00	Round
	1134	Round Barn Hay Fork Carrier (not illustrated).....	each 6.67	
25	1131	Release Block for Round Barn Carrier.....	each .67	
25	523	Double Bead End Stop Block.....	each .17	Cage
25	383	Rope Hook.....	each .17	Excelsior
27	1135	Guide Pulley for Round Barn.....	each 4.00	
28	621	Junior Hay Fork Carrier for Cable Track.....	each 4.20	Combine
28	801	Trip Block for Junior Carrier for Cable Track.....	each .67	March
28	C430-A	Rope Swivel for Junior Carrier.....	each .33	
29	417	Galvanized Steel Wire Rope, 5/8 inch diameter.....	per 100 ft. 6.50	May
		Galvanized Steel Wire Rope, 1/2 inch diameter.....	per 100 ft. 5.50	August
29	418	Galvanized Steel Strand, 1/2 inch diameter.....	per 100 ft. 2.67	June
		Flexible Wire Draft Rope.....	per 100 ft. 6.50	July
29	337	Wire Cable Loop Clamp.....	per doz. 2.67	Porto



Price List—Continued

Page	Fig.		Price	Code
29	337½	Wire Cable Stop Clamp	per doz.	\$2.00 Rico
30	571	Double Bead Steel Track	per ft.	.12 Clara
30	584	Single Bead Steel Track	per ft.	.12 Cora
30	550	Splice Clamp for Double Bead Steel Track	each	.20 Mohler
30	436	Splice Clamp for Single Bead Steel Track	each	.20 Mulkins
30	498	Standard Two-Part Track Hanger	per doz.	1.00 Carson
30	500	Light Two-Part Track Hanger	per doz.	.82 Camp
30	832	5 inch Link Track Hangers	per doz.	1.06 Trout
31	780	Straight Wood Track Hang Hook, 14 inches	per doz.	.80 Canna
31	781	Straight Wood Track Hang Hook, 16 inches	per doz.	.90 Chestnut
31	372	Jointed Wood Track Hang Hook, 14 inches	per doz.	1.33 Cairo
31	424	Improved Malleable Rafter Bracket	per doz.	.48 Casper
31	425	Common Malleable Rafter Bracket	per doz.	.40 Caesar
31	465	Malleable Ridge Pole Bracket	per doz.	.67 Cubeb
31	675	Side Rafter Bracket	per doz.	.80 Cute
31	725	Side Beam Bracket	per doz.	1.00 Beam
31	373	Barbed Chisel Point Steel Nail	per pound	.10 Cement
32	351	6-tine Standard Size Balance Grapple Hay Fork	each	6.67 Planet
33	648	4-tine Balance Grapple Hay Fork	each	5.33 Prophet
33	686	6-tine Extra Large Balance Grapple Hay Fork	each	8.00 Farmer
34	1137	Louden Rocker-Bar Hay Fork	each	2.50 Tuttle
34	350	Triple Harpoon Hay Fork	each	3.33 Peerless
34*	353	Harris Double Harpoon Hay Fork	each	1.07 Pony
*	674	31-inch Harris Double Harpoon Hay Fork	each	1.33 Pocket
*	676	Alfalfa Double Harpoon Hay Fork	each	2.47 Pants
34*	356	Nellis Single Harpoon Hay Fork	each	2.00 Poker
36	984	6-ft. Carry-All Hay Sling	each	4.67 Entire
37	666	4-ft. Standard Hay Sling	each	2.13 Moon
37	668	5-ft. Standard Hay Sling	each	2.53 Mars
37	600	Three Rope Hay Sling	each	2.67 Modern
37	324	California Hay Sling (regular)	each	3.33 Moxie
37	1105	California Hay Sling (made up of 5/8 inch rope)	each	3.60
38	516	Louden Hay Sling Coupling	each	.67 Mate
38	1106	Handy Hay Sling, 3 Ropes	each	1.60
	717	Handy Hay Sling, 2 Ropes	each	1.17
	718	Handy Hay Sling Holder	each	1.00 Day
38	328	Side Trip Sling Holder	each	1.00 Martyr
39	652-653	Fork Clevis	each	.33 Maroon
39	332	Sling Binding Pulley	each	2.00 Mentor
40		Self-Locking Sling Pulleys with Handy Hay Sling Holder Attachment	per pair	2.35
40	330-331	Self-Locking (Right Angle) Hay Sling Pulleys	per pair	2.00 Mason
41		All Registering Heads	each	.33
42	649	Parallel Hay Sling Pulleys	per pair	1.67 Mastiff
42	651	Senior Parallel Hay Sling Pulley for Wire Draft Rope	per pair	2.33 Miller
43	467	High Grade Knot Passing Pulley, Wood Sheave	per doz.	4.40 Paragon
43	494	High Grade Knot Passing Pulley, Iron Sheave	per doz.	5.13 Passport
43	468	High Grade Draft Pulley, Wood Sheave	per doz.	3.67 Perlude
43	495	High Grade Draft Pulley, Iron Sheave	per doz.	4.40 Password
44	519	Mammoth Pulley	per doz.	6.67 Pencil
44	651	Cable Pulley, 7 inch iron Sheave	per doz.	12.00 Kuroki
44	579	Cable Pulley, 8 inch Sheave	per doz.	16.00 Perfect
44	364	Upright Floor Pulley	per doz.	6.67 Palace
45	366	Standard Fork Pulley	each	.67 Togard
45	1139	Senior Fork Pulley	each	1.00
45	359	Return Pulley	per doz.	\$2.00 Pointer



Price List—Continued

Page	Fig.			Price	Code
45	435	Comb Pulley	per doz.	2.40	Perch
45	360	Check Pulley	per doz.	1.20	Parasite
45	623	Snatch Pulley Block	per doz.	6.67	Pawn
45*	729	Cast Frame Knot Passing Pulleys	per doz.	2.67	Peter
45*	522	Cast Frame Draft Pulley	per doz.	2.13	Presto
45*	641	Wood Frame Reed Pulley with Hook	per doz.	2.67	Ray
45*	642	Wood Frame Reed Pulley with Eye	per doz.	2.67	Frank
46	389	Floor Hook, $\frac{3}{4}$ x 7 inches	per doz.	.93	Ensign
46	390	Rafter Hook, $\frac{5}{8}$ x 6 inches	per doz.	.80	Envoy
46	391	Small Hook, $\frac{1}{2}$ x $3\frac{1}{2}$ inches	per doz.	.67	Exile
46	469	Single Bead Pulley Hook	each	.17	Province
46	470	Double Bead Pulley Hook	each	.17	Provost
46	348	Bracket Pulley Holder	each	.40	Pyramid
47	344	Hoisting Singletree	each	1.00	Prince
47	345	Spreader Attachment	each	.67	Pension
47	367	Lightning Rope Hitch	per doz.	2.13	Emery
47	383	Swivel Rope Hook	each	.17	Excelsior
47	349	Offset Hinge	per pair	.53	Puss
47		Hay Door Fittings	per set	1.33	
48	645	No. 1 Hay Rack Clamps $\frac{3}{8}$ x 14	per doz. sets	12.00	Finger
		No. 2 Hay Rack Clamps $\frac{3}{8}$ x 16	per doz. sets	12.80	Fang
		No. 3 Hay Rack Clamps $\frac{3}{8}$ x 18	per doz. sets	13.60	Fair
49	593	Combination Rack Irons	per set	2.33	Fox
49	398	Louden Improved Stake Holder	per doz.	2.67	Santiago
49	398 $\frac{1}{2}$	Louden Common Stake Holder	per doz.	1.60	Tampa
49	624	Box Rack Stake Holder	per doz.	1.67	Bahama
49	627	Pressed Steel Stake Holder	per doz.	1.00	Beach
49	426	Self Opening Ice Tongs, 13 inch	per doz.	8.00	Cardenos
49	695	Self Opening Ice Tongs, 17 inch	per doz.	8.50	Matanza
49	696	Self Opening Ice Tongs, 21 inch	per doz.	9.00	Sharp
50	448	Louden Wire Stretcher	per doz.	9.33	Key West
50	806	Louden Stretcher Hoist	per doz.	9.33	Mole
51*	534	Perfect Hoist No. 25 Triple Sheave	each	5.33	Ruth
51*	533	Perfect Hoist No. 27 Double Sheave	each	4.67	Eliza
51*	532	Perfect Hoist No. 29 Single Sheave	each	4.00	Jennie
51*	697	Perfect Hoist No. 31 Triple Sheave	each	4.00	Emma
51*	698	Perfect Hoist No. 33 Double Sheave	each	3.00	Elsie
51*	699	Perfect Hoist No. 35 Single Sheave	each	2.67	Maude
51*	730	Perfect Hoist No. 37 Double Sheave	each	2.13	Mable
51*	731	Perfect Hoist No. 39 Single Sheave	each	1.60	Bessie
61	911	Bird Proof Barn Door Track	per 100 ft.	13.33	Bandit
62	961	Supporting Hangers and Brackets for Bird Proof Track	per doz.	1.00	Hang
63	902	Bird Proof Door Hanger	per doz. sets	16.00	Bird
64	1052	Adjustable Bird Proof Hangers	per doz. sets	16.00	
64	1202	Garage Door Hanger	per doz. sets	16.00	
65	1200	Covered Bird Proof Door Track	per 100 ft.	18.00	
66	458	Double Tread Barn Door Hangers	per doz.	11.20	Dewey
66	452	Double Tread Barn Door Track	per 100 ft.	8.00	Evans
67	566	Covered Double Strap Barn Door Hanger	each	8.53	Reliance
67	487	Rigid Barn Door Track	per 100 ft.	5.28	Marble
67	567	Covered Jointed Barn Door Hanger	per doz.	8.53	Shamrock
68	455	Sliding Barn Door Latch	per doz.	2.40	Manilla
68	456	Screw Adjustable Stay Roller	per doz.	1.33	Cuba
68	457	Slide Adjustable Stay Roller	per doz.	1.33	Havana
68	349	Off Set Hinges	per pair	.53	Puss
68	1205	Steel Door Stop	per doz.	1.60	



INDEX

	Page		Page
Adjustable Bird-Proof Door Hanger	64	Harris Fork	34
Automatic Hay Sling Carrier	16	Hay Forks	32, 34
Bird-Proof Barn Door Hanger	61	Hay Fork Carriers	6, 11
Box Rack Stake Holder	49	Hay Rack Clamps	48
Bracket Pulley Holder	46	Hay Slings	35, 38
Cable Draft Rope (Not Illustrated)	8	Hay Sling Couplings	38
Cable Pulleys	44	High Grade Pulleys	43
California Hay Sling	37	Hoists (Perfect)	51
Carry-All Hay Sling	36	Hoists (Power)	22, 23
Carry-All Sling Carrier	12	Hoisting Singletree	47
Cast Frame Draft Pulley	45	Hooks	46
Check Pulley	45	Ice Tongs	49
Comb Pulley	45	Improved Malleable Rafter Bracket	31
Combination Rack Irons	49	Iowa Hay Sling Carrier	14
Covered Bird-Proof Barn Door Track	65	Jointed Wood Track Hook	31
Covered Double Strap Door Hanger	67	Junior Fork Carrier for Cable Track	28
Covered Jointed Barn Door Hanger	67	Junior Steel Track Hay Fork Carrier	6
Cross Draft Sling and Fork Carrier	18	Junior Fork Carrier for Wood Track	11
Double Bead Steel Track	30	Lightning Rope Hitch	47
Double End Hoist Barn	55	Link Track Hangers	30
Double Harpoon Hay Fork	34	Malleable Rafter Brackets	31
Double Tread Barn Door Hangers	66	Mammoth Pulley	44
End Stop Block (Double Bead Track)	6-8	Nail (Barbed Chisel Point)	31
End Stop Block (Single Bead Track)	10	Nellis Harpoon Fork	34
Five-inch Link Track Hanger	30	Off-Set Hinge	47, 68
Flexible Wire Draft Rope	29	Perfect Hoists	51
Floor Hook	46	Power Hoists	22, 23
Forks	32, 34	Pulleys	43, 45
Fork Clevis	39	Rack Irons	49
Fork Pulleys	45	Rafter Brackets	31
Four-Tine Grapple Fork	33	Rafter Hook	46
Galvanized Steel Wire Rope	29	Release Block for Cross Draft Carrier	18
Galvanized Steel Strand	29	Reversible Hay Sling Carrier	17
Garage Door Hanger	64	Rigid Barn Door Track	67
Grapple Forks	32	Rope Hitch, Lightning	47
Guide Pulley for Round Barn	27	Rope Hook	17
Handy Hay Sling Holder	38	Rope Swivel (Junior Carrier)	28
Harpoon Forks	34	Round Barn Outfit	25

(Continued on next page.)





INDEX—Continued

	Page		Page
Screw Adjustable Stay Roller.....	68	Small Hook.....	46
Self-Locking Sling Pulleys.....	39	Snatch Pulley Block.....	45
Self-Opening Ice Tongs.....	49	Splice Clamp for Single Bead Steel	
Senior Fork Pulley.....	45	Track.....	30
Senior Hay Fork Carrier.....	8	Splice Clamp for Double Bead Steel	
Senior Parallel Hay Sling Pulley for		Track.....	30
Wire Draft Rope.....	42	Spreader Attachment.....	47
Side Rafter Bracket.....	31	Stake Holders.....	49
Side Trip Sling Holder.....	38	Standard Fork Pulley.....	45
Sing'e Bead Track Pulley Hook.....	46	Standard Hay Fork Carrier.....	10
Singletree (Hoisting).....	47	Straight Wood Track Hang Hook....	31
Single Bead Steel Track.....	30	Swivel Rope Hook.....	47
Single Bead End Stop Block.....	10	Three-Part Rope Hitch for Cross	
Six-Tine Grapple Forks.....	32	Draft Carrier.....	20
Slings.....	35, 38	Three-Rope Hay Sling.....	37
Sling Binding Pulleys.....	39	Triple Drum Power Hoist.....	23
Sling Couplings.....	38	Upright Floor Pulley.....	44
Slide Adjustable Stay Roller.....	68	Wire Stretcher.....	50
Sliding Barn Door Latch.....	68	Wood Frame Reed Pulley.....	45

LOUDEN BRANCH HOUSES

St. Paul, Minnesota

Albany, New York

Fort Wayne, Indiana

