

Historic, archived document

Do not assume content reflects current scientific knowledge, policies, or practices.

Review
A99.9
F7644
2007

CORE LIST

MATHEMATICAL ANALYSIS OF FOREST FIRE SUPPRESSION [1, 2]6

F. A. Albin
G. N. Korovin
E. H. Gorovaya

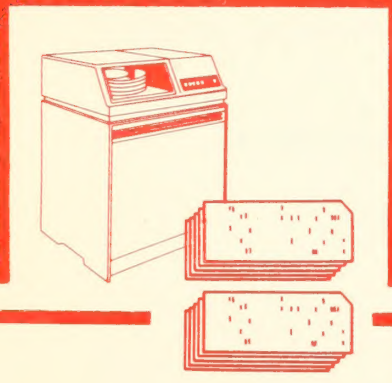
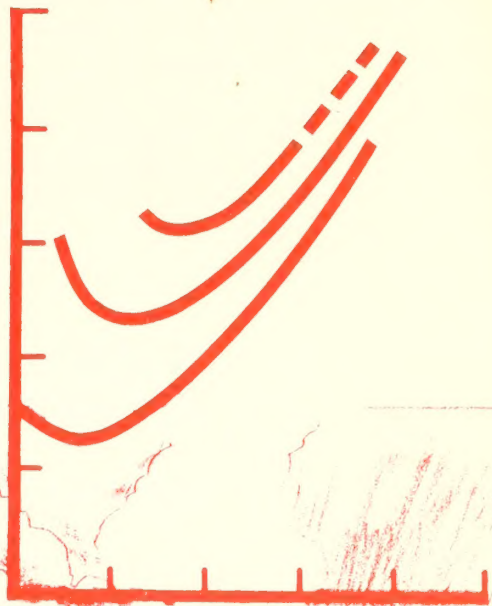

USDA Forest Service Research Paper INT-207
INTERMOUNTAIN FOREST AND RANGE EXPERIMENT STATION
FOREST SERVICE, U.S. DEPARTMENT OF AGRICULTURE

THE AUTHORS

F. A. ALBINI is associated with the Intermountain Forest and Range Experiment Station, Ogden, Utah 84401; located at the Intermountain Station's Northern Forest Fire Laboratory, Missoula Montana.

G. N. KOROVIN AND E. H. GOROVAYA are associated with the Leningrad Forestry Research Institute, Mathematical Methods Laboratory, Leningrad, Russia.

ACKNOWLEDGMENT

Special thanks are due to Mr. Roger McCluskey of the Northern Forest Fire Laboratory, whose invaluable assistance made possible the timely completion of the numerical computations.

MATHEMATICAL ANALYSIS OF FOREST FIRE SUPPRESSION

F. A. Albini, G. N. Korovin, E. H. Gorovaya

INTERMOUNTAIN FOREST AND RANGE EXPERIMENT STATION
Forest Service
U.S. Department of Agriculture
Ogden, Utah 84401

RESEARCH SUMMARY

This paper presents a mathematical formulation of the construction of a containment perimeter for a wildland fire. The formulation permits the calculation of total burned area, final perimeter, and containment time, if the rate of growth of the fire can be specified as a function of time and position. Using a simple but flexible fire shape function, numerical results are given, showing the influence of the rate of spread in the front, flank, and back directions expressed in ratio to the rate of control line construction. These results may be useful in presuppression planning and effectiveness analyses. This paper is the result of collaborative effort carried out as part of the U. S. /U. S. S. R. scientific-technical exchange program in forestry.

CONTENTS

	Page
INTRODUCTION	1
BASIC CONCEPTS AND LIMITATIONS OF METHOD	1
SIMPLIFYING ASSUMPTIONS	3
SENSITIVITY ANALYSIS	8
CHANGING TACTICS: INDIRECT ATTACK ON RAPID HEAD FIRE	12
SUMMARY	19
REFERENCES	19

PREFACE

In October 1976, as part of a technical-scientific exchange program in forestry, a team of forest fire specialists from the United States visited the Soviet Union. Frank Albini, representing Forest Fire and Atmospheric Sciences Research, worked at the Leningrad Forestry Research Institute. The Institute is the main organization performing fire research for protecting forests in the Soviet Union.

Dr. Albini collaborated with Candidate Georghy N. Korovin, chief of the computational methods laboratory, and members of his staff, including Ms. E. H. Gorovaya, on the analysis presented in this paper. The group formulated the scope of the analysis, methods of computation, and mathematical expressions. Numerical results were generated independently and compared later. This paper, in Russian, is included in the annals of the Leningrad Institute for 1977. The translation presented here should be useful in tactical planning for forest fire suppression, a matter of practical importance in both countries.

INTRODUCTION

In the process of planning and evaluating forest fire control activities, it is often desirable to have available quantitative expressions relating the effort expended in fire suppression and the results to be expected under various conditions. It is the purpose of this paper to introduce a mathematical method for the analysis of fire suppression (or fire containment) activity which can be used to derive such relationships. We show, by example, how the method can be applied to determine the burned area and the time required for suppression, using a simple but flexible expression for the shape of the fire.

In addition, we explore the sensitivity of the burned area and the time required for suppression to the following factors:

- (1) The size of the fire at the start of suppression.
- (2) The rate of spread of the fire in the front, flank, and back directions, and a parameter describing the shape of the fire.
- (3) The rate of suppression (or rate of control line construction).
- (4) The tactics employed.

In the following section we introduce the basic concepts of and the limitations on the method of analysis and present the general analytical forms. In subsequent sections we introduce simplifying assumptions, present examples, and extend the analysis to the situations requiring a change of tactics to stop a rapidly spreading head fire.

BASIC CONCEPTS AND LIMITATIONS OF METHODS

We seek to describe analytically the rate and direction of progress of a fire-suppression force as a function of the shape and rate of growth of a fire. For this purpose, we assume that the work proceeds, if possible, at the edge of the fire. It is not important whether the effort is directed toward extinguishing the flames (direct suppression in U.S. fire control terminology), or toward construction of a barrier across which the fire will not spread. The mathematical description of the rate of containment is the same. But it is necessary to restrict our attention to fires which do not spread by spotting and which have a perimeter that is a smooth curve.

If the fire meets the conditions described and the work of suppression (or containment) proceeds at the fire edge, it is possible to determine the boundary of burned area and the time that the work will require, if the position of the fire edge can be expressed analytically as a function of position and time.

Employing polar coordinates, let $r(\theta, t)$ be the distance from the point of ignition to the edge of the fire at time t and in the direction given by the angle θ (measured from an arbitrary fixed direction). Here we insist that $r(\theta, t)$ be single valued, possess a positive time derivative, and be differentiable with respect to θ . If the rate of progress of a fire-suppression crew, working at the edge of the fire, can be expressed as $\lambda(\theta, t)$, then we can write the equations for the generation of the final boundary, $R(\theta)$.

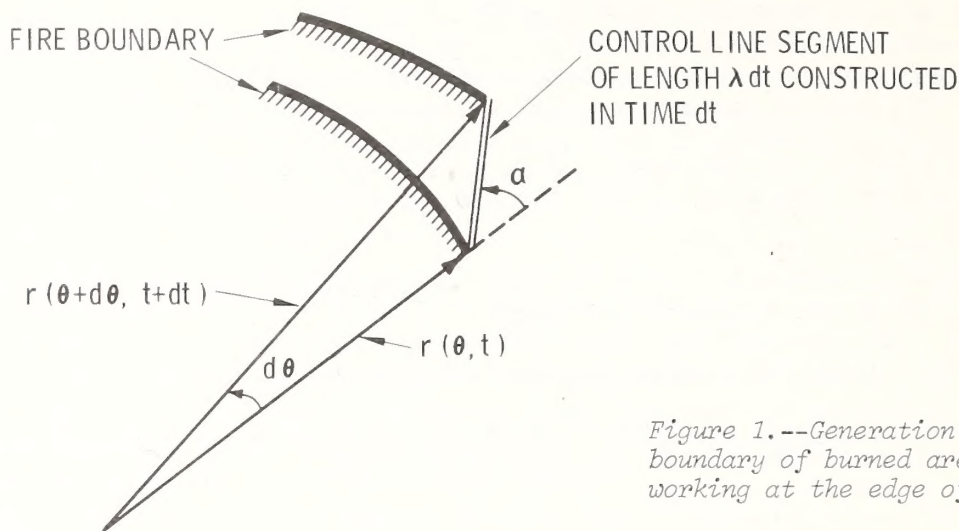

Figure 1.--Generation of final boundary of burned area by crew working at the edge of a fire.

Referring to figure 1, assume a differential element dt of time to elapse. During this time the crew will construct an element λdt of the final boundary. In order to remain in contact with the advancing edge of the fire, this element of the boundary curve must be constructed at an angle α (measured counterclockwise) with respect to the direction θ . We can write the formulae for the components of the arc λdt in the tangential and radial directions from inspection:

$$d\theta = (\lambda dt) \sin \alpha / r(\theta, t) \quad (1)$$

$$dR = (\lambda dt) \cos \alpha = r(\theta + d\theta, t + dt) - r(\theta, t) = \frac{\partial r}{\partial \theta} d\theta + \frac{\partial r}{\partial t} dt \quad (2)$$

Substituting $d\theta$ in equation 2 from equation 1, and employing the short notation

$$\frac{\partial r}{\partial \theta} = r' ; \frac{\partial r}{\partial t} = \dot{r}$$

we find

$$\lambda \cos \alpha = (r'/r) \lambda \sin \alpha + \dot{r} \quad (3)$$

Squaring both sides of equation 3 and solving for $\sin \alpha$ we obtain

$$\sin \alpha = \frac{-(\dot{r}/\lambda) (r'/r) + \sqrt{1 + (r'/r)^2 - (\dot{r}/\lambda)^2}}{1 + (r'/r)^2} \quad (4)$$

$$\cos \alpha = \frac{(\dot{r}/\lambda) + (r'/r) \sqrt{1 + (r'/r)^2 - (\dot{r}/\lambda)^2}}{1 + (r'/r)^2} \quad (5)$$

Equations 1 and 2 can be regarded as describing the evolution of the final boundary of the burned area, $R(\theta)$:

$$\frac{d\theta}{dt} = (\lambda/R) \sin \alpha \quad (6)$$

$$\frac{dR}{dt} = \lambda \cos \alpha \quad (7)$$

The last four equations can be used to model the final boundary, taking into consideration the limitations mentioned above.

Note that the condition required for eventual completion of the boundary is that the expression under the radical (equations 4 and 5) should be nonnegative, or

$$\lambda \geq \dot{r} / (1 + (r'/r)^2)^{1/2} \quad (8)$$

The right hand side of inequality 8 is the rate of advance of the edge of the fire in the direction perpendicular to the boundary, so the requirement is intuitively obvious. So long as inequality 8 is maintained the crew can make progress in containing the fire.

SIMPLIFYING ASSUMPTIONS

To gain further insight into the relative importance of the various factors outlined above, we introduce simplifying assumptions which permit closed form solutions of equations 6 and 7 and make possible numerical examples.

First, we assume that the shape of the free-burning fire can be expressed analytically and that the form of the fire is invariant. That is, the boundary of the fire simply expands linearly with time, and, similar to the enlargement of a photograph, maintains its shape. This assumption implies that the fire is fully developed and is burning in continuous, homogeneous fuel on flat terrain or gentle slopes, and that the wind does not change speed or direction. Such idealized conditions never occur exactly, but many fires approximately satisfy these conditions at least for short periods of time.

Since we assume that the fire boundary grows linearly with time, the shape of the fire, expressed in polar coordinates, is the same as the distribution of radial rates of

spread as a function of the polar angle. We establish the reference direction ($\theta = 0$) to be in the direction of the maximum rate of spread, and express the radial rate of spread as:

$$\dot{r}(\theta) = \begin{cases} V_f + (V_F - V_f) \cos^n \theta, & 0 \leq \theta \leq \pi/2 \\ V_B + (V_f - V_B) \sin^n \theta, & \pi/2 \leq \theta \leq \pi \end{cases} \quad (9)$$

where: V_F = the forward or frontal rate of spread

V_f = the rate of spread at the flank

V_B = the backing rate of spread

n = a shape parameter to be determined empirically for various fuel types.

This functional form is quite flexible, and can be used to generate a wide variety of shapes. Figure 2 displays some of the shapes generated by this formula; in the figure all shapes are normalized by the maximum dimension (that is, $\dot{r}(\theta)/V_f$ is plotted).

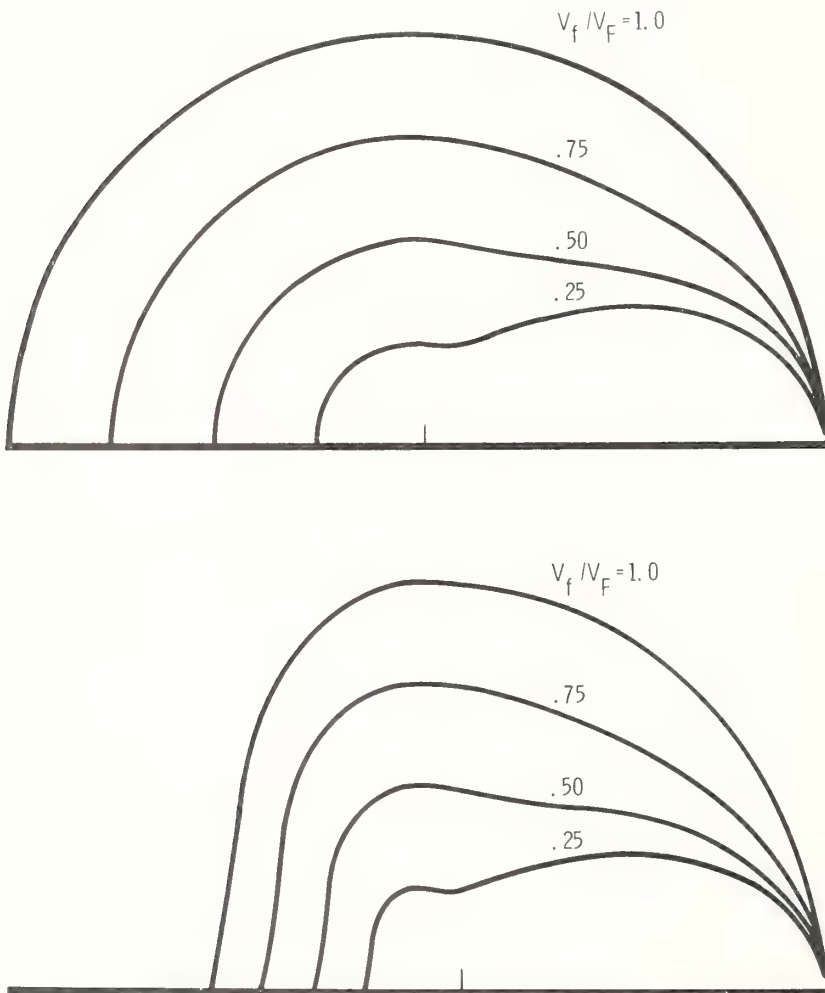

Figure 2.--Shapes of fires generated by equation 9. In all cases, the fire perimeter is drawn to a scale such that the distance from the point of ignition (tic mark on horizontal line) to the head of the fire (right-hand edge of each outline) is the same. In the upper figure $V_B/V_f = 1.0$; in the lower figure $V_B/V_f = 0.5$; for both figures $n = 4$.

Table 1.--Area and perimeter of free-burning fires
for different values of fire shape parameters

$\frac{V_f}{V_F}$	$\frac{V_B}{V_f}$	n = 1		n = 2		n = 4	
		Area	Perim	Area	Perim	Area	Perim
		$r^2(o)$	$r(o)$	$r^2(o)$	$r(o)$	$r^2(o)$	$r(o)$
0.1	0.25	0.841	3.33	0.641	2.92	0.475	2.64
	.50	.843	3.32	.644	2.92	.478	2.65
	.75	.845	3.33	.646	2.94	.481	2.67
	1.0	.848	3.35	.650	2.97	.485	2.71
0.2	.25	.922	3.53	.720	3.11	.549	2.84
	.50	.929	3.51	.728	3.12	.558	2.86
	.75	.938	3.53	.740	3.16	.571	2.91
	1.0	.948	3.58	.754	3.23	.589	3.00
0.3	.25	1.03	3.76	.825	3.34	.650	3.08
	.50	1.04	3.73	.844	3.35	.671	3.11
	.75	1.06	3.76	.869	3.41	.701	3.18
	1.0	1.09	3.83	.901	3.51	.741	3.31
0.4	.25	1.16	4.01	.956	3.60	.778	3.34
	.50	1.19	3.97	.990	3.61	.816	3.38
	.75	1.22	4.01	1.03	3.69	.870	3.49
	1.0	1.26	4.10	1.09	3.83	.940	3.65
0.5	.25	1.32	4.28	1.11	3.90	.935	3.64
	.50	1.36	4.24	1.17	3.91	.993	3.68
	.75	1.42	4.28	1.24	4.01	1.08	3.81
	1.0	1.48	4.40	1.32	4.18	1.19	4.03
0.6	.25	1.50	4.59	1.30	4.21	1.12	3.96
	.50	1.56	4.54	1.37	4.23	1.20	4.01
	.75	1.64	4.59	1.47	4.35	1.32	4.17
	1.0	1.74	4.73	1.60	4.55	1.48	4.43
0.7	.25	1.71	4.92	1.51	4.56	1.33	4.31
	.50	1.79	4.86	1.61	4.58	1.44	4.37
	.75	1.90	4.92	1.75	4.72	1.61	4.56
	1.0	2.03	5.08	1.92	4.95	1.82	4.85
0.8	.25	1.94	5.28	1.74	4.93	1.57	4.68
	.50	2.05	5.21	1.88	4.95	1.72	4.76
	.75	2.19	5.28	2.06	5.11	1.93	4.97
	1.0	2.36	5.46	2.29	5.38	2.22	5.31
0.9	.25	2.20	5.66	2.01	5.31	1.84	5.08
	.50	2.34	5.58	2.17	5.34	2.03	5.16
	.75	2.52	5.66	2.40	5.52	2.30	5.40
	1.0	2.73	5.86	2.69	5.82	2.65	5.78
1.0	.25	2.49	6.05	2.29	5.72	2.13	5.51
	.50	2.66	5.97	2.50	5.75	2.36	5.60
	.75	2.88	6.05	2.79	5.95	2.70	5.86
	1.0	3.14	6.28	3.14	6.28	3.14	6.28

Throughout the rest of this paper we will employ dimensionless forms for all parameters and results. Table 1 gives values for the perimeter length and the area of various fire shapes generated using equation 9. In this table the perimeter length is normalized by $r(0)$ and the area by $r^2(0)$, where $r(0)$ is the distance from the point of origin to the head (or front) of the fire. These values may be used to compare sensitivities in absolute terms, because later results will be given in terms of the initial fire perimeter length and initial fire area.

The second simplifying assumption we make is that the fire is to be suppressed (or contained) through the work of two crews which divide the effort equally. This assumption not only introduces the simplification of mathematical symmetry, but reflects current practice both in the United States and the Soviet Union. The advantage of this tactic is clear upon a little thought: If the work of suppression proceeds in only one direction from the starting point, then when the crew completes its circuit around the fire edge, it will encounter the fire burning behind the original line of control near the starting point. If the work proceeds in both directions from the starting point, then when the two teams meet on the opposite edge of the fire the containment will be complete.

The third assumption employed here is that the rate of progress by the suppression crew (λ) is constant. This is a good approximation for machine-aided effort, but is clearly not a good approximation for work with handtools or backpack pumps (with the possible exception of the new Soviet technique of backfiring against a line of foam laid down using a backpack cannister). It would be a little more complex to assume that the rate of suppression is a simple function of the rate of advance of the fire edge perpendicular to the boundary (see inequality 8) which quantity is proportional to the fire intensity as defined by Byram (1959). For instance, one might argue that direct suppression will progress at a rate inversely proportional to the depth of the flaming zone. This depth is, in turn, approximately proportional to the rate of advance of the fire edge (Albini 1976). For the purpose of exploring the sensitivity of burned area and time required for containment to various factors, however, it is sufficient to use a constant work rate.

Using these simplifying assumptions it is possible to write closed form expressions for the burned area and the time expended. Dividing equation 7 by equation 6 and integrating we obtain the formula for the shape of the final boundary:

$$R(\theta) = R(\theta_0) \exp \left(\int_{\theta_0}^{\theta} f(\theta') d\theta' \right) \quad (10)$$

In this equation the function to be integrated is

$$f(\theta) = \frac{\dot{r}/\lambda + (r'/r) \sqrt{1 + (r'/r)^2 - (\dot{r}/\lambda)^2}}{- (r'/r) (\dot{r}/\lambda) + \sqrt{1 + (r'/r)^2 - (\dot{r}/\lambda)^2}} \quad (11)$$

which is, under our assumptions, purely a function of the angle θ , since $\dot{r}(\theta)$ is given by equation 9 and

$$r'/r = \left(\frac{d}{d\theta} \dot{r}(\theta) \right) / \dot{r}(\theta) \quad (12)$$

Note that the value of $R(\theta)$ depends upon the choice of the starting point, θ_0 . If the effort begins at the front edge of the fire on the line of symmetry, then

$$\theta_0 = 0; R(\theta_0) = r_0(0) \quad (13)$$

where $r_o(0)$ is distance from the point of ignition to the front edge of the fire at the time the suppression work begins. If, however, the work begins at the back edge of the fire, then

$$\theta_o = \pi; R(\theta_o) = (V_B/V_F) r_o(0) \quad (14)$$

Figure 3 shows examples of final fire shapes computed according to equation 10. Both tactics are illustrated in each sketch of figure 3; the upper half of each diagram shows the result of attacking the head fire first and the lower half shows the result of attacking the backing fire first.

The time required to complete the work (Δt) is obtained from equations 4, 6, and 10:

$$\Delta t = (R(\theta_o)/\lambda) \int_{\theta_o}^{\theta_o + \pi} \left\{ \exp\left(\int_{\theta_o}^{\theta} f(\theta') d\theta'\right) / \sin \alpha \right\} d\theta \quad (15)$$

where $\sin \alpha$ is given by equation 4.

The total burned area (S) is given simply by

$$S = \int_0^{\pi} R^2(\theta) d\theta = R^2(\theta_o) \int_{\theta_o}^{\theta_o + \pi} \exp\left(2 \int_{\theta_o}^{\theta} f(\theta') d\theta'\right) d\theta \quad (16)$$

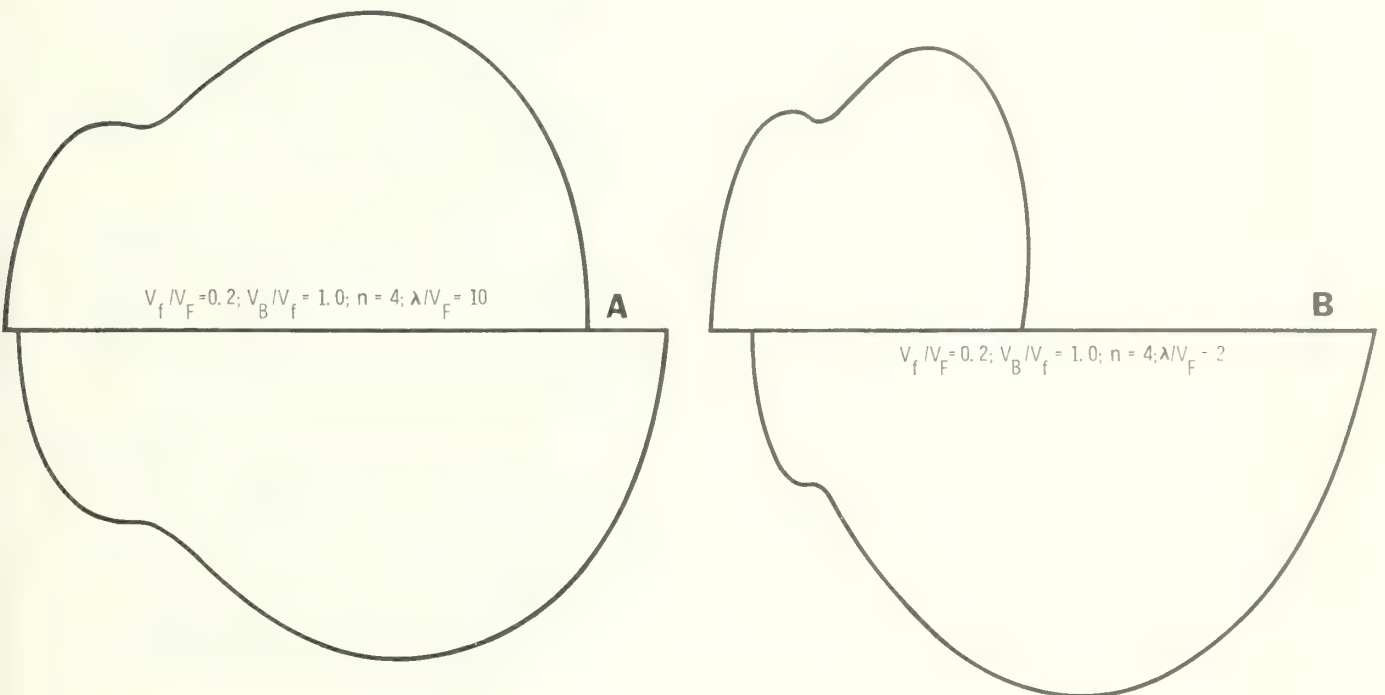

Figure 3.--Shape of burned area for successfully contained fires according to equation 10. In each sketch, the upper half corresponds to attacking the head fire first and the lower half corresponds to attacking the same fire from the back. The fire shape parameters are given in each sketch (see equation 9). Ratio λ/V_F is the rate of line construction divided by the forward rate of spread.

SENSITIVITY ANALYSIS

The functional forms derived above are admittedly complicated, but the evaluation of such expressions is relatively easy with the aid of modern digital computers. These equations were programmed and evaluated on both the EC-1020 computer at the Leningrad Forestry Research Institute and the CDC-7600 at the Lawrence Berkeley Laboratory's computer facility on the campus of the University of California at Berkeley.

The results of these computations are displayed in tables 2, and 3. Table 2 gives values of the area burned divided by the area of the fire at the time suppression begins. Table 3 gives values of the time required to contain the fire (Δt), multiplied by the rate of suppression (λ), and divided by the perimeter of the fire at the time suppression starts. Since the product $\lambda \Delta t$ is numerically equal to the length of perimeter of the burned area, the values in table 3 are also equal to the ratios of final perimeters to initial perimeters.

In terms of area burned (table 2) we can conclude that the tactic of suppressing the head fire first (tactic 2) is significantly superior (>50 percent) to suppressing the backing fire first only when the head fire spreads at approximately 3 times the rate of the backing fire and the rate of suppression is no more than 3 times the forward rate of spread. For rates of suppression 5 times the head fire rate of spread or greater, neither fire shape nor tactics alter the burned area substantially. For fires which show little directional difference in spread rate ($V_F/V_B < 3$) the choice of tactics is of little consequence unless $\lambda \leq 3V_F$.

The sensitivity of the burned area to the ratio of suppression rate to forward rate of spread (λ/V_F) is less in the case of tactic 2 than in the case of tactic 1, for fixed fire shape parameters ($V_f/V_F, V_B/V_f, n$). Conversely, the sensitivity of the burned area to fire shape parameters for fixed values of λ/V_F is much greater for tactic 2 than for tactic 1, but in either case the sensitivity to the value of n is less than the sensitivity to V_f/V_F . The latter parameter becomes increasingly important as λ/V_F approaches one, for both tactics.

The statements made above also apply to the time required for containment (table 3). In general, the time required for containment varies less than does the burned area, no matter which variable is considered. Significant differences (>50 percent) between tactics appear only for fires for which the forward spread rate much exceeds the flanking rate ($V_f/V_F < 0.4$), except for the case when fire suppression is almost impossible ($\lambda/V_F = 1.5$). As in the case of burned area, the containment time is more sensitive to fire shape under tactic 2 than under tactic 1, but the converse is true for sensitivity to suppression rate for fixed fire shape.

It should be stressed that the area and perimeter ratios given in tables 2 and 3 are to their values at the time suppression begins. In order to establish the values of burned area and containment time, these numbers must be multiplied by initial area (table 2) or by the ratio of initial perimeter length to rate of suppression (table 3). Because of this fact, one can conclude that the sensitivity of actual burned area to initial fire size ($r^2(0)$ used to normalize entries in table 1) is simply magnified by the factors in table 2.

Table 2.--Burned area/initial fire area for two suppression tactics and various fire shape factors. λ/V_F is the ratio of suppression rate to forward rate of spread; V_f is the flanking rate of spread and V_B the backing rate; n is another shape parameter (see fig. 1)

λ/V_F		Tactic 1 : attack backing fire first						Tactic 2 : attack head fire first						
		n = 1		n = 2		n = 4		n = 1		n = 2		n = 4		
		V_f/V_F	V_B/V_f	0.5	1.0	0.5	1.0	0.5	1.0	0.5	1.0	0.5	1.0	0.5
100	0.2		1.02	1.02	1.02	1.02	1.02	1.02	1.01	1.01	1.01	1.01	1.01	1.01
	.4		1.03	1.03	1.02	1.02	1.02	1.02	1.02	1.02	1.01	1.02	1.01	1.02
	.6		1.03	1.03	1.03	1.03	1.02	1.02	1.02	1.02	1.02	1.02	1.02	1.02
	.8		1.03	1.03	1.03	1.03	1.03	1.03	1.02	1.03	1.02	1.03	1.02	1.03
	1.0		1.03	1.03	1.03	1.03	1.03	1.03	1.03	1.03	1.03	1.03	1.02	1.03
10	.2		1.28	1.29	1.25	1.26	1.23	1.24	1.12	1.13	1.10	1.11	1.09	1.10
	.4		1.30	1.30	1.27	1.27	1.25	1.25	1.16	1.18	1.14	1.17	1.13	1.17
	.6		1.33	1.32	1.30	1.30	1.29	1.29	1.21	1.24	1.19	1.23	1.18	1.23
	.8		1.37	1.35	1.35	1.34	1.34	1.33	1.26	1.31	1.25	1.31	1.23	1.31
	1.0		1.42	1.39	1.40	1.39	1.40	1.39	1.33	1.33	1.31	1.39	1.29	1.39
5	.2		1.69	1.69	1.60	1.62	1.55	1.56	1.26	1.28	1.22	1.24	1.19	1.22
	.4		1.74	1.74	1.66	1.66	1.60	1.61	1.36	1.40	1.31	1.37	1.29	1.36
	.6		1.82	1.80	1.75	1.74	1.70	1.70	1.48	1.57	1.43	1.54	1.40	1.53
	.8		1.94	1.90	1.88	1.87	1.84	1.84	1.63	1.77	1.58	1.76	1.54	1.75
	1.0		2.11	2.03	2.06	2.03	2.04	2.03	1.82	2.03	1.76	2.03	1.72	2.03
3	.2		2.57	2.58	2.34	2.37	2.20	2.23	1.49	1.52	1.40	1.44	1.34	1.39
	.4		2.73	2.70	2.49	2.50	2.33	2.35	1.70	1.80	1.59	1.73	1.53	1.70
	.6		2.97	2.89	2.75	2.73	2.59	2.59	1.99	2.21	1.86	2.14	1.78	2.11
	.8		3.37	3.21	3.17	3.11	3.03	3.03	2.39	2.80	2.24	2.75	2.13	2.72
	1.0		3.98	3.70	3.80	3.70	3.72	3.70	2.99	3.70	2.81	3.70	2.66	3.70
2.5	.2		3.26	3.28	2.90	2.95	2.69	2.74	1.63	1.67	1.50	1.55	1.42	1.49
	.4		3.52	3.49	3.14	3.16	2.89	2.92	1.92	2.07	1.77	1.95	1.67	1.90
	.6		3.94	3.80	3.56	3.53	3.30	3.31	2.34	2.67	2.15	2.56	2.02	2.50
	.8		4.65	4.36	4.28	4.19	4.05	4.04	2.98	3.64	2.73	3.55	2.55	3.49
	1.0		5.82	5.30	5.48	5.30	5.31	5.30	4.00	5.30	3.68	5.30	3.44	5.30
2.0	.2		4.91	4.95	4.19	4.28	3.79	3.88	1.88	1.94	1.68	1.76	1.55	1.65
	.4		5.47	5.39	4.66	4.70	4.18	4.23	2.34	2.59	2.08	2.38	1.93	2.28
	.6		6.40	6.11	5.55	5.49	5.00	5.02	3.07	3.67	2.71	3.44	2.49	3.32
	.8		8.14	7.47	7.24	7.05	6.65	6.67	4.30	5.70	3.81	5.49	3.45	5.33
	1.0		11.5	10.1	10.5	10.1	10.0	10.1	6.67	10.1	5.94	10.1	5.41	10.1
1.5	.2		12.0	12.1	9.35	9.63	8.00	8.27	2.52	2.64	2.09	2.23	1.84	2.01
	.4		14.3	14.0	11.1	11.2	9.26	9.45	3.50	4.06	2.86	3.48	2.50	3.20
	.6		18.7	17.4	14.6	14.5	12.2	12.4	5.35	7.10	4.31	6.23	3.70	5.74
	.8		28.8	25.4	23.3	22.7	19.9	20.5	9.55	15.3	7.68	14.1	6.48	13.2
	1.0		58.3	48.9	49.4	48.9	44.9	48.9	22.3	48.9	18.2	48.9	15.6	48.9

Table 3.--Time required to contain a fire for two suppression tactics and various fire shape factors. λ/V_F is the ratio of suppression rate to forward rate of spread; V_f is the flanking rate of spread and V_B is the backing rate; n is another shape parameter (see fig. 1). Entries in table are $(\lambda \times \text{containment time}/\text{initial perimeter})$, so are numerically equal to the final perimeter/initial perimeter

λ/V_F		Tactic 1 : attack backing fire first						Tactic 2 : attack head fire first						
		n = 1		n = 2		n = 4		n = 1		n = 2		n = 4		
		$\frac{V_B}{V_F}$	$\frac{V_f}{V_F}$	0.5	1.0	0.5	1.0	0.5	1.0	0.5	1.0	0.5	1.0	0.5
100	0.2	1.01	1.01	1.01	1.01	1.01	1.01	1.01	1.01	1.01	1.01	1.01	1.00	1.00
	.4	1.01	1.01	1.01	1.01	1.01	1.01	1.01	1.01	1.01	1.01	1.01	1.01	1.01
	.6	1.01	1.01	1.01	1.01	1.01	1.01	1.01	1.01	1.01	1.01	1.01	1.01	1.01
	.8	1.02	1.01	1.01	1.01	1.01	1.01	1.01	1.01	1.01	1.01	1.01	1.01	1.01
	1.0	1.02	1.02	1.02	1.02	1.02	1.01	1.02	1.01	1.02	1.01	1.02	1.01	1.02
10	.2	1.13	1.13	1.12	1.12	1.12	1.12	1.06	1.07	1.05	1.05	1.04	1.04	
	.4	1.14	1.14	1.13	1.13	1.13	1.13	1.08	1.09	1.07	1.08	1.06	1.07	
	.6	1.15	1.15	1.14	1.15	1.14	1.14	1.10	1.12	1.09	1.11	1.08	1.11	
	.8	1.17	1.16	1.16	1.16	1.16	1.16	1.13	1.15	1.12	1.14	1.11	1.14	
	1.0	1.19	1.18	1.18	1.18	1.18	1.18	1.15	1.18	1.15	1.18	1.14	1.18	
5	.2	1.30	1.30	1.28	1.28	1.27	1.27	1.13	1.14	1.10	1.11	1.08	1.09	
	.4	1.32	1.32	1.30	1.30	1.29	1.29	1.17	1.19	1.14	1.17	1.12	1.16	
	.6	1.35	1.35	1.33	1.33	1.32	1.32	1.22	1.26	1.20	1.24	1.18	1.23	
	.8	1.39	1.38	1.38	1.38	1.36	1.37	1.28	1.33	1.26	1.33	1.24	1.32	
	1.0	1.45	1.43	1.43	1.43	1.42	1.43	1.36	1.43	1.34	1.43	1.32	1.43	
3	.2	1.61	1.61	1.57	1.57	1.54	1.55	1.25	1.26	1.18	1.20	1.14	1.17	
	.4	1.66	1.66	1.61	1.62	1.58	1.59	1.32	1.36	1.26	1.31	1.22	1.28	
	.6	1.74	1.72	1.69	1.69	1.65	1.66	1.42	1.50	1.37	1.46	1.33	1.44	
	.8	1.84	1.81	1.79	1.79	1.76	1.78	1.56	1.69	1.51	1.67	1.47	1.65	
	1.0	2.00	1.95	1.95	1.95	1.92	1.95	1.74	1.95	1.69	1.95	1.66	1.95	
2.5	.2	1.83	1.83	1.76	1.77	1.73	1.73	1.31	1.33	1.23	1.26	1.17	1.21	
	.4	1.90	1.89	1.83	1.83	1.78	1.79	1.41	1.46	1.33	1.40	1.28	1.36	
	.6	2.01	1.98	1.93	1.93	1.88	1.90	1.55	1.65	1.47	1.60	1.42	1.57	
	.8	2.17	2.13	2.10	2.10	2.05	2.07	1.74	1.93	1.67	1.90	1.62	1.88	
	1.0	2.42	2.34	2.35	2.34	2.30	2.34	2.01	2.34	1.95	2.34	1.90	2.34	
2.0	.2	2.28	2.28	2.16	2.17	2.10	2.11	1.43	1.45	1.31	1.34	1.23	1.27	
	.4	2.40	2.38	2.27	2.28	2.19	2.21	1.57	1.65	1.45	1.55	1.37	1.49	
	.6	2.59	2.55	2.45	2.45	2.36	2.39	1.78	1.95	1.66	1.87	1.58	1.81	
	.8	2.91	2.82	2.76	2.76	2.66	2.71	2.10	2.44	1.98	2.38	1.90	2.34	
	1.0	3.42	3.27	3.28	3.27	3.18	3.27	2.61	3.27	2.48	3.27	2.40	3.27	
1.5	.2	3.72	3.72	3.42	3.43	3.24	3.26	1.70	1.74	1.48	1.54	1.35	1.41	
	.4	4.04	4.01	3.68	3.69	3.47	3.50	1.96	2.10	1.72	1.89	1.58	1.77	
	.6	4.60	4.48	4.18	4.18	3.91	3.98	2.38	2.75	2.12	2.54	1.95	2.40	
	.8	5.66	5.40	5.16	5.16	4.82	4.98	3.15	4.07	2.84	3.88	2.63	3.74	
	1.0	7.93	7.45	7.32	7.45	6.93	7.45	4.77	7.45	4.38	7.45	4.13	7.45	

Since the initial fire area is equal to the square of $r_o(0)$ multiplied by a shape factor (table 1) which decreases as the fire becomes more elongated in shape (V_f/V_F , V_B/V_f decreasing, n increasing), one can assert that the initial fire area is of extreme importance in determining final burned area.

The time required for containment can be found in ratio to the idealized time elapsed from ignition to the beginning of suppression through the following relationships:

$$\Delta t_s = r_o(0)/V_F, \quad (17)$$

$$\Delta t = (P_o/\lambda) (\lambda \Delta t/P_o), \quad (18)$$

where

Δt_s = idealized time between ignition and start of suppression

Δt = time required for containment

P_o = fire perimeter length at the start of suppression

$(\lambda \Delta t/P_o)$ = values given in table 3.

Dividing equation 17 by equation 18, we find

$$\Delta t/\Delta t_s = (P_o/r_o(0)) (\lambda \Delta t/P_o)/(\lambda/V_F) \quad (19)$$

where values of $(P_o/r_o(0))$ are tabulated in table 1.

Note, however, that while the values given in table 1 are limited to the range $2 \leq P_o/r_o(0) \leq 2\pi$, the ratio $(\lambda \Delta t/P_o)/(\lambda/V_F)$ can take on a very wide range of values. To find the value of this highly variable quantity, one merely divides the entries in table 3 by the values of (λ/V_F) given in the left most column. When this is done one obtains, approximately, the ratio of the time required for containment to the idealized time since ignition, because the value of $P_o/r_o(0)$ is of the order of unity. In this way one readily sees that one of the most important factors in determining the time required for containment is the rate of suppression in ratio to the forward rate of spread (λ/V_F). This parameter is far more influential than fire shape or choice of tactics. The idealized time since ignition (Δt_s) is the normalizing value for Δt in equation 19, and is very important when λ/V_F is less than about three. When λ/V_F falls below three, the ratio $\Delta t/\Delta t_s$ (according to equation 19 and table 3) becomes greater than one under tactic 1. Under tactic 2 the ratio is generally greater than one when λ/V_F is less than 2.5.

From this sensitivity analysis we can reinforce conventional wisdom with regard to the two most important factors in determining the burned area and time required for containment: (1) minimize the time between ignition and start of suppression (Δt_s , and indirectly, $r_o(0)$); and (2) use the maximum available suppression force (λ). In addition we have established a means of quantifying the influence of these factors for the purpose of assessing overall effectiveness of fire suppression forces.

CHANGING TACTICS: INDIRECT ATTACK ON RAPID HEAD FIRE

In the mathematical formulations above, a necessary condition for successful containment of a fire is that $\lambda > V_F$, or that the rate of suppression must exceed the forward rate of spread of the fire. But as every firefighter knows, this condition can be violated and yet the fire can be contained. If the head fire is advancing too rapidly to be contained by suppression action at the edge of the fire, in many cases the firefighting team will construct a "fire break" or barrier ahead of the advancing fire to stop its forward progress. Then working against the flanking fire either from the forward or the rear direction, the encirclement can be completed by work at the edge of the fire.

In figure 4 we sketch such an attack against a rapidly advancing head fire. The first step, shown in figure 4a, is to establish a barrier ahead of the fire, perpendicular to the direction of maximum rate of spread. When the fire reaches this barrier, as shown in figure 4b, work proceeds back toward the flanks of the fire. When the crew meets the advancing edge of the fire, as shown in figure 4c, work can proceed at the edge of the fire from that point on around to the rear, since the perpendicular rate of fire spread at the point of meeting is less than the rate of suppression.

For the purpose of carrying out a mathematical analysis of this tactic, we idealize the situation as follows:

- (1) Work proceeds symmetrically, by two crews, and the rate of line construction is everywhere the same ($=\lambda$, as before).
- (2) At the instant the forward edge of the fire reaches the perpendicular barrier, the crews change direction of work and proceed in straight lines back toward the fire flanks.
- (3) The direction chosen for the second straight segment of barrier line is such as to bring the crew into contact with the edge of the fire in a direction tangent to the instantaneous fire boundary.

Clearly there is a mathematical solution to the problem of choosing the best distance (a) ahead of the fire front, and likewise a best (probably curved) path to follow to bring the crews into contact with the edge of the fire. Such a solution would be interesting as a mathematical problem, but of little practical significance. The idealization chosen is, hopefully, a compromise between mathematical perfection and realizable practice. It should be noted that this idealization is not tied to any particular method of line construction (machine-aided hand line, hand line with back firing, machine construction, explosive construction, etc.)

The use of the tactic as described would be rare in the United States and is infrequent in the Soviet Union. But, when conditions permit its use with due regard for crew safety, the reward in terms of burned area and time of control can be substantial in some cases.

As the procedure is outlined above, for any given set of fire shape parameters (V_f/V_F , V_B/V_F , and n) and given value of λ/V_F , the final area and perimeter are completely determined by the choice of a value for the distance (a) ahead of the fire at which the initial barrier is constructed. We normalize this distance by the initial distance from the point of ignition to the front of the fire, $r_0(0)$.

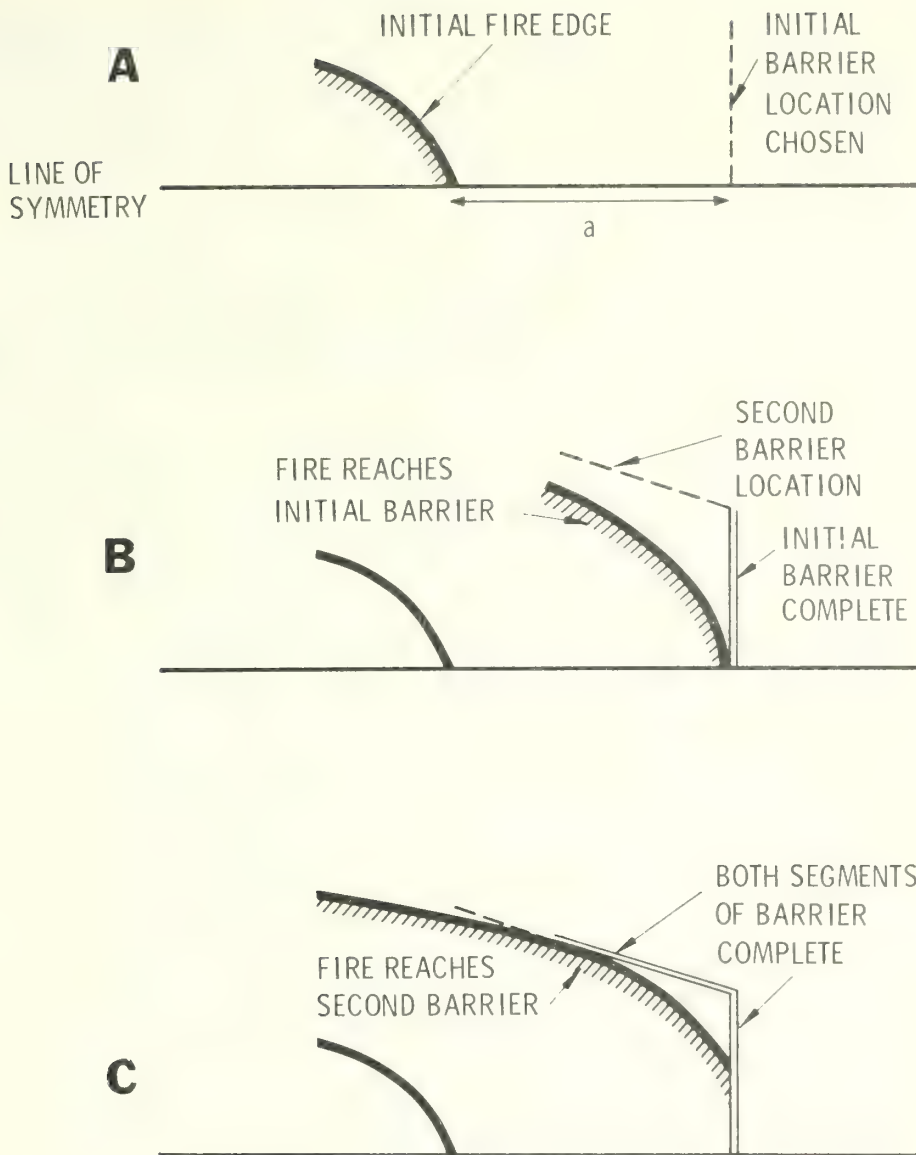

Figure 4A.--The first step in controlling a rapid head fire is the construction of a barrier at distance "a" ahead of the initial fire location. B: Construction of the second segment of the barrier starts when the fire reaches the first segment. C: Work proceeds against the flanking fire, by direct attack, when the fire reaches the second barrier segment.

Clearly a best choice exists for the value $a/r_0(0)$. If "a" is too small, the fire will reach the barriers very quickly, and contact with the edge of the fire will occur at a position near the line of symmetry; if this contact occurs where inequality 8 is violated, control will not be possible. If "a" is too large, the initial barrier will be unnecessarily long and much time will be wasted before contact with the fire edge is made; indeed if "a" is sufficiently large, the second barrier will contact the edge of the fire at a point to the rear of the fire flank, resulting in much unnecessary burned area.

Table 4.--Values of burned area/initial area and final perimeter length/initial perimeter length when the suppression tactic is to build barriers ahead of the fire as sketched in figure 4. Also, tabulated is the first barrier distance ahead of the fire (a) divided by $r_0(0)$, the distance from the point of ignition to the head of the fire. λ is the rate of suppression, V_f the forward rate of spread, and V_f the flanking rate; n is a fire shape parameter (see figure 2)

$\frac{\lambda}{V_f}$	$\frac{V_f^*}{V_f}$	Minimum values of						First barrier location, $a/r_0(0)$					
		Burned area			Perimeter length			For minimum			For minimum		
		initial area			initial perimeter			burned area			perimeter length		
		n=1	n=2	n=4	n=1	n=2	n=4	n=1	n=2	n=4	n=1	n=2	n=4
2	0.1	1.72	1.54	1.42	1.36	1.25	1.17	0.04	<.02	<.02	0.06	0.05	0.03
	.2	1.87	1.67	1.55	1.41	1.30	1.22	.04	.04	<.02	.07	.05	.03
	.3	2.07	1.85	1.72	1.48	1.36	1.29	.05	.04	<.02	.07	.06	.03
1.5	.1	2.15	1.81	1.60	1.55	1.36	1.24	.10	.07	.04	.13	.09	.05
	.2	2.43	2.04	1.81	1.64	1.44	1.32	.10	.07	.04	.15	.10	.06
	.3	2.82	2.35	2.09	1.75	1.54	1.42	.12	.08	.04	.16	.11	.06
1.25	.1	2.66	2.10	1.77	1.75	1.48	1.31	.14	.09	.06	.19	.12	.07
	.2	3.11	2.43	2.07	1.88	1.59	1.42	.15	.10	.07	.22	.13	.08
	.3	3.78	2.92	2.48	2.04	1.73	1.55	.18	.13	.08	.25	.15	.08
1.0	.1	3.96	2.70	2.11	2.19	1.70	1.44	.34	.20	.11	.39	.23	.13
	.2	4.98	3.32	2.58	2.42	1.87	1.59	.38	.22	.13	.44	.25	.16
	.3	6.65	4.28	3.29	2.75	2.10	1.79	.45	.26	.15	.49	.28	.18
0.9	.1	5.34	3.21	2.34	2.57	1.86	1.52	.54	.29	.15	.59	.31	.15
	.2	7.13	4.09	2.96	2.93	2.08	1.70	.62	.32	.17	.66	.35	.19
	.3	10.3	5.54	3.93	3.44	2.40	1.96	.72	.37	.20	.76	.40	.21
0.8	.1	9.44	4.19	2.73	3.42	2.14	1.64	1.12	.47	.23	1.12	.47	.24
	.2	14.3	5.65	3.60	4.14	2.46	1.88	1.37	.54	.26	1.37	.55	.27
	.3	25.3	8.31	5.04	5.37	2.95	2.22	1.78	.65	.30	1.78	.65	.31
0.7	.1	41.0	6.88	3.54	7.10	2.73	1.87	3.50	.90	.40	3.50	.90	.40
	.2	116.0	10.5	5.12	11.7	3.33	2.23	5.80	1.10	.50	5.80	1.10	.50
	.3		18.2	7.89		4.36	2.77	>10	1.40	.60	>10	1.40	.60

* For all cases, $V_B/V_f = 0.5$

Table 4 presents the results of repetitive calculations of burned area and final perimeter for several fire shapes and various ratios of the rate of suppression to the forward rate of spread. Also shown in table 4 are the best values of a/r_0 for achieving the minimum burned area or the minimum containment time. The value of a/r_0 which minimizes the burned area does not necessarily simultaneously minimize the final perimeter length.

The striking feature of the entries in table 4 is the low values of burned area and perimeter length achievable using this tactic. A comparison of the entries in table 2 and 3 with those in table 4 for the same conditions shows that this "indirect attack" tactic does not increase the burned area or extend the time of containment significantly when $\lambda/V_F < 2$, compared to the aggressive tactic of direct attack at the head of the fire. And for such low values of λ/V_F this tactic is highly preferable to the tactic of approaching the fire from the back.

Figures 5 and 6 exhibit the sensitivity of burned area and final perimeter to the choice of first barrier location. The location of the first barrier to minimize burned area will result in a containment time not very different from the minimum value. Conversely, if the barrier is located to minimize containment time, very little area beyond the minimum will be burned. Figures 7 and 8 show graphically the sensitivity of the optimum barrier location to the rate of suppression and fire shape. The similarity of the curves in figures 5 and 7 and in figures 6 and 8 again illustrates that the criterion for optimization of the barrier location is not significant if the fire shape, suppression rate, and forward fire spread rate are known.

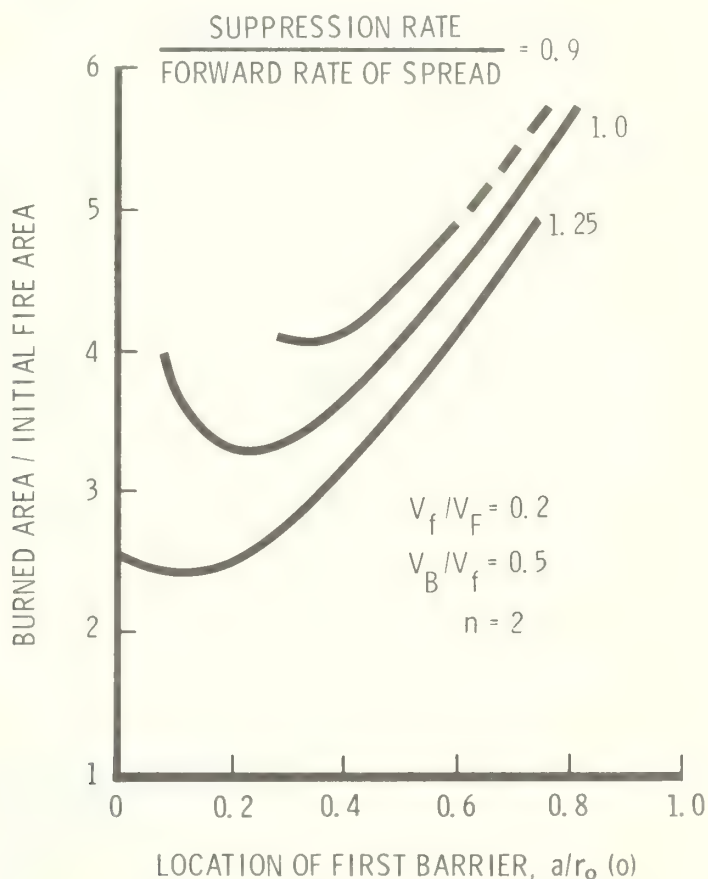

Figure 5.--Sensitivity of burned area to the choice of first barrier location.

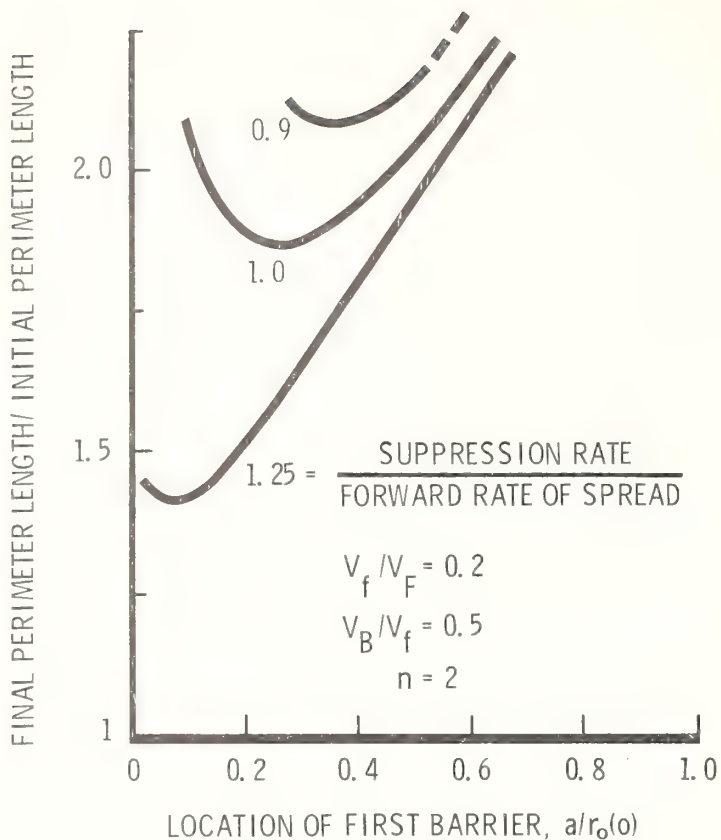

Figure 6.--Sensitivity of final perimeter to the choice of first barrier location.

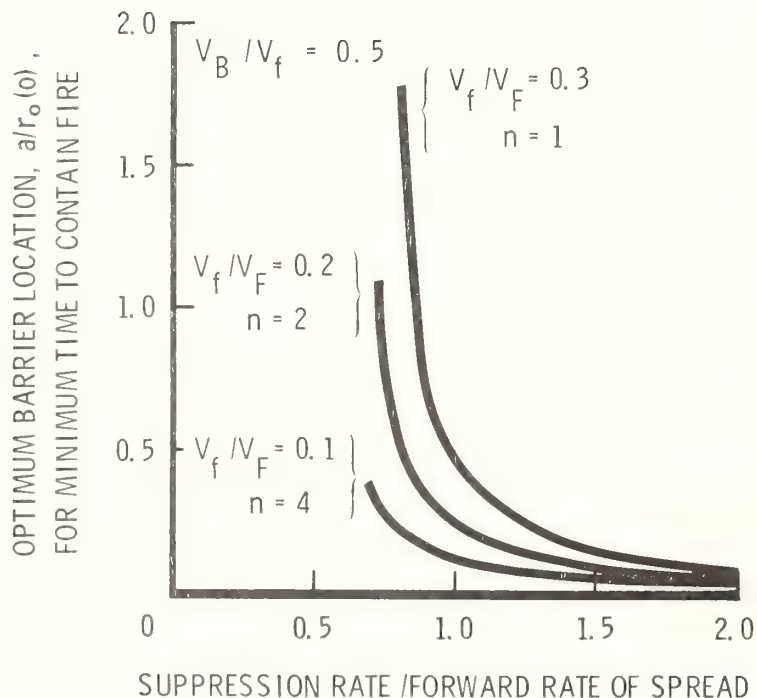
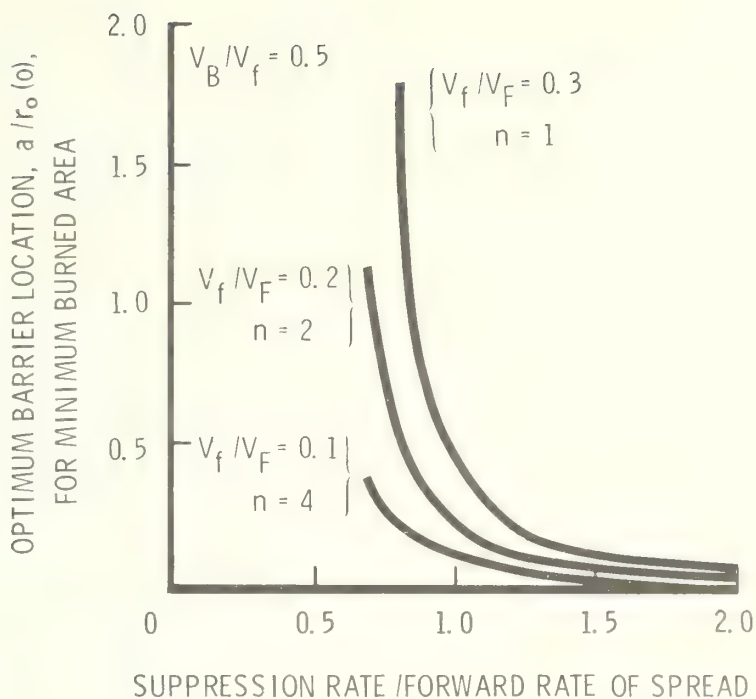

Figure 7.--Sensitivity of optimum (minimum burned area) location of first barrier to suppression rate and fire shape.

Figure 8.--Sensitivity of optimum (minimum containment time) location of first barrier to suppression rate and fire shape.



But this series of figures also tells another story of sensitivity. Note that a small "error" in barrier placement is inconsequential so long as λ/V_F , V_f/V_F , and n are properly chosen. But improper choice of fire shape or rate variables can lead to a catastrophic miscalculation. For example, assume that $V_f/V_F = 0.2$, $n = 2$ describes the shape of the forward edge of the fire. So if λ/V_F is estimated to be 1.0, then from either figure 7 or figure 8, a choice of $a/r_0(0)$ in the range 0.22-0.25 is indicated. Such a choice would result in a burned area of no more than 3.5 times the initial area, and a final perimeter approximately 1.9 times the initial perimeter. However, if the value of the suppression rate had been overestimated by 10 percent or the forward rate of spread underestimated by a similar amount, we should refer to the curves labeled "0.9" in figures 5 and 6. On these curves, any value of $a/r_0(0)$ less than 0.28 results in no solution. In other words, any barrier location closer than the critical value of $0.28 r_0(0)$ from the forward edge of the fire will not allow sufficient time to the crew to achieve a "capture" condition when the work reaches the edge of the fire.

Because of this sensitivity and the severity of such an error, an "optimum" choice for the first barrier location is not of practical significance. Some substantial "margin of safety" must be considered in the selection of the initial barrier location whenever $\lambda \sim V_F$. For this reason, table 5 is presented, showing the burned area and perimeter ratio for the same conditions as in table 4, except that the initial barrier location is chosen to be twice the value which minimizes the burned area. This table, therefore, incorporates a "margin of safety" of 100 percent in the deviation from optimum. A comparison of the values in tables 4 and 5 reveals that the "penalty" paid for this margin of safety is not severe in most cases.

Table 5.--Values of burned area/initial area and final perimeter length/initial perimeter length when the suppression tactic is to build barriers ahead of the fire as sketched in figure 4. In this table, the barrier location, a , is chosen to be twice the value which minimizes the burned area using this tactic (see table 4). This "margin of safety" is introduced to accommodate the practical difficulty of estimating forward rate of spread and/or suppression rate to high accuracy

$\frac{\lambda}{V_F}$	$\frac{V_F^*}{V_F}$	n = 1			n = 2			n = 4		
		$\frac{a}{r_0(0)}$	Burned area	Final perimeter	$\frac{a}{r_0(0)}$	Burned area	Final perimeter	$\frac{a}{r_0(0)}$	Burned area	Final perimeter
2.0	0.1	0.08	1.73	1.36	0.04	1.54	1.25	0.04	1.42	1.17
	.2	.08	1.88	1.42	.07	1.69	1.30	.04	1.56	1.23
	.3	.09	2.08	1.48	.08	1.86	1.36	.05	1.73	1.29
1.5	.1	.19	2.24	1.56	.14	1.88	1.38	.07	1.62	1.25
	.2	.21	2.52	1.65	.15	2.10	1.46	.08	1.84	1.34
	.3	.23	2.94	1.77	.16	2.43	1.56	.08	2.11	1.43
1.25	.1	.27	2.77	1.76	.17	2.15	1.49	.11	1.83	1.33
	.2	.31	3.26	1.90	.19	2.50	1.60	.15	2.16	1.44
	.3	.35	4.00	2.08	.26	3.12	1.78	.16	2.59	1.58
1.0	.1	.68	4.89	2.36	.40	3.15	1.81	.22	2.30	1.49
	.2	.76	6.20	2.64	.47	3.97	2.02	.26	2.85	1.66
	.3	.90	8.66	3.08	.52	5.00	2.26	.30	3.67	1.89
0.8	.1	2.24	19.0	4.72	.94	6.34	2.59	.46	3.37	1.82
	.2	2.74	36.4	6.49	1.08	8.53	2.99	.52	4.58	2.12
	.3	3.56	56.6	7.94	1.30	13.70	3.77	.60	6.49	2.52

* For all cases, $V_B/V_f = 0.5$.

SUMMARY

We have established a mathematical formalism for the analysis of forest fire suppression that can be used for planning purposes. Through the use of results such as those presented in this paper, analyses of costs and effectiveness of fire-suppression organizations will be facilitated. The methodology is complicated enough that numerical evaluations are only possible using modern digital computers. But basic results of broad applicability can be generated at modest expense so the investment appears to be worthwhile.

Extension of the present analysis to include the effect of a variable rate of suppression is straightforward. Other tactics of fire suppression can also be studied using the basic formulation presented here. Such extensions may be the subject of future studies.

REFERENCES

Albini, Frank A.

1976. Estimating wildfire behavior and effects. USDA For. Serv. Gen. Tech. Rep. INT-30, 92 p. Intermt. For. and Range Exp. Stn., Ogden, Utah.

Byram, G. M.

1959. Combustion of forest fuels. *In*: Forest fire control and use, p. 90. Kenneth P. Davis, Ed., McGraw-Hill Book Co., New York.

Headquarters for the Intermountain Forest and Range Experiment Station are in Ogden, Utah. Field programs and research work units are maintained in:

Billings, Montana
Boise, Idaho
Bozeman, Montana (in cooperation with Montana State University)
Logan, Utah (in cooperation with Utah State University)
Missoula, Montana (in cooperation with University of Montana)
Moscow, Idaho (in cooperation with the University of Idaho)
Provo, Utah (in cooperation with Brigham Young University)
Reno, Nevada (in cooperation with the University of Nevada)

Albini, F. A., G. N. Korovin, and E. H. Gorovaya.

1978. Mathematical analysis of forest fire suppression. USDA For. Serv. Res. Pap. INT-207, 19 p. Intermountain Forest and Range Experiment Station, Ogden, Utah 84401.

This paper presents a mathematical formulation of the construction of a containment perimeter for a wildland fire. The formulation permits the calculation of total burned area, final perimeter, and containment time, if the rate of growth of the fire can be specified as a function of time and position.

KEYWORDS: forest fire control, fire behavior model, fire management, computer programs.

Albini, F. A., G. N. Korovin, and E. H. Gorovaya.

1978. Mathematical analysis of forest fire suppression. USDA For. Serv. Res. Pap. INT-207, 19 p. Intermountain Forest and Range Experiment Station, Ogden, Utah 84401.

This paper presents a mathematical formulation of the construction of a containment perimeter for a wildland fire. The formulation permits the calculation of total burned area, final perimeter, and containment time, if the rate of growth of the fire can be specified as a function of time and position.

KEYWORDS: forest fire control, fire behavior model, fire management, computer programs.

U.S. DEPT. OF AGRICULTURE
NATL. AGRIC. LIBRARY
RECEIVED

AUG 15 '78

PROCUREMENT SECTION
CURRENT SERIAL RECORDS

