



506.42
M26

MEMOIRS AND PROCEEDINGS

OF

THE MANCHESTER

LITERARY & PHILOSOPHICAL

SOCIETY.

(*MANCHESTER MEMOIRS.*)

VOLUME XLI. (1896-97)

MANCHESTER:
36, GEORGE STREET.

—
1897.

SMITHSONIAN INSTITUTION

LIBRARY

LEWIS & CLARK

1803

1803

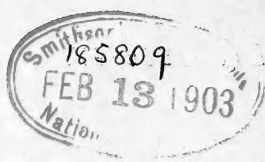

LIBRARY

NOTE.

The authors of the several papers contained in this volume are themselves accountable for all the statements and reasonings which they have offered. In these particulars the Society must not be considered as in any way responsible.



CONTENTS.

MEMOIRS.

	PAGE
I. On <i>Rachiopteris cylindrica</i> Will. Plate 1. By THOMAS HICK, B.A., B.Sc., A.L.S.	pp. 1-14
II. On the Structure and Contents of <i>Anthoceros tuberosus</i> Taylor. Plate 2. By J. H. ASHWORTH, B.Sc.	pp. 1-6
III. On Methods of Determining the Dryness of Saturated Steam and the Condition of Steam Gas. By OSBORNE REYNOLDS, M.A., LL.D., F.R.S.	pp. 1-14
IV. Hymenoptera Orientalia, or Contributions to a knowledge the Hymenoptera of the Oriental Zoological Region. Part V. Plates 3 and 4. By PETER CAMERON	pp. 1-144
V. On the Ampullæ in some specimens of <i>Millepora</i> in the Manchester Museum. By SYDNEY J. HICKSON, M.A., D.Sc., F.R.S.	pp. 1-4
VI. Descriptions of New Species of Brachiopoda and Mollusca from the Millstone Grit and Lower Coal Measures of Lancashire. Plate 5. By HERBERT BOLTON, F.R.S.E.	pp. 1-7
VII. Descriptions of Thirty-four Species of Marine Mollusca from the Arabian Sea, Persian Gulf, and Gulf of Oman. Plates 6 and 7. By J. COSMO MELVILL, M.A., F.L.S.	pp. 1-25
VIII. Hypoiodous Acid and Hypoiodites. By R. L. TAYLOR, F.C.S.	pp. 1-20
IX. Some further investigation of Fossil Seeds of the genus <i>Lagenostoma</i> (Williamson) from the Lower Coal Measures, Oldham. Plate 8. By JOHN BUTTERWORTH, F.R.M.S.	pp. 1-4
X. On Continuity. By HORACE LAMB, M.A., F.R.S.	pp. 1-9
XI. The Costs of Sea Transport in proportion to Values of Cargoes. Plates 9 to 12. By A. W. FLUX, M.A.	pp. 1-18
XII. The Fall in Prices during the past Twenty Years. Plates 13 to 15. By A. W. FLUX, M.A.	pp. 1-15

MEMOIRS (*continued*).

	PAGE
XIII. Hymenoptera Orientalia, or Contributions to a knowledge of the Hymenoptera of the Oriental Zoological Region. Part VI. <i>Plate</i> i6. By PETER CAMERON pp. 1-27	
XIV. The Composition of some Ancient Iron Implements and a Bronze found at Thebes. By ARTHUR HARDEN, M.Sc., Ph.D. pp. 1-3	
XV. On the Nature of the Röntgen Rays. (The Wilde Lecture). By Sir GEORGE G. STOKES, Bart., M.A., LL.D., F.R.S. pp. 1-28	

PROCEEDINGS.

BAILEY, CHARLES, F.R.S.—On so-called Carnivorous Plants .. vii.	
BARNES, C. L., M.A.—On some Errors in Science xv.	
BENNETT, ALFRED R., M.I.E.E.—A Convection Scope and Calorimeter.. .. . xxvii.	
BOWMAN, F. H., D.Sc.—On the Method of Working the Marconi Telegraph Receiver xxxi.	
CHAFFERS, Mr.—Exhibit of "Plankton," and Holothuridæ. .. xxxiv.	
CHORLTON, Mr.—On a Swarm of Dung-beetles at King Arthur's Castle xxvi.	
COWARD, T. A.—Exhibit of Eggs of the Cuckoo (<i>Cuculus canorus</i>).. vi.	
CRABTREE, B. H.—Exhibit of a Collection of British Clearwings .. xxiv.	
FARADAY, F. J., F.L.S.—On the Pont du Gard, in relation to the Theories of the Erosion of River Valleys xviii.	
— Exhibit of Photograph of the Pont du Gard xx.	
FISHER, H.—Exhibit of a Collection of Arctic Plants from the Franz Josef Archipelago xxii.	
GRIFFITHS, ALBERT, M.Sc.—On the Viscosity and Electrolytic Resistance of a Gelatine Solution ix.	
— On a Mixture whose Electric Resistance depends on the Magnetic Field in which it is placed.. .. . xi.	
GWYTHER, R. F., M.A.—Exhibit of two Distribution-curves showing the comparative results of Examinations in Mathematics for Three Years xiii.	
HICKSON, SYDNEY J., M.A., D.Sc., F.R.S.—Exhibit of Two Black-bird's Eggs, one without yolk, the other with two yolks .. xviii.	

PROCEEDINGS (*continued*).

	PAGE
HOYLE, W. E., M.A.—Exhibit of the Album of Photographs presented to Dr. John Murray by the contributors to the "Challenger" Reports.	xxxiv.
JOHNSON, LINDSAY, M.D., F.R.C.S.—Exhibit of, and Remarks on, a Series of Drawings of the <i>fundus oculi</i> of Animals	xx.
KELVIN, LORD, F.R.S.—Address to, on the occasion of the Jubilee of his Professorship.	iii.
— Reply to the Address	iv.
LEES, CHARLES H., D.Sc.—On the Experiments of Wiedemann on the Specific Heats of Vapours	xv.
— An Account of Zeeman's Experiments on the effect of a Magnetic Field on the Vibrations emitted by a Source of Light.	xxxii.
MELVILL, J. COSMO, M.A., F.L.S.—Exhibit of Marine Mollusca from the Loyalty Islands	v.
— Exhibit of Species of <i>Droseraceæ</i>	vi.
— Exhibit of a Specimen of <i>Calophasia platyptera</i>	xxi.
— Exhibit of Arctic Plants	xxii.
NICHOLSON, FRANCIS, F.Z.S.—Exhibit of pamphlet entitled: "Rules established for the government of the Literary and Philosophical Society of Manchester," &c.	viii.
— Donations of Books to the Society's Library	xviii.
— Exhibit of a copy of Gilbert White's "Naturalist's Calendar" (1795)	xxxii.
PANKHURST, R.M., LL.D.—On the Patent Office	xxx.
REYNOLDS, OSBORNE, M.A., F.R.S.—On the top called "The Devil on Two Sticks"	xii.
ROGERS, THOMAS.—Exhibit of Specimens of <i>Sacoglottis amazonica</i> , with Fruit	xxiv.
— Exhibit of a curious Caterpillar from Rio de Janeiro	xxv.
— Exhibit of the fungus <i>Torrubia gracilis</i> growing out of the Chrysalis of a Moth.	xxxiii.
— Exhibit of slides of Ostracoda.	xxxiv.
SCHILL, C. H.—Exhibit of Elateridæ	xxiv.
SCHILL, P. H.—Exhibit of a Collection of Palæarctic Parnassius	xxiv.
SCHUNCK, EDWARD, Ph.D., F.R.S.—On Carminic Acid, with exhibit of <i>Cactus opuntia</i>	xiv.
SCOWCROFT, W. R.—Exhibit of New Zealand Ferns	xxiv.

	PAGE
STIRRUP, MARK, F.G.S.—Exhibit of Diagrams of Fossil Insects found in the Coal Measures of France	xxv.
— Exhibit of a Drawing of <i>Pteridophora Alberti Meyer</i>	xxxiii.
— On the Ostracoda of the Coal Measures.	xxxiv.
WEISS, F.E., B.Sc., F.L.S.—On the Tubers of <i>Anthoceros Tuberosus</i> .. v.	
WILDE, HENRY, F.R.S.—Announcement of his gift of an electric lamp for the lantern	xviii.
General Meetings	i., viii., xii., xiii., xiv., xxvii.
Special Meeting for the delivery of the Wilde Lecture	xxxvii.
Annual General Meeting	xxxv.
Meetings of the Microscopical and Natural History Section:—	
Ordinary	vi., xxi., xxii., xxiv., xxvi., xxxiii.
Annual	xxxiii.
Report of the Council, April, 1897, with Obituary Notices of E. du Bois-Reymond, Sir Joseph Prestwich, H. A. Rézal, J. J. Sylvester, A. A. L. Trécul, Francis Walker, S. Cottam, T. Hick, and J. Parlane	xlii.
Treasurer's Accounts	lxvii.
Report of the Microscopical and Natural History Section and Accounts	lxx.
List of the Council and Members of the Society	lxxii.
Lists of the Awards of the Wilde Medal and the Premium	lxxxvii.

I. On *Rachiopteris cylindrica*, Will.

By THOMAS HICK, B.A., B.Sc., A.L.S.,

Assistant Lecturer in Botany, Owens College, Manchester.

Received October 6th. Read October 6th, 1896.

In his ninth memoir "On the Organisation of the Fossil Plants of the Coal Measures,"* the late Prof. Williamson described a series of plant remains from the Lower Coal Measures of Halifax, under the name of *Rachiopteris cylindrica*. The genus *Rachiopteris* he had previously adopted for the reception of a number of isolated Fern petioles whose connections were unknown, and in referring the specimens to it, he only did so provisionally, as he was "far from certain" at the time that they were "true Ferns."† As to the nature of the fragments, he was undecided whether they were parts of roots or parts of stems.

The description given by Williamson in 1878 is a brief one, based apparently upon a small number of microscopic preparations, and, so far as I can discover, no further observations have been published on the subject. In the present communication I propose to give a more detailed account of the plant than was possible when Williamson wrote of it, and then to consider whether or not the knowledge since acquired throws any light upon its affinities. The specimens on which I

* Phil. Trans., 1878.

† Loc. cit. p. 350.

have mainly relied are a number of sections prepared by Mr. James Binns, of Halifax, and now in the Cash Collection at the Manchester Museum, Owens College, but these have been supplemented by others.

Anatomy and Histology.

Transverse sections of *Rachiopteris cylindrica* have a circular or elliptical outline. The diameter of the circular ones varies slightly from an average of 2 mm. ($\frac{2}{25}$ in.), while the elliptical ones are somewhat larger, and measure for the most part 2.1 mm. ($\frac{1}{12}$ in.) by 1.9 mm. ($\frac{1}{13}$ in.). It is obvious, therefore, that the objects to be dealt with are small, but there is nothing to show that they are in an immature state. In most of them one recognises without difficulty (Fig. 1) a central cylinder or stele, surrounded by a cortex, and a peripheral or epidermal layer. The stele, when single, is circular in transverse section, with a diameter varying between 0.4 and 0.75 mm. ($\frac{1}{60}$ and $\frac{3}{100}$ in.). In many cases, however, it is preparing for, or in a state of, division, and is then more or less elliptical, measuring 1 by 0.8 mm. ($\frac{1}{25}$ by $\frac{1}{30}$ in.). The cortex, including the epidermis, varies in thickness from 0.4 to 0.8 mm. ($\frac{1}{60}$ to $\frac{1}{30}$ in.).

The Epidermis.

The peripheral layer or epidermis is not usually quite distinct, but when it is, as in No. 115,* it presents itself as a single layer of cells. No signs of stomata have yet been seen in it. In some sections, such as the one just referred to, it is provided with a covering of multicellular hairs, the density of which varies in different specimens, while in some no hairs are visible. In these last, however, it is

* Here and throughout the figures refer to the Register of the "Cash" Collection of sections of Carboniferous Plants in the Manchester Museum, Owens College

not certain that the outermost layer is actually the epidermis. For the most part the hairs are seen only in transverse section. They are very rarely, and then for short lengths only, presented in longitudinal section. As in the epidermal cells, no cell contents have as yet been met with in the hairs.

Putting together the details observable in various fragments, the hairs may be described as filaments made up of a single row of cells placed end to end. At the base, what appears to be a sort of pedestal is sometimes seen, but no indications of anything of the nature of a terminal gland have been found. From the fact that transverse sections of the stem show the hairs, when present, also cut, for the most part, transversely, it seems probable that the latter were appressed rather than spreading.

The Cortex.

The cortex is, apparently, cellular throughout, but the outer part is usually more or less differentiated from the inner. The former, or hypoderma, consists of elements which in the transverse section are polygonal, or rounded in shape, and of relatively large size. The walls show some degree of thickening, which, however, diminishes from without inwards. Longitudinal sections show the elements to be much elongated in that direction, and, in form and appearance, to be sclerenchymatous.

The inner part of the cortex is composed of cells which are somewhat smaller and rounder in transverse section than the elements of the hypoderma. Towards the stele they diminish in size, become somewhat compressed radially (as was noted by Williamson),* and are arranged in concentric layers. They show a certain amount of wall thickening, which increases from without inwards, and the innermost elements are elongated

* Loc. cit. p. 350.

longitudinally. In the middle part of the cortex, where the hypoderma and the inner parenchyma run into one another, the cell walls are thinner and often much crumpled. In young specimens a complete zone of thin-walled elements occupies this region, but in older ones it is occupied by a series of radial lacunæ, separated by cellular partitions. (Fig. 1.) From the appearance of the tissues abutting on these lacunæ, it seems probable that their origin was lysigenous rather than schizogenous.

The contents of the cortical elements are somewhat remarkable, and present some interesting modifications. In one or two specimens the contents of both hypoderma and inner parenchyma are in the form of contracted utricles, as may be seen in the marginal section on No. 102. But in the second section on the same preparation, as well as in other cases, the utricular form is restricted to the hypoderma, and the contents of the inner parenchyma are in the form of granules, which remind us of the stored starch of recent plants. In the majority of the preparations, however, the cortical cells contain certain sharply defined black bodies, of a rounded or ellipsoidal shape, and with an even contour (Fig. 2). Frequently they are seen to be enclosed in a sort of vesicle, the cavity of which they do not fill, and whose wall is, therefore, somewhat removed from the body itself. The bodies are small compared with the size of the elements in which they lie, and two or more are frequently seen in the same element, especially in longitudinal sections like No. 113. In the specimen figured by Williamson* they are very numerous, and are carefully represented, but are not referred to in the description. In most instances where the black bodies are present, the granular and utricular forms of cell contents are absent, but not in all. Thus, in No. 115 the contents of the hypoderma are

* Loc. cit. Plate XXIV., Fig. 80.

utricular, while those of the inner parenchyma are represented by the peculiar black bodies. In No. 106 we have both the black bodies and the granular contents, but the distribution of each is irregular.

The nature and origin of these peculiar black bodies are points not easily determined. The first question that arises is whether they are actually portions of the cell contents or adventitious bodies that have found their way into the plant from without. Against the latter view must be set the fact that they are absent from the tissues of other plant fragments, and found in all preparations of *Rachiopteris cylindrica* which have been fossilised simultaneously and under the same conditions. Moreover, an examination of numerous sections of other species of *Rachiopteris* found in the same situations has so far failed to show their presence as regularly and as copiously as in the species under consideration. In some sections of the roots of *Psaronius* black bodies are occasionally met with which might be compared with them; but they lack the uniformity of shape and the definiteness of contour of those found in *Rachiopteris cylindrica*. On the other hand, their frequency in this species is remarkable. Leaving out doubtful cases where fossilisation has caused the disorganisation or disappearance of the cell contents, we have in the "Cash" Collection 17 preparations of the plant which show cell contents. Of these only three fail to show the black bodies, viz.: Nos. 102, 103 and 104, and they are all cut from the same specimen. It follows that out of 15 different specimens, we have only one in which these bodies do not occur. Lastly, there are reasons for regarding this specimen as younger than the rest, and it may be that the contents of the cortical cell have not assumed their final form. It is not desirable to place too much weight on these points, but taking the whole of the facts together, they seem strong enough

to warrant the provisional conclusion that the bodies in question are really constituents, or derivatives, of the normal cell contents and not alien immigrants from without. On this view their mode of origin will have to be sought in the changes brought about in the process of fossilisation, but with regard to this I am not in a position to say anything.

Finally, before leaving the subject, it may be worthy of notice that the general occurrence and peculiarities of these bodies have made it possible to use them to some extent as a diagnostic character of *Rachiopteris cylindrica*, and with such good results that determinations first made by their aid have been subsequently confirmed by more rigorous methods.

Endodermis.

At the innermost part of the cortex, where it abuts on the central cylinder, one naturally expects to find an endodermis, and the sections have been carefully scrutinised for indications of its presence. The result is not so completely successful as could have been wished, since it still leaves some doubt whether a specially differentiated endodermis is or is not always present. The case appears to be somewhat similar to that of *Lycopodium clavatum*, for we find here also thick-walled elements abutting on the stele, and here a well-marked endodermis cannot always be clearly recognised. But in favourable sections, *e.g.*, Nos. 104, 105 and 107, a layer of thin-walled elements is found on the inside of the thick-walled inner parenchyma, which, in the shape of its cells, their mode of union, and the appearance of the radial walls, bears some resemblance to an endodermis (Fig. 1). Its cells are larger than, and alternate with, those of the next layer on the cortical side; and they also alternate with those of the next layer within.

Hence it may be regarded as the innermost layer of the cortex, or the phloeoterma of Strasburger.*

The Central Cylinder or Stele.

If the layer of cells just referred to be really the phloeoterma, then all the tissues within it must be those which constitute the stele. On this view we can distinguish, more or less readily according to the state of preservation of the specimens, (i.) a pericycle, (ii.) phloem, and (iii.) xylem.

The pericycle is seldom sharply defined, but when it is, it consists for the most part of a single layer of thin-walled cells, as large as those of the endodermis, but more variable in size and less regular in shape and arrangement. The cell contents have altogether disappeared or are too vague for determination.

The phloem is composed of thin-walled, empty, and irregularly-shaped elements of different sizes, in which little differentiation has so far been detected. It forms a complete zone round the xylem, but the breadth of the zone is not always uniform. The reference of this zone to the phloem is based more upon its topographical position than upon its structure, but in one preparation, No. 104 (Fig. 1), larger elements are embedded in it, which in form, position, and arrangement resemble the sieve-tubes seen in transverse sections of recent Ferns.

The xylem occupies the centre of the stele, and, as was pointed out by Williamson, the larger elements are usually at the periphery, while the smaller are in the centre (Figs. 1 and 2). In Williamson's figure† the larger and smaller elements are well differentiated, and this is not an unusual state of affairs, though in some sections the difference is less sharply marked (Fig. 1). In the

* *Histologische Beiträge*, III.

† *Phil. Trans.* 1878. Plate XXIV., Fig. 80.

majority of the transverse sections I have seen, the central elements include one or more groups of small ones, which resemble in appearance the protoxylems of recent vascular bundles. When two such groups are met with, the appearance is as if a single group had, in some way, been divided. When three, four, or five groups are met with, as is often the case, they are arranged symmetrically round the centre, and look as though they had originated by division from a smaller number.

As to the nature of the elements of the xylem, the sections at my disposal do not enable me to speak altogether without reservation. The larger are probably tracheides, as good longitudinal sections, No. 127 for instance, show. In this section the wall markings are scalariform, the pits stretching for the most part from one angle to another. But in some slightly oblique transverse sections, represented by No. 114, the pits appear to be much less elongated and approach an elliptical form.

The case of the smaller elements is not quite so certain. In the longitudinal section just referred to, they present themselves as scalariform structures quite similar to the larger ones, save for the smaller diameter. The same may be said of the oblique transverse sections, where the markings of the large and small elements appear to be the same. In No. 127, however, there are suggestions at one or two points of a spiral marking, but whether these are actually spiral, or are really scalariform markings altered in some way, it is impossible to say.

The position then as regards the xylem is this. In transverse sections we have one or more groups of small elements that may be interpreted as groups of protoxylem, but this interpretation has not so far been confirmed by satisfactory evidence that they have spiral or annular markings.

Neither in transverse nor longitudinal sections have any cellular elements been met with in the xylem, so that the xylem may be said to be wholly vascular, so far as observation has at present gone.

Division of the Stele.

The description of the stele given above does not apply to all the preparations that have been examined. In the majority a condition is met with which does not appear to have presented itself to Williamson at the time he dealt with this plant, and which shows the stele in a state of division (Figs. 2, 3, 4, 5). As this appears to be associated with the mode of branching of the plant, and the formation of lateral members, it deserves to be described with some detail.

So far as has yet been seen, the division of the stele takes place in one of two ways, being either (1) an equal division, or (2) an unequal division.

In equal division, the stele divides along a diameter in such a way that the two halves have, from the first, the same size, form, and appearance, and when the process is completed we get two distinct steles of the type already described. An early stage of the process is well shown in No. 110, where we have two semi-circular masses of xylem, inclosed in a common zone of phloem, and separated by a narrow band of thin-walled parenchyma. This parenchyma cuts through the xylem in such a way as to have the small groups of elements, presumed to be protoxylem, abutting directly upon it. As the two moieties of the stele become more and more divergent, a centrifugal development of xylem would seem to take place on the inner side of these semi-circular masses until the circular contour is restored in each, and we have the appearance seen in No. 105 (Fig. 2). Here we have two normal strands of xylem,

separated by a band of phloem, and enclosed in a zone of the same tissue. At a later stage, shown in No. 107, the two steles are found to be completely formed, and are isolated from one another by the intercalation of cortical tissue.

In this mode of stelar division we obviously have a true dichotomy of the same, and it can hardly be doubted that the process is associated with a dichotomy of the axis itself. If this inference be correct, it will follow that whatever be the nature of that axis, be it stem, petiole, or other structure, it is characterised by a dichotomous mode of branching.

In unequal division the stele divides into two portions, which, from the first, are conspicuously different from one another. Ultimately they become converted into perfect steles; but they are not alike, one being of the normal type, and the other differing in important particulars. An early stage of this mode of division is met with in No. 103 (Fig. 3), where a segment of the xylem, whose height is not more than one-third of the diameter of the whole, is cut off from the rest by a narrow band of delicate parenchyma, resembling that met with in equal division. The dividing line passes through some of the smaller elements which have been referred to as probably protoxylem. The smaller segment of xylem is composed mainly of large tracheides, with only a few smaller ones on the side turned towards the other segment. As the process advances, the larger segment appears to receive an accession of centrifugally-developed xylem on the inner side, by which the detached segment is replaced, and the normal, circular form and appearance is restored. The smaller segment seems to develop little or no xylem on its inner side, and the typical form and appearance is not restored.

Thus, in Nos. 101 and 102 (Figs. 5 and 4), where we find two complete steles quite separated from one another,

which have arisen by unequal division, it is clear at a glance that the two strands of xylem are very different from one another. The normal stele needs no description. The other presents a xylem, semi-lunar in form, with small elements on the flattened side, and much larger ones on the convex side. The number of preparations of this type of stele is not large, and their phloem is not clear enough to justify a definite statement; but two or three of them have raised the suspicion that the phloem is mainly, if not entirely, restricted to the convex side of the xylem. It is somewhat tantalising that the preparations should fail at this important point, because, as will be seen below, the nature of the member to which this stele belongs depends, at least in part, upon the symmetry of the stele. It is important, therefore, to decide whether the latter is radially or bilaterally symmetrical.

Lastly, in No. 115, we have two distinct and complete structures, lying near to one another, whose steles correspond respectively to those found in the same axis in No. 101.

In No. 105 (Fig. 2), in addition to the two steles already described, a third structure is found in the cortex, which is obviously some organ which, originating at or near the bifurcation, is on its way from the central cylinder to the surface. Coming off obliquely, its section is an oblique one, but in it we can easily distinguish both a central cylinder and a cortex. The cortical cells seem to have had thin walls and copious cytoplasmic contents, as if full development had not yet been attained. The central cylinder is not at all well defined, but I suspect it carried a diarch xylem strand. The real nature of this organ is not quite certain, but its endogenous origin leads me to think it is a root. Moreover, in several preparations, Nos. 102 and 103, for example, sections of

the principal axis are accompanied by sections of structures that are almost certainly roots, and have some resemblance to the organ in question.

Division of the Axis.

Looking at the whole series of sections with dividing steles, it seems scarcely open to doubt that while in equal division we have an indication of dichotomous branching of the axis, in which the two members are strictly homologous with each other and their common podium, in unequal division of the stele we have an indication of the formation of some lateral organ which is not homologous with the axis from which it arises.

As to the morphological nature of this lateral organ or appendage, the evidence to hand is not sufficient to justify any definite conclusion. The suggestion that it is a foliar organ naturally and readily occurs, and that may be its character. It would be in favour of this view if the suspicion expressed above that the stele is not radially symmetrical could be converted into certainty, and this view is supported by the negative evidence that besides the appendages in question, there is nothing else that can be regarded as suggestive of leaves; indeed the absence of anything like an ordinary leaf-trace bundle, both in the cortex and at the periphery of the xylem, is one of the peculiarities of this plant. But of positive evidence, as just stated, there is not nearly enough to justify a conclusion.

On the other hand, the large size of the detached portion, relatively to that of the whole stele, is hardly in accordance with the foliar hypothesis. In several of his Memoirs* Williamson describes an unequal division

* See Part II. Phil. Trans., 1872; Part XI. Phil. Trans., 1881; Part XII. Phil. Trans., 1883; Part XVI. Phil. Trans., 1889; and Part XIX. Phil. Trans., 1893.

of the stele of *Lepidodendron*, which in some respects resembles that met with in our plant. But in these cases it would seem that the detached smaller segment soon becomes changed into a radially symmetrical stele, similar, in essential points, to that from which it originates, a condition of things which has not been found in *Rachiopteris cylindrica*. According to Williamson, this mode of branching in *Lepidodendron* is associated with the formation of fruit-spikes or strobili, into the axes of which the branches of the stele, successively formed by unequal division, are distributed. While there is a possibility, then, that in our plant the lateral appendage may be some form of fruit or an organ axial in its nature, the character of its stele is rather opposed to such an interpretation than in favour of it.

Fig. 6, which is taken from No. 102, shows what are probably the relations in space between the axis and its offshoots. At A and B we have two normal axes which have apparently arisen by the dichotomy of a common podium. Just below A is a section, *a*, of what appears to be a root, while another, *r*, is seen just above B. Below B, at *s*, is one of the unknown lateral appendages. Symmetry of arrangement would suggest a lateral appendage above A, but the periphery of the latter is at the extreme edge of the preparation, and it is impossible to say whether such an appendage was or was not originally present. The stele of B is undergoing unequal division in a plane at right angles to that which contains all the other sections.

What is Rachiopteris cylindrica?

Whatever interest or importance may attach to the anatomical details set forth in the preceding pages, it must be admitted that they help us but little towards a knowledge of the position which *Rachiopteris cylindrica* should

occupy in the Vegetable Kingdom. In the Memoir referred to at the outset, Williamson found it extremely difficult to form a reasonable conjecture on this point, and ultimately remarks, "it may be a Fern Stem, though I know no recent type of Fern which it resembles; it may be the root of some type of Fern, an idea suggested by the tendency to a concentric arrangement of the cortical cells; or it may belong to some dwarf type of Lycopodiaceous plants." Whether in the last sentence Williamson meant that it might be the root or the stem is not certain.

From what has been said of the histology of the stele, botanists will allow that its characters do not support the view that the axis of *Rachiopteris cylindrica* is a root. Nor is it otherwise with the mode of branching. We may conclude then with some confidence that it is either a stem structure—a caulome, in fact—of some kind, or the phyllopodium of a foliar organ.

The further question as to whether it should be referred to the *Lycopodiaceæ*, or to the *Filices*, cannot be answered definitely. Williamson tells us that "the entire series of [his] sections of this plant displays a considerable resemblance" to "sections of the aerial and subterranean stems of *Psilotum triquetrum*," but those I have examined hardly confirm this. Indeed, if the small elements *within* the strand of xylem are, as I presume, protoxylem elements, that fact of itself would be evidence against *Lycopodiaceous* affinities. On the other hand, it would not be inconsistent with what we know of the xylem strands of Ferns. If, therefore, our choice is to be restricted to the *Lycopodiaceæ* and *Filices*, the latter seem entitled to the preference. As, however, there are other types of Carboniferous plants in addition to those mentioned, it will be well to leave this point for future investigation.

Explanation of Figures on Plate 1.

- Fig. 1. Transverse section of *Rachiopteris*, showing undivided stele. This photograph is taken from slide No. 104 of the Cash Collection in the Manchester Museum.
- Fig. 2. Transverse section, showing division of stele into two equal parts (Cash Coll., No. 105).
- Fig. 3. Transverse section, showing unequal division of stele (Cash Coll., No. 103).
- Fig. 4. Transverse section taken a little higher up than section 3, showing beginning of separation of the two unequal steles (Cash Coll., No. 102).
- Fig. 5. Transverse section, showing completion of division of the stele (Cash Coll., No. 101).
- Fig. 6. Photograph of a larger portion of slide No. 102, than in Fig. 4 showing two stems, A and B, with their offshoots; *a* and *r* are probably lateral roots; and *s* is a lateral structure of unknown nature.
-

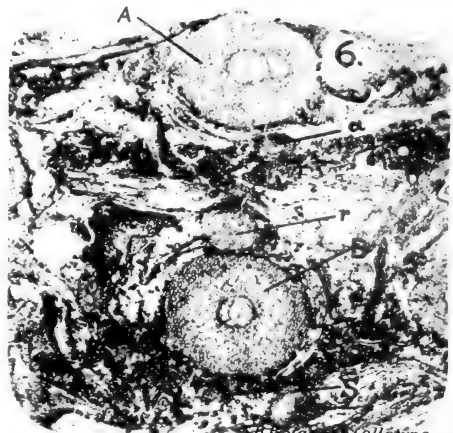
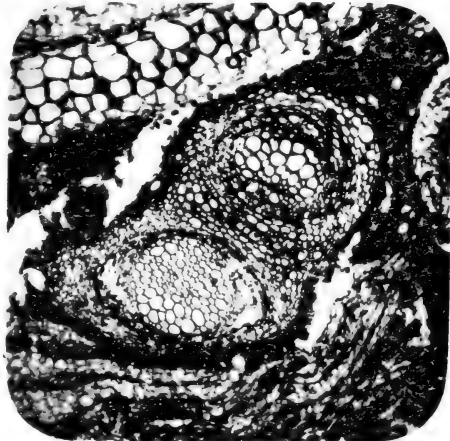
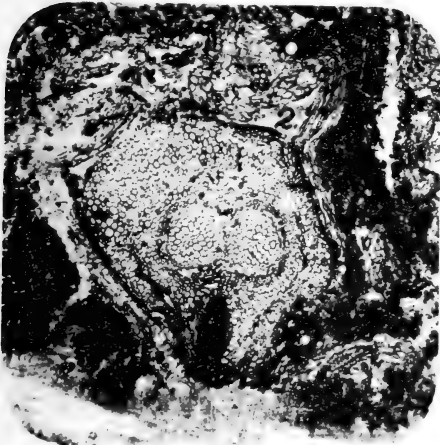
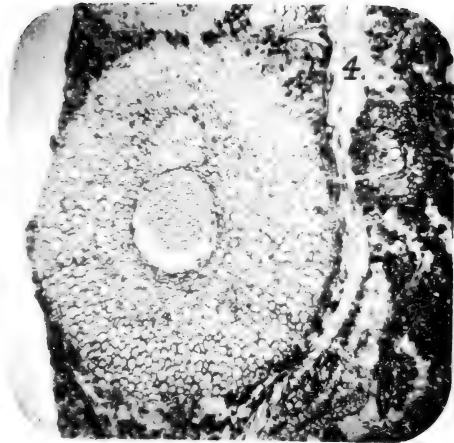
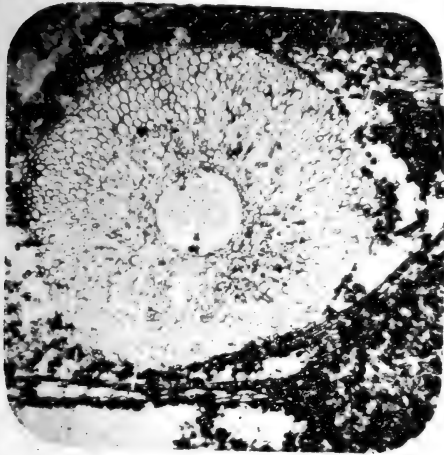

RACHIOPTERIS CYLINDRICA.

B. Botanicus Collotype



II. On the Structure and Contents of the Tubers of *Anthoceros tuberosus*, Taylor.

By J. H. ASHWORTH, B.Sc.

[Communicated by Professor F. E. Weiss.]

Received October 6th. Read October 6th, 1896.

In the Synopsis Hepaticarum (Gottsche, Lindenberg et Esenbeck, 1847) the occurrence of tubers in *Anthoceros tuberosus*, *Riccia vesicata*, *Riccia tuberosa* and *Petalophyllum Preissii* is mentioned.

In *Anthoceros tuberosus*, the tubers were first described by Taylor in the *London Journal of Botany* (1846, p. 412), the specimens described being collected by Drummond on the banks of the Swan River in Western Australia. This account is quoted in the Synopsis, where the oval tubers are described (p. 792) as occurring chiefly, but not exclusively, in sterile plants, being formed at the ends of outgrowths from the thallus, and containing a farinaceous mass within a deeply coloured envelope or cuticle. Attention is drawn to the presence of rootlets upon the tubers, and the latter, which are to be regarded as gemmæ, are said to serve as organs which can resist drying during the hot period of the year.

In *Riccia vesicata* (Taylor), the tubers are described as oblong or round and provided with rootlets (loc. cit. p. 795).

In *Riccia tuberosa* (Taylor), the tubers are described as pale yellow, rounded or oblong, slightly curved bodies,

Nov. 17, 1896.

provided with rootlets, and yielding, on compression in water, a small amount of farinaceous matter and opaque globules (loc. cit. p. 796).

Nothing is said about the tubers of *Petalophyllum Preissii* (Gottsche) beyond the statement of their presence (loc. cit. p. 792).

Recently Goebel* has found tubers on a *Fossombronina* (n. sp.) from Tovar, which he finds are produced by the thickening, and filling with reserve food materials, of a downward-growing apex, on entering the soil. In these tubers, Ruge (loc. cit. p. 306) finds that the reserve food materials contain considerable quantities of starch.

Beyond these observations I have been unable to find any other references to the tubers of Liverworts.

The object of my investigation was to ascertain the structure and the nature of the contents of the tubers of *Anthoceros tuberosus*. Unfortunately, I have had at my disposal only dry herbarium material, but I have been able to make out several new points of interest.

Anthoceros tuberosus. The tubers occur on the ventral surface of the thalloid expanse, and they lie embedded in the soil beneath the thallus. They are spherical or pear-shaped, their diameter being $\cdot 15$ — $\cdot 35$ mm., and the length of the stalk attaching them to the ventral surface of the thallus $\cdot 2$ — $\cdot 35$ mm. (Pl. 2, Fig. 1). The wall of each tuber is formed of three or four layers of more or less rectangular cells, which are almost devoid of contents, there being only very small remnants of protoplasm found in some of the cells (Fig. 1, C.). The walls of these cells are corky in nature, as they are coloured yellow by iodine, and are not swollen or turned blue by a subsequent treatment with strong sulphuric acid. Many of the cells of the outermost layer, and some of the cells of the stalk, are

* Flora. 1893. Band 77. G. Ruge. Beiträge z. Kenntniss der Vegetationsorgane der Lebermoose. p. 305.

produced into hair-like processes, attaining a length of .25 mm. (Fig. 1, H.). These do not appear to be cut off by a cell wall from the cells from which they arise. The walls of these hairs, and also of the cells of the basal part of the stalk, differ slightly in composition from the corky cell walls, as on treating with iodine and sulphuric acid they stain slightly bluish-green, but do not swell appreciably. These cell walls appear to be cellulose which has become almost transformed to cork. The hairs are probably the remains of absorbing organs (the rootlets mentioned in the Synopsis) which performed some function during the formation of the tuber.

Within the protective cells, lie closely-packed cells which all contain food materials. The cell walls of this portion of the tuber are thin, and of unchanged cellulose (Pl. 2, Fig. 2). Each cell contains a large, central, usually elongated nucleus (N), a large number of round or oval granules (G), colourless or slightly yellow imbedded in the remains of the protoplasm (P), and numerous small oil drops (O), or one large one due to the coalescence of the smaller drops.

The oil is present in considerable quantity, as can readily be seen on crushing a tuber in water between a glass slide and a cover, when large fluid oil-drops exude. These are at once stained brown, or black, by osmic acid. The drops are readily soluble in chloroform, ether, benzene, but dissolve only slowly in absolute alcohol. The oil is not vaporised by heating for two hours to 120°—140°C., and it is not readily saponified with potash, even on heating for several minutes. The oil-drops are fluid at the ordinary temperature (12°C.), as can be seen on compression.

The granules present in the cells are of different sizes (Fig. 2); a few are large, but the greater number are of smaller size. The larger granules have an average diameter

of $\cdot 006$ mm., the diameter of the smaller granules being about $\cdot 002$ mm. Both larger and smaller grains contain one, two, or three brighter and more refringent portions, which may be enclosed bodies or only specialised portions of the substance of the grains. The grains are swollen and dissolved by a weak solution of potash (2%), and in some grains there is an inner portion which remains undissolved for a short time. The granules are *not* starch, as they are stained *yellow* by iodine. They give other reactions for proteids; *e.g.*, they turn bright yellow when treated with nitric acid and ammonia (xanthoproteic reaction), and they stain readily with picrocarmine, hæmatoxylin, aniline blue, acid fuchsin, and other protoplasmic stains. The tests mentioned above prove that the grains consist of some proteid substance, and they appear to be aleurone grains.

The food material stored up in the tubers of *Anthoceros tuberosus* differs, therefore, from that in the tubers of *Fossombronia* (n. sp.), which were found by Ruge to contain considerable quantities of starch. In the Synopsis, the tubers of *Anthoceros tuberosus* are said to contain a *farinaceous* mass; but it is necessary to remember, in considering this statement, that the nature of aleurone grains was only discovered in 1855, that is eight years after the publication of the Synopsis.

The small size of the granules in the tubers of *Anthoceros tuberosus* does not preclude the possibility of their being aleurone grains, as in some plants aleurone grains attain a diameter of only $\cdot 001$ mm. The occurrence of larger and smaller grains in the same cell is also known in other cases (*e.g.* *Vitis*). The occurrence of oil and aleurone grains together as reserve food materials is not at all uncommon, but they have not hitherto, to my knowledge, been found together in Liverworts, though oil-containing bodies have long been known to occur in

them.* The oil found in these tubers closely resembles that which Pfeffer found in other Liverworts in its solubility in various reagents, its fluid condition at a temperature of 12°C., the difficulty experienced in its saponification with potash, and in the fact that the oil is not vaporised on heating to 140°C.

Besides these stalked tubers projecting ventrally into the soil, there are analogous bodies formed in the substance of the thallus, which have not hitherto been described. These are produced by the formation of a cellular mass (like that of the inner part of a stalked tuber) between the upper and lower layers of the thallus. The cells of these tuberous masses have the same structure and contents as those in the inner portion of the external tubers. These cellular masses are usually oval in shape, and their average length and breadth are .2 mm. and .15 mm. respectively. They are somewhat flattened dorso-ventrally, their thickness being .1—0.15 mm. In several sections, I have found one of these internal masses at the base of the stalk of an ordinary (but small) tuber. This suggests that, possibly, the stalked tuber in question was in process of formation, and that the cells at the base of the stalk were storing up food materials, which would subsequently be passed into the tuber. Internal masses of considerable size occur in other places in the thallus where there is no sign of the formation of a stalked tuber, and these probably always remain in the thallus, and are independent of any external tuber.

Regarding the function of the tubers, the Synopsis says they should be looked upon as gemmæ, and Ruge (*Flora*, 1893, p. 306) suggests that this process of vegetative reproduction is an adaptation to a mode of life in which the plants are subjected to periodic droughts. In support of this view he mentions the fact that the four

* Pfeffer. *Die Oelkörper der Lebermoose.* *Flora.* Jan., 1874.

plants which bear tubers, mentioned in the Synopsis, come from Western Australia. We may regard these tubers as gemmæ, the inner cells of which have become stored with food materials, and which are protected by a corky envelope formed by modification, when the tuber is fully formed, of the cell walls of the outer cell layers. In *Anthoceros tuberosus*, we may presume that the internal cellular masses, as well as the ordinary tubers, can give rise to new plants, and hence if the thallus becomes dry and dies there will still remain several living cellular masses, filled with food materials, which will be enclosed and protected by the remains of the dead thallus. These would probably be able to survive a considerable time and then give rise to new plants under circumstances favourable to their germination. It is possible that this plant forms the cellular masses in the thallus before it produces the stalked tubers, and, thus, early secures protection against extinction by drying during hot periods. That this is a possible explanation is supported by the fact that, in the dry herbarium specimens at my disposal, the histology of the cells of these internal food-laden cells is quite good, and the normal shape of the cells is retained, whereas the ordinary cells of the thallus are shrunk and collapsed.

The specimens used in this investigation were obtained from the Carrington Herbarium in the Manchester Museum, Owens College, and the work was carried on in the Botanical Laboratory of the College during the Lent Term of this year, under the direction of Professor Weiss, to whom I am indebted for advice and criticism.



ASHWORTH, *Tubers of Anthoceros tuberosus.*

Explanation of Figures in Plate 2.

Fig. 1. Longitudinal section of the tuber (with its stalk) of *Anthoceros tuberosus*, $\times 100$.

Fig. 2. Three cells from the internal portion of the tuber, $\times 1,000$. In the two upper cells the proteid granules are shown, and in the lower one the oil-drops.

- C. Cork cells.
 - G. Proteid Granules.
 - H. Hairs.
 - N. Nucleus.
 - O. Oil-drops.
 - P. Protoplasm.
-

Fig. 1

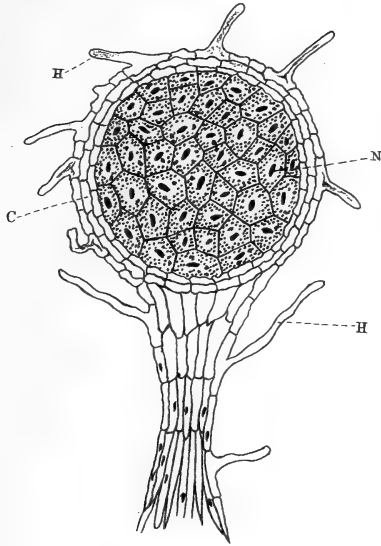
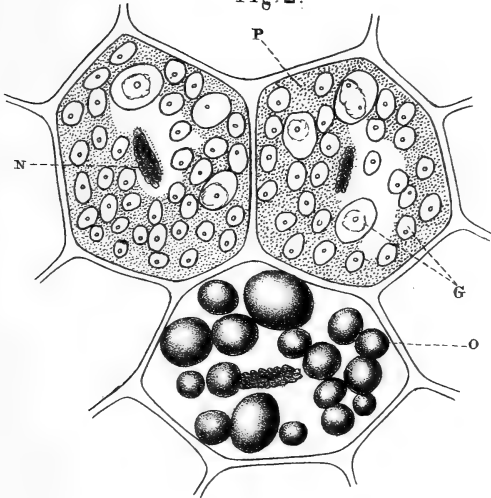

Fig. 2.





III. On Methods of Determining the Dryness of Saturated Steam and the Condition of Steam Gas.

By OSBORNE REYNOLDS, M.A., LL.D., F.R.S.

Received October 20th. Read November 3rd, 1896.

When, after all air has been expelled from a vessel partially filled with water and kept at rest at a constant temperature, equilibrium is established, the vapour is said to be dry saturated steam.

It is easy to show that under these circumstances the pressure of the steam is a definite function of the temperature. But it has been found very difficult to show, by direct means, that the density of the steam is also an invariable function of the temperature, although many experiments, from the time of Watt, have indicated that this is the case; those of Fairbairn and Tate being the least open to criticism.

That the density of dry saturated steam is a constant function of the temperature has, however, been completely established indirectly by the experiments of M. Regnault on the total heat of evaporation, although these experiments do not directly furnish a measure of the density. These experiments consisted in maintaining a vessel containing a definite quantity of water in steady constant condition as to temperature and pressure and quantity of water, by the steady admission of water at *any* constant temperature, and the withdrawal of the vapour in an upward direction, with a slow motion so as to preclude the convection of water out of the vessel

Nov. 17, 1896.

by the steam, the steam so withdrawn being condensed in a calorimeter back again to water at any constant temperature. The results proving that the total amount of heat given up by the steam for each temperature in the boiler is consistently proportional to the weight of steam condensed.

It thus appears that the density of saturated steam at constant temperature must be constant, and that gravity alone is sufficient to free the saturated steam from any water that may have been entangled with it by the action of boiling, provided the rate of flow over the surfaces is not sufficient to carry along with the steam any water there may be on the surfaces. It was only after the utmost care in securing these conditions that Regnault succeeded in obtaining consistent results—which results have since been confirmed by many researches, including that of Messrs. Harker and Hartog read before the Society last year.

It is to be noticed that the whole theory of the properties of steam, as at present accepted, and all the steam tables are founded on these experiments of Regnault's on the total heat of evaporation, so that if any other definition is given of dry saturated steam, than that of the vapour of water which results from boiling the water under constant pressure after it is drained of entangled water by gravitation, these properties and tables will not apply.

Wet Steam.

For the most part the precautions taken by Regnault are precisely those under which steam is produced in practice. That is to say, in practice the conditions in the boiler are maintained, as far as practicable, steady, and the steam is withdrawn in a vertical direction from the steam space over the water, where it is drained by gravitation. Owing, however, to exigencies as to space

and weight, a great deal more steam is often generated in proportion to the space than was the case in the experiments. Also the velocity of the steam after entering the steam pipes is, in practice, often so great that, even where these are ascending, any water that may have been drawn in with the steam, or produced by condensation owing to the radiation of heat from the pipes, is swept along with the steam; and where, as in cases like the locomotive, the engine is under the boiler, so that the pipes are descending, this must be so. Under such conditions the steam as it enters the boiler will be accompanied by some water, and is then variously called "wet steam," "nearly dry steam," or "super-saturated" steam, though the last name is apparently intended to imply that, notwithstanding Regnault's experiments, the density of steam after drainage is not necessarily a definite function of the temperature or pressure.

Whatever may be the cause of the water entering the engine with the steam, its presence in unknown quantity prevents Regnault's formula for the total heat of evaporation from being used to form a correct estimate of the quantity of heat received by the engine. For the only measures of the steam supplied to the engine are obtained from the measures of the feed-water supplied to the boiler or the water discharged from a surface condenser, so that, if an unknown quantity of water enters with the steam, estimates so formed must be in excess.

This is a matter of very serious consideration in all attempts to obtain a comparison of the actual performance of an engine in work done as compared with the theoretical performance under ideal conditions. And, as the modern practice of steam engineering is largely guided by the results of such attempts, methods of assuring dry steam or, failing that, of in some way measuring the percentage

of water passing with the steam into the engine, have attracted a great deal of attention.

For purely experimental purposes, it is always possible to supply the engine with dry steam, even where the boiler is at a distance, by passing the steam through a sufficiently large vessel close to the engine, so that the water may be disentangled by gravitation before the steam enters the engine. These are called water-separators. In some cases such separators form part of the engine, but, although their employment is becoming more common, it is only in comparatively few cases that this is practicable.

In other cases, that is, in the great majority of cases, the desire to obtain some experimental evidence of the percentage of water in the steam as it enters the engine, has led to the use of methods of testing samples of the steam drawn continuously from the steam pipe close to the engine.

Sampling the Steam.

In such methods, the question of getting a fair sample of the steam as it enters the engine is quite distinct from that of testing the sample so obtained. The water in the pipe, although moving in the direction of the steam, will not be uniformly distributed throughout the steam, and will, to a great extent, merely drift along the surface of the pipe and mostly on the lower surface, so that unless a sample taken from the lowest part of the pipe is found to be dry, in which case the steam is dry, such methods afford but little evidence as to the percentage of water entering the engine with the steam.

Testing the Samples.

For absolute dryness such samples may, where the pressure in the steam pipe is steady, be tested by allowing the sample to flow quietly through a separator, so as to drain out the water, the weight of which is then observed.

But any attempt to estimate the percentage of water in the sample involves the subsequent condensation and weighing of the steam in the sample as well as the drained water, which are difficult and complicated operations. Besides this, the pressure in the steam pipe near the engine is generally subject to considerable periodic alterations owing to the intermittent and periodic demand for steam in the engine, which introduces complications of unknown extent.

Wire-drawing Calorimeters.

With a view to obtaining a test for the samples of steam which should be independent of the separator, the so-called Wire-drawing Calorimeter has been introduced. In this, the sample of steam, whether it has been first drained or not, is received quietly in a vessel at the same pressure as the steam pipe, where it is at steady known pressure; from this it is allowed to escape continuously through a small orifice into a second larger vessel, maintained at greatly lower pressure than the first. In this its temperature and pressure are measured, the steam then passing on into a condenser or into the atmosphere.

The quantity of water present is then estimated from the observed pressures in the two vessels, and the difference between the observed temperature in the second vessel and the temperature of saturation at that pressure, as taken from Regnault's tables.

Such calculations are at once seen to be based on Regnault's determination of the relations between the pressure and temperature of saturated steam, together with the heat relations, whatever they may be, between saturated steam and superheated steam. And, as the second relation does not appear to be known except as a very rough approximation, the results so obtained must be doubtful.

Results.

The results obtained with these calorimeters have apparently revealed the presence of anything up to 5 per cent. more water in the samples than those revealed by the *simple separator*, and this even when the steam has been drained in the separator before passing into the calorimeter.

This apparent experimental evidence of previously unsuspected water carried by steam has necessarily excited great interest, and is naturally welcomed, as it apparently brings the engines by so much nearer perfection.

On second thoughts, however, a very serious consideration will present itself, namely, that if the drained steam from a separator contains latent water, the drained steam from the separator on which Regnault made his experiments must also have contained similar latent water, and hence the theoretical volumes of steam, which are based solely on these experiments, must be subject to identically the same corrections as the observed results, so that the discovery, if true, would thus leave the percentage of theoretical performance unchanged, while it would upset the truth of Regnault's results as to the properties of steam—and, moreover, upset all other deductions from these properties, including the deductions involved in these estimations.

That such is the case cannot be admitted until after the fullest consideration and verification of the experiments and of the method of reduction by which the novel results have been obtained.

These experiments are many, and the methods of reducing the results have not been very fully, although widely, published, but in all that I have seen the results have been deduced by means of the properties of

steam as determined by Regnault's experiments, by a formula which is based on a misunderstanding of the meaning of "the specific heat, at constant pressure, for steam when in the gaseous state," as determined by Regnault. And that this must have been the case with the other results would seem to follow from the fact that this formula, when based on the correct meaning, affords no definite result at all under the circumstances of the experiments.

It has thus seemed to me important not only to call attention to the error in reduction by which certain of these results have been obtained, but also to indicate, and if possible to verify, a method by which experiments could be made, so that Regnault's determination of the specific heat of steam gas could be correctly used to ascertain whether or not such latent water does exist in drained steam—that is, to ascertain whether Regnault's experiments on the specific heat of steam gas are consistent with his experiments on the latent heat of steam.

In the present paper the purpose is limited to pointing out the theory of the reductions, and to giving indications of the method of experimenting, the general character of the apparatus, and the precautions necessary.

The Theory of the Reductions.

By the law of conservation of energy, when a steady stream of matter flows through a chamber with fixed walls, so that the condition within the chamber is steady, the energy of the matter which enters (potential and actual) is equal to the energy which leaves in the same time, and hence is equal to the energy of the matter which leaves, together with such energy as may escape into the walls of the chamber. Thus, if a stream of fluid flows in a horizontal direction through a fixed passage and if

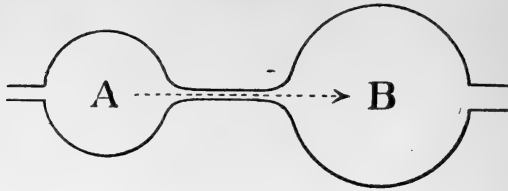

P_1' = pressure,
 T_1' = temperature,
 V_1' = volume per lb. of fluid,
 $H_1' - P_1'V_1'$ = mechanical equivalent of heat
 per lb. of fluid,
 u_1 = velocity of fluid
 } at A,

P_2' = pressure,
 T_2' = temperature,
 V_2' = volume per lb. of fluid,
 $H_2' - P_2'V_2'$ = mechanical equivalent of heat
 per lb. of fluid,
 u_2 = velocity of fluid
 } at B,

and H_j = the mechanical equivalent of heat, per lb. of fluid passing through, received through the surface.

Then
$$H_1' + \frac{u_1^2}{2g} + H_j = H_2' + \frac{u_2^2}{2g} \dots\dots\dots (1).$$

Also, if the fluid at A consists, per lb., of

S_1 lb. of steam and $(1 - S_1)$ lb. of water,

and at B consists of

S_2 lb. of steam and $(1 - S_2)$ lb. of water,

and if h_1 and h_2 are put for the mechanical equivalents of heat per lb. of water respectively at the temperatures, T_1 and T_2 , of saturated steam at pressures of P_1' and P_2' respectively, then $T_1' = T_1$, where P_1' and T_1 are pressure and temperature corresponding to the initial state of saturated steam at A, and T_2 may be taken to correspond

to the temperature of saturated steam at pressure P_2' . And if, further, H_1 equals the equivalent of the total heat of evaporation at pressure P_1' per lb., then

$$H_1' = S_1(H_1 - h_1) + h_1 \dots\dots\dots (2).$$

And if, similarly, H_2 and h_2 correspond to the temperature of saturated steam at pressure P_2' , then

$$H_2' = S_2(H_2 - h_2) + h_2 + K(T_2' - T_2) \dots\dots (3).$$

Where K is the mean specific heat of steam at constant pressure between the temperatures T_2' the actual temperature at B, and T_2 the temperature of saturated steam at the actual pressure (P_2') at B. It being noticed that, if $1 - S_2$ is greater than nothing, $T_2' = T_2$, so that the last term in (3) vanishes. While, if $(1 - S_2)$ is zero, this last term expresses the heat, whatever it may be, requisite to raise steam, at constant pressure P_1' , from the temperature of saturation T_2 to the observed temperature T_2' .

Substituting from equations (2) and (3) in equation (1), this becomes

$$\begin{aligned} S_1(H_1 - h_1) + h_1 + \frac{u_1^2}{2g} + H_j \\ = S_2(H_2 - h_2) + h_2 + \frac{u_2^2}{2g} + K(T_2' - T_2) \dots\dots\dots (4). \end{aligned}$$

If then u_1 , u_2 , and H_j are small enough to be neglected, since the values of H_1 , h_1 , H_2 , h_2 , T_2 are obtainable from Regnault's tables, when P_1' , P_2' or T_1' are observed, all the remaining quantities may be known except S_1 , S_2 , and K . And either, if S_2 is not equal to unity, $(T_1' - T_2) = 0$, and

$$S_1(H_1 - h_1) + h_1 = S_2(H_2 - h_2) + h_2 \dots\dots\dots (5),$$

or, if $(1 - S_2) = 0$

$$S_1(H_1 - h_1) + h_1 = H_2 + K(T_2' - T_2) \dots\dots\dots (6).$$

Equation (5) gives S_1 in terms of S_2 when $T_2' = T_2$, but, since S_2 is unknown, this is of no use; while, if T_2' is greater

than T_2 , equation (6) gives S_1 in terms of K which is a function of T_2 and T_2' , which has not been determined.

If it were possible to determine the exact value of T_2' at which $S_2 - I = 0$, then

$$S_1 (H_1 - h_1) + h_1 = H_2.$$

But, here again, this is practically impossible, since the only indication that $S_2 - I = 0$ is that T_2' is greater than T_2 as given by Regnault's tables for steam at P_2' , and, for any such excess as can be observed, the value of $K (T_2' - T_2)$ is considerable, since, at the point of saturation, K is apparently infinite, so that neither of these determinations are practical.

With a view to getting over these difficulties, the course that has apparently been adopted is to obtain a condition such that the temperature (T_2') after wire-drawing is from 10° to 20° F. higher than the saturation temperature (T_2), and then to assume that K is equivalent to the specific heat at constant pressure of steam gas as determined by Regnault, or that

$$K = 772 \times 0.48,$$

an assumption which constitutes the error in reduction to which I have referred.

The possibility of obtaining an accurate estimate.

This depends on obtaining a certain condition in the experiment, and reducing by a formula proved by Rankine (Trans. Roy. Soc. Edinb., 1849, 1855).

Rankine's formula is that the total heat to convert water from a liquid state at any particular temperature, say 32° , to steam gas at any temperature (T_2'), the operation being completed under constant pressure, is expressed by

$$\frac{H_2'}{772} = C_1 + a (T_2' - 32^\circ),$$

C_1 being a quantity depending only on the initial state, and a being the specific heat at constant pressure of the steam gas, determined by Regnault to be

$$0.48.$$

Taking the initial state to be at 32° , Rankine obtained, as the most probable value,

$$C_1 = 1092.$$

It is to be noticed, however, that although this value 0.48, as obtained by Regnault, has been universally accepted, the experiments by which he obtained it were independent of the method by which he determined the total heat of evaporation of saturated steam, and that, as Regnault observes,* the smallness of the scale as compared with that by which the total heats were determined rendered it necessarily less accurate, as regards the measurement of the total quantities of heat observed; although the extreme care with which the numerous experiments in the four cases were made, seems to assure their relative accuracy. The experiments consisted in determining the total heat necessary to raise water from 32°F. or 0°C. to temperatures of about 120°C. and 220°C. under the pressure of the atmosphere, then taking the differences as being the heat necessary to raise water from 120°C. to 220°C. It thus involves the assumption that steam at 20°C. (or 36°F.) above the boiling point is in the condition of steam gas. This is probably very near the truth. Had, however, the experiments been as absolutely accurate as those for the total heat of saturated steam, they would have afforded the means of comparing the two methods of Regnault by Rankine's thermodynamical formulæ. As it is, such a comparison can be made. Thus, substituting the total heats as obtained in the experiments for specific heat

* *Mém. Acad. Sci., Vol. XXVI., pp. 170, 909.*

in Rankine's formula, the constant C_1 is found to be not 1092, as given by Rankine, but between 1076.4 and 1053.7, with a mean of about 1055. Taking this value, the heat necessary to raise water from 32° to 248°F . at constant pressure of 14.7lbs. per square inch is

$$1055 + 0.48 (216) = 1158.68$$

To raise water from 32° to saturated steam at 212° requires by Regnault's formula for total heat of saturated steam

$$1091.7 + .305 (180) = 1146.6$$

Hence, to raise saturated steam from 212° to 248° at constant pressure would require 12.08 T.U., which, divided by the difference of temperature, gives for the mean specific heat of steam from saturation at 212° to 248°F . at constant pressure

$$\frac{12.08}{36} = .335,$$

which shows that the specific heat, at constant pressure, of steam rises with the temperature. And this, although in accordance with the results obtained by Regnault for other vapours, presents great thermo-dynamical difficulties; since many experiments have shown that the steam, on being heated from saturation to 36°F . above, expands three or four times as much as it would if it were gas. It is to be noticed that an error of 3% in estimating the total quantity of steam, which in these experiments would only mean an error of

$$0.0004$$

in the actual weighings, would account for the differences in the values of C_1 as determined by Rankine and as estimated from Regnault's experiment on specific heat, while such an error on the determination of the specific heat would fall within the limits of experimental accuracy. It thus seems probable that Rankine's determinations of the constants in his formula are approximately right.

In order to make use of this formula in the reduction of the experiments under consideration, all that is necessary is to bring about, by means of wire-drawing, the condition that T_2' shall be sufficiently larger than T_2 to insure that the final condition approximates to that of steam gas. That this difference must be more than 20°F . has been shown, but it would appear that with this difference the error is not great.

To use the formula,

$$\left\{ 1092 + 0.48 (T_2' - T_2) \right\} 772$$

is substituted for the right member of equation (6),

H_j , $\frac{w_1^2}{2g}$, $\frac{w_2^2}{2g}$ being small, so that

$$S_1(H_1 - h_1) + h_1 = 772 \left\{ 1092 + 0.48 (T_2' - 32^\circ) \right\} \dots (7),$$

which only requires the experimental determination of T_1 and T_2' to give the value of S_1 , provided that the final condition is that of steam gas.

The means of assuring the condition of Steam Gas.

Perhaps the most important fact to which attention is herein directed is that, although, as already stated, the limiting relations of temperature and pressure of steam gas are not known with any degree of precision, the wire-drawing experiments are capable of affording simple and direct evidence of the existence of such a final state. As the pressure of steam is reduced by wire-drawing which is gradually increased, at first, owing to the great expansion, the temperature falls considerably, but, as the wire-drawing increases, by the diminution of pressure in the receiving vessel, the fall of temperature gradually diminishes, until the gaseous state is produced, when the temperature T_2' will be unaffected by still greater wire-drawing.

So that to insure a gaseous state, all that is necessary is to gradually diminish the pressure in the receiving vessel, maintaining that in the first vessel, until the temperature T_2' in the receiving vessel becomes constant.

The only doubt is whether this point can be practically reached, and this can only be determined by experiments.

The remarkable circumstance in the flow of gases, of which I published the explanation in a paper read before this Society in 1885, that when steam or gas flows through a restricted channel from one vessel into another, in which the pressure is less than half that of the first, the quantity which passes is independent of the pressure on the receiving side, must have an important place in simplifying the apparatus required for such experiment.

Thus, with boiler pressure on one side of an orifice opening into a vessel from which its escape is allowed by an adjustable valve, the whole experiment can be regulated by this valve, the quantity flowing through remaining constant for all pressures after the half is reached.

The only precautions necessary for accuracy are those to secure approximately small velocities at the points where the temperature is measured, and those to render small the loss of temperature in the steam by radiation. And, although these must complicate the appliances, they appear to be practical. I may also notice that, should such experiments be accomplished, they will afford the means of verifying or correcting Rankine's value for C_1 , which he has only given as a probable approximate value.

I hope these experiments may shortly be made, as Mr. J. H. Grindley, B.Sc., Fellow of Victoria University, has undertaken the research in the Whitworth Engineering Laboratory, Owens College.

IV. Hymenoptera Orientalia, or Contributions to a knowledge of the Hymenoptera of the Oriental Zoological Region. Part V.

By PETER CAMERON.

[Communicated by J. Cosmo Melville, M.A., F.L.S.]

Received November 9th. Read November 17th, 1896.

In view of the fact that Colonel C. T. Bingham is at present engaged on a Monograph of the Indian Hymenoptera, I deem it advisable to give in this part of my paper descriptions of new species only, leaving the information I possess regarding the distribution and habits of the known species to be dealt with in another paper.

Compared with the immense number of parasitic Hymenoptera (Ichneumonidæ, Braconidæ, &c.) known from the Nearctic and Palæarctic zoological regions they are but feebly represented, in fact they are almost absent in the southern parts of the Indian Peninsula; but they appear to be more numerous in Ceylon, and are probably not uncommon in the Himalayas.

ICHNEUMONIDÆ.

ICHNEUMON CLOTHO, *sp. nov.* (Pl. 3, f. 1).

Niger, abdomine cæruleo; linea antennarum, orbitis oculorum, scutello, post-scutelloque albis; alis fusco-hyalinis.

♀. Long. 15 mm.

Hab. Mussouri (Rothney).

Head black, shining, the face strongly, the front and vertex much less strongly punctured; the orbits on the top and bottom and on the inner side, on the bottom very

Feb. 22nd, 1897.

broadly; on the sides narrowly, and dilated in the middle, especially at the top, yellow; the mandibles thickly covered with dull fulvous hair; rufous before the apex. Antennæ stout; 7-8 joints near the middle on the underside yellowish-white; the scape punctured; on the underside covered with pale golden hair. Thorax black; the edge of the pronotum, scutellum and post-scutellum yellow, the mesonotum closely punctured; thickly covered with a short, dull fulvous pubescence; the scutellum punctured; the post-scutellum hardly so; the sides of the former smooth, shining, and impunctate; the depression at the side of the post-scutellum also smooth and shining and with a distinct margin; the median segment coarsely irregularly striolated at the base; the middle of the apex closely transversely striated; the sides much more strongly transversely striated; all the areæ clearly defined. The lower part of the propleuræ irregularly obliquely striated. The mesopleuræ closely punctured; the middle with some irregular longitudinal striations; the meta-pleuræ closely punctured, running into irregular striations at the apex. Legs covered with pale pubescence; the outer and lower half of the four anterior coxæ, the hinder coxæ entirely black, except a yellow spot in the middle above; the front femora are rufo-testaceous on the underside, the middle pair towards the apex only; the front tibiæ testaceous in front; the middle pair rufo-testaceous towards the apex; the hinder pair quite black and both the hinder pairs have a broad white mark near the base; the four anterior tarsi dull testaceous, the hinder pair dark, with the third and fourth joints white. Abdomen shining, bright blue, except the petiole, which is darker; shining, almost glabrous; the petiole at the apex before the gastrocæli with a strongly punctured spot; the gastrocæli shallow, large, the base with some striations; the apex flesh-coloured.

ICHNEUMON TAPROBANÆ, *sp. nov.*

Niger, pedibus flavis: coxis trochanteribusque nigris, alis fulvo-hyalinis, stigmatate fusco. ♂. Long. 11 mm.

Hab. Ceylon (*Rothney*).

Head bearing a white down; closely punctured, the clypeus with the punctures widely separated; the palpi testaceous. Thorax closely punctured; the depression at the base of the scutellum wide, deep; the scutellum finely punctured, shining; the centre fuscous; its apex finely longitudinally striated; the post scutellum finely rugose; the median segment rugose; there are two straight keels at the base, forming an almost square area; the lateral keels end in stout, blunt spines; the apex oblique, with two straight keels down the centre. The propleuræ finely longitudinally striated at the base; the mesopleuræ punctured, an oblique band of fine striations in the middle; the metapleuræ longitudinally striated, indistinctly at the base, much stronger at the apex. The front coxæ on the lower side are thickly covered with fulvous hair; the middle femora are fuscous on the underside at the base. At the top the areolet is narrowed, being there as long as the space bounded by the second transverse cubital and the recurrent nervures. Abdomen black; the apex of the petiole finely rugose, keeled down the sides; the gastrocœli finely striated at the base.

ICHNEUMON INTAMINATUS, *sp. nov.*

Niger; femoribus posticis rufis; alis hyalinis, nervis stigmatateque nigris. ♂. Long. 9 mm.

Hab. Missouri (*Rothney*).

Head entirely black; the front and vertex very shining, sparsely covered with white hair; the face and clypeus almost impunctate, covered with long white hair; the mandibles and palpi black. Antennæ as long as the body, black, the scape with longish pale hair. Thorax shining,

the pleuræ and sternum with long white hair; the median segment with an oblique slope at the apex; its base smooth, the rest rough, the apex with a few irregular striations; the apical part of the propleuræ near the middle with a few striations; the rest of the pleuræ obscurely punctured; the mesopleuræ and the metapleuræ at the apex on the lower side striolated. Legs thickly covered with short white hair; black, including the calcaria; the hinder femora red. The areolet is a little narrowed at the top, being there as wide as the space bounded by the first transverse cubital and the recurrent nervures. Petiole coarsely aciculated, keeled down the centre and the sides; the apex smooth, shining; the other segments smooth and shining.

ICHNEUMON VACILLANS, *sp. nov.*

Niger; tibiis tarsisque anterioribus, femoribus basique tibiarum posticarum, rufis; alis hyalinis, nervis fuscis. ♂.
Long. 11 mm.

Hab. Missouri (*Rothney*).

Head black, thickly covered with moderately long white hair, closely but not strongly punctured; the palpi black. Antennæ entirely black; the scape with a longish, the flagellum thickly with a microscopic pile. Thorax entirely black; thickly covered with short fuscous pubescence. Metapleuræ much more strongly punctured than the mesonotum and more opaque; the apex with a gradually rounded slope; obscurely striolated in the middle; a shallow furrow leads down from the spiracles; the pleuræ uniformly punctured. Wings hyaline; the nervures at the base and the stigma in the middle testaceous. Legs: the apical third of the anterior femora, the tibiæ and tarsi, the middle legs except the coxæ and trochanters, the hinder femora except the knees, and the basal third of the tibiæ, red; the calcaria pale rufous. Abdomen black, shining, impunctate.

ICHNEUMON APPROPINQUANS, *sp. nov.*

Niger; multo albo-maculato; pedibus rufis, basi nigris; alis fulvo-hyalinis, stigmatate fulvo. ♀. Long. 15 mm.

Hab. Missouri (*Rothney*).

Head black; strongly punctured; the vertex transversely striolated; the inner orbits from the clypeus to the hinder ocelli broadly yellow, narrowed towards the eyes; at the outer side at the foot of the eyes is a large yellow mark; and on each side of the clypeus is a crescent-shaped mark; palpi pale fulvous. Antennæ black, the upper side beyond the middle broadly white. Thorax closely punctured, covered with a pale short down; the edge of the pronotum, tegulæ, tubercles, scutellum, post-scutellum, two large marks on the median segment at the tubercles; and a large mark on the mesopleura, clear yellow. The apex of the pro- and meso-pleuræ crenulated; on the median segment are only the basal areæ; the apex oblique; at its top are some stout longitudinal keels; the centre coarsely rugosely punctured; the sides with stout transverse keels. The four front coxæ are broadly white at the base in front; the hinder pair have a large white mark at the base above; the trochanters black; the four anterior white at the apex; the hinder with a small white mark above; the apex of the fore femora, the tibiæ and the base of the tarsi white in front; the tarsi black, paler at the base. Wings fulvo-hyaline, the nervures fuscous, paler towards the apex; the stigma fulvous; the areolet at the top nearly as long as the space bounded by the recurrent and second transverse cubital nervures. Abdomen black; the apex of the petiole and a large mark on each side of all the other segments, white. Petiole smooth, shining, longitudinally striolated in the middle before the white; gastrocœli broad; their base roughly and irregularly striolated.

ICHNEUMON HYPOCRITA, *sp. nov.*

Niger, annulo antennarum, facie, scutello, coxis, trochanteribus tarsisque posticis albis; pedibus fulvis; trochanteribus posticis tarsisque posticis late nigris; alis fusco-hyalinis. ♂. Long. 10 mm.

Hab. Missouri (Rothney).

Head black, closely punctured; the face thickly covered with short white hair; below the antennæ entirely white, including the oral organs. Antennæ black, the scape beneath, and a broad belt (9 joints) beyond the middle, white. Thorax black; the tegulæ, tubercles, scutellum, and post-scutellum white; closely punctured; the scutellum with widely separated punctures; at the sides of the post-scutellum is a row of stout keels; the areæ on the median segment clearly defined; the supra median longer than broad, bulging out at the sides; the lateral wider than it and impunctate; the rest of the segment transversely striated. Pleuræ strongly punctured; the lower part of the propleuræ strongly striated; the metapleuræ rugosely punctured. The four anterior coxæ and trochanters white; the rest of them fulvous; the hind coxæ black; the hind femora black except at the extreme base; the hind tibiæ broadly black at the apex; the hind tarsi white except at the base. Wings hyaline, with a faint fuscous tinge; the stigma and nervures black; the areolet a little longer than broad; the transverse cubital nervures straight, parallel; the recurrent nervure is received shortly beyond the middle. Abdomen black, shining, smooth; the second and third segments at the apex fulvous.

ICHNEUMON ROTHNEYI, *sp. nov.* (Pl. 3, f. 2).

Niger; abdominis segmentis 2—6 ferrugineis; tibiis tarsisque sordide testaceis; alis flavo-hyalinis, stigmatate fulvo. ♂. Long. 17—18 mm.

Hab. Missouri (Rothney).

Head black, strongly and closely punctured; thickly covered with short grey hair; the mandibles piceous before the apex. Antennæ black, 7—8 of the middle joints yellowish-white. Thorax black, closely punctured; a line on the pronotum and the scutellum yellow; the latter smooth and almost impunctate; its apex black. The median segment rugose; thickly covered with short white hair, its apex hollowed in the centre; its sides with stout keels; there are two central keels widely separated; the space between these and the bordering keel stoutly transversely striated, it being also striolated obscurely on the innerside of the central keel; the basal area is a little wider than long. All the coxæ and trochanters are black and thickly covered with a pale down; the anterior femora slightly; the middle pair even more so and the hinder pair still more so, the apex of the hinder tibiæ and the apical joints of the tarsi, blackish. Wings hyaline, but with a distinct fulvous tinge; the stigma clear fulvous; the nervures fuscous, darker towards the base; the top of the areolet is a little less in length than the space bounded by the second transverse cubital and the recurrent nervures. Abdomen ferruginous; the petiole and the base of the second segment, black; the petiole smooth at the base; the sides at the apex coarsely punctured; the raised central part closely longitudinally striated. Gastrocœli large, deep, with a few stout, irregular keels; the second segment between longitudinally striated; the apical segments are smooth and impunctate.

ICHNEUMON BUDDHA, *sp. nov.*

Niger, scutello flavo; flagello antennarum medio late albo; pedibus rufis; apice tibiarum posticarum tarsisque posticis nigris; abdomine late rufo, apice albo. ♀. Long. 8 mm.

Hab. Missouri (*Rothney*).

Head black, the sides of the clypeus and the greater part of the mandibles in middle rufous; the eyes very distinctly margined on the inner side; the front and vertex closely punctured; the clypeus, except at the base, with very few punctures. Antennæ stout, sparsely and shortly pilose; the middle of the flagellum broadly white beneath and at the sides. Thorax black; the pronotum yellowish in the middle; the mesonotum coarsely alutaceous; the scutellum shining; post-scutellum narrowed towards the base; the part at the sides of the scutellum behind with strong, stout keels, which become wider from the inner to the outer side; the part at the sides of the post-scutellum crenulated. Median segment large; the apex with an oblique slope, roundly excavated in the centre; coarsely punctured; the sides at the apex irregularly obliquely striated; all the areæ completely defined; the central coarsely transversely striated; there are two stout keels bordering the central depression on the apical part. Propleuræ at the apex strongly striolated; the part above this coarsely punctured, the puncturing becoming finer towards the top; above the front coxæ are two stout, sharp keels, forming between them a sharp channel. All the coxæ and base of trochanters black; the apex of the hind tibiæ and the tarsi black; the middle tarsi fuscous. The basal half of the petiole black; the apical rufous; coarsely punctured; and with two sharp keels down the middle. The second and third segments entirely rufous; the apical two cream white above, except at the side of the penultimate; the ventral surface broadly rufous at the base; gastrocœli striated at the base.

ICHNEUMON VISHNU, *sp. nov.*

Long. fere 10 mm. ♂.

Hab. Mussouri (*Rothney*).

A species very like the above described species. It

seems to differ from it in too many points of colouration and structure to be its ♂. For example, the supra-median area on the median segment here is rounder and completely separated from the base, which is not the case with the other species; it is, further, fully larger, while if it were the ♂, it should be smaller.

Antennæ as long as the body, the scape covered with long fuscous hair; a white band of six joints beyond the middle. Head black; strongly punctured; the clypeus with only a few punctures on its apical margin. The orbits, except at the top, yellow, the inner band being the wider, especially at the bottom; the mandibles broadly yellow in the middle; the labrum fringed densely with golden hair. Thorax black; the edge of the pronotum, but not completely, the tegulæ, tubercles, and scutellum broadly at the sides, but not uniting at the apex, a line at the sides in front of it, and the post-scutellum, yellow. Pro- and meso-thorax closely punctured; the scutellum thickly covered with brownish hair; at the sides of the post-scutellum there are some stout keels. The median segment has an oblique slope at the apex; the central area complete, rounded at the base, almost transverse at the apex; the other nervures are not so clearly defined; the apex is transversely striated. Legs rufous; the coxæ, trochanters, apex of the hinder tibiæ and the posterior tarsi, black; the fore coxæ yellowish white at the apex. The areolet is much narrowed at the top; the transverse cubital nervures almost meeting there. Petiole black, a yellow band across its apex; the second and third segments rufous; the apical two segments white above; beneath the 2—4th segments are rufous.

ICHNEUMON CONFUSANEUS, *sp. nov.*

Niger, flagello antennarum albo; tibiis tarsisque anticis testaceis; abdomine late rufo; alis hyalinis, stigmate fusco.
♀. Long. 6 mm.

Hab. Trincomali, Ceylon (*Yerbury*).

Antennæ black, the 8—14th joints clear white beneath. Head closely punctured all over; the clypeus with the punctures more widely separated; the mandibles before the teeth rufous. Pro- and meso-notum closely and rather strongly punctured; the scutellum with the punctures smaller and more widely separated. Median segment with the areas complete; coarsely punctured; the apex in the middle closely transversely striated. The apex of the propleuræ strongly longitudinally striolated; on the mesopleuræ there is a shining impunctate spot below the hind wings. The middle tibiæ are darker coloured than the anterior, especially in front. The areolet is narrowed at the top, being there not much wider than the space bounded by the recurrent and the transverse cubital nervures; the recurrent being received nearly in the middle of the cellule. Petiole shining, black; the apex, except in the middle, with some distinctly separated punctures; the second, third, and base of the fourth segment ferruginous; gastrocœli smooth.

ICHNEUMON INQUIETUS, *sp. nov.*

Long. 6 mm.

Hab. Trincomali, Ceylon (*Yerbury*).

Is nearly related to *I. confusaneus*; but differs in having the legs without black, except on the apex of the hinder femora and tibiæ; the propleuræ more completely and strongly striolated, and the second abdominal segment closely longitudinally striated.

Head closely punctured, immediately over the antennæ obscurely striated transversely; the clypeus more shining, with the punctures much more widely separated; the mandibles pale yellow, piceous before the apex. Antennæ black; the 9—12th joints clear white. Mesonotum closely punctured; the scutellum shining; sparsely punc-

tured, especially at the base. Median segment coarsely punctured; the apex in the middle transversely striolated. The mesonotum punctured; the pro- and meta-pleuræ on the lower part longitudinally striolated. The four anterior legs fulvous; the coxæ and trochanters yellow; the hinder legs have a more reddish tint, including the coxæ and trochanters; a spot on the underside of the coxæ, the apex of the femora and the tibiæ black. Petiole black, shining; the second and third segment rufous; the base of the second depressed and with an interrupted transverse smooth shallow furrow at the apex of the depression; strongly longitudinally striolated, the striæ becoming very faint towards the apex, especially in the middle, which is aciculated.

ICHNEUMON INTEGRATUS, sp. nov.

Niger, facie, scutello, maculis 2 metanoti abdominisque segmentis late, flavis; alis fulvo-fumatis, stigmatè fulvo.
Long. 15 mm.

Hab. Missouri (Rothney).

Head black, densely covered with white, behind with fulvous hair; the face below the antennæ yellow; fulvous in the middle (perhaps through discoloration); the apex of the clypeus black; the mandibles reddish towards the apex; the base densely covered with fulvous hair; the palpi fulvous. Thorax thickly covered with pale pubescence; the tubercles, tegulæ, a short line in front of them, scutellum, a line on the post-scutellum, and two triangular marks on the median segment near the spiracles, yellow. Propleuræ irregularly striated towards the apex below. The median segment has only the basal area clearly defined; it is broader than long, rough; the centre with four stout keels, converging towards the apex; the apex has an abrupt slope; the central area closely and roughly transversely striated; the lateral areæ

with the transverse keels much stouter, more widely separated, and they are divided into two by a stouter keel. Coxæ black; the four hinder broadly yellow at the base; the apical joint of the four anterior trochanters pale; of the hinder pair entirely rufous; the apex of the hinder femora and of the hinder tibiæ black; the hair is fulvous on the coxæ. The alar nervures fuscous, pale at the base; at the top the areolet is as wide as the space bounded by the second transverse cubital and the recurrent nervure. Petiole shining at the base; the apex closely longitudinally striolated; the gastrocæli shining; the base with some stout keels; the yellow on the second and third segments, broad; the apical segments entirely rufous, the fourth and fifth only rufous at the base.

ICHNEUMON NUMERICUS, *sp. nov.*

Long. 15 mm. ♂.

Hab. Missouri (*Rothney*).

Resembles *I. integratus*; but has the yellow markings much more expanded on the thorax; the pleuræ having two large marks; the apex of the median segment yellow, and the antennæ yellow, broadly black at the apex.

Head rather strongly punctured, the lower part densely covered with white, above the antennæ with longer fuscous hair; below the antennæ entirely yellow; the inner orbits broadly to the hinder ocelli, and the outer to near the level of the lower, this latter belt becoming gradually narrowed to the top, yellow. The front in the middle transversely striated; the mandibles and palpi yellow; the former piceous at the apex; palpi yellow. Antennæ as long as the body, rufous-yellow, the apex broadly black; the three basal joints black above. Thorax closely punctured; thickly covered with short hair, which is darker on the mesonotum, whiter on the rest; a broad band on the pronotum; the scutellum,

post-scutellum, the apex of the median segment, except a small black mark in the middle at the apex, a triangular mark on the lower part of the propleuræ, a large mark on the lower side of the mesopleuræ, and an oblique one on the metapleura, yellow. On the median segment only the basal area is defined; it is longer than broad, smooth; the apex with four stout longitudinal keels, its extreme apex, yellow; the sides at the base rugosely punctured; the apex transversely striated, more strongly at the sides; the central keels stout, straight. The four front coxæ entirely yellow; the hinder black; the apex broadly rufous; the four front legs entirely rufous, yellower in front; the hinder rufous; the apex of the tarsi broadly black. Petiole black; the sides margined; stoutly keeled at the apex, which is strongly longitudinally striolated, raised at the middle, depressed at the sides; the base of the second segment striated; the gastrocœli shallow; the black bands on the second and third segments broad, triangularly produced in the middle at the base; in the centre of the fourth segment at the apex is a black mark, triangularly produced at the base.

ICHNEUMON AGRAENSIS, *sp. nov.*

Fulvus, pedibus posticis nigro-maculatis; alis fulvo-hyalinis, stigmatate fusco. ♂. Long. 13 mm.

Hab. Agra (*Rothney*).

Head luteous, the orbits paler; covered with a white microscopic pubescence; the face closely covered with shallow punctures; the apex of the clypeus rounded; the tips of the mandibles blackish. Scape of antennæ luteous; the flagellum, brownish beneath, darker above. Mesonotum of a darker tint than the rest of the body; rough in texture; the scutellum with large punctures; and covered with long fuscous hair, large, raised above the level of the mesonotum; a deep depression at its

base; its apex oblique. Median segment closely rugosely punctured; the base with the punctures larger and more widely separated; the extreme base impunctate. There is a central pear-shaped area, and two wide lateral ones; the apex is rounded and transversely striolated in the middle. The lower part of the propleuræ shining, impunctate; the upper with shallow punctures, the meso- and metapleuræ closely punctured; an impunctate spot on the mesopleuræ near its apex. Legs fulvous; the apex of the hind femora, of the hinder tibiæ and the hinder tarsi except at the base, black. The areolet at the top is as wide as the space bounded by the recurrent and the second transverse cubital nervures. Except at the base the abdomen is closely punctured, the apex of the petiole, depressed at the sides; the gastrocœli large, the innerside at the base striolated, the outer punctured, the space between longitudinally striated; the sixth joint entirely, the seventh, black with a large white mark in the middle at the apex; the two apical segments entirely black beneath.

CRYPTUS INFERNALIS, *sp. nov.*

Ferrugineus, capite, antennis, abdominisque apice late nigris; flagello antennarum annulo late albo; alis hyalinis, nervis fuscis. Long. 7 mm.

Hab. Agra (Rothney).

Head black; the orbits from the top of the frontal depression to the occiput, white, the white mark narrowed at base and apex; the frontal depression transversely striated; the palpi testaceous. Antennæ black, the middle of the flagellum broadly white. Thorax entirely red; the pro-mesonotum and scutellum shining; almost impunctate; the depression at the base of the scutellum crenulated. Median segment closely rugosely punctured; the base laterally shining and impunctate; at the base and at the top of the flat part is a

transverse keel which bulges backwards in the middle, the basal one being rounded, the apical transverse at the base; the apex has an oblique slope; the pleuræ closely punctured; the propleuræ at the base more shining and obscurely striolated. The four anterior legs rufous; the hinder femora and the coxæ black, except at the base and apex; the hinder tibiæ and tarsi black, the former only black behind. The petiole is broadly black at the base; smooth and shining, the apex without keels and not raised in the centre at the apex; its apex and the second segment ferruginous; the other segments black except the last, which is milk-white above. Gastrocæli absent. Areolet almost square.

CRYPTUS INDICUS, *sp. nov.*

Niger, albo-maculatus; pedibus anterioribus pallidis; coxis, trochanteribus femoribusque posticis rufis; tibiis tarsisque posticis nigris, basi albis; alis hyalinis, apice fumatis. ♂.
Long. 8—9 mm.

Hab. Missouri (*Rothney*).

Head shining, the front sparsely punctured; below the antennæ, including the oral organs and the inner orbits to the ocelli broadly, white; the tips of the mandibles black; the basal portion of the antennæ white beneath; the apical brownish. Thorax black, shining, minutely punctured; the prothorax in front, a curved mark narrowest on the outside, on the side of the meso-notum at the base, the tubercles, tegulæ, scutellum, and a mark on the apex of the metapleuræ over the coxæ, white. Pro- and meso-notum punctured; the scutellum impunctate, the median segment much more strongly punctured and without any keels. The four front legs are entirely pallid yellow; the hind coxæ, trochanters, and femora red; the apex of the hind femora, tibiæ, and tarsi, black; the base of the hind tibiæ and the greater part of the

metatarsus at the base, white. Wings clear hyaline, the apices of both wings smoky; the nervures fuscous; the areolet shortly appendiculated at the top; the recurrent nervure received in the basal third of the cellule. Abdomen very smooth, shining; the petiole entirely white on the basal half; its apex narrowly, the base of the second segment, its apex narrowly, the base and apex of the third and fourth, broadly, white; the ventral surface for the greater part white.

CRYPTUS ORIENTALIS, *sp. nov.*

Niger, pedibus abdomineque late rufis; alis fusco-hyalinis, nervis testaceis. ♀. Long. 12; terebra 4 mm.

Hab. Missouri (*Rothney*).

Head black; the apex of the clypeus, the orbits narrowly, except near the top behind, the base of the mandibles, a line at their base joined to the eyes, pale testaceous; the palpi fuscous, testaceous at the base. Antennæ black; the 6—8 joints pale testaceous beneath. Thorax black; closely punctured; the lower half of the propleuræ strongly longitudinally striolated; the parapsidal furrows complete, deep, broadest at the base; the scutellum closely punctured; the post-scutellum shining, and bearing a few scattered punctures; on the base of the median segment are two large areas, curved; truncated at the sides, the space enclosed being finely rugose; between the basal and the apical keels the front is strongly irregularly striolated; the central keels being the larger and most regular; the spines large, somewhat triangular. The apex has an oblique slope; the centre coarsely coriaceous; the sides with stout transverse striations. Coxæ and trochanters black; the anterior trochanters testaceous at the apex; the hinder tibiæ infuscated, especially towards the apex; the hind tarsi rufo-testaceous, the metatarsus except at the apex, and the apex of the terminal joint black. At the top the

areolet is as wide as the space bounded by the second transverse cubital and the recurrent nervure. Abdomen shining, impunctate; bare; black; the apex of the petiole, the apex and sides of the second segment, the third segment except at the base and the others almost entirely, rufous.

HEMITELES VEDA, *sp. nov.*

Ferrugineus, thorace nigro-maculato; alis fulvis. Long. 15; terebra 4 mm.

Hab. Trincomali, Ceylon (*Yerbury*).

Head ferruginous, the part above the antennæ, and a triangular mark leading down to it from the ocelli, black, the part enclosing the ocelli being also black; strongly punctured, the clypeus and the part immediately over the antennæ, smooth; the inner orbits below the antennæ obscure yellow; the inner orbits above the antennæ distinctly margined; the clypeus near the base of the mandibles, black. Antennæ bare; from the thirteenth joint brownish beneath, blackish above. Thorax rufous; a small mark on the propleuræ, the mesopleuræ broadly at the base, narrowly at the top and down the apex, the metapleuræ except a mark in the centre leading into a smaller one at the side, black; the extreme base of the median segment, its apex and two oblique marks there, black; the metanotal keels almost obsolete at the base; towards the apex there are two straight central and an oblique lateral fairly well indicated; the lower side of the propleuræ obliquely striolated; the base and apex of the mesopleuræ narrowly longitudinally striated; the base of the metapleuræ crenulated, and on the lower side there is a stout curved keel. Legs ferruginous, the tips of the tarsi and a large mark on the hinder side of the posterior coxæ, black. Wings fulvous, lighter coloured at the apex; the stigma and costa fulvous; the nervures blackish; the areolet wider than long,

narrower at the bottom than at the top through the first transverse cubital nervure being sharply, the second slightly, oblique; the recurrent nervure is received in the basal third of the cellule. Petiole shining, the apex finely punctured, and with an elongated depression; the base broadly black; the rest of the abdomen shagreened.

MESOSTENUS HIMALAYENSIS, *sp. nov.*

Niger, albo-maculatus; pedibus fulvis; coxis anterioribus albis, basi tibiæ tarsorumque posticorum late nigris; alis hyalinis; nervis fuscis. ♂. Long. 9 mm.

Hab. Himalayas.

Antennæ as long as the body; black; the scape beneath and a broad band beyond the middle, white. Head shining; the face closely punctured; the front obscurely striolated; below the antennæ, the oral region except the apices of the mandibles, the orbits except near the top of the eyes, white. Thorax black; the mesonotum closely punctured; a broad line on the pronotum, tegulæ, tubercles, a mark on the centre of the mesonotum, scutellum, post-scutellum, three marks on the median segment in a triangle, a mark at the base of the mesopleura, a smaller one at the apex nearer the breast, a somewhat triangular mark below the hind wings, a large pear-shaped mark on the metapleura and the greater part of the mesosternum, white. Median segment with a gradually rounded slope, coarsely punctured; the basal white mark is longer and narrower than the apical. The four front coxæ and trochanters white; the hinder red like the femora; the basal joint of the trochanters blackish; the apex of the second, the third, and the fourth tarsal joints are white. Wings hyaline, the areolet quadrangular; the recurrent nervure received at its apex. Abdomen black, shining, impunctate; all the segments broadly white at the base above and beneath.

ROTHNEYIA, *gen. nov.*

Differs from all known Ichneumonidæ by having only three visible abdominal segments, the third ending at the apex in a semicircle which forms at each side a stout tooth; the scutellum projects at each side in a stout triangular tooth; there are two large spines on the centre of the median segment at the side. Antennæ 25-jointed. Legs and wings as in *Ichneumon*.

This genus does not fit well into any of the subtribes of *Ichneumonides*. The alar neuration is quite as in *Ichneumon*; but otherwise the genus differs completely; and, as regards the abdomen, it can only be compared with some Braconidæ such as *Chelonus*. The form of the spiracles I cannot determine from the roughness of the median segment.

ROTHNEYIA WROUGHTONI, *sp. nov.* (Pl. 3, f. 3).

Nigra, petiolo ferrugineo; pedibus rufis; geniculis, tibiis tarsisque posticis, nigris; alis hyalinis, basi antennarum late rufis. ♀. Long. 5 mm.

Hab. Missouri (*Rothney*).

Antennæ black; the 5—6 basal joints of the flagellum brownish; closely covered with a microscopic down, the scape with white hair. Head black; below the antennæ thickly covered with long white hair; the front and vertex punctured, more sparsely covered with fuscous hair. Mandibles depressed at the base; piceous in the middle; the palpi white. Thorax black; the mesonotum more strongly in the centre, which is broadly raised; the scutellum rugosely punctured; the sides raised; the apex between the teeth depressed; the apex of the teeth rufous. The middle of the metanotum between the teeth stoutly bordered or margined all round; the top longitudinally, the apex irregularly transversely striolated; with a semicircular keel at the extreme apex. Pleuræ

shining; the lower part strongly transversely striolated; the mesopleuræ at the top punctured, on the lower part more closely punctured; the central part impunctate and with a few striations. Wings hyaline, the nervures fuscous; the cubitus a little narrowed at the top, being there as wide as the space bounded by the second transverse cubital and the recurrent nervures, which, as is also the second transverse cubital, are widely bullated. Legs rufo-testaceous; the apex of the hinder femora and the hinder tibiæ and tarsi, black. Abdomen black; the petiole rufous; covered closely with short white hair; closely and strongly punctured; petiole with the sides strongly keeled; the keels at the dilated apex being continued slightly obliquely to the apex down the middle; the genital armature white.

PIMPLIDES.

PIMPLA PULCHRIMACULATA, *sp. nov.*

Nigra, late flavo-maculata; pedibus fulvis; alis hyalinis, apice violaceo-maculatis. ♀. Long. 14 mm.

Hab. Trincomali, Ceylon (*Yerbury*).

Head smooth, shining; yellow; the ocellar region, a band leading down from it to a broad transverse band over the antennæ, and the occiput broadly, black. Antennæ nearly as long as the body, black. Palpi testaceous. Pronotum narrowly edged with yellow; the mesonotum black, with two lines in the middle running from the base to the tegulæ, becoming gradually narrower as they do so; the scutellum, except at the apex; post-scutellum and two broad curved lines on the sides of the median segment; the base of the propleuræ, a large mark on the mesopleuræ much narrowed on the lower side, the tubercles, a mark before the middle coxæ, and the metapleuræ, except a black oblique line leading to the spiracles, yellow. A broad black mark, narrowed

in the middle down the centre of the median segment. Legs fulvous, the coxæ yellow; a large mark in front of the hind pair and a smaller mark behind, joined together by a broad band at the top, black. Petiole smooth and shining; a broad band in the middle ending before the apex in a large semicircle; the other segments closely punctured; the terminal segments are brownish; the oblique depression on the 2—4th segments distinct; the second segment broadly depressed at the sides at the base, the segment at the outer side of the depression being yellow. The outer half of the cubitus curved; the areolet oblique, shortly appendiculated at the top; the cloud at the apex extends from the costa to about the same distance below the cubital nervure.

PIMPLA TAPROBANÆ, *sp. nov.*

Nigra, pedibus flavis, coxis trochanteribusque nigris; alis fulvo-hyalinis. ♀. Long. 13 mm.

Hab. Ceylon.

Head closely punctured, covered with a short white pubescence; the face projecting, at top forming almost a triangle; clypeus forming a semicircle at the top, where it is obscurely punctured; the apex almost perpendicular; the labrum piceous, fringed with long golden hair; palpi and mandibles entirely black. Pro- and meso-notum thickly covered with fuscous hair; obscurely shagreened; a large square spot on the scutellum and a long one on the post-scutellum, yellow; the median segment broadly raised in the middle at the base; the centre raised; strongly, the sides finely transversely, striated; the centre at the apex with an oblique slope; the sides rather acute at the top. Pro- and meso-pleuræ shining, impunctate, thickly covered with short whitish pubescence; and having a plumbeous tinge. Legs almost bare; the fore trochanters beneath and at the apex all round, yellow. Wings fulvo-hyaline; the stigma testaceous in the middle;

the tegulæ black. Abdomen entirely black; shining; impunctate; the petiole at the base depressed in the middle; oblique; its top somewhat triangularly, its sides much more widely depressed; gastrocœli oblique, smooth, raised in the centre; and from them an oblique furrow leads to the apex of the segment; the oblique furrows on the third segment moderately deep and wide; on the fourth they are shallower.

PIMPLA LAOTHOE, *sp. nov.*

Nigra, pedibus rufis; coxis, trochanteribus, apice tiliarum posticarum tarsisque posticis, nigris; alis fulvo-hyalinis; nervis fuscis, stigmatè fulvo. ♀. Long. 13 mm.; terebra 3—5 mm.

Hab. Missouri (*Rothney*).

Head black, thickly covered with pale fulvous hair, especially long and thick below the antennæ, where there is in the centre a shining, impunctate line; the front broadly but not deeply depressed; the front ocellus surrounded by a furrow, which is continued down the front to the antennæ; the front with the punctures shallow, especially towards the eyes. Thorax entirely black; the pro- and meso-notum closely punctured, thickly covered with short fuscous hair; scutellum shining, smooth; the punctures shallow, widely separated, the sides much more strongly and closely punctured, except at the base; post-scutellum rugosely punctured; the median segment with a gradually rounded slope, rugose; the centre transversely striated. Propleuræ at the bottom longitudinally striated; at the top are two stout longitudinal keels. All the coxæ and trochanters black; the coxæ beneath thickly covered with fulvous hair, as are also the tibiæ and tarsi; the hinder tarsi black. Abdomen entirely black; above closely, strongly, and uniformly punctured, except at the apices of the segments, which are smooth and shining; the base of the petiole widely depressed, smooth and almost impunctate.

PIMPLA NEPE, *sp. nov.* (Pl. 3, f. 4).

Long. 13 mm.; terebra 4 mm.

Hab. Missouri (*Rothney*).

Almost identical in coloration with *P. laothoe*, but may be known from it by the absence of the furrow on the front and of the keels on the propleuræ; by the scutellum being more closely and strongly punctured and pale yellow in the centre.

Head closely and strongly punctured below the antennæ; the front widely depressed, impunctate, shining; the palpi dirty testaceous. Pro- and meso-notum strongly and closely punctured, thickly covered with short pale hair; the scutellum thickly punctured behind, more sparsely in front; the top with a pale orange mark; the post-scutellum strongly longitudinally striolated. Median segment with a gradually rounded slope from the base to the apex; coarsely rugosely punctured; the centre broadly raised in the middle towards the apex. Pleuræ and sternum punctured. All the coxæ and trochanters are black; the former on the lower side thickly covered with fulvous hair; the hinder tarsi black, except at the apex. The petiole with a deep impunctate excavation at the base; the other segments closely and somewhat strongly punctured, except at the extreme apex.

OPHIONIDES.

ENICOSPILUS CEYLONICUS, *sp. nov.*

Flavus; alis hyalinis, stigmatè fulvo. ♀. Long. 15 mm.

Hab. Ceylon, Trincomali (*Yerbury*).

Antennæ longer than the body, uniformly fulvous; the scape bare, the flagellum with a close microscopic pile. Head fulvous, the face paler, more yellowish; the tips of the mandibles black; the palpi testaceous; the ocelli very large, raised above the level of the eyes,

which the hinder almost touch. Mesonotum shining; the scutellum pallid yellow; the base of the median segment depressed in the middle; a stout transverse keel behind it; behind this keel the segment is coarsely shagreened and with an indistinct furrow down the centre; the pleuræ coarsely shagreened. Legs uniformly fulvous, almost bare; wings clear hyaline; the stigma fulvous; the clear bare space contains one large horny mark, with a distinct dark border; above it is a curved spot, and behind two smaller spots. Abdomen darker towards the apex. The cubital nervure is much thickened at the base.

Enicospilus, or *Henicospilus* as the purists would have it, differs from *Ophion* proper in the fore wings having a clear space, which usually contains one or more horny points; and, the stump of the cubital nervure, found well developed in *Ophion*, is absent. In some cases the smooth space is present without having horny points in it, or they are very faint. In either case I believe it will be found that the base of the cubital nervure is thickened, which is not the case with *Ophion*, *sensu str.* In view of the great similarity of the species of *Ophion*, it seems to me desirable to adopt *Enicospilus* as a distinct genus. Species belonging to it are found in all parts of the world.

ANOMALON DECORUM, *sp. nov.*

Nigrum, facie, orbitis oculorum, ore, palpis, linea pronoti, tegulis, scutello, coxis trochanteribusque, flavis; alis hyalinis.
♀. Long. 10 mm.; terebra 3 mm.

Hab. Trincomali, Ceylon (*Yerbury*).

The scape yellowish beneath; the flagellum absent. Head shining, sparsely covered with white hair; yellow; the centre of the vertex broadly (the black narrowed towards the bottom), and the occiput, except at the edges, black; the tips of the mandibles black; the eyes

largely converging at the bottom, they being there not separated by much more than twice the width of the scape. Thorax black; the pronotum broadly, tegulæ and tubercles yellow. Mesonotum opaque; the central lobe raised; the scutellum yellow; the median segment reticulated; the pro- and meso-pleuræ longitudinally striolated, closely above, more widely below; the meta-pleuræ reticulated. The four front legs yellow; the tibiæ and femora infuscated beneath; the tarsi at the apex black. The wings reach to the middle of the abdomen. Petiole black, smooth and shining, the apical third dilated; its top with an elongated depression; the other segments testaceous beneath.

ANOMALON BRACHYPTERUM, *sp. nov.*

Nigrum, pedibus anterioribus, trochanteribusque posticis, pallidis; alis brevibus, hyalinis; abdomine testaceo, apice nigro. ♂. Long. 9 mm.

Hab. Trincomali, Ceylon (*Yerbury*).

Antennæ black, the scape yellow beneath; the flagellum covered with a microscopic down. Head black; closely punctured; the face densely covered with white hair; the mandibles testaceous, the palpi white. Thorax black, rough; in front sparsely, behind thickly, covered with white hair; the median segment with a gradual slope. Wings short, not reaching much beyond the apex of the petiole; the nervures black. The front four legs whitish yellow; the posterior black, the trochanters, knees, and spurs whitish-yellow (the front four legs are vermilion, but this is probably owing to discoloration with chemicals). Abdomen more than twice the length of the head; the petiole longer than the second segment, nodose at the apex; the base black; the apex brownish; the rest rufotestaceous; the second segment testaceous, black above; the apical two segments black above.

ANOMALON MUSSOURIENSE, *sp. nov.*

Nigrum; flagello antennarum, pedibus abdomineque fulvis; alis fulvo-fumatis. ♀. Long. 17—18 mm.

Hab. Missouri (*Rothney*).

Antennæ fulvous; the basal two joints entirely, and the third above, black. Head black; thickly covered with long fulvous hair, palest on the face; the lower three-fourths of the inner orbits, broadly in front, narrowed behind, the front and vertex coarsely, rugosely punctured; the face below the antennæ, the clypeus, labrum, and the mandibles, except at base and apex, fulvous-yellow; the palpi rufous; the face and clypeus coarsely punctured, depressed at the sides. Thorax strongly punctured; thickly covered with short fuscous hair; the scutellum yellow; a fulvous mark on the apex of the mesopleuræ and an oval one on the metapleura, rufo-fulvous; the suture on the apex of the mesopleura, yellow. The median segment coarsely reticulated; depressed in the middle; the apex in the centre with stout curved transverse keels. Legs rufous; the anterior paler, of a more yellowish tinge; the four posterior coxæ black, rufous at the base; the apex of the hinder femora and of the hinder tibiæ, black. A line on the top of the second and on the top of the fifth and sixth and the third to sixth abdominal segments, broadly at the sides on the lower part, black. The wings are uniformly fulvous smoky; the stigma and costa fulvous; the other nervures fuscous.

CAMPOPLEX BUDDHA, *sp. nov.*

Niger, tibiis tarsisque anticis flavis; abdominis medio late rufo; alis hyalinis; nervis stigmatæque nigris. ♀. Long. 14 mm.

Hab. Missouri (*Rothney*).

Antennæ black, shining, sparsely covered with long white hair. Head closely and almost uniformly punctured,

the face thickly covered with white hair; the hair on the top is equally thick and somewhat longer. Palpi testaceous, black at the base. Thorax closely punctured, thickly covered with white hair, short on the mesonotum, longer on the rest of the thorax; scutellum distinctly margined at the sides; the median segment longitudinally rugulose; the apex more coarsely transversely striolated. Propleuræ on the lower side irregularly obliquely striolated; the apex of the mesopleuræ shining, almost impunctate; the metapleuræ opaque, finely rugose. Legs covered with a white down; the anterior knees, tibiæ, and tarsi yellow; the middle knees testaceous; the calcaria white. Abdomen shining; the third and fourth and the lower half of the fifth segments rufous.

CAMPOPLEX SPECIOSUS, *sp. nov.*

Long. 12 mm.

Hab. Ceylon.

Is very near to *C. buddha*; but may be known from it by the base of the median segment having a clearly defined large triangular keel.

Head closely and uniformly punctured; thickly covered with glistening white hair; the mandibles yellow, the teeth piceous. Antennæ entirely black, longer than the body. Thorax black, closely punctured, thickly covered with short white hair; in the centre of the mesonotum is a longitudinal furrow; the median segment in the middle in the part below the triangular keel is irregularly striated; the apex with the striæ more apart, and it is more shining. The mesopleuræ have the punctures more distinctly separated than the others. The anterior coxæ and trochanters entirely, the apex of the middle coxæ and the basal joint of the middle trochanters and the underside of the four anterior femora, bright lemon yellow; the anterior tibiæ and tarsi entirely and the

middle tibiæ in front whitish-yellow; the coxæ thickly covered with long glistening white hair; the calcaria white. Wings clear hyaline; the costa and nervures black. Abdomen black; the third to fifth segment red.

CAMPOPLEX SUMPTUOSUS, *sp. nov.*

Hab. Ceylon.

Is similarly coloured to the preceding two species, but is much smaller (7 mm.), and otherwise may be readily separated by the two keels at the base of the median segment being roundly curved.

Black; the apex of the second segment, the third and fourth and the base of the fifth segments red; wings clear hyaline. Head black, closely and uniformly punctured, thickly covered with short white hair, darkest and shortest on the vertex; mandibles and palpi black. Scape of antennæ sparsely covered with white hair; the flagellum with a close, black, microscopic down. Thorax closely punctured, the propleuræ strongly obliquely striolated at the bottom; the raised part on the mesopleuræ below the tegulæ finely transversely striated. Median segment broadly, but not deeply depressed in the middle, the basal keel roundly curved. Legs thickly covered with white microscopic down; the calcaria black. The areolet oblique, triangular at the top; the recurrent nervure received near the apical third of the areolet.

LIMNERIA CEYLONICA, *sp. nov.*

Nigra, abdominis apice late rufo; trochanteribus, tibiis, tarsisque anticis, rufis; alis hyalinis, stigmatate nigro. ♂. Long. 7—8 mm.

Hab. Ceylon (*Rothney*).

Head very closely and rather strongly punctured all over; the face somewhat thickly covered with short white hair; the mandibles ferruginous, black at the base; the

palpi testaceous, paler towards the apex. Antennæ entirely black, covered with a dark microscopic down. Thorax entirely black, alutaceous; thickly covered with white hair; the propleuræ shining, obliquely striated; strongly at the base, much finer at the apex; the mesopleuræ punctured; in the centre above to near the middle transversely striolated; the metapleuræ alutaceous; all thickly covered with short white hair; the median segment has a gradually rounded slope, and is thickly covered with white hair. Anterior coxæ black, white at the apex; the base of the trochanters and the anterior femora tibiæ and tarsi fulvous; the apex of the middle femora and base of tibiæ, rufous; all the spurs pale. Wings clear hyaline, slightly infuscated towards the apex; the areolet shortly appendiculated at the top; the nervures slightly curved, the lower side sharply angled in the middle. The basal segment of the abdomen entirely black; the second segment black, except the apex above and a mark on the side of the apex which are rufous like the rest of the abdomen.

LIMNERIA AGRAENSIS, *sp. nov.*

Nigra, pedibus rufis; apice tibiæ posticarum tarsisque nigris; alis hyalinis, stigmate testaceo; tegulis flavis. ♀.
Long. 7—8 mm.; terebra 3 mm.

Hab. Agra (*Rothney*).

Head alutaceous, except on the vertex very thickly covered with white hair; the mandibles testaceous, thickly covered with golden hair; the teeth black, the part in front of them piceous; the palpi yellow. Thorax black; closely punctured, thickly covered with white hair; the middle of the mesopleuræ transversely striated, and with a smooth spot at the apex of the striated part; the basal area of the median segment larger, longer than broad; the keel straight, forming an acute angle in the

centre; the apex of the apical area bulges into it as a triangle from the sides of which a keel goes round the edge of the segment; there is a short, stout, oblique keel outside the spiracles, beyond which it curves round to the apex of the segment, but is much thinner than the basal branch. Legs rufous; the base of the anterior pair yellow; the apex of the hind tibiæ and the tarsi black; the latter thickly covered with a white down, the spurs pale yellow. Wings clear hyaline; the stigma and nervures dark testaceous. Abdomen black; the second and third segments pale testaceous beneath; the petiole with an elongated area at the base of the thickened part; the apices of the second and third segments obscure rufous.

LIMNERIA MOROSA, *sp. nov.*

Nigra, palpis tegulisque albis; pedibus rufo-testaceis, abdominis segmentis testaceo-maculatis; alis hyalinis. ♀.
Long. 5 mm.

Hab. Trincomali, Ceylon (Yerbury).

Antennæ entirely black, thickly covered with a pale microscopic pubescence. Head closely punctured, the face thickly covered with white pubescence; the mandibles and palpi white. Thorax shagreened, opaque, sparsely covered with minute pale hair; the three basal areæ on the median segment distinct; the others not clearly defined, the apex finely transversely striated. The four anterior legs pale testaceous; the femora with a more reddish hue; the coxæ broadly black at the base; the hinder entirely black; the apex of the hinder tibiæ and tarsi fuscous. Petiole black, shagreened, the base flat, very smooth and shining; the other segments black, broadly rufo-testaceous at the apex and at the sides; the ventral segments of a paler more yellowish testaceous colour. The stigma testaceous on the lowerside; the areolet distinctly petiolated.

PANISEUS CEYLONICUS, *sp. nov.*

Long. 19 mm.; terebra 4 mm.

Hab. Trincomali, Ceylon (*Yerbury*).

Comes near to *P. lineatus*, Bé. from Bengal, but that has the mesonotum marked with brownish lines; the alar nervures brownish at the base, reddish at the apex, while here they are uniformly black, and no mention is made of the dark antennæ.

Antennæ as long as the body; the scape testaceous; the flagellum black, dark brownish on the underside beyond the middle. Head clear yellow, the occiput in the middle of a more fulvous line; the teeth of the mandibles black, rufous at their base. Thorax bearing a microscopic white down; the median segment finely and closely but distinctly transversely striated. The hinder tarsi pale yellow. Abdomen infuscated towards the apex. The second transverse cubital nervure is interrupted on the lower side.

TRYPHONIDES.

EXOCHUS AITKINI, *sp. nov.*

Niger, pedibus strammeis; coxis tarsisque posticis nigris; alis hyalinis, stigmatate fusco. ♂. Long. 7 mm.

Hab. Bengal (*E. H. Aitkin*).

Head shining, closely covered with short black hair; below the antennæ closely and somewhat strongly punctured; a semicircular furrow in front of the ocelli, the palpi, yellow; the mandibles before the apex piceous. Antennæ bearing a close fuscous pile; the flagellum, especially towards the base, brownish. Pro- and mesonotum sparsely covered with fuscous pubescence; the suprmedian area on the median segment a little longer than broad; the keels at its base curved outwardly to shortly beyond the middle, when they become straight and oblique; the apical keel transverse. Pro-, meso-,

and base of the meta-pleuræ shining and impunctate; the latter with a curved keel on the innerside of the spiracle, beyond which the segment is shagreened. The base of the petiole depressed; the depression margined, the margin continued shortly beyond it as blunt keels; the apex of the segment obscurely punctured.

The areolet is petiolated to near the bottom, where there is formed a minute cellule, not much wider than the transverse cubital nervure; its outer nervure is faint, and is interstitial with the recurrent.

BRACONIDÆ.

BRACON CEYLONICUS, *sp. nov.* (Pl. 3, f. 5).

Niger, pro-meso-thoraceque rufis; pedibus anticis testaceis; alis fere hyalinis. ♀. Long. fere 7 mm.; terebra fere 2 mm.

Hab. Ceylon (Yerbury).

Head black, shining, impunctate, the oral region (including clypeus) rufo-testaceous; the tips of the mandibles black; the palpi pallid testaceous. Antennæ longer than the body, entirely black. Thorax shining, impunctate, sparsely covered with white pubescence; the prosternum black; the metapleuræ and the median segment at the apex infuscated. Wings longer than the body; the lower side of the stigma fuscous. The middle legs, except at the base, infuscated; the hinder coxæ, femora, tibiæ, and tarsi, black; the trochanters fuscous. Abdomen black; the basal three ventral segments white, with a black spot in the centre of each. Petiole broadly depressed at the base and down the sides; the rest rugosely longitudinally punctured. The other dorsal segments coarsely rugosely punctured; the second with a raised somewhat triangular space in the centre at the base, from which a sharp keel runs to near the apex; at its side is an oblique furrow, with a sharp border on the inner side; the suturiform articulation longitudinally striated.

BRACON TRICARINATUS, *sp. nov.*

Niger, capite, prothorace, scutello, abdominis basi et apice pallide luteis; alis fere hyalinis. ♀. Long. 7 mm.; terebra 3 mm.

Hab. Ceylon (Yerbury).

Head testaceous-yellow, except at the orbits; shining, impunctate; the tips of the mandibles black and piceous; a deep, wide furrow leads down from the ocelli. The scape of the antennæ black; the flagellum broken off. Pro- and meso-notum smooth, shining, impunctate; in the centre of the latter is a large black mark reaching from the extreme base to near the middle, and two equally large lateral ones reaching from near the base to the apex; the scutellum luteous; the mesonotum at its sides and apex, black. Median segment entirely black; at the base in the centre is a depression which is finely longitudinally striated. Meso- and meta-sternum black; the metapleuræ and the mesopleuræ from the end of the oblique furrow, black. The front legs are entirely testaceous; the middle pair testaceous except the coxæ and trochanters; the posterior pair entirely black. The petiole testaceous; its raised centre black; the raised central part is narrowed gradually towards the apex, where it is a little less than the width of the lateral parts; at the apex it is stoutly keeled in the centre with the sides depressed; the base of the depression sharply keeled; the lateral depression on the inner side obliquely striated; its sides keeled down the centre. The second segment in the centre irregularly reticulated; the sides rugosely punctured; in the centre is a straight, stout keel, triangularly dilated at the base, this part being aciculated; the latter keels are equally stout, not dilated at the base and oblique; the third segment is longitudinally rugose, except at its sides at the apex, where it is smooth and shining; in the centre

is a keel; the other segments are only black down the centre and at the sides; the ventral segments black, the base testaceous, sharply produced in the middle.

BRACON ITEA, *sp. nov.*

Long. 4—5 mm.; terebra 2 mm.

Hab. Trincomali (*Yerbury*).

Head testaceous, shining, the face, except in the centre, aciculated; the palpi pale; antennæ black; the second joint obscure testaceous. Thorax testaceous, the median segment infuscated in the middle, where there is a shallow furrow. The legs pallid testaceous; the hinder femora and tibiæ infuscated, the former above and beneath. The raised central part of the petiole aciculated; the second and third segments rather strongly rugosely punctured; keeled down the centre; the dilated base of the keel on the second segment aciculated; the suturiform articulation finely longitudinally striolated; the third and fourth segments with a transverse furrow, oblique at the sides and longitudinally striolated; the second, third, and fourth segments broadly black in the middle; the black suffused with piceous on the third; the third with a distinct, the fourth with a less distinct longitudinal furrow; the ventral segments yellowish-testaceous.

BRACON AGRAENSIS, *sp. nov.* (Pl. 3, f. 6).

Flavus, vertice antennisque nigris; alis fuliginosis, basi late flavo. ♀. Long. 13 mm.; terebra 2 mm.

Hab. Agra (*Rothney*).

Antennæ as long as the body, black, almost glabrous. Head shining, thickly covered with long fulvous hair; the sides of the clypeus with an oblique, the base with a straight furrow; the apices of the mandibles black; behind the black extends to near the middle of the eyes. Thorax entirely yellow, smooth; a broad, curved furrow across the mesopleuræ. Legs entirely yellow. The raised

part of the petiole strongly longitudinally striolated; the second segment inside the oblique furrows strongly longitudinally striolated; the base at the sides smooth; the furrows striolated; the suturiform articulation longitudinally striolated, broadened at the sides. The wings are yellow to near the base of the first cubital cellule; the first cubital cellule is hyaline above and beneath and at the base; and there is a clearer hyaline spot below the transverse cubital nervure. The stigma is broadly yellow at the base.

BRACON INGRATUS, *sp. nov.*

Long. fere 10 mm.

Hab. Agra (*Rothney*).

Head shining; the tips of the mandibles black; a broad furrow leads down from the ocelli. Thorax shining, impunctate; the curved furrow on the mesopleuræ wide; the median segment with a gradual slope, very smooth and shining. On the metapleuræ is a broad oblique furrow. Legs entirely luteous, the tibiæ thickly covered with pale hair. Wings bright yellow to near the stigma, which is luteous, black at base and apex; the first cubital cellule with a large somewhat triangular hyaline spot, and there is a smaller one below the first transverse cubital nervure. Petiole smooth; the apex in the centre with a few stout longitudinal keels; the lateral furrows wide. The other segments strongly rugosely punctured; the second segment with a stout keel in the centre reaching near to the apex; at the sides is a broad slightly curved depression, stoutly keeled on the innerside; the other segments have a stout transverse keel at the base, which become wider at the sides, and are crenulated.

In coloration it agrees exactly with *Bracon agraensis*; but may be at once separated from it by the strongly punctured abdomen with the longitudinal keel on the second segment.

BRACON ROTHNEYI, *sp. nov.*

Fulvus; alis fuscis, basi flavo; antennis nigris. Long. 6.5 mm.

Hab. Agra (*Rothney*).

Head entirely yellow, except the tips of the mandibles, which are black; the front and vertex shining, impunctate; below the antennæ it is obscurely rugose; furrowed down the centre; the clypeus shining, impunctate. Antennæ entirely black. Thorax above entirely smooth, shining, impunctate, very sparsely haired. Pleuræ smooth and shining; the metapleuræ with an oblique furrow. Legs entirely luteous, sparsely covered with white hair. Wings uniformly dark fuscous; the costa, except before the stigma, and the latter at the base, fulvous. Abdomen rugosely punctured; the raised part of the petiole with a double keel, open at the base, rounded at the apex. At the base of the second segment is a shining, smooth, raised area from which a stout keel proceeds to near the apex; at the side is a large oblique Λ -shaped space, acutely margined on the innerside and obliquely striolated; there are indistinct depressions on the sides of the third and fourth segments.

BRACON YERBURYI, *sp. nov.*

Niger, orbitis oculorum, pro- et meso-thorace rufo-testaceis; tibiis, tarsis anterioribus, femoribusque anticis, testaceis; alis fere hyalinis. ♀. Long. 4 mm.; terebra fere 1 mm.

Hab. Ceylon, Trincomali (*Yerbury*).

Antennæ black; the flagellum covered with a very microscopic pile. Head obscure dark testaceous, darker on the face and on the vertex; the face with a distinct longitudinal keel. Thorax dark rufo-testaceous; the metathorax much darker; the mesopleura with an oblique deep wide furrow at the top. The hinder legs are entirely black and thickly covered with white microscopic

pubescence; the middle tibiæ are obscure testaceous at the base; the rest of it and the tarsi black. The lower side of the stigma and the apical nervures are testaceous. The petiole obscure brown; the raised central part finely longitudinally striated; the second and third rather coarsely longitudinally striated; the second much more strongly than the third; and it has also its sides depressed and finely and irregularly striated; both have a smoother longitudinal line down the middle; the other segments are obscure brownish and aciculated.

SPINARIA NIGRICEPS, *sp. nov.* (Pl. 3, f. 7).

Nigra, thorace abdominisque basi rufis; pedibus anterioribus pallide flavis; alis fuscis. Long. 7 mm.

Hab. Ceylon (Yerbury).

Head black, the oral region and organs testaceous; a broad furrow leads down from the ocelli and there is a curved one over each antennæ. Antennæ longer than the body, black, the flagellum covered with a close microscopic pile. Thorax bare, shining; the sutures crenulated; a broad curved crenulated depression on the lower part of the mesosternum, which is black for the greater part; the median segment bears large shallow punctures. Legs covered with white hair; the four anterior entirely pallid yellow; the hinder black, the apices of the coxæ and the trochanters pale. Wings longer than the body; fusco-hyaline; the nervures and stigma blackish; the former paler towards the apex. Abdomen shining, base longitudinally striolated; the base with a large distinctly margined (rounded at the apex) space, which is smooth, except for a few scattered punctures; at the end of the metapleura over the apex of the hind coxa is a sharp tooth; the apical segment in the middle ends in two large sharp teeth, the part between them at their base being rounded; at their side is a

shorter tooth about one-fourth of their length; the two proceeding segments end at the sides in large, sharp teeth. The basal segment is pallid fulvous, except for a black band in the middle; the second and third segments black, except the side of the second broadly and a triangular mark on the side of the third; the fourth segment is pallid rufo-fulvous except at the base and the sides; the terminal spines pale fulvous; the others deep black; the basal half of the ventral surface testaceous; the apical blackish.

The above described species comes nearest in form to *S. leucomelæna*, West., as also in its general coloration; but Westwood's species may be known from it by the black thorax.

APANTELES TAPROBANÆ, *sp. nov.*

Niger, pedibus abdominisque subtus rufo-testaceis; alis hyalinis. ♀. Long. 2 mm.

Hab. Trincomali, Ceylon (*Yerbury*).

Antennæ longer than the body; the scape testaceous, the flagellum obscure brownish beneath. Head black; the mandibles and palpi testaceous; the face finely punctured; its centre raised, the raised part becoming gradually wider towards the apex. Thorax above thickly covered with a pale pubescence; the median segment rugosely punctured; the propleuræ, the mesopleuræ in front of the depression, and the sternum finely punctured; the apex of the metapleuræ more closely and coarsely punctured; the legs rufo-testaceous except the base of the fore coxæ and the whole of the hinder coxæ, which are black; the latter coarsely punctured. The stigma fuscous; the nervures pale white, the basal two segments of the abdomen closely punctured; the sides of the second segment narrowly, the others broadly, and the ventral surface rufo-testaceous.

CHALCIDIDÆ.

CHALCIS BENGALENSIS, *sp. nov.* (Pl. 3, f. 9).

Nigra, pedibus anterioribus albis, basi late nigro; coxis trochanteribus femoribusque posticis, rufis; tibiis posticis albis, anticis nigris; tarsis posticis albis; alis hyalinis, nervis nigris; tegulis albis. ♀. Long. 2 mm.

Hab. Barrackpore (*Rothney*).

Antennæ 11-jointed, placed in the middle of the face; black; the scape bare, shining; the flagellum with a pale microscopic pile; the scape not reaching to the hinder ocelli; the antennal depression deep, sharply bordered; at the apex produced roundly in the middle; the vertex rough; the cheeks and clypeus covered thickly with long glistening white hair; the apex rounded at the top, smooth, and shining; the mandibles with the three teeth piceous. Thorax above coarsely punctured; covered sparsely with white hair; the sides and apex of the scutellum thickly covered with long silvery hair; the apex of the scutellum rounded; the median segment with an abruptly oblique slope; strongly reticulated. The lower part of the propleuræ coarsely, the upper part finely punctured; mesopleuræ coarsely punctured; the depression at its base wide, deep, strongly longitudinally striolated; the metapleuræ strongly irregularly reticulated, the reticulations much closer at the base. The four anterior coxæ and trochanters entirely black; the front femora black at the base; the middle black with the apex white; the hind coxæ (except at the base where they are black) trochanters and femora red; the tibiæ white, black in front; the tarsi white except at the apex; the femoral teeth, black, short, stout, closely pressed together at the apex, over a dozen in number.

CHALCIS ECCENTRICA, *sp. nov.*

Long. 5 mm.

Hab. Bombay (*Rothney*).

Very similar in coloration to *C. bengalensis*; but has

the scape of the antennæ reddish beneath; the thorax almost bare, the scutellum wanting the thick mass of white hair at the apex entirely; while the apex looked at from above is seen to be stoutly bidentate; instead of being uniformly rugosely punctured, the punctures are all widely separated, while at the base in the middle there is a large shining impunctate space.

Head rugosely punctured, sparsely covered with white hair; the clypeus shining, impunctate, glabrous, with two elongated punctures on either side of the middle; and there is a shining, impunctate spot above it. Base of mandibles finely longitudinally striated; the centre broadly rufous. Scape of antennæ rufous, darker at the apex; the flagellum stout, thickly covered with short white hair. Pro- and meso-notum with large deep punctures; the scutellum also strongly punctured; the centre at the base with a large smooth, impunctate space, surrounded by large shallow widely separated punctures; its apex ending in large teeth, rounded at the points; the median segment strongly reticulated. Propleuræ at top finely shagreened; its lower part and sides behind irregularly reticulated; the mesopleuræ shining; at the base on the lower side with some large deep punctures, this basal part being separated from the larger posterior by a distinct keel; the metapleuræ coarsely rugosely punctured, and in front thickly covered with long white hairs. Legs: the four anterior coxæ and trochanters, black; the four anterior femora broadly black at the base; the apex white; the tibiæ and tarsi white; the former broadly lined with black at the base; the hind coxæ, trochanters and femora red. The tibiæ and tarsi white, like the anterior, the tibiæ broadly black in the middle; the femora with 10 minute black teeth. Abdomen very smooth and shining; the penultimate segment aciculate, and bearing large deep round punctures.

HALTICELLA ERYTHROPUS, *sp. nov.*

Nigra, pedibus rufis, coxis, tibiis tarsisque posticis nigris; alis hyalinis. Long. 5 mm.

Hab. Agra (Rothney).

Head coarsely punctured; above sparsely covered with silvery hair; the face from the bottom of the eyes on either side of the antennal groove thickly covered with pale golden hair; the sides of the head stoutly margined. Antennæ long, slender, bare, the apex of the second joint rufous. Thorax strongly punctured, the punctures on the mesonotum much finer and closer at the base, and there is a smooth, impunctate spot on the sides. Median segment areolated, the base fringed with long pale golden hair; the basal central area elongated pyriform, transversely striolated. Propleuræ strongly punctured; the mesopleuræ hollowed, bare, stoutly longitudinally striolated; metapleuræ coarsely rugosely punctured, thickly covered with long fulvo-silvery hair. Fore coxæ with the edges on the outer side margined; the hind coxæ very smooth and shining, thickly covered with long silvery hair in front; the femora slightly, the tibiæ and tarsi thickly covered with silvery hair. Abdomen very smooth; the second segment at the top and apex laterally thickly and the other segments more sparsely covered with long silvery hair. Wings hyaline, a faint fuscous cloud under the costa; the nervures fuscous; tegulæ rufo-testaceous.

The parapsidal furrows are obsolete; the apex of the scutellum without teeth; the antennæ are 11-jointed, long, slender; the scape reaches to the ocelli; the hind coxæ have a large stout tooth at the apex. The fore tibiæ may be infuscated, and the hinder rufous behind; the median segment at the sides near the apex projects into a stout, large tooth.

This species agrees best with *Euchalcis* as defined by Kirby (*Journ. Linn. Soc. (Zool.)* xvii., 63).

TEMNATA, *gen. nov.*

Antennæ 12-jointed, situated immediately over the mouth. Face broadly, but not deeply, excavated. Mesonotum without parapsidal furrows. Scutellum at the apex narrowed, and projecting at the sides into two oblique triangular teeth. At the base of the metapleuræ near the hind wings are two stout keels almost united on the outer border and forming a somewhat horseshoe-shaped area; on the side beyond this are two stout spines widely separated. Ovipositor short.

Comes nearest to Kirby's genus *Megalocolus* (*Journ. Linn. Soc. (Zool.)* xvii., 61), which differs from it in having the antennæ inserted in the middle of the face; the hind coxæ have a leaf-like projection on the upperside, and the ovipositor is as long as the abdomen itself.

TEMNATA MACULIPENNIS, *sp. nov.* (Pl. 3, f. 10).

Nigra, argenteo-pilosa; alis fumatis, albo-fasciatis. ♀.
Long. 6 mm.

Hab. Agra (*Rothney*).

Head strongly punctured, very sparsely covered with a microscopic pile, which gives it a greyish appearance. From the middle of the lower side of the cheek a distinct keel runs to the eyes. Pro- and mesonotum closely punctured; the scutellum with the punctuation equally strong, but closer; the apical teeth are not twice longer than wide and rounded at the apex. Median segment with keels all over from the base to the apex; the two central straight, the others more oblique; the sides at the apex thickly covered with long silvery hair. Pro- and metapleura coarsely and uniformly punctured; the mesopleuræ with longitudinal keels rather widely separated; the upper side at the apex rugosely punctured. Legs black, sparsely covered with a silvery pile. Abdomen shining; the apex opaque, shagreened; the fore wings to the base of the

stigma hyaline; there is then a narrow fuscous stripe, followed by a hyaline one extending a little beyond the cubitus; the rest of the wing smoky, lighter at the apex.

PROCTOTRUPIDÆ.

EPYRIS AMATORIUS, *sp. nov.* (Pl. 3, f. 8).

Long. 7 mm. ♂.

Hab. Barrackpore (*Rothney*).

Head strongly punctured, more widely separated behind the ocelli, the clypeus stoutly keeled down the middle, and a curved keel on either side of this united to the central at the base; the mandibles with large punctures; the four basal teeth brownish. Antennæ entirely black; the scape sparsely; the flagellum more closely covered with pale fuscous hair, nearly as long as the thickness of the joints. Pro- and meso-notum thickly covered with long fuscous hairs; the base of the pronotum closely transversely striolated; the rest of it coarsely irregularly rugosely punctured, except at the apex, the smooth apical part being separated by a distinct keel from the rest; the mesonotum with scattered punctures; the parapsidal furrows reaching not quite to the apex; the scutellum almost impunctate. The median segment transversely, more widely at the base, where there is in the centre a somewhat triangular area; the apex is more strongly and closely transversely striolated. Propleuræ shining, smooth; the mesopleuræ covered with large, distinctly separated punctures, except a smooth, elongated, slightly raised space under the wings; the metapleuræ punctured at the top and round the apex; the top at the base with two longitudinal keels, between which are two perpendicular ones. Legs black, the joints testaceous; the femora and tibiæ sparsely, the tarsi more thickly covered with shorter white hair. Wings hyaline, with a very faint fulvous tinge; the stigma black; the

nervures testaceous. Abdomen shining; the apex sparsely covered with long pale hair; at the base is a distinctly bordered longitudinal furrow.

Except the radius, the alar nervures are obsolete.

SCOLIIDÆ.

TIPHIA TARSATA, *sp. nov.*

Nigra, tibiis tarsisque anticis rufis; alis fusco-hyalinis.

♂. Long. 9 mm.

Hab. Missouri (*Rothney*).

Head shining, strongly punctured; the punctures widely separated on the vertex; the front and vertex covered with longish pale hair; the clypeus and lower part of the cheeks thickly covered with long white hair; the base and the apex of the mandibles broadly in the centre, ferruginous. The scape of the antennæ strongly punctured beneath and sparsely covered with long white hair; the flagellum obscure brownish beneath. Pronotum punctured, except at the apex; and rather thickly covered with long pale hairs; the mesonotum with a broad fringe of large punctures round the sides; the scutellum with large punctures all over, which are much closer towards the apex. Median segment alutaceous; with three complete keels down the centre; the apex at the sides shining, smooth. Propleuræ obscurely punctured round the edges; the rest finely obliquely striated; the mesopleuræ strongly punctured; the metapleuræ obliquely, somewhat irregularly striated, the striæ widely separated. Legs thickly covered with white hairs; the fore knees, femora, and tarsi rufous; the tarsi pale; the apex of the middle tibiæ and the middle tarsi testaceous, as are also the apices of the basal two joints and the third joint of the posterior tarsi. Abdomen shining, thickly covered with long white hair, especially towards the apex, where it has a fulvous hue.

TIPHIA MAGRETTII, *sp. nov.*

Nigra, nitida, femoribus posticis rufis; alis fusco-hyalinis.

Long. 10 mm.

Hab. Missouri (*Rothney*).

Black, shining, sparsely covered with longish glistening white hair. Antennæ entirely black; the scape shining, bearing a few large punctures and long white hairs; the flagellum opaque, covered with a dull microscopic pile. Head covered with long glistening white hair and bearing large moderately deep punctures; the mandibles shining, grooved, and broadly red towards the middle. Pro- and meso-notum shining, bearing long white hairs; and widely separated punctures; the scutellum irregularly punctured round the sides and apex; those on the latter being the larger; the apex of the post-scutellum with scattered punctures. Median segment shagreened; the base almost glabrous, with two complete keels in the centre, and having between them one which is only three-fourths of their length; the apex slightly hollowed towards the centre, which has a straight keel; sparsely covered with long white hair. Propleuræ smooth, shining above; the lower part obscurely transversely striated; the mesopleuræ projecting at the base; almost straight, smooth and impunctate; the sides rather strongly punctured, but with the punctures all distinctly separated; sparsely covered with long white hairs; the metapleuræ strongly obliquely punctured. Legs thickly covered with stiff white hairs; the short thick spines on the hind tibiæ and the calcaria pallid testaceous. From the stigma the wings have a decided smoky tinge; and are traversed by four white lines (two above and two below the cubital nervure) like nervures. Abdomen black, shining, and covered, especially towards the apex, with long white hairs; the sides of the basal segments sparsely; the apical more closely and thickly covered with long white

hairs; the last segment more or less piceous; the ventral segments shining, sparsely covered with long white hairs.

This can hardly be *Tiphia rufofemorata* Sm., for the head with "numerous fine punctures," "the apical half of the mandibles ferruginous," the scutellum "strongly punctured" cannot apply to our species; nor is there any mention of the metasternum being striolated. It is very like the well-known European species *Tiphia femorata*; but differs in having the hinder tibiæ black; the apex of the clypeus more sharply projecting and more deeply incised, and the second abdominal segment not depressed and crenulated at the base.

Tiphia femorata is recorded by Magretti from Burmah. (*Ann. Mus. Civ. Genova*, XII. p. 52.)

TIPHIA CASSIOPE, *sp. nov.*

♀. Long. 7 mm.

Hab. Missouri (*Rothney*).

Resembles *T. Magrettii* in coloration, but is smaller and the clypeus is not distinctly projecting and incised in the middle as it is in *T. Magrettii*.

Head shining, sparsely punctured, and bearing some long white hairs behind; the clypeus punctured, transverse, the apex smooth; the apical three-fourths of the mandibles rufous, the extreme apex black. Antennæ black; the apex of the scape piceous; bearing a few large punctures and some longish pale golden hairs. Pro- and meso-notum shining; the former with the basal three-fourths punctured, the punctures being closer together at the base; the sides in the middle and the apex, impunctate; the mesonotum with moderately large punctures in the middle, the sides with a few widely separated punctures; the scutellum punctured at the apex and sides. Median segment shining, slightly shagreened at the base; the three longitudinal keels complete. The lower half of

the propleuræ finely longitudinally striated; the mesopleuræ with scattered punctures and sparsely covered with long white hairs; the metapleuræ finely and closely longitudinally striated. Legs thickly covered with long white hairs, the four hinder trochanters and femora bright rufous; the fore femora and tibiæ underneath more or less dull rufous. Wings hyaline, slightly suffused with fuscous. Abdomen shining, the apex of the first segment with a transverse row of punctures; the apical half of the last segment shining, dull piceous.

The three species here described with red on the legs may be separated as follows:—

- | | |
|--|------------------|
| 1 (4) Femora red, wings smoky. | |
| 2 (3) Clypeus incised, projecting. | <i>Magrettii</i> |
| 3 (2) „ transverse, not projecting. | <i>cassiope</i> |
| 4 (1) Femora black; anterior tibiæ and tarsi rufous. | <i>tarsata</i> |

TIPHIA CLYPEALIS, *sp. nov.*

Nigra, clypeo, tibiis anticis, tarsisque anterioribus, rufis; alis hyalinis, nervis fuscis. ♀. Long. 7 mm.

Hab. Missouri (*Rothney*).

Head shining, punctured; covered with long silvery hairs, which are densest below the antennæ; the clypeus rufous; punctured; the apex smooth, impunctate, and slightly curved; mandibles broadly rufous in the middle. Antennæ ferruginous beneath towards the apex, the last joint entirely so. Pronotum shining, punctured; the mesonotum with the punctures more widely separated; the sides being free from them, and being there too more widely separated than they are on the sides; the scutellum with large, widely separated punctures all over. Median segment coarsely in the middle, the sides much more finely aciculated. Propleuræ finely obliquely striated throughout. Legs thickly covered with white hairs; the

anterior knees, tibiæ, and tarsi, the base and apex of the middle tibiæ and the apices of the hinder tarsal joints, rufous. Radial cellule closed; the second recurrent nervure received in the apical third of the cellule. Basal segment of the abdomen except a belt at the apex, with only a few scattered indistinct punctures; the apices of the others closely punctured; and sparsely covered with long white hairs; the apical ventral segment strongly aciculated, rufous at the apex; there is a distinct curved keel on either side of the penultimate segment.

TIPHIA FUSCINERVIS, *sp. nov.*

Nigra, tarsis anticis rufis; abdominis apice longe fulvo-hirto; alis hyalinis, nervis stigmatæque fuscis. ♀. Long. fere 8 mm.

Hab. Missouri (*Rothney*).

Head densely covered with long fuscous hairs; shining, strongly punctured, the mandibles broadly ferruginous before the apex; the palpi dark testaceous. Antennæ obscure brownish towards the apex, covered with a pale microscopic pile, the scape shining, coarsely punctured on the inner side. Pronotum closely punctured; the mesonotum with the punctures larger and more widely separated; the scutellum with a wide belt of punctures at the apex, a narrower one at the sides and base, and a somewhat broader one down the middle; the post-scutellum finely rugose. Median segment coarsely alutaceous; the keels straight, a little converging towards the apex; an interrupted keel down the middle at the base; the apex with an oblique slope. The lower part of the propleuræ obliquely striolated; the upper part obliquely aciculated; the mesopleuræ strongly punctured. Legs thickly covered with longish white hairs; the calcaria pale luteous. Wings hyaline; the stigma dark piceous; the nervures pale testaceous. The basal seg-

ment of the abdomen very smooth and shining, sparsely punctured in the middle; the third and following segments punctured, thickly covered with long pale fulvous hairs, which are more silvery towards the apex.

TIPHIA INCISA, *sp. nov.*

Nigra, longe argenteo-pilosa; apice clypei incisa; alis hyalinis, nervis fuscis. ♂. Long. 9—10 mm.

Hab. Missouri (*Rothney*).

Head black, thickly covered with cinereous pubescence; rather strongly punctured; the clypeus closely punctured; the apex smooth, roundly incised. Antennæ thick, the scape with a few large punctures and with longish white hairs; the flagellum closely covered with a pale microscopic down. Pronotum closely punctured, the extreme apex only impunctate; the mesonotum strongly punctured but not closely; the scutellum more closely punctured all over, this being also the case with the post scutellum; the median segment short, finely rugose, opaque, the base sparsely, the apex much more densely covered with long white hairs; at the base are two straight keels, with an indistinct one in the centre, the two forming an area nearly as broad as long; the apex has an oblique slope and has an indistinct keel down the centre. Propleuræ aciculated, obscurely striated at the bottom; mesopleuræ punctured; the metapleuræ with about eight semi-oblique keels at the top. Wings hyaline, the nervures and stigma black; the radial cellule closed at the apex. Legs entirely black except the calcaria, which are pale fulvous; the tarsi with a fulvous pubescence beneath. Abdomen covered with longish white hairs; the basal segment with widely separated punctures all over, its apex depressed; the apical more closely and strongly punctured than the middle segments.

TIPHIA IMPLICATA, *sp. nov.*

Long. 9 mm.

Hab. Missouri (*Rothney*).

Head densely covered all over with long white hair; opaque, the clypeus largely produced and projecting; the sides oblique, the apex transverse; the mandibles entirely black, covered with long white hairs; the base punctured. Pro- and meso-notum closely punctured all over; the latter more strongly than the former, and more sparsely towards the middle; the scutellum punctured all over like the mesonotum; the post-scutellum closely finely rugosely punctured. The median segment finely rugosely punctured, towards the apical keel irregularly striolated; the two outer keels curving inwardly; the central straight, not reaching quite to the apex. The apex of the segment sharply oblique. Propleuræ strongly transversely striolated, except at the extreme apex, which is shining and impunctate; the mesopleura alutaceous; the metapleura depressed at the base, closely longitudinally striolated. Legs black, thickly covered with long pale hairs, the hairs on the underside of the tarsi pale golden; the calcaria and the tibial and tarsal spines pale fulvous. The wings hyaline, infuscated towards the apex; the radial cellule is not appendiculated; the second recurrent nervure is received shortly beyond the middle of the cellule. Abdomen shining, impunctate at the base, more opaque and thickly haired towards the apex; the basal segment above with a long shallow depression; the ventral segments sparsely covered with long pale hairs.

TIPHIA ERYTHROCERA, *sp. nov.*

Nigra, mandibulis, tibiis, tarsis anticis, flagelloque antenarum rufis; alis hyalinis. ♀. Long. 8 mm.

Hab. Missouri (*Rothney*).

Antennæ rufous, covered with a pale microscopic pile;

the base of the scape black; covered with long golden hairs on the underside. Head shining, sparsely haired; covered with large distinctly separated punctures; the mandibles ferruginous; sparsely covered on the lower side with long golden hairs; the teeth are black. Pro- and meso-notum with scattered punctures except at the apices; the scutellum with a few punctures at the apex. Median segment alutaceous; the three keels complete. Propleuræ alutaceous, smooth and shining above; the mesopleuræ punctured, alutaceous at the top; the metapleuræ striolated throughout, much more finely at the base. Legs thickly covered with white hairs; the tibial spines pale; the four anterior tarsi; the front tibiæ behind and the middle tibiæ entirely ferruginous; the hinder tarsi ferruginous; the calcaria and tarsal spines pale fulvous. Wings hyaline, suffused with fuscous; the nervures fuscous; the stigma black; the second recurrent nervure received in the apical third of the cellule. Abdomen shining, sparsely covered with long white hairs; the transverse depression on the apex of the petiole closely and coarsely punctured at the sides, more widely and sparsely at the middle; the puncturing on the dorsal segments becomes closer and coarser towards the apical; the last shining, impunctate, piceous broadly at the apex.

METHOCA.

Smith described two Indian species of *Methoca*, under the same name—*orientalis*—(Cat. Hym. III., 66) from Northern India and another, renamed *Smithii* by Magretti (*Ann. Mus. Civ. Genova*, xxxii., p. 259), taken by Mr. Rothney at Barrackpore (*Trans. Ent. Soc.*, 1875, p. 35). Both were described from males; and represent, so far as can be judged from the descriptions, different species. The undernoted female is, I should say, quite distinct from either.

METHOCA BICOLOR, *sp. nov.* (Pl. 4, f. 12).

Nigra, nitida, thorace basique abdominis rufis. ♀. Long. 5 mm.

Hab. Barrackpore (*Rothney*).

Antennæ stout, the four basal joints of the antennæ rufous, sparsely covered with white hairs, becoming slightly and very gradually thickened towards the apex. Head shining, impunctate. Thorax shining, impunctate, except at the base of the scutellar region where it is transversely striated; the mesonotum at the sides of the scutellum is also somewhat obliquely strongly striated. The basal segment of the abdomen is rufous, except at the extreme apex; the other segments shining, impunctate; the apical segment obscure rufous. Legs black, the tarsi obscure testaceous, the femora sparsely haired; the tibiæ covered with stiff hairs.

METHOCA RUGOSA, *sp. nov.* (Pl. 4, f. 11).

Nigra, basi flagello antennarum late, femoribus tarsisque anticis rufis; alis violaceis, basi hyalinis. ♂. Long. 15 mm.

Hab. Ceylon.

Antennæ stout, almost bare, the basal three joints and the base of the fourth rufous. Head black; the mandibles broadly rufous in the centre; the front strongly punctured, almost reticulated, thickly covered with fuscous hairs; the vertex more shining, less pilose; the punctures shallower and more widely separated, especially at the side of the ocelli. Thorax black, the pronotum, except a smooth, impunctate band at the apex, coarsely transversely striolated; the mesonotum much more strongly and irregularly transversely striolated; scutellum strongly irregularly reticulated; the sides towards the apex impunctate; in the centre of the metanotum is a pear-shaped area, with four stout transverse keels, the two central being the longest; at the side of this are stout

semi-longitudinal keels; the apex at the top is stoutly margined; at the top is a triangular area, the sides with stout oblique keels, meeting in the centre; the pleura coarsely irregularly reticulated, the sternum irregularly transversely striolated; its side stoutly keeled with a sharp margin at the edge, the pleura at the side of this being hollowed; the sternum widely hollowed, the hollow becoming gradually wider towards the apex. Abdomen shining, impunctate; the base stoutly longitudinally striated; the basal ventral segment strongly reticulated; keeled down the middle to near the apex; the other segments with punctures at the apex, these being fewer on the middle and more numerous on the apical segments.

MUTILLIDÆ.

Since my paper on the Indian Mutillidæ (*Manchester Memoirs*, V., 1892) was published, some additional species have come into my possession from Mr. Rothney and from Col. Yerbury. The collection from the last-named gentleman is of especial value, as it enables us to unite the sexes of a few species.

The discovery by Mr. Rothney of an apterous ♂ *Mutilla*, although not unique, is of interest. It is remarkable that the four known apterous species of ♂ *Mutilla* have the thorax emarginate, as it often is with ♀ *Mutillæ*, while it never is so in the winged males.

a. Males. *Wingless, thorax incised.*

MUTILLA ÆDIPUS, *sp. nov.* (Pl. 4, f. 13. ♂.)

Ferruginea, aptera, abdomine nigro, albo maculato; pedibus nigris; thorace late inciso. ♂. Long. fere 9 mm.

Hab. Barrackpore (*Rothney*).

Head large, wider than the thorax, the part behind the eyes more than twice their length; coarsely punctured, closely covered with white pubescence; black, ferruginous

from shortly above the antennal tubercles to the top of the eyes; the black above the outer side of the eyes being oblique. Antennæ entirely black; the scape thickly covered with stiff white pubescence, the black part of the head densely covered with glistening white pubescence; the vertex and occiput with the pubescence longer, darker, and more erect. Thorax not twice the length of the head; gradually narrowed to the metathorax, which bulges out, so that it is as wide as the prothorax. Above, the thorax is coarsely rugose and covered with long fuscous hairs; the apex of the median segment is oblique and has a sharp spine in the centre. The pleuræ are shining, impunctate; covered with white pubescence; black; the upper part of the pro-, the upper third of the meso-, and the meta-pleuræ above the oblique furrow, rufous. The sides of the median segment with three large and one short spine. The legs black; covered densely with white hairs; the tibiæ almost spineless. The abdomen longer than the head and thorax united, velvety black, covered with long black hairs; a square spot on the centre of the first segment; three large oval ones at the apex of the second; a small one in the centre of the third, a larger one in the centre of the fourth, both narrowed and rounded at the base; and the greater part of the fifth, white. Ventral segments black; the second strongly punctured, sparsely covered with white hairs; the others are fringed with long pale hair.

The genital armature is normal.

b. Winged, thorax not incised.

Fore wings with only one recurrent nervure; three transverse cubital nervures; stigma elongate; apex of abdomen bispinose, middle tibiæ with two spines. Petiole serrate beneath, elongate, nodose at apex. Eyes very large, oval, entire; ocelli large.

The precise generic position of this species must stand over for further study in connection with its unknown ♀. It is very closely related to the *Photopsis* section of the American genus *Sphærophthalma*. In general form and appearance it is very like *Mutilla obliterated* Sm., which is, however, abundantly distinct otherwise. It differs from *Mutilla* proper in the eyes being entire in the ♂.

MUTILLA APICIPENNIS, *sp. nov.*

Thorace capiteque ferrugineis; abdomine nigro, basi ferrugineo; pedibus pallide testaceis; alis hyalinis, apice fumatis.
♂. Long. 10 mm.

Hab. Trincomali (Yerbury).

Head as wide as the thorax, shining, glabrous; the mandibles with long fulvous hairs; their teeth deep black; a slight depression on the front above the antennæ; the eyes and ocelli large; the head behind the eyes not half their length. Antennæ thick, uniformly fulvous, covered with a close white pubescence. Thorax uniformly fulvous, shining; the mesonotum obscurely punctured; the scutellum rugosely punctured; the median segment with a gradually rounded slope; reticulated uniformly, sparsely covered with long white hairs. Pro- and meso-pleuræ rugosely punctured; the edges of the former crenulated; the metapleuræ reticulated. Legs pale testaceous, covered with long pale hairs; the hinder femora broadly infuscated towards the apex. Petiole elongated, gradually dilated, and strongly punctured, especially towards the apex; where there is a black band; beneath it is hollow, shining, the edges rough, the other segments shining, their apices obscure testaceous; covered with long pale hairs. The wings, which do not reach to the apex of the abdomen, are milk-white. The nervures pale testaceous. The apex from the third transverse cubital nervure smoky; the two basal transverse cubital nervures curved; the third sharply

angled; the first recurrent nervure received in the basal third of the cellule; the second completely obliterated.

The ocelli are larger than usual; the second abdominal segment unarmed beneath. On the mesonotum the two parapsidal furrows are complete; the last dorsal abdominal segment rufous and punctured at the apex.

In appearance this species resembles the American genus *Photopsis*. It is apparently closely related to *M. pedunculata* from Arabia and Egypt.

A. Descriptions of species known in both sexes.

The following species belongs to a group the species of which, being so similarly coloured, are very difficult to identify; and I should not have ventured to describe it if I had not got both sexes.

MUTILLA ACIDALIA, *sp. nov.*

♀. Black, thorax above ferruginous. Head as wide as the thorax, coarsely punctured; the head behind the eyes developed a little less than the length of these latter; covered with a short, sparse, white pubescence. Antennæ stout, covered with a white down; the basal joint reddish at the apex. Thorax above, coarsely punctured, sparsely covered with fuscous hairs; the median segment with an abrupt slope, coarsely punctured, covered with long white hairs. Abdomen not much longer than the head and thorax united; black; sparsely covered with long fuscous hairs; the hypopygium rather strongly longitudinally striated; on the second segment are two oval, on the third and fourth segments two square marks of silvery pubescence; the basal ventral segment is ferruginous; the others obscure testaceous at their apices; and marked with long white hairs. Legs black, the tibiæ and tarsi with white hairs; the tibial spines stout, fuscous; the calcaria pale.

♂. Head and thorax black, the former in front and the pronotum thickly covered with long white silvery hairs; abdomen ferruginous, except the apical segment, which is black above and beneath; wings fuscous, paler at the base. Antennæ elongate, slender, tapering towards the apex; the scape grooved laterally, sparsely covered with long white hair; the flagellum covered with a sparse down; the third joint nearly twice the length of the fourth. Head not much narrower than the thorax; behind the eyes it is a little longer than their width; the front and vertex strongly punctured. Prothorax strongly punctured, the pronotum thickly covered with grey pubescence; the mesonotum strongly punctured, the punctures deep and clearly separated; down the sides run two deep furrows; the median segment with a somewhat abrupt rounded slope; reticulated; in the centre is an elongated area reaching from the base to shortly beyond the middle, the base being dilated. Propleuræ obliquely striolated, smooth behind; the mesopleuræ coriaceous, projecting in the middle, where they are thickly covered with long white hairs. Legs covered with longish white hairs; the calcaria pale. Radial cellule elongate; the basal abscissa of the radius sharply oblique, the apical more rounded; the first transverse cubital nervure oblique; the second broadly and roundly curved; the third sharply angled above the middle; both the recurrent nervures are received shortly beyond the middle. Keel on basal ventral segment stout, black.

MUTILLA OPULENTA, Smith.

The ♀ of this species is probably *M. soror*, Sauss. (*Ann. Soc. Ent. Fr.*, vii., 1867, 354, t. 8, f. 3.) As Smith's name is the older one, it will have to be adopted should *soror* prove to be a variety.

Col. Yerbury has taken the sexes together. The ♀ however has the thorax black, while in the typical *M. soror*

it is reddish; but in other respects the two agree, except that the hinder femora have more black. It may, however, be as well to give a description of the ♀ *M. opulenta* in case *M. soror* may be different.

Head as wide as the thorax; red, coarsely and rugosely punctured, shining, bare, behind the eyes the vertex almost as long as the width of the eyes. Scape of the antennæ rufous, darker at the apex and beneath, and bearing large punctures; the flagellum black, thickly covered with fuscous pile. Thorax black, twice the length of the head; the sides almost parallel, not dilated towards the apex, very coarsely rugosely punctured; the apex of the median segment with a very slight oblique slope; above coarsely punctured, the rest finely and uniformly rugose; the lower part covered with long golden hairs. The pleuræ smooth; the base of the pronotum and the metapleuræ coarsely punctured; the lower portion of the metapleuræ thickly covered with pale golden pubescence. Petiole black, the apex (probably the whole in fresh examples) fringed with golden hairs; on the base of the second segment are two large oval golden marks; its apex has a golden band, broadly narrowed in the centre; the third segment is entirely golden; the pygidium coriaceous, fringed at the sides with long golden hairs. The second ventral segment has large, somewhat shallow, clearly separated punctures; all the segments fringed with long golden hairs. The front four legs red, the knees black, sparsely covered with golden hairs, especially the tarsi; the apical three-fourths of the hind femora are black; the tibiæ and tarsi thickly covered with golden hair.

The form of the spots on the second abdominal segment varies. In one example on the inner side at the apex they are rounded; in another they are there truncated as figured by Saussure in his *M. humbertiana*; in another they are more as he figures them in *M. soror*, but the

band on the fourth segment is as in *M. humbertiana*; in *M. soror* it is figured as straight at the base. *M. insularis* Cam., may be known from it by the thorax being red; by the metapleuræ not being coarsely punctured throughout, only at the extreme apex, the band on the third segment complete, not incised at the base.

MUTILLA PERELEGANS, *sp. nov.*

This is the supposed variety of *M. pulchrina* figured by me (*Manchester Memoirs*, V., 1892, pl. I, f. 6), but which I now regard as quite distinct; and, thanks to Col. Yerbury, I am enabled to describe the male, as well as the female, in detail.

♀. Head very slightly narrower than the thorax; stoutly keeled on the sides behind, ferruginous, coarsely rugosely punctured; covered sparsely with longish black hairs; almost transverse behind, where it is developed the length of the eyes. Mandibles black. Scape of the antennæ deep black, shining, glabrous; the flagellum thick; the third joint twice the length of the fourth; brownish beneath. Thorax a little narrowed from the middle to the apex; above coarsely rugosely punctured, the punctures elongated; sparsely covered with long black hairs, but very thickly on the pronotum, while the median segment is thickly covered with long pale golden hairs, and has a somewhat oblique slope. Pro- and meso-pleura shining, impunctate; except a broad punctured projection down the mesopleuræ, the projection itself being covered with long pale golden hairs; and, above, it forms a projecting tooth, behind which is another slightly larger and rounder one. Legs black; the femora slightly, the tibiæ and tarsi thickly covered with long golden hairs. Abdomen longer than head and thorax together; black; an orange-coloured mark of hairs, broader than long and with the sides rounded, in the centre of the second seg-

ment; the sides of the second segment above broadly fringed with pale golden hairs; the third segment entirely covered with golden hairs; the rest of the abdomen with black stiff hairs; the third and fourth ventral segments covered with golden hairs; the fifth and sixth slightly fringed with golden hairs; the apical segment with a dense tuft of golden hairs at the end.

Length, 12 mm.

♂ much larger (17 mm.) has the head and thorax red; the abdomen with the apex of the third and the fourth, and the fifth segments entirely covered with golden pubescence. Head distinctly narrower than the thorax, coarsely rugosely punctured; sparsely covered with long black hair; below the antennæ the hairs are longer and fulvous; behind rounded at the sides, about one half the length of the eyes; the apical half of the mandibles black. Antennæ short, thick; but tapering very considerably towards the apex; the basal two joints red; the rest black and almost bare; the scape with a few long hairs; and strongly punctured above. Pro- and meso-notum coarsely rugosely punctured; thickly covered with long black hairs; scutellum flat, the sides and apex projecting; covered with long black hairs, except at the apex, where they are longer and pale fulvous in colour; this being also the case with the post-scutellum. Median segment strongly reticulated; the apex roundly emarginate; the sides projecting into stout teeth. Pro- and meso-pleuræ coarsely rugosely punctured except the lower part of the former. The fore legs are reddish like the thorax; the four hinder legs are entirely black, except the coxæ at the base; they have the femora slightly, the tibiæ and tarsi densely covered with long pale golden hairs. Wings fusco-violaceous; the base much lighter, almost hyaline; the basal and apical abscissæ of the radius are oblique and, at the base of the latter, it projects a little; the first

and second transverse cubital nervures are curved; the third is obliterated entirely, while the cubital nervure itself terminates at the second transverse cubital. The abdomen has the basal two segments strongly punctured; golden band on the apex of the second segment is interrupted in the middle; the basal ventral segment is more or less rufous, and projects at the apex into a sharp, triangular plate; at the base in the middle it is semi-circularly incised.

B. Species described from males only.

a. Fore wings with only two transverse cubital nervures.

MUTILLA PERVERSA, *sp. nov.*

Nigra, thorace rufo, sterno nigro; alis subfumatis, nervis fuscis. ♂. Long. 5 mm.

Hab. Barrackpore (*Rothney*).

Head black, shining, sparsely covered with longish pale hairs. Vertex behind the eyes equal to their length, and not much narrowed; the mandibles dark piceous, the teeth black; the palpi fuscous. The antennal scape not furrowed beneath, sparsely haired; the flagellum stout, covered with a microscopic down. Thorax above entirely obscure ferruginous, punctured, but not strongly; sparsely covered with long white hairs; the median segment with a gradually rounded slope. Propleuræ almost black; the mesopleuræ obscurely punctured in front; the metapleuræ impunctate at the base; the apex strongly reticulated. Legs covered with long soft hairs; the calcaria white. Alar nervures fuscous; the first abscissa of the radius oblique; the apical small, almost straight; the first transverse cubital nervure straight, oblique; the second curved and largely bullated at the bottom; the first recurrent nervure is received shortly beyond the middle of the cellule. Abdomen shining, almost impunctate covered, especially towards the apex, with long soft

white hairs. The basal abdominal segment without a keel sharply separated from the second, which is gradually raised to the obliquely depressed apex, thus leaving a sharp depression between the two.

b. Fore wings normal, with three transverse cubital nervures.

MUTILLA INDEFENSA, *sp. nov.*

Nigra, vertice fulvo-hirta; collare late abdomineque ferrugineis; abdominis basi apiceque nigris; alis fuliginosis. ♂.
Long. 17 mm.

Hab. Bombay District (*Wroughton*).

Head a little narrower than the thorax; the vertex and front densely covered with fulvous pubescence, intermixed with long fuscous hair; the clypeus sharply keeled in the middle; the mandibles entirely black, fringed with long golden hairs. Antennæ entirely black, the scape widely grooved; sparsely covered with long fuscous hairs. The head behind the eyes is rapidly narrowed, and is not half the length of the eyes. The pronotum is broadly covered with thick orange pubescence; the pleuræ at the base coarsely punctured; the rest is longitudinally striolated. Mesonotum coarsely punctured especially towards the apex; there are two moderately wide longitudinal furrows. Scutellum pyramidal; coarsely rugosely punctured; and, like the mesonotum, thickly covered with long black hairs. Median segment coarsely reticulated; its base thickly covered with golden hairs; the centre with an elongated area reaching to the edge of the slope, which is oblique. Mesopleuræ coarsely punctured, covered with silvery pubescence; the apex impunctate; the base of the metapleuræ impunctate; the apex coarsely reticulated. Legs black; the calcaria white; the femora, tibiæ, and tarsi thickly covered with long white hairs. Wings fusco-violaceous, paler at the base; the basal abscissa of the

radius oblique and twice the length of the apical; the second cubital cellule elongate, its lower side twice the length of the third; the first recurrent nervure is received shortly beyond the middle; the second in the apical third of the cellule. Abdomen thickly covered with long rufous hairs; the petiole black; the sides with large deep punctures; the keel blunt; the second segment indistinctly punctured; the last two segments black; the apices of the others fringed with long orange hairs; the last segment is more strongly punctured; and is stoutly keeled at the sides.

MUTILLA DILECTA, *sp. nov.*

Nigra, thorace rufo, mesopleuris nigris; alis fuscohyalinis. ♂. Long. 8 mm.

Hab. Barrackpore (Rothney).

Head black, coarsely punctured, covered densely with white pubescence and more sparsely with long fuscous hairs; a furrow leads down to the antennæ; head rounded and narrowed behind the eyes, the vertex less than half the length of the eyes; an indistinct furrow at the sides of the ocelli; mandibles entirely black; palpi pale. Antennæ stout, the flagellum covered with pale down; the scape sparsely haired. Prothorax large, red, except a somewhat triangular black mark on the lower part of the propleuræ; in front it is transverse; the sides above straight, very slightly widened and straight towards the tegulæ. Mesonotum coarsely punctured, as also the scutellum; the median segment strongly reticulated; the reticulations large and all well defined, the central reticulation at the base being the largest, with the sides straight, and the apex triangular. The apex of the median segment is obliquely truncated. The propleuræ are coarsely longitudinally striolated; the mesopleuræ somewhat strongly punctured except at the base and the apex, the latter

being excavated, smooth, shining; and impunctate; the metapleuræ coarsely reticulated. The basal abdominal segment is a little longer than broad, strongly punctured, bearing long pale fuscous hairs, and, at the apex, pale golden hairs; the second segment is not quite so strongly punctured as the apex of the first; the other segments are less strongly, but more closely, punctured, than the second; the apical is more strongly punctured than the penultimate. The basal ventral segment is keeled down the middle. Legs entirely black, and covered with white hairs; the calcaria pale. Tegulæ densely covered with long white hairs. The basal abscissa of the radius straight, oblique; the apical roundly curved; the first recurrent nervure received in the middle; the second in the apical fourth of the cellule. The nervures are dark fuscous.

MUTILLA DISCRETA, *sp. nov.*

Nigra, longe argenteo-pilosa; alis fusco-violaceis. ♂.
Long. fere 9 mm.

Hab. Barrackpore (*Rothney*).

Head densely covered with silvery pubescence; that between the ocelli and the antennæ completely hiding the texture; that on the vertex intermixed with long grey hair; vertex behind the eyes rounded and narrowed a little more than the length of the eyes. Antennal tubercles acute, piceous; the middle of the mandibles piceous. Antennæ black, the flagellum with a short pile; the scape with long hairs, and apparently more deeply excavated beneath than usual. Sides of the pronotum rounded, closely punctured and covered with long pale hairs. Mesonotum bearing large, round, deep punctures, the scutellum also with large deep punctures; at its base is a wide deep distinct furrow, behind which is a longer narrower one. The median segment has a gradually rounded slope, and is strongly reticulated.

Pleuræ strongly punctured; the apex of the propleuræ strongly crenulated; the base and apex of the mesopleuræ excavated, shining, impunctate, except on the lower part; the propleuræ reticulated, except at the base. The base of the abdomen excavated, projecting at the sides; the other segments punctured, but the punctation becoming weaker towards the apex; all the segments fringed with long white hairs. The keel on the basal ventral segment stout, a little curved, and a little projecting at the apex; the second segment has the punctures large and deep; the others have the base impunctate; the apex closely punctured, and with the oblique lateral furrows distinct; the apical half of the hypopygium roundly depressed. Legs densely covered with white hairs. The first transverse cubital nervure curved and bent at the lower third; the second sharply elbowed a little above the middle; both the recurrent nervures are received shortly beyond the middle of the cellule.

MUTILLA RUFODORSATA, *sp. nov.*

Nigra, dense argenteo-hirta; mesonoto rufo; abdomine nigro-cæruleo; alis fusco-violaceis. ♂. Long. 13 mm.

Hab. Agra (*Rothney*).

Head narrower than the thorax, rugosely punctured, densely covered with silvery hairs all over; the mandibles before the tips piceous. Antennæ entirely black; the basal two joints covered thickly with silvery hairs; the flagellum with an indistinct down. Thorax densely covered with silvery hairs all over, black; the mesonotum and basal half of scutellum rufous. Pronotum and mesonotum coarsely punctured, almost reticulated; the scutellum very coarsely irregularly reticulated; the apex of the median segment has a sharp oblique slope; coarsely reticulated; the base thickly covered with silvery pubescence. The pleuræ coarsely punctured, except the base

and apex of the mesopleuræ; the metapleuræ coarsely reticulated. The legs are thickly covered with white hair. The basal two segments of the abdomen above are somewhat strongly punctured; the punctations becoming weaker towards their apices; all the segments at their apices are fringed with silvery hairs. The apical dorsal segment terminates in the middle in a triangular depression, with raised stout lateral keels, and with a central keel not half the width of the lateral ones. The second ventral segment is coarsely punctured; the sides at the base depressed, and with an indistinct keel between; the keel on the basal segment broad; the basal part the longest. Tegulæ large, rather strongly punctured. The wings are strongly fusco-violaceous, more lightly coloured at the base; the basal abscissa of the radius sharply oblique, the apical curved; the first transverse cubital nervure oblique, the second almost straight; the third sharply angled in the middle; the first recurrent nervure is received shortly before, the second at a slightly greater distance beyond the middle of the cellule.

MUTILLA PROVIDA, *sp. nov.*

Nigra, pro-meso-thorace mesonotoque rufis; alis fere fumatis. ♂. Long. fere 7 mm.

Hab. Bombay Presidency (*Wroughton*).

Comes very near to *M. dilecta*; but is easily known from it by the black scutellum and metathorax.

Head as wide as the mesothorax; entirely black, except the antennal tubercles, which are rufous; densely covered all over with long soft white hairs; rounded behind, where it is as long as the eyes; the palpi fuscous; the mandibles before the teeth rufous. Antennæ black; the scape with some white hairs; the flagellum with a fuscous down. Pro- and mesothorax coarsely punctured, covered with long white hairs; ferruginous,

except the lower part of the propleuræ and the prosternum. Scutellum black; covered with long white hairs; the base and centre of the median segments with large, the sides with smaller reticulations, and having a gradually rounded slope. The propleuræ are coarsely punctured, almost reticulated; the mesopleuræ coarsely punctured and densely covered with long white hair; the upper part of the metapleuræ reticulated, the lower smooth. Legs black, densely covered with long white soft hairs; the calcaria pale. The alar nervures testaceous, slightly darker at the base; radial cellule wide; the basal abscissa of the radius oblique, straight, shorter than the apical which is curved, almost angled in the middle; the first transverse cubital nervure is oblique, slightly curved; the second is curved and bullated beneath hardly oblique; the third is sharply angled in the middle; the first recurrent nervure is received in the middle, the second in the apical third of the wing. Abdomen at the base rather strongly punctured, towards the apex, the punctation becomes weaker; covered, especially at the apices of the segments, with long white hairs. The basal abdominal segment coarsely punctured; the central keel, moderately strongly developed and hardly raised at the apex; the second segment strongly, the others much more weakly punctured; their apices fringed with long white hairs; the apical segment entire, not depressed, punctured throughout.

C. Species described from females only.

MUTILLA LUXURIOSA, *sp. nov.*

Nigra, thorace supra obscure ferrugineo; abdomine albosexmaculato. ♀. Long. 7—8 mm.

Hab. Ceylon (*Yerbury*).

Head not broader than the thorax; black; the mandibles in the middle, clypeus and the antennal tubercles

rufous; coarsely punctured, covered with longish and white and fuscous hairs; behind the eyes less than their length; narrowed and rounded. Antennal scape covered with long pale hairs, not grooved; the flagellum obscure fuscous beneath; covered with an indistinct microscopic down; the third joint nearly twice the length of the fourth. Mandibles grooved on the outer side. Thorax a very little dilated gradually towards the apex; the pronotum coarsely shagreened; mesonotum coarsely rugosely punctured; median segment at the apex with an abruptly oblique slope; the propleuræ obscurely, the metapleuræ coarsely rugosely reticulated, its outer edge spinose; the mesopleuræ shining, a little excavated, smooth, shining, and glabrous. Legs thickly haired; the spines thick, pale and black on the tibiæ, rufous on the tarsi. Basal abdominal segment gradually dilated towards the apex, not distinctly separated from the second; on the latter are two oval whitish fulvous marks near the base; the third and fourth have two marks of the same colour; those on the latter the smaller; the apical is fringed laterally with pale long hairs, and is closely aciculated or shagreened. The basal ventral segment is obscure rufous; the keel in the middle has a longer and a shorter blunt tooth; the second segment has widely scattered punctures; the others are finely transversely striated at the base; the apex with scattered punctures and covered with long pale fulvous hairs.

Resembles closely *M. aulica* Sm., in coloration, but wants the large spot of silvery pubescence on the vertex, and otherwise is easily known from *M. aulica* by having the pronotum at the base transverse, with the sides acute; while *M. aulica* has the sides broadly narrowed and the base not transverse. In one of my examples of *M. aulica* there are only four white spots on the abdomen.

MUTILLA REMOTA, *sp. nov.*

Long. 15 mm. ♀.

Hab. Trincomali (*Yerbury*).

Comes very near to *M. egregia* Sauss., in the coloration of the abdomen and in the sides of the thorax having a stout spine; but differs in having the head and thorax entirely black, not red.

Head narrower than the thorax, deep black, coarsely rugosely punctured, thickly covered with long black, intermixed on the front with shorter golden hairs; the orbits on the outer side narrowly rufous. Antennal scape rufous, covered with long golden hairs. Thorax at the base narrower than the head, becoming gradually wider to the spines, then becoming rather abruptly narrower to the apex; coarsely rugosely punctured, sparsely covered with long black hairs; the apex of the median segment with an abrupt oblique slope; coarsely rugosely punctured; the hairs long; on the upper part black, on the lower golden. The pro- and meso-pleuræ rugosely punctured; the latter projecting in the middle and ending at the top in a stout rufous spine; the space beyond the spine a little hollowed and finely transversely striated; the metapleuræ entirely rugosely punctured. The legs black; the tibiæ rufous; the femora covered with long black hairs; the tibiæ and tarsi more thickly with long golden hairs. The petiole narrow at the base, gradually dilated to the apex; thickly covered with long golden fulvous hairs, broadly at the apex, narrowly at the base; the intermediate space covered with long black hairs. Second segment coarsely punctured; covered with short black hairs; the apex with a belt of golden pubescence; the fourth segment covered with golden pubescence; the other segments covered with long black hairs. The basal two ventral segments covered with fuscous; the third and fourth covered with golden pubescence.

MUTILLA MANDERSI, *sp. nov.*

Nigra, thorace rufo; abdomine fulvo-sexmaculato; basi femorum late rufo. ♀. Long. 17 mm.

Hab. Shan States (*Manders*).

Comes very close to *M. fumaria*, but differs from it in its longer and, as compared with the head, somewhat narrower thorax, which is further entirely rufous, besides being less strongly punctured; and by the legs being broadly rufous at the base. It comes near also to *M. sexmaculata*, but that has the thorax more thickened towards the apex, with its sides entirely black, while the marks on the abdomen are much more elongated on the second segment.

Head as wide as the thorax, black, coarsely rugosely punctured, covered with fuscous and golden hairs; behind the eyes it is rounded, and is there somewhat shorter than the length of the eyes; the mandibles are rufous in the middle. Scape of the antennæ covered sparsely with long silvery hairs; the flagellum with an obscure down; the third joint twice the length of the fourth. Palpi black. Thorax more than twice the length of the head; the sides almost straight; hardly dilated towards the apex; above closely and strongly punctured; covered with longish fuscous hairs; the apex with a semi-abrupt slope, rounded at the top; the pleuræ smooth, shining, beneath covered with a silvery down; the base and apex obscurely punctured. Abdomen with the basal three segments as long as the head and thorax united; the top covered thickly with black; the sides and ventral surface more sparsely with longer silvery hairs; velvety; the basal segment gradually dilated towards the apex; the two marks on the second segment are oval, large; on the third they are more than twice broader than long; on the fourth they are not much longer than broad; there are none on the fifth; the pygidium is densely covered at the sides with long fulvo-

aureous hairs. The basal ventral segment is coarsely punctured, and has in the middle a projection, which rises a little towards the apex, which is a very little curved; the second segment has distinctly separated punctures; the others are finely and closely punctured on the apical half and thickly clothed with long pale fulvous hairs. The legs are moderately pilose; the tibial spines fulvous or pale; the fore femora are rufous at the sides and beneath in the middle; the two hinder pairs rufous, except at the base and apex, where they are black.

In size and form it comes near to *M. sex-maculata*, but may be known from it by the thorax being entirely red; and by the third and fourth abdominal segments having interrupted white bands instead of spots; the marks on the second segment, too, being oval and not elongate.

MUTILLA VALIDA, *sp. nov.*

Nigra, thorace supra rufo, abdomine albo-bimaculato, basi longe fulvo-hirto. ♀. Long. 8 mm.

Hab. Barrackpore (*Rothney*).

Head slightly wider than the thorax; thickly covered with long, the sides more thickly with silvery pubescence; behind the eyes it is developed twice the length of the eyes. Scape covered with long white hairs; the flagellum with fuscous down. Thorax about one half longer than the head, its sides straight; the pronotum and the apical three-fourths of the median segment black; the rest reddish; strongly punctured, almost reticulated; the apex with an oblique slope; slightly hollowed, smooth; the pro- and meta-pleuræ coarsely reticulated, the mesopleuræ impunctate, smooth; the lower part thickly covered with white hairs. The basal segment of the abdomen smooth, obscurely shagreened, the apex with a broad, thick band of rich fulvous hair; the second segment with two oval marks of pale fulvous hairs; the apex with a broad

fulvous belt of thick hairs; the third covered with thick hair, laterally pale, in the middle rufo-fulvous; the other segments fringed with pale fulvous hair. Ventral segments sparsely covered with pale hairs; the second strongly punctured.

MUTILLA HUMILIS, *sp. nov.*

Nigra; capite et thorace rufis; abdomine argenteo 4-maculato; pedibus anticis obscure rufis. ♀. Long. 4 mm.

Hab. Barrackpore (*Rothney*).

Head wider than the thorax, rufous; the orbits broadly black; the vertex and front obscurely longitudinally striolated; the oral region and the palpi testaceous; the mandibles piceous before the apex. Thorax above ferruginous, the sides all round the top, bordered with black and irregularly longitudinally striolated; the edges irregular, rough; with a few teeth which are more numerous on the sides of the median segment, which has a gradually rounded slope, and has at the top a large tooth. Pleuræ shining, impunctate, glabrous. Legs black; the anterior tibiæ and tarsi obscure rufo-testaceous. Abdomen black, sparsely covered with long black hairs; on basal segment is a square of silvery pubescence; on the apex of the second segment are three oval silvery marks; the other segments are marked with silvery pubescence in the middle.

MUTILLA LAETA, *sp. nov.*

Nigra, thorace supra rufo; abdomine argenteo 4-maculato. ♀. Long. 9 mm.

Hab. Barrackpore (*Rothney*).

Head hardly wider than the thorax, very coarsely rugosely punctured, covered with long glistening hair; a rufous mark in the centre of the vertex. Scape of the antennæ covered with long glistening hairs; the flagellum with a distinct down; the thorax is not quite twice the

length of the head; the sides looked at from above are straight; but the mesopleuræ are slightly excavated; above coarsely uniformly punctured; the propleuræ entirely black, coarsely punctured; the mesopleuræ smooth shining, separated from the propleuræ by a keel; black, rufous above, the lower part densely covered with silvery pubescence; the metapleuræ coarsely reticulated, rufous above, black below. The median segment has at the apex a sharp oblique slope. Abdomen black, covered with black hairs, two elongated oval marks of silvery pubescence on the second segment near the middle; the third and fourth segments with silvery pubescence at the sides above; the other segments fringed with silvery pile. The ventral segments covered with silvery hairs; the second segment strongly punctured, the punctures distinctly separated. Legs entirely black, densely covered with stout hairs; the tibial spines stout, longish.

MUTILLA PUERILIS, *sp. nov.*

Ferruginea, sparse longe albo-hirta; abdomine nigro. ♀.
Long. fere 8 mm.

Hab. Ceylon (*Yerbury*).

Antennæ ferruginous, the scape shining, sparsely covered with longish white hairs; the flagellum closely covered with short white down. Head shining, sparsely covered with longish white hairs; the tips of the mandibles and an elongated mark extending from the antennal tubercles to the eyes, becoming narrowed as it approaches them, black. Thorax above coarsely rugose, becoming somewhat reticulated towards the median segment; the mesothorax hardly narrowed towards the middle. The propleuræ a little shagreened; the base of the mesopleuræ a little aciculated and hollowed; the rest very shining and impunctate; the apical part of the metapleuræ with distinctly separated punctures. The median segment is

rounded at the top; the apex semi-oblique; abdomen shining, closely and minutely punctured; sparsely covered with long pale hairs; the base of the first to third segments in the middle bearing long pale golden hairs; the hypopygium covered with long pale golden hairs and closely punctured; the ventral segments black, sparsely covered with long white hair; the second segment bearing large, widely separated punctures; the other segments more closely and finely punctured at the apex. Legs covered with long stiff whitish hairs; the anterior tibiæ and femora slightly infuscated.

MUTILLA ARIEL, *sp. nov.*

Ferruginea; abdomine cæruleo, argenteo-maculato; antennis pedibusque nigris; basi antennarum ferrugineo. ♀. Long. II mm.

Antennæ black, sparsely pilose; the basal two joints and the greater part of the third rufous. Head ferruginous; above the antennæ blackish; coarsely punctured; sparsely covered with long fuscous hairs. Thorax ferruginous, not half the length of the abdomen, the sides rounded at base and apex; the latter with an oblique slope, broadly rounded at the top; above coarsely punctured, sparsely covered with long blackish hairs, which become silvery white on the median segment, there is a large pale golden spot on the base of the mesonotum; the sides are slightly and gradually narrowed from the base of the mesothorax to the apex. The mesopleuræ a little hollowed in the centre, infuscated; the lower part densely covered with pale golden hair; the pro- and meta-pleuræ coarsely punctured. The abdomen is metallic blue, shining, sparsely covered with long black hairs; there is a spot of silvery pubescence on either side of the basal segment, an oblong or oval one in the middle of the second; the second segment at the apex has a broad band of silvery pubescence, dilated, broadly and

roundly in the middle; the other segments above in the middle bear silvery spots; the ventral segments are somewhat thickly covered with long silvery pubescence. The legs are covered with longish stiff silvery hairs; the tibial spines stout; the calcaria pale testaceous.

Comes nearest to *M. regia* Sm., of which it may be a variety, but is larger judging by the examples at my disposal; the latter has the flagellum rufous, not black; the legs for the greater part rufous, and the thorax more dilated at the base. The head and thorax want the metallic brassy tint of *M. metallica* and *M. pulchriiventris*.

MUTILLA DIVES, *sp. nov.*

Nigra; thorace supra ferrugineo; abdomine argenteo-maculato. ♀. Long. 8 mm.

Hab. Barrackpore (*Rothney*).

Antennæ entirely black, stout, as long as the head and thorax united. Head a very little narrower than the thorax, coarsely punctured, sparsely covered with fuscous hairs, thorax coarsely rugosely punctured; the base rounded, the sides not contracted as seen from above; the mesopleuræ excavated, shining, impunctate; densely covered with long silvery hairs. The median segment sharply oblique; the metapleuræ coarsely rugose; the propleuræ with shallow punctures. Abdomen a little longer than the head and thorax united, deep black, velvety, the base of the second segment with silvery pubescence in the middle; a somewhat roundish spot above in the middle, and a slightly smaller one at the apex; the third segment is covered entirely with silvery pubescence; and the apical segment is fringed with long silvery hairs. Legs entirely black, densely covered with long white hairs.

Is not unlike *M. taprobana* but is longer, and has the pleuræ entirely black.

MUTILLA PEREGRINA, *sp. nov.*

Long. 7 mm.

Hab. Barrackpore (*Rothney*).

A smaller and more slender species than *M. discreta*, from which it may be known by the mesonotum being more coarsely punctured and having besides two stout longitudinal furrows.

Head distinctly narrower than the thorax; the part behind the eyes, almost less than their length; strongly punctured; thickly covered with long white hairs; the mandibles ferruginous before the teeth; the palpi dark fuscous. Antennæ stout; the scape grooved beneath; sparsely covered with long pale hair; the flagellum thickly covered with fuscous down. Pronotum strongly and closely punctured; the mesonotum strongly punctured; and with the punctures more widely separated; the longitudinal furrows wide and continuous; the scutellum less strongly punctured than the mesonotum; the median segment with a gradually rounded slope; strongly reticulated. Pleuræ coarsely punctured; the base of the metapleuræ impunctate, the apex reticulated. The basal abdominal segment very coarsely punctured; the second less strongly, the other segments almost impunctate, and rather densely covered with long white hairs. The basal ventral segment coarsely punctured, without a keel; the second rather strongly punctured; the others finely and closely punctured at the apex; the apical segment closely punctured, without any depression.

MUTILLA COTESII, *sp. nov.*

Nigra; *thorace capiteque argenteo-maculatis*; *pedibus nigris, basi rufis*. ♀. Long. 8 mm.

Hab. Barrackpore (*Rothney*).

Head large, wider than the thorax, but not much; black; a large somewhat roundish mark of silvery

pubescence on the centre of the vertex, the edge of the occiput rufous; the vertex strongly longitudinally striolated; the front strongly striolated; the antennal tubercles shining, rufous; the middle of the mandibles broadly rufous. Antennæ covered with white pubescence; the flagellum for the greater part rufous beneath. Thorax not one-half longer than the head; very slightly widened towards the apex; the edges at the top irregular; those of the median segment with four large pale rufous teeth, the apex of the median segment oblique, but not sharply. The pleuræ shining, impunctate, black, except the apices of the metapleuræ which are rufous; the mesopleuræ are hollowed at base and apex. Legs black, covered with white hair; the tibial spines long, pale rufous. The coxæ, trochanters, and base of femora (the hinder broadly) rufous. Abdomen not much longer than the head and thorax united; the basal segment at the base obliquely truncated, and at the apex distinctly separated from the second; and with a square mark of silvery pubescence in the centre at the apex; the second segment has at the apex three somewhat oval marks of silvery pubescence; the fourth and fifth segments have silvery pubescence at the apex. The keel on the basal ventral segment ends in the centre in two teeth, the basal being twice the length of the apical; the second segment bears large, round deep punctures; the centre is a little raised, and the raised part ends before the apex in a blunt raised, somewhat triangular tooth. The other segments are more closely punctured, except at the base; and all are covered with long pale soft hairs.

MUTILLA ROTHNEYI, *sp. nov.* (Pl. 4, f. 14).

Capite thoraceque supra ferrugineis, abdomine nigro, argenteo 5-maculato. ♀. Long. 8 mm.

Hab. Barrackpore (Rothney).

In coloration and form of the head and thorax like

M. ædipus, but the latter is easily known from it by the thorax being contracted in the middle.

Head large, a little broader than the thorax; coarsely longitudinally striolated; the striæ running into reticulations towards the antennæ; black; the front and vertex broadly ferruginous; the ferruginous colour extending to a little below the bottom of the eyes; the antennal tubercles and a stripe on the mandibles ferruginous. The scape of the antennæ covered with long silvery hairs, the flagellum sparsely with a pale down. Thorax short, not much longer than the head; coarsely rugosely punctured, sparsely covered with black hairs; the apex of the median segment oblique; the pleuræ excavated, shining, impunctate; the base and apex a little pilose; at the top in the middle the median segment ends in a sharp spine. Abdomen a little longer than the head and thorax united; the base obliquely truncated, with a narrow margin at its apex, and with a spot of pale golden pubescence in its centre above; at the apex of the second segment there is a central and a lateral somewhat larger oval mark of pale golden pubescence; the other segments have a somewhat squarish mark in the middle of the same colour. The ventral segments punctured, the basal segment much more strongly than the others; they are fringed with fulvous hairs. Legs entirely black, bearing white hair.

The present species may, of course, be the ♀ of my *M. ædipus*, but this is a point which can only be decided by direct observation. The head in *M. Rothneyi* is wider compared to the prothorax; the mesothorax is stoutly spined; the front and vertex strongly longitudinally striated all over, while in *M. ædipus* it is only punctured; the head behind the eyes in *M. ædipus* is much more thickly covered with white hairs. There is no appreciable difference in the form and coloration of the two; in *M. Rothneyi* the sides of the median segment are

stoutly spined all over; in *M. ædipus* there are only five large, stout, widely separated spines, these becoming larger from the base to the apex; in *M. Rothneyi* the second basal abdominal segment is stoutly produced in the middle towards the apex, which is not the case in *M. ædipus*.

FOSSORES.

OXYBELUS CEYLONICUS, *sp. nov.*

Long. 7 mm.

Hab. Trincomali, Ceylon (*Yerbury*).

Approaches nearest to *O. squamosus* Sm., with which it agrees best in the form of the squama; but *O. squamosus* may be known from it by the hinder tibiæ and tarsi being yellow, while here they are black.

Head closely punctured, covered, with short white pubescence, especially above, where it assumes a fulvous hue. The scape of the antennæ black above, yellowish beneath; the flagellum fulvous; its base yellowish, blackish above. The clypeus projects and is thickly covered with longish silvery hairs; the mandibles yellowish at the base, black at the apex, and piceous between. Thorax black; a line on the pronotum behind; the tegulæ, tubercles, sides of the scutellum, and the squamæ on the post-scutellum yellow. Mesonotum closely punctured, the punctures more widely separated towards its apex; the suture at the base of the scutellum crenulated; the scutellar punctures large, widely separated, more numerous at the apex, where there is, in the middle, a stout projection. Post scutellar squamæ curved on the outer side, ending in a curved triangular tooth; the squama large, curved at the base, where there is a stout longitudinal keel; the rest of it with stout striations all clearly separated; the apex roundly incised; the ends rounded; the segment at the side of the squama is smooth except for a few striations,

and is for the most part pale brownish; its outer side aciculated and with a few stout striations; the apex has in the middle two stout keels, which form a large triangular space rough in the centre and depressed at the apex; the keels prolonged as one to the apex; the sides obliquely aciculated. The mesopleuræ punctured, the metapleuræ obliquely striated; the striations widely separated. Legs: the coxæ and the base of the fore femora black; the fore femora yellowish; the four posterior ferruginous, the fore tibiæ yellowish; the middle ferruginous; the hinder blackish; the tarsi blackish; the anterior testaceous, yellowish at the base; the hind tibiæ strongly spined, the spines white, the spurs of a more testaceous hue; the apex of the middle femora and the four hinder tibiæ at the base, yellow. Wings clear hyaline, the nervures dark fuscous. Abdomen black, strongly punctured, the sides with a broad yellow line on the four basal segments; the pygidial area thickly covered with longish fulvous hairs.

ASTATA TARDA, *sp. nov.*

Nigra; abdomine rufo late balteato; alis hyalinis, fere fumatis; stigmatè testaceo. ♂. Long. 10 mm.

Hab. Ceylon (Yerbury).

Resembles *A. agilis* Sm., but is larger, and has not the wings distinctly smoky at the apex; the radial cellule at the top much longer than the stigma, while in *A. agilis* it is only about its length; the third cubital cellule much longer compared to the second; and the median segments with no distinct longitudinal keels. Head closely punctured; the sides and clypeus thickly covered with long white hairs; a furrow leads down to the antennæ, the space between the latter smooth and shining, as is also the space in front of the ocelli. Scape of the antennæ covered with long white hairs.

Thorax covered with long white hairs; the mesonotum closely punctured; the scutellum at the base smooth, impunctate; post-scutellum rugose; the median segment reticulated; its top on the oblique apex with a deep oval, impunctate depression; a wide deep oblique depression on the mesopleura. The basal segment of the abdomen black; its apex, the second segment and the base of the third, ferruginous; the base and apex thickly covered with long white hair; the basal ventral segment ferruginous at the sides.

PISON (PARAPISON) ROTHNEYI, *sp. nov.* (Pl. 4, f. 15).

Nigrum, argenteo-pilosum; mandibulis geniculis, tibiisque anticis rufis; alis hyalinis. ♀. Long. 6—7 mm.

Hab. Barrackpore (*Rothney*).

Black, shining, covered with silvery pubescence. Head finely punctured, covered with short fuscous pubescence, except at the incision of the eyes; the cheeks thickly and the clypeus more sparsely covered with silvery pubescence; an indistinct shallow longitudinal furrow below the ocelli; the mandibles and palpi rufous. Antennæ black; the apical three joints rufous beneath; covered with sparse fuscous pubescence. Thorax shining, impunctate; sparsely covered with white pubescence, especially at the sides and base; the median segment with a broad longitudinal furrow extending from the base to the middle of the segment. Pleuræ sparsely covered with short white hairs; the apex of the propleuræ brownish and surrounded by a fringe of silvery pubescence; in the centre of the mesopleura is a deep short depression, a little longer than wide; the sternum deeply and widely excavated. Legs black, thickly covered with short silvery pubescence; the apical third of the fore femora, the front tibiæ entirely, the hinder side of the middle, the basal three-fourths of the hinder, the hinder knees and the calcaria, rufo-

testaceous. Wings hyaline, the costa and nervures black, the latter paler towards the apex of the wing; the second cubital cellule is much narrowed towards the top, the space there bounded by the transverse cubital nervures being less than that bounded by the first recurrent and the first transverse cubital nervure; the second recurrent nervure is almost interstitial nervure. Abdomen shining, impunctate; sparsely covered towards the apex with a silvery pile; the apical segments at the apices testaceous.

Parapison was erected by Smith (*Trans. Ent. Soc.*, 1869, p. 298) for those species, otherwise agreeing with *Pison*, which have only two transverse cubital nervures. Kohl (*Die Gattungen und Arten der Larriden*, *Verh. z.-b. Ges. Wien*, xxxiv.) regards it as only a section of *Pison*.

PISON STRIOLATUM, *sp. nov.*

Nigrum; facie argenteo-pilosa; alis hyalinis. ♀. Long. 8 mm.

Hab. Missouri (*Rothney*).

Has the typical neuration of *Pison* as figured by Kohl, (*Verh. z.-b. Ges. Wien.*, xxxiv., t. 8, f. 1,) *i.e.*, the recurrent nervures are both interstitial.

Head in front opaque, coarsely rugose, behind the ocelli the vertex more shining, and with the punctures more distinct and much more widely separated; below the centre of the eye incision thickly covered with silvery pubescence; the apex of the clypeus gradually brought to a sharp point. Thorax black; sparsely covered with fuscous, the median segment with longer white hairs; the sides with oblique, the centre with curved striæ; the base with a short straight keel at the base; the apex is broadly depressed. Pleuræ strongly punctured; a wide longitudinal furrow on the mesopleura; the metapleuræ smooth; covered sparsely with long hair. Tibiæ and tarsi thickly covered with white pubescence, which gives

them a whitish appearance. The two recurrent nervures are completely interstitial; the pedicle of the second recurrent nervure is longer than the lower cellule. Abdomen smooth, shining, impunctate; the apex sparsely covered with white hairs.

CEMONUS.

Neither this genus (or subgenus according to some authors) nor its type *Pemphredon* has been recorded hitherto from the Oriental Region.

CEMONUS FUŚCIPENNIS, *sp. nov.* (Pl. 4, f. 16).

Niger, nitidus, sparse albo-hirsutus; alis fumatis, basi fere hyalinis. ♀. Long. 8—9 mm.

Hab. Missouri (*Rothney*).

Head very shining, the front closely, the vertex much more sparsely covered with shallow punctures; sparsely covered with long fuscous hairs; the cheeks and clypeus at the sides much more thickly covered with long white hairs; the clypeus with a few punctures in the middle; mandibles entirely black. Antennæ entirely black; almost bare. Thorax shining; the pronotum coarsely punctured; the mesonotum shining, smooth; in front with a few widely separated punctures; and an indistinct, shallow, longitudinal furrow; and there is a more distinct lateral one. The smooth area in the base of the median segment is stoutly crenulated; and there is a distinct longish longitudinal furrow in the centre; and the sides (but not at their extreme edges) have some shallow punctures. The propleuræ at the base are strongly aciculated; the centre smooth, almost impunctate, the mesopleuræ strongly punctured; the metapleuræ obliquely striolated, almost reticulated. Legs black; the femora and tibiæ sparsely covered with long white hair; the

tibiæ also with a pale pubescence; the tarsi have the hairs thicker and shorter. Wings, nervures, and stigma black; the second recurrent nervure received shortly before the first transverse cubital. Petiole rugosely punctured; covered with long white hair; the rest of the abdomen very smooth and shining, almost glabrous, except at the apex, where there are a few pale hairs.

POMPILIDÆ.

CEROPALES ALBOVARIEGATA, *sp. nov.*

Lutea; capite thoraceque albo-maculatis; vertice, pronoto basique mesonoti, nigris; alis hyalinis. ♂. Long. 8 mm.

Hab. Trincomali, Ceylon (*Yerbury*).

Antennæ black; the basal two joints of the flagellum brownish beneath; the scape yellowish beneath; the flagellum thickly covered with short pubescence. Head shining, impunctate; the front, vertex and occiput, except at the sides, black; the rest white; the labrum brownish; the tips of the mandibles black; the antennal tubercles largely projecting above the antennæ, clear white; oval, deeply triangularly cleft down the middle; the anterior ocellus in a depression from which runs a furrow. Thorax smooth, shining, impunctate, glabrous; the pronotum black, lined with white at the apex; its sides at the base projecting beneath, clear white; the mesonotum black to the scutellum, in front of which it is white, it having also a white line at the tegulæ; there is a white mark under the tegulæ, a smaller one under the hind wings; a large mark at the base of the mesopleuræ on the lowerside, and a narrow line opposite it at the apex, a small triangular oblique mark and a curved one over the hind coxæ, clear white; legs fulvous; the anterior coxæ white beneath; the hind tarsi fuscous. Wings clear hyaline; the stigma and nervures black.

POMPILUS ICHNEUMONIFORMIS, *sp. nov.*

Fulvus; capite, thorace apiceque antennarum nigro-maculatis; alis fulvo-hyalinis, stigmatate fusco. ♀. Long. 13—14 mm.

Hab. Missouri (*Rothney*).

Head fulvous; a broad black band with straight sides, extending from the ocelli to near the eyes; the vertex sparsely covered with fuscous; the clypeus much more densely with longer fulvous, hairs; the apex of the clypeus transverse, smooth, and shining; the orbits have a yellower tint than the clypeus; mandibles yellow, black at the apex. Antennæ fulvous; the apical five joints black; thorax fulvous; the base of the pronotum, of the mesonotum, two broad black lines on it extending from the base to the scutellum, the sides at the post-scutellum, the base of the median segment, the pleural sutures and the sternum, black. Legs entirely fulvous; the coxæ with a more yellowish hue. Wings fulvous, the apex with a smoky violaceous hue; the second cubital cellule at the top is a little longer, at bottom shorter than the third; the first recurrent nervure is received shortly before, the second in, the basal third of the cellule. Abdomen fulvous; the extreme base black; where there is a deep triangular depression.

DIPLOPTERA.

RHYNCHIUM BASIMACULA, *sp. nov.* (Pl. 4, f. 17.)

Nigrum; facie abdomineque flavo-lineatis; alis violaceis. Long. 16 mm. ♀.

Hab. Barrackpore (*Rothney*).

Black; the apex of the first and of the second abdominal segment much more narrowly, and a short line behind the eyes, white; the wings violaceous. Front and vertex with large, clearly separated punctures; the

clypeus with the punctures obscure; its apex depressed; slightly curved; the base of the clypeus, and the inner orbits to the top of the incision, white; the mandibles deeply grooved. Antennæ entirely black. Thorax opaque; black; the edge of the pronotum white behind; the pro- and meso-notum strongly, but not very deeply punctured. Scutellum and post-scutellum more rugosely punctured than the mesonotum. Pro- and meso-notum more strongly punctured than the metapleuræ, of which the punctures are more widely separated and not so deep. Legs black, covered with a white down. Abdomen shining, impunctate; the apex of the basal segment with a broad white band of equal width; the second with a much narrower band, dilated slightly at the sides. Wings violaceous; the second cubital cellule at the top is as long as the space bounded by the second recurrent and the second transverse cubital nervures.

The ♂ is very similar to the ♀; the clypeus is entirely pale yellow, with a mushroom-like black mark at the apex; the line on the orbits is broader; the scape is for the greater part yellow, beneath.

This species was recognised by the late Mr. F. Smith as an undescribed species; but it has not, so far as I know, been described.

EUMENES BUDDHA, *sp. nov.*

Nigra; clypeo, lineis pronoti, tibiisque anterioribus flavis; alis fusco-violaceis. ♀. Long. 15 mm.

Hab. Barrackpore (*Rothney*).

Head black; the clypeus, and a narrow line dilated at the top reaching from it to near the ocelli, lemon yellow; the clypeus triangularly cleft in the middle at the apex forming two straight teeth; the part behind these being oblique; the teeth and apex of the mandibles rufous; front and vertex strongly punctured, sparsely covered

with white down; there is a short yellow line behind, and close to, the eyes above the middle. Antennæ black, except the terminal hook and the two joints in front of it which are fulvous; the hook sharply curved. Thorax coarsely punctured all over, sparsely covered with white pubescence; a very narrow line on the side of the propleuræ joined to a larger one on the mesopleura, a line on the apex of the prothorax, one in the centre of the post-scutellum and a line on the apex of the first and second abdominal segments, lemon-yellow. Propleuræ shining, impunctate, deeply obliquely excavated; there is a short longitudinal furrow in the centre of the mesopleura; the oblique space below the hind wing smooth shining, impunctate, except the lower half at the base, which is strongly punctured; the upper edge at the apex crenulated. The median segments at the apex roundly depressed. Legs black, covered with a white down; the hair on the under side of the front tarsi is fulvous.

EUMENES ADVENA, *sp. nov.*

Nigra; tegulis pedibusque rufis; alis fusco-violaceis.
Long. 15 mm. ♀.

Hab. Barrackpore (*Rothney*).

Antennæ entirely black; the scape shining, the flagellum coarse, opaque. Punctures of the head, close, especially on the front where they run into reticulations; the clypeus very thickly, the rest of the head more sparsely covered with silvery hairs; the front somewhat triangularly produced between the antennæ. Mandibles with two deep, wide longitudinal grooves on the apical half, the grooves being piceous towards the apex. Thorax coarsely punctured, more sparsely in the middle of the mesonotum, and still more sparsely on the scutellum; the parapsidal grooves are deep, wide, and run from base to apex. The propleuræ are coarsely irregularly obliquely striolated, on

the lower half the striations being stout; the rest of it, being irregularly punctured and on the lower part irregularly striolated; the mesopleuræ strongly punctured; the punctures widely separated; shortly beyond the centre is a wide deep depression bearing some stout irregular keels; the hinder part of the mesopleuræ strongly aciculated. Scutellum shining; the middle at the apex a little depressed; at the base is a wide depression with five stout keels; and at its apex is a deep wide depression with oblique median segment depressed in the middle; the sides of the depression oblique and meeting at the bottom, and irregularly, somewhat obliquely striolated, the bottom and sides with a sharp keel; the lower part outside this central depression strongly irregularly reticulated. Legs red, covered sparsely with white hairs; the greater part of the fore coxæ and the base of the middle pair above, black. Abdomen black; covered with white hairs; a long depression, keeled in the centre, down the middle at the base; the second segment punctured; the other segments also punctured, but with the punctures closer together; and covered with long white hair.

ANTHOPHILA.

ANDRENIDÆ.

As will be seen, the Andrenidæ are almost exclusively confined to the northern parts, and more particularly to the mountainous regions of India.

PROSOPIS.

Only one species of *Prosopis* has been recorded from the Indian Peninsula; but several are known from the Australian portion of the Malay Archipelago. The new species here described may be separated as follows:—

- 1 (2) Front strongly longitudinally striated (only the hinder tibiæ yellow at the base). *striatifrons*

- 2 (1) Front not longitudinally striated.
- 3 (4) Tibiæ not annulated with white. *leucotarsis*
- 4 (3) Tibiæ annulated with white at the base.
- 5 (6) The keel on the median segment rounded inwardly in the middle at the apex and not running into a central furrow. *strenua*
- 6 (5) The keel on the median segment not rounded inwardly in the middle at the apex.
- 7 (8) The middle of the median segment raised and separated from the sides, which are not striated, base of tibiæ black. *obsoleta*
- 8 (7) The middle of the median segment not raised and separated from the sides and uniformly rugose; base of tibiæ white. *bellicosa*

PROSOPIS STRIATIFRONS, *sp. nov.*

Nigra; orbitis oculorum infra lineaque pronoti flavis; alis hyalinis. ♀. Long. 7 mm.

Hab. Barrackpore (Rothmey).

Comes near to *P. obsoleta*; but is larger and stouter; the front is stoutly longitudinally striated; the median segment longitudinally striated.

Head black; the inner orbits yellow, the yellow dilated towards the middle, gradually at the bottom, more sharply and obliquely at the top. The front and clypeus longitudinally striated; the front raised, its sides with a stout border; the vertex finely punctured, very sparsely and shortly haired. Antennæ stout, the flagellum obscure brownish beneath. Thorax closely punctured, the mesonotum rather strongly punctured; the scutellum with the punctures finer and more widely separated. Centre of median segment at the base irregularly and somewhat strongly reticulated; this reticulated part being surrounded by a distinct border; the rest of the segment coarsely aciculated; the apex with a furrow down the

centre. Mesopleuræ more strongly punctured than the mesonotum; the oblique furrow obscurely crenulated. In the front of the pronotum is an interrupted yellow line; the tegulæ are yellow in front, fuscous behind, and below them is a yellow mark. Wings hyaline; the costa and stigma black; the nervures more fuscous in tint; the first recurrent nervure is received shortly in front of the transverse, almost interstitial; the second interstitial. Legs covered with white hairs; the fore tibiæ broadly obscure rufous (perhaps discoloured) in front; the basal third is lined with yellow behind; the base of the hind tibiæ clear yellow. Abdomen shining, glabrous, impunctate.

PROSOPIS LEUCOTARSIS, *sp. nov.*

Nigra; clypeo, tegulis tarsisque flavis; alis hyalinis, nervis stigmatæque pallidis. ♀. Long. 5 mm.

Hab. Ceylon (*Rothney*).

Head nearly as wide as the thorax; shining, impunctate; the front and vertex sparsely covered with long pale hairs; the clypeus and labrum yellowish-white, immaculate. Antennæ black, sparsely microscopically pilose; the scape sparsely covered with fuscous hair. Thorax black, shining, bearing longish white hairs; the base of the median segment somewhat flat, aciculate; the apex with an oblique slope; covered with long pale hairs. Pleuræ shining, impunctate, thickly covered with longish pale hairs, and having a bronzy tinge. Legs black, with a greenish tinge, sparsely haired; the tarsi rufo-testaceous, thickly covered with white hairs. The second recurrent nervure is straight, oblique; the second is, at the top, curved towards the first; the cellule at the top being there not much more than half the length it is at the bottom; the first recurrent nervure is almost interstitial; the second recurrent nervure is received very shortly in front of the second transverse cubital.

PROSOPIS STRENUA, *sp. nov.*

Long. 6 mm. ♀.

Hab. Barrackpore (*Rothney*).

Head as wide as the thorax, closely, but not very strongly, punctured; sparsely covered with pale hairs; a square mark on the clypeus, a line on the inner orbits extending from the base of the mandibles to near the level of the front ocellus, and becoming gradually wider in the middle, bright yellow; the labrum and tips of the mandibles piceous; the palpi testaceous. The front raised and stoutly keeled laterally over the antennæ. Antennæ covered with a fuscous pubescence; the base of the scape and the second and third joints, obscure rufous; the flagellum obscure testaceous beneath. Thorax black; a line on the base of the pronotum, narrowed in front, the tegulæ at the base and a mark in front of them, lemon-yellow. Mesonotum closely and rather strongly punctured; the scutellum with the punctures, if anything, larger, but more widely separated. Middle of the median segment raised, the raised parts forming a rugose triangle, bordered by a smooth space semicircular at the apex, which again is bordered by a distinct keel; its apex has a straight abrupt slope; the base in the middle excavated; the apex transversely rugose. Pleuræ rather strongly punctured; a wide furrow running down from the tegulæ to the sternum, which is strongly punctured and slightly hollowed in the middle. Legs black, slightly covered with white pile; the anterior greater part of the fore tibiæ, the base of the middle, the basal half of the hinder, and the greater part of the basal joint of the hinder tarsi, bright yellow; the front four tarsi testaceous, obscure yellow at the base, black at base behind. Wings hyaline; the nervures fuscous, the stigma and costa darker; the two recurrent nervures interstitial. Abdomen black, shining, the ventral segments obscurely punctured at the base; the apex bearing fuscous hairs.

PROSOPIS ABSOLUTA, *sp. nov.*

Long. 5 mm. ♀.

Hab. Barrackpore (*Rothney*).

Resembles *P. strenua*; but may be known by the base of the median segment wanting the smooth space and the curved keels.

Head scarcely so wide as the thorax, strongly punctured, almost rugose; thickly covered with short white hairs; a mark rounded at the base and broader than long at the apex of the clypeus; an elongate somewhat triangular spot, extending from the base of the clypeus to near the front ocellus, the apex of its dilated part being at the top of the clypeus, and the lines are united there by a yellow mark, which is truncated at the bottom, rounded at the top. Flagellum brownish beneath, covered with a microscopic down. Thorax black, strongly punctured; covered with short white pubescence; the median segment broadly and coarsely rugose in the middle, the rugose part triangular, and at the apex bearing stout transverse irregular keels; the sides and apex of the median segment alutaceous, covered with a pale microscopic down. Mesopleuræ rather strongly punctured, the punctures all distinctly separated; the metapleuræ coarsely alutaceous. Legs covered with white pubescence; the greater part of the fore tibiæ and the hinder four broadly white at the base; the front pair piceous behind; the calcaria white; the tips of the tarsi testaceous. Wings hyaline, the stigma and nervures dark fuscous; the first recurrent nervure received in front of the transverse cubital; the second interstitial. Abdomen entirely black; a spot of white pubescence on the side of the second segment.

PROSOPIS BELLICOSA, *sp. nov.*

Long. 6 mm.

Hab. Barrackpore (*Rothney*).

May be known from the other species by the central

part of the median segment being distinctly raised and separated from the lateral; these are smooth, shining, and impunctate; the surrounding keel is stout and piceous in colour.

Antennæ black; the flagellum brownish beneath, and bearing a slight white microscopic down. Head coarsely punctured; bearing short white microscopic pubescence; the inner orbits to near the lower ocellus, and dilated below the antennæ and narrower at the bottom than at the top, and a large mark on the clypeus, broad at the base and gradually narrowed to the top, yellow; the upper part of the mandibles yellow, the apical piceous. Thorax black; the pro- and meso-notum punctured; the median segment at the base with a large somewhat square coarsely rugose space, surrounded by a smooth impunctate area, bordered by a stout, semicircular piceous keel; the apex without a distinct furrow and thickly covered with white hairs. Pleuræ and sternum strongly punctured; a line on the pronotum at the apex, the tubercles and the base of the tegulæ yellow, the apex of the tegulæ, piceous. Legs black, covered with white pubescence; the anterior knees, tibiæ and tarsi, the middle tibiæ broadly at the base and slightly at the apex, the hinder tibiæ broadly at the apex and the metatarsi, yellow; the hinder femora incline to piceous beneath; and the yellow is suffused at the base or apex with brownish. Abdomen shining, the sides sparsely covered with white pubescence.

The size of the yellow mark on the clypeus varies.

HALICTUS.

a. Species with the abdomen more or less reddish.

HALICTUS WROUGHTONI, *sp. nov.*

Niger; longe dense pallide hirtus; abdominis basi late rufo; pedibus nigris, femoribus fere piceis, longe albo-pilosis; alis hyalinis, stigmatè piceo, nervis pallidis. ♀. Long. 8mm.

Hab. Bombay Presidency (*Wroughton*).

Head black, very densely covered with grey pubescence, longer and slightly sparser in front; short and very dense behind, completely hiding the surface; the labrum fringed with long golden pubescence; the mandibles ferruginous at the apex, their base, on the outer side, covered with short, close, white pubescence. Antennæ black, slender, the scape sparsely covered with short white hairs. Thorax densely covered with soft white hairs; the mesonotum closely but not deeply punctured; the hairs on the post-scutellum shorter and covering it entirely; the base of the median segment closely, irregularly striolated; the hairs on the pleuræ long and thick. Legs black; the femora dark piceous; covered with long white hairs, those on the hinder femora being especially long; on the hinder tibiæ and tarsi they have a fulvous tinge. The third cubital cellule is nearly twice the length of the second at top and bottom. Abdomen shining, impunctate; the basal segment and the basal half of the second red; the basal segment at the base covered with long white hairs; the others fringed with white pubescence; the ventral segments red; the apical two black; thickly covered with long pale hairs.

HALICTUS DECORUS, *sp. nov.*

Niger; abdominis basi late rufo; tarsis testaceis; alis hyalinis. ♀. Long. fere 5mm.

Hab. Missouri (*Rothney*).

Head with a slight greenish tinge; the clypeus and the lower part of the front thickly covered with white pubescence; the vertex with longer, sparser fuscous hairs; the mandibles ferruginous, the teeth blackish; their base sparsely covered with pale hairs. Antennæ black, brownish beneath from the fifth joint. Thorax black, almost impunctate; the pronotum thickly covered with white hairs; as is also the post-scutellum and the sides of

the scutellum; the median segment has an elongated semicircular area, the base raised, rugosely punctured; the rest of it smooth, with a distinct central and a few incomplete longitudinal keels, there being also a transverse keel before the apex. Behind the narrow part of this area, at the sides of it, is a strongly irregularly obliquely keeled area; the apex of the segment semi-oblique, strongly aciculated. Meso- and meta-pleuræ thickly covered with white hairs; the latter obliquely striated. Legs black, with a piceous tinge, the femora darker; the femora sparsely, the tibiæ and tarsi thickly, covered with white hairs. Tegulæ testaceous, darker behind. Wings clear hyaline, the nervures and stigma blackish; the recurrent nervures received near the apical third of the cellules. Abdomen shining, smooth; the basal three segments red above and below; the apical black, thickly covered with longish white hair.

Comes near to *H. xanthognathus* Sm., but is much smaller and otherwise quite distinct.

HALICTUS DISSIMILANDUS, *sp. nov.*

Long. fere 6 mm. ♀.

Hab. Missouri (*Rothney*).

Is very like *H. decorus* in size and coloration, but may be at once known by the base of the median segment not having a depressed semicircular area clearly defined by a keel; it being instead strongly reticulated; the legs, too, are much lighter in tint.

Antennæ black, thick, sparsely covered with white microscopic hairs; the front and vertex more sparsely with longer hairs; the vertex obscurely punctured; mandibles rufous, the tips black. Pro- and meso-notum covered with fuscous hairs; the hairs on the scutellum longer and paler; the pro- and meso-notum coarsely punctured; the scutellum not quite so strongly punc-

tured as the mesonotum; the median segment stoutly reticulated; its apex oblique shining, not reticulated. Propleuræ smooth, piceous; the base with some longitudinal keels; the apex fringed with woolly hairs; the mesopleuræ coarsely rugosely punctured; the metapleuræ with an oblique smooth space in the centre, the base and apex coarsely punctured. Legs obscure piceous; the femora darker; sparsely covered with white hairs. Wings hyaline; the nervures and stigma fuscous; the first recurrent nervure received quite close to the transverse cubital; the second in the apical third of the cellule. The basal three segments of the abdomen rufous, widely suffused with black in the middle; the apical segments sparsely covered with white hairs; the ventral segments coloured like the dorsal.

One of this species has projecting from the apex of the third dorsal segment the larvæ of one of the *Stylopidæ*, probably a *Halictophagus*.

HALICTUS INVIDUS, *sp. nov.*

Niger; thorace fortiter punctato; metanoto reticulato; abdominis medio ferrugineo; alis hyalinis, apice fere fumatis.
♀. Long. 7—8 mm.

Hab. Missouri (*Rothney*).

Head rugosely punctured; below the antennæ thickly covered with white hairs; the front and vertex more sparsely covered with longer white hairs. Mandibles piceous in the middle; underneath with a few long golden hairs. Antennæ stout, the flagellum thickly covered with longish white hairs; the joints of the flagellum dilated broadly beneath; towards the apex bearing a white microscopic pile. Thorax coarsely rugosely punctured; the punctures on the apex of the mesonotum larger and more widely separated; the base of the median segment with stout longitudinal keels, irregular in the middle,

forming almost reticulations; at the apex in the middle is an area broad and rounded at the base, becoming narrowed towards the apex; forming an almost pyriform space; there is an oblique, somewhat similar, area at its side at the top; the rest has four stout slightly oblique keels, running from the centre. Pro- and meso-pleuræ coarsely strongly punctured, running into strong reticulations at the apex; the metapleuræ coarsely strongly punctured; the base coarsely obliquely striated; the punctures at the apex large, round. Legs black; the apices testaceous; the femora sparsely, the tibiæ, and especially the tarsi, covered with silvery white pubescence. The first and second transverse cubital nervures are bullated at top and bottom; the first recurrent nervure is received quite close to the transverse cubital; the second shortly before the apical third of the cellule. Abdomen shining, the basal three segments punctured; the apical smooth and shining; the ventral segments shining, broadly ferruginous in the middle; the third ferruginous in the middle.

HALICTUS SERENUS, *sp. nov.*

Niger; abdominis basi late rufo; alis hyalinis, nervis testaceis. ♂. Long. 5 mm.

Hab. Missouri (*Rothney*).

Head finely punctured, thickly covered with long white hair; the mandibles before the apex ferruginous; beneath with some long golden hairs. Antennæ stout, the scape with some long white hairs; the flagellum almost bare. The base of the median segment with its area irregularly striolated; the lateral striations on it straighter and more widely separated; the apex hollowed, smooth, impunctate at base, the apex rough, but without any distinctly defined keels. Pleuræ strongly aciculated, covered with long white hairs; femora clothed with some long white hairs; the tibiæ and tarsi more thickly with

golden hairs. Abdomen shining, black, the basal segment reddish, the base with longish white hairs, deeply and widely incised above; the ventral segments like the dorsal. The first recurrent nervure almost interstitial, received immediately in front of the transverse cubital nervure; the second in the apical fourth of the cellule.

b. Green or blue species.

HALICTUS GRANDICEPS, *sp. nov.*

Cupreo-viridis, longe albo-hirsutus; antennis nigris; alis flavo-hyalinis. ♀. Long. 8—9 mm.

Hab. Missouri (*Rothney*).

Head large, wider than the thorax, coppery green, thickly covered with white pubescence; closely and uniformly punctured; except above, and on the clypeus, where the punctures are more widely separated; the apical half of the clypeus coppery and fringed with golden hairs. Antennæ black; very sparsely covered with microscopic pile. Thorax above closely and rather strongly punctured; the punctures wider apart and larger on the apex of the mesonotum and on the scutellum; the hairs on the mesonotum sparse; on the post-scutellum long and thick; the base of the median segment depressed, finely longitudinally striated; this part in front being bordered by a shining, smooth, glabrous space; the apex has an oblique slope; an elongated deep depression in the middle, into which run two shallow curved furrows from the top, which enclose a triangle at the top. Pleuræ closely and finely punctured; the enclosed space below strongly, the hind wings at top and bottom strongly transversely striolated; the lower part of the metapleuræ at the bottom at the base finely longitudinally striated. The four hinder tibiæ and tarsi thickly covered with long pale fulvous hairs; the femora and the fore legs with the hairs whiter and sparser; the spurs pale fulvous. Wings

hyaline but with a distinct fulvous tinge, especially towards the base; the stigma and nervures fulvous, the lower nervure of the costa blackish. Abdomen shining, shagreened, except the base of the basal segment; the apices of the segments fringed with white hairs; the last segment thickly covered with long pale golden hairs; the ventral segments shagreened and covered with long pale hairs at the apex.

HALICTUS ALEXIS, *sp. nov.*

Viridis, dense fulvo-hirtus; alis hyalinis, stigmatè pallide flavo; pedibus longe, dense, pallide pilosis. ♀. Long. 7 mm.

Hab. Barrackpore (Rothney).

In its bronzy green coloration it agrees with *H. propinquus*; but it is larger, and the tibiæ and tarsi are not yellowish-fulvous, neither are the tegulæ fulvous.

Head uniformly and closely punctured all over, except on the clypeus where they are fewer and much more widely separated, densely covered with longish pale fulvous hairs; the apex of the clypeus shining, dark bronzy; the labrum covered with long pale golden hairs; the mandibles entirely black; their lower side bearing some long pale golden hairs. Antennæ entirely black; the scape sparsely covered with long pale fulvous hairs; the flagellum almost glabrous. Mesonotum closely and rather strongly punctured, thickly covered with fulvous hairs; the parapsidal furrows distinct; the fulvous hairs at the apex of the scutellum and on the post-scutellum long and thick. The basal curve on the median segment finely and closely rugose; its apex shining and impunctate; the apex of the segment with an oblique slope; shagreened; furrowed down the centre. The propleuræ deeply excavated; the excavation forming an oblique triangle, obscurely striated down the centre and at the apex thickly covered with white hairs; the mesopleuræ strongly

and closely punctured; the hairs very long and thick; the metapleuræ finely punctured; the middle finely striated. Legs, especially the hinder, thickly covered with pale fulvous hairs; the femora with the hairs longer and much sparser; the fore femora beneath glabrous, shining, black; the tarsi ferruginous at the apex. Wings clear hyaline, the stigma and nervures yellowish-testaceous, the stigma darker; the second cubital cellule at the top somewhat shorter, at the bottom equal in length to the third at the top, which is there scarcely half the length it is at the bottom; the first recurrent nervure is almost interstitial; the second received near the apical third. Abdomen dark bluish-green; the segments fringed with pale fulvous pubescence; the apical very thickly with longer fulvous hair, except on the furrow in the centre. Ventral segments shining, thickly covered with long pale fulvous hairs.

HALICTUS DISCURSUS, *sp. nov.*

Long. fere 4 mm.

Hab. Missouri (*Rothney*).

Comes near to *H. propinquus* Sm., but may be known from it by its smaller size, by the thorax not being thickly covered with white hairs, and by the deep, wide, longitudinal furrow on the base of the mesopleuræ; and by having a short longitudinal furrow at the base of the mesonotum.

Bluish-green, metallic, shining, the knees, tibiæ and tarsi rufo-testaceous; wings clear hyaline, the stigma and nervures pallid, the stigma somewhat darker. The apex of the clypeus is bronzy; the labrum is thickly covered with long golden hairs; the mandibles and trophi testaceous; scape of the antennæ black; the flagellum brownish beneath; covered with white microscopic pile. The area at the base of the median segment finely and

closely longitudinally striated except at the apex; which has an oblique slope; the pleuræ shining, impunctate, sparsely covered with white hairs; at the base of the mesopleuræ and above its middle is a wide, deep furrow, extending from the base to the apical third; the metapleuræ finely punctured at the base. Legs thickly covered with white hairs. The second and third cubital cellules are subequal: the first recurrent nervure is interstitial; the second, the third transverse cubital and the cubital nervure from the second transverse cubital, are almost obsolete. Abdomen shining; the base with a wide, deep, longitudinal furrow; the apical segments thickly covered with long white hairs; the fifth segment on either side of the smooth dark testaceous central rima, thickly covered with long pale golden hairs; the ventral segments pale at the apices; the sides of the basal segments and the apices of the apical segments thickly covered with long white hairs; the basal segments in the middle sparsely covered with long white hairs.

c. Species entirely black; the abdomen banded with white hairs.

HALICTUS SEPULCHRALIS, *sp. nov.*

Niger; abdomine late albo-balteato; pedibus longe fulvo-hirsutis; alis hyalinis. ♀. Long. 8 mm.

Hab. Missouri (Rothney).

Head black, hardly so wide as the thorax, the face and outer orbits thickly covered with short white pubescence; the vertex and front closely punctured, sparsely covered with long fuscous hairs; the middle and apex of the mandibles piceous. Antennæ black, shining, almost glabrous. Pro- and meso-notum very shining, with only a few microscopic punctures; sparsely covered with short white hairs; the post-scutellum with long white hairs; the median segment at the base with a belt of longi-

tudinal striæ narrowed gradually towards the apex; shining; its apex with an oblique slope, hollowed in the centre, the sides distinctly bordered; the pleuræ and sternum alutaceous, covered with long white hairs. The hind legs covered all over thickly with white hairs; the front four legs less strongly and thickly haired; the femora bare and shining in front; the hairs on the tarsi have a more fulvous tinge; apices of the tarsi rufous. Wings clear hyaline; the nervures fuscous; the stigma paler; the costa darker; the first recurrent nervure almost interstitial; the second received in the apical fourth of the cellule; the tegulæ black, piceous in the middle. Abdomen shining, impunctate; the base of the first segment sparsely covered with longish pale hairs; the second to fifth segments bordered at the apex with white depressed pubescence; the apical segment finely punctured laterally; the rima aciculate, piceous; the ventral segments sparsely covered with long hairs, shining, the basal segments more or less piceous.

HALICTUS PICIPES.

Niger, nitidus; pedibus piceis; capite thoraceque long albohirtis; alis hyalinis; ♂ flagello antennarum subtus bronneo.
♀. Long. 6—7 mm.

Hab. Missouri (Rothney).

Head alutaceous, thickly covered with longish white hairs, which are shorter, sparser, and darker coloured on the vertex. Mandibles piceous before the teeth. Antennæ stout, the flagellum beneath, brownish, darker at the apex. Pro- and meso-notum shining, impunctate, sparsely covered with fuscous hairs; post scutellum thickly covered with white down and with long white hairs. Base of the median segment irregularly longitudinally keeled; those in the middle being wider apart; its apex with an abrupt oblique slope; shining, impunctate; the middle hollowed widely at the top. Pro- and meso-pleuræ closely and

finely rugosely punctured; the oblique depression under the fore wings irregularly transversely striolated; the metapleuræ have a blistered appearance, and are covered with long white hairs. Wings clear hyaline; the nervures fuscous; the first recurrent nervure interstitial; the second received in the apical fourth of the cellule. Tegulæ fuscous, lighter coloured round the edges. Legs piceous; thickly covered with longish white hairs; the coxæ black. Abdomen shining, impunctate, the basal segment at the base with some long white hairs; the others fringed with white hairs at the apices; the ventral segments fringed with long white hairs; the apical segment broadly rounded; its sides acutely projecting.

HALICTUS TARDUS, *sp. nov.* (Pl. 4, f. 18).

Niger; longe albo-hirtus; tarsi fulvo-hirsutis; metanoto reticulato; alis hyalinis. ♀. Long. 8 mm.

Hab. Missouri (*Rothney*).

Head closely and somewhat strongly punctured; densely covered with long soft white hairs; the labrum fringed with long fulvous hairs; the mandibles piceous at the base. Antennæ stout; the scape with longish white hairs; the flagellum with sparse white down. Mesonotum and scutellum shining, bearing widely separated shallow punctures, and, as well as the post-scutellum, thickly covered with long white hairs; the median segment at the base closely longitudinally striated, the striæ not all quite straight; the apex of the striated area smooth and impunctate; the apex of the segment strongly reticulated; and with a deep and wide furrow down the centre; the sides sharply and stoutly margined. Propleuræ smooth, shining; the top bluntly triangular; the mesopleuræ rugosely punctured; the metapleuræ at the base alutaceous; the apex reticulated; but with the keels much weaker than they are on the mesonotum.

Legs black; the coxæ and femora sparsely covered with long white hairs; the tibiæ and tarsi much more thickly with fulvous hairs; those of the tarsi having a deeper fulvous tint than those of the tibiæ; the calcaria fulvous. Wings hyaline; the nervures fuscous; the costa and upper part of the stigma black; the lower part of the latter piceous; the second and third cubital cellules at the top and bottom nearly equal in length. Abdomen impunctate, shining, shagreened towards the apex; the basal segment at the base covered with long erect white hairs; the other segments, except the last, fringed with depressed white hairs; the last segment thickly covered with stiff black hair; the apical area fringed with golden hair; the ventral surface thickly covered with long white hairs.

HALICTUS FUNEBRIS, *sp. nov.*

Long. 9 mm. ♀.

Hab. Missouri (*Rothney*).

This species agrees with *H. tardus* in having the metanotum strongly striolated at the base; and in having the tarsi thickly covered with long golden hairs; but it may be at once known by the apex of the median segment not being reticulated, and having only a few oblique stout keels.

Head shagreened, the clypeus obscurely punctured; covered all over with long white hair; the mandibles piceous towards the apex, bearing beneath a few fulvous hairs. Antennæ stout, bare, the scape with a few long white hairs. Mesonotum coarsely shagreened, opaque; the lateral furrows distinct; covered, as is also the scutellum, with long pale hairs; the scutellum rough at the base, the apex irregularly reticulated; the base of the median segment longitudinally closely and stoutly carinated; the apex with a central keel, from which run a few oblique keels. Legs black, the femora and tibiæ

sparsely covered with white hairs; the hairs on the tarsi denser and golden. Wings clear hyaline, the nervures black; the second cubital cellule at the top equal in length to, at bottom shorter than, the third; the first recurrent nervure is received very shortly before the second transverse cubital; the second before the apical third of the cellule. Abdomen shining, impunctate, sparsely covered with fuscous hairs, above and below.

HALICTUS CIRIS, *sp. nov.*

Niger; clypeo, labro, scapo antennarum subtus, tibiis tarsisque, flavis; flagello antennarum subtus brunneo; alis hyalinis. ♀. Long. fere 5 mm.

Hab. Barrackpore (*Rothney*).

Head black, from shortly below the ocelli to the apex of the clypeus thickly covered with short white hairs. Clypeus shining, bearing large widely-separated punctures; at the top, in the middle, the yellow projects triangularly into the black. Mandibles yellow, the apex rufous; the palpi and tongue testaceous. Antennæ stout covered with a pale microscopic pile; the yellow on the under side of the scape with a black mark in the middle. Thorax black, alutaceous, not shining, sparsely covered with a short down; the edge of the pronotum in front and below the tegulæ lemon-yellow; the tegulæ yellow; the base of the median segment longitudinally striolated; the space between the striæ aciculated; the apex of the depression smooth and shining; the apex of the segment oblique; furrowed down the centre; the sides distinctly and strongly keeled. The pleuræ strongly aciculated, opaque, thickly covered with white hairs; the propleuræ excavated. Legs covered with white hairs; the apex of the fore femora and the hinder four knees rufo-testaceous; the tibiæ and tarsi yellow; the hinder tibia rufous before and behind, with a large black line in front. Wings clear

hyaline; the nervures pallid yellow; the costa darker; the first and second transverse cubital nervures bullated at the top next to the radial nervure; the first recurrent nervure interstitial; the second received in the apical fourth of the cellule.

HALICTUS VISHNU, *sp. nov.*

Niger; clypeo, geniculis tarsisque testaceis; alis hyalinis, nervis stigmatæque testaceis. ♀. Long. 4 mm.

Hab. Missouri (*Rothney*).

Head thickly covered with longish fuscous hairs; the clypeus testaceous, the middle of the mandibles piceous. Antennæ almost glabrous; the flagellum brownish beneath. Mesonotum covered with longish fuscous hairs; closely punctured; the scutellum with the punctures more widely separated; post-scutellum thickly covered with long fulvous hair; the base of median segment shining, glabrous, impunctate, and marked with a few straight longitudinal keels, which do not reach to the bordering carina at the apex of the basal region; the apex has a sharp oblique slope, and is sparsely covered with long hairs. Pleuræ covered with longish white hairs. Legs covered with white hairs; the knees, anterior tibiæ in front and the tarsi testaceous. Wings hyaline, the stigma and nervures testaceous; the first recurrent nervure received in the apical third of the cellule, the second in the second shortly beyond the middle. Abdomen shining, impunctate; the segments above and beneath thickly covered with white hairs; the apical ventral segment with a distinct bordering keel.

HALICTUS SALUTATRIX, *sp. nov.*

Niger, nitidus; geniculis tarsisque albis; alis hyalinis. ♀ et ♂. Long. 6 mm.

Hab. Missouri (*Rothney*).

Head black, closely and minutely punctured; thickly

covered with pale fulvous hairs; the clypeus shining, the punctures, especially towards the apex, more widely separated; the mandibles testaceous in the middle, piceous towards the apex. Antennæ black, covered with a microscopic down. Thorax shining, minutely punctured; covered with white hairs, especially long on the pleuræ, post-scutellum and apex of median segment; the area at the base of the median segment longitudinally striated; the apex at the base very shining; its central furrow not very wide. Propleuræ deeply excavated in the middle and finely striated; the apex at the top, finely striated; the meso- and meta-pleuræ opaque, shagreened, covered with long white hairs. Legs covered with long white hairs, which are especially thick on the hinder four tibiæ and tarsi; the knees of the front pair, the base of the hinder four tibiæ and the tarsi yellowish-testaceous. Wings clear hyaline, the nervures fuscous; the stigma darker at the base; the first recurrent nervure is almost interstitial; the second is received in the apical third of the cellule; the apices of the basal three segments of the abdomen pale, slightly fringed with pale hairs, the apical segments thickly covered with long fulvo-golden hair; the ventral surface, especially towards the apex, bearing long pale, fuscous hairs, the apical segment for the greater part aciculated.

HALICTUS BUDDHA, *sp. nov.*

Long. 5 mm. ♀.

Hab. Missouri (*Rothney*).

Agrees closely with *H. salutatrix*, and, like it, has the base of the tibiæ and the tarsi white; but the front four tibiæ are entirely white; the clypeus broadly white at the apex, the antennæ broadly brownish beneath, the base of the median segment much more strongly striolated.

Head below and between the antennæ thickly covered with white hairs, the front and vertex more sparsely covered with long fuscous hair; the vertex opaque, coarsely shagreened; the apex of the clypeus and labrum yellowish-white; the palpi fuscous; the scape of the antennæ and the second joint entirely black; the others black above, brownish beneath. Pro- and meso-notum shagreened, bearing a short pale down; a narrow longitudinal furrow down the centre of the mesonotum at the side; the scutellum uniformly shagreened like the mesonotum; the post-scutellum rugose, covered with long pale hairs. The curved basal area on the median segment shining, irregularly longitudinally carinate, the keels less distinct in its centre. The pleuræ closely longitudinally striated; the part below the hind wings covered with long white hairs; the propleuræ and the pronotum in front shining, glabrous, impunctate; and sharply separated obliquely perpendicularly behind. Wings clear hyaline, the nervures pale yellowish; the second and third cubital cellules almost equal in length at top and bottom; the first recurrent nervure is almost interstitial; the second is received in the apical third of the cellule. Abdomen shining; the basal segment, except at the apex, covered with long white hairs and without a longitudinal furrow; the segments at the apex fringed with white depressed hairs; the ventral segments bearing long white hairs; the penultimate segment shining and smooth in the middle.

HALICTUS ALPHENUS, *sp. nov.*

Nigro-cæruleus; abdomine nigro; femoribus subtus piceis; pedibus longe albo-fumatis. ♂. Long. 6—7 mm.

Hab. Missouri (*Rothney*).

Head and thorax dark blue; the clypeus black. Head obscurely shagreened, covered with long fuscous hairs; the base of the mandibles piceous. Antennæ entirely

black, the flagellum almost bare; the scape bearing long white hairs. Pro- and meso-thorax impunctate, covered with long white hairs; the pleuræ under the wings striated; the base of the median segment obscurely longitudinally striated; its apex oblique, slightly hollowed in the centre, the sides margined. Legs black; the femora with a piceous hue; sparsely haired, the hairs on the tibiæ and tarsi much thicker, especially on the tibiæ which have a fulvo-golden hue; the spurs yellowish-testaceous. Abdomen black, shining, glabrous, except at the apex, which bears fulvous hairs; the ventral segments shining, impunctate, almost glabrous. Wings clear hyaline, the nervures fuscous; the first recurrent nervure almost interstitial; the second received in the apical fourth of the cellule.

HALICTUS GARRULUS, *sp. nov.*

Niger, pallide fulvo-hirtus; geniculis, tibiis tarsisque pallide fulvis; alis fulvo-hyalinis, stigmatè fulvo, nervis pallidis. ♂.
Long. 7 mm.

Hab. Missouri (*Rothney*).

Head black; the front and vertex coarsely alutaceous; the lower part of the face densely covered with golden-fulvous pubescence; the mandibles dark piceous, black at the base. Antennæ brownish, the upper part blackish; the scape black, sparsely covered with longish pale hairs. The edge of the pronotum, the mesonotum, fringed all round with pale fulvous hairs; the mesonotum closely and rather strongly punctured; the scutellum with the punctures more widely separated; the post-scutellum thickly covered with pale pubescence, completely hiding its surface; the base of the metanotum strongly longitudinally keeled throughout; the remainder opaque, closely punctured, furrowed in the middle at the apex and thickly covered with long white hairs. Pleuræ

opaque coarsely alutaceous; thickly covered with long white hairs. Legs thickly covered with fulvous white hairs; the femora with a piceous tinge beneath; the tibiæ and tarsi fulvous; the tarsi paler. Wings with a faint fulvous tinge; the stigma and costa fulvous; the nervures testaceous; the second transverse cubital nervure largely bullated; the recurrent nervures received shortly beyond the middle. Abdomen shining, impunctate; the segments edged with white pubescence; the ventral surface shining, the first and second segments shining, very sparsely haired; the others much more quickly covered with longish fuscous hairs.

d. Abdomen thickly banded with fulvous hairs.

HALICTUS PULCHRIVENTRIS, *sp. nov.*

Niger; tarsis albis; alis fere hyalinis, apice fumatis. ♂.
Long. 9 mm.

Hab. Missouri (*Rothney*).

Head black; in front from shortly above the antennæ, densely covered with pale fulvo-aureous pubescence, which completely hides the skin; vertex and front strongly punctured, half shining, sparsely covered with fulvous hairs. Antennæ black, the second and base of the third joint beneath rufous; the scape covered with longish pale fulvous hairs; the flagellum with a microscopic down. Thorax black, a thick band of fulvous pubescence on the pronotum, and a broader belt behind the scutellum of longer fulvous hairs; the mesonotum covered with short fuscous hairs; the median segment from shortly below the basal area covered with long pale fulvous hairs. Mesonotum strongly punctured; a short shallow longitudinal furrow on each side of the mesonotum, originating at the base and reaching to the middle. The basal area of the median segment longitudinally striolated except at the apex, where it has some widely separated punctures

on either side of the base of the furrow; the sides of the segment at the area are impunctate; the rest of it with distinctly separated punctures. The mesopleuræ, except at base and apex, thickly covered with long pale fulvous hairs; the metapleuræ covered with a pale fulvous down and more sparsely with long pale fulvous hairs. Wings hyaline, with a slight fuscous tinge; the apex from the apex of the radial cellule smoky; the nervures fuscous; the stigma darker at the top; both the recurrent nervures are received about the same relative distance beyond the middle. Legs thickly covered with longish fulvous hairs, the tarsi and the anterior tibiæ in front testaceous. Abdomen punctured, strongly towards the base, more weakly towards the apex; the segments shining at the base, sparsely covered with long fuscous hair; the fourth segment thickly covered with depressed fulvous pubescence; the fifth obliquely depressed; covered with long fulvous hair; the last segment ferruginous.

HALICTUS TAPROBANÆ, *sp. nov.*

Long. 6 mm.

Hab. Ceylon (*Rothney*).

Agrees very closely in form and coloration with *H. pulchriventris*, but is much smaller; and otherwise easily separated by the striated area of the median segment being distinctly and triangularly produced at the apex, which is not the case in *H. pulchriventris*; it is also not hollowed at the apex.

Antennæ black, the flagellum brownish on the under-side, covered with a pale microscopic down. The face below the antennæ and the sides as high as the lower ocellus, thickly covered with pale fulvo-aureous pubescence; the mandibles broadly ferruginous in the middle. Thorax black; the mesonotum and scutellum closely punctured, the edge of the pronotum behind and a belt

behind the scutellum thickly covered with long pale fulvous pubescence; the mesonotum covered with short, the scutellum with long, dark fulvous hairs. The area on the median segment triangularly produced in the middle, and longitudinally striolated; the central striæ not reaching to the apex; the area bare, the rest of the segment covered with long pale fuscous hairs. Mesopleuræ thickly covered with fulvous hairs; the hairs on the metapleuræ sparser and longer. The front femora entirely, beneath and above, and the four posterior entirely on the under side, obscure testaceous, as are also the apices of the tibiæ; the basal joint of the tarsi white; the others white, but with a testaceous tinge. Wings hyaline, the apex slightly infuscated, the stigma and nervures testaceous, the former black at the extreme base. The first recurrent nervure is received shortly before, the second shortly beyond, the middle of the cellule. Abdomen shining, the segments shagreened; their apices thickly fringed with pale hairs; the last segment testaceous. Ventral segments shining, sparsely covered with long hairs, their apices white; the last testaceous; the penultimate with a shallow depression, wide at base, becoming gradually narrower towards the apex.

ANDRENA ROTHNEYI, *sp. nov.*

Nigra; abdominis basi late rufo; capite thoraceque rufis; alis hyalinis. Long. 10—11 mm.

Hab. Missouri (*Rothney*).

Antennæ entirely black; the scape sparsely covered with long fuscous hairs; the flagellum with an obscure microscopic pile. Head covered with long pale fulvous hairs, more sparsely on the centre of the clypeus and of the vertex; the inner orbits of the eyes bordered with a band of pale fulvous depressed pubescence; the apex of the clypeus fringed with golden hairs; the clypeus sparsely; the inner orbits more closely punctured; the

vertex finely and closely longitudinally striated from the hinder ocelli, behind which it is smoother and shining; the occiput thickly covered with long pale golden hairs. The mandibles are piceous before the middle; the joints of the palpi are white at the base. Thorax bearing pubescence of moderate length; fulvous above; that on the pleuræ paler; finely punctured; a longitudinal furrow on either side of the mesonotum, a very indistinct one down the middle of the scutellum, which at the apex is fringed with long fulvous hairs. The middle of the median segment bearing a large somewhat triangular opaque shagreened space not uniting with the apex; the sides shining and smoother, and bearing long fulvous hairs; the apex being similarly clothed. The pleuræ shagreened, somewhat shining; the apex of the pro- and of the meta-pleuræ thickly covered with long pale fulvous hairs; the sternum sparsely covered with long pale fulvous hairs. Legs black; the hairs pale fulvous. Abdomen with the basal two segments ferruginous above and beneath; shining, impunctate, almost glabrous; the other segments black, their apices fringed with pale fulvous hairs; the hypopygium aciculated, the sides sharply bordered; the centre with an elongated raised space, sharply pointed towards the apex; the ventral segments covered, but not very thickly, with long fulvous hairs, which are longest towards the apex. Wings with a faint fuscous tinge; the nervures black.

Andrena communis Sm. ("North India, Masuri; taken at an elevation of 7,000 ft."), resembles this species in coloration; but it has the antennæ fuscous beneath; the apical margin only of the first abdominal segment is ferruginous, which colour also extends to the third. Both, as also the following species, resemble the European *Andrena cetti*. Smith points out this resemblance in regard to his *A. communis* (Descr. New Sp. Hym. p. 51).

ANDRENA MALIGNA, *sp. nov.*

Long. 9 mm. ♂.

Hab. Missouri (*Rothney*).

Agrees with *A. Rothneyi* generally in coloration; but the basal abdominal segment is only ferruginous at the apex, while the third is entirely ferruginous; the hairs on the head and thorax much thicker and longer and uniformly distributed; the pleuræ much more strongly punctured, the mesopleuræ also being obliquely striolated behind. Judging from the description it can hardly be the ♂ of *A. communis*.

Antennæ entirely black, the scape sparsely covered with long fuscous hairs; the flagellum opaque, almost glabrous. Head large, distinctly wider than the thorax; black; thickly covered with long fulvous hairs; the vertex except at the sides and behind, closely, somewhat obliquely, striated; the clypeus with large, clearly separated, punctures; tips of mandibles piceous. Thorax densely covered all over with long fulvous hairs; propleuræ deeply excavated; the mesopleuræ opaque; the base obscurely punctured, the apex obliquely striated; the base of the metapleuræ with a deep shining, oblique depression. Legs densely covered with long pale fulvous hairs. Wings hyaline, but with a distinct fuscous tinge; the first and second transverse cubital nervures are distinctly bullated at the base and apex and roundly curved, the third on the lower side. Abdomen thickly covered with longish fulvous hairs; the first segment black, except at the apex; the second ferruginous, except a black stripe before the apex; the third is entirely ferruginous; the apical three segments thickly covered with long fuscous hairs; the basal five ventral segments ferruginous; the two basal segments with a black line in the centre which bifurcates on the third to fifth; the sixth and seventh black; the seventh thickly covered with long fulvous hairs.

ANDRENA RETICULATA, *sp. nov.*

Nigra; capite thoraceque pallide fusco-hirsutis; metathorace reticulato; alis hyalinis, nervis fuscis. ♀. Long. 12 mm.

Hab. Missouri (*Rothney*).

Head black; covered with long cinereous hairs, except on the clypeus; and having them sparser on the front; the clypeus strongly punctured all over; the extreme apex transverse, shining, impunctate; immediately below the antennæ is a clearly defined space, a little longer than broad, the apex transverse, the sides straight, smooth, and shining. Mandibles deeply grooved; the tips piceous. Antennæ black, covered at the apex with a pale down. Thorax covered all over with pale fulvous hairs, which are paler and longer and thicker on the pleuræ and sternum. Mesonotum strongly punctured, the punctures in the middle more widely separated than on the sides; the scutellum punctured; the punctures smaller than on the mesonotum, and very sparse in the middle at the base; the base of the median segment with stout distinctly separated longitudinal striæ, those in the middle being more widely separated than those at the sides; the apex on either side of the central hollow, strongly transversely striated. Pleuræ with the punctures somewhat less in size than they are on the mesonotum. Femora covered with longish pale hair; the hair on the tibiæ and tarsi shorter and thicker, the spurs rufo-testaceous. Wings hyaline, the nervures blackish. Abdomen shining, impunctate; the segments narrowly lined with silvery hairs.

ANDRENA SÆVISSIMA, *sp. nov.*

Long. 12 mm. ♂.

Hab. Missouri (*Rothney*).

A larger and stouter species than *A. phædra*, which agrees with it in the structure of the median segment; but the present species differs from it in being larger and

stouter; the base of the median segment is more strongly reticulated, the central fovea larger and deeper; and the apex is strongly transversely striolated.

Head black; the front and vertex sparsely covered with long pale fulvous hairs; the clypeus almost bare; the vertex closely punctured; the clypeus with the punctures larger and more distinctly punctured below; projecting between the antennæ is a raised space, very smooth, shining, and triangular at the top; transverse at the bottom and with a few large punctures. Antennæ black, almost glabrous. Thorax densely covered with long pale fulvous hairs; the median segment at the base almost glabrous; the triangular space in the middle at the base aciculate, the apex shining, impunctate; the sides more strongly aciculated. Pleuræ shining, impunctate. The hairs on the femora fulvous; on the tibiæ and tarsi blackish: the middle tarsal joints testaceous. The wings have a decided fusco-violaceous tinge beyond the transverse basal nervure; the nervures and stigma in the centre fuscous; the tegulæ pale testaceous. The basal segment of the abdomen thickly covered with long pale testaceous hairs; the other segments thickly covered with black hairs, except at the apices which are fringed with white depressed hairs; the basal half of the ventral segments smooth, glabrous; the apical fringed with longish black hairs; the pygidium glabrous, shining, impunctate; the lateral furrows wide, covered all over with long pale fulvous hairs, closely and rather strongly punctured; the punctures larger and more widely separated towards the apex; the base of the scutellum almost impunctate; the base of the median segment with short stout keels; those at the sides being longer and sharply bent in the middle; the middle before the basal keels coarsely reticulated; in front of this again is a large, somewhat pear-shaped, shining, impunctate depression;

the rest of the segment is rugosely transversely punctured. The propleuræ have a dense curve of pale fulvous hair; the propleuræ below and at the junction with the mesopleuræ are widely furrowed, the furrow being transversely keeled. Legs thickly covered with pale hairs, which are darker on the hind legs. Wings clear hyaline; the nervures fuscous; the second cubital cellule at the bottom as long as the third; the first recurrent nervure is received very shortly beyond the middle; the second in the apical third of the cellule. Abdomen shining; the segments above and beneath lined with white depressed hair; the basal segment with a deep, wide, longitudinal furrow.

The present species agrees very closely with *A. reticulata*, but it may be known from it by the deep furrow on the basal segment of the abdomen, by the large shining, deep depression at the middle of the median segment; which in *A. reticulata* is smooth, shining, and without any depression.

ANDRENA MEPHISTOPHELICA, *sp. nov.*

Long. 11—12 mm.

Hab. Missouri (*Rothney*).

Is related to *A. sævissima*; but may be known from it by its smaller size; by the much stronger and closer punctation of the clypeus; by the hairs on the median segment being much longer, closer and fulvous in colour, differing from the hairs on the mesonotum, which are much paler.

Head, except on the clypeus, covered thickly with long hairs, pale beneath, darker on the front and vertex. Clypeus with large punctures, which are much sparser on the apex, its apex being almost clear of them and fringed with dark fulvous hairs; the base of the mandibles aciculate. The antennæ almost bare; the flagellum from the second joint brownish beneath. Pro- and meso-thorax

thickly covered with long pale fulvous hairs, the scutellum with only long hairs behind, and almost without punctures; the median segment, except a triangular space in the middle at the base, thickly covered with rufo-fulvous hairs, which completely hide the texture; the triangular bare space at the base opaque, rugosely aciculated; with an indistinct keel down its centre. The upper part of the propleuræ aciculated. Legs thickly covered with pale fulvous hairs; the calcaria white. Wings clear hyaline; the nervures dark fuscous; the first recurrent nervure is received shortly beyond the middle of the cellule; the second about the same distance from the third transverse cubital nervure. The first and second dorsal segments of the abdomen are covered with long pale fulvous hairs; the others have the hairs darker and shorter, and the second, third, and fourth are fringed at the apex with glistening white hairs; the ventral segments are broadly fringed at the apex with long pale hairs.

ANDRENA GRACILLIMA, *sp. nov.* (Pl. 4, f. 19).

Nigra; capite thorace abdominisque basi longe fulvo-hirtis; alis fumatis, basi fere hyalinis. ♀. Long. 15mm.

Hab. Missouri (Rothney).

Head deep black; the occiput thickly covered with long fulvous hairs; the front with hairs almost as long, but somewhat shorter. The front from the hinder ocelli closely longitudinally striated; a sharp keel runs down from the ocelli; the clypeus shining, the punctures close at the base, becoming more widely separated towards the apex; which is in the middle almost free from them; the apex slightly projecting. Antennæ black; the flagellum almost glabrous; the fifth and following joints brownish beneath. Pro- and meso-thorax and the median segment punctured; the scutellum with the punctures more widely separated, especially in the middle at the base; the

median segment has an oblique slope; the extreme base has short stout longitudinal keels; below this it is reticulated; the rest strongly transversely striolated. Pleuræ rather strongly punctured, covered with long pale hairs; the hairs on the metapleuræ longer and thicker. Legs black; thickly covered with pale fulvous hairs; those on the hind legs thicker and longer. Wings hyaline, the nervures dark fuscous; the first recurrent nervure received very shortly beyond the middle of the cellule. Abdomen shining; the segments fringed with white pubescence, above and beneath; the ventral segments more strongly punctured than the dorsal.

ANDRENA MOROSA, *sp. nov.*

Nigra; capite thoraceque longe pallide hirtis; abdominis basi ferrugineo-maculato; alis hyalinis. Long. 12—13 mm.

Hab. Missouri (*Rothney*).

Head, except the clypeus, thickly covered with long greyish hair; opaque, and coarsely alutaceous, the front closely longitudinally striated; the clypeus shining, almost glabrous, and bearing distinctly separated punctures; the labrum broadly and roundly incised at the apex. Thorax thickly covered with long greyish hairs, more sparsely on the mesonotum; the mesonotum and scutellum shining, almost impunctate. Median segment coarsely alutaceous; the base rugosely longitudinally striolated; the centre with a shallow longitudinal furrow; the sides bare, and apex thickly covered with long grey hairs. Pleuræ alutaceous, covered with long grey hairs. Legs, especially the hinder pair, thickly covered with long greyish hairs; those on the hind legs being darker; the calcaria white. Wings hyaline, but with a slight fuscous tinge, especially in front; the nervures fuscous. Abdomen shining, impunctate; the first and second dorsal segments at the apex piceous; the second to fourth segments at the apices

fringed with pale hairs; the fifth segment with the fringe thicker and longer and dark fulvous; the sixth segment similarly clothed at the sides; the hypopygium alutaceous; the centre triangularly raised, but not sharply. The second ventral segment rufous, black in the centre, the black mark being dilated at the apex; the third and fourth black, piceous at the base.

ANDRENA PHÆDRA, *sp. nov.*

Long. 8 mm. ♂.

Hab. Missouri (*Rothney*).

This species is very closely allied to *A. reticulata*, and has, like it, the base of the median segment reticulated; but its apex is not transversely striolated; while in its centre, below the reticulated part, is a deep, shining, impunctate, and somewhat triangular space; the widest part of which is at the base.

Head densely covered with long greyish hairs; closely rugosely punctured; the clypeus strongly punctured, with the punctures more widely separated; depressed at the apex and with very few punctures; the mandibles deeply grooved; their teeth piceous. Antennæ black, towards the apex with a fuscous down. Thorax densely covered with long pale fulvous hairs; the mesonotum and scutellum bearing large, clearly-separated punctures except the former in the middle at the apex and the latter at the base; the base of the median segment with a band of short longitudinal keels; and a second band of similar keels in the middle behind the first; and from the centre of this runs a short deep, shining, somewhat triangular depression; the rest of the segment rugosely punctured. Mesopleuræ with large punctures; a curved furrow above the middle; above which is a large, smooth, impunctate space; the part immediately below the wings being coarsely punctured; the metapleuræ closely rugose.

Legs covered with long white soft hairs; especially thick and close on the tarsi. Wings clear hyaline; the nervures dark fuscous; the second and third cubital cells at the bottom almost equal in length; the first recurrent nervure is received shortly before the middle; the second in the apical third. Abdomen with the apices of the segments fringed with white hairs; the basal segment sparsely covered with long white hairs; at its base is a deep triangular depression; the ventral segments shining; their apices fringed with white hair.

ANDRENA SODALIS, *sp. nov.*

Long. 8—9 mm.

Hab. Missouri (*Rothney*).

Agrees with *A. phædra* and *A. reticulata* in having the median segment reticulated at the base; from the former it may be known by there being a triangular keel and spot in the middle of the segment at the base, in which there is no deep triangular depression; from the latter by its smaller size and by the median segment not being transversely striated.

Head densely covered with long pale fulvous hairs, hiding the sculpture; the front and vertex finely and closely rugose; the clypeus strongly punctured, the punctures distinctly separated; the mandibles deeply grooved; their teeth piceous. Antennæ black; the apex with a microscopic down. Thorax above thickly covered with fulvous hairs; the sides and head with longish pale hairs; the mesonotum closely and rather strongly punctured, less closely in the middle towards the apex; the scutellum punctured pretty much as the base of the mesonotum, and covered with longer hairs. Median segment with an oblique slope; the base with a double row of short thick keels; below these is a large wide triangular shining reticulated space; the rest of the segment rugosely punc-

ured. Legs thickly covered with white hairs; the spurs white. Wings clear hyaline; the tegulæ sordid testaceous; the nervures dark fuscous; the second and third cubital cellules at the bottom subequal; the first recurrent nervure is received shortly beyond the middle; the second in the apical third. Abdomen black; the basal segment sparsely covered with long pale hairs; the others belted with white depressed hair at the apex; the ventral segments fringed with white hair; the apical bordered with piceous.

ANDRENA ANONYMA, *sp. nov.*

Long. 11—12 mm.

Hab. Missouri (*Rothney*).

Head black; the front and vertex covered with long pale hairs, the latter alutaceous, except at the top of the eyes, where it is smooth and shining; in front of this smooth space is a spot of dark fulvous hairs; the clypeus strongly punctured, especially towards the base, the apex broadly shining, smooth, with some widely separated punctures, the centre almost impunctate. Antennæ entirely black; the flagellum almost glabrous. Thorax covered with long fulvous hairs, which are paler on the pleuræ; the mesonotum and scutellum almost impunctate, shining; the median segment alutaceous, with a gradually rounded slope; at the base is a shallow indistinct longitudinal furrow. Legs thickly covered with pale hairs. Wings clear hyaline, the stigma and nervures fuscous; the first recurrent nervure is received in the middle, the second in the apical fourth of the cellule. Abdomen shining, smooth, impunctate, the segments fringed with white hairs at their apices; the apical segments thickly covered with fuscous to dirty white hairs; the ventral segments fringed with long white hair.

APIDÆ.

NOMADA CEYLONICA, *sp. nov.*

Ferruginea; capite thoraceque late nigro-maculatis; abdomine flavo-bimaculato; alis fuscis, basi fere hyalinis. ♀.
Long. fere 6 mm.

Hab. Ceylon (*Rothney*).

Head black; the orbits narrowly, the clypeus, mandibles except at the apex, ferruginous; coarsely punctured; the front and vertex covered with long fuscous, the face more thickly with shorter, white hairs; the apex of the clypeus shining, impunctate. Antennæ rufous; almost bare; the flagellum blackish above; the front projecting sharply between the antennæ. Thorax ferruginous, coarsely punctured, rather thickly covered with white hairs; a broad central and two narrower black continuous bands on the mesonotum; the metanotum entirely, the propleuræ, except at the top, the mesopleuræ below the tegulæ, under the wings, and at the apex (but the latter with a long ferruginous mark at the top), the metapleuræ and the sternum, black. The curved furrow in front of the middle coxæ is deep, and the part enclosed by it is much less strongly punctured than the rest of the sternum. The scutellum is strongly punctured and longitudinally depressed down the middle; the post-scutellum is of a paler colour. The median segment is entirely black; the basal area almost rugose; the sides at the front of it very thickly covered with long white hairs. Legs rufous, covered with white hairs; the greater part of the hinder coxæ, the base of the hinder femora, above and beneath, and the hind tarsi, black. Wings fuscous, paler at the base; the stigma fuscous, lighter in the centre. Abdomen shining, impunctate; black. The first segment with a dull ferruginous band before the apex; the second segment

dull ferruginous, black in the centre and with a large yellow mark at the side; the ventral surface ferruginous, marked with black.

A form of what is no doubt the same species has only the central line on the mesonotum black; the median segment broadly black only down the middle; the pleuræ and sternum without black; the abdomen above almost entirely black, except the yellow marks, and the hinder femora without black.

ANTHIDIUM FLAVIVENTRE, *sp. nov.*

Flavum, nigro-maculatum; vertice nigro, flavo-maculato; pedibus flavis; alis hyalinis. Long. 5 mm.

Hab. Poona (*Wroughton*).

Head yellow, the vertex from the antennæ to shortly behind the eyes, the black surrounding them entirely narrowly behind; on the vertex is a large yellow mark, broader than long, in the centre between the antennæ and the ocelli; strongly punctured, sparsely covered with white pubescence. Mandibles yellow, the teeth black. Antennæ black, shining, the flagellum obscure brownish beneath. Thorax black, strongly punctured; a large mark in front of the tegulæ; on each side of the mesonotum at the base is a thick straight line which curves round the tegulæ to their end; on each side of the median segment is a large yellow mark, obliquely truncated at the apex, leaving a somewhat triangular black mark in the middle at the base, the apex of the median segment transverse, the sides oblique. Pleuræ coarsely punctured; behind covered with white hairs. Legs yellow, thickly covered with white hairs, the hinder femora broadly black at the base. Wings infuscated at the apex; the nervures black. Abdomen above black, coarsely punctured; on the basal five segments are broad yellow lines, which become gradually broader until, on

the sixth, they almost unite; ventral surface lemon-yellow, rugose, thickly covered with short white hairs.

STELIS PARVULA, *sp. nov.*

Nigra; dense albo-hirsuta; tegulis abdomineque albo-maculatis; alis hyalinis. Long. 4 mm.

Hab. Barrackpore (*Rothney*).

Head thickly covered with longish white hairs; the rest of the head covered with similar hair; but not so thickly; the tips of the mandibles piceous; punctured. Antennæ with the scape covered closely with moderately long pubescence; the flagellum with a microscopic pile. Pronotum finely, the mesonotum coarsely, punctured; the pronotum in front fringed with long white hair; the mesonotum in front is also fringed with long white hair; the rest of it has the pubescence sparser and shorter; the scutellum nearly as strongly punctured as the mesonotum; its apex entire, rounded; its sides broadly white. Mesopleuræ thickly covered with white hair; the propleuræ slightly pilose; the meta- as thickly haired as the meso-pleuræ; the base of the median segment thickly covered with long white hairs; its apex hardly pilose. Legs black; thickly covered with long white hairs, the knees and apices of the tarsi rufous; the calcaria yellowish-white. Wings clear hyaline; the nervures fuscous; the stigma darker; tegulæ large, yellow, a large black mark in the centre. Abdomen thickly covered with white hairs, especially towards the apex; the sides of the segments with longish, moderately broad yellow marks; the basal two segments narrowly lined with yellow; the third to fifth segments bear two elongated yellow marks; the apical segment has an elongated mark at the sides, and two somewhat roundish ones in the centre. Ventral segments thickly covered, especially at the apices, with long white hairs; their sides lined with yellow.

COELIOXYS.

The species of this genus known to me from India may be separated as follows:—

- 1 (6) Thorax coriaceous, the punctures not distinctly separated.
- 2 (5) With metanotal spines.
- 3 (4) The metanotal spines long, sharp, curved.
basalis
- 4 (3) The spines short, blunt, straight, wings subhyaline.
apicalis
- 5 (2) Without metanotal spines.
argentifrons
- 6 (1) Thorax coarsely punctured, the punctures distinctly separated.
- 7 (8) Thorax with six marks of white pubescence, the scutellum much more finely and closely punctured than the mesonotum.
sexmaculata
- 8 (7) Thorax not maculate, the scutellum not more coarsely punctured than the mesonotum.
- 9 (10) Apex of scutellum projecting in the middle.
fuscipennis
- 10 (9) Apex of scutellum almost transverse, not projecting in the middle.
confuscus, cuneatus

COELIOXYS SEXMACULATA, *sp. nov.*

Long. 11 mm. ♀.

Hab. Barrackpore (*Rothney*).

Head in front densely covered with white pubescence, which is thicker at the sides; the orbits behind except at the top with similarly coloured hairs; the vertex and front strongly punctured. Antennæ black, almost glabrous. Pronotum strongly punctured, lined with white pubescence; mesonotum more coarsely punctured; the scutellum more closely and finely punctured; there are two white spots on the base of the mesonotum, two on

the base of the scutellum, and a smaller one behind the tegulæ. Scutellar spines stout. Mesopleuræ and meta-pleuræ thickly covered with white pubescence; strongly punctured. Wings fuscous; more lightly coloured at the base. Legs black; the tarsi beneath thickly covered with golden pubescence; the spurs black. The basal segment closely and rather strongly punctured, margined with silvery white pubescence; the transverse furrow on the second and third segments rugose; the apical segment above closely punctured, keeled down the centre; the keel indistinct at the base, becoming thicker towards the apex, where it is depressed on either side of it. The ventral segments punctured; a band of white pubescence down the centre of the basal; the others transversely banded with silvery pubescence.

Comes near to *C. fuscipennis*, but that species wants the white marks on the mesonotum, which has also the punctures more distinctly separated, this being especially noticeable on the scutellum, where they are round and deep, and not, or hardly, touching each other, whereas in *C. sexmaculata* they are much coarser and closer, forming a rugose surface.

ANTHOPHORA DEIOPEA, *sp. nov.*

Nigra, longe dense pallide hirta; capite nigro ♂ facie alba. Long. 13 mm. ♀.

Hab. Missouri (*Rothney*).

Head black, thickly covered with long pale grey hairs, especially on the front and vertex; the labrum fringed with golden hairs; the mandibles ferruginous, black at the apex. The vertex behind the front ocellus bare, shining, broadly depressed. Thorax thickly covered with long grey hairs all over. Legs: the femora and tibiæ dark rufous; the former sparsely covered with long white hairs, the front four tibiæ covered densely behind with

pale fulvous hairs; the hairs on the hinder tibiæ much longer, thicker, and of a brighter fulvous tint; the tarsi rufous, thickly covered with long golden hairs at the base. Wings hyaline, with a faint fuscous tinge; the costa and nervures blackish; the first recurrent nervure is received shortly before the second transverse cubital nervure; the second is interstitial. Abdomen above and at the sides thickly covered with long pale fulvous hairs; the penultimate segment rufous at the apex; the apical ferruginous, black at the apex, the base closely transversely striated; the sides, especially towards the apex, broadly furrowed; abdominal segments black, the base and apex broadly ferruginous; the segments at the apices thickly fringed with fulvous hairs.

The ♂ is covered all over with long hoary hairs; the clypeus, except at the sides and the inner orbits, cream-yellow; the extreme apex piceous, the mandibles cream coloured; the tips black, ferruginous in front of the black; the labrum black, covered with white hairs; the ventral segments are coloured as in the ♀; this being also the case with the legs, which bear long white hairs.

MEGACHILE SAMSON, *sp. nov.*

Nigra; thorace abdominisque basi rufo-hirsutis; alis fusco-violaceis. ♂. Long. 25 mm.

Hab. Himalayas.

Head deep velvety black, opaque, coarsely alutaceous, thickly covered with black hairs, which are longest and thickest on the front and at the base of the clypeus, which is short, coloured and haired like the vertex, and projecting in the middle into a stout, large, somewhat triangular thickly-haired tooth; its apex shining, and smooth at the sides; the labrum large, as long as the space between the ocelli and the apex of the clypeus,

covered with a dull golden down and with some long black hairs; its apex bearing much longer hairs. Mandibles very large, opaque, the middle above with some elongated punctures and elongated striæ; the apical tooth large; the basal rounded in the middle. Antennæ black, glabrous. Thorax opaque, closely rugosely punctured; above thickly covered with rufous hair, this being also the case on the upper part of the pleuræ; the hairs on the lower part are much darker; on the sternum fulvous, the latter broadly depressed in the middle at the base. Wings smoky, darker and more violaceous at the apex; the base with a slight yellowish tinge; the costa, stigma, and nervures black; the last with a yellowish tinge in the middle of the wing; the recurrent nervures are both received at the same distance from the transverse cubitals. Legs thickly covered with stiff black hairs; the anterior four tibiæ end above in a large stout somewhat triangular process, which ends in a small curved point. The basal abdominal segment broadly depressed in the middle above; the sides, base, and apex thickly covered with rufous hairs; the second segment depressed at the base, fringed with fulvous hairs, this being also the case with the third at the sides; the second and following segments thickly covered with stiff black hairs. Ventral surface thickly covered with long stiff black hairs. The hinder calcaria are short and thick.

This *Megachile* is, next to *M. Pluto* Sm. (from Bachian), the largest of the species from the Oriental Region. Smith's species is 18 lines in length, that being however the length of a ♀, the only sex known to its describer (*Trans. Linn. Soc., V., 1860, 133*). Our species is also apparently related to *M. monticola* Sm., but I cannot make it agree with Smith's description.

MEGACHILE HORNEI, *sp. nov.*

Nigra; facie longe fulvo-hirta; pedibus anticis rufotestaceis, alis fumatis. ♂. Long. 17 mm.

Hab. Missouri (*Rothney*).

Head large; below the antennæ and the orbits to the ocelli, densely covered with long fulvous hairs. Mandibles black, covered with long fulvous hairs, and with large clearly separated deep punctures. Antennæ black; the scape closely punctured. Thorax black, closely and rather strongly punctured; the pronotum and prosternum thickly covered with long fulvous hairs; the rest of the thorax thickly covered with black hairs, that on the mesonotum shorter, on the median segment as long as the fulvous hairs on the pronotum. On the base of the median segment is a dull impunctate area dilated into a sharp point in the middle; the rest alutaceous, obscurely punctured; the pleuræ opaque, obscurely punctured, thickly covered with long black hair. Legs: the anterior femora and tibiæ, the base of the middle femora and the lower part of the middle tibiæ in front, fulvo-testaceous; the anterior four tarsi thickly covered with pale fulvous hairs; the hinder tarsi covered with longer, thicker, and whiter hair. Wings at the apex fuscous, with a faint violaceous tinge, lighter below the stigma and at the base. Abdomen black; above closely punctured, thickly covered with black hairs, very long at the base and the apex; the base semicircularly incised; its apex very smooth, shining, and with a bluish tinge; a narrow furrow extends from the middle to the base; the apical dorsal segment deeply incised in the middle; the apex flat; triangularly incised in the middle. The ventral segments fringed with short fulvous hairs at the apex; the apical segment depressed, coarsely punctured, covered at the base with long fulvous hair.

Allied to *M. anthracina* Sm.=*M. fasciculata* Sm., ♂ cf., Horne and Smith (*Trans. Zool. Soc. vii.* (1872), p. 179). The fore coxæ are sharply triangularly produced in front.

MEGACHILE SYCOPHANTA, *sp. nov.*

Nigra; capite thoraceque longe cinereo-hirtis; abdomine subtus longe albo-hirto; alis hyalinis. ♀. Long. 13—14mm.

Hab. Missouri (*Rothney*).

Head thickly covered with long hairs; fulvous above, cinereous below the antennæ. Clypeus coarsely punctured; a shining, impunctate longitudinal line down the middle; the teeth on the mandibles blunt, rounded; the inner side of the mandibles smooth; the rest irregularly striated and punctured; the lower side bearing long golden hair. Antennæ black, shining, smooth. Thorax closely and rather strongly punctured; the mesonotum (but very sparsely in the middle) with long pale fulvous hair; the scutellum almost impunctate, the post-scutellum fringed with long pale fulvous hairs; the pleuræ and sternum punctured like the mesonotum and covered with long white hairs. Legs black; the hairs of the tibiæ and tarsi on the inner side thick, deep golden; on the rest of the legs the hairs are longer, sparser, and pale silvery; the calcaria pale. Wings hyaline, the nervures blackish. Abdomen closely punctured, the basal segments thickly covered with long pale fuscous hairs; the third and following segments fringed with short silvery hairs, the third and fourth deeply depressed; the last segment coarsely and closely rugose; the ventral scopa apparently white, but the colour hidden by reddish pollen.

The ♂ is similarly coloured to the ♀; there is no spine before the front coxæ; the apical abdominal segment has no spines; it is broadly and roundly incised; this being also the case with the fourth, and, to a less extent, with the third segment; above the apical segment is depressed at the apex.

MEGACHILE IMPLICATOR, *sp. nov.*

Nigra, longe fulvo-hirta; alis hyalinis, apice fumatis. ♂.
 Long. 9 mm.

Hab. Missouri (*Rothney*).

Antennæ black, the scape with fulvous hairs; the flagellum almost bare. Head densely covered all over with long fulvous hairs, being especially thick and long on the face and vertex. Mandibles entirely black, coarsely punctured at the base, where they have a few fulvous hairs. Thorax thickly covered all over with long fulvous hairs; the mesonotum strongly and closely punctured. Legs thickly covered all over with long pale hairs; those on the under side of the hinder tarsi inclining to fulvous; the claws piceous. The wings are almost hyaline to the end of the radial cellule, when they become fuscous; the tegulæ black. Abdomen black; the basal segment at the apex thickly; the second and third more narrowly fringed with long fulvous hairs; the apical segments with long black hairs; the ventral segments fringed at the apices with long white hairs; the apical broadly and roundly incised.

The anterior four coxæ and the base of the femora are strongly punctured; the apex of the latter very smooth and shining and with a piceous tinge.

Comes near to *M. lanata*; but, apart from the difference in coloration, the latter may be known from it by the strongly rugosely punctured pleuræ and sternum.

MEGACHILE ALBOLINEATA, *sp. nov.*

Nigra; abdomine albo-lineato; femoribus posterioribus rufis; alis hyalinis. ♀. Long. fere 10 mm.

Hab. Ceylon (*Rothney*).

Head rather closely punctured; the inner and outer orbits of the eyes broadly covered with white hairs; the

clypeus projecting; smooth, shining, impunctate, and slightly notched at the apex; mandibles coarsely punctured, their lower edges smooth, shining, and impunctate, and fringed with long golden hairs. Mesonotum strongly punctured, thickly covered with long fuscous pubescence; the sides, base, and apex of the tegulæ thickly with long white hairs. Base of median segment shining, impunctate; the rest of it closely punctured, and covered with long white hairs. Femora on the lower side sparsely covered with soft white hairs; the tibiæ more thickly; the tarsi still more thickly covered with fulvous pubescence, especially the hinder four. Wings clear hyaline, the nervures and stigma black. Abdomen above rather strongly and closely punctured, black; the segments at the apex densely fringed with white pubescence; the transverse furrows on the second and third segments deep, shining, impunctate. Ventral fringe long; clear white.

MEGACHILE MALIGNA, *sp. nov.*

Nigra; femoribus rufis; abdominis scopa fulva; alis hyalinis. ♀ et ♂. Long. 8—9 mm.

Hab. Missouri (*Rothney*).

Head black, the front and face thickly covered with long pale fulvous hair; the vertex closely punctured, the hairs much sparser and of a deeper fulvous tint. Mandibles strongly punctured, thickly covered at the base with long pale fulvous hairs; the apical two teeth stout; the part at their base piceous. Antennæ entirely black. Thorax coarsely alutaceous, thickly covered with white hairs, which are especially long on the sides and mesonotum, where they are of a paler tint. Median segment alutaceous, its slope rather abrupt. The fore femora black; the lower side entirely and the upper side at the base above, and the hinder four pairs, rufous; the tibiæ

and tarsi thickly covered with white hairs, which have a fulvous tint on the metatarsus; the spurs pale testaceous; the apex of the hinder tibiæ piceous on the outer side. Abdomen black; above closely punctured; the segments fringed with silvery pubescence; the scopa pale fulvous; the basal ventral segment rufous.

The ♂ is similarly coloured to the ♀; except that the ventral segments are rufous, except the apical one, which is depressed broadly in the middle, and cleft slightly and roundly; on either side are three stout teeth, which become successively, but not much, shorter. On the sternum in front of the fore coxæ are two stout projecting plates, curved on the inner side, straight and slightly oblique on the outer.

MEGACHILE PULCHRIPES, *sp. nov.*

Nigra, longe argenteo-pilosa; coxis, trochanteribus, femoribus tibiisque posticis, rufis; alis hyalinis, stigmatate fusco. ♀. Long. 6 mm.

Hab. Missouri (*Rothney*).

Head coarsely punctured; the inner orbits thickly covered with white depressed pubescence; the rest of the head sparsely covered with fuscous hairs; the labrum bears some long golden hairs; a straight keel runs from the base of the antennæ to the apex of the clypeus, the part on the latter being the thinner; the mandibles furrowed on the lower side; the teeth piceous; the apical two large. Antennæ black, shining, smooth. Thorax coarsely punctured; the scutellum more strongly than the mesonotum; the scutellum at the sides projecting into triangular teeth at the apex; the rest of the apex rounded, sparsely pilose; the edge of the pronotum and the base of the scutellum thickly covered with white hairs. The median segment sharply oblique, its sides thickly covered with white woolly hairs. Propleuræ finely and closely

punctured; the mesopleuræ with the punctures much larger, those at the top being more widely separated and larger; the top, base, and apex thickly covered with white hairs. Legs thickly covered with white hairs, especially the tarsi; the base and apex of the fore femora; the hinder four femora entirely, the apex of the hind coxæ, the apex of the middle trochanters and the hinder trochanters, the hinder tibæ and the hinder tarsi broadly at the base, rufous; the hinder tibæ and base of tarsi strongly punctured; the lower part of the metatarsus covered thickly with long golden hairs; the calcaria pale golden. Abdomen closely punctured; the segments fringed with silvery hairs; interrupted on the basal segment; the abdominal segments strongly punctured; the scopa pale fulvous. Wings clear hyaline, the nervures and stigma fuscous.

MEGACHILE PARVULA, *sp. nov.*

Nigra, dense albo-pilosa; alis hyalinis, nervis nigro-fuscis. ♀. Long. fere 6 mm.

Hab: Mussouri (*Rothney*).

Front and vertex strongly punctured, the former not so strongly as the latter; the clypeus more closely and not quite so strongly punctured as the front; the vertex covered with long fuscous hairs; the inner orbits and the clypeus more thickly with white pubescence, especially the orbits; the clypeus slightly projecting; its apex curved; the labrum thickly fringed with golden hairs; the mandibles closely punctured; the apical three-fourths deeply furrowed; the two stout teeth rufous. Antennæ shining, almost glabrous. Thorax strongly punctured; the pronotum and the sides of the mesonotum fringed thickly with white hairs; the post-scutellum covered with much longer hairs. The base of the median segment with short stout longitudinal keels all over; those at the sides more widely separated and a little longer; the apex

smooth, shining, impunctate, glabrous at the top; the rest of it obscurely punctured and sparsely covered with white hairs. Pleuræ coarsely punctured, and covered with long white hair; a shining, impunctate, semi-oblique furrow on the lower three-fourths of the mesopleuræ at the apex; the base of the metapleuræ finely and closely punctured. Legs thickly covered with white hairs; those on the under side of the hinder tarsi fulvous; the calcaria fulvous; the claws rufous. Wings clear hyaline; the nervures and stigma dark fuscous. Abdomen closely punctured; the base smooth and shining; the segments fringed with white hairs; the ventral scopa fulvous.

MEGACHILE CHRYSOGASTER, *sp. nov.*

Nigra; capite thoraceque albis; abdomine subtus longe aureo-hirto; alis hyalinis. ♀. Long. 7 mm.

Hab. Mussouri (Rothney).

Head strongly and closely punctured; the vertex sparsely, the front more thickly covered with long fuscous hairs; the sides of the clypeus and between the antennæ thickly covered with long white hairs; the mandibles coarsely punctured, their lower side fringed with long golden hairs. Antennæ shining, the scape slightly pilose; the flagellum glabrous. Mesonotum rather strongly punctured; sparsely covered with long fuscous hairs; the scutellum with the punctures larger and more widely separated; its apex fringed with long white hairs (longer than those on the mesonotum). The base of the median segment is coarsely crenulated, the edge being stoutly keeled; the apex with a sharp abrupt slope, and covered with long white hairs. Pleuræ strongly punctured, thickly covered with long white hairs. Abdomen shining; the basal segment with an abrupt, very slightly concave, slope; the top at the base with a distinct raised margin, the part behind this being depressed and crenulated. The

other segments covered with shallow clearly separated punctures; the basal segments bare; the apical thickly covered with silvery pubescence, especially at their apices; ventral hairs dense, aureo-fulvous; the apical segment strongly punctured, fringed at the apex with pale fulvous hairs. Legs stout, covered with long white hairs; the anterior femora and tibiæ strongly punctured, the tibiæ almost rugose; the tarsi densely covered with long golden hairs. The wings clear hyaline; the nervures black; the tegulæ black, edged with white in front; shining, impunctate.

CERATINA PROPINQUA, *sp. nov.* (Pl. 4, f. 20).

Cærulea; clypeo, geniculis tarsisque albis; alis hyalinis.
♀. Long. 4—5 mm.

Hab. Missouri (*Rothney*).

Head blue, an elongated shining impunctate white mark, rounded at the top, a little dilated at the apex, on the clypeus; the front in centre broadly carinate, the apex however of it being sharply margined, and from the ocelli a curved shining keel runs into it from either ocellus; the front and vertex very finely punctured; the face on either side of the white mark with large irregular punctures, which are continued up in a single row along the inner orbits. Antennæ black, brownish beneath. Mesonotum closely and finely punctured, shining; the scutellum more closely and finely punctured; the median segment finely and closely punctured, shining, except in the middle at the base; the pleuræ closely punctured. Legs thickly covered with white hairs; the anterior femora at the apex above and more broadly beneath, and the tibiæ and tarsi white; the tibiæ for the greater part fuscous behind; the hinder tibiæ fuscous, white at the base. Wings clear hyaline, the nervures fuscous, the stigma darker; the first and second transverse cubital

nervures roundly curved and meeting closely at the top, where they are separated by about the space bounded by the first recurrent and second transverse cubital nervures; the third cubital cellule at the top is twice the length of the space bounded by the second recurrent and third transverse cubital nervures. Abdomen closely shagreened, shining and impunctate at the apices of the segments above and beneath.

Differs from the other green and blue species by the very much less strongly punctured head and thorax.

CERATINA TAPROBANÆ, *sp. nov.*

Viridis; abdomine nigro, late flavo-balteato; pedibus flavis; alis hyalinis. Long. fere 4 mm.

Hab. Ceylon (*Yerbury*).

Head green, shining, sparsely covered with pale hairs, clypeus, labrum, mandibles, and palpi pale yellow; the clypeus with two black lines. Scape of the antennæ yellow; the flagellum yellow beneath, black above. Thorax green, the scutellum dark purple; the metanotum of a darker green than the mesonotum, coarsely alutaceous; the pleuræ green, very finely punctured; the edge of the pronotum and the tubercles lemon-yellow. Legs yellow; covered densely with white hairs; the coxæ, trochanters, the basal third of the anterior femora; the basal half of the middle, and the basal fourth of the hinder, black. Wings hyaline; the stigma and nervures pallid testaceous; the recurrent nervures are almost interstitial. Abdomen pallid yellow; the second and third segments broadly black in the middle; the others broadly black at the base; the ventral segments broadly banded with black.

CERATINA BEATA, *sp. nov.*

Nigra, flavo-maculata; alis hyalinis. Long. fere 5 mm.

Hab. Trincomali, Ceylon (*Yerbury*).

Head shining, impunctate, glabrous, lemon-yellow; a broad black line runs down to the mandibles, curving round the side of the clypeus, and continued broadly upwards till it joins a broad black mark on the vertex, enclosing two yellow marks joined at the apex above the antennæ, these two yellow marks being joined to the lower yellow one by a narrow line between the antennæ; the inner orbits are yellow; behind the eyes is a broad yellow line which reaches near to the base of the mandibles, nearing the eyes as it does so; on the top of the occiput is a yellow line dilated in the middle; the vertex behind the eyes has large shallow punctures; the mandibular teeth black. Antennæ black, rufo-testaceous beneath; the scape having a yellower line. Prothorax yellow; the mesonotum black, with two yellow longitudinal lines in the centre and two narrower ones at the sides, neither reaching the base nor apex; its base obscurely punctured. Scutellum and post-scutellum yellow; the sides and apex of the median segment shagreened. Mesopleuræ closely punctured, yellow, except a broad line, below the wings and round the apex; the metapleura black; under the wings is a raised shining spot. Legs entirely lemon-yellow; thickly covered with white hairs. Abdomen yellow, shining, minutely punctured, the segments broadly black at the base; the ventral surface yellow.

CERATINA MODERATA, *sp. nov.*

Nigra; labro, clypeo, basi tibiærum, lineisque abdominis, flavis; alis hyalinis. Long. 5 mm.

Hab. Missouri (*Rothney*).

Black; the labrum, clypeus, a curved line on the face close to the eyes and between the antennæ, the dilated

yellow mark on the clypeus, and a transverse mark roundly dilated in the middle above, yellow. Front and vertex sparsely covered with long fuscous hairs; the face below the antennæ with three irregular rows of round punctures; the front depressed sharply between the antennæ and with a row of punctures between the furrow, the orbits above bordered with a row of punctures; the vertex punctured, except at the sides of the ocelli, the punctures large, clearly separated. Antennæ black, shining, the scape sparsely clothed with long white hair; the flagellum bare. Thorax shining, rather closely covered with white pubescence, which is darker in front than it is at the apex; the apex of the pronotum broadly yellow; the mesonotum shining, bearing widely separated shallow punctures; the scutellum minutely punctured. The base of the median segment has an elongated finely rugose area, bordered with a shining, impunctate space, the rest of the segment obscurely shagreened, and with an indistinct shallow narrow furrow down the middle; the propleuræ shining, the mesopleuræ with large, widely separated punctures; the metapleuræ alutaceous. Legs black, thickly covered with long white hairs; the lower apical half of the fore femora, the front four tibiæ before, the hind tibiæ also, but with a black line in the centre, bright yellow; the tarsi covered thickly with long white hairs; the front pair inclining to testaceous. Wings clear hyaline, the nervures testaceous; the first transverse cubital nervure is oblique; the second gradually curved towards it at the top; the second cubital cellule at the top is not half the length of the third; the first recurrent nervure is received slightly less than the length of top of the second cubital from the second transverse cubital nervure. Abdomen shining at the base, the rest more opaque, shagreened, and clothed closely with white hair; the ventral segments closely punctured.

CERATINA ORNATIFERA, *sp. nov.*

Long. 8 mm.

Hab. Missouri (*Rothney*).

Very similar to *C. hieroglyphica*, but with the legs entirely black, except a yellow line on the tibiæ.

Head shining, sparsely covered with long fuscous hairs; the vertex with scattered punctures; a depression, narrowed towards the apex, in front of the anterior ocellus; the sides of which are flat, shining, and bear a row of punctures, there being a row of three inside of it at the apex; there is a sharp keel between the antennæ, from which the sides slope sharply and are punctured. The clypeus has widely separated punctures, except in the centre; the labrum is rugosely punctured. Antennæ entirely black, smooth, shining, the scape with a few long fuscous hairs. On the clypeus, extending from the base to the apex, is a broad yellow mark, which at its apex extends on either side to the base of the mandibles, where it is bounded by a curved furrow; on each side of the central yellow mark is a yellow mark with its apical half broadened on the inner side; and over the central yellow mark is a broad curved one which extends beyond its sides, and there are two oblique broad lines, narrowed at base and apex behind the eyes; above the antennæ are two yellow marks wider than long. Thorax black, shining; the pronotum with a broad line on either side in the centre; the tubercles, the apex of the tegulæ and a broad slightly curved mark on the scutellum, yellow; the scutellum slightly punctured at the base and apex; the median segment coarsely shagreened; the base flat, more shining in front laterally. The propleuræ at the top shining, smooth; the rest closely and strongly longitudinally shagreened; the mesopleura and sternum with large distinctly separated punctures; the metapleuræ at the base closely punctured, the rest coarsely shagreened.

Legs thickly covered with long pale hairs; a mark on the under side of the fore femora; the tibiæ above yellow, the yellow becoming successively longer, but not reaching to the apex; the hairs on the hind tibiæ and tarsi very long and thick. Wings clear hyaline; the nervures and stigma fuscous; the top of the second cubital cellule is as wide as the space bounded by the first recurrent and the second transverse cubital nervures. Abdomen shining, smooth; the basal segment above, with a deep wide somewhat triangular depression, but with the apex rounded; on the apex of the basal segment is a yellow line, intersected by two square black marks, the second, third, and fourth segments bordered with yellow, which is dilated at the sides. Ventral segments strongly and closely punctured, lined with yellow at the apices and covered with long white hair.

The ♂ is similar; but with the yellow markings larger; there is a curved yellow mark on the mesonotum near the scutellum and two long narrow ones down the sides; the yellow line behind the eyes much larger; that on the scutellum much larger and dilated widely in the middle at the apex; the yellow on the anterior four tibiæ and tarsi more extended; and the yellow bands on the abdomen are broader above and beneath.

ANTHOPHORA ROTHNEYI, *sp. nov.*

Nigra, longe pallide hirta; abdomine pallide argenteo-fasciato; scapo antennarum, mandibularum basi oreque flavis; clypeo nigro-bimaculato; alis hyalinis, nervis nigris.
♀. Long. 10—11 mm.

Hab. Missouri (*Rothney*).

Head densely covered with hoary hairs, longest and thickest on the top; the labrum and clypeus yellow, obscurely punctured; the two marks on the clypeus are dilated at the apex and reach from the base to shortly

beyond the middle. Antennæ black, the scape yellow beneath, sparsely covered with long white hairs. Mandibles yellow, the apex black. Thorax covered, except on the scutellum, with long hoary hair; the scutellum closely and rather finely punctured, except in the middle. Legs black; the femora sparsely in front bearing white hairs; all the tibiæ in front and the four front tarsi in front thickly covered with silvery white hairs; the hinder tarsi thickly covered with black stiff hairs. Wings clear hyaline; the nervures black; the second cubital cellule at the top is as wide as the space bounded by the first transverse cubital and the first recurrent nervure; the second recurrent nervure is almost interstitial. Abdomen black; the ventral segments more or less piceous; the dorsal segments fringed with depressed silvery hair.

The ♂ wants the black marks on the yellow clypeus; the flagellum is brownish beneath; the apical ventral segment is deeply furrowed down the middle, and the sides are also deeply and more widely furrowed; the bounding keels being acute, stout; the space between them in the centre slightly hollowed.

Agrees with *A. cincta* in form and general coloration; but is smaller; the hairs on the head and thorax hoary, not fulvous; and the fasciæ on the abdomen are pale silvery, not blue.

SOCIALES.

TRIGONA BENGALENSIS, *sp. nov.*

Nigra, nitida; antennis flavo-testaceis; abdominis basilate brunneo; alis hyalinis. ♀. Long. 3 mm.

Hab. Barrackpore (*Rothney*), in old tree stumps.

Head black, shining, the face thickly covered with white pubescence, the mandibles and palpi rufo-testaceous. Antennæ entirely rufo-testaceous. Thorax shining, impunctate; the pleuræ thickly covered with long white

hairs, but more sparsely in the middle; the mesonotum sparsely covered with longish fuscous hairs; the semicircular depression at the base of the scutellum deep; the scutellum fringed with long fuscous hairs at the top and at the apex behind, the latter oblique, projecting at the top; the median segment very smooth, shining, glabrous, rounded. Legs covered with white hairs, shining, the apical four joints of the tarsi testaceous; the hinder femora and tibiæ have a piceous tinge. Wings clear hyaline, the stigma pallid-testaceous; the radial nervure complete; the cubital only extending to the middle of the second cubital cellule; the two transverse cubital nervures very faint, almost obsolete.

Explanation of Plates.

PLATE 3.

- Fig. 1. *Ichneumon clotho*.
 „ 2. *Ichneumon Rothneyi*.
 „ 3. *Rothneyia Wroughtoni*.
 „ 4. *Pimpla nepe*.
 „ 5. *Bracon ceylonicus*.
 „ 6. *Bracon agragensis*.
 „ 7. *Spinaria nigriceps*.
 „ 8. *Epyris amatorius*.
 „ 9. *Chalcis bengalensis*.
 „ 10. *Temnata maculipennis*.

PLATE 4.

- Fig. 11. *Methoca* ♂ *rugosa*.
 „ 12. *Methoca* ♀ *bicolor*.
 „ 13. *Mutilla ædipus*.
 „ 14. *Mutilla Rothneyi*.
 „ 15. *Pison* (*Parapison*) *Rothneyi*.
 „ 16. *Cemonus fuscipennis*.
 „ 17. *Rhynchiium basimacula*.
 „ 18. *Halictus tardus*.
 „ 19. *Andrina gracillima*.
 „ 20. *Ceratina propinqua*.

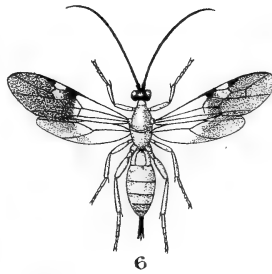
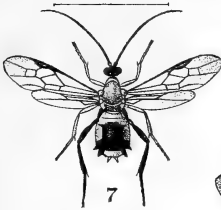
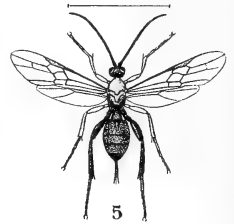
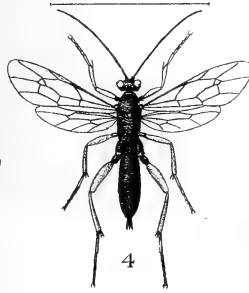
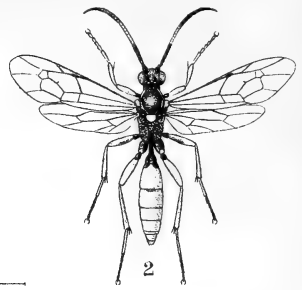
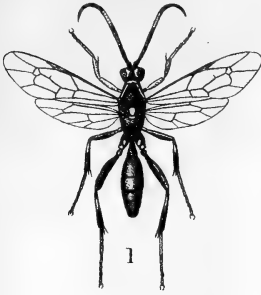

W. Purkiss. del. et lith.





12



11



13



14



15



16

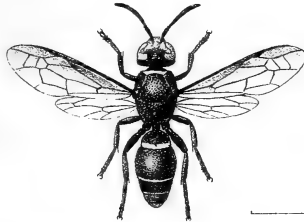

17



18

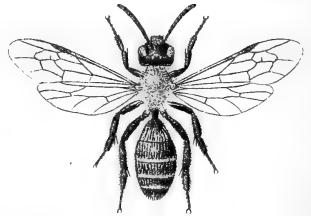

19



20

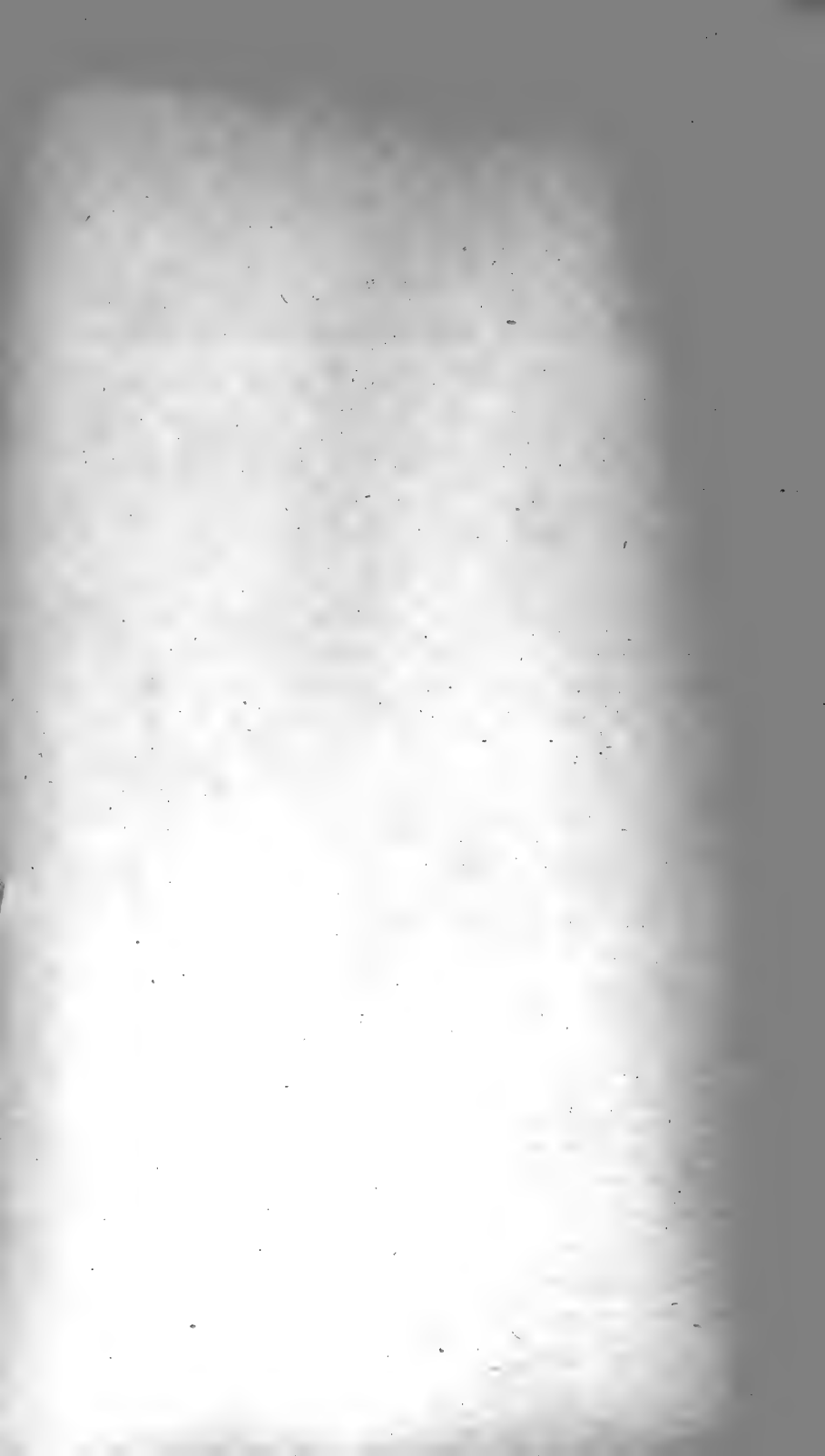

V. On the Ampullæ in some specimens of *Millepora*
in the Manchester Museum.

By SYDNEY J. HICKSON, M.A., D.Sc., F.R.S.

Received December 15th. Read December 15th, 1896.

In 1884, Quelch called attention to certain cavities in the superficial coenenchym of *Millepora Murrayi*, from Samboangan, which he called "Ampullæ," and considered to be of the same nature as the ampullæ of the Stylasteridæ.

In 1890, I was fortunate enough to obtain some spirit specimens of this species from Professor Haddon, and I found that each ampulla contains a curious male medusiform gonophore, in different stages of development.

As this was the first intimation of the presence of medusæ in the group of the Hydrocorallinæ, and the medusæ were only males, I have been for some time collecting specimens of *Millepora* from different localities in the hope of obtaining the medusæ in other species.

I have obtained spirit specimens from the Bahamas, Bermuda, West Indies, and Tonga, through the kindness of Professor Agassiz, Mr. Shipley, Mr. Lister, and Dr. Günther, and I have carefully re-examined my own specimens from Celebes.

I have also examined numerous skeletons in the possession of the British Museum, of the Museum at Cambridge, and elsewhere; but none of these, except

Feb. 22nd, 1897.

Millepora Murrayi, showed any signs of possessing medusæ or ampullæ.*

Quelch, moreover, gives no account of any ampullæ in any species he describes except *M. Murrayi*.

When searching through the collection of *Milleporas* in the Manchester Museum I came across a single branch of a coral labelled *M. Schrammi*, which resembles very closely the figure of the specimen of this name given by Duchassaing and Michelotti.

Unfortunately the specimen has no history, and I cannot tell where it came from. Michelotti's description of the *M. Schrammi*, from the Antilles, is very imperfect, and it is quite impossible to determine with any degree of certainty whether the specimen in the Museum really belongs to this species or not; but it is very different indeed in form from *M. Murrayi*, and could not possibly, under our present system of classifying species of these forms, be included in Quelch's new species.

Now, the specimen shows clearly several scars of ampullæ, some in clusters, some quite irregularly scattered.

In another specimen of *Millepora* without history, which is very much broken and dusty, several areas are covered with the scars of ampullæ.

The discovery of the ampullæ on these fragments led me to examine very carefully the larger and more perfect specimens in the Museum, and I was delighted to find that one which is labelled *Millepora alcicornis*, and another labelled *Millepora complanata*, exhibit these cavities in large numbers on some of their branches.

* NOTE.—Since the above was written I have examined a number of specimens in the British Museum and the Museum of Natural History at Liverpool, and I have noticed several ampulla-bearing specimens, other than those belonging to the species *M. Murrayi*.—January 28th, 1897.

The general effect of the scars is to give the branches which bear them a diseased or weather-worn appearance, and it also obscures the regular symmetry of the circles of dactylopores round the gastropores.

It is, perhaps, for this reason that collectors and curators of museums have rejected the ampulla-bearing specimens and branches of specimens in favour of the more healthy-looking sterile branches.

It is certainly a very extraordinary fact that hitherto the ampullæ have been recorded only on the single species *M. Murrayi*.

The interest of these observations lies in the fact that they suggest very forcibly that free swimming medusæ occur in other species of *Millepora* both in the West Indies and the East Indies, and that they appear in large numbers either spasmodically or at the times when the vitality of the colony is on the wane. I may take this opportunity of again asking zoologists and others to send me spirit specimens of *Millepora*. Fragments of the older and outer branches of large colonies seem to be the most favourable for the investigation of this particular feature; but from what has been observed on the dried skeletons, it seems possible that the medusæ may be found on other parts as well.

The most important problems that have still to be solved are these: Are the medusæ of the different species of *Millepora* alike, or do they present specific differences? Are the medusæ confined to the male sex, or do medusæ occur bearing the ova?

The general features of the anatomy of *Millepora* show that it is a genus which stands quite by itself. Its relations to the *Stylasteridæ*, the group of coral-forming hydroids with which it is usually associated, are so remote as to be problematical. Its wide geographical distribution

4 HICKSON, on *Ampullæ* in *Specimens of Millepora*.

is associated with a very extraordinary uniformity of structure.

These facts all indicate that *Millepora* is an isolated genus of exceptional interest. A thorough knowledge of its reproductive processes would fill an important gap in our science.

VI. Descriptions of New Species of Brachiopoda and Mollusca from the Millstone Grit and Lower Coal Measures of Lancashire.

By HERBERT BOLTON, F.R.S.E.

Received November 19th. Read December 1st, 1896.

The invertebrate fauna of the millstone-grit and coal-measures of Lancashire has been industriously collected by many local geologists over a considerable number of years, but very little has been done to satisfactorily determine the various collections of fossils. Especially has the group of Mollusca been neglected, and until quite recently it was impossible to decide what forms were clearly recognisable species and what forms were new.

Dr. Hind's recent "Monograph on Carbonicola, Anthracomya, and Naiadites," published by the Palæontographical Society, has placed these three genera upon a more satisfactory basis; but many other genera of the Pelecypoda, and the whole of the Gastropoda yet remain to be dealt with.

The accession by gift of the C. Dugdale collection of millstone-grit and coal-measure fossils from the Rossendale area, of the Kay-Shuttleworth collection of fossils from the Burnley coalfield, and by a similar gift from Mr. Robert Cairns, of Ashton-under-Lyne, has caused the collections of the Manchester Museum, Owens College, to be enriched by several new species from the Lancashire coal-measures. It is very desirable that these species should be named and their generic position determined in order that they may be placed in their true position amongst the geological collections of the Museum,

May 20th, 1897.

and in order that they may be of use to geologists who make use of these collections.

Three of the species here described are from the shales and "bullion-balls" of the Bullion or upper-foot coal-seam of the lower coal-measures. The seam is by far the most remarkable of all the coal-seams which occur in the Lancashire coal-measures, and has yielded to the palæobotanist and palæontologist more material, and of greater interest, than all the rest.

From it were obtained the "coal-balls," by the cutting up of which the late Professor Williamson, your late member Mr. T. Hick, and others were enabled to determine so much of the original structure of the coal vegetation.

It seems less known that resting upon the roof of the coal are other stone balls, often with an outer crust of pyrites, and usually filled with a great number of *Goniatites*, *Aviculopectens*, &c. The shales are full of crushed shells and the bones, teeth, and scales of fishes. Indeed, it is no exaggeration to say that the Bullion seam, and the few feet of shale which form its roof, contain the most varied and abundant fauna of the coal-measures. The species which I describe as *Tellinomya robusta* is a middle coal-measure fossil, and appears to be of considerable value as a zonal fossil. In every case where it has been brought before my notice and the locality has been known, it has been obtained from the shales immediately over the Cannel mine.

DISCINA (ORBICULOIDEA) ORBICULARIS, *sp. nov.*

(Pl. 5, f. 1 and 2).

Discina, G. Wild, "The Lower Coal Measures of Lancashire" (*Trans. Manch. Geol. Soc.*, Vol. XXI., 1890—92, p. 365, pl. iii., f. 9).

Diagnosis: Shell almost circular, the sides contracted a little posteriorly. Free valve much flattened and slightly

conoidal. Apex halfway between centre and posterior margin. Surface covered with equidistant concentric lines of growth. Ventral valve flat, more circular than free valve, and bearing a narrow slit-like foramen passing from the centre to the posterior margin. Marked with concentric striæ as in the free valve. Shell thin and horny.

Diameter 13 mm.

Localities and Horizons: Carre Heys, Colne; roof of Bullion coal, lower coal-measures.

Ashton Moss Colliery, Ashton-under-Lyne; "Marine-band," middle coal-measures.

Observations: This form has been known for a long time from the Lancashire coal-measures. It is a much less robust species than *Discina nitida*, and less elevated. It approximates somewhat to *Discina Davreuxiana*, but is flatter, smaller, and more circular. The dorsal valve of *D. orbicularis* is extremely low, almost flat.

AVICULOPECTEN CAIRNSII, *sp. nov.* (Pl. 5, f. 3 and 4).

Diagnosis: Valves feebly convex, wider than long, inequilateral and markedly oblique. Surface bearing faint concentric striations, probably lines of growth. Hinge line straight, short, and about half the length of the shell. Anterior ear of right valve small, and gradually merging into anterior border. Posterior ear marked with four or five strong rounded ribs; byssal notch deep. Ears of left valve equal, and concentrically striated.

Locality and Horizon: River Tame, Dukinfield; "Marine-band," middle coal-measures.

Observations: This species is a little larger than *A. fibrillosus*, Salter, with which it is found in association, and presents important differences. It is a much more oblique form, and destitute of the radiating ribs which are so conspicuous a feature in Salter's species. The

valves are also shorter in proportion to their width, and the ears are more nearly equal. It gives me great pleasure to name this species after Mr. Robert Cairns, of Ashton-under-Lyne, who has for many years been a diligent student of Lancashire geology.

ANTHRACOMYA BELLULA, *sp. nov.* (Pl. 5, f. 5).

Modiola Macadami, C. Dugdale, "General Section of the Lower Coal Measures and Millstone Grit Rocks of Rossendale" (*Trans. Manch. Geol. Soc.*, Vol. XIX., 1887, p. 228).

Diagnosis: Shell transversely oblong; narrowest in the region of the umbones; slightly expanded posteriorly, ventral margin sub-parallel to the hinge line. Umbones moderately tumid, almost touching, placed far forwards at anterior fifth of length. Lunule small. Anterior end of valves produced, narrow, acutely rounded. The diagonal ridge almost obsolete, lost on the convexity of the shell before reaching the ventral margin. Ventral margin but slightly rounded. Posterior border sloping obliquely upwards. Surface of shell smooth, marked by faint concentric lines of growth, which broaden out over the posterior third of the shell.

Localities and Horizons: Bonfire Hill, Crawshawbooth; in dark shales immediately under the lower rough-rock of the millstone-grit series.

Bankside Quarry, Bacup; in shales under rough-rock. Not now exposed.

Greens Clough, on the moorland between Bacup and Portsmouth; in shale under rough-rock.

Observations: Only three specimens of this species have been seen by me, although more have been found. The specimens now in the Manchester Museum are so well preserved that no doubt need exist as to their specific identity.

A small slab in the Dugdale collection bears two whole shells with open valves.

A small slab with a single pair of valves is in the Cairns collection at the Manchester Museum.

This species has a general resemblance to *A. pumila* and *A. minima* var. *carinata*, but differs from the former in being much narrower in proportion to the length, in the more forward position of the umbo and the produced anterior extremity. The latter feature also distinguishes it from *A. minima* var. *carinata*, as also the absence of a strong oblique ridge.

The species occurs much lower than any other of the genus in the English carboniferous.

TELLINOMYA ROBUSTA, *sp. nov.* (Pl. 5, f. 6, 7, 8 and 8a).

Diagnosis : Shell oval, obtuse, surface smooth, marked by faint concentric lines of growth, strongest along anterior border. Valves strongly convex, umbones gibbous. External ligament present and usually well defined. Anterior lunule well marked, and a posterior escutcheon which is bounded by a slight ridge passing backwards from the umbones to the upper posterior border. Anterior border a little produced and well rounded, and gradually merging into the ventral border. Posterior border short, sometimes a little produced and angulated.

Localities and Horizons :

Chequerbent,	} ;	Cannel mine of the middle coal-measures.
Tyldesley,		
Bank Colliery, L. Hulton,		
Worsley Tunnel,		
Watergate, Bolton,		
Hulton Park, Bolton,		
Mill Hill Bleachworks, Bolton ; horizon not known.		

Observations : This species is readily distinguishable by its stout swollen form and smooth surface, together with

the presence of an anterior lunule. In well-preserved specimens the lunule and anterior border meet in an obtuse angle. The species seems restricted to the shales overlying the Cannel mine of the middle coal-measures. For some time I regarded the species as belonging to the genus *Schizodus*, but further consideration has led me to place it in the genus *Tellinomya* (*Nucula*?) by reason of the presence of an external ligament, a lunule, and a feebly marked corselet, and by the absence of the posterior truncation and oblique ridge so characteristic of *Schizodus*.

One cast shows a small anterior adductor impression.

The occurrence of the species in so many localities immediately over the Cannel seam of the middle coal-measures makes it of considerable value as a zonal fossil.

NATICOPSIS GLOBULARIS, *sp. nov.* (Pl. 5, f. 9).

Diagnosis: Shell globose, spire depressed, and very acute, volutions six, increasing in size rapidly, last volution large and swollen; suture well defined; aperture ovate. Surface smooth or marked by faint lines of growth.

Locality and Horizon: Carre Heys, Colne; over Bullion coal, lower coal-measures.

Observations: This beautiful little *Naticopsis* is to be found in most collections from the Lancashire coal-measures.

It is readily distinguishable by the almost globular last volution, above which stands the extremely short acute spire.

Specimens are almost invariably completely pyritised.

RAPHISTOMA (?) ORNATA, *sp. nov.* (Pl. 5, f. 10).

Diagnosis: Shell small, spire depressed, increasing in size rapidly; consisting of three and a half whorls.

Suture deep, whorls sharply convex above, sides almost flat, broadly convex below. Ornament of strong raised longitudinal lines, crowded on the shoulder, more widely spaced below.

Locality and Horizon : Bacup ; in "bullion-balls" of the Bullion seam, lower coal-measures.

Observations : Several specimens of this pretty little shell were found by me in a bullion-ball which had been partially calcined in order to extract the fossils.

The species was associated with what appears to be a small form of *Anthracomya*.

It may be that this species belongs to the *Pleurotomaria*, but the flattened spire and the absence of any evidence of a sinus have led me to place it in the genus *Raphistoma*.

BOLTON, *New Brachiopoda and Mollusca.*

Explanation of figures in Plate 5.

(The lettered numbers are those of the registers of the Manchester Museum, and are painted upon the matrix enclosing the specimens.)

- Fig. 1. *Discina orbicularis*. Ventral valve. Carre Heys, Colne. W 466, e coll. Wild.
- „ 2. „ „ Dorsal and ventral valves. Ashton Moss Colliery. L 2620, e coll. Cairns.
- „ 3. *Aviculopecten Cairnsii*. Left valve. River Tame, Dukinfield. L 3489, e coll. Cairns.
- „ 4. „ „ Right and left valves. Same locality and collection as fig. 3. L 3490.
- „ 5. *Anthracomya bellula*. Conjoint valves. Bonfire Hill, Crawshawbooth. L 3491, e coll. Dugdale.
- „ 6. *Tellinomya robusta*. Conjoint valves seen from above. Watergate Colliery. L 3492. (The anterior side of the shell is to the right, the faintly marked area to the left of the umbone being the escutcheon within which is a small well-marked ligament. The anterior lunule is more strongly defined than is indicated by the figure, and bears a few feeble longitudinal ribs.)
- „ 7. „ „ Same shell as above, viewed from the right side. Posterior margin much contracted, partly by abrasion.
- „ 8. „ „ Seen from the left side, and showing a greater development than fig. 7. Watergate Colliery. L 3493.
- „ 8a. „ „ Diagrammatic section through original of fig. 8.
- „ 9. *Naticopsis globularis*. Carre Heys, Colne. W 467, e coll. Wild.
- „ 10. *Raphistoma* (?) *ornata*. Figure of whole shell, built up from a series of four incomplete specimens. Bacup, Rossendale. L 3494, e coll. Bolton.
-

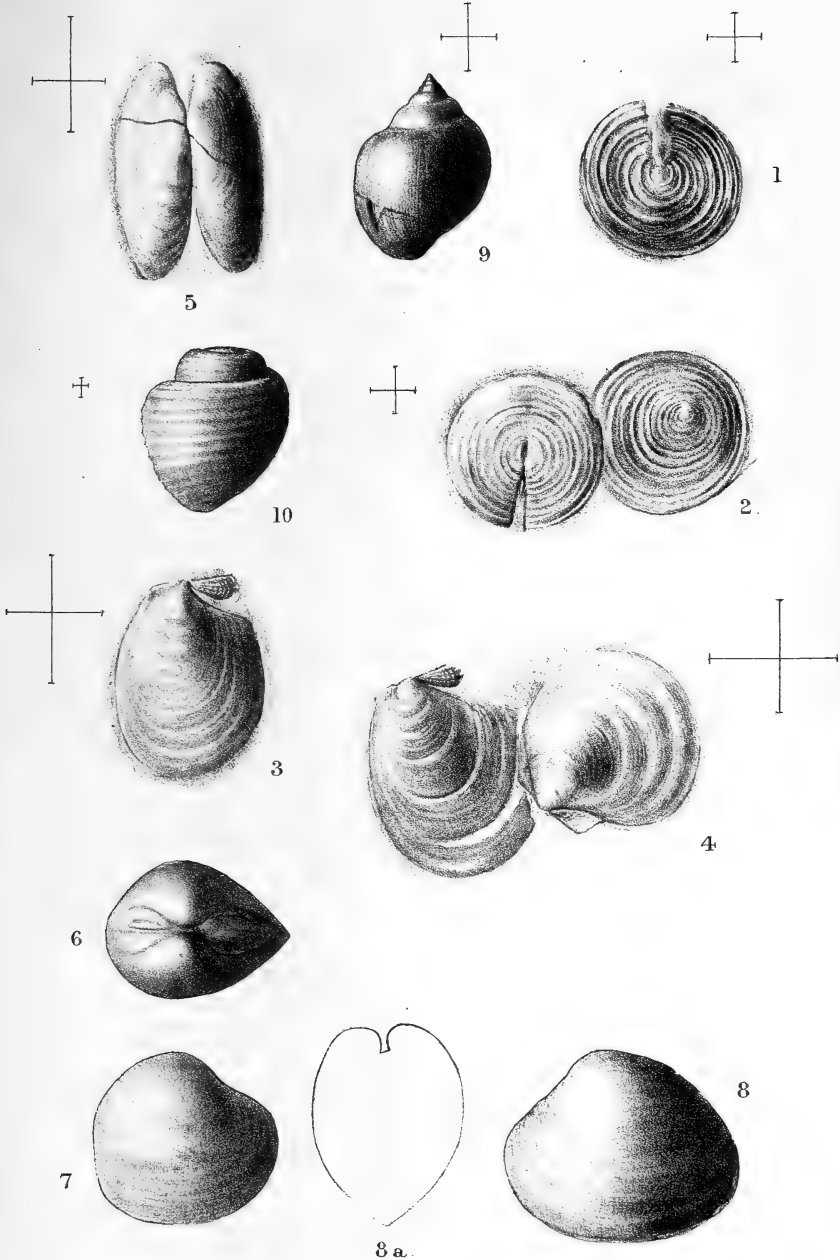

G.M. Woodward del. et lith.

Mintern Bros. imp. London.

BRACHIOPODA AND MOLLUSCA.



VII. Descriptions of Thirty-four Species of Marine Mollusca from the Arabian Sea, Persian Gulf, and Gulf of Oman.

(Mostly collected by F. W. Townsend, Esq.)

By JAMES COSMO MELVILL, M.A., F.L.S.

Received and read December 15th, 1896.

For the past three or four years, Mr. F. W. Townsend, of Manora, Karachi, has been most successfully utilising the exceptional advantages possessed by him as officially connected with the Submarine Telegraph Service in the North Indian Ocean, embracing the whole distance from Karachi to Bushire, frequent inspection of the cable being, of course, necessary.

Various marine objects, both animal and vegetable, rapidly surround and encrust the cable, and these have, from time to time, to be removed.

It is only natural to suppose that many Mollusca take up their abode amongst the *Algæ* and other growths, and the results of Mr. Townsend's dredgings and examinations of the cable have, in this particular, been beyond all measure gratifying and encouraging.

Mr. G. B. Sowerby, F.L.S., has already described some remarkable new species thus discovered by Mr. Townsend, of which the most remarkable, perhaps, are a most beautiful *Niso* (*N. venosa* Sowb.), a *Cancellaria* (*C. paucicostata* Sowb.), a large orange and white *Spondylus*

May 20th, 1897.

(*L. exilis* Sowb.), a handsome *Pecten* (*P. Townsendi* Sowb.), and some very pretty *Trochidæ*, *Bullia*, and other Mollusca.*

Mr. Townsend's collection abounds in species not yet satisfactorily named. Many, especially amongst the *Pelecypoda*, are juveniles, and for identification, therefore, not in good condition; others are mature, but obscure in themselves. Amongst such are many small *Pleurotomidæ*. However, as the following paper will show, there are amongst them some very fine and unequivocal addenda to Molluscan species, the most conspicuous, perhaps, being the *Mitra* (*Costellaria*) *stephanucha*, a giant of its section, and which Mr. Townsend has just discovered in greater plenty than when the first specimens came to light. The beautiful *Scalaria fimbriolata* is also noteworthy, a large *Tapes*, and a *Yoldia*, of which the forms known hitherto are arctic rather than tropical.

We believe it to be Mr. Townsend's intention to publish sooner or later a complete summary of the species obtained in his various dredging expeditions in this locality, or, rather, series of localities between long. 50° and 70°.

This catalogue, when fully worked out, will be found to contain several hundred species, and will be the most important contribution towards the Mollusca of the North-west Indian Ocean (embracing the Persian Gulf, Sea of Oman, and the Arabian Sea) that has been written within recent years.

Combining and connecting, as this vast region does, the fauna of the Red Sea and Aden with that of Bombay and Ratingiri, and, still further south, Ceylon, it is not surprising to find that several species hitherto thought peculiar have extended their range. Only very recently, when describing certain new marine shells from Bombay,

* Vide *Proc. Mal. Soc. Lond.*, Vol. I, pp. 160, 214, 278.

I dwelt upon the specialised nature of the forms. Already one has had cause to modify that opinion. Of the 50 to 60 species then described as novelties, more than 20 have already been found in Mr. Townsend's dredgings, thus extending their range. Of these we may mention, as being especially abundant, the following: *Rissoina pachystoma*, *R. epentroma*, *Marginella mazagonica*, *Tellina lechriogramma*, and *Engina zea*. *Pyrgulina callista*, *P. Edgarii*, and *Seila bandorensis* have also occurred, and *Phasianella minima*.

A few of the following new forms were dredged by Captain E. R. Shopland, at Karachi, or off the Mekran Coast, and we also include a *Columbella* (*C. Cartwrighti*), collected by Capt. Cartwright, R.N., from this same region.

It now only remains for me to briefly tender my best thanks to Sir Rawson W. Rawson, K.C.M.G., for kindly forwarding for my inspection Mr. Townsend's MS. lists, with valuable notes of locality, and for giving me information thereupon; to Mr. Hugh Fulton, for many notes and specimens bearing on the results of the examination of this collection at, and comparison with the stores of, the British Museum of Natural History; and especially am I under a great debt of obligation to Mr. G. B. Sowerby, F.L.S., of Fulham Road, London, whose notes on most of the species now to be described have been of the greatest possible value, and they nearly all have passed through his hands.

Now also, as on many other occasions, must I render thanks to Mr. Edgar Smith for much help and assistance; and finally, and here I speak not only for myself, but for all interested in the geographical distribution of Marine Mollusca, much gratitude is due to Mr. F. W. Townsend, for it is too rarely that such exceptional advantages as those possessed by him, as chief executive officer with regard to the Telegraph Cable, are grasped at, at all events so thoroughly and enthusiastically.

NASSA (NIOTHA) MAMMILLIFERA, *sp. nov.* (Pl. 6, f. 2).

N. testa fusiformi, spira attenuata, ad apicem acuta, gracili, solidiuscula, anfractibus octo, quorum apicalibus duobus, vitreis, lævibus, cæteris apud suturas multum impressis, subventricosis supernis tribus, ultimo undecim gemularum vel mammillarum ordinibus spiralibus decorato, mamillis parvis, rotundis, nitidis, valde regularibus, infra suturas et ad medium ultimi anfractus obscure rufo-vittata, apertura oblonga, labro extus paulum effuso, incrassato, nitido, albo, intus denticulato, canali brevi, margine columellari paulum effosso, dente suturali prominente.

Long. 11, lat. 5 mm., *sp. maj.*

Hab. Persian Gulf.

Five specimens of a small *Nassa*, which is unlike any in the National collection. It would appear near *N. margaritifera* Dunker. The above description will show its peculiarities, the very regular mammillate nodules, three-rowed in the upper whorls, eleven-rowed in the lowest, with much attenuation of whorl, and sharp apex. The shell is obscurely banded transversely with rufous.

NASSA (HIMA) TOWNSENDI, *sp. nov.* (Pl. 6, f. 1).

N. testa fusiformi, eleganter superne attenuata, sub-turrita, pallide brunnea, anfractibus octo, tumidulis, ad suturas impressis, longitudinaliter arcte obliquicostatis, spiralliter liratis, costis ad juncturis lirarum clathrato-noduliferis, liris ultimi anfractus erga basin fortioribus, ad suturas et ad medium ultimi anfractus obscure rufocincta, apertura subrotunda, sinu canali lato, peristomate extus incrassato, intus sex crenato-dentato, dente suturali prominente.

Long. 14, lat. 6 mm.

Hab. Mekran Coast.

An elegantly formed *Nassa*, the upper whorls becoming much attenuate, somewhat tumid, impressed at the

sutures, lower whorls rounded, pale brown, banded with obscure rufous toning at the sutures and middle of the last whorl. Longitudinally costate, costæ somewhat noded at the junction of the spiral liræ, mouth roundish, sinus of the canal broad, lip thickened without, six crenate-dentate within, sutural tooth prominent. Near *N. concinna* Powis. Two specimens, precisely similar.

I venture to dedicate this interesting species to Mr. F. W. Townsend, its discoverer.

SISTRUM RAWSONI, *sp. nov.* (Pl. 6, f. 3).

E. testa ovato-fusiforimi, brunneo-castanea, anfractibus octo, quorum tribus apicalibus pallidé brunneis, vitreis, lævissimus, cæteris paullum ventricosus, longitudinaliter laticostatis, costis obtusis, spiraliter crassiliratis, interstitiis transversim tenuistriatis, liris in penultimo et antepenultimo anfractu quatuor, in ultimo circá octodecim, apertura ovata, labro extus incrassato, intus rufo-carnoso, decem vel undecim denticulato, denticulis albis, nitidis, columella rufo-carnosa, simplice, canali paullulum producto.

Long. 15, lat. 7 mm., *sp. max.*

Locality. Persian Gulf. Long. 27 N., lat. 52 E.

A very pretty species, that might almost equally well be considered an *Engina*; but there are several points of similarity between the shell now before us and *S. concatenatum* Lam. Of a warm chestnut-brown colour, covered with a fugitive epidermis, the whorls eight, three being apical, pale brown, glassy, smooth, the remainder thickly ribbed, and coarsely transversely lirate; the mouth oval, outer lip thickened, ten or eleven denticled within, the denticles being white, shining, the interstices, with the outer lip and columella, rufous, flesh colour; canal very slightly produced.

I venture to associate with this species the name of Sir Rawson W. Rawson, K.C.M.G., so well and uni-

versally known for successful scientific investigations conducted both in the Eastern and Western hemispheres.

A great many specimens.

CORALLIOPHILA PERSICA, *sp. nov.* (Pl. 6, f. 4).

C. testa pyramidata, fusiformi, utrinque attenuata, sordidé alba, anfractibus septem, quorum apicalibus duobus, minutis, lævibus, sordidé albis, cæteris obscure costatis, costis infra suturas evanidis, et spiraliter arctissimé liratis, liris pulchré squamatis, ultimo anfractu expanso, apertura ovata, labro extus effuso, parum incrassato, columella simplice, canali producto, recto.

Long. 15, lat. 6.50 mm.

Hab. Persian Gulf.

A fusiform shell, much attenuate both apically and at the base. Seven-whorled, dirty-white, the whorls obscurely ribbed, and transversely beautifully lirated, the liræ being squamigerous.

MITRA (COSTELLARIA) STEPHANUCHA, *sp. nov.*

(Pl. 6, f. 7).

M. testa attenuata, fusiformi, solidiuscula, rufo-cinerea, indistincté fasciata vel hic illic maculata, apice acutissimo, anfractibus quatuordecim, gradatulis, supernis multicostulatis, costulis simplicibus, quinque vel sex ultimis longitudinaliter fortiter paucicostatis, costis infra, juxta suturas, angulatim noduliferis, nodulis arctis, spiraliter coronatis, interstitiis omnes apud anfractus inter costas spiraliter puncto-liratis, apertura angusta, oblonga, labro extus tenui, intus striato, columella quadriplicata.

Long. 42, lat. 12 mm.

Hab. Persian Gulf, Muscat, &c.

A very highly interesting *Mitra*; doubtless its affinities are with *M. mucronata* Swn., and its allies, e.g., *M.*

fusiformis, chem *M. Dohrni* A. Ad., *M. nodilyrata* A. Ad., &c., but it differs from all in its large size, attenuate fusiform shape, cinereous-red colour, the gradate whorls 14 in number, smoothness of the whorls (to the naked eye), excepting where the spiral acutely noduled coronations encircle the upper part of the last five or six whorls, these coronations gradually get fainter, and disappear altogether in the upper whorls, which are many-ribbed, with interstitial transverse liration; these liræ continue on the lower whorls, many-punctate, and the ribs on these last are fewer and very strongly marked.

Two specimens, and, I believe, others have been more recently procured by Mr. Townsend, from Muscat.

(στεφανούχος, crown-bearing.)

MARGINELLA (GIBBERULA) CHARBARENSIS, *sp. nov.*

(Pl. 6, f. 16).

M. testa oblonga, nivea, politissima, apice acuto undique polito, anfractibus quinque, lævissimis, unicoloribus, ultimo anfractu recto, apertura angusta, oblonga, labro extus subincrassato, involuto, intus planato, lævi, columella quinqueplicata.

Long. 8, lat. 4 mm.

Hab. Charbar, Mekran Coast; also Persian Gulf.

A snowy-white, unicolorous, vividly polished shell, five-whorled, the last whorl straight, aperture narrow, oblong, outer lip slightly thickened, involute, columella five-plaited. Though allied to *M. monilis* Phil., and others of the same section, it appears distinct from its congeners. We have seen several specimens, from the two distinct localities as given above, all much alike, excepting that one (Charbar) form has a more sunken spire.

MARGINELLA (CRYPTOSPIRA) SHOPLANDI, *sp. nov.*

(Pl. 6, f. 15).

M. testa ovata, conica, albo-lactea, semipellucida, tenui, lævissima, nitida, anfractibus quatuor, linea lactea suturas circumcingente, spira conspicua, prominente, apertura angusta, oblonga, labro extus paululum incrassato, supra applanato, intus, præcipué ad basim, minuté denticulato, columella quadriplcata.

Long. 3, lat. 1.50 mm.

Hab. Karachi.

This has been collected at the above-mentioned locality by Captain E. R. Shopland, in whose honour we have the pleasure of naming it, as well as by Mr. Townsend.

It is a delightful little species, of a beautiful semi-pellucid milky-white colour, four-whorled, whorls shining, smooth, a milk-white line encircling the sutures, the spire prominent, mouth narrow, oblong, outer lip flattened above, attenuate below, within, especially towards the inner base, minutely denticled, columella four-plaited.

This species is of the same contour as the larger and coarser *M. mazagonica* Melv., and here we may take the opportunity of mentioning that this latter species, described in the *Manchester Memoirs*, vii. (1893) p. 57, from Bombay, has since been dredged both on the Mekran Coast and Persian Gulf by Mr. Townsend, much enlarging its area of distribution in consequence.

COLUMBELLA (MITRELLA) CARTWRIGHTI, *sp. nov.*

(Pl. 6, f. 14).

C. testa oblongo-fusiforimi, versus apicem attenuata, solidiuscula, anfractibus octo, feré lævibus, castaneo-brunneis, longitudinaliter albo-maculatis vel strigatis, strigis zebrinis,

ultimo anfractu versus basim attenuato, et sulculoso, apertura ovato-oblonga, labro crassiusculo, intus multidenticulato, columella simplice.

Long. 6.50, lat. 3mm.

Hab. Bahrein, Persian Gulf (Captain Cartwright, R.N.).

Several specimens received from Captain Cartwright of an almost smooth *Mitrella*, eight-whorled, and typically striped with longitudinal yellow or whitish flames on a dark-chestnut ground. There is, however, more variable-ness in marking, other specimens being yellow-chestnut and round spotted; others, again, paler, and showing the white marking as calcareous, on a pale cinereous semi-transparent ground. It is a smaller, more compact shell than *C. Euterpe* Melv. from Bombay, and which Mr. Townsend has also dredged at Karachi. The specimens have been examined by Mr. Stephen Pace, who meditated at one time describing them, and, indeed, gave the name as above in MS., in honour of the discoverer; but his approaching departure to the East Indies has compelled him to abandon the idea, and, accordingly, we include it in this paper, gladly adopting his proposed name for the species.

TEREBRA SEVERA, *sp. nov.* (Pl. 6, f. 8).

T. testa aciculata, per attenuata, cinereo-brunnea, anfractibus undecim, quorum duobus apicalibus lævissimis, brunneis, tribus vel quatuor proximis his supernis longitudinaliter acuticostatis, costis paucis, et transversim uni- vel bi-liratis, cæteris valdè irregulariter rudicostatis, vel striatis, ultimo anfractu juxta basim obscurè spiraliter albo-vittato, apertura oblonga, labro extus simplice, margine columellari subplicato, apud basim corrugato.

Long. 14.50, lat. 4 mm.

Hab. Mekran Coast.

A very attenuate, finely aciculate species of sombre colour, and rude irregular longitudinal plaiting. I agree with Mr. Hinds and other authors that the genus is difficult to sub-divide; but this shell would probably be termed an *Acus*, being allied to *A. cinerea* Bom. in form.

(*severus*, grave, austere.)

TEREBRA (EURYTA) THYRÆA, *sp. nov.* (Pl. 6, f. 13).

T. testa gracili, nitida, fusiformi, albida, anfractibus octo, quorum duobus apicalibus, pervitreis, lævissimis, cæteris ventricosis, apud suturas impressis, longitudinaliter indistinctè obliquicostatis, apud basim evanescentibus, undique spiraliter irregulariter sulculosis, anfractibus supernis transversim brunneo-vittatis suprà suturas, in ultimo trivittato, viz.; infra, juxta suturam, irregulariter squarroso-maculato, apud medium laticincto, ad basim vitta continua irregulari dorsaliter confluyente, apertura recta, angusta, labro tenui, columella recta.

Long. 12, lat. 4 mm.

Hab. Karachi and Mekran Coast.

This is a very elegant, chaste species, and quite an outlying form of the genus, being most allied to *T. (Euryta) Brazieri* Angas, from Australia, and *T. pulchella* A. Ad. It is almost an *Olivella* in shape, graceful, attenuate, white with transverse interrupted brown banding or spotting, eight-whorled, two being transparent, apical, the remainder obscurely longitudinally obliquely ribbed, and irregularly sulcose. Aperture straight, narrow, outer lip simple, columella straight. Two specimens.

(*θυραῖος*, outside, outlying, from its characters when compared to the majority of the genus.)

NATICA STRONGYLA, *sp. nov.* (Pl. 6, f. 20).

N. testa parva, globosa, pallidé ochraceo-cornea, profundé angusté umbilicata, spira brevissima, anfractibus quinque, quorum apicalibus duobus albo-vitreis, lævibus, apud suturas valdé impressis ultimo anfractu permagno, rapidé accrescente, et, cum penultimo, infrá, juxta suturas, spiraliter oblique crenulato-rugosis, in uno specimine ultimo anfractu transversim squarrosis brunneis maculis decoratis, cum bino macularum minorum ordine intercalato, in alteris unicoloribus, apertura lunata, labro parum effuso, lævi, margine columellari incrassato, extus sinuoso, callo intus regionem umbilicarem extenso, operculo normali, pulchré costato.

Long. 9, lat. 9 mm.

Hab. Persian Gulf.

A pretty little *Eu-Natica*, of a pale ochraceous-brown colour, deeply impressed at the sutures, five-whorled, two being apical; below the sutures on the last three whorls obliquely wrinkled; on one specimen two transverse bands of square red spots are seen on the last whorl, and between these two rows, two other rows of very small brown dots. The aperture is lunar, lip smooth, columellar margin without cinereous, thickened, extended into the region of the deep but narrow umbilicus. The operculum is beautifully ribbed. Near *N. pulicaris* Phil.

We cannot exactly match this little species, which may not have quite attained its full growth. Three specimens.

(στρόγγυλος, round).

SCALARIA FIMBRIOLATA, *sp. nov.* (Pl. 6, f. 10).

S. testa attenuato-fusiforimi, gracili, candida, delicatula, tenui, anfractibus quatuordecim, quorum apicalibus quatuor albo-vitreis, lævissimis, cæteris longitudinaliter arcaté lamel-

latis, apud suturas multum impressis, lamellis delicatis, fimbriolatis, duplicatis, ad suturas supra angulatis, interstitiis regulariter transversim squarrosé clathratulis, ultimo anfractu infra medium biangulato, angulo inferiore acuto, ad basim extremam spiraliter pulchré coronato, et spiraliter eximie clathrato, apertura rotunda, peristomate incrassato, albo, nitido, continuo, margine columellari simplice.

Long. 19, lat. 5 mm.

Hab. Karachi.

An exquisite species. The whorls are 14, four attenuate, fusiform, colour white, much impressed at the sutures, the longitudinal lamellæ are doubly fimbriate, angled below the sutures, very close, and interstitially transversely latticed. Below the middle of the last whorl are two angles, the lower, or most basal of them, is acute, and spirally extending round the base of the shell, the base itself being spirally crenulate-fimbriate, and within beautifully latticed. Mouth round, peristoma white, shining, continuous. Allied to the large and powerful *S. decussata* Kien (= *Kieneri* T. Canefri) in sculpture and texture, but the whorls are not so ventricose.

(*fimbriolata*, from the fringed appearance of the lamellæ.)

SYRNOLA KARACHIENSIS, sp. nov. (Pl. 6, f. 9).

S. testa attenuata, aciculata, fusiformi, subpellucida, perlævi, laté ochraceo-brunnea, anfractibus undecim, ad suturas paullum canaliculatis, rectis, lævissimis, anfractu ultimo tres proximos altitudine exæquante, apertura oblonga, labro extus tenui, ad basim paullum reflexo, columella uniplicata.

Long. 10, lat. 2.25 mm.

Hab. Karachi.

A very sharply pointed, attenuate species, with smooth straight whorls, ochraceous-brown, subpellucid, 11 in number. Slight canaliculation exists at the sutures, the

mouth is oblong, outer lip simple, somewhat reflexed at the base, columella one-plaited. We have seen three specimens, all similar. The shell might be considered *S. brunnea* A. Ad., in miniature; but the latter species is of very much stouter build throughout, and is not, really, very nearly allied.

ELUSA BRUNNEO-MACULATA, *sp. nov.* (Pl. 6, f. 5).

E. testa aciculata, terebrali, albida, parum nitente, anfractibus quatuordecim, apicalibus ?, rectis, minimé turritis, undique longitudinaliter crassicostatis, costis obtusis, planis, interstitiis spiraliter tenuistriatulis, albis, sparsim raro brunneo-maculatis, apertura ovata, labro paullum crassiusculo, apud medium extus simul ac intus brunneo-tincto, margine columellari, incrassato, uniplicato.

Long. 15, lat. 4.50 mm., *sp. maj.*

Hab. near Karachi, 7 fathoms.

A fine, conspicuous *Elusa*, of bold design, and distinguished by the scattered brown spots and dashes here and there, on a white ground. The whorls are 14, all uniformly thickly costate, the interstices being spirally very finely striate. Mouth ovate, outer lip a little thickened, stained both outside and within in the middle with a brown streak. Columellar margin thickened, one-plaited. Two or three specimens only.

EULIMA EPIPHANES, *sp. nov.* (Pl. 6, f. 6).

E. testa aciculata, politissima, lævi, lactea, apice acutissimo anfractibus quatuordecim, rectis, continuis, lævissimis, ultimo recto, apertura oblonga, labro paullum producto, margine columellari obliquo.

Long. 14, lat. 2.50 mm.

Hab. Linjah, Persian Gulf, 5 fathoms, soft mud.

This very graceful *Eulima* resembles nearly only two others of the genus, viz., *E. attenuata* Sowb. and *E. epeterion* Melv.

From the former of these (*attenuata*) it differs in greater width of whorl, and more oblique columella; from the latter in smaller size, more straightness of whorl, and less width in the last whorl. To *E. pura* Ad. it also bears some resemblance, but the outer lip is not thickened as in *E. pura*, and the aperture is longer in proportion to the length of the shell in our species.

(επιφάνης. Manifest, conspicuous.)

TURRITELLA FULTONI, *sp. nov.* (Pl. 6, f. 12).

T. testa attenuata, pergracili, apice aciculato, pallidé albo-ochracea, anfractibus sexdecim ad novemdecim, ad suturas impressis, ventricosis, supernis tricarinatus, quatuor vel quinque ultimis, ad penultimum spirāliter quadricarinatis, ultimo anfractu octo vel novem carinis instructo; præter has, carinula minore primam et secundam carinam interveniente, inter secundam et tertiam, tertiam et quaternam liris elevatis accingendis, apertura rotunda, labro simplice, basi livatula.

Long. 27, lat. 8 mm., *sp. max.*

Hab. Ormara, 2 fathoms, in sand.

Allied to *T. incrassata* Sowb., but the sculpture is not quite the same. The largest specimen is sixteen-whorled, very gracefully attenuate, whorls screw-like, impressed at the sutures, with in the upper whorls three, in the lower four thick angular spiral keels, the last whorl being adorned with eight or nine. Between these principal keels there are lesser ones, sometimes degenerating into mere varied liræ—the base of the shell being also lirate. Mouth round, lip simple.

Six specimens.

In the National collection is a tablet of this shell, collected in the Persian Gulf by Mr. W. D. Cumming.

GIBBULA (CANTHARIDELLA) PHÆDRA, *sp. nov.*

(Pl. 6, f. 17).

G. testa acuté conica, angusté ad profundé perforata, pyramidali, parva, solidula, anfractibus sex, nigro-olivaceis, infra juxta suturas, hic illic cinereo-flammatis, undique longitudinaliter et minuté punctolineatis, lineis regularibus, ultimo ad peripheriam acutangulato, apertura quadratula, intus vividissimé iridescente, basi simili modo sulcato-lineata, columella recta.

Alt. 6, lat. 4 mm.

Hab. Charbar Pt., 7 fathoms.

Allied to *G. Stolickzana* Nevill, from Ceylon, but of totally different shape, being more acutely conical, and in this respect exactly (save for the umbilicar perforation) resembling a *Cantharidus* or *Elenchus*. The whorls are six, colour dark olive, with occasional white flaming at the sutures. The peripheral angle of the last whorl is acute, the whole shell is closely sulcate-linear, these lines being most regular. The square mouth is intensely green, iridescent within.

Three specimens.

(φαίδρος, brilliant.)

MONILEA ASTROLABENSIS, *sp. nov.* (Pl. 7, f. 21).

M. testa perforata, depresso-globulosa, solida, alba, anfractibus quatuor, ventricosis, undique spiraliter tenuiliratis, infra suturas et ad medium anfractus ultimi squarrosé brunneo-maculatis, et hic illic laté brunneo-ochraceo interspersis, ultimo ad peripheriam rotundato, ad basim spiraliter lirato, et ochraceo-sparso, circá umbilicum crenulifero, apertura rotunda, peristomate lævi, haud multum incrassato, simplice.

Alt. 3.50, diam. 4 mm.

Hab. Astrolabe Island, Mekran Coast.

A thick, almost smooth shell, but when examined with a lens it is found to be uniformly spirally striate. Four-whorled, the whorls tumid, and painted below the sutures and in the middle of the last whorl with square brown spots, the surface between being mottled with lighter ochraceous-brown painting, as is also the case at the base. This is likewise spirally striate. The umbilical region is crenulate, the umbilicus itself narrow. Mouth quite round; peristome not much thickened, simple. The nearest ally is the more sombre-coloured *M. rotundata* Sowb., from Hong Kong (*Proc. Mal. Soc.*, Vol. I., p. 158, pl. xii., f. 19), with which it agrees in size, and the character of the thickly crenulated basal ridge fringing the umbilicus; but we have compared it closely with the types, and find many differences, notably in the striolation.

MINOLIA CLIMACOTA, *sp. nov.* (Pl. 7, f. 22).

M. testa gradato-conica, subdepressa, angusté umbilicata, solida, albo-ochracea vel albo-cinerea, anfractibus septem, apud suturas multum impressis, undique irregulariter spiraliter arcaté liratis, liris conspicuis, sulculosis, pulchré tornatis, infra juxta anfractuum suturas nigris, nigro-rufis vel cinereis flammis maculisve depictis triangularibus, basi planata, lævissima, ad peripheriam unangulata, infraque peripheriam brunneis vel cinereis flammis decorata, apertura angulato-rotunda, labro simplice.

Alt. 14, diam. 14 mm., *sp. maj.*

Hab. Charbar.

Though allied to *M. variabilis* Sowb., we do not think this shell a form of that species. Four specimens are before us, the three larger of these being gradate, and from them the above description is taken; the smaller shell, perhaps not full grown, is, as in the types, very deeply spirally lirated and sulcose, the triangular

notches of black-brown painting being the same, while the narrow umbilicus and smooth base are also identical, but the whorls are not gradate, or hardly so.

(κλιμάκωτος, terraced.)

MINOLIA NEDYMA, *sp. nov.* (Pl. 7, f. 23).

M. testa laté et profundé umbilicata, depresso-conica, gradatula, anfractibus quinque concinné tornatis, infrá suturas rectangulatis, flammis variis longitudinaliter cinereis depictis, ultimo rapidé accrescente, regulariter spiraliter sulcato, et longitudinaliter obscuré decussato, apud peripheriam rotundo-angulato, et pulchré marginato, basi concentricé costulata, costulis gemmatis, apertura rotunda, labro simplice.

Alt. 3, lat. 5 mm.

Hab. Off anchor, Bunder-Abbas, Persia.

About 20 specimens. Mr. Hugh Fulton has compared closely with this *M. Caifassii* Caramagna, from Assab, Red Sea, from which it differs in being less fragile, and in its much flatter and more depressed form. *M. gradata* Sowb. is a much larger shell.

(νήδυμος, delightful.)

THALOTIA BELUCHISTANA, *sp. nov.* (Pl. 6, f. 19).

T. testa pyramidata, angusté umbilicata, solidiuscula, anfractibus novem, tribus apicalibus ventricosulis, striatulis, puniceo-tinctis, cæteris ad suturas, et ultimo ad peripheriam spiraliter carina elevata, filosa, rufo-punicea, longitudinaliter obliquissimé striata accinctis, superficie anfractuum transversim regulariter lirata, et obliquissimé longitudinaliter striata, cinerea, apud peripheriam anfractus ultimi acuticarinatam, basi concinna, applanata, concentricé decemlirata, liris filosis, regulariter rufo-punctulatis, apertura quadrata, peristomate tenui, margine columellari paullum reflexo, umbilicum semiobtegente.

Alt. 10, diam. 9 mm.

Locality. Charbar, 7 fathoms.

An extremely neat shell, which seems better placed in *Thalotia* than *Calliostoma*. It is allied to *T. Torresi* Smith, being identical in form, and in umbilicus, but the grained pattern is here replaced by smooth whorls, spirally lirate, and at the sutures elevete, threaded, red tained, and the whole surface of the whorl being extremely obliquely striate, the striæ passing from left to right. The periphery is acutely keeled, the concentric liræ at the base are rufous-dotted, and the reflexed columellar margin half conceals the narrow umbilicus. The upper whorls are tinged with pink—say the three apical, and the next three as well.

CALLIOSTOMA FUNICULARE, *sp. nov.* (Pl. 6, f. 18).

C. testa solida, pyramidata, pallidé fulvescente-ochracea, hic illic cinereo-effusa, anfractibus decem, apicalibus duobus pellucetibus, deinde quatuor supernis transversim tribus gemmularum ordinibus instructis, cæteris quatuor vel quinque cingulis funiculatis accinctis, nitidis, cingulo superiore angusto, crenulato-gemmulifero, duobus inferioribus cingulis præcipue in penultimo, antepenultimo, et apud peripheriam ultimi anfractus latioribus, nitidis, et regulariter latè rufo-maculatis, ad peripheriam acutangulato, basi spiraliter concinné novem-funiculata, delicatè et regulariter rufo-punctata, apertura subquadrata, labro paululum effuso, marginem apud columellarum incrassato.

Alt. 14, diam. 11 mm.

Hab. Telegraph Cable. Lat. 27 N., long. 52 E. (F. W. Townsend.)

A compact pyramidal species of the normal type of *Calliostoma*, being in pattern not altogether unlike a small *C. zizyphinus* L. The whorls are 10, two being apical, and the next four transversely beaded, shining, the remaining

whorls are four or five spirally banded with raised liræ, the upper lira beaded, the two lower broader, smooth, rufous-spotted. At the periphery there are two similar liræ, and the base is beautifully spirally lirated, the liræ being also rufous-dotted. The mouth is square, outer lip somewhat expanded, columellar margin thickened.

(*funicularis*, bestowed in double sense, from the locality, and also from the rope-like spiral banding.)

ETHALIA CARNEOLATA, *sp. nov.* (Pl. 7, f. 25, 26).

E. testa depresso-conica, profundé sed angusté umbilicata, solida, lævissima, læté carnea, anfractibus quinque vel sex, apud suturas impressis, apicalibus minutis, omnibus lævibus, supernis interdum spiraliter tenuissimé striatis, ultimo ad peripheriam obtus-angulato, rapidé accrescente, omnibus spiralliter pallidé brunneo- et albo-vittatis, ultimo apud basim lævi, circá umbilicum incrassato et lævi-tornato, apertura rotunda, intus puniceo-carnea, peristomate extus simplice, columellarem apud marginem albo, incrassato, umbilicum callo nitido paullum obtigente.

Alt. 4, diam. 7 mm.

Hab. Bass Island, 10 fathoms.

A depressedly conical smooth little species, which, owing to the callus on the columellar margin, seems better included in *Ethalia* than *Minolia*. It is of a pale carnation or flesh-colour in hue, inside the mouth a deeper shade of the same colour, painted with fillets spirally of ochre-brown beaded with white.

Several specimens.

N.B.—A much larger shell (alt. 6, diam. 11) is in the collection, from the Persian Gulf. This shell, though it shows no trace of carnation tinging, as in the *Ethalia* just described, yet has so many points in common with it that we expect it will be found to be an outlying variety of this species.

ETHALIA MINOLINA, *sp. nov.* (Pl. 7, f. 24).

E. testa depresso-conica, rufo-carnea, spiraliter albo-vittata, solida, anfractibus sex, inclusis apicalibus, undique spiraliter arctissimé filostriatis, striis variis, anfractu penultimo gradatulo, ultimo apud peripheriam rotundo-angulato, basi simili modo filostriata, umbilico profundo, apertura rotunda, peristomate marginem apud columellarem linguifero, calloso, umbilicum impendente. Operculo corneo.

Alt. 6, diam. 10 mm.

Hab. Persian Gulf.

A pretty, bright shell, depressedly conical, six-whorled, rufous-flesh colour, uniformly very closely filostriate, the pattern being, as is so often seen in this genus and the congeneric *Minolia*, a banded filleting of white and fawn colour. The umbilicus is deep, and partly covered by the tongue-shaped callus extending from the columellar margin. Allied to *E. striolata* A. Ad., from Borneo.

(*minolina*, resembling a *Minolia*.)

FISSURELLA TOWNSENDI, *sp. nov.* (Pl. 7, f. 27, 27a).

F. testa oblonga, ad medium utrinque paullulum attenuata, foramine oblongo, declinato, undique radiatim arcté costulato, spiraliter clathrato, interstitiis squarrosis, colore pallescente, radiis variis brunneis depicto, margine basali crenulato.

Long. 21, lat. 13 mm.

Hab. Karachi.

Mr. Hugh Fulton, who has carefully studied this species, and compared it with its congeners, writes me that it is near *F. fumata* Reeve and *F. corticula* Sowb., but flatter than the former, and the orifice, though in declension, is more terminal than in either of the foregoing.

Several specimens.

DENTALIUM CONSPICUUM, *sp. nov.* (Pl. 7, f. 28).

D. testa nitida, subulata, arcuata, lactea, longitudinaliter tenuistriata, striis inæqualibus, hic tenuibus, illic crassioribus, spiritaliter irregulariter concentricè liricinctis, ad apicem octagonalibus, ad basim evanidis, basi ipsa perlævi, rotunda.

Long. $1\frac{3}{4}$, lat. $\frac{3}{16}$ unc.

Hab. Karachi.

A milky-white conspicuous species, slightly arcuate, eight-angled at the apex, the longitudinal striæ very unequal down the body of the shell, and entirely vanishing before the base, which is very smooth, and round at the orifice. It is concentrically unequally liriate.

Two specimens.

LEUCOTINA JASKENSIS, *sp. nov.* (Pl. 6, f. 11).

L. testa pergracili, multum attenuata, delicatula, alba, anfractibus novem, ad suturas impressis, ventricosulis, spiritaliter costatis, costis lævibus, nitidis, interstitiis decussatis, apertura oblonga, peristomate extus haud incrassato, paullulum producto, columella recta.

Long. 10, lat. 2.50 mm.

Hab. Jask, Persian Gulf.

A white, exceedingly graceful, attenuate *Leucotina*, nine-whorled, the whorls being slightly ventricose, all uniformly spirally ribbed, the ribs smooth, bold, and shining. Interstitially the whorls are decussate. Mouth oblong, the peristome thin, slightly produced, columella straight. Another beautiful form of this genus, *L. speciosa* Ad., also occurs in Mr. Townsend's collections.

CHIONE MEKRANICA, *sp. nov.* (Pl. 7, f. 30).

C. testa parva, subtriangulari, pallidé albo-carnea, postice trapeziformi, anticè paullum producta, margine ventrali recto,

intus denticulato-serrato, umbonibus parvis, haud conspicuis, lunula brunnea, angusta, valvis longitudinaliter radiatim sulcatis, sulcis irregularibus, interstitiis inæqualibus, posticé majoribus.

Alt. 7.50, diam. 3.50, lat. 10 mm.

Hab. Mekran Coast.

A small somewhat triangular species, almost colourless, except for one or two cinereous blotches on the posterior side; it is slightly produced anteriorly, the ventral margin being almost straight. Umboes inconspicuous, the valves being longitudinally radiately ornamented with irregular sulcations, the sulci not being equi-distant, large interstitial spaces occurring on the posterior side. The lunule is dark brown, and narrow.

Allied to the group of *C. Layardi*, &c.

DOSINIA GLOBA (A. Ad. Mss.), *sp. nov.* (Pl. 7, f. 35).

D. testa feré rotunda, solida, sordidé alba, omnino concentricé regulariter costulata, costis parvis, simplicibus, anticé abbreviata, cum margine ventrali ad latus posticum rotundato, umbonibus incurvis, lunula cordata.

Alt. 25, lat. 26, diam. 12 mm., *sp. max.*; alt. 15, lat. 18, diam. 9 mm., *sp. min.*

A typical *Dosinia*, apparently common on the East coast of the Arabian Sea. It is in our Bombay list, as collected by Mr. Abercrombie, under the name *D. gibba* Ad., and also in Paetel's catalogue (Vol. III., p. 90), under the same name, without locality or reference. We think there has been some confusion here, and that this Mollusc has never been properly described, and accordingly we consider it best to rectify this omission at the present opportunity.

TAPES ONCODES, *sp. nov.* (Pl. 7, f. 34).

T. testa rudi, sordidé alba, tenui, inflata, concentricé ruduplicata et lineata, anticé rotunda, posticé oblonga, producta, umbonibus convexis, margine dorsali posticé rectiusculo, anticé declivi, margine ventrali subconvexo, feré recto.

Alt. 29, lat. 47, diam. 25 mm.

Hab. Mekran Coast.

A coarse, dirty white shell, but of light make, and not unlike some forms of *T. pullastra* L. Many specimens.

(ὄγκώδης, inflated.)

TELLINA (MÆRA) METHORIA, *sp. nov.* (Pl. 7, f. 31).

T. testa parva, alba, nitida, perlævi, pulchré prismatica, subtrapeziformi, anticé oblonga, declivi, posticé truncata, brevi, margine ventrali paullulum sinuosa, umbonibus parvis, dorsaliter utrinque declivi, valvis delicatissimé spiraliter concentricé striatulis.

Alt. 8, lat. 12, diam. 4.50 mm.

Hab. Dredged at 2 fathoms off Mekran Coast.

A shining white shell, very smooth, with beautiful prismatic reflections. With aid of a lens the surface of both valves is seen to be very finely spirally striate; the umbones are very small, posterior margin truncate, and very contracted; the anterior is oblong, somewhat slanting, the ventral a very little sinuous.

Many specimens allied to *T. lechriogramma* Melv., which, described four years ago from Bombay, has been found to have a wide distribution further north, Mr. Townsend having dredged beautiful specimens, some with a flesh-coloured tinge. Our shell, however, differs from this in shape, sculpture, and presence of prismatic reflections.

(μεθόριος, akin to, *i.e.*, *lechriogramma*.)

DONAX APERITTUS, *sp. nov.* (Pl. 7, f. 33).

D. testa solidiuscula, compacta, lævi, nitida, indistincté lirata, latere antico producto, postico subtruncato, paullum extenso, radiatim recti-corrugato, margine ventrali minuté serrato, umbonibus inconspicuis, planatis.

Long. 8, lat. 15 mm.

Hab. Karachi.

A smooth shell, with the anterior side produced, somewhat truncate, though slightly extended also posteriorly, the radiate corrugations being prominent; the rest of the surface almost smooth, the umbones inconspicuous; ventral margin minutely serrate.

(ἀπέριττος, simple.)

PECTUNCULUS MASKATENSIS, *sp. nov.* (Pl. 7, f. 32).

P. testa paullum compressa, æquilaterali, solidiuscula, rotundata, dorsaliter recta, brunneo-rufo-alboque sparsa, umbonibus parvis sed conspicuis, radiatim fortiter costulata, costis uniformibus, apud medium et infrá sulculo divisis, utrâque parte nodulis parvis decoratis, interstitiis spiraliter tenuissimé liratis, cardine dentibus octodecim in utrâque valvâ instructo, pulchré brunneo-tinctis, interiore albo-lacteo.

Alt. 22, lat. 25, diam. 10 mm.

Hab. Muscat (or Maskat), Arabia, 10 fathoms in sandy mud.

Allied to the well-known *P. pectiniformis*, Lam., but the ribs, as seen by the above description, are of an entirely different character, being smooth and undivided by a sulculus in Lamarck's species. It ranks among the more select of a genus famous for a highly-individualised type of beauty.

YOLDIA TROPICA, *sp. nov.* (Pl. 7, f. 29).

Y. testa oblonga, trapezioides, tenui, lævissima, spiraliter striatula, epidermide olivacea contecta, anticé prolongata subrostriata, posticé brevi, rotundata, margine ventrali recto, dorsali declivi, umbonibus parvis, lunula angustissima, dentibus anticis septemdecim, posticis quatuordecim, pectinaceis, intus albo-lactea.

Alt. 10, lat. 18, diam. 7.25 mm.

Hab. Karachi.

One perfect example of an interesting shell, of which one valve also exists, unnamed, in the National Collection. It is thin, covered with an olivaceous epidermis, spirally finely striate, squarely elongate. Slightly swollen towards the umbones, which are small, anteriorly prolongate, posteriorly short and rounded, ventrally straight, dorsally slightly sloping on each side of the umbones. The anterior comb-like teeth are 17, the posterior 14 in number. Within the shell is milky-white.

MELVILL, *Descriptions of Marine Mollusca.*

Explanation of Plates.

PLATE 6.

- Fig. 1. *Nassa Townsendi*.
,, 2. *Nassa mammillifera*.
,, 3. *Sistrum Rawsoni*.
,, 4. *Coralliophila persica*.
,, 5. *Elusa brunneo-maculata*.
,, 6. *Eulima epiphanes*.
,, 7. *Mitra (Costellaria) stephanucha* (nat. size).
,, 8. *Terebra severa*.
,, 9. *Syrnola karachiensis*.
,, 10. *Scalaria fimbriolata* (nat. size).
,, 11. *Leucotina jaskensis*.
,, 12. *Turritella Fultoni* (nat. size).
,, 13. *Terebra (Euryta) thyræa*.
,, 14. *Columbella (Mitrella) Cartwrighti*.
,, 15. *Marginella (Cryptospira) Shoplandi*.
,, 16. *Marginella (Gibberula) charbarensis*.
,, 17. *Gibbula (Cantharidella) phædrá*.
,, 18. *Calliostoma funiculare*.
,, 19. *Thalotia beluchistana*.
,, 20. *Natica strongyla*.

PLATE 7.

- Fig. 21. *Monilea astrolabensis*.
,, 22. *Minolia climacota*.
,, 23. *Minolia nedyma*.
,, 24. *Ethalia minolina*.
,, 25. *Ethalia carneolata*.
,, 26. *Ethalia carneolata*, var.
,, 27. } *Fissurella Townsendi*.
,, 27a. }
,, 28. *Dentalium conspicuum*.
,, 29. *Yoldia tropica*.
,, 30. *Chione mekranica*.
,, 31. *Tellina (Mæra) methoria*.
,, 32. } *Pectunculus maskatensis*.
,, 32a. }
,, 33. *Donax aperittus*.
,, 34. *Tapes oncodes*.
,, 35. *Dosinia globa*.

VIII. Hypoiodous Acid and Hypoiodites.

By R. L. TAYLOR, F.C.S.

Received and read February 9th, 1897.

HYPOIODITES.

It appears to have been always considered very doubtful whether hypoiodous acid has ever been prepared at all, and many chemists are hardly willing to recognise hypoiodites as very definite compounds. The information one can obtain about these bodies is very vague and indefinite, and in some respects contradictory.

My investigation was originally undertaken with the object of isolating hypoiodous acid, but the following experiment led me to include hypoiodites as well. I had found that a solution of iodine in water acted in many respects very much better than any other solution, or than the solid substance, and trying the effect of adding a little alkali to some of this aqueous solution, I was astonished at the particularly definite character of the solution obtained, and especially at its bleaching action, and felt sure that this remarkable solution could not be generally known, or else hypoiodites would certainly have met with better recognition than they have hitherto received.

So far as I am aware, the most important papers on hypoiodites have been those by Schönbein (*Journal für praktische Chemie*, 1861, p. 387), and by G. Lunge and R. Schoch (*Berichte*, 15, p. 1883) on Calcium Hypoiodite.

May 20th, 1897.

The more important of these is that by Schönbein, and in the first part of this paper I shall describe some of Schönbein's experiments, with others which I have performed and which confirm and extend his results. I shall refer to the work of Lunge and Schoch afterwards. I find that Schönbein, in his experiments, used the very solution which I have already mentioned as giving such remarkable results, that is, iodine dissolved in water. Unfortunately, however, Schönbein's paper has been badly summarised in all the standard dictionaries and works on chemistry, and this important point is not usually mentioned. Schönbein's paper is one of a series. He had been trying experiments on the action of chlorine water and bromine water upon dilute ammonia, and then naturally passed on to iodine, using that substance also in solution in water. Such a solution is very dilute, being at the most only about one part in 5,000; but this solution, in many respects, gives more definite results than any other.

Schönbein first described the action of ammonia upon iodine water, whereby the liquid was decolorised, and a solution obtained which bleached indigo just as the liquids produced by the action of ammonia upon chlorine water and bromine water did. He found, further, that the solution gave a deep blue coloration with a mixture of starch-paste and potassium iodide, and even with starch-paste alone. Left to itself, the liquid lost these peculiarities, more quickly at high than at low temperatures, and almost instantaneously when boiled. He then found that similar results were obtained with potash solution, and that both solutions were decomposed by hydrogen peroxide, with manifest liberation of oxygen. He also pointed out that the solutions smelt of saffron. He not unnaturally concluded from these results that the liquids contained hypoiodites, and that the action

of iodine upon the alkalies was similar to the action of chlorine and bromine, and might be represented as follows:—



He also concluded that, as the liquids lost their bleaching power, they gradually changed into iodide and iodate, according to the following equation:—



One thing which seemed to puzzle him very much was that the liquids gave a blue colour with starch alone, even when he added potash in the proportion of two equivalents to one of iodine. He thus made the liquid strongly alkaline, and capable, as he said, of taking up more iodine; and he argued, therefore, that there could not be any free iodine present in the excess of potash, and that hence the blue colour could not be due to iodine. In addition he pointed out that the liquid was almost, if not quite, colourless. He found, however, that the addition of potassium iodide turned the liquid brown again, manifestly owing to the liberation of iodine. I shall show further on that these results are easily explained.

I may mention that in all my experiments the iodine used was carefully purified by Stas' method, and that the indigo was a solution of indigo carmine in water.

As has been already mentioned, the liquids produced by the action of alkalies upon aqueous iodine have a most energetic bleaching action upon indigo; they also bleach cochineal and logwood, but not litmus. In bleaching indigo they are much more active than either a solution of chlorine or of bleaching powder of anything like the same strength; in fact, compared with Schönbein's solutions, chlorine and hypochlorites may be described as very sluggish.

Borrowing, with some modifications, a method described by Lunge and Schoch in their paper, I attempted, by means of a standard solution of indigo carmine, to ascertain the strength of the bleaching liquids, in order to find, if possible—assuming that the reaction goes as Schönbein suggested, and as the corresponding reaction with chlorine and bromine are well known to go,—the amount of iodine converted into what one may call “bleaching iodine.” After many attempts, I found that the best results were obtained by standardising the solution of indigo carmine against a dilute solution of chlorine, which had been titrated against a standard iodine solution by means of potassium iodide and sodium thiosulphate in the usual way. The aqueous iodine solution was also standardised against the same standard solution of iodine. The amount of iodine present in the aqueous solution was usually from 0·17 to 0·22 grammes per litre. One of the difficulties experienced in standardising the solutions was due to the end-reaction with chlorine water and the indigo solution being exceedingly slow. No such difficulty, however, was anticipated with the iodine bleaching solutions, the end-reaction with these being apparently sharp and distinct.

The method employed was to take a measured volume (usually 20 c.c.) of the aqueous iodine solution, to add one or two drops of potash or soda, and then immediately run in the standard indigo carmine until there was a distinct green colour. (The indigo solution is bleached to a slightly yellow liquid, and this of course becomes green as soon as an excess of indigo is added.) For a long time the results were unsatisfactory. The bleaching power of the solutions seemed to vary in an extraordinary manner. Frequently the results obtained gave 90% and 95% of the iodine converted into “bleaching iodine,” and

then, in another experiment, with the same solution of iodine, the bleaching action, without any apparent reason, ran up to 30 or even 40% *above the theoretical amount*, that is above the amount which it ought to be if the whole of the iodine used had been converted into iodide and hypoiodite according to the equation



Similar anomalous results were obtained when solutions of bleaching powder or of sodium hypochlorite were used instead of chlorine water. These extraordinary results were ultimately found to be due to a very strange action on the part of the indigo, an action of which I can at present offer no explanation. The *excess* of bleaching action upon the indigo is not permanent; on standing for a minute or two the blue colour returns. This of course is not the case with what I may call the genuine bleaching action. If one cubic centimetre of indigo solution in excess of what is permanently bleached be added, although there appears to be no indication of when the end-point is being passed, on standing for a minute or two a blue colour appears. I further found that this curious temporary bleaching action only occurs when a large excess of alkali (in comparison with the amount of iodine present) has been used.

Now, of course, it was possible to determine the amount of permanent bleaching action. The following example is one out of a great many experiments which I made:—

20 c.c. of the aqueous iodine solution (=·0035 iodine), after the addition of alkali bleached 15 c.c. of standard indigo solution, 1 c.c. of which (titrated with standard solution of chlorine) corresponded to ·000228 of iodine, so that the amount of iodine indicated by the bleaching action was $\cdot000228 \times 15 = \cdot00342$, which was practically the

whole of the iodine. The solutions used are extremely dilute, but there is really no difficulty in making estimations which will be accurate to within two or three per cent. The general result of these experiments is that 95% of the iodine in Schönbein's solutions undergoes the reaction represented by the equation



These results are amply confirmed by an altogether different method—one which was used by A. Schwicker (*Zeit. physikal. Chem.*, 16, 303-314) in an investigation which he has recently made on the reaction velocity of potassium hypoiodite. He takes advantage of the fact that potassium bicarbonate will decompose a mixture of hypoiodite and iodide, with liberation of iodine. He also uses a little soda-water, the carbonic acid in which is intended to convert any liberated potash into the bicarbonate. The bicarbonate apparently decomposes the mixture of hypoiodite and iodide, with formation of normal carbonate and liberation of iodine, according to the following equation:—

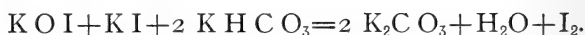

With my dilute solutions, I find that it answers just as well to run into the liquid, which is always sufficiently alkaline, a small quantity of soda-water. This immediately liberates the iodine, which can now be estimated by means of a centi-normal solution of sodium arsenite. Carbonic acid does not decompose potassium iodate, so that this method may be employed in all mixtures of hypoiodites, iodates, and iodides. In one determination by this method 97% of the iodine originally used was liberated on the addition of the soda-water. We may, therefore, conclude that when potash acts upon iodine-water there is practically no iodate formed.

As Schönbein pointed out, the solutions are very unstable. I have made a number of experiments upon the rate at which the change occurs, estimating this by the diminution in bleaching power. I find that the presence of excess of alkali makes the solution more stable; but even then a solution loses half its bleaching power on standing, in the dark, for four hours. In 24 hours 75% of the bleaching power goes. If a much smaller amount of alkali is used half the bleaching power goes in an hour. On heating the solutions, they alter very rapidly, and every bleaching liquid of this kind which I have prepared loses its bleaching power entirely if boiled for three or four minutes. As Schönbein assumed, this loss of bleaching power is doubtless due to a change of the hypiodite into iodide and iodate—



As mentioned above, Schwicker has recently investigated the rate at which the above change occurs at the ordinary temperature with different proportions of iodine and potash present. The results do not appear to have been altogether satisfactory. But he used iodine dissolved in potassium iodide, and there is no doubt that the latter would affect the results materially. Probably better results would be obtained by the use of a solution of hypiodite made from hypiodous acid (see page 16), which would not contain any iodide at all.

I may refer here to the fact that whether the liquid contains iodide and hypiodite or iodide and iodate, the addition of an acid at once liberates the whole of the iodine; in the one case hypiodous and hydriodic acids are liberated, which at once decompose each other ($\text{HOI} + \text{HI} = \text{H}_2\text{O} + \text{I}_2$); in the other hydriodic and iodic acids are similarly liberated, and in the exact amounts

needed to decompose each other ($5\text{HI} + \text{HIO}_3 = 3\text{H}_2\text{O} + 3\text{I}_2$).

I have made similar bleaching solutions by using lime-water and baryta-water with aqueous iodine, and in nearly all respects these resemble Schönbein's solutions, there being perhaps a little difference in their stability in favour of the sodium and potassium compounds. They are all decomposed on boiling.

I have further found that, by using a little very finely divided (preferably precipitated) iodine with the aqueous iodine and then adding the alkali, very much stronger solutions may be prepared. A solution made in this way bleaches large quantities of indigo, and gives further reactions which add very strongly to the evidence that these solutions contain hypoiodites. Thus they give a black precipitate (on standing) with a cobalt solution; an immediate dark brown precipitate with a solution of a manganeous salt; and with lead salts a precipitate which manifestly contains a considerable amount of the brown peroxide of lead. Also these strong solutions give an immediate and copious evolution of oxygen with hydrogen dioxide. In these reactions the solution acts exactly as the corresponding hypochlorites and hypobromites do. The dilute solutions made with aqueous iodine naturally do not give these reactions so satisfactorily unless large quantities are used. On the other hand, the stronger solutions would not be so suitable for the quantitative experiments as the more dilute ones.

The solution made with iodine water and not too much alkali gives with nitrate of silver a precipitate which is quite distinct from the ordinary precipitated hydrate of silver, having a sort of dark buff colour. Of course the precipitate must contain silver iodide and probably also some hydrate, as the original liquid must of necessity be somewhat alkaline; but it probably also

contains some silver hypiodite. If the liquid is poured off or filtered off from the precipitate, it is found to have completely lost its bleaching power. On the other hand, if the precipitate is treated with a dilute acid, part of it dissolves up, leaving the yellow iodide of silver, and at the same time the solution acquires bleaching properties, though not to anything like the extent that would correspond to a complete transformation of the hypiodite into a silver salt, and then to hypiodous acid. In the two transformations a large amount of the hypiodite is evidently decomposed.

I have already mentioned that Schönbein was greatly puzzled to account for his bleaching solutions giving a deep blue colour with starch alone. Lunge and Schoch, in their paper, suggested that some iodine probably existed in the liquid in combination with potassium iodide. But a much more reasonable explanation had already been supplied by the experiments of E. Lenssen and J. Löwenthal (*Journal für praktische Chemie*, 1862, p. 245), who found that sodium iodide and hypiodite decompose each other, liberating iodine, and that the amount of alkali required to react with free iodine was greater when potassium iodide was present than when there was no iodide. They practically stated that the reaction



is a balanced one, and that the addition of potassium iodide reverses the action, which now produces potash and free iodine.

It follows that the amount of alkali required to complete the above reaction must be greater than that represented by the equation. I have added varying amounts of a standard solution of soda to the same amount of aqueous iodine. With one equivalent of

alkali to one of iodine the solution is distinctly yellow, and gives a deep blue colour with starch; with two equivalents of alkali the liquid is a very pale yellow, and the colour with starch is much less intense; with three equivalents the liquid appears colourless, and gives only a slight colour with starch, so that apparently the reaction is all but complete, and with four equivalents it is quite complete.

It is probable that the character of this reaction has something to do with the comparative failure to obtain bleaching solutions when using iodine dissolved in potassium iodide. It may also help to explain the fact that in the action of ozone upon potassium iodide the development of free iodine may proceed to quite a remarkable extent, considering that its liberation must be accompanied by the formation of an equivalent amount of potash. It is clear, however, that, as there is always a very large excess of potassium iodide present, this must tend to prevent the formation of any but the smallest amount of hypoiodite.

In 1882 the paper by Lunge and Schoch on Calcium Hypoiodite appeared. The authors criticised Schönbein's work at some length. They objected to the importance which Schönbein appeared to attach to the fact that his solutions gave an evolution of oxygen with hydrogen peroxide, pointing out that a mixture of potassium iodide and iodate does the same thing. There is a certain amount of weight in this objection, but not much. It is quite true that a mixture of iodide and iodate does evolve oxygen with hydrogen dioxide, but only either on standing or when gently warmed; whereas, as I have already pointed out, the stronger hypoiodite solutions which I have prepared give an immediate violent effervescence on the addition of the peroxide. Schönbein's dilute solutions certainly do not give oxygen

anything like so rapidly as these stronger ones, but still much more rapidly than a mixture of potassium iodide and iodate. I still consider, with Schönbein, that the immediate evolution of oxygen with hydrogen peroxide is a valuable indication that these solutions contain hypoiodites.

Lunge and Schoch prepared their "hypoiodite of calcium" by rubbing together for some time iodine with a large excess of lime and a comparatively small amount of water, allowing to stand for some hours, and then diluting with water. They thus obtained a solution which apparently resembled Schönbein's solutions in many respects, but gave "with cobaltous nitrate a green precipitate—*no black peroxide.*" It bleached cochineal, logwood, and indigo carmine just as Schönbein's solutions do.

The authors attempted to estimate the bleaching strength of the solution by means of a standard solution of indigo carmine, standardised against a dilute solution of bleaching powder, the strength of which was estimated by means of a standard solution of sodium arsenite. But they could not succeed in measuring the bleaching power of their iodine-lime solution directly, because towards the end the decolorisation was so extraordinarily slow. They therefore added an excess of indigo solution, and allowed to stand for 15 minutes; then excess of bleaching powder solution was added, and this excess finally brought back by a drop or two of sodium arsenite solution. In this way they estimated that in their solution 14.6 per cent. of the total iodine present existed as "bleaching iodine." They further stated that the solution, kept in the dark, gradually lost its bleaching power, but that only 76 per cent. of the bleaching action had disappeared at the end of 23 days. They also tried the effect of heating the solution, and found, on one

occasion, that when boiled for one hour, 52 per cent. of the bleaching power had disappeared. In another experiment a sample was boiled for seven hours, and then only lost 53 per cent. of its bleaching power!

It is evident that there are some irreconcilable discrepancies between these results and mine. In the first place, I never found any difficulty in estimating the bleaching power of a solution directly, except in the case where the bleaching is not permanent. Secondly, my solutions gave black precipitates with cobalt; and, in the next place, every bleaching solution that I have made is decomposed completely by boiling for, at most, four minutes. Judging from the analogous bodies, hypochlorites and hypobromites, and from the instability of hypoiodites on merely keeping them in the dark, it is inherently highly improbable that any hypoiodite could stand being boiled for seven hours! I have prepared what I should call calcium hypoiodite by adding lime-water to aqueous iodine, and it decomposes completely when boiled for three minutes. Whether the complicated method adopted by Lunge and Schoch for estimating the bleaching action has anything to do with these discrepancies I am not prepared to say, but it seems quite plain that if Schönbein's solutions consist of hypoiodites, then Lunge and Schoch's solution does not. I have tried to repeat Lunge and Schoch's experiments, following their directions, and have obtained a bleaching liquid which acts practically like Schönbein's solutions; that is, there is little or no difficulty in estimating the bleaching power directly, and it loses its bleaching power completely when boiled for a few minutes. If, also, as I should recommend, the iodine and lime are rubbed together with water, and then diluted *immediately*, instead of, as they recommend, allowing the mixture to stand for several hours, a solution is obtained three or four times as strong, which gives a

dark brown precipitate with cobalt; but this also is decomposed completely when boiled for a few minutes. It also gradually decomposes when kept in the dark, and a sample tested on one occasion, after being left for three days, had lost entirely its bleaching power.

Since the appearance of Lunge and Schoch's paper there have been occasional references to hypoiodites in other papers. Thus C. Lonnes (*Zeit. anal. Chem.*, 35, 409-436) has pointed out that the conversion of iodine into an iodide and an iodate by an alkali is not immediately complete, part remaining uncombined, and part being converted into hypoiodite, and that the hypoiodite has greater stability in presence of excess of alkali.

Chattaway (*Chem. Soc. Jour.*, lxi., p. 1572) has stated that in several of the decompositions which the so-called "Nitrogen Iodide" undergoes, hypoiodites are produced.

Quite recently (*Proc. Roy. Soc. Edin.*, xxi., 235) Dr. J. Walker and S. A. Kay, B.Sc., have published a paper on the so-called "Magnesium Hypoiodite," a brown substance formed by the union of magnesia, either wet or dry, with free iodine, and which has sometimes been supposed to be magnesium hypoiodite. They conclude, however, that it is simply a case of absorption of iodine, without any chemical combination. They find that this brown precipitate is produced when potash is added to a solution of iodine in potassium iodide until the iodine just disappears, and then a solution of magnesium sulphate is added, magnesium hydrate being precipitated, and iodine manifestly liberated. They have concluded from this that, as pointed out above, the reaction between iodine, potash, potassium iodide, and water is a balanced one.

HYPOIODOUS ACID.

So far as I have been able to ascertain, it has always been stated that all attempts to obtain hypoiodous acid by the action of iodine and water upon mercuric oxide have failed, and that nothing but iodic acid was formed.* I had tried the action once more with the aqueous solution of iodine, and had apparently been as unsuccessful as ever. I had succeeded, as I believe, in obtaining the acid by other methods, to be presently described, and had noticed the curious anomaly that the free acid, or what I took to be the free acid, bleached indigo with far less energy than the hypoiodites described in the first part of this paper; but I had failed, as others no doubt had frequently failed, to obtain any bleaching solution by the action of iodine and water upon mercuric oxide.

In the paper already referred to by Walker and Kay, the authors state that they "made a solution of hypoiodous acid by agitating pure aqueous solution of iodine

* So long ago as 1845 Köne (*Poggendorff's Ann.*, 66, p. 302) tried the experiment of shaking up precipitated mercuric oxide with an alcoholic solution of iodine, and, from the fact that he obtained an unstable solution which gradually liberated iodine, and from analogy with the chlorine compounds, he concluded that hypoiodous acid was formed. I have repeated the experiment, and there certainly appears to be a hypoiodous compound produced; the alcohol which is present, however, interferes with the reactions. The filtered liquid contains a considerable amount of mercury. It gives a yellowish precipitate with water, and if a little alkali is added to this it possesses very strong bleaching properties. The precipitate produced with water dissolves up in sodium hydrate, but in a few seconds another precipitate appears which is manifestly iodoform; at the same time the liquid loses its bleaching power. This appears to point to the conclusion that the formation of a hypoiodite is the necessary prelude to the formation of iodoform (see *Van Deventer and Van't Hoff, Chem. Central.*, 1888, p. 362). On account of this rapid change in presence of an alkali, the solution does not give the cobalt reaction. If the precipitate produced by water in the alcoholic solution is allowed to stand for some hours, scarlet mercuric iodide separates out. The alcoholic solution is moderately stable, but it gradually liberates iodine on standing.

with mercuric oxide," filtered, neutralised with potash, and added magnesium sulphate, so obtaining a white precipitate. The addition now of a few drops of potassium iodide *stained the precipitate brown*. This certainly pointed to the presence of a hypoiodite, which would be decomposed, with liberation of iodine, by potassium iodide. I thought the reaction might *possibly* be due to iodic acid, which is usually said to be the sole product of the action of iodine on mercuric oxide; but experiment convinced me that it was not. Further investigation soon showed that hypoiodous acid is really produced when iodine water is shaken up with mercuric oxide (the precipitated oxide is far the best) and filtered. Many others besides Walker and Kay have no doubt prepared the acid in this way but failed to recognise it. The explanation is that the bleaching action of the free acid is *excessively feeble* as compared with Schönbein's solutions. Contact with the indigo solution for a long time causes the colour slowly to disappear, *but the addition of a drop of alkali* immediately transforms the acid into as strong a bleaching solution as Schönbein's solutions.

I may at once state what appears to me a possible explanation of what seems at first sight a most extraordinary anomaly—that a free acid has a very much feebler oxidising power than one of its salts! When hypoiodous acid bleaches, I suppose it does so according to the following equation:—

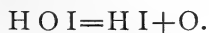

It thus produces hydriodic acid, an extremely unstable body itself, and, further, a compound which would immediately decompose the remaining hypoiodous acid. On the other hand, in presence of an alkali, the result of losing oxygen would be to produce sodium or potassium iodide, both perfectly stable bodies, and with any ten-

dency to decompose the remaining hypoiodite counteracted by the presence of the alkali. Then there is also the further consideration that apparently hypoiodous acid can only have about one-half the total bleaching power that a hypoiodite will have, because, as soon as any of it does bleach, it produces hydriodic acid, which would immediately decompose an equivalent amount of the remaining hypoiodous acid. (In one comparative experiment that I made, the bleaching power of the free acid was almost exactly half that of an equal volume of the same iodine solution to which soda had been added. But the bleaching continued for *two hours*, so that the effect would be complicated by the spontaneous decomposition of the free acid.)

When a little alkali is added to the hypoiodous acid prepared in this way, the solution behaves almost exactly like Schönbein's solutions. It bleaches strongly, and some determinations I have made with the standard indigo solution gave a bleaching action equivalent to 80% of the iodine used, that is, representing 40 out of a possible 50% of iodine existing as hypoiodous acid. This result again is confirmed by experiments by Schwicker's method, only in the case of this solution, when it is neutralised by an alkali, it forms nothing else but hypoiodite, and consequently the addition of soda-water simply liberates hypoiodous acid, and there is no separation of iodine. In order to complete the determination potassium iodide has to be added, when there is an immediate liberation of iodine. A determination by this method, which is probably more accurate than the bleaching method, gave liberated iodine equal to 90% of that originally used, so that 45 out of a possible 50% of iodine existed in the solution as hypoiodous acid.

The hypoiodous acid solution to which a little alkali has been added gives a precipitate with cobalt solution,

which gradually turns brown and then black, and an immediate brown precipitate with a manganous salt. With silver nitrate it gives a buff-coloured precipitate similar to the one I had previously obtained from Schönbein's solutions, but in this case of course it will not be mixed with so much silver iodide. If nitrate of silver is added to the solution containing the free acid a milkiness is produced, and on boiling there is a further precipitate, which contains silver iodide and iodate; the iodate can be dissolved out by ammonia. This reaction I had previously noticed with the acid prepared in another way. The hypiodous acid is manifestly converted into hydriodic and iodic acids:—



The aqueous solution of the free acid appears to be moderately stable. When it decomposes, as one would anticipate, it appears to do so according to the equation given above, only in this case the two acids immediately decompose each other, liberating iodine.* In the case of the solution made, as described, with the use of aqueous solution of iodine, the appearance of free iodine in the liquid is very slow; but, by using iodine-water with a little suspended precipitated iodine, a much stronger solution of the hypiodous acid is obtained, in which the brown colour of iodine begins to show itself within a minute or two of its being filtered. (It appears also that some mercury comes through, because on standing for some hours there is a slight deposit of the scarlet iodide of mercury.) After standing for some time, this solution,

* It will be somewhat difficult to measure the rate at which the hypiodous acid decomposes. Neither of the two methods mentioned in the text for estimating the amount of hypiodite is applicable when once the decomposition of the acid has started, because each of them would require the preliminary addition of a little alkali, and this would at once convert any liberated iodine into iodide and hypiodite.

which manifestly contains free iodine (carbon bisulphide shaken up with it is coloured deep violet), gives no blue colour with starch until the addition of a drop of alkali, or until it has been exposed to the air for some time. If a little of the mixture of the brown solution with starch is poured into a shallow vessel, or is poured backwards and forwards from one vessel to another, it soon turns blue.*

Some time before obtaining the free hypoiodous acid in the way described above, I had obtained what must have been either the acid or a solution of its silver salt by another method. It was pointed out by Dancer (*Chem. Soc. Journ.*, xv., 447) that hypobromous acid could be obtained by the action of bromine-water upon solution of nitrate of silver, according to the following equation:—



Chlorine acts in a similar way, producing hypochlorous acid. A solution of nitrate of silver with powdered iodine appears to form nothing but iodide and iodate of silver; but I found that iodine suspended in water gave a bleaching liquid when shaken up with solution of silver sulphate, or with a paste of silver carbonate, the carbonate giving the better result. Wishing to obtain some quantitative results, I began to use an aqueous solution of iodine, instead of having it merely suspended in water. Shaking up this solution with a little silver carbonate and rapidly filtering, a liquid is obtained which contains a small amount of silver, but which gives all the reactions which I have described as characteristic of Schönbein's

* Dr. A. Harden tells me that he has found that a mixture of aqueous iodine and iodic acid, in certain proportions, behaves in exactly the same way as the above solution. It is known that iodine forms no blue compound with starch unless an iodide be present; but I can offer no explanation of the effect which the air appears to have on the above reaction.

solutions, complicated a little, in some cases, by the silver which is present. It bleaches indigo slowly, but much more rapidly than the acid prepared with mercuric oxide; it also bleaches cochineal and logwood, and oxidises cobalt and manganese salts in presence of an alkali. The action of the iodine upon the silver carbonate may probably be represented by the following equation:—

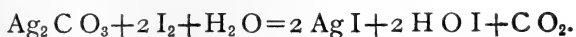

If a drop of silver nitrate is added to the solution and the liquid boiled, a yellow precipitate is produced, containing iodide and iodate of silver.

I made many attempts to ascertain, by various methods, the proportion of the iodine used which was converted into hypoiodous acid. I filtered the liquid into an acidified solution of potassium iodide, whereby iodine is liberated, the amount of which I estimated. Another method tried was to allow the liquid to run into a standard solution of sulphurous acid, and then to find the amount of this which was oxidised. The results were not satisfactory, as I seldom found that more than 50% of the iodine was converted into bleaching iodine. I have reason to believe that this result was due to some insoluble hypoiodite of silver being left in the precipitate. Finally I tried the standard indigo solution, and found that it was possible to estimate the bleaching power even in the muddy liquid containing the excess of silver carbonate and the silver iodide which was produced in the reaction. Shaking up a known volume of the iodine solution with silver carbonate and immediately running in the indigo solution, the bleaching action indicated about 50 to 60% of the theoretical amount; but the addition of a few drops of dilute sulphuric acid carried the bleaching power still further, owing no doubt to the decomposition of some insoluble silver hypoiodite by the acid. By adding the

dilute acid immediately after shaking together the iodine and the silver carbonate, a bleaching action was obtained equal to from 90 to 95% of the theoretical amount. Subsequently, I found that, with the aqueous solution of iodine, nitrate of silver reacts perfectly well, producing a bleaching liquid which gives all the reactions already described, complicated a little by the presence of excess of silver. The bleaching action, immediately after the silver nitrate has been added, indicates 95% of the theoretical amount.

The solutions prepared by the use of these silver salts are extremely unstable; that made with the silver nitrate loses 90% of its bleaching power on standing five minutes. This I think may be attributed to the presence of silver in the solution and to the tendency of the iodine and silver to form the insoluble silver iodide. The solutions prepared in this way are considerably more sluggish in their bleaching action than the alkaline hypoiodites, but very much more rapid than the free acid prepared by the mercuric oxide method. If the explanation which I suggested for the difference between the free acid and Schönbein's solutions is correct, it seems to me that it would apply in this case as well. There is silver present in the solutions, and therefore when the bleaching is finished the final product will be silver iodide, a much more stable body than hydriodic acid.

I have to thank Mr. G. P. Varley, B.Sc., and Mr. J. H. Wolfenden, B.Sc., for assistance given me in some portions of this work.

Central Board School, Manchester.

IX. Some further investigation of Fossil Seeds of the genus *Lagenostoma* (Williamson) from the Lower Coal Measures, Oldham.

By JOHN BUTTERWORTH, F.R.M.S.

Received February 17th, 1897. Read February 23rd, 1897.

[*Communicated by Mr. John Boyd.*]

In studying the remains of the plants that compose our coal seams it is as well to bear in mind that the names given to many of them are only provisional, and often derived from their resemblance to some well-known object. Such provisional names are convenient, as they can be readily dropped or changed when the true history and genus of the plant or fruit is known. Thus it is with the seeds under consideration, which have been named *Lagenostoma* by the late Professor W. C. Williamson, a name derived from the peculiar bottle-shaped mouth of the seed. Seeds of this genus run rather small in dimensions, varying from 1-10th to 1-4th of an inch in length and 3-64ths to 1-10th in breadth; but to give a better idea of their character, as they have been known up to the present, I exhibit a number of seeds, some of which are detached from the matrix in which they have been embedded, while others are still embedded but ground to transparency. I am not prepared to enter into any speculation as to the character of the tree or plant which bore these seeds, but am disposed to believe that

May 20th, 1897.

the seeds were borne in clusters, each seed being carried on a separate pedicel. In support of this view some seeds are shown that still retain the impression where the stalk has been attached, and in a paper read before the Geological Society in 1872 by Mr. Carruthers, he also figures *Cardiocarpon Lindleyi* as borne in clusters.

In Professor Williamson's eighth memoir (*Phil. Trans.* 167, 1878) he describes two species of *Lagenostoma*, *L. physoides* and *L. ovoides*; but it is the figure of *L. physoides* that represents the seeds under consideration.

From a careful reading of Williamson's description of this seed it appears that he had a slight suspicion that the seed was not perfect in all its parts; one common defect attending these seeds, which is very much against reading their structure correctly, is, that they are often surrounded with dark carbonaceous matter. This was the case with Williamson's seeds, and is also the case with many seeds in my own cabinet. I supplied Williamson with many seeds detached and partly embedded in the matrix, but I do not remember one that did not show the dark carbonaceous band, which is so opaque and requires to be ground so thin that the structure (when present) is often destroyed before it is ground thin enough. I refer to this carbonaceous matter so pointedly because it is quite clear to me that Williamson has been led astray by its alteration of the structure. In the batch of seeds just discovered the above carbonaceous matter is not present, and the structure of the respective parts of each seed is perfectly clear so far as it has been preserved. I should like here to direct attention to a statement Williamson made in his description of *L. physoides*. In his eighth memoir, p. 242, referring to Fig. 78b, he says "even the endotesta of the seeds being entirely absent"; but from my photographs (Plate 8)

it will be seen that the endotesta is in each case present, and I have not the least doubt that the absence of the endotesta in Williamson's seeds is due to the presence of so much carbonaceous matter. But there are other more marked differences between my recently discovered seeds and the one Williamson describes, for if we turn again to Figs. 77—78, we shall see that only one zone of tissue is shown, starting at the base of the canopy measuring downwards, whereas in three at least of my new seeds (Plate 8) three zones are shown, viz., taking the endotesta as one, the testa proper as the second, and the investiture of the thick body of hairs as a third. Another point of difference existing between my new seeds and Williamson's *Lagenostoma* is this, in all my seeds the testa is shown to be lobed longitudinally, and it is quite clear that the sides and crown of each lobe form the seat from which the hairs spring, but none spring from the spaces between the lobes; this feature is wholly absent in all Williamson's figures of *L. physoides* as well as *L. ovoides*. I may, however, remark that in my cabinet I have sections of seeds which show the testa surrounded by a series of very acute lobes, but no hairs spring from them. I do not think they have yet been described; at least Williamson has nothing figured that corresponds to them. I think the points of difference between my new seeds and Williamson's *L. physoides* will be clearly seen from the matter and material I have laid before you, yet I do not see that the difference is such as to warrant the removal of either from the genus *Lagenostoma*. They have both the peculiar bottle-shaped mouth, and this is the characteristic on which the genus rests at present. In conclusion, I wish to mention a curious coincidence in the finding of these new seeds: I found the block from which I took five photographs, but two of my

fellow-workers have fortunately picked up parts of the same block in which they have each met with one seed. The whole of these seeds have been found at one pit which has just been abandoned owing to the nodules in which the seeds and plants are found taking the place of the coal.

Description of figures in Plate 8.

Fig. 1 is a slightly tangential section of *Lagenostoma*. On the upper side, the section is cut through the centre of a lobe, and shows the hairs springing from it. On the lower side, the section is cut through the space between two lobes, and therefore shows few hairs.

Fig. 2 is an oblique section of another *Lagenostoma*. In it, the seed appears to have a continuous zone of hairs all round, but they spring only from about the crown of each lobe. The cavity passing down the centre of each lobe is shown at (A).

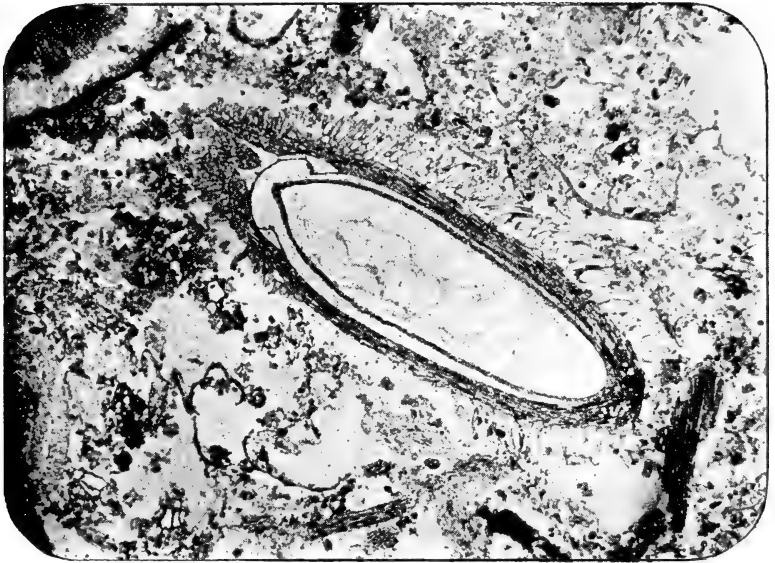

Fig. 1.



Fig. 2.



X. On Continuity.

By Professor HORACE LAMB, M.A., F.R.S.

Received and read March 9th, 1897.

A word or two of apology may possibly be needed for bringing before the Society a paper whose most definite results consist merely in new, or rather modified, proofs of one or two fundamental theorems in the Infinitesimal Calculus. It may, perhaps, be allowed to urge in excuse that although in the past English mathematicians have taken their share in discussions concerning the logic of the mathematical sciences, yet the particular subject at present in view, the Theory of Functions of a Real Variable, has as yet attracted very little notice in this country. It may also be said that the current proofs of the theorems referred to present little variety, and that the five or six treatises in which they are to be found reproduce the same steps in almost exactly the same order. There may, therefore, be some justification for an attempt to bring these theorems more immediately into connection with first principles. Of any fundamental novelty in the treatment of the matters involved there can, from the nature of the case, be no question; but opportunity is taken of insisting on a point which, simple as it is, is in some danger of being overlooked in the modern endeavours to establish the Calculus on a purely numerical basis.

1. It is necessary to explain, in the first place, the point of view from which the theorems referred to are developed. For reasons to be given further on, the

May 20th, 1897.

geometrical notion of magnitude is adopted. More precisely, it is assumed that every magnitude of the particular kind under consideration can be represented by a length OM , measured on an unlimited straight line $X'X$ from a fixed origin O on it, to the right or left, according as the magnitude is positive or negative. To every magnitude of the kind in question there corresponds, then, a definite point M , and when we say that a magnitude admits of "continuous variation," it is implied that the point M may occupy *any* position on the line $X'X$, within (it may be) a certain range.

Algebraically, any magnitude is represented by a symbol, such as x , denoting the ratio which it bears to some standard magnitude of its own kind. It is immaterial, for our present purpose, what basis we adopt for a precise definition of the term "ratio."

2. Suppose, now, that we have an endless sequence of magnitudes of the same kind

$$x_1, x_2, x_3, \dots \dots \dots (I),$$

each greater than the preceding, so that the differences

$$x_2 - x_1, x_3 - x_2, x_4 - x_3, \dots$$

are all positive. Suppose, further, that the magnitudes (I) are all less than some finite quantity a . The sequence will, in this case, have an "upper limit"; that is to say, there will exist a certain quantity μ , greater than any one of the magnitudes (I), but such that, if we proceed far enough in the sequence, the members will ultimately exceed any assigned magnitude which is less than μ .

This has been justly characterised by Dedekind* as the fundamental theorem of the Calculus. The proof, from the geometrical point of view, is of course almost intuitive.

* *Stetigkeit und irrationale Zahlen* Brunswick, 1872.

In the geometrical representation, the magnitudes (1) are represented by a sequence of points:—

$$M_1, M_2, M_3, \dots \dots \dots (2),$$

each to the right of the preceding, but all lying to the left of some fixed point A . Hence every point on the line $X'X$, without exception, belongs to one or other of two

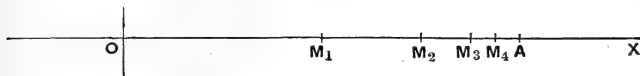

mutually exclusive categories. Either it has points of the sequence (2) to the right of it, or it has not. Moreover, every point in the former category lies to the left of every point of the latter. Hence there must be some point M , say, such that all points to the left of M belong to the former category, and all points to the right of it to the latter. Hence, if we put $\mu = OM$, μ fulfils the definition of an “upper limit” above given.

3. One variable quantity is said to be a “function” of another, when, other things remaining the same, if the value of the latter be fixed, that of the former becomes determinate. This definition is due to Dirichlet; all that it implies is that for each value of the independent variable there is one, and only one, definite (and therefore finite) value of the dependent variable, or function.

The definition of a “continuous function” is a matter of some nicety, the difficulty being apparently to frame a definition which shall not merely be sufficient, but shall embody a test which can be immediately applied to any proposed analytical function. The definition now usually adopted is as follows :

Let x and y be corresponding values of the independent variable and of the function. Let δx be any admissible increment of x , and δy the corresponding

increment of y . Then if, σ being any positive quantity different from zero, we can always find a positive quantity ϵ , different from zero, such that for all admissible values of δx which are less (in absolute value) than ϵ , the value of δy will be less in absolute value than σ , the function is said to be "continuous" for the particular value x of the independent variable.

As already indicated, this test can be easily applied to particular cases; but it does not lend itself very readily to the proof of general theorems. The reason is that the definition does not warrant us in making any statement whatever about the value of the function for any value of x other than the one referred to, however near. In the ignoring of this consideration lies a fruitful source of fallacies.

4. We may construct a mental representation of the relation between two variables x, y ; one of which is a function of the other, by taking rectangular co-ordinate axes $X'OX, Y'OY$. If we measure OM along OX to represent any particular value of the independent variable x , and ON along OY to represent the corresponding value of the function y , and if we complete the rectangle $OMPN$, the position of the point P will indicate the values of both the associated variables.

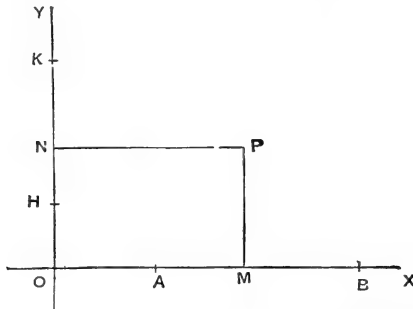

Since, by hypothesis, M may occupy any position on $X'X$, between (it may be) certain fixed termini A, B , we

obtain in this way an infinite assemblage of points P . But we are not entitled to assume that this assemblage, even in the case of a continuous function, constitutes a *curve*, in the ordinary acceptation of the word. Indeed, one of the most remarkable achievements of the modern Theory of Functions is the discovery of continuous functions possessing properties which transcend our faculties of even mental representation.

5. After these preliminaries, which have necessarily consisted in a recapitulation of known matters, we can proceed to the theorems more especially in view.

I. A continuous function cannot change sign without passing through the value zero.

Let $\phi(x)$ be a function of x which is continuous from $x=a$ to $x=b$, where $b > a$, inclusively; and let us suppose, for definiteness, that $\phi(a)$ is positive, and $\phi(b)$ negative. In the geometrical representation, let $OA=a$, $OB=b$, $AH=\phi(a)$, $BK=\phi(b)$. In virtue of the continuity of

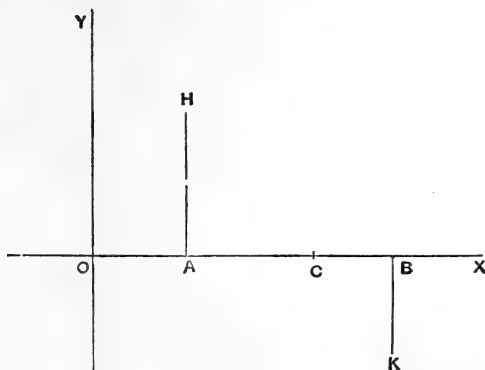

$\phi(x)$ there is a certain range extending to the right of A , at every point of which $\phi(x)$ differs from AH by less than AH , and is therefore positive. Similarly, there is a certain range extending to the left of B at every point of which $\phi(x)$ is negative. Hence the points of the range AB ,

without exception, belong to one or other of two mutually exclusive categories; either they have to the left of them points for which $\phi(x)$ is negative, or they have not. Moreover, every point of the former category lies to the right of every point of the latter. Hence there must be some point C between A and B , such that every point to the right of C belongs to the former category, and every point to the left of it to the latter. Further, at the point C itself, the value of $\phi(x)$ must be zero. For if it were positive, then, in virtue of the continuity, there would be points to the right of C for which $\phi(x)$ is positive; and if it were negative there would be points to the left of C for which $\phi(x)$ is negative. Either of these suppositions is inconsistent with the above determination of C .

It follows, in the usual manner, that a continuous function cannot change from one value to another without passing once (at least) through every intermediate value.

II. In every finite range of the independent variable, a continuous function has a greatest and a least value.

More precisely, if $\phi(x)$ be a function which is continuous from $x=a$ to $x=b$, inclusive, and if μ be the upper limit of the values which $\phi(x)$ assumes in this interval, there is some value of x in the interval for which $\phi(x)=\mu$. Similarly for the lower limit.

To those who are accustomed to associate with every function a graphical representation, the theorem may appear to be self-evident. If the matter be reviewed after studying a rigorous proof, or (better still) after attempting to construct an independent proof, it will be seen that the fallacy (for such it is) in this supposition is due to the fact that every line which we can draw on paper, or even mentally picture to ourselves, has a certain breadth.*

* See F. Klein, *Ueber den allgemeinen Functionsbegriff, und dessen Darstellung durch eine willkürliche Curve*, Math. Ann, vol. 22, p. 249.

Similarly, there will be a certain range, extending to the right of M_1 , but not reaching to B , at every point of which y is not greater than $\mu - \frac{1}{2^2}\sigma$, let M_2 mark the extremity of this range. Proceeding in this way we get an ascending sequence of points

$$M_1, M_2, \dots M_n, \dots$$

the property of M_n being that at all points to the left of it y is not greater than $\mu - \frac{1}{2^n}\sigma$, whilst every point to the right of M_n will have points to the left of it at which this condition is violated. At M_n itself we must have

$$y = \mu - \frac{1}{2^n}\sigma.$$

By the reasoning of § 2, the sequence

$$M_1, M_2, M_3, \dots M_n, \dots$$

will have an upper limit M (say). Moreover, at this point M we must have

$$y = \mu,$$

exactly. For, if not, let y_1 be the value of y at this point, and let y' be a quantity between y_1 and μ . Then in virtue of the continuity, there will be a certain range extending to the left of M for every point of which $y < y'$. But by the preceding argument, any such range will contain an infinite number of points belonging to the above sequence, and will, therefore, contain points for which the value of y differs from μ by as little as we please, and for which therefore $y > y'$. The contradiction shows that y_1 cannot differ from μ .*

6. The above investigations have been clothed in a geometrical form, and it remains to consider how far this affects the essence of the demonstrations.

* The diagram is intended merely to exhibit the mode in which the successive points M_1, M_2, M_3, \dots are determined. If $OK = \mu$, then, in the figure, N_1 bisects HK_2 , N_2 bisects N_1K , and so on.

For a function which can be *adequately* represented by a curve, the proof is superfluous, as already indicated.

So far as regards the representation of functional relations by Cartesian co-ordinates, this is merely a mode of expression. We have not assumed any property of the assemblage of points representing a continuous function which is not contained in the formal definition.

It is otherwise with the fundamental conception of continuous magnitude from which we started in § I. As the method here followed runs counter to the arithmetical tendency which is so marked a feature of the modern Theory of Functions, some remarks are called for in justification. In the writer's opinion, the question as to whether a geometrical or an arithmetical basis is the more appropriate foundation for the Calculus cannot be answered absolutely. It is a question of point of view. But in some of the most important applications of the Calculus, it would appear that the geometrical basis is not only legitimate, but is imposed on us by the nature of the case. As regards Analytical Geometry this is a truism; but it is perhaps not so generally recognised that the whole of Mathematical Physics is in the same case.

A few instances will suffice to make this clear. In Dynamics, the ideal clock consists of a point describing a straight line; it follows that *time* in this subject has exactly the same kind of continuity as *length*. A *velocity* is a distance described in some standard time; a *mass* is the ratio of two velocities acquired in the same time under certain conditions; and so on.

It is when we pass from the ideal representations of things which we construct in Theoretical Physics to the question of concrete measurement that the arithmetical view of the subject claims special attention. This lies, however, beyond the scope of the present paper.

XI. The Costs of Sea Transport in proportion to Values of Cargoes.

By A. W. FLUX, M.A.

Received and read March 9th, 1897.

Among the many causes which have been assigned for the extraordinary and persistent fall in general prices during the past quarter of a century, some considerable prominence has been given to the cheapening of transport. There can be no doubt that the railway and the steamship have contributed in no small degree to enabling raw products to reach our shores in abundance, and to distributing cheaply the products of our mills, factories, mines, &c. It is worth inquiry, however, to what extent the reductions in cost of carriage have *directly* contributed to the fall of prices. The importance of this element is by no means entirely disposed of, even were it proved that the whole costs of handling and transmission of goods had been reduced far less in proportion than prices have fallen. To this point I shall return later. At present it is sufficient to note that it is important to determine, if possible, what proportion of the fall in prices has been offset by a reduction in the costs of transportation.

May 20th, 1897.

The investigation of this question on a thoroughly satisfactory basis seems hardly possible, even were the information available far more abundant and reliable than, in reality, it is. One section of the inquiry has been taken up by Mr. W. E. Bear and others, and it appears to have been established, if the figures quoted are really fair *representative* figures of prices and freights, that, great as has been the fall in the cost of carriage of wheat by sea, it has no more than kept pace with the fall in the wholesale price of wheat in English markets.

My attention was attracted to another mode of examining the question than that of taking quotations of freights and comparing them with the price-variations of the leading commodities one by one. The course of inquiry I propose to lay before you is by no means one which is unencumbered with numerous pitfalls. In fact, it has seemed to me that to pick one's way safely and securely through the various difficulties of the official returns which must be used, is a task which may be compared with that of riding a pneumatic-tyred bicycle along a country lane strewn with prickly twigs from the hedges on either side. He must exercise great care who would succeed in getting through the lane without a serious puncture.

The method I propose to adopt is to compare the values of the totals of the trade between selected pairs of countries, as represented by the returns of the Customs Houses at either end of the journey. On the one side we shall have recorded the values of goods exported from country A to country B, on the other the values of the same goods regarded as imports to country B from country A. If we could rely on the accuracy of both estimations, the differences shown would represent the various charges for freight, insurance, and commissions or

profits. The greater part would be freight, and we should be provided with a means of comparing the freight charges with the values of the goods entering into the trade, not piecemeal, but in bulk.

Unfortunately it will not do to select at random our pairs of countries for such a comparison. In the case of the trade between France and Germany, for example, the German records of imports are uniformly below the French records of exports. Our own imports from Germany are recorded at lower figures (since 1889) than the German exports to this country. I cannot pretend to give all the reasons for such divergencies in the records. One influential cause in the latter case may be that a considerable quantity of goods from Germany reach us *viâ* Holland or Belgium, and are accredited to the country of latest departure in place of that of ultimate origin. Similarly the French records include goods passing through Germany to other countries; the German figures which apparently apply to the same goods only include imports for German consumption. So far as possible liability to error from such causes as these must be guarded against.

Next we come to a source of error more difficult to treat, namely, systematic under- or over-valuation of the goods concerned on one or both sides of the account. Protective duties are a powerful stimulant to an under-valuation of imports. A notable example is afforded by the case of our trade with the United States of America, from which I had hoped to obtain valuable evidence on the subject of inquiry. During the five years ending 1880 American records of imports from the United Kingdom showed an annual average of $27\frac{1}{4}$ millions sterling. Our records of exports to America showed an average of $24\frac{1}{4}$ millions. The difference of $12\frac{1}{2}\%$ is a not unreason-

4 FLUX, *Costs of Sea Transport in proportion to Values.*

able allowance for freight and commissions. During the succeeding five years, the records on both sides averaged about $35\frac{1}{4}$ millions sterling yearly. Then comes a change, and, in the ten latest years of the record the averages have been: American imports from United Kingdom, £34,000,000; British exports to America, rather over £40,000,000. The goods have lost some 15% of their value in their journey across the Atlantic. Apart from this fatal weakness, the American system of valuing imports at their value in the country of origin would deprive us of useful evidence on this part of the trade. Before leaving the American trade, it may not be amiss to record the comparison of the figures of the movement eastwards to us. The British figures of imports exceed the American figures of exports by 15% in 1876-80, by $7\frac{1}{2}$ % in 1881-85, by $11\frac{1}{2}$ % in 1886-90, and by 7% in 1891-95. The fact that the American official year ends in June will not seriously disturb the comparison of five-year averages.

The last point mentioned makes it advisable to state that the comparison of the figures year by year cannot in any case be entirely satisfactory. Goods are exported from one country in the later months of one year and there recorded as exports, but may not reach their destination till the next year has begun, and thus fall into a different year when regarded as imports. The movement of this kind may easily differ considerably in successive years, but the irregularity will be slight when spread over the records of three, five, or more years. Similarly the differences in the dates at which accounts are made up (those of India, for example, being made up to March 31st) will not seriously disturb averages extending over three years at least.

For the purposes of the inquiry to be made, I shall take the United Kingdom as one of the countries in the

comparison in every case, if for no other reason than because changes in tariffs, and complicated and comprehensive systems of import duties, will not be liable to disturb the basis of comparison on one side of the account at least. If the valuations are less accurate at one time than at another, it will not be by reason of efforts to escape newly-imposed exactions. For the other side of the comparison it is desirable to select a country not likely to be greatly affected by transit-trade, that is, one with which our trade as recorded approximates closely to the trade as it exists in reality. The movement in each direction should be, as far as possible, a direct movement, not a movement *viâ* a third country. We have, also, to exercise care in regard to the inclusion or exclusion of bullion and specie, some countries including, others excluding, treasure in their trade accounts.

We proceed, then, with the examination of the records. By way of preliminary, the comprehensive survey of the trade of the world given by Dr. von Juraschek may be noticed. It is as follows (amounts in millions of marks):—

Average of the years		Imports of the world.		Exports of the world.		Excess Imports per cent.
1880-84	..	35,071 ₂	..	30,587 ₂	..	14·7
1885-89	..	33,632 ₇	..	29,213 ₁	..	15·1
1890-94	..	37,678 ₉	..	32,485 ₁	..	16·0

There are so many sources of error in such comprehensive estimates as that here quoted that it is not advisable to rely upon their indications too implicitly; on the other hand, the very fact of the errors being numerous and independent may give a total not affected by large errors. Taking the figures *quantum valeant*, they do suggest that the low freights of the present day

are a greater burden on trade than the heavier charges of former times. (See Plate 9).

To approach more nearly to the case where we can examine the details on both sides of the account with some approach to precision, we may take the case of the trade between the United Kingdom and British Possessions abroad. The Channel Islands, Gibraltar, Malta, and Hong Kong are omitted on both sides of the estimate, for lack of complete returns. As bullion and specie are included in the greater part of the Colonial returns, we must include them also in the home side of the account. Before passing to the aggregate values of this trade, it may be worth while noting that a useful piece of information is contained in the latest *Statistical Abstract for the Colonies*. In the case of Barbados, before 1893 the imports into the colony were entered at their values at the port of shipment. An estimated amount for freight insurance and value of packages was included from that date, and the addition to the values of the total imports of the colony was 21·4% in 1893, 15·9% in 1894, and 13·3% in 1895. So also with the Gold Coast, where a similar change in 1894 resulted in an increase of 15·3% on the value as estimated at the port of shipment, and in 1895 the addition was 14·7%. In the latter case the imports from the United Kingdom are separately given, and the charges for freight, &c., on these were 13·4% and 14·3% respectively in 1894 and 1895.

Such changes in the mode of record as these would, if they affected any large amount of the trade, render any attempt at comparison with former years comparatively valueless unless the figures were corrected for these errors. The great bulk of the trade, however, has not undergone any such change in the mode of record

during the past twenty years, to which the following comparison is confined (the total movement is shown in Plate 10) :—

AVERAGE VALUE OF TRADE BETWEEN THE UNITED KINGDOM AND THE COLONIES IN QUINQUENNIAL PERIODS (IN THOUSAND £).

Average of	Exports.	Imports.	Excess of Imports per cent.	Shipping employed. Thousands of tons cleared or entered.	Amount of excess per ton of shipping.
1875-79.					
To Colonies	74,270 ..	80,790 ..	8·8 ..	4,014 ..	32/6
From Colonies..	72,630 ..	87,723 ..	20·8 ..	3,532 ..	85/6
Total trade			14·7 ..	7,546 ..	57/3
1880-84.					
To Colonies	88,790 ..	96,951 ..	9·2 ..	5,185 ..	31/6
From Colonies..	83,280 ..	99,395 ..	19·3 ..	4,039 ..	79/9
Total trade			14·1 ..	9,224 ..	52/6
1885-89.					
To Colonies	89,078 ..	97,942 ..	9·9 ..	5,541 ..	32/-
From Colonies..	78,875 ..	92,434 ..	17·2 ..	4,020 ..	67/5
Total trade			13·3 ..	9,561 ..	47/-
1890-94.					
To Colonies	89,722 ..	96,460 ..	7·5 ..	5,336 ..	25/3
From Colonies..	90,484 ..	107,487 ..	18·8 ..	4,477 ..	76/-
Total trade			13·2 ..	9,813 ..	48/4

The reduction in the costs of transport, in proportion to the value of the goods handled, is not very marked here, especially in the case of the movement towards this country. It may be fairly remarked that the records of the outward movement might be expected to show evidence of such undervaluation in the imports as has been already noted in the trade with America. The same cause would produce but little effect on the homeward movement. The comparison made in the last column is suggestive. It should be remarked, however, that, even if it be just to exclude transhipped goods from the comparison of direct imports and exports (to include them would not affect the main point, the change in the proportion of transport charges to values), these goods

8 FLUX, *Costs of Sea Transport in proportion to Values.*

are carried by the ships included in the summary, and their inclusion would make some difference in the final column of the table.

There is something unsatisfactory, however, in dealing with an aggregate of such a heterogeneous character as that obtained by summing the trade of our various colonies. We, therefore, proceed to particularise further, and examine our trade with Australia and New Zealand. We are here freed from complications arising from an inclusion on one side of the account of home products (or goods for home consumption) only, while the other side includes goods in transit in addition to the former. There appears, however, to be room for considerable error yet, for we are informed that goods arriving (say) from Japan in a British ship at Sydney and thence proceeding to Melbourne are commonly entered as Japanese imports in Sydney and again as British goods in Melbourne. What the extent of error from this cause may be is quite impossible to gauge. The import duties, again, may be expected to act as a depressing cause of values of imports. Changes in the pressure of Customs dues may vitiate comparisons of one period with another. Export dues, where levied, may also be expected to have an analogous effect. The question of transhipped goods is a serious one, for a value varying from about £600,000 per annum to more than the double of this is transhipped in this country for Australasia, and *may* be included in the goods there recorded as imported from the United Kingdom. The following comparison omits these, but includes bullion and specie. As to these transhipped goods, if we admit them to the account, we shall, in several years, have a result with Australasia analogous to that with America, namely, goods going half way round the world without gaining in value.

In order to include the latest available returns, those for 1895, we shall take periods slightly different from those adopted in the other cases. (See also Plate II).

TRADE BETWEEN THE UNITED KINGDOM AND AUSTRALASIA

(IN THOUSAND £).

Average or	Exports.	Imports.	Excess of Imports per cent.	Shipping employed. Thousands of tons cleared or entered.	Excess per ton of Shipping.
1871-75.					s. d.
To Australasia	17,571 ..	18,926 ..	7.7 ..	465 ..	58/2
From Australasia..	21,624 ..	24,467 ..	13.1 ..	246 ..	231/-
Total trade			10.7 ..	711 ..	118/-
1876-80.					
To Australasia	19,973 ..	22,341 ..	11.8 ..	574 ..	82/6
From Australasia..	22,579 ..	27,306 ..	20.9 ..	352 ..	268/-
Total trade			16.7 ..	926 ..	153/-
1881-85.					
To Australasia	27,152 ..	30,712 ..	12.9 ..	892 ..	80/-
From Australasia..	25,935 ..	28,848 ..	11.2 ..	542 ..	107/6
Total trade			12.2 ..	1,434 ..	90/3
1886-90.					
To Australasia	25,526 ..	28,691 ..	12.4 ..	956 ..	66/-
From Australasia..	26,191 ..	28,028 ..	7.0 ..	594 ..	61/9
Total trade			9.7 ..	1,550 ..	64/6
1891-95.					
To Australasia	21,228 ..	23,794 ..	12.1 ..	850 ..	60/4
From Australasia..	31,126 ..	35,902 ..	15.3 ..	819 ..	116/7
Total trade			14.0 ..	1,669 ..	88/-
Total trade of 25 years					
1871-95.					
To Australasia	557,257 ..	622,320 ..	11.7 ..	18,687 ..	69/7
From Australasia..	637,276 ..	722,764 ..	13.4 ..	12,770 ..	134/-
Total trade			12.6 ..	31,457 ..	95/8

The outward costs appear to keep fairly steady, but not to diminish relatively to the value of the goods carried. The homeward costs show so much irregularity that it is not easy to say what is the tendency. The six years 1883-88 showed extremely low costs, averaging only 6%.

Turning now to the trade with India, we are met with a difficulty which had indeed presented itself in the consideration of the Colonial trade, but, as the argument was not to rest entirely on the deductions from that comparison, was passed unnoticed then. The question is, what rate of exchange shall be used for comparing the Indian with the British returns. I have adopted the average rate realised by the Secretary of State by sales of Council Bills. It is, I think, probable that this may be rather too low, making the Indian values less than those which would be obtained if we could know the average rate obtained for all mercantile bills. Even if Council Bills do not, as a rule, sell somewhat below the average rate of first-class mercantile bills, there is a deduction which should be made for the fact that we want the average sight exchange, while the average of Council Bills includes, especially in the earlier years, a large proportion of paper dated forward, even though it have not long to run. The effect of taking the exchange uniformly too low would be to make the costs appear too small on the outward trade, too large on the homeward trade; but, taking both together, the result would not be appreciably affected unless the error in exchange were considerable, or the difference between the values of the two currents of trade very considerable. Changes in Indian tariffs may somewhat derange the comparison, as noted in other cases. The difference in the dates at which the Indian and English official years close causes a further slight error, but, by comparing the records of the English years beginning in January with those of the Indian official years beginning on the following first of April, not much error will affect quinquennial aggregates from this cause. (The total yearly movement is shown in Plate II).

The following table shows the course of

TRADE BETWEEN INDIA AND THE UNITED KINGDOM
(IN THOUSAND £)

Average of	Exports.	Imports.	Excess of Imports per cent.	Shipping engaged (from Indian records). Thousands of tons.	Excess per ton of Shipping.
					s. d.
1875-79.					
To India	24,653 ..	27,709 ..	12·4 ..	1,299 ..	47/-
From India	23,816 ..	28,711 ..	20·5 ..	1,394 ..	70/3
Total trade ...			16·4 ..	2,693 ..	59/-
1880-84.					
To India	31,821 ..	35,601 ..	11·9 ..	1,476 ..	51/3
From India	28,183 ..	35,200 ..	24·9 ..	1,498 ..	93/8
Total trade			18·0 ..	2,974 ..	72/7
1885-89.					
To India	32,382 ..	36,158 ..	11·7 ..	1,542 ..	49/-
From India	25,661 ..	32,301 ..	25·9 ..	1,432 ..	92/9
Total trade			17·9 ..	2,974 ..	70/-
1890-94.					
To India	31,375 ..	33,818 ..	7·8 ..	1,406 ..	34/9
From India	21,822 ..	29,860 ..	36·8 ..	1,288 ..	124/4
Total trade			19·4 ..	2,694 ..	77/10

The figures of this table can hardly be explained without the assumption that the Indian valuations in the records used were on the basis of rates of exchange higher than those obtained for Council Bills at the time, or, possibly, an over-valuation of exports on this side, valuations at former rates being used while prices have fallen. Such a fact, however, will not overbalance the upward tendency of transportation charges, regarded as a proportion of values of the goods concerned, to which these figures point. It should further be remarked that the figures of shipping in the above table include entrances and clearances in ballast or light. They are taken from the Indian returns.

12 FLUX, *Costs of Sea Transport in proportion to Values.*

To try what influence the trade of neighbouring Colonies has on the returns, we examine the

TRADE BETWEEN THE UNITED KINGDOM AND INDIA, CEYLON, MAURITIUS,
AND THE STRAITS SETTLEMENTS (IN THOUSAND £).

Average of	Exports.	Imports.	Excess of Imports per cent.	Shipping Employed. Thousands of tons cleared or entered.	Excess per ton of Shipping.
1875-79.					s. d.
To the East	35,681	.. 37,528	.. 5'2	.. 1,525	.. 24/2
From the East ..	30,897	.. 37,294	.. 20'7	.. 1,111	.. 115/-
Total trade			12'4	.. 2,636	.. 62/6
1880-84.					
To the East	41,968	.. 46,153	.. 10'2	.. 1,907	.. 43/11
From the East ..	33,672	.. 42,497	.. 26'3	.. 1,339	.. 131/9
Total trade			17'2	.. 3,246	.. 80/1
1885-89.					
To the East	42,827	.. 47,181	.. 10'2	.. 2,047	.. 42/6
From the East ..	31,885	.. 40,251	.. 26'2	.. 1,411	.. 118/7
Total trade			17'0	.. 3,458	.. 73/7
1890-94.					
To the East.. . .	43,769	.. 45,833	.. 4'8	.. 1,886	.. 21/11
From the East..	30,520	.. 40,821	.. 33'7	.. 1,347	.. 152/11
Total trade			16'8	.. 3,233	.. 76/5

It is tolerably clear that the values on arrival in the East and on departure thence are under-stated. To correct this error would, as may be seen by a brief consideration of the figures, rather increase the total excess of imports on the whole trade, if the percentage error be not greater for the goods at shipment than for those valued at arrival. (The yearly movement is shown in Plate 12.)

The returns of shipping here employed are those of the United Kingdom, and do not include ships light or in ballast, as do the Indian returns.

Turning now, as a last comparison, to our trade with the Scandinavian Peninsula, we obtain the following record of

TRADE BETWEEN THE UNITED KINGDOM AND NORWAY AND SWEDEN

(IN THOUSAND £).

Average of	Exports.	Imports.	Excess of Imports per cent.	Shipping engaged. Thousand tons.	Excess per ton of Shipping.
1875-79					s. d.
To Norway and Sweden ..	5,641 ..	6,889 ..	22·1 ..	1,125 ..	22/2
From Norway and Sweden	7,607 ..	9,568 ..	25·8 ..	1,926 ..	20/4
Total trade			24·2 ..	3,051 ..	21/-
1880-84.					
To Norway and Sweden ..	5,310 ..	6,850 ..	29·0 ..	1,412 ..	21/10
From Norway and Sweden	8,837 ..	11,038 ..	24·9 ..	2,217 ..	19/10
Total trade			26·4 ..	3,629 ..	20/7
1885-89.					
To Norway and Sweden ..	5,303 ..	7,240 ..	36·5 ..	1,715 ..	22/7
From Norway and Sweden	8,897 ..	11,055 ..	24·2 ..	2,388 ..	18/1
Total trade			28·8 ..	4,103 ..	19/11
1890-94.					
To Norway and Sweden ..	6,574 ..	8,689 ..	32·2 ..	2,180 ..	19/5
From Norway and Sweden	10,343 ..	11,918 ..	15·2 ..	2,806 ..	11/3
Total trade			21·8 ..	4,986 ..	14/10

In this case, if we trust the evidence of the figures, the burden of transport charges rather grew heavier than lighter till the last four or five years, when, by a great reduction in the homeward charges, the burden has been considerably lightened, becoming less than in the latter half of the seventies. In the outward trade the charges are recorded as heavier than formerly, though, in proportion to the shipping employed, lighter. (See also Plate 12.)

If any reliance can be placed on the official returns of trade, we are bound to conclude, from such examination of them as precedes, that the costs of transport have not, in general, sensibly decreased in proportion to the value

of the goods handled, so far as sea-carriage is concerned. No conclusion as to railway charges or cost of carriage by road is here even suggested. If we are compelled, by facts relating to actual charges, to reject this conclusion, we are left in the uncomfortable situation of being compelled to distrust the indications of the progress and distribution of our country's trade which we have believed to be, not indeed thoroughly trustworthy in detail, but at any rate roughly accurate, sufficiently so to enable a tolerably correct judgment of the actual progress of trade with different parts of the world to be framed upon their indications.

I hoped to be able to put before you some actual comparisons which might help to decide which of these alternatives was the closer to the truth. As yet, however, the material for this has not come to hand. I hope I may obtain it before long.

The object of comparing the various trade movements by value with the shipping recorded as concerned in them was, originally, to gain some clue to the progress of trade not too much involved in price-changes, in accordance with the well-known methods of Sir Rawson Rawson. The actual comparisons made in the final columns of the preceding tables must not be read as efforts to determine the average freight paid in each class of trade. Apart from all liabilities to error, in many, if not in most, cases, several other items of charge will be included in the amounts there named. Unless the nature of the errors entering into the returns are such as to have undergone considerable changes in amount during the twenty years considered, however, the question of growth or diminution of such charges in the aggregate should be reflected in these figures, even though the actual magnitude of the charges be totally misrepresented in every case. It is

this question of variation, *not* the question of amount, in regard to which I have desired to make inquiry. (See, however, Appendix.)

Regarding the matter from a very simple standpoint, it may appear to many to need no demonstration that the proportion of transportation charges to values has not greatly decreased, and this for two reasons.

The first is that, taking for argument's sake the figure of 15% as a rough average of such charges, even if goods were conveyed, packed, and handled for nothing, and agents gave their services freely without reward, the amount of decrease thus rendered possible in values would fall far short of the actual recorded decrease. The other reason is that goods are nowadays sent long distances by sea, whose value, compared with their bulk or weight, is far below what could have profitably been sent in former times, and this apart from any fall in prices, the nature of the goods themselves being the point in question. Lower charges per ton may easily be an even greater percentage than formerly of the value of goods now entering largely into international trade, but which were not then able to present to dealers any hope of profit, owing to the expense of carriage. For this reason, among others, a comparison of the value of goods with the tonnage concerned in conveying them is of importance.

Lowered freight charges would, we might expect, operate on market values with a power not at all adequately represented by the mere fall in freights themselves. By increasing supplies of some articles a competition is established not only between those having the increased supplies from new sources to dispose of, but between these and persons who struggle desperately, but, in the main, vainly, to prevent the stream of productive effort from being deflected from its accustomed channels, preferring lowered

profits and a poorer livelihood to the risks of changing occupation.

To determine whether or not the stimulus to the fall in prices was provided by reduced transport charges is not easy. If we could know with certainty which of these movements was first in point of time, we might be assisted in our judgment. I do not know that it would be easy to provide an answer to the question of priority.

An important reflection on the result is this: that the great improvements in facilities of transport do not appear to have released any fraction of the energies of the world *from* the task of conveying materials from places where they are (comparatively) of slight value to places where they are (comparatively) of great value *to* the task of altering the form of the materials or their nature so as to fit them for the service of mankind. In fact, regarding the relative increases in steam-power in the two classes of industry, the conclusion, altogether apart from anything advanced in these pages, would be that transport occupies a larger proportion of the energies of the world than formerly. Cognate to this is the further fact that the series of handlings between the wholesale seller and the retail buyer absorb also a larger proportion of value than formerly, and that the fall in wholesale prices is only partially reflected in retail prices.

APPENDIX.

It seems desirable to make some attempt at testing the probability of truth in the figures here given. As I have no new figures of actual freights paid, I may be allowed to refer to figures given by Mr. Stephen Bourne and Sir Robert Giffen in papers published by them. In 1875 Mr. Bourne stated, in a paper read before the Royal Statistical Society, that a careful series of calculations

referring to freights actually paid on cotton from America and on corn, tea, sugar, timber, &c., from (apparently) other countries for twenty years preceding that date showed that $8\frac{1}{2}\%$ to $12\frac{1}{2}\%$ was added to the value by the freight, and estimated that 11% might be considered a fair average. Also, from ascertained import freight lists of ships for a series of years, an average freight of 89s per ton was deduced.

In 1878 Mr. Newmarch supposed that, to make a fair comparison between exports and imports, 10% should be added to the former, 5% subtracted from the latter for all charges of conveyance. He also quoted a letter from Mr. McKay, of Liverpool, estimating the freights earned in British bottoms at 30s. per ton on imports and 20s. per ton on exports.

Another shipowner, quoted by Sir Robert Giffen in a paper read in 1882, calculated that on the actual weights of goods imported and exported in the American trade the freights would come to about 27s. 6d. and 20s. respectively. Sir Robert Giffen himself expresses the view that freights might be estimated at not much below those quoted by Mr. Bourne, spite of the lapse of seven years, and estimated that, though some freights might fall, the cost of working ships would not bear any considerable all-round deduction. He places the earnings of steamers, including their income from the passenger traffic, probably now more important even than then, at not less than £15 per ton, net register, and for sailing ships at £7 per ton per annum.

Insurance, commissions, and other charges, should, on the same authority, count for fully $2\frac{1}{2}\%$. In a case of a Manchester shipment quoted by Mr. McKay, these totalled up to 4% .

We may remember, too, that the records of imports and exports may themselves be in error to the extent of 1

or 2 %, even when there is no systematic error such as have been referred to.

Will such figures as these just enumerated agree with the deductions made in the tables I have drawn up? I have applied a partial test on the following lines. The Colonial trade is concerned in about 25 % of the value and 15 % of the entrances and clearances in British ports. The trade with Northern Europe (Northern ports of Russia, Norway, Sweden, Denmark, Germany, Holland, Belgium, and France) accounts for some 36 % of the value and 44 % of the shipping, leaving 39 % of value and 41 % of shipping for the rest of the world.

If we may suppose the Scandinavian figures to give a fair average of charges in the Northern European trade, then, allowing about $2\frac{1}{2}$ % on the export values as commissions and insurances, the Colonial and European trade, 60 % of the whole, would give an average freight in 1880-84 of about 24s. 6d. per ton register. Seeing that we are here dealing with practically the same proportion of value and of tonnage, we may fairly compare this with the estimate of 30s. on imports and 20s. on exports, and it appears not to seriously disagree with them.

A similar calculation for 1890-94 shows an average freight of no more than 20s. per ton.

A recent writer in the journal *American* states that it is customary to estimate the freightage on American imports at 8 %, on exports at 12 % of their value. Comparing these figures with those deduced for the Australian trade, and allowing for commissions and insurances, a rather remarkable agreement results. Difference of distance appears to compensate differences in the nature of the trade.

FLUX, *Costs of Sea Transport in proportion to Values.*

Description of Plates.

Plate 9. Figures of Imports and Exports of the World given in Neumann-Spallart's *Übersichten der Weltwirthschaft*, with percentage excess of the former in each year (1878 to 1894).

Plate 10. Exports from United Kingdom to British Possessions and Imports of latter from United Kingdom in each year (1875 to 1894), and

Exports from British Possessions to United Kingdom and Imports into United Kingdom from British Possessions in each year (1875 to 1894).

On the right, the sum of the two amounts of Exports and of the two amounts of Imports shown on the left, together with the percentage excess of the latter in each year, is shown.

Plates 11 and 12 show for other special cases what the right-hand half of Plate 10 shows for British Colonial trade.

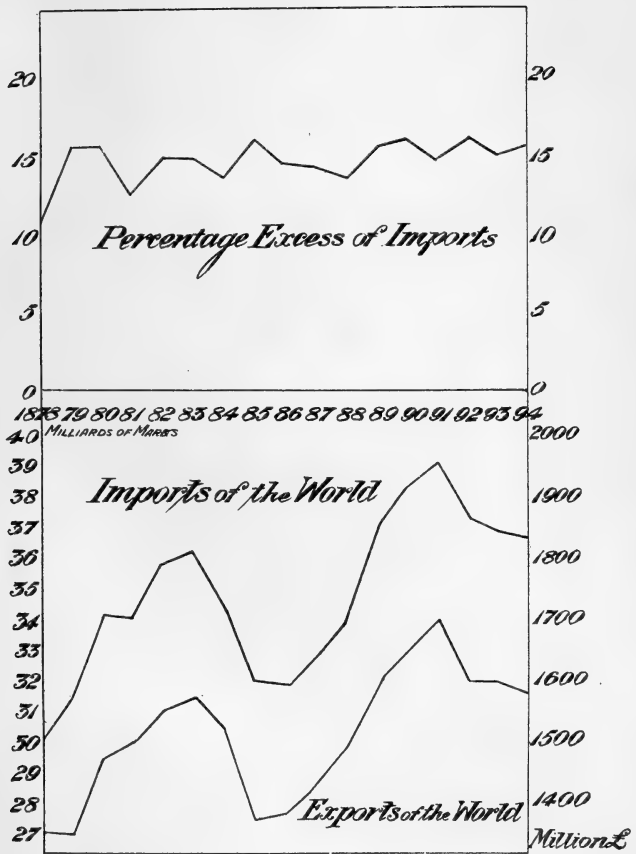

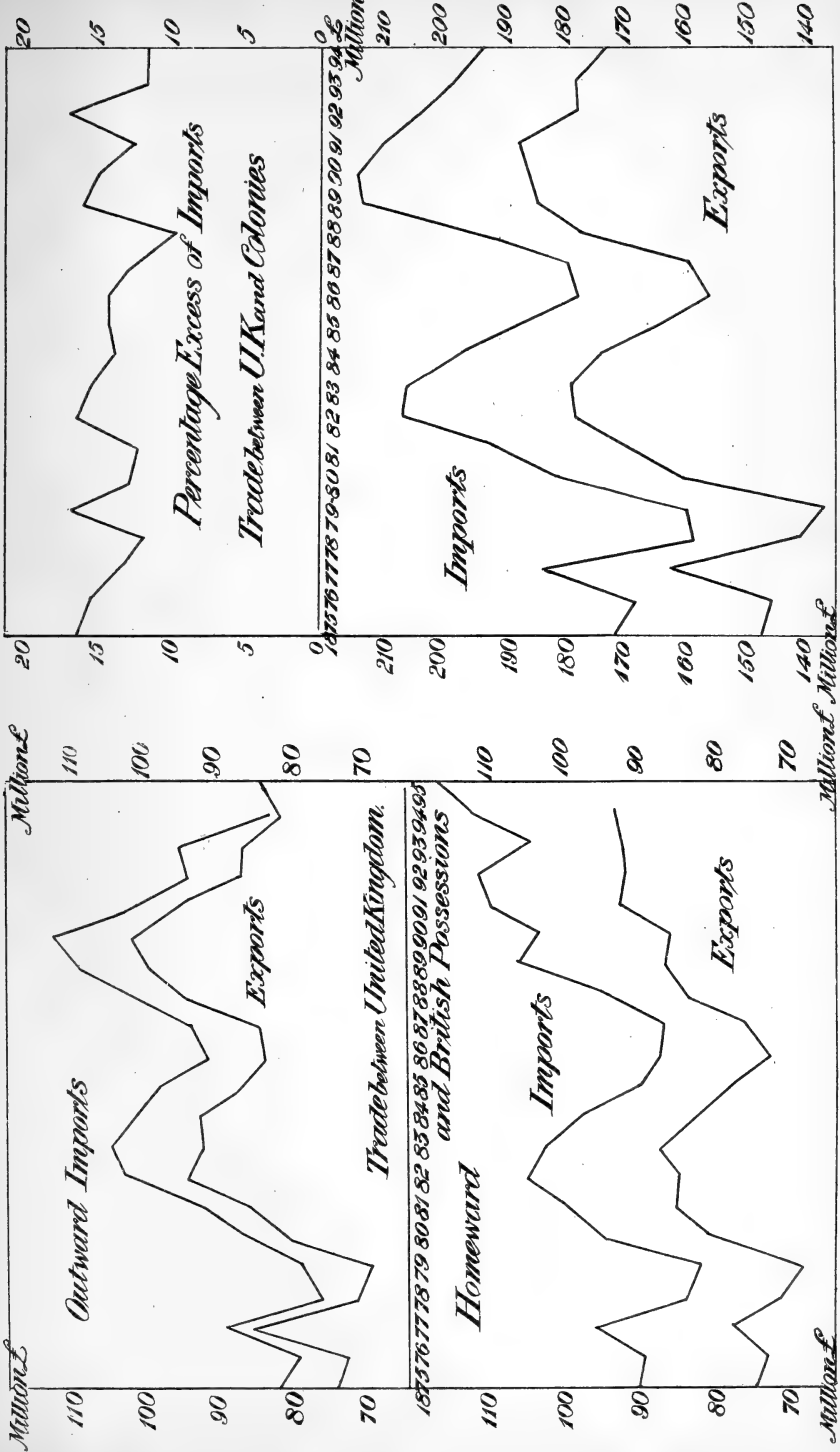

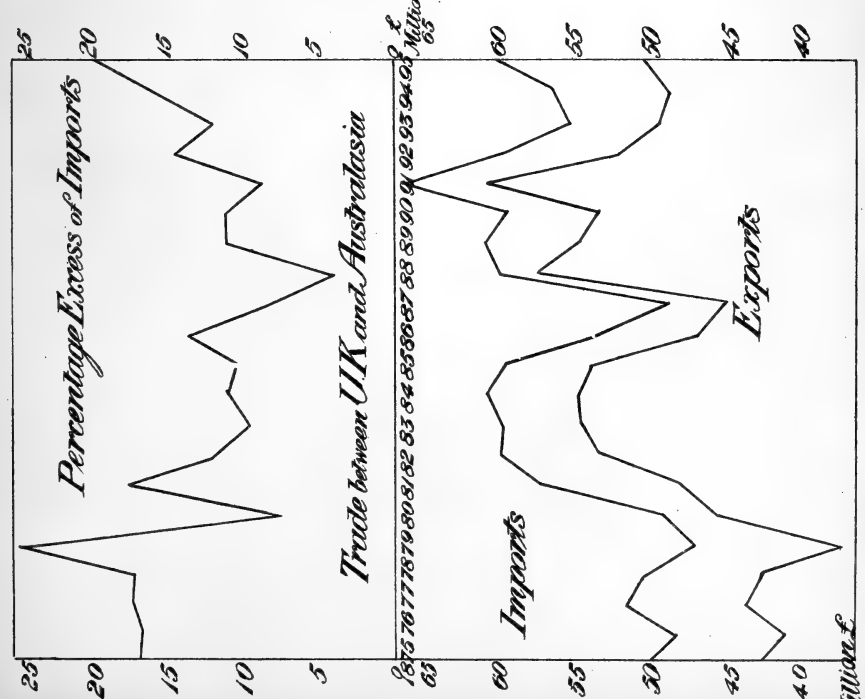
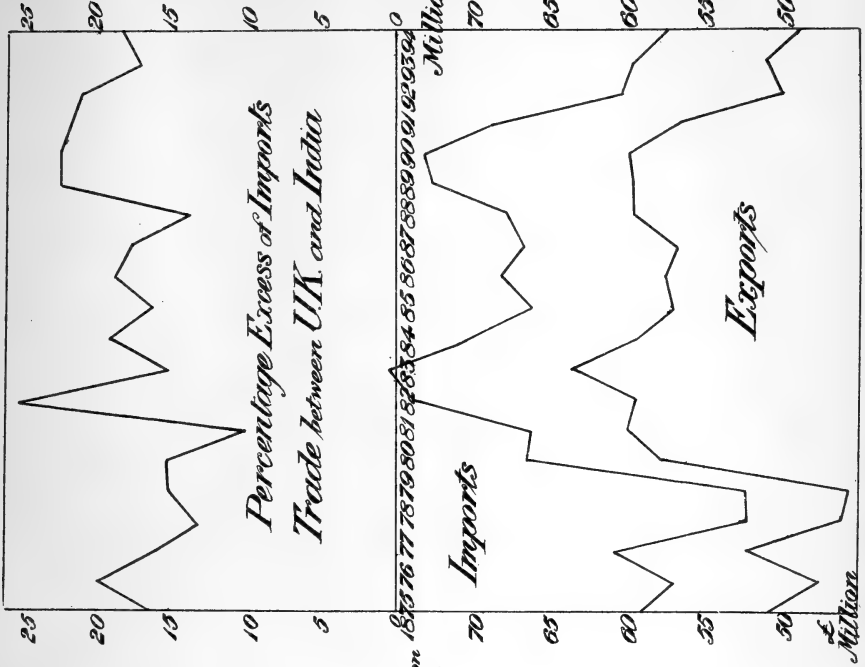

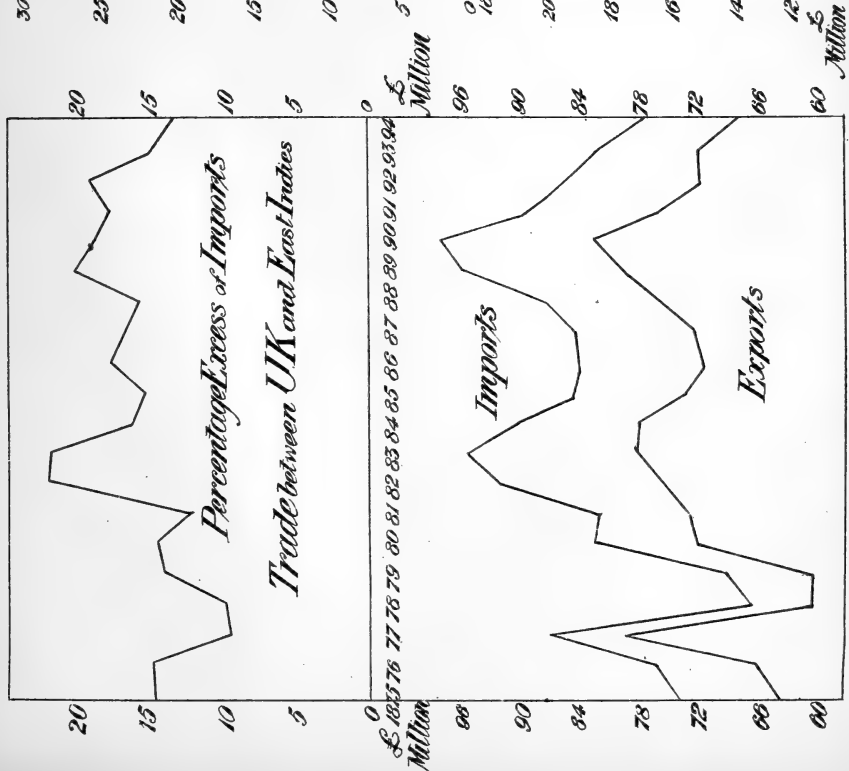
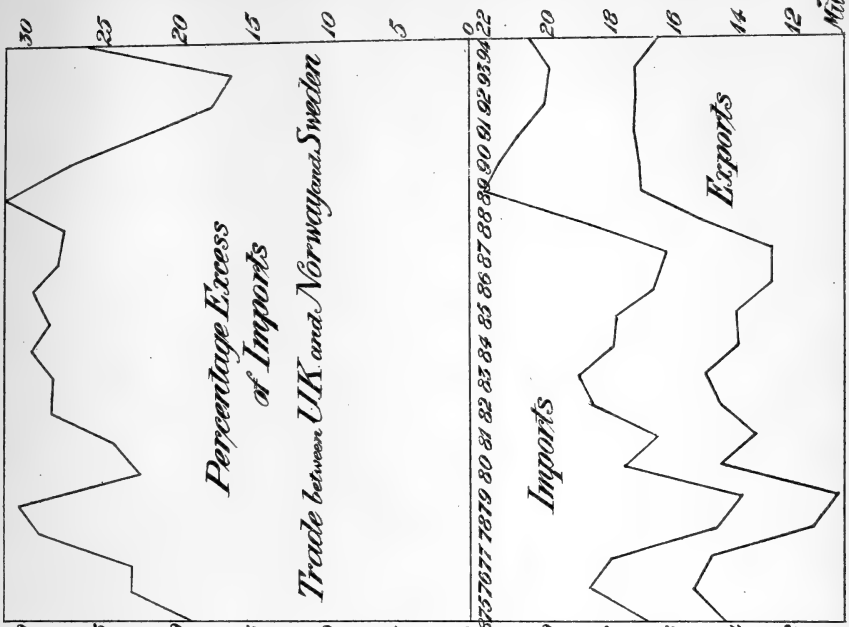

Million

Million

Million

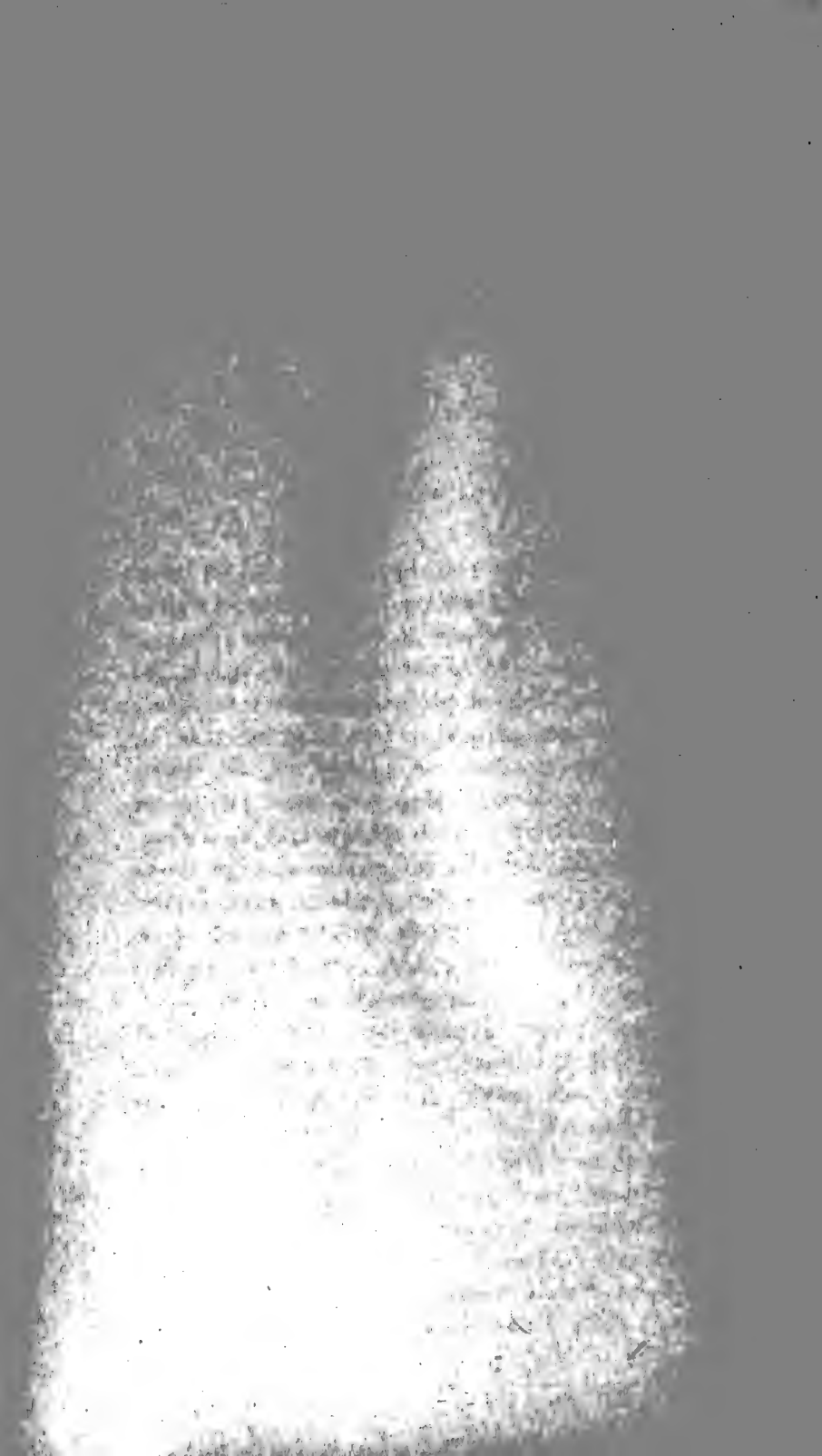

XII. The Fall in Prices during the past Twenty Years.

By A. W. FLUX, M.A.

Received and read March 9th, 1897.

The question of how great the fall in wholesale prices during twenty years past has been, is one that has received several answers from persons of undoubtedly extensive knowledge and capacity to form reliable estimates of the movement. It will be not without interest to compare these estimates with each other, and thus see how far they are in agreement. This has been done several times already; but the following comparison offers, the writer believes, some points that are both new and interesting. It is not proposed to deal with any estimates of the movements of prices outside our own country, and, of the different estimates for the British movements of prices, those of Sir Rawson Rawson, of Mr. Sauerbeck, and two estimates afforded by the *Economist* will be compared.

The comparisons will be made so that the rise and fall of prices shall be expressed as percentages on the average prices of 1886. Some results given in the U. S. Senate Report on *Wholesale Prices and Wages* in 1893 permitted of a comparison of the effects of selecting different dates as starting points with index numbers calculated on the same basis. In that report all results were reduced to a comparison with 1860. I need not here refer in further detail to these results, merely referring to them as a means of testing further than is done here the effect of the change

May 20th, 1897.

in the date selected as the basis of comparisons of average prices. For the purpose of comparisons over so short a period as twenty years there are obvious advantages in selecting the middle of the period as a basis from which to measure movements earlier and later.

To take the *Economist* Index number first. This number, as is well known, is the aggregate obtained by expressing the price of each of 22 selected commodities as a percentage of the corresponding price, averaged over the six years 1845-50, and summing these percentages. If we divide the result by 22, we obtain a figure showing the average percentage rise or fall of price of these 22 commodities. For purposes of comparison we may express the figure for each year as a percentage of the figure for 1886. For more thorough comparison, each of the 22 prices may be expressed as a percentage of the corresponding price of 1886. The change of basis might be expected to produce considerable change in the result, since the proportions between the prices obtaining in 1886 were by no means those obtaining in 1845-50. The modification produces much less difference than might be expected, the chief differences being that the fall to 1886 is somewhat greater than in the original number, and the movement from 1886 to 1890 less irregular.

The fifty-years-old set of standard prices are less out of touch with the circumstances of to-day than might have been anticipated. The figures for January 1st of each year, referred to January 1st, 1886, start, in the original number, from a level of 34% above 1886, in the modified number from 42% above. The two approach, and finally coincide in 1885 as well as in 1886. In the subsequent movement, both rise; but the original rises to 111 in 1890 and 1891 the modified reaches this level in 1889 and in 1891, meanwhile rising to 113. The subsequent fall carries the original to 95, the modified

to $93\frac{1}{2}$, and in January, 1897, the two are coincident at 96.4. The movements are shown in Plate 13.

A similar treatment of Sauerbeck's Index for 45 commodities shows even less divergence between the results of the two calculations. The fall to 1886 is from 37% above of the original, 41% of the modified index in 1876. After 1886 the modified number keeps very slightly above the original, reaching 106 as contrasted with 105 in 1889 and falling to 89.4 as contrasted with 88.4 in 1896. The movements are shown in Plate 13.

It is to be noticed that, though the *Economist* number and that of Mr. Sauerbeck indicate practically the same movement from 1877 to 1886, the subsequent movement shows a constantly lower level of price in the latter estimate than in the former. The last ten years have experienced, according to the *Economist* number, a considerable rise and a subsequent fall to very little below the original level; but, according to Mr. Sauerbeck, the rise was not great, and the level subsequently reached is substantially lower than that of 1886.

Neither of these index numbers makes any very systematic allowance for the greater importance of changes of price in some than of those in other commodities, beyond allowing more than one quotation to enter in some cases, as, for example, in the *Economist* number, where two quotations of raw cotton, cotton yarn and cotton cloth all enter and thus permit the variations of cotton prices to exercise a large influence on the final total. If we may regard the quotations used as fair samples of the price movements of groups of commodities of tolerably equal importance, of the changes in which the quoted price serves as a tolerably accurate measure, this circumstance will be of little moment. So slight has the difference been between these simple averages and what are called *weighted* means, where each quotation

is weighted in accordance with the estimated importance of the commodity concerned, that writers of great eminence have considered the process of weighting to be a quite unnecessary complication in the calculations.

I do not propose to refer you to the course of any of the ordinary weighted averages; but there exists a series of numbers which contain within themselves such a weighted mean as is here referred to. Mr. Stephen Bourne has, in a series of papers, given calculations of the value which our foreign trade in any year would have had if the price of each article entering into it had averaged the same as it averaged in the preceding year. The *Economist* has for several years published calculations on the same basis, and I propose to utilise these two sets of calculations, which carry us back as far as to a comparison of 1878 with 1877, adding my own calculation of the corresponding figures for one further year.

There are certain special features connected with the combination of these separate calculations which must be noticed. If every article entering into the trade were entered in the returns, both by quantity and by value (and accurately in both), and if the several different qualities of otherwise similar substances were separately recorded, a very accurate presentation could be made of the variation of the cost of our Imports, or the price obtained for our Exports, which was due to price-changes only, and the average variation of the quantities dealt with might then be deduced. It is not possible, however, to deal thus elaborately with the matter. Some classes of goods cannot conveniently be quantified otherwise than by the misleading means of their weight. To enter lace, umbrellas, millinery, &c., by weight, for example, would not afford a sound basis of comparisons of quantity. In other cases dissimilar articles, the amount of each of

which is but small, are massed together and entered by value only. In all such cases of entry by value alone, we cannot pretend to measure the price-variation from the information supplied. The method adopted is to determine the average price-variation for the goods which permit of it, and to assume an equal price-variation for the remainder. It may be said that the assumption is one which might be expected, *à priori*, to be false. It is at any rate capable of being contended that it is equally likely to be correct, and there is, moreover, no means available for determining what proportion of price-variation should be applied if the average actually proved to hold for the tested part of the trade be not used.

When the total cost of one year's imports or exports has been determined at the preceding year's prices, a comparison with the actual cost of the preceding year's trade enables us at once to obtain a figure showing the variation in volume (as the phrase is used) of the trade between the one year and the preceding.

The process just described is nothing more nor less than the construction of a very elaborately weighted index number for the single year's variation. When we proceed to the next year, the weights associated with each price-variation will be changed, and thus the process differs from that of the construction of an ordinary index number with fixed weightings. It is obvious that we may compound the successive yearly variations and obtain an estimate of the total variation both in price and in quantity between any two dates for which these calculations exist. There is the advantage that the accidental price-proportions of a *reference-period* are not perpetuated in their influence on the measurement of all subsequent movements, as in ordinary index numbers. The impossibility of evaluating the whole of the trade imparts some uncertainty to the result. It is, however,

permissible to suggest that the measurement we obtain of price-variations is one not very far from what we should obtain if we were able to satisfy ourselves in regard to the price and quantity of every item of the trade. (For the algebraic examination of this point, see Appendix.)

The results are very similar to what are indicated by the two index numbers already considered for the years 1876-86. The import prices averaged 33%, the export prices 40% in 1876 above the 1886 level. (The exports of domestic produce, and total imports less re-exports, are here used.) Subsequently the import price is persistently below the level of 1886, and in 1895 reached 20% below, recovering 1% in 1896.

The export prices, however, follow a course after 1886 more closely analogous to that indicated by the *Economist* index number, falling 1% to 1887, then rising to 10% above 1886 in 1890, and thence falling to 6% below standard in 1895, recovering somewhat in 1896. Plate 14 shows the movements.

It appeared to me to be of interest to try to compare these index numbers with the others we have been dealing with. The basis I have employed is the following. The exports of our own produce may serve to gauge the price-variations of goods produced at home and consumed at home, for if the prices obtained in the wholesale markets for similar goods for export and for home consumption be not identical, the percentage variations from year to year may nevertheless be the same, and this may hold, spite of the fact that many things are made and consumed at home which are not made for export; the imports which are not again exported do enter into the home trade, though some of them, even a great part of them, are exported after manufacture; the relative importance assigned to the price-variations of each is somewhat arbi-

trary ; I have chosen to assume the import price-variations to be of only one-third the importance of the export price-variations, and can only offer the following partial justification. Three times the value of domestic exports, together with the value of retained imports, give a figure of some 1150 millions on the average of the last five years. Now, though this falls short by about one-fifth of the estimate given by Mr. Mulhall, in his recently-published work, of the total income of the inhabitants of the United Kingdom, we must remember that our figures deal with wholesale prices, while the incomes of the people are spent on retailed articles. If we chose to give the domestic export prices four times the weight of the import prices, it would make little difference. On the ground that the import prices themselves have a certain reflected effect in the export prices of the goods made from the imported raw materials, we may be satisfied with the basis chosen. It is worthy of remark that the index number thus obtained from the import and export prices is one which is remarkably close in its variations to the index number prepared on Mr. Sauerbeck's data. (See Plate 14.) It will not be far from the truth to say that the price-levels of 1876 and 1896 were in the proportion of 3 to 2. The *Economist* index number shows a change which is more nearly expressed by 4 to 3.

Another mode of regarding price-changes has been adopted by Sir Rawson Rawson. He regards the tonnage entered or cleared with cargoes as a fair measure of the change in volume of the trade, and the value per ton as a measure of price-variation. Recalculating these values, and including transhipped goods in the lading of ships entered or cleared, the value per ton of the imports turns out to have been, in 1876, 26% greater than in 1886, to have steadily decreased to 1886, and after that to have moved somewhat irregularly.

The lowest point reached was 8% below the 1886 level. The exports, on the other hand, stood, in 1876, at prices 30% above those of 1886, as estimated by this criterion, and fell nearly 18% below that level by 1894, somewhat recovering in 1895 and 1896. (See Plate 15.)

Now, can there be any useful conclusions drawn from the comparison of Sir Rawson Rawson's method with that of Mr. Stephen Bourne and the *Economist*? If the conclusions are to be sound, the answer appears to be "No," and for reasons explained in what follows. Suppose one year to be characterised by a larger import of bulky and cheap goods than the preceding, but no change of prices to have occurred. We may, if desired, add the hypothesis that the quantities of other imports have decreased, and also without change in price. The totals might work out at the same aggregate value as those of the preceding year, and, since prices have not changed by our hypothesis, the price-level and the volume of trade would have remained stationary according to such measurements as those of Mr. Bourne. The more bulky goods requiring a larger tonnage to transport them, the tonnage entries would be greater, and the average value per ton consequently less. By Sir Rawson Rawson's method, therefore, average prices would be shown to have fallen and the volume of trade to have increased. If this were the sole source of difficulty, we should be able to deduce from the facts a valid conclusion, to wit, that the imports are to a less degree, the exports to a greater degree than formerly of a bulky and cheap nature, and that the change has been much more rapid since 1887 than before that date; the period 1880-84 showing, however, no inconsiderable effect of this nature. The same conclusions would be arrived at by such a method of argument as the following: The average value of imports per ton of shipping in 1886

was £14. 12s., of exports £9. 12s. If the *Economist* changes of price be relied upon, the average level of price of imports for the last five years is about 15% below that of 1886, of exports hardly 2% below. The value at the average prices of 1892-96 of the ton of goods of 1886 would therefore be, for imports £12. 8s., and £9. 8s. for exports. The actual average value has been about £14 and £8. 11s. respectively, thus indicating goods of greater value in the same bulk in the later imports than in those of 1886, and the contrary with exports as already concluded by the former mode of argument.

But there is another feature besides this. The average price per lb of cotton yarns and twist exported in 1883-4-5 was, roughly, one shilling. For the last three years it has been, roughly, 9½d., a fall of fully 20%. Now, this may be a real fall of price of yarns of similar quality and fineness; it may be, and, I believe, to some extent is, something more than that. If the yarns exported to-day are of finer counts than those of a dozen years ago, the price corresponding to yarns such as are now sent abroad would have been something over a shilling, say, for example, 14 pence. The actual fall of price should therefore be regarded as something over 30% in place of 20%, on the basis of the assumed figure. Were we able to estimate the yarns exported, not simply as *grey* and *bleached and dyed*, or, as was done before 1889, merely as one undistinguished mass, but by the weight of each count included in that mass, the figure of price-variation, if my hypothesis be correct, would have fallen more than that resulting from the *Economist* calculations. Similarly, if the imports include now goods of lower qualities than formerly, but called by the same name, the prices resulting from considering the quantity and value of the various headings of imports should show a greater fall than has actually occurred in prices, and than would be shown if we were able to distinguish and

allow for such changes of quality. Were the movement of the kind now referred to sufficiently great, the lines of import prices and of export prices from the *Economist* calculations would rise and fall respectively, and might even be made to coincide with the price-line deduced by Sir Rawson Rawson.

Were we to assign the whole of the divergence actually shown to the first cause mentioned, we should arrive at a conclusion as to the meaning of it precisely opposite to that deduced if the second be supposed to be the powerfully operating cause. Probably both causes are at work and each contributes a share to the result, leading to the conclusion that the average prices of imports have fallen less, of exports more, than is revealed in the *Economist* calculations, but that the export prices have fallen less, import prices more than is shown by the tonnage statistics of Sir Rawson Rawson.

That, in the exports, the first of the causes has been strongly operative is shown by a calculation based on the last-named authority's estimates. He has called attention to the fact that a largely-increasing proportion of the export tonnage is concerned in carrying coals. If his estimate of 100 tons of shipping to 150 tons of coal exported be employed (for want of the records of ships clearing with coal I am compelled to use it, and it may not be necessary to seek such accuracy as the use of those records would give) we find that about twenty years ago one-half of the shipping cleared was needed to carry the coals exported, while, lately, three-fifths of the whole are engaged in that trade. If we eliminate the value of the coals from the value of exports and the ships conveying them from the tonnage cleared, the fall of value of exports per ton of shipping appears entirely changed. The average value is more than doubled, and the resulting price-curve is thrown upwards since 1886

so much as to show a less fall of price than that resulting from the *Economist* figures. As the effect on the average price of exports of the greatest changes of price of coal exported which the past twenty years show was but a trifle over 1%, and as the figure of 1896 is but 5% above that of 1886, the exclusion of coal from the estimate of average export prices would produce but slight variations in the result—variations perfectly insignificant when compared with the changes in Sir Rawson Rawson's calculations which this one item makes. These considerations, though not at all destroying the utility of the tonnage calculations, may lead us to prefer, as a reliable estimate of the actual movement, the *Economist* figures.

As a useful application of the latter figures, the corresponding variations in quantities of imports and exports are of considerable interest. The results are best seen in a diagram. The leading points may profitably be indicated here, however. The imports retained were, twenty years ago, 18% in quantity below those of 1886, last year they were 60% above that level. Domestic exports were, twenty years ago, 32% less in quantity than in 1886, last year they were nearly 19% greater than in 1886. The re-exports made about equal progress with the domestic exports from 1876 to 1891, since which date the movement shown is quite irregular. The volume rose to 18% above the 1886 level in 1895, but less than 11% above in 1896. Over the whole period the volume of re-exports may be said to have increased some 60%, but the value, on which profits in handling them depends to a large extent, has only increased 10%. (I compare the average of 1895 and 1896 with that of 1876 and 1877.) I shall make no attempt to estimate the total gain of the twenty years arising from buying imports at lower prices and to set it off against the loss arising from selling exports

cheaper. Even if the estimates were so reliable as to make the estimate worth computing the meaning of the result would be questionable, for it would only include the most obvious effect of causes the other effects of which may easily be far more important and possibly quite other in their nature. It is worth calling attention to the fact that if it be true that the import price-fall is over-estimated, that of exports under-estimated, the growth of volume of imports is exaggerated, that of exports insufficiently shown in the diagram. (Plate 15).

APPENDIX.

Let P_n be the declared value of (say) the imports in any year, P_{n-1} in the preceding year, &c.

Let A_n be the value of a part of them, B_n the value of the same at the prices of the preceding year.

Then we may write

$$A_n/B_n = p_n/p_{n-1},$$

and we may also write $A_n = p_n a_n$, $B_n = p_{n-1} a_n$, the p 's being symbols indicating the average price-level, the a 's similarly denoting movements of quantity.

As A_{n-1} denotes the value of goods of the same kind as those included in A_n , B_n and A_{n-1} denote the values, on the same price-level, of these goods imported in the two years, and we have $B_n/A_{n-1} = a_n/a_{n-1}$, a result which follows from $B_n = p_{n-1} a_n$, $A_{n-1} = p_{n-1} a_{n-1}$.

Let $P_n = A_n x_n$, x_n denoting the proportion which the value of the total imports bears to those which are included in the above estimates. If also Q_n denote the value of the preceding year's imports on the assumption that the average change of price in the goods not included in A_n is identical with that of the goods which are so included, R_n the true value of the whole imports at the prices of the preceding year, we have

$$Q_n = B_n x_n, \quad R_n = B_n y_n,$$

where y_n denotes the proportion of the whole to the part evaluated at the prices of the preceding year. We can accurately determine the x 's, but the form of the returns and the nature of some of the goods do not permit us to know the numerical values of the y 's.

We have

$$P_n = p_n a_n x_n, \quad Q_n = p_{n-1} a_n x_n, \quad R_n = p_{n-1} a_n y_n.$$

If also we write $P_n = \pi_n a_n$, π_n denoting the price-level, a_n the quantity, we have

$$\frac{\pi_n}{\pi_{n-1}} = \frac{P_n}{R_n} = \frac{p_n}{p_{n-1}} \cdot \frac{x_n}{y_n}$$

and

$$\frac{a_n}{a_{n-1}} = \frac{R_n}{P_{n-1}} = \frac{a_n}{a_{n-1}} \cdot \frac{y_n}{x_{n-1}}$$

In practice $\frac{\pi_n}{\pi_{n-1}}$ is not ascertained, and $\frac{p_n}{p_{n-1}}$ is used in its place; also $\frac{a_n}{a_{n-1}}$ is not ascertained, and $\frac{a_n x_n}{a_{n-1} x_{n-1}}$ is used in its place. In contrasting the n^{th} and the r^{th} years we have

$$\frac{\pi_n}{\pi_r} = \frac{p_n}{p_r} \cdot \frac{x_n \cdot x_{n-1} \cdot \dots \cdot x_{r+1}}{y_n \cdot y_{n-1} \cdot \dots \cdot y_{r+1}}$$

$$\frac{a_n}{a_r} = \frac{a_n x_n}{a_r x_r} \cdot \frac{y_n \cdot y_{n-1} \cdot \dots \cdot y_{r+1}}{x_n \cdot x_{n-1} \cdot \dots \cdot x_{r+1}}$$

In using the proportions of the p 's and a 's in place of those of the π 's and a 's therefore, we are liable to introduce errors.

It is clear that

$$\frac{\pi_n a_n}{\pi_r a_r} = \frac{p_n}{p_r} \cdot \frac{a_n x_n}{a_r x_r}$$

which might have been arrived at without using the values above shown for $\frac{\pi_n}{\pi_r}$ and $\frac{a_n}{a_r}$. Thus when using, in place of the true ratios, the values of the calculated price- and volume- ratios, errors might exist in both the latter ratios as estimated, but not in their product. Only if each x be equal to the corresponding y , could we get accurate results for each of the ratios separately. This last condition implies that the price-variation is the same for the quantified and unquantified parts of the total dealt with.

Description of Plates.

Plate 13 (left-hand figure). The broken line shows the variation of the Index Number of the *Economist* for January 1st of each year, from 1876 to 1897, expressed as a percentage of its amount on January 1st, 1886. The full line shows the variations when each of the 22 quotations making up the Index Number is expressed as a percentage of the quotation on January 1st, 1886, instead of as a percentage of the average quotation for 1845-50, as in the original number.

The right-hand figure shows the same for Mr. Sauerbeck's Index Number, where the quotations are the *average* for each year.

Plate 14. The left-hand figure shows the result of compounding the price-variations for Imports and Exports [the former Imports less Re-exports, the latter Exports of British and Irish Produce], as these are calculated by the *Economist* year by year.

The right-hand figure compares Mr. Sauerbeck's original Index Number with that obtained by taking three times the Export Index Number plus the Import Index Number, as these are shown in the left-hand figure, and dividing this sum by four.

Plate 15. The left-hand figure shows the variations of the value of the Exports and Imports of the United Kingdom, including transhipped goods, but excluding bullion, per ton of shipping cleared or entered *with cargoes only*.

The right-hand figure shows the variations in the Imports and Exports of the United Kingdom as they would appear if the average level of prices for each remained unchanged, *assuming that the variations of price are accurately represented in the left-hand figure of the preceding diagram*.

The table on the preceding page gives the numerical results sufficing for the construction of the diagrams.

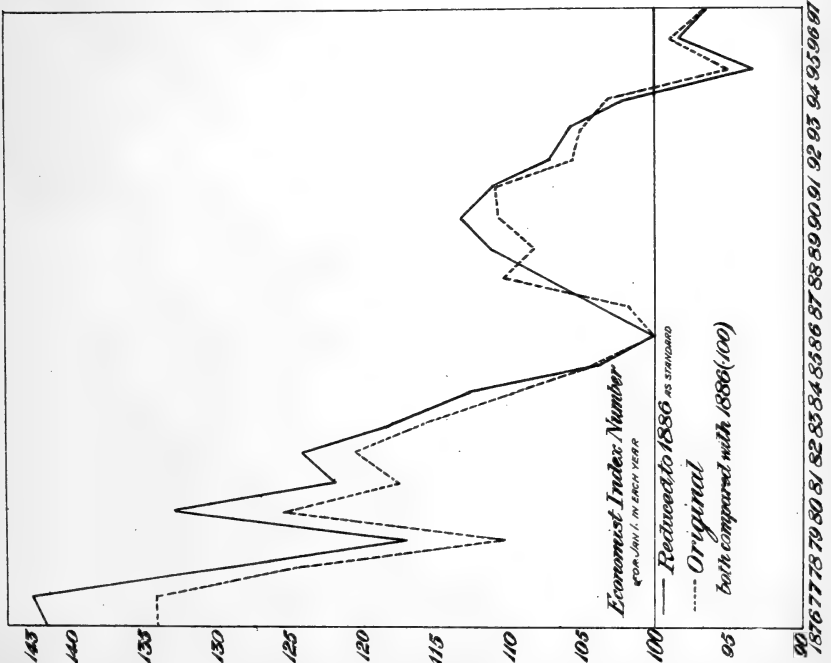
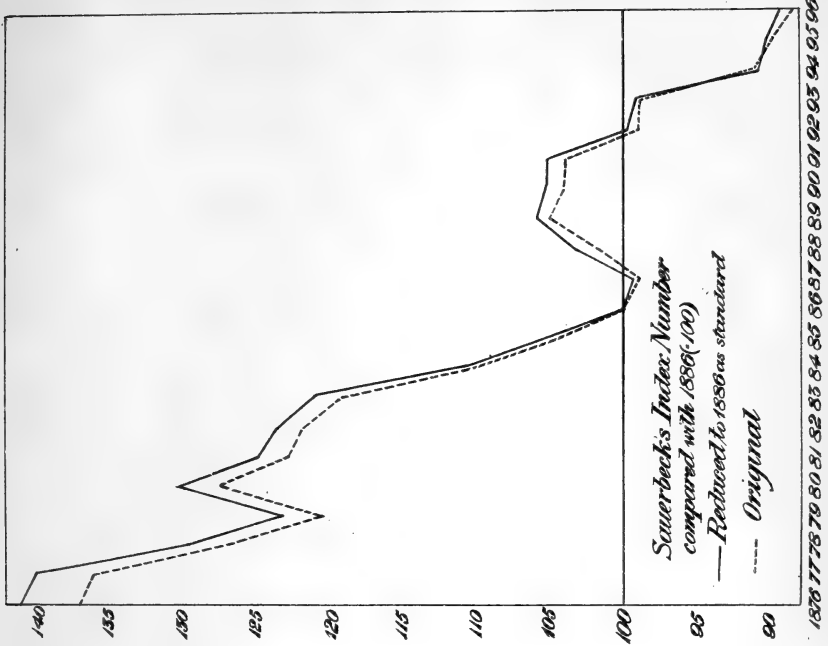



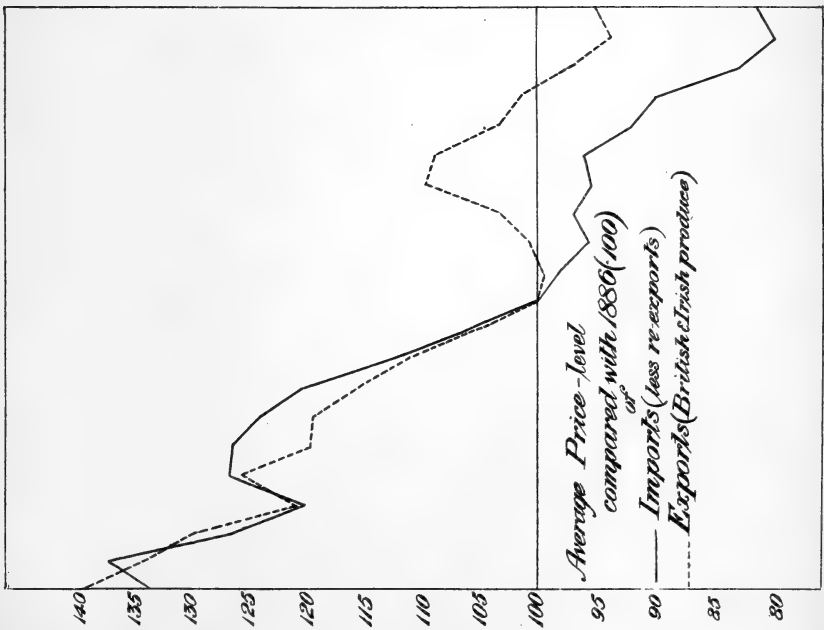
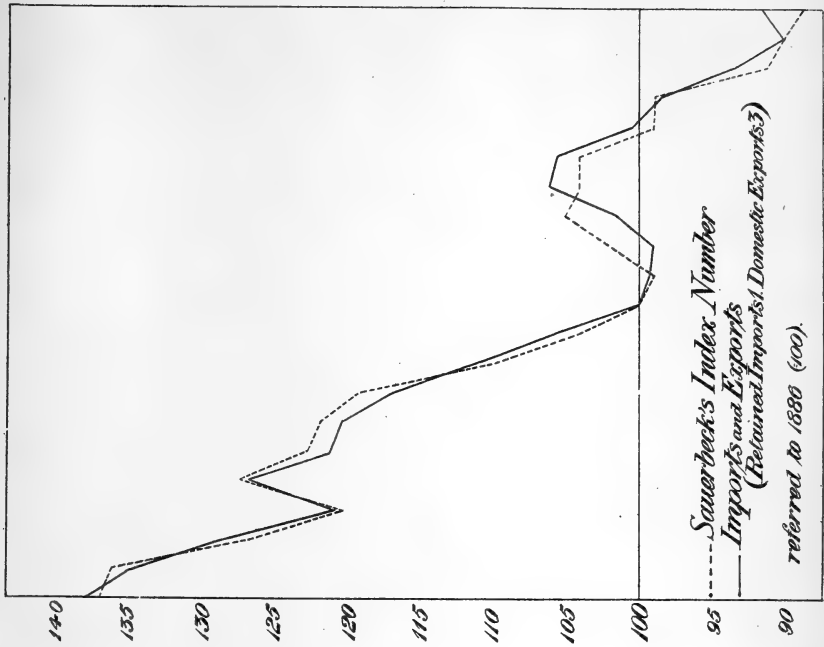

1876 77 78 79 80 81 82 83 84 85 86 87 88 89 90 91 92 93 94 95 96

1876 77 78 79 80 81 82 83 84 85 86 87 88 89 90 91 92 93 94 95 96

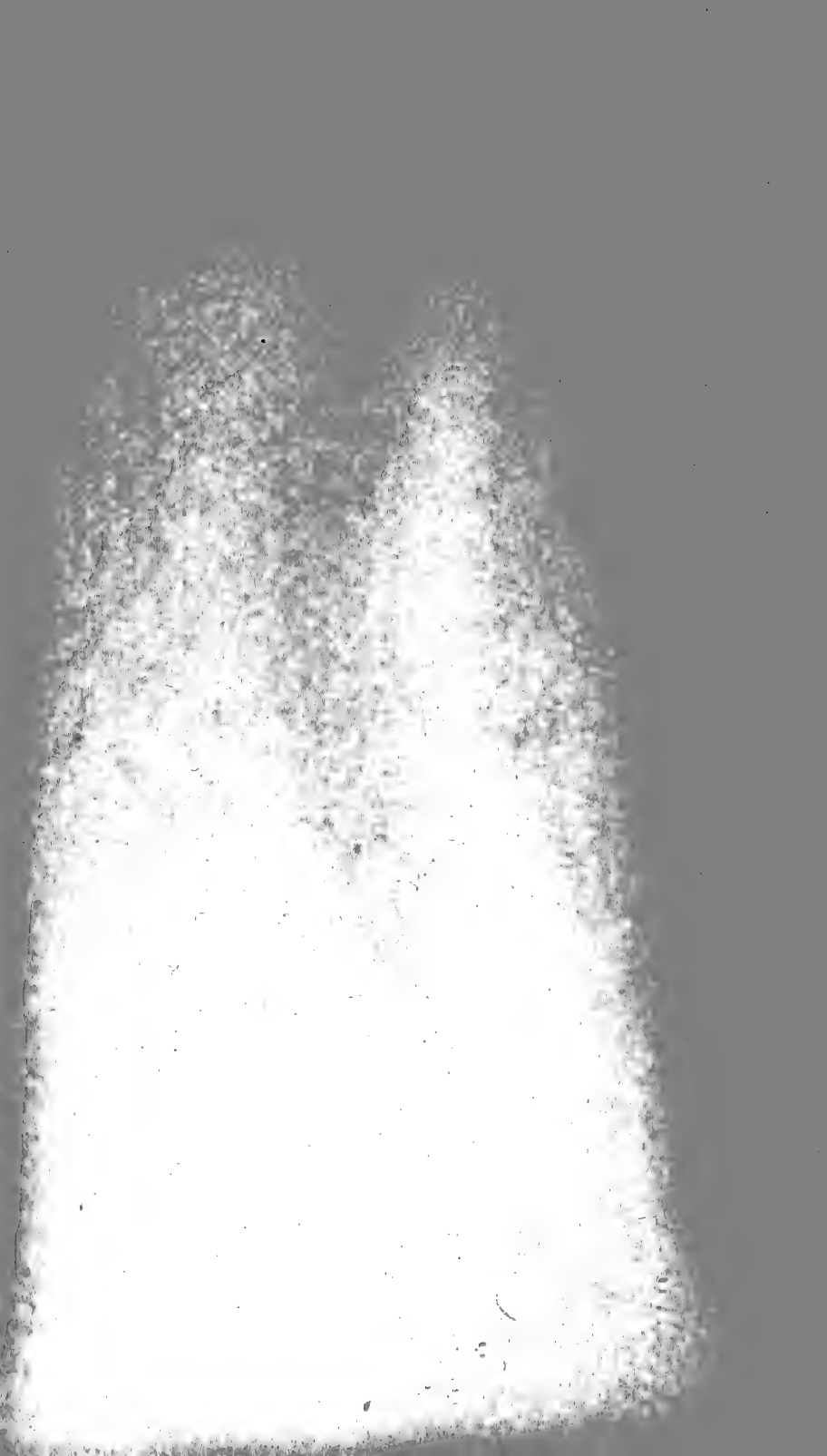

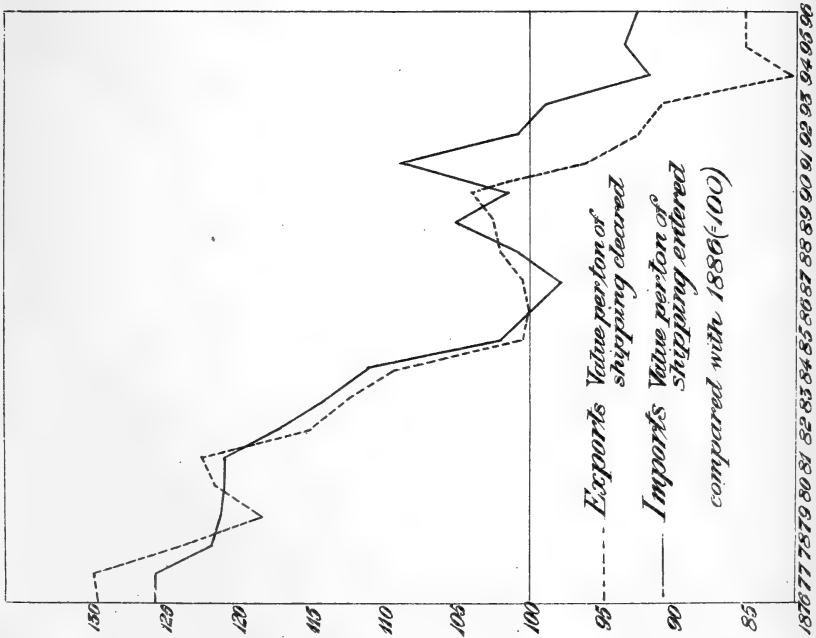
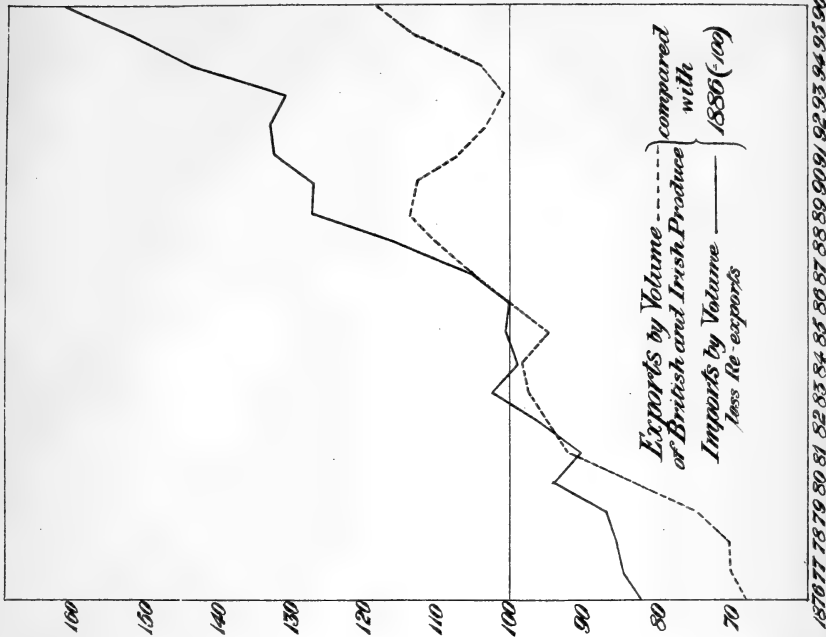

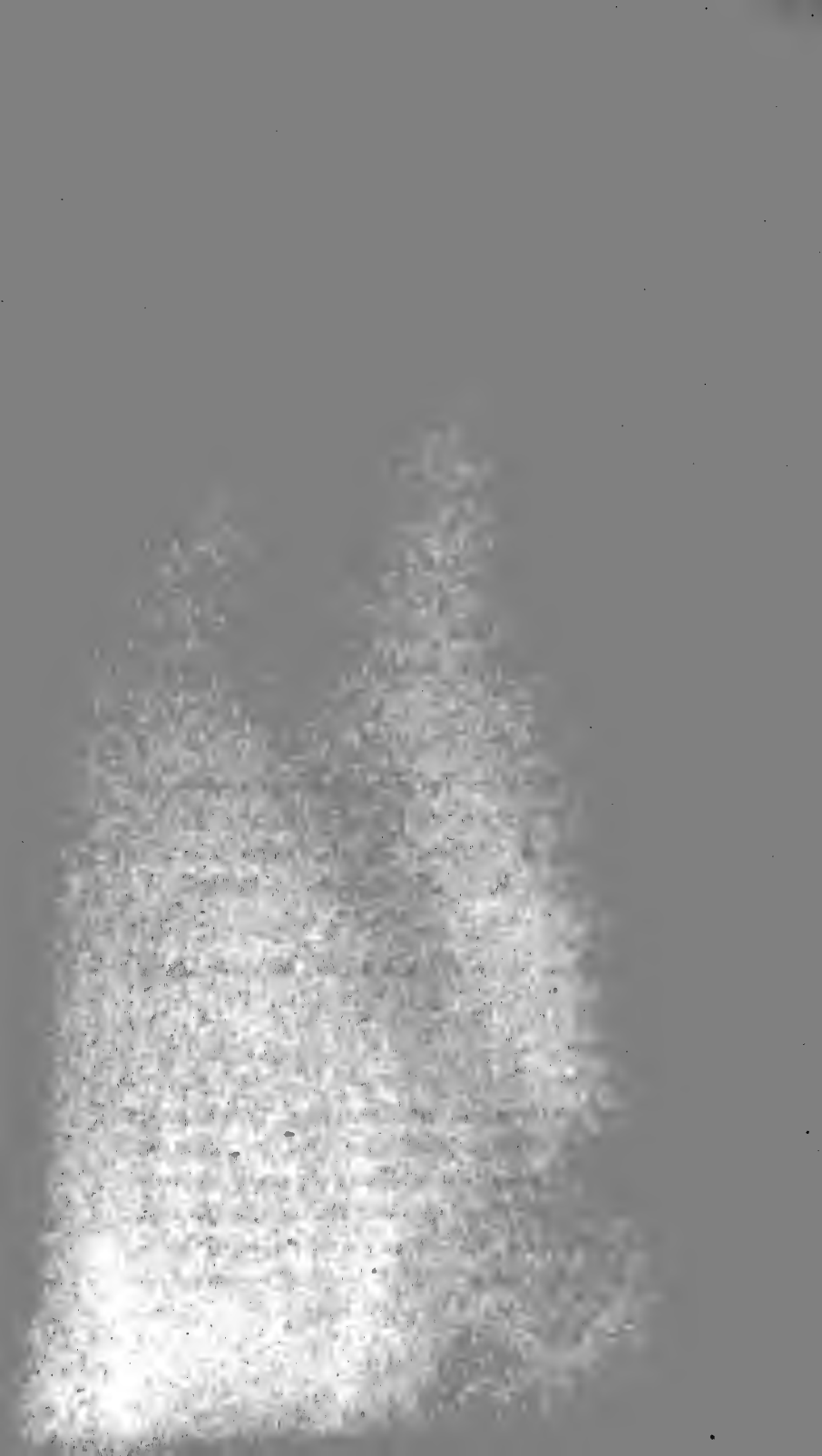

XIII. Hymenoptera Orientalia, or Contributions to a knowledge of the Hymenoptera of the Oriental Zoological Region. Part VI.

By PETER CAMERON.

[Communicated by J. Cosmo Melvill, M.A., F.L.S.]

Received March 16th. Read March 23rd, 1897.

In continuation of my last paper on Indian Hymenoptera, I give here descriptions of new species belonging to various groups.

CHRYSIDIDÆ.

This interesting family is being revised, as regards the Indian species, by M. Robert du Buysson, in the *Journal of the Bombay Natural History Society*, from material chiefly collected by Mr. R. C. Wroughton, in Bengal.

CHRYSIS.

A. Apex of abdomen undulated, without distinct teeth.

CHRYSIS PERFECTA, *sp. nov.*

Long. 8—9 mm.

Hab. Barrackpore.

Green, the flagellum of the antennæ black; the vertex, the middle of the pronotum and mesonotum, bluish; the apex of the first abdominal segment narrowly, of the second segment to near the middle, bluish, with a purplish tinge; the tarsi blackish, the basal joint testaceous; the wings fuscous, lighter coloured at the apex.

September 22nd, 1897.

The scape of the antennæ, the second joint, and the base of the third, green; the flagellum black, covered sparsely with a microscopic white down; the third joint slightly, but perceptibly, longer than the fourth. The vertex coarsely punctured; a curved keel runs from the side of the lower ocellus, the space between being irregularly longitudinally striolated, except in the centre at the apex, where it is smooth; the space below the antennæ thickly covered with long white hair; the clypeus has some scattered, moderately large punctures; the mandibles black, piceous towards the middle. Pronotum coarsely punctured; depressed in the middle; the mesonotum with the punctures as large, but, if anything, more widely separated; the median segment with the punctures still larger, deeper, and coarser, and with an oblique wide depression at the sides, this depression having at the base a few stout oblique keels. Propleuræ strongly and somewhat irregularly punctured, and with a large oval depression on its lower side; the mesopleuræ in front with small punctures; the rest with the punctures large, coarse, and deep; at the bottom are five stout perpendicular keels, which form one oval and three straight foveæ; the sternum finely punctured; the mesosternum with a straight keel, which does not quite reach to the apex. Legs green; the femora and tibiæ punctured, sparsely covered with white hair; the tarsi with the hair shorter and thicker, black; the base broadly testaceous. Wings fuscous, with a violaceous tinge; the apex almost hyaline. Abdomen large; the puncturing moderately close, deep, and of about equal strength on all the segments; on all closer and stronger laterally. The apical segment waved; without teeth, but with a rounded projection on either side of the middle; there are 10 foveæ, the central large, broader than long, the others smaller and rounder; the ventral

surface green, finely punctured, the apical segment with a longitudinal furrow down the centre; the apex blackish.

B. Apex of third abdominal segment rounded, with a tooth on either side at the end.

CHRYSIS FURIOSA, *sp. nov.* (Pl. 16, f. 9).

Viridis, late cæruleo-maculata, flagello antennarum nigro; alis fere hyalinis. ♀. Long. 6 mm.

Hab. Barrackpore.

Head nearly as wide as the thorax, green, a large purplish-blue patch on the vertex. On the front distinctly below the ocelli is a stout keel depressed inwardly, broadly in the centre, continued as a straight somewhat oblique keel down the sides of the eyes, from which it is distinctly separated, and becoming united to a semicircular keel over the frontal depression, which is finely and closely punctured at the sides, and finely transversely striated in the middle. From the centre of the top frontal keel a short thick keel runs down to the centre of the area. The vertex bears longish fuscous hair; the sides of the frontal depression with short white hair. Antennæ black; the scape, second and third joints, green; the flagellum covered with a microscopic down; the scape with white hair; the third joint is fully one quarter longer than the fourth. Prothorax half the length of the head; the sides, seen from above, oblique at the base; the rest curved, the base and apex of the curve being distinct, almost forming teeth; the punctuation coarse and even; in the central region is a large bluish band. Mesonotum coarsely punctured, the punctures large, round, and deep; the punctuation on the scutellum and the middle of the median segment similar to that on the mesonotum. The front of the propleuræ coarsely punctured; the rest excavated, shagreened; the mesopleuræ coarsely punctured, almost running into

reticulations; the hinder part with the punctuation closer and finer; over the sternum is a wide, deep, longitudinal furrow. The prosternum has a semicircular furrow at the apex; and down its centre, before and behind the semicircular furrow, is a straight keel.

C. Apex of abdomen with a tooth on either side and in the middle.

This section resembles closely that of the preceding, from which it differs in having a tooth in the centre of the apex of the abdomen, and also in the front having no area enclosed by stout keels.

CHRYSIS MENDICALIS, sp. nov.

Long. 6 mm.

Hab. Barrackpore.

Green, the centre of the thorax and the greater part of the second and third abdominal segments, blue; the coxæ, femora, and tibiæ green; the tarsi fuscous; the wings almost hyaline.

Antennæ stout, black; the first and second joints green; the third joint hardly one-quarter longer than the fourth. Vertex coarsely punctured, almost reticulated on the lower side; the ocellar region, and the part behind, bluish-purple; the excavated front closely punctured at the side; the centre finely transversely striated; the keel over the depression stout, and reaching to near the bottom of the eyes. Pronotum slightly more than half the length of the eyes; the sides oblique, rounded in front, uniformly coarsely punctured, the central area more coarsely, almost running into reticulations towards the apex, and for the greater part purplish. The propleuræ with a large oval depression at the top, which is almost smooth; the lower part shagreened. The mesopleuræ coarsely punctured, almost reticulated; a small basal and a larger apical, smooth, deep depression

on the side of the mesosternum; the metapleuræ almost smooth above, shagreened beneath. Wings almost hyaline; the nervures fuscous; the stigma black; the tegulæ green, punctured. Abdomen with a triangular depression in the centre at the base; the basal segment green, tinged with blue; the second and third segments blue, their sides green; the apices with a brassy tinge; there are on each side of the centre two distinct foveæ of nearly equal size, and a much larger one looking like two united, at least on one side of the example examined; for on the other side there are four foveæ, all clearly separated from each other. Ventral surface smooth, shining, green, with brassy tints.

D. Apex of abdomen with four teeth.

CHRYSIS DISPARILIS, sp. nov.

Long. nearly 7 mm.

Hab. Barrackpore.

Green; the vertex, the mesonotum, and the greater part of the abdominal dorsal segments, bluish-purple; the tarsi broadly testaceous at the base.

Head as wide as the mesonotum and somewhat longer than the pronotum, green; the ocellar region and the greater part of the occiput purple, coarsely punctured; the cheeks thickly covered with long white hair. Over the frontal depression and below the ocelli is a curved keel. Antennæ stout; the third joint on the lower side equal in length to the fourth. The thorax strongly punctured; the pronotum entirely green; the mesonotum purple; the scutellum and metanotum green; the scutellum with a faint purplish tinge. Wings hyaline. The first abdominal segment green, with a large purplish mark across the middle; the second segment purple, green at the apex; the last purple, green before the teeth, which are themselves purple.

HEDYCHRUM LUGUBRE, *sp. nov.* (Pl. 16 f. 10).

Cæruleum, viride maculatum; flagello antennarum fusco; tarsis fusco-testaceis; alis fuscis. Long. 4—5 mm.

Hab. Barrackpore.

Scape of the antennæ green, rather strongly punctured; the flagellum fuscous-black, covered with a pale fuscous down; the third joint about one-quarter longer than the fourth. Head strongly punctured, the frontal depression finely and closely transversely striated. The base of the mandibles green, the rest of them blackish, with a piceous stripe before the middle. Prothorax longer than the head, strongly punctured above; two large blue splashes, nearly united, behind; its sides oblique, except at the apex, which is straight. Mesonotum in the middle purplish; the base, especially in the centre, with the punctures smaller and more widely separated than they are at the sides, and more especially behind; the scutellum, with the punctures larger and deeper than they are on the mesonotum; the median segments with the punctures larger and deeper than on the scutellum. Propleuræ in front coarsely punctured; behind smooth; the mesopleuræ coarsely punctured, behind finely striated; the metapleuræ finely longitudinally striated, more finely on the lower than on the upper side; the mesopleuræ finely transversely striated. Legs green, the tibiæ with a bluer tinge than the femora; the apex of the tibiæ testaceous; the tarsi dark testaceous, paler towards the apex. Wings uniformly dark fuscous; the nervures darker. Abdomen bluish, greener in tint in the middle; the punctures on the second segment more widely separated than on the basal; that on the third much coarser than on either. The ventral surface smooth, sparsely covered with white hair.

The head and thorax may have brassy tints; the relative proportions of the blue and green in the abdomen varies.

ICHNEUMONIDÆ.

ICHNEUMON ARDATES, *sp. nov.*

Niger, scutello flavo; abdomine rufo, flavo- et nigro-balteato; pedibus rufis; alis fere hyalinis, stigmatate flavo. ♀.
Long. 13 mm.

Hab. South India.

Head coarsely punctured; the inner orbits in the middle broadly, and a mark immediately below the antennæ, rufous; the palpi pale yellow. Antennæ short, thick, the 13—14 basal joints pale yellowish-testaceous, the apices deep black. Thorax black, except the scutellum which is pale yellow; closely punctured; the propleuræ closely obliquely striated except at the top. The lower part of the mesopleuræ coarsely punctured; the upper shining, irregularly shagreened; the metapleuræ closely coarsely irregularly striated. Median segment closely rugose; only the suprmedian area clearly defined; it is a little wider than long, slightly narrowed from the middle; the apex in the middle a little dilated inwardly. Legs, including the coxæ, rufous. The narrow part of the petiole rufous; the broad apex with a yellowish band, the sides black; the raised central part of the apex closely longitudinally striated. The sides of the gastrocœli stoutly striated. The second segment is entirely rufous; the basal half of the third segment and the whole of the fourth black; the apical half of the third yellow, with a reddish tinge; the apical segments pale-yellow.

ICHNEUMON ÆLVANUS, *sp. nov.*

Capite, abdomine pedibusque rufis; thorace nigro, rufomaculato; antennis rufis, apice late nigro; pedibus rufis, coxis posticis nigris; alis fusco-violaceis. ♂. Long. 23 mm.

Hab. India, South-east Provinces.

Head entirely rufous, strongly punctured all over; the orbits distinctly margined on the inner side; the vertex broadly depressed; the tips of the mandibles black. Antennæ stout, the flagellum bare, from the 15th joint deep black. Thorax strongly punctured, black; the pronotum in front in the middle, its sides, a mark in front of the scutellum, the scutellum and post-scutellum, the tubercles and the lower part of the mesopleuræ in front, rufous; median segment strongly punctured, except in the middle at the base; the suprmedian area rounded and narrowed at the base. Legs closely covered with short hair; the tibiæ and tarsi are paler than the femora. Wings uniformly fuscous violaceous; the areolet longish, narrow; at the top slightly narrower than the space bounded by the recurrent and second transverse cubital nervures. The basal half of the petiole black; coarsely punctured, especially toward the apex; the sides there depressed, and there is near the base of the dilated part a shining, impunctate, somewhat triangular space; the gastrocœli longitudinally striated from the base to near the apex; the striæ stout, all distinctly separated and of nearly equal thickness. The apical segments are thickly covered with short fulvous hair.

ICHNEUMON GODWIN-AUSTENI, *sp. nov.*

Cæruleus, orbitis oculorum, geniculis tibiisque anticis flavis; alis fusco-violaceis. ♀. Long. 15 mm.

Hab. Khasi (*Godwin-Austen*).

Antennæ black, the 11th and 12th joints white beneath and at the sides, from these joints becoming

thickened and slightly compressed laterally; almost bare. Head shining, the outer orbits at and a little below the middle and the inner from the top to shortly below the middle, yellowish. Face flat, slightly dilated in the middle below the antennæ; punctured, the punctures at the sides more widely separated than in the middle, this being also the case on the front and vertex. Pro- and meso-thorax closely and uniformly punctured; the scutellum more shining and sparsely punctured; the median segment more strongly and closer punctured than the mesonotum, which has the areæ all clearly defined. Legs blue, the coxæ closely and thickly covered with white hair; the femora sparsely haired. Areolet narrowed at the top, the transverse cubital nervures being almost united; the recurrent nervure is received in the apical third of the areolet. Abdomen closely and strongly punctured; the apex of the petiole raised; the raised part clearly margined and separated from the sides; this raised part is longitudinally striated. Gastrocœli wide, deep; their sides obliquely striated; the part between the gastrocœli in the middle longitudinally at the sides, especially at the base, more strongly obliquely, striolated.

This species has the antennæ thickened towards the apex somewhat as it is in *Joppa*, but I cannot look upon it as congeneric with the American species of *Joppa*. Apart from the dilated antennæ (and in this point we find considerable variation in *Ichneumon*) I can find nothing whereby to distinguish it from *Ichneumon* as generally defined.

CRYPTUS PERPULCHER, *sp. nov.* (Pl. 16, f. 7).

Niger, thorace abdomineque flavo-maculatis; pedibus fulvis, apice femorum posticorum basique tibiarum posticarum, nigris; alis hyalinis. ♂. Long. 13 mm.

Hab. Borneo.

Antennæ black, bare, a broad white band near the middle. Head black; a mark close to the eyes opposite the ocelli, a mark touching the eyes immediately under the antennæ, and having a somewhat roundish projection issuing obliquely from above its middle, the mandibles (except the teeth) and the palpi, whitish-yellow; the face above the clypeus irregularly striated; front depressed, especially over the antennæ, where there is a straight keel in the centre; below the ocelli are a few oblique stout striæ. Pro- and meso-notum smooth, shining, impunctate; the middle lobe of the mesonotum well developed; the pro- and meso-pleuræ stoutly longitudinally striolated, except the former above at the base, where there is a smooth triangular spot; and the apex of the mesopleuræ where the striations only extend to the lower side. The base of the median segment before the keel is smooth, the rest of it closely transversely striated; the metapleuræ irregularly rugosely punctured. The following yellow marks are on the thorax: The tegulæ, scutellum, post-scutellum, an elongated triangular mark before the spiracles; a smaller one in front of and above the hinder coxæ; and a **L**-shaped mark on the median segment extending from near the transverse keel to the apex of the segment, the cross piece being thicker than the longitudinal. The coxæ are black, except the anterior at the extreme apex; the middle pair have a small mark at the base, and the hinder part a large yellow mark extending from the base to near the apex, its inner end being more prolonged than its outer; the fore coxæ and trochanters are whiter in tint than the others; the hinder trochanters are black, this being also the case with the apex of the femora, and to a less extent the base of the tibiæ; the four front tarsi are dark fuscous; the apex of the hind tibiæ, the base of the metatarsus broadly, and the extreme apex of the tarsi, black; the fore tarsi are

infuscated; the middle almost black. Wings hyaline, the stigma and nervures black; the areolet longer than broad; the second recurrent nervure received near the apical third of the cellule. Abdomen black, shining. All the segments pale yellow at the apex; the apical one almost entirely yellow; the ventral segments black, dull yellow at the apices.

CRYPTUS BROOKEANUS, *sp. nov.*

Niger, annulo late flagello antennarum tarsisque posticis albis; pedibus fulvis; trochanteribus posticis, apice femorum posticorum tarsisque posticis nigris; alis hyalinis. ♀. Long. 11 mm.

Hab. Borneo.

Antennæ as long as the body, from the apex of the fifth to the base of the fourteenth joint white above and at the sides; bare. Head black, bearing a short, sparse, black pubescence; the front, except at the sides, irregularly longitudinally striolated; the striæ rather stout; the face shagreened; the palpi white. Thorax entirely black; the pro- and meso-notum almost shining, impunctate; the base of the median segment behind the transverse keel (which is broadly curved backwards in the centre) irregularly longitudinally striated, and with two stout straight keels down the centre; behind this keel it is irregularly reticulated; in the middle at the sides are two stout spines. The upper part of the propleuræ is obliquely striolated, the striæ becoming stronger towards the apex, at the base in the middle being almost obsolete; the portion over the coxæ impunctate, smooth; the mesopleuræ closely irregularly longitudinally striolated; immediately under the wings are a few stout, clearly-separated oblique striations, which are mostly turned up at the base. The mesosternum smooth, impunctate, except a crenulated

furrow down its centre, and separated from the pleuræ by a curved crenulated furrow. Legs fulvous; the four anterior tibiæ and tarsi infuscated; the fore tibiæ white in front; the hinder trochanters, the apical third of the hinder femora and the hinder tibiæ, black; the hinder spurs black; the tarsi white, the extreme apex black. The second transverse cubital nervure is faint; the recurrent nervure is received in the apical third of the cellule. The petiole is smooth and shining; the sides at the apex depressed; the rest of it alutaceous; the apex of the second segment pale testaceous.

ICHNEUMON MITRA, *sp. nov.* (Pl. 16, f. 6).

Long. 12 mm.

Hab. Borneo.

Antennæ stout, almost bare, the 10—15 joints white except beneath. Head black; the orbits from shortly above the antennæ to shortly behind the hinder ocelli, the sides and apex of the clypeus (the latter narrowly), the labrum and palpi, yellowish-white; the mandibles piceous before the middle. The face rather strongly punctured; the punctures on the clypeus more widely separated towards its apex; the space above the antennæ shining and impunctate; the vertex coarsely punctured. The face and vertex covered with short white hair; the inner orbits distinctly margined. Thorax black; the edge of the pronotum, tubercles, tegulæ in front, and scutellum, yellowish-white. Thorax closely punctured; the propleuræ closely punctured above, beneath shining, and with strong, somewhat oblique keels behind; the mesopleuræ with the punctures larger and more clearly separated above, the lower part with them smaller and much more closely set together, and at the apex running into striæ. The mesonotum closely punctured; the scutellum has the punctures shallower and more clearly separated; the yellow mark does not occupy quite its

entire surface, and is somewhat mitre-shaped; the post scutellum shining, impunctate. The median segment strongly punctured, thickly covered (especially behind) with white hair; the suprmedian area longer than broad; the sides almost straight; the base transverse; the apex curved roundly inwardly. The metapleuræ are more coarsely punctured than the mesopleuræ, and more thickly haired. Legs black; the front tibiæ and tarsi dirty testaceous (perhaps discoloured); the outer half of the fore coxæ, the outer side of the middle and a larger mark on the hinder side of the hinder coxæ, yellowish-white; the spurs also yellowish-white. Wings hyaline; the stigma and nervures black; the latter paler towards the apex; the areolet at the top in length a little less than the space bounded by the recurrent and the second transverse cubital nervures. Abdomen black; the base of the first, second, and third segments with yellow bands dilated at the sides, and which become gradually narrowed, a large mark on the sixth, rounded at the base, narrowed gradually at the sides and the greater part of the seventh, yellowish-white. The ventral segments black; the basal yellowish in the middle.

This species is abundantly distinct from the two species of *Ichneumon* described by Smith from Borneo, the antennæ of *I. penetrans* and the head of *I. comisator* being for the greater part yellow.

BRACONIDÆ.

BRACON BORNEENSIS, *sp. nov.*

Capite, thorace pedibusque flavis, abdomine ferrugineo; alis fuscis, basi late flavo; flagello antennarum nigro. ♂.
Long. 10 mm.

Hab. Borneo.

Scape of antennæ pale yellow, sparsely covered with longish hairs; the flagellum entirely black. Head

shining, sparsely covered with fuscous hair, which is longer and paler below the antennæ than on the vertex. At the sides and behind the ocelli are bordered by a distinct furrow; in front of them is a depression from which a straight narrow furrow runs to the base of the antennæ. Thorax smooth, shining, impunctate, the upper part fulvous, the sides and sternum paler. Legs fulvous, sparsely haired. Wings from the transverse basal nervure dark fuscous, with a slight fulvous tinge; the stigma and the nervure in the fuscous part of the wings, blackish; in the yellowish, yellow. The central part of the petiole above has a few widely separated keels; the lateral furrows wide and deep; the central part has the sides at the apex rounded and with a wide short furrow on the inner side. Down the centre of the second segment is a straight keel depressed in the middle, and which does not quite reach the apex of the segment; on either side at the base is a wide oblique depression reaching near to the apex; at its base are some sharply oblique keels; the rest of it has a few semi-oblique keels; the suturiform articulation has throughout straight stout keels; the other segments coarsely rugosely punctured, except the last, which is smooth, shining, impunctate, and of a pale yellow colour.

Is not unlike *B. Rothneyi* but is larger, the base of the wings more broadly yellow; the lateral depression on the second abdominal segment is much larger and deeper; the central keel much more complete and clearly defined and without a smooth triangular base; the base of the antennæ yellow, not black, &c.

BRACON DISSIMULANDUS, *sp. nov.*

Niger; *capite, pro-mesothorace metapleurisque ferrugineis; alis fuscis, fere violaceis.* ♀. Long. 14; terebra 5 mm.

Hab. Borneo.

Head ferruginous, the teeth of the mandibles black; rather closely covered with black hair, particularly on the face; the front and vertex smooth, the face smooth in the centre, the sides with large, shallow, distinctly separated punctures; the sides of the clypeus have a yellowish hue; the palpi are covered with long, black hair; the mandibular teeth black. Antennæ entirely black; the scape with longish black hair. Pro- and meso-thorax smooth and impunctate; their pleuræ and sternum sparsely covered with fuscous hairs. The metathorax thickly covered with longish black hair; the upper part almost entirely black. The two anterior legs entirely ferruginous; the four hinder black; the intermediate with the base of the coxæ broadly, and the extreme base and apex of their femora ferruginous; the hinder legs are thickly haired. Wings large, uniformly smoky-violaceous; there is an elongated clear hyaline spot below the first transverse cubital nervure. The petiole is deeply depressed at the base; the raised centre bordered along the sides by a wide, moderately deep, shallow furrow; the raised central part bearing stout longitudinal keels; the central being stouter and straighter; at the apex of the segment there are shorter keels between the longer ones, or those become bifid. The third segment is nearly similarly striolated, but with the striæ closer together; and there is at the apex an interrupted transverse furrow; the remaining segments shining, smooth; the ventral surface pale-yellowish, the sheaths of the ovipositor thickly covered with long hair.

Of the Oriental species it comes nearest to *B. foveatus* Sm., but that has the ovipositor twice the length of the body.

BRACON CHARAXUS, *sp. nov.*

Niger; capite, thorace pedibusque anticis ferrugineis; alis fuscis, fere violaceis. ♀. Long. 11; terebra 12 mm.

Hab. Borneo.

Antennæ black; the flagellum almost bare; the scape thickly covered with blackish hairs, and piceous in the middle beneath. Head shining, sparsely covered with long fuscous hairs; below the antennæ bearing all over except in the middle, where there is a smooth space, moderately large punctures; the front and vertex very smooth and shining, except for a few small punctures along the inner orbits; the mandibles ferruginous, their teeth black; the palpi fuscous. Thorax entirely ferruginous, smooth, shining, impunctate; the middle lobe of the mesonotum raised; the median segment sparsely covered with long black hairs; on its side is a deep wide furrow, which does not reach the base. Wings uniformly deep smoky, but with a violaceous tinge. The fore legs entirely ferruginous, as are also the middle coxæ, except that they are darker; the four anterior legs sparsely covered with short hair; the hinder tibiæ and tarsi have the hair much longer and thicker. The petiole above is smooth and shining, except the apex in the middle, where it is a little rough; the middle part bounded by the keels is almost transverse, and has behind it a small space bearing some minute punctures; the outer divisions at the apex are obliquely truncated. The 2—4 segments are closely and strongly longitudinally striolated, the striations on the second being irregular; in the centre of the second segment are two keels, which unite in the middle and are continued to the apex as one; from the base near the edge runs another keel, which runs obliquely to the central keel, when it becomes straight; the sides are distinctly margined above; on the side of the second segment is a large smooth, shining space; and there is a similar one, but smaller, on the third in front of the depression; the other segments are smooth and shining, the last is

depressed at the base and is fringed at the apex with longish hairs. The ventral segments, except at the apex, are, in the middle, yellowish-testaceous; the last ventral segment projects beyond the apex of the dorsal.

Allied apparently to *B. foveatus* Sm. from Singapore; but that, among other differences, has the ovipositor twice the length of the body.

POMPILIDÆ.

SALIUS LEPTOCERUS, *sp. nov.*

Niger, abdomine pedibusque rufis; capite, thorace coxisque dense fulvo-hirtis; alis fusco-violaceis. Long. 17; exp. al. 24 mm.

Hab. Sikim.

Antennæ a little longer than the body, entirely black, except the scape on the under side, which is rufous. Head densely covered all over with a golden fulvous pile and less densely with long fulvous hair. Mandibles densely covered with short depressed fulvous pubescence; the palpi blackish. Thorax densely covered all over with golden fulvous pubescence and more sparsely with longish pale fulvous hair; there is a wide, deep furrow down the centre of the post-scutellum, and there is a narrower, less distinct one down the base of the median segment, which is obscurely transversely striated. Wings fuscous-violaceous, shining, the nervures blackish; the first recurrent nervure is received a short distance in front of the second transverse cubital; the nervures dark fuscous, the stigma darker at the base. Legs red; the coxæ black, densely covered with golden pubescence and, more sparsely, with longish fulvous hair; the posterior are rufous on the under side; the trochanters are black at the base. Abdomen dark fulvous; the second, third, and fourth segments black at the base.

Comes near to *S. zelotypus* Bingham from Tenasserim.

DOLICHUSUS CLAVIPES, *sp. nov.* (Pl. 16, f. 4).

Niger; *alis hyalinis*. ♀. Long. 9 mm.

Hab. Barrackpore (*Rothney*).

Antennæ filiform. Immediately above, and slightly protruding over them is a large projection which, seen from the side, is triangular; above depressed, the sides and apex distinctly raised; the base not margined; the front and vertex shining, impunctate. Antennæ separated from the base of the clypeus, which is keeled down the centre. Eyes reaching to the base of the mandibles. Radial and cubital cellules not differing from *Pseudagenia*. Prothorax somewhat longer than in typical *Pseudagenia*. Mesonotum with two nearly complete, deep parapsidal furrows; the median segment with distinct areæ; on the sides on the top of the apical part is a small blunt tooth, and in the middle is a much larger and more distinct one. At the base of the third ventral segment is a transverse furrow; the sheath of the ovipositor largely projecting. Claws with one tooth.

Antennæ filiform, the scape sparsely haired; the flagellum closely covered with a short pubescence. Head shining, impunctate; sparsely haired; the outer orbits on the lower side thickly covered with longish white hair; the clypeus, especially at the sides, and the base of the mandibles with longer white hairs. Thorax shining; pro- and meso-notum thickly covered with fuscous hair; the hair on the median segment longer and thicker; the apex of the pronotum depressed and clearly separated from the mesonotum. The parapsidal furrows do not quite reach to the apex of the mesonotum. Apex of scutellum semi-circular; post-scutellum stoutly longitudinally striolated. In the centre of the median segment are two keels which converge a little at the apex of the flat part, and these are united by a transverse keel; the centre at the base

shagreened and with four irregular longitudinal keels; the oblique apex shagreened. Propleuræ shining; the mesopleuræ shining above, shagreened below; the top projecting, oblique; a keel runs down the base from the tubercles; the metapleuræ closely longitudinally striolated. Legs shining, sparsely haired; the base of the hind spurs thickly covered with stiff pale hairs. Wings clear hyaline; the nervures blackish; the first transverse cubital is sharply elbowed from a little below the middle towards the apex of the cellule, the second straight, the third curved roundly toward the base of the cellule; the first recurrent nervure is received shortly beyond the middle of the cellule, the second near the basal third.

SPHEGIDÆ.

DIODONTUS STRIOLATUS, *sp. nov.* (Pl. 16, f. 3).

Niger, mandibulis, tegulis, geniculis, tibiis tarsisque flavis; alis hyalinis, nervis stigmatæque fuscis. ♂. Long. fere 5 mm.

Hab. Lahore (*Rothney*).

Antennæ entirely black, almost bare; the apex of the scape fuscous. Head shining, the front and vertex with fine, distinctly-separated punctures; mandibles yellow, the extreme base black, the teeth piceous-black; the palpi yellow; the clypeus projecting, roundly and deeply incised in the middle. Thorax shining, faintly aciculated above; the propleuræ with stout, distinctly separated striæ; the apical half of the mesopleuræ closely longitudinally striated, the striations becoming closer together at the apex; the metapleuræ, except at the base beneath, more strongly and irregularly striolated. The apex of the four front femora, the tibiæ and tarsi, testaceous; the middle tibiæ infuscated behind; the hinder tibiæ blackish; the hinder tarsi infuscated. Wings short, not reaching

much beyond the middle of the abdomen, slightly infuscated, the nervures testaceous, the stigma black; at the top the second cubital cellule is slightly wider than the space bounded by the first transverse cubital and the second recurrent nervures. Legs sparsely covered with white pubescence; the apex of the femora, tibiæ and tarsi, testaceous; the hinder tibiæ infuscated. Abdomen shining.

DIDINEIS ORIENTALIS, *sp. nov.* (Pl. 16, f. 2).

Niger, mandibulis, scapo antennarum subtus, tibiis, tarsis tegulisque albidis, alis hyalinis, nervis fuscis. ♂. Long. 5 mm.

Hab. Barrackpore (*Rothney*).

Antennæ fuscous, darker above, the scape bearing a few hairs, the flagellum thickly covered with short pile; the base of the apical joint before the base of the curve projecting. Head shining; the vertex with shallow closely-pressed punctures, and covered with longish blackish hair; the vertex with the hair shorter and closer; the cheeks and clypeus thickly covered with silvery hair, that on the clypeus being the longer. Mandibles with longish silvery hair; their base black, the rest piceous, with a yellow band between; the palpi yellow. Thorax black, shining, closely covered on the pro- and meso-thorax with black hair; almost impunctate; the depression on the propleuræ with a few stout, oblique keels. In the centre of the median segment is a large somewhat triangular area, but with the apex rounded, bounded by stout keels, and having in the centre of it two slightly diverging keels, which reach a little beyond the middle. From the apex of the triangle a straight keel runs down to the apex of the segment, and in the centre at the side is a somewhat semicircular area, which is joined to the central keel

by two short transverse ones. Legs thickly covered with short white hair; the apices of the coxæ, of the trochanters and of the femora, the base of the hinder tibiæ, the four anterior tibiæ and all the tarsi, yellowish-testaceous; the femoral tooth stout, oblique, somewhat triangular; the apex of the hinder femora fuscous. The wings have a faint fuscous tinge; the stigma fuscous, the nervures dark testaceous; the second cubital cellule oblique, at the bottom longer than the third cellule; the recurrent nervures almost interstitial; the third transverse cubital nervure is curved at the top; the lower part straight, oblique. Abdomen smooth and shining, sparsely covered with longish white hair, which becomes longer and thicker towards the apex.

This and *Alyson* are interesting additions to the Oriental Zoological Region, the few described species being from Europe and North America.

ALYSON ANNULIPES, *sp. nov.* (Pl. 16, f. 1).

Niger, mandibulis basi tibiæ posticarum maculisque 2 abdominis flavis; alis hyalinis, fusco-fasciatis. ♀. Long. 6 mm.

Hab. Poona (*Wroughton*).

Black, shining, almost impunctate; the head, pro- and meso-thorax sparsely covered with long fuscous hair; the apex of the median segment with shorter white hair. Head shining, smooth; the upper part covered with fuscous hair, which is much longer behind the ocelli; the lower part is more thickly covered with short silvery pubescence. Mandibles broadly yellow behind the middle, the two basal teeth piceous, the apical tooth darker in colour. The inner orbits with a yellow line; the clypeus yellow, the extreme apex piceous; the central tooth larger, the lateral not half its size; the palpi yellow. Thorax black, except two yellow marks on the

scutellum; rather thickly covered with longish fuscous hair; the hair on the pleuræ and apex of the median segment white. Median segment transversely irregularly striated; in its centre is a somewhat triangular area which reaches near to the apex of the top part, where it is rounded, and from which a straight keel runs to the apex; down the centre of the triangular area are two keels not reaching the end of the area, and bulging out at the apex. At the top of the oblique apex are, on each side of the central keel, three areæ, the inner being the larger; the rest of the areæ irregular. Wings clear hyaline, the stigma and nervures black; the radial, the base of the first and the second and third cubital cellules, smoky. Legs thickly covered with short white hair; the anterior knees, tibiæ, and tarsi yellowish in front; the apices of the four hinder coxæ and of the trochanters, a line below the apex of the hinder tibiæ, and the spurs yellow; the femoral tooth oblique, stout, twice as long as broad, the apex bluntly rounded. Abdomen shining, impunctate, the apex and ventral surface sparsely covered with long black hairs; the spots on the second segment obscure yellow (perhaps discoloured); the third segment obscure testaceous laterally at the base.

GASTROSERICUS BINGHAMI, *sp. nov.* (Pl. 16, f. 8).

Long. 5 mm. ♂.

Hab. Barrackpore (*Rothney*).

This species differs in too many points from *G. Rothneyi* to be its ♂. It differs also from the type of the genus (*G. Waltii* from Egypt) in having the clypeus toothed in the middle.

Head alutaceous, the vertex covered with a pale golden microscopic down; the orbits behind with silvery pubescence; the face and oral region thickly covered with

golden pubescence; the space where the hinder ocellus should be, shining, smooth. Clypeus yellow, the apex piceous; its centre raised and projecting into a stout triangular tooth; the mandibles yellow, piceous at the apex. Antennæ stout; the basal joints with a minute silvery pubescence; the apex of the scape yellow; the ocellar space raised and surrounded, except in front, by a furrow, and a wider furrow runs down the vertex. Thorax alutaceous; the scutellum finely punctured; the median segment at the apex finely punctured; the extreme apex minutely transversely striated; the fovea is wide and deep, sharply narrowed at the apex. The sides, base, and apex of the mesonotum thickly covered with golden hair; the hair on the meso- and meta-pleuræ silvery. Tegulæ and a curved spot at the apex of the pronotum yellow. Wings hyaline, the nervures and costa fuscous, darker towards the apex. Legs black; the apical half of the fore femora, the apices of the four hinder and the tibiæ and tarsi clear yellow; the four hinder tibiæ broadly lined with black behind at the base; the 3—5 joints of the hinder tarsi infuscated. Abdomen covered with a sericeous pubescence; the sides of the dorsal and the apices of the apical ventral segments obscure testaceous; the apical segment for the greater part rufous.

PISON ORIENTALE, *sp. nov.*

Long. 8 mm.

Hab. Barrackpore (*Rothney*).

Comes near to *P. striolatum*, but differs in the striolated metapleuræ. Entirely black; head and thorax thickly covered with long fuscous hairs; the face more closely covered with silvery hair. Front rugosely punctured; behind the ocelli the punctures much finer and more widely separated. Apex of clypeus shining, bare, the apex in the middle produced into a small rounded

point. Antennæ covered with a white microscopic pile. Thorax thickly covered with longish whitish hair. Mesonotum bearing large distinctly separated punctures which are much closer together; scutellum with the punctures smaller and not so deep, and almost absent in the centre. Median segment with a wide furrow in the centre in which are a few stout transverse keels; on either side of this it is irregularly punctured and has some curved striæ. Propleuræ shining, strongly depressed obliquely in the centre; mesopleuræ strongly punctured all over, and without a distinct longitudinal furrow; metapleuræ almost impunctate and more shining than the mesopleuræ. Wings hyaline, the costa and stigma black, the other nervures not so deep in tint; the recurrent nervures received shortly in front of the transverse cubital. Abdomen thickly covered with white hair, which is especially thick at the sides of the segments at their apices; the basal segments sparsely punctured; the others impunctate; the basal ventral segment strongly punctured.

PISON APPENDICULATUM, *sp. nov.* (Pl. 16, f. 5).

Long. 7—8 mm.

Hab. Barrackpore (*Rothney*).

Resembles *P. orientale*, but has the body more thickly pilose, the apex of the clypeus more broadly produced in the middle, the appendicle of the areolet as long as the cellule itself, and the recurrent nervures are received at a greater distance from the transverse cubitals.

Head closely and rather strongly punctured, more closely and hardly so strongly behind the ocelli; the front and vertex covered with long fuscous hair; from the lower part of the eye incision to the apex of the clypeus thickly covered with longish silvery hair, which hides the sculpture entirely; the apex of the clypeus

roundly produced in the middle. Thorax thickly covered with long fuscous hair; the mesonotum strongly punctured, particularly at the sides; the centre of the scutellum almost without punctures; the median segment at the base shagreened, the centre with a wide, deep furrow, in which are a few stout transverse keels; the apex is irregularly and rather strongly transversely striated, the striations coarser above than below; there is a deep furrow at the top. Propleuræ coarsely shagreened; the mesopleuræ strongly punctured and without a furrow; the basal half of the metapleuræ more shining and less pilose than the rest. Wings hyaline, the nervures and stigma blackish; the pedicle of the petiole oblique, as long as the cellule; the recurrent nervures are received somewhat less than half the length of the cellule in front of the transverse cubital nervures. Legs thickly covered with longish hair and white pile; the spurs pale testaceous at the base. Abdomen thickly haired, and, at the apices of the segments, lined with silvery pubescence.

PISON (PARAPISON) CRASSICORNE, *sp. nov.*

Long. 5 mm. ♀.

Hab. Barrackpore (*Rothney*).

Comes near to *P. Rothneyi*, but smaller, the furrow on the median segment extending from the base to the apex; and the apex transversely striolated.

Head: the vertex and front shagreened, covered with a short fuscous pubescence; the cheeks and clypeus thickly covered with silvery pubescence; the mandibles and palpi pale testaceous. Antennæ entirely black, distinctly thickened towards the apex. Thorax shining, the pro- and meso-thorax impunctate, the oblique half of the median segment transversely striated; there is at its base a narrowish furrow, and behind the striated part,

and separated from the basal, is a short, wider, and deeper furrow. The pro- and meso-pleuræ are shagreened; the latter has a wide and deep longitudinal furrow in the middle; the metapleuræ are shagreened at the base; the rest smooth and shining. The second cubital cellule at the top is as wide as the space bounded by the recurrent and first transverse cubital nervures; the upper part of the second transverse cubital nervure is curved; the lower straight, only slightly oblique; the second recurrent nervure is interstitial. The four front tibiæ are for the greater part dark testaceous; the hinder pair broadly dark testaceous at the base; the calcaria pale. Abdomen shining, impunctate, densely covered with white pubescence towards the apex; the five apical segments cream-coloured at their apices, the last more broadly than the others.

TRYPOXYLON COGNATUM, *sp. nov.*

Nigrum, abdomine rufo-balteato, capite thoraceque dense albo-pilosis, calcaribus albis; alis hyalinis, apice fere fumato.
♀. Long. 11 mm.

Hab. Himalaya.

Head black; the front and vertex alutaceous; the former with a shallow longitudinal depression in the centre; the eye incisions and the clypeus and the space below the antennæ densely covered with silvery pubescence; the vertex covered with short fuscous pubescence; the outer orbits except at the top, covered with longish, silvery pubescence; the mandibles piceous towards the apex; the palpi pale yellow. Antennæ entirely black, the scape covered with white hair. Thorax black; the mesonotum very shining, and with a bluish tinge; the pubescence on the pro- and meso-notum and scutellum dense, pale, that on the post-scutellum longer than on the scutellum. At the base the median segment is longi-

tudinally striated; in the centre depressed, and in the middle of the oblique part is a longer, wider, and deeper depression; the apex closely punctured. Pro- and mesopleuræ and sternum densely covered all over with dense white pubescence; the metapleuræ sparsely covered with shorter white hair at the apex. Legs entirely black, except the apices of the four anterior tarsi, which are rufous, and the spurs, which are white. Wings clear hyaline, the apex slightly infuscated; the stigma and costa black; the nervures paler. Abdomen densely covered with short, pale hair; the petiole longer than the second and third segments united; the apex of the petiole and the second and the third segments ferruginous.

Comes nearest to *T. rejector* Sm. from Mainpuri, with which it agrees in coloration, but which differs from our species in having "an impressed line in front of the anterior ocellus, terminating at an elevated carina just above the insertion of the antennæ" (*cf. Trans. Zool. Soc. vii., 189*).

Explanation of Figures in Plate 16.

1. *Alyson annulipes*.
 2. *Didineis orientalis*.
 3. *Diodontus striolatus*.
 4. *Dolichusus clavipes*.
 5. *Pison appendiculatum*.
 6. *Ichneumon mitra*.
 7. *Cryptus perpulcher*.
 8. *Gastrosericus Binghami*.
 9. *Chrysis furiosa*.
 10. *Hedychrum lugubre*.
-

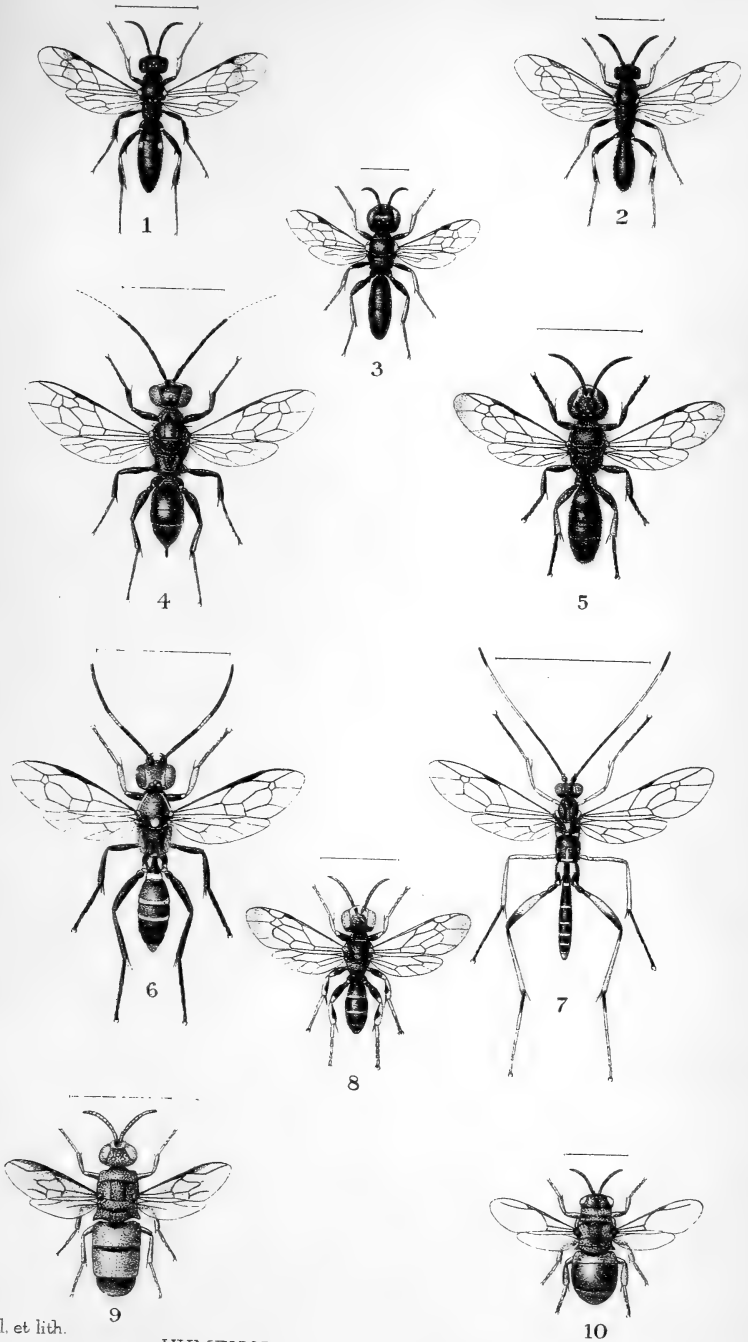

W. Purkiss, del. et lith.

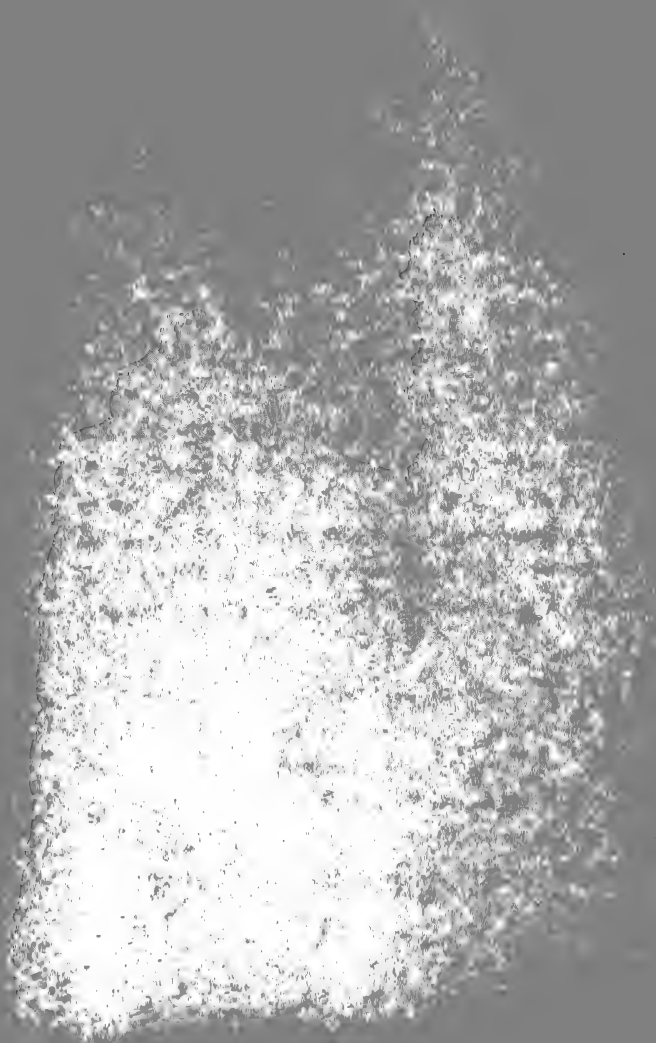

XIV. The Composition of some Ancient Iron Implements and a Bronze found at Thebes.

By ARTHUR HARDEN, M.Sc., Ph.D.

Read April 27th. Received May 1st, 1897.

The iron implements in question were found by Flinders Petrie, and are stated by him to date from about 670 B.C., a period at which iron had not passed into common use even among the Greeks. According to their discoverer the forms of these tools are quite unknown in Egyptian use, but were evolved by an iron-using people. The implements are probably relics of the Assyrian invasions (669-666 B.C.) Although many specimens of iron more ancient than these are known, so far as I am aware, no analyses of manufactured iron dating from before the Christian Era have hitherto been made.

The collection of implements which is now in the Owens College Museum includes several chisels, saws, files, rasps, nails, and other small objects. The main interest of the analytical examination was to ascertain the amount of carbon present in the iron, along with the several amounts of silicon, phosphorus, sulphur, and

September 22nd, 1897.

manganese. Two implements were selected for examination:—

(1) A chisel shaped like a modern mortise chisel, which weighed 333·05 grams and had a specific gravity of 7·763 at 18°/18°. The blade was sufficiently hard to scratch apatite but not felspar, and must, therefore, be considered as soft. This implement contains a small amount of nickel and cobalt (about 0·15%), metals which are frequently found in iron in small amount. It also contains a trace of copper, but appears to be quite free from manganese.

(2) An implement shaped like a modern hard edge or hardie, used in blacksmith's work. This weighed 462·5 grams, and was decidedly harder than the chisel, the edge distinctly marking felspar. The metal of this implement is free from nickel and cobalt, as well as from manganese.

The analytical results were as follows:—

	(1) CHISEL.	(2) HARDIE.
Carbon	0·11	0·15
Silicon	0·07	0·22
Sulphur	0·026	0·03
Phosphorus	0·01	0·07

Both the implements, therefore, contain a very low amount of carbon, and must be characterised as very mild steel or even malleable iron incapable of becoming very hard by tempering.

An experiment was made with one of the files to see whether it was capable of becoming hard, and it was found that when the metal was heated to whiteness and quenched in water it did become distinctly harder, but was still much softer than a modern file.

The specimen of bronze was taken from a small model of an implement found in the foundation deposit

of a building in Thebes, and probably dating from 1500-1000 B.C. Analysis shows that it is a true bronze, its composition being—

Copper	93·3
Tin.....	6·8
Iron	0·5

This metal, it must be remembered, was not intended for use as an implement but merely as a model, and hence it had not been hardened by the addition of cuprous oxide, as were some of the tools of similar date analysed by Gladstone. The presence of tin also indicates that the alloy is not of the highest antiquity, since Berthelot has shown that a Copper Age preceded the Bronze Age. It is interesting to note that the particular bronze which was analysed had not been at all converted into carbonate, and was quite free from any green coating, although the opinion is held by some archæologists that articles which escape attack in this way may be classed as pure copper.

THE WILDE LECTURE.

XV. On the Nature of the Röntgen Rays

By SIR G. G. STOKES, Bart., F.R.S.

Delivered July 2nd, 1897.

Ever since the remarkable discovery of Professor Röntgen was published, the subject has attracted a great deal of attention in all civilised countries, and numbers of physicists have worked experimentally, endeavouring to make out the laws of these rays, to determine their nature if possible, and to arrange for their application. I am sorry to say that I have not myself worked experimentally at the subject; and that being the case, there is a certain amount of presumption perhaps in my venturing to lecture on it. Still, I have followed pretty well what has been done by others, and the subject borders very closely on one to which I have paid considerable attention; that is, the subject of light.

In Röntgen's original paper he stated that it was shown experimentally that the seat of these remarkable rays was the place where the so-called cathodic rays fall on the opposite wall of the highly-exhausted tube in which they are produced. I will not stop to describe what is meant by cathodic rays. It would take me too much away from my subject, and I may assume, I think, that the audience I am now addressing know what is meant by that term. This statement of Röntgen's was not, I think, universally accepted. Some experimentalists set themselves to investigate the point by

September 22nd, 1897.

observing the positions of the shadows cast by bodies subjected to the discharge of the Röntgen rays—to investigate, I say, the place within the tube from which the rays appeared to come. Now, when the shadows were received on a photographic plate, and the shadow was joined to the substance casting the shadow, and the joining lines were produced backwards, as a rule they tended more or less nearly to meet somewhere within the tube—Crookes' tube, I will now call it—and some people seem to have had the idea that at that point of meeting or approximate meeting there was something going on which was the source of these rays. I have in my hands a paper published in St. Petersburg by Prince B. Galitzin and A. v. Karnojitzky, which contains some very elaborate photographs obtained in this way. A board was taken and ruled with cross lines at equal intervals, and at the points of intersection nails were struck in in an upright position. The board was placed on top of the photographic plate, with an opaque substance between—a substance which these strange Röntgen rays are capable of passing through, though it is impervious to light. The shadows cast by the nails were obtained on the photograph, and this paper contains a number of the photographs. It is remarkable, considering the somewhat large space in the tube over which the discharge from the cathode is spread, that the shadows are as sharp as they actually are; and the same thing may be affirmed of the ordinary shadows of the bones of the hand, for instance, which one so frequently sees now. Another remarkable point in these photographs is that in some cases it appears as if there were two shadows of the same nail, as though there were two different sources from which these strange rays come, both situated within the Crookes' tube. Now, have we a right to suppose that

the place of meeting of the lines by which the shadows are formed, prolonged backwards into the tube, is the place which is the seat of action of these rays? I think we have not. If a portion of the Crookes' tube which is influenced by the cathode discharge be isolated by, we will say, a lead screen containing a small hole, you get a portion of the cathodic rays which come out through that small hole, and you can trace what becomes of them beyond. It is found that the influence is decidedly stronger in a normal direction than in oblique directions. Professor J. J. Thomson, of Cambridge, who has worked a great deal experimentally at this subject, mentioned that to me as a striking thing. You might imagine that the fact that the shadows appear to be cast approximately from a source within the tube could be accounted for in this way. Supposing, as Röntgen believed, that the seat of the rays is in the place where the cathode discharge falls on the surface of the glass, those which come in an oblique direction have to pass through a greater thickness of glass than those which come in a normal direction. Now, glass is only partially transparent to the Röntgen rays; therefore the oblique rays would be more absorbed in passing through the glass than the rays which come in a normal direction. I mentioned that to Professor Thomson, but he said he thought the difference between the intensity of the rays which come out obliquely and those which come out in a normal direction was much too great to be accounted for in that way.* I will take it as a

* I have found by subsequent inquiry that the experiment referred to was not made by Professor Thomson himself, but by Mr. C. M. McClelland, in the Cavendish Laboratory, and that on being recently repeated with the same tube the effect of the X rays was found to be by no means so much concentrated towards the normal to the wall of the tube as in the former experiment. It seems likely that the difference may have been due to use of the tube in the interval, which would

fact, without entering at present into any speculation as to the reason for it, that the Röntgen rays do come out from the glass wall more copiously in a normal direction than in an oblique direction. Assuming this, we can rightly say that the results obtained by Prince Galitzin and M. v. Karnojitzky, and similar results obtained by others, do not by any means prove that the seat of the rays is within the tube. Suppose, for example, that the tube were spherical, and a portion of this spherical surface were reached by the cathodic rays; if the Röntgen rays which passed outside came wholly, we will say, in a normal direction, produce the directions backwards and you will get the centre of the tube. But we have no right to say from that there is anything particular going on in the centre of the spherical tube. The result is perfectly compatible with Röntgen's original assertion, which I believe to be true, as to the seat of the rays.

Everything tends to show that these Röntgen rays are something which, like rays of light, are propagated in the ether. What, then, is the nature of this process going on in the ether? Some of the properties of the Röntgen rays are very surprising, and very unlike what we are in the habit of considering with regard to rays of light. One of the most striking things is the facility with which they go through bodies which are utterly have made the exhaustion higher, and caused the X rays given out to be of higher penetrative power, so as to render the increased thickness of glass which the rays emerging obliquely had to pass through to be of less consequence. But the subject is still under examination. In consequence of the result obtained in the second experiment, the statement in the text should be less absolute; but it may very well have happened that in the experiments of others the conditions may more nearly have agreed with those of the first experiment, causing what we may call the resultant activity of the X rays to have had a direction leaning towards the normal drawn from the point casting the shadow to the wall of the tube.

opaque to light, such, for example, as black paper, board, and so forth. If that stood alone it would, perhaps, not constitute a very important difference between them and light. A red glass will stop green rays and let red rays through; and just in the same way if the Röntgen rays were of the nature of the ordinary rays of light, it is possible that a substance, although opaque to light, might be transparent to them. So, as I say, that remarkable property, if it stood alone, would not necessarily constitute any great difference of nature between them and ordinary light. But there are other properties which are far more difficult to reconcile with the idea that the Röntgen rays are of the nature of light. There is the absence, or almost complete absence, of refraction and reflection. Another remarkable property of these rays is the extreme sharpness of the shadows which they cast when the source of the rays is made sufficiently narrow. The shadows are far sharper than those produced under similar circumstances by light, because in the case of light the shadows are enlarged as the effect of diffraction. This absence, or almost complete absence, of diffraction is then another circumstance distinguishing these rays from ordinary rays of light. In face of these remarkable differences, those who speculated with regard to the nature of the rays were naturally disposed to look in a direction in which there was some distinct difference from the process which we conceive to go on in the propagation and production of ordinary rays of light. Those who have speculated on the dynamical theory of double refraction have been led to imagine the possible existence in the ether of longitudinal vibrations, as well as those transversal vibrations which we know to constitute light. If we were to suppose that the Röntgen rays are due to longitudinal vibrations, that would constitute such a

very great difference of nature between them and rays of light that a very great difference in properties might reasonably be expected. But assuming that the Röntgen rays are a process which goes on in the ether, are the vibrations belonging to them normal or transversal? If we could obtain evidence of the polarisation of those rays, that would prove that the vibrations were not normal but transversal. But if we fail to obtain evidence of polarisation, that does not at once prove that the vibrations may not after all be transversal, because the properties of these rays are such as to lead us *à priori* to expect great difficulties in the way of putting in evidence their polarisation, if, indeed, they are capable of polarisation at all. Several experimentalists have attempted, by means of tourmalines, to obtain evidence of polarisation, but the result in general has been negative. Of the two photographic markings that ought to be of unequal intensity on the supposition of polarisation, one could not say with certainty that one was darker than the other. Another way of obtaining polarised light is by reflection at the proper angle from glass or other substance; but, unfortunately for the success of such a method, the Röntgen rays refuse to be regularly reflected, except to a very small extent indeed. The authors of the paper to which I have already referred appear to have had some success with the tourmaline. Like others who have worked at the same experiment, they took a tourmaline cut parallel to the axis and put on top of it two others, also cut parallel to the axis, and of equal thickness, which were placed with their axes parallel and perpendicular respectively to that of the under tourmaline. But they supplemented this method by a device which is not explained in the paper itself, although a memoir is referred to in which the explanation is to be found—at least by those who

can read the Russian language, which, unfortunately, I cannot. I can, therefore, only guess what the method was. It is something depending on the superposition of sensitive photographic films. I suspect they had several photographic films superposed, took the photographs on these, and then took them asunder for development, and after development put them together again as they had been originally. They consider that they have succeeded in obtaining evidence of a certain amount of polarisation. If we assume that evidence to be undoubted, it decides the question at once. But as the experiment, as made in this way, is rather a delicate one, it is important for the evidence that we should consider as well what we may call the Becquerel rays. If time permits, I shall have something to say about these towards the close of my lecture, but, for the present, I shall say merely that they appear to be intermediate in their properties between the Röntgen rays and rays of ordinary light. The Becquerel rays undoubtedly admit of polarisation, and the evidence appears on the whole pretty conclusive that the Röntgen rays, like rays of ordinary light, are due to transversal, and not to longitudinal, vibrations. It remains to be explained, if we can explain it, wherein lies the difference between the nature of the Röntgen rays and rays of ordinary light which accounts for the strange and remarkable difference in the properties of the two. I may mention that, although Cauchy and Neumann, and some others who have written on the dynamical theory of double refraction, have been led to the contemplation of normal vibrations, Green has put forward what seems to me a very strong argument against the existence of normal vibrations in the case of light. The argument Green used always weighed strongly with me against the supposition that the Röntgen rays were due to

longitudinal vibrations; and the experiments by which, as I conceive, the possibility of their polarisation has now been established, go completely in the same direction, showing that they are due, assuming them to be some process going on in the ether, to a transversal disturbance of some kind.

Now, the so-called cathodic rays are, as we may say, the parents of the Röntgen rays. Consequently, if we are to explain the nature of the Röntgen rays, it is very important that we should have as clear ideas as may be permissible of the nature of the cathodic rays. Now, two views have been entertained as to the nature of the cathodic rays. According to one view, they are not rays of light at all, but streams of molecules which are projected from the cathode, and, if the exhaustion within the tube be sufficient, reach the opposite wall. That was the idea under which Crookes worked in his well-known experiments, and, so far as I know, it is the view held by all physicists in this country. Another opinion, however, has been published, and there are some eminent physicists who favour it, especially, I think, in Germany. According to this latter opinion, the cathodic rays are, like rays of light, some process going on in the ether. The cathodic ray, coming from the cathode towards the opposite wall of the tube, is invisible as such if you look across it. There is in reality a faint blue light ordinarily, but not necessarily, seen when you look across it. Lenard, in his most elaborate and remarkable experiments, succeeded in producing the cathodic rays within a space from which the gas was so very nearly completely taken away that, although the cathodic rays passed freely through the space, there was no appearance of the blue light when you viewed their path transversely. They produced, however, the ordinary effect of phosphorescence at the other end of

the tube. The appearance, then, may be analogous to that of a sunbeam coming from a hole in the clouds. If it were not for the slight amount of dust and suspended matter in the air, the sunbeam would be invisible if you looked across it. But as the air is never free from motes, you see the path of the sunbeam when you look across it by the light reflected from these motes. Something of the same kind may be conceived to take place with regard to the cathodic rays if they are some process going on in the ether. But there are very great difficulties in the way of this second hypothesis; and especially as regards certain properties of the cathodic rays. In the first place, they act mechanically. In Crookes' experiments he succeeded in causing a light windmill, if I may so describe it, to spin rapidly under the action of the rays. And when they were received on a very thin film of blown glass, the glass was actually bent under them as they fell upon it. But that is not all. These cathodic rays appear to proceed in a normal direction from the cathode, and ordinarily proceed in straight lines. But—and this is the important point—they are capable of being deflected in their path both by electro-static force and by magnetic or electro-dynamic force. Nothing whatever of the kind occurs with rays of light, and there are enormous, almost insuperable, difficulties in the supposition of any such deflection occurring if the cathodic rays are a process going on in the ether. I will not go into all the arguments for and against the two views, especially as the cathodic rays only enter incidentally into the subject I have chosen to bring before you. I will confine myself to one or two of the chief difficulties in the way of the supposition that the cathodic rays are streams of molecules. In his admirable experiments Lenard produced the cathodic rays in a tube which was highly exhausted,

but not exhausted to the very highest degree that art can obtain. When you get to such tremendous exhaustions as that, you cannot get the discharge to pass through the tube. What did he do? Previous experiments had shown that certain metals—aluminium especially—are, or appear to be, to a certain extent transparent to these rays. Working on the supposition that an aluminium plate is, to a certain extent, transparent to these rays, Lenard constructed a tube, highly exhausted, but not to the very last degree. Then a window of aluminium foil—a very small aperture for mechanical reasons—was fastened in an air-tight manner at the end of the tube, to lead into a second tube provided with a phosphorescent screen. The cathodic rays produced in the first tube fell upon the aluminium plate and, as Lenard supposed, passed through it as rays of light would pass through glass. And so he got them into the second tube, and it not being necessary to make an electric discharge pass through the second tube, he could exhaust it to the very highest power of skill that he had. It was a work of days and days. The cathodic rays behaved in this very highly exhausted tube like ordinary cathodic rays. We are asked to assume that we are dealing here with a vacuum, and according to Lenard that shows—and no doubt it would if we grant the assumption—that it is no longer a question of matter, but of some process going on in the ether.* And, apparently on the strength of that very elaborate experiment, Röntgen in his first paper seems to have been of the opinion that the cathodic rays were something going on in the ether. But are we justified in assuming that we are here dealing with a perfect

* Even if the vacuum were perfect, and the result were still the same, that would not disprove the theory that the cathodic rays are streams of molecules, for the molecules might have been obtained from the aluminium window itself.

vacuum? I do not think we are. I believe it passes the power of art to produce a perfect vacuum. You always have a little residue of which you cannot absolutely get rid, and some of Lenard's own figures show the effect of the residual gas. He isolated by screens a small part of the cathodic discharge in the second tube, and received it on a phosphorescent screen. He represents the phosphorescent light in the tube as consisting of a bright nucleus surrounded by a less bright halo. The bright nucleus was such as would be produced if the cathodic rays were rays of light, provided that that light were incapable of diffraction. But, then, how do you account for the halo? The blue light by which the cathodic rays are seen under ordinary circumstances is due, I believe, to an interference of the projected molecules with the molecules of the gas. In some of Lenard's experiments he received the cathodic rays in the first tube into the air, and a considerable amount of this blue light was seen. The appearance was much as if you had admitted a beam of light into a mixture of milk and water. To my mind this fainter halo in the most refined of Lenard's experiments, lying outside this well-defined nucleus, was evidence that the vacuum, in spite of all the skill and time expended upon it, was not perfect. And for aught we know to the contrary—I believe, indeed, it is the case—the cathodic rays in the second highly-exhausted tube were really streams of molecules coming from the residual gas in the tube. But now comes a difficulty with regard to the passage of the cathodic rays through an aluminium plate. If the cathodic rays were something going on in the ether we might very well understand that an aluminium plate might be transparent to them although opaque to ordinary rays of light. But if the cathodic rays are really streams of molecules, how can we imagine that they get

through the plate? Do they get through the plate? I do not believe they do. Do they riddle the plate like a bullet going through a thin piece of board? I do not think it. Suppose you have a trough containing a solution of sulphate of copper, and at the ends of it you have two copper plates; if you send an electric current through the trough, copper is eaten away at the anode and deposited at the cathode. Now, suppose you divide this trough into two by a plate of copper, you still have copper eaten away at the original anode and copper deposited at the original cathode. The interposed plate really divides the cell into two, in each of which electrolysis goes on, so that you have not only copper eaten away at one end of the trough and deposited at the other, but in your interposed plate you have copper eaten away at one side and deposited at the other. So it may be that the second surface of the aluminium foil becomes, as it were, a new cathode, and starts cathodic rays. This, perhaps, is not what we should have anticipated beforehand. Still, there is nothing unnatural in it, and nothing, it seems to me, in consequence of which you would be obliged to reject the theory which makes the cathodic rays to be streams of molecules. There are one or two other difficulties mentioned by Wiedemann, but I do not think they are at all serious; they are certainly not so serious as the one I have just referred to. I will therefore pass on. The possibility of deflecting the cathodic rays by electrostatic and magnetic forces seems to be an insuperable difficulty in the way of the theory which makes them to be a process going on in the ether; but both of these are perfectly in accordance with what was to be expected on the supposition that they are streams of molecules, provided you remember that these molecules are highly charged with electricity. A moving charged body behaves

as regards deflection like an electric current. Again, if you have highly-charged molecules in the neighbourhood of a positively or negatively statically-charged body, they will be attracted or repelled, and the deflections of the rays are precisely what was to be expected according to that theory. I think we may assume that the cathodic rays are really streams of electrified molecules which strike against the opposite wall of the tube, or, as I will now call it, the target. Now, when a molecule, coming in this way from the cathode, strikes the target, how does the molecule act? It may act in two ways. It may act as a mass of matter, infinitesimal though it be, by virtue of its momentum—by virtue of its mass and velocity—and it may act also as a charged body, a statically-charged body. What the appropriate physical idea is of a statically-charged body is more than I can tell you. I was talking not long ago to Lord Kelvin about it—and he is a far higher authority in electrical matters than I am—and he considers that the physical idea of a statically-charged body is still a mystery to us. Well, if these charged molecules strike the target we may think it exceedingly probable that by virtue of their charge they produce some sort of disturbance in the ether. This disturbance in the ether would spread in all directions from the place of disturbance, so that each projected molecule would on that supposition become, on reaching the target, a source of ethereal disturbance spreading in all directions. Well, what is the character of such a disturbance? The problem of diffraction, dynamically considered, may be supposed to reduce itself to this. Suppose you have an infinite mass of an elastic medium, and suppose a small portion is disturbed in the most general way possible, what will take place? A wave of disturbance

will spread out spherically from the place of disturbance.* You might at first sight suppose that you could have a wave, in any limited region of which you might have a transversal disturbance in some one direction, the same all through the thickness of the shell occupied by the wave, though naturally the direction of disturbance might vary from one region to another more or less distant region. But the dynamical theory shows that that is not possible. In any limited region, or elementary area, as we may regard it, of the wave, as you pass in a direction perpendicular to the front, the disturbance in one direction must be exchanged for a disturbance in the opposite direction, in such a manner that ultimately—that is, when the radius of the wave is very large compared with its thickness—the integral of the disturbance in one direction, which we may designate as positive, must be balanced by the integral of the disturbance in the opposite, or negative, direction. The simplest sort of “pulse,” as I will call it, in order to distinguish it from a periodic undulation, would be one consisting of two halves in which the disturbances were in opposite directions. The positive and negative parts are not necessarily alike, as one may make up by a greater width, measured in the direction of propagation, for a smaller amplitude; but it will be simplest to think of them as alike, except as to sign. The following figure represents this conception, the positive and negative halves being distinguished by a difference of shading.



* If the medium be compressible there will be two waves, that which travels the more swiftly consisting of normal vibrations; but the opinion has already been expressed that it is transversal vibrations with which we are concerned.

According to the view here put forward, the Röntgen emanation consists of a vast succession of independent pulses, starting respectively from the points and at the times at which the individual charged molecules projected from the cathode impinge on the target. At first sight it might appear as if mere pulses would be inadequate to account for the effects produced, seeing that in the case of light we have to deal with series consisting each of a very great number of consecutive undulations. But we must bear in mind how vast, according to our theoretical views, must be the number of molecules contained in the smallest quantity of ponderable matter of which we can take cognisance by our senses. Hence, small as is the quantity of matter projected in a given short time from the cathode, it may yet be sufficient to give rise to pulses the number of which is inconceivably great. It remains to consider in what way this conception may enable us to explain the most striking properties of the Röntgen rays in relation to the contrasts which they offer to rays of light.

The most elementary difference, as being one which has relation only to propagation in the ether, consists in the absence, or, at any rate, almost complete absence, of diffraction. As the different pulses are by hypothesis quite independent of one another, we have to explain this phenomenon for a single pulse.

In the figure let CB be a portion of a spherical pulse spreading outwards from the centre of disturbance

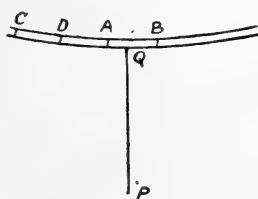

(which I will call O) from which it came, P a point in front of the wave, where the disturbance which will arrive there is sought. From P let fall a normal PQ on the front of the wave, and let AB , taken around Q , be a small portion of the spherical shell which at the present moment is the seat of the pulse, and suppose the breadth of AB to be small compared with PQ and with the radius of the shell, but large compared with the shell's thickness. Let CD be an element of the shell of similar size to AB , but situated in a direction from P distinctly inclined to PQ ; and supposing all the disturbance in the shell stopped except what occupies one or other of the elements AB , CD , let us inquire what will be the disturbance subsequently produced at P in the two cases respectively.

I have shown elsewhere* that in our present problem the disturbance at P is expressed by a double integral taken over such portion of the surface of a sphere with P for centre and bt for radius (b being the velocity of propagation) as lies within the disturbed region, which in this case is the spherical shell or a part of it. It will be convenient to think of a series of spheres drawn round P with radii bt for increasing values of t . When t is such that the sphere just touches the shell at Q , and then goes on increasing, the disturbance is nearly the same all over that portion of the surface of the sphere which lies within the small region AB , and that, whether we take the portion of the expression for the disturbance at P which depends on the disturbance (displacement or velocity) at the surface of the sphere whose radius is bt , or the portion which depends on the differential coefficient of the displace-

* "On the Dynamical Theory of Diffraction." *Cambridge Philosophical Transactions*, Vol. IX., p. 1, or *Collected Papers*, Vol. II., p. 243, Arts. 19-22.

ment or velocity with respect to a radius vector drawn from O. Consequently the positive and negative parts of the disturbance will reach P in succession. But if instead of the small portion AB of the shell we take CD, lying in a direction from P not very near the normal, it is easy to see that the positive and negative parts of the disturbance expressed by our double integral, reaching as they do P simultaneously, almost completely cancel each other. And this cancelling is so much more nearly complete as the obliquity is greater, and likewise as the thickness of the shell is smaller. If, then, the disturbance in the ether consequent on the arrival of any projected molecule at the target is very prompt, lasting it may be only a very small fraction of the period of a single vibration of the ether in the case of light, our shell will be so thin that a small isolated portion of the Röntgen discharge is propagated so nearly wholly in the direction of a normal to the wave that the almost complete absence of diffraction is thus accounted for.*

The explanation which has just been given of the apparent absence of diffraction in the case of the Röntgen rays is closely analogous to the ordinary explanation of the existence of rays and shadows. It differs, however, in this respect, that here we are dealing

* It is known that there is a difference of quality in Röntgen rays, and that the Röntgen discharge may be filtered by absorption. It is known also that the increased exhaustion in a Crookes' tube, which is accompanied by increasing difficulty in sending a discharge through it, has the effect of giving rise to increasing penetrative power in the Röntgen rays which it gives out. It seems to me probable that this difference of quality corresponds to a more or less close approach to perfect abruptness in the production of disturbance in the ether when a molecule propelled from the cathode reaches the target, and accordingly to a less or a greater thickness in the outward-travelling shell of disturbance in the ether; and that at relatively high exhaustions the molecules are propelled with a higher velocity, and so give rise to a more prompt disturbance when they reach the target.

with a single pulse, whereas in the case of light we are dealing with an indefinite succession of disturbances. In order to understand the sharpness of the shadows produced by the Röntgen rays, we are not obliged to suppose that the disturbance is periodic at all. It must be partly negative and partly positive, and that being the case, if the thickness of the shell is very small, the amount of diffraction will be very small, too. Those who have attempted to obtain evidence of the diffraction of the Röntgen rays have been led to the conclusion that if the rays are periodic at all the period is something enormously small—perhaps thirty times, perhaps a hundred times, as small as the wave-length of green light. It seems difficult to imagine by what process you could get such very small vibrations, if vibrations there be. It is easier to understand how the arrival of charged molecules at the cathode might produce disturbances which are almost abrupt.

Well, then, this is what I conceive to constitute the Röntgen rays. You have a rain of molecules coming from the electrically-charged cathode, which you may think of as the rain-drops in a shower. They strike successively on the target, each molecule on striking the target producing a pulse, as I have called it, in the ether, which is essentially partly positive and partly negative; and you have a vast succession of these pulses coming from the various points of the target which are not protected by some screen interposed for the purpose of experiment.

This explains the absence, or almost complete absence, of diffraction. But that is not all we have to explain; we have still a very serious thing behind. What is it that constitutes the difference between the Röntgen rays and rays of ordinary light in consequence of which the one are not refracted, or only in an infinitesimal degree, while

the other are freely refracted? This difficulty led me to conceive of a theory, which I believe to be new, as to the nature of refraction itself—as to the nature of what takes place, for example, when light is refracted through a prism. Suppose we have light of a definite refrangibility, and a prism on which it may be made to fall. When the light is admitted we commonly imagine—at least, I believe so—that the light is immediately refracted, and with proper appliances you get the spectrum. Immediately? I do not think so. How is it that light travels more slowly through refracting medium than through vacuum? There are different conjectures which have been advanced. One is that the ether within refracting media is more dense than the ether in free space. Another is that while the density is the same the elasticity is less. Then, there have been speculations as to the ether being loaded with particles of matter.

Take a piano. If you strike a note a string is set in vibration. You would hardly hear any sound at all if it were rigidly supported. But it rests on a bridge communicating with a sounding-board, and the sounding-board presents a broad surface to the air, and is set in motion by the string. The sounding-board and the string form a compound vibrating system. In the same way it may be that the molecules of the glass, or other refracting medium, and the ether form between them a compound vibrating system, and, *when the motion is fully established*, the two vibrate harmoniously together. But how does it get to be established? We can hardly imagine otherwise than that the ether is excessively rare compared with ponderable matter.* Well, supposing

* The views as to the nature of refraction, which I have endeavoured to explain, lead me incidentally to make a remark on another subject not, indeed, very closely connected with it. From the first, Röntgen recognised as the seat of the X rays which he had discovered the place

the ethereal vibrations start and reach a set of molecules, they are somewhat impeded by the molecules, and they tend also to move the molecules. But as the molecules are relatively very heavy, it may be that it takes some considerable time for the molecules to be set sensibly in motion. Now, if the system of molecules is exceedingly complex, a mode of motion of the molecules, or it may be of the constituent parts of the molecules, may be found such that the system tends to vibrate in practically any periodic time that you may choose; only as you choose one time or another the mode of vibration will be different; and, again, according to the direction in which the molecules are successively made to vibrate the actual mode of vibration will be different. Well, I conceive that the difference between the propagation of the Röntgen rays and rays of ordinary light with

where the cathodic rays fall on the wall of the Crookes' tube. This place is indicated to the eye by the fluorescence of the glass. But we are not on that account to regard the fluorescence as the cause of the Röntgen rays, or even to regard the Röntgen emission as a sort of fluorescence. I have seen it remarked, as indicating no very close connection between the two, that with a metallic target we have a copious emission of Röntgen rays though there is no fluorescence, and that when a spot on the glass wall of a Crookes' tube has for some time been exposed to a rather concentrated cathodic discharge, though the fluorescence which it exhibits under the action of the cathodic discharge becomes comparatively dull, as if the glass were in some way fatigued for fluorescence, it emits the Röntgen rays as well as before.

Fluorescence is undoubtedly indicative of a molecular disturbance; but in what precise way this disturbance is brought about by the cathodic discharge, is a matter on which I refrain from speculating. But whatever be the precise nature of the process, it seems pretty evident that it can only be by repeated impacts of molecules from the cathode that a sufficient molecular disturbance can be got up to show itself as a visible fluorescence.

Suppose a shower of molecules from the cathode to be allowed suddenly to fall on the anti-cathode, and after raining on it for a little to be as suddenly cut off. According to the views I entertain as to the nature of the Röntgen rays, the moment the shower is let on the

reference to passing through a prism depends upon that. When you let a ray of light fall upon a refracting medium such as glass, motions begin to take place in the molecules forming the medium. The motion is at first more or less irregular; but the vibrations ultimately settle down into a system of such a kind that the regular joint vibrations of the molecules and of the ether are such as correspond to a given periodic time, namely, that of the light before incidence on the medium. That particular kind of vibration among the molecules is kept up, while the others die away, so that after a prolonged time—the time occupied by, we will say, ten thousand vibrations, which is only about the forty thousand millionth part of a second—the motion of the molecules of the glass has gradually got up until you have the molecules of the glass and the ether vibrating har-

emission of Röntgen rays begins, it lasts as long as the shower, and ceases the moment the shower is cut off. But the fluorescence only gradually, quickly though it may be, comes on when the shower is allowed to fall, and gradually fades away when the shower is cut off. So far from the fluorescence being in any way the cause of the Röntgen emission, there seems reason to think that if it exercises any effect upon it at all, it is rather adverse than favourable. For it has been found that when the target is metallic, and gets heated, the Röntgen discharge falls off; and fluorescence, like a rise of temperature, involves a molecular disturbance, though the kind of disturbance is different in the two cases.

As the fluorescence of the glass wall and the emission of X rays are two totally different effects of the same cause, namely, the molecular bombardment from the cathode, the intensity of the one must by no means be taken as a measure of the intensity of the other, even with the same tube. The former effect would appear to be the more easily produced. This consideration removes a difficulty mentioned at p. 10 of the paper by Prince Galitzin and M. v. Karnojitzky, as attending the supposition that the X rays originate in the points in which the cathodic rays fall on the wall of the tube or other target. Nor need it surprise us that in some cases the shadows seem to indicate more than one source of action, when we remember that from a given point more than one normal can be drawn to a given closed surface.

moniously together. But in the case of the Röntgen rays, if the nature of them be what I have explained, you have a constant succession of pulses independent of one another. Consequently there is no chance to get up harmony between the vibrations of the ether and the vibrations of the body.

Go back to the case of light passing through glass. When the regular combined vibration is established you have a kinetic energy, due partly to the motion of the ether and partly to the motion of the molecules. If you make abstraction of the loss of energy by reflection, the rate at which the energy passes within the glass must be the same as it has outside, and consequently there must be the same energy for one wave length, which corresponds to one period of the vibration, inside as outside. But if the kinetic energy of the ether is the same for the same volume inside and outside, and you have in addition inside a certain amount of kinetic energy due to the motion of the molecules, the two taken together can only make the energy for a wave inside the same as for a wave outside on the condition that the velocity of propagation inside is less than the velocity of propagation outside. That is the theory I have been forced to adopt as to the nature of refraction in consequence of the ideas I hold as to the nature of the Röntgen rays; and if you adopt that theory I think everything falls into its place. When you have the Röntgen rays falling on a body, the motion of the ether due to them is interfered with by the molecules of the body, more or less. No body is perfectly transparent to these rays, and on the other hand perhaps we may say no body is perfectly opaque. That all falls into its place on this supposition as to the nature of the action of the ether on the molecules. Now, why is it that the Röntgen rays do not care whether you present them

with black paper or white paper? What is the cause of blackness? The light falling upon the paper produces motion in the ultimate molecules. In the case of a transparent substance you have a compound vibrating system going on, vibrating without change. But in the case of an absorbing medium the vibrations which after a time are produced in the molecules spread out into adjoining molecules, by virtue of the communication of the molecules with one another, and are carried away; so that in the case of an absorbing medium there is a constant beginning to set the molecules in vibration; but they never get to the permanent state, because the vibration is carried away by communication from one molecule to another. But in the case of the Röntgen rays you have done with the pulse altogether long before any harmonious vibration between the ether and the molecules can be established; so that a state of things is not brought about in which you get a, comparatively speaking, large vibration of the molecules. Consequently, the Röntgen rays do not care whether you give them black paper or not.

I must not keep you more than a minute or two longer; but I do not like to close this lecture without saying a word or two regarding the Becquerel rays. What takes place there? To be brief, I must refer to the most striking case of all. Take the case of metallic uranium. That gives out something which, like the Röntgen rays, has an influence passing through black paper, and capable of affecting a photographic plate. It is also capable of effecting the discharge of statically-charged electrified bodies. Apparently this goes on indefinitely. You do not need, apparently, to expose the metal to rays of high refrangibility in order that this strange thing should go on. What takes place? My conjecture is that the molecule of uranium has a struc-

ture which may be roughly compared to a flexible chain with a small weight at the end of it. Suppose you have vibrations communicated to such a chain at the top; they travel gradually to the bottom, and near the bottom produce a disturbance which deviates more from a simple harmonic undulation. So, if a vibration is communicated to what I will call the tail of the molecule of uranium, it may give rise to a disturbance in the ether which is not of a regular periodic character. I conceive, then, that you have vibrations produced in the ether, not of such a permanently regular character as would constitute them vibrations of light, and yet not of so simple a character as in the Röntgen rays—something between. And accordingly there is enough irregularity to allow the ethereal disturbance to pass through black paper, and enough regularity on the other hand to make possible a certain amount of refraction. You can also obtain evidence of the polarisation, and, consequently, of the transverse character of these rays.

According to the theory of the nature of the Röntgen rays which I have endeavoured very briefly to bring before you, we have here, as I think, a system the various parts of which fit into one another. You start with the Röntgen rays, which consist, as I conceive, of an enormous succession of independent pulses; you pass to the Becquerel rays, which are still irregular, but are beginning to have a certain amount of regularity; and you end with the rays which constitute ordinary light. According to this theory, the absence of diffraction in the Röntgen rays is explained, not by supposing they are rays of light of excessively short wave length, but by supposing they are due to an irregular repetition of isolated and independent disturbances. So far as I know, the view I have been led to form as to the nature of refraction, and which forms an integral portion of the

theory as to the Röntgen rays, is altogether new; so much so that I felt at first rather startled by it; but I found myself fairly driven to it by the ideas I entertain as to the nature of the Röntgen rays, and I am not aware of any serious objection to it.

ADDITIONAL NOTE.

The problem of diffraction in the case of a vast system of *independent* very slender pulses deserves to be treated in somewhat greater detail. It is rather simpler than the problem of diffraction in the case of series of undulations such as those which constitute light, because the pulses are to be treated separately and independently, like streams of light from different sources; and as the whole thickness of a pulse in the case of the Röntgen rays may probably be something comparable with the millionth of an inch, we have no need to inquire what will be the disturbance continually passing across a fixed surface in space; we may treat the shell at any moment as constituting an initial disturbance in the ether, and then examine the efficiency of different parts of the shell in disturbing at a future time the ether at a given point of space in front of the shell.

The thickness of the shell is not necessarily the same at points situated in widely different directions as regards their bearing from the centre, and the same applies to the direction of disturbance. But in any case for a small portion of the shell the thickness may be deemed uniform, and the direction of disturbance sensibly the same as we pass from point to point in a direction tangential to the shell, while it varies with great rapidity,

at least as regards its amount, when we pass from point to point in a normal direction, vanishing at the outer and inner boundaries of the shell.

As the disturbance we are concerned with is of the distortional kind only, the disturbance at time t at a point P in front of the shell may be obtained from that at time 0 in the shell in its position which is taken as initial by the last equation in Art. 22 of my paper on diffraction already cited. Let R be a point in the shell

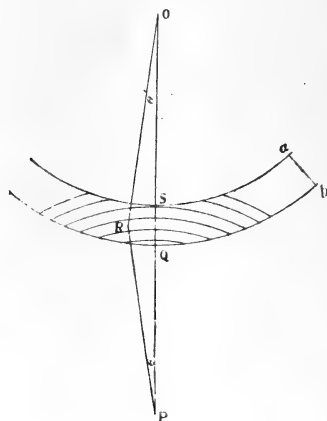

of disturbance when in that position which is regarded as initial, r , r' the distances PR , OR ; θ , θ' their inclinations to OP ; ϕ the azimuth round OP of the plane PRO . Then in the formula referred to $d\sigma = \sin \theta d\theta d\phi$. Also $rd\theta \times \sin (\theta + \theta') = dr'$; and $\sin \theta / \sin (\theta + \theta') = r' / OP = r' / (r + r')$ very nearly.

Let OP cut the inner boundary of the shell in S , and let ab or QS , the thickness of the shell, be denoted by λ . In the equation referred to, the term arising from the differentiation with respect to t of the t outside the sign of double integration will be of the order λ / r' as compared with the others, and may, therefore, be neglected.

The t outside may be replaced by r/b , and the fraction $r/(r+r')$, being sensibly constant over the range of integration, may be put outside. Our expression then becomes

$$4\pi b \xi = \frac{r'}{r+r'} \int \int \left(u_0 - b \frac{d\xi_0}{dr'} \right)_{bt} dr' d\phi. *$$

As the disturbance deemed initial was only a momentary condition of a wave that had been travelling outwards with the velocity b , we must have $u_0 = -b \frac{d\xi_0}{dr'}$, and therefore

$$2\pi \xi = -\frac{r'}{r+r'} \int \int \left(\frac{d\xi_0}{dr'} \right)_{bt} dr' d\phi.$$

The expression is left in the first instance in this shape in order to show more clearly the manner in which each portion of the disturbance in the state taken as initial contributes towards the future disturbance at P . When there is no obstacle to the transmission we shall have $\int d\phi = 2\pi$, and $\int \left(\frac{d\xi_0}{dr'} \right)_{bt} dr' = (\xi_0)_{bt}$ taken between limits. If $bt < PQ$, the sphere round P with radius bt does not cut the disturbed region at all, and the disturbance at P is nil. If $bt > PS$, the limits of r' are the distances from O at which the sphere round P cuts the inner and outer limits of the shell, and as the disturbance there vanishes, we have again no disturbance at P . But if bt lies between those limits, and the sphere round P cuts OP in T (which point must lie between Q and S) the limits of r' will be OT to a point in the outer boundary of the shell, where therefore ξ_0 vanishes. Hence the displacement at P is the same as was initially at T , only diminished in the ratio of $r+r'$ to r' , as we know it ought to be.

*The suffix bt means that the integration is taken over a spherical surface with centre P and radius bt .

Reverting to the expression for ξ given by the double integral, we see that the only portion of the shell which is efficient in producing a subsequent disturbance at P lies between the sphere round O with radius OQ and the sphere round P with radius PS . If β be the distance from OP of the intersection of these spheres, we have, considering the smallness of the obliquities,

$$\beta^2 = \frac{2rr'\lambda}{r+r'}.$$

If we suppose r and r' to be each 4 inches, and λ the millionth of an inch, we have $\beta = 0.002$ inch, so that at a distance not less than the one-250th of an inch from the projection of the edge of an opaque body intercepting Röntgen rays coming from a point 4 inches off, and received on a screen (fluorescent or photographic) 4 inches on the other side, there would be full effect or no effect according as we take the illuminated or the dark side of the projection. We see then how possible it may be to have an almost complete absence of diffraction of the Röntgen rays if the pulses are as thin as above supposed; and as these rays are started in the first instance in a totally different manner from rays of ordinary light, namely, by the arrival of charged molecules from a cathode at a target instead of by the vibrations of the molecules of ponderable matter, we know of no reason beforehand forbidding us to attribute an excessive thinness to the pulses which the charged molecules excite in the ether.

PROCEEDINGS
OF
THE MANCHESTER LITERARY AND
PHILOSOPHICAL SOCIETY.

Extraordinary General Meeting, July 7th, 1896.

EDWARD SCHUNCK, Ph.D., F.R.S., President, in the Chair.

The circular summoning the meeting having been read, Mr. JOHN JACKSON ASHWORTH, Hillside, Wilmslow Park, and 39, Spring Gardens, was unanimously elected Treasurer in place of Mr. Rupert Swindells, M.Inst.C.E.

General Meeting, October 6th, 1896.

Professor OSBORNE REYNOLDS, M.A., LL.D., F.R.S.,
Vice-President, in the Chair.

Mr. James Hardie, M.D., F.R.C.S., Wrenwood, Higher Broughton, and Mr. F. H. Bowman, D.Sc., F.R.S.E., Mayfield, Knutsford, were elected ordinary members.

Ordinary Meeting, October 6th, 1896.

PROFESSOR OSBORNE REYNOLDS, M.A., LL.D., F.R.S.,
Vice-President, in the Chair.

The thanks of the members were voted to the donors of the books upon the table.

The announcement was made that, during the recess, the Society had lost by death four ordinary members: Mr. William Brockbank, F.G.S., F.L.S., Mr. Samuel Cottam, F.R.A.S., Mr. Thomas Hick, B.A., B.Sc., A.L.S., and Mr. James Parlane; and one honorary member: Sir Joseph Prestwich, F.R.S., F.G.S.

And that, after consideration of the replies of the members to the circular issued in June for the purpose of learning the wishes of members as to the hours of meeting, the Council had decided that the meetings should be held alternately, at five o'clock in the afternoon and at half-past six in the evening.

Also, that the Council had acted with Councils of other learned Bodies in sending a representative with an Address to the Celebration of the Jubilee of LORD KELVIN'S appointment to fill the Professorship of Natural Philosophy in the University of Glasgow, and that Professor Schuster, Ph.D., F.R.S., had kindly been present on that occasion as their representative. The Address and the reply from Lord Kelvin were read, and it was moved by Professor F. E. Weiss, seconded by Dr. C. H. Lees, and resolved unanimously, that the Address sent to Lord Kelvin on the celebration of his Jubilee, and his reply to it, be entered among the proceedings of the Society.

[ADDRESS.]

To the Right Honourable Lord KELVIN,

LL.D., D.C.L., D.Sc., F.R.S.,

Professor of Natural Philosophy in the University of
Glasgow.

The Council of the Manchester Literary and Philosophical Society beg to offer you their heartiest congratulations on the occasion of the Jubilee of your Professorship. The members of the Society unite with the whole scientific world in the expression of admiration and gratitude for the great services rendered by you to the cause of Science; but they desire especially to refer to the long and friendly relationship which has existed between yourself and this Society. You were one of the first to recognise the merit of the work of our townsman and member Joule, and we look back with pleasure to the visit you paid to this city when you unveiled his statue in our Town Hall.

We have counted you as one of our Honorary Members since 1851, and it was to our Society that you first communicated your Memoir "On the Convective Equilibrium of the Atmosphere," which forms the foundation of the science of Meteorology.

It is our earnest wish that you may long be spared to prosecute the researches which have rendered your name famous throughout the world.

(Signed) EDWARD SCHUNCK, Ph.D., F.R.S.,

President.

June 16, 1896.

[REPLY.]

THE UNIVERSITY, GLASGOW.

For the Address which I have had the honour to receive from the Manchester Literary and Philosophical Society on the occasion of the Jubilee of my Professorship of Natural Philosophy in the University of Glasgow, I desire to express my warmest thanks. I value very highly the great honour which it has conferred on me. The friendly appreciation of my scientific work contained in the Address is most gratifying.

I feel deeply touched by the great kindness to myself, and the good wishes for my welfare, of which it gives expression.

(Signed)

KELVIN.

July 7, 1896.

The SECRETARIES recalled the attention of the members to a circular lately issued asking authors of papers to supply abstracts of their papers before the date of reading them, in order that copies might be quickly communicated to suitable periodicals, and also supplied to members present at the meeting when the papers are read.

Professor F. E. Weiss prefaced the reading of the late Mr. THOMAS HICK'S paper "**On *Rachiopteris cylindrica*, Will.**," by lamenting the loss which the Society, and Botanical Science generally, has sustained from Mr. HICK'S death. The paper read was the record of the last work upon which Mr. Hick was engaged, and it had been forwarded by his family, having been found with the pencilled note *to be read at the Manchester Literary and Philosophical Society* in Mr. Hick's handwriting.

The paper is printed in full in the *Memoirs*.

The circumstances under which the paper came to the Society were felt to be exceptional, and it was moved by Mr. Charles Bailey, F.L.S., and seconded by Mr. J. Cosmo

Melvill, M.A., F.L.S., and resolved unanimously, "That the Secretaries be desired to write to Mrs. Hick and express to her and her family the sympathy and condolence of the Society in their heavy loss."

Mr. J. H. ASHWORTH, B.Sc., Owens College, read a paper entitled, "**The Structure and Contents of the Tubers of *Anthoceros tuberosus*.**"

The paper is printed in full in the *Memoirs*.

Professor Weiss pointed to the biological interest of the tubers as illustrating the adaptation of a liverwort, a plant usually associated with a damp climate, to a dry locality. The presence of oil, together with a nitrogenous food-material in the cells, too, was of more usual occurrence than granules of a starchy nature, such as those described by Ruge.

Mr. JAMES COSMO MELVILL exhibited a number of small Marine Mollusca from the Loyalty Islands, many of which were new to Science.

[*Microscopical and Natural History Section.*]

Ordinary Meeting, October 12th, 1896.

CHARLES BAILEY, F.L.S., President of the Section,
in the Chair.

Mr. COWARD exhibited a few specimens of eggs of the Cuckoo (*Cuculus canorus*) along with the eggs of their foster parents. He remarked on the vexed question of the resemblance of the eggs to those of their foster parents. There were, among his specimens, two distinct types of the eggs of the Tree-Pipit, and also two types of Cuckoo's eggs closely resembling these, but one of the clutches of Tree-Pipit's eggs of the dark brown type contained a Cuckoo's egg of the greenish type, and a clutch of greenish Pipit's eggs contained a dark brown Cuckoo's egg.

That the Cuckoo sometimes makes mistakes was illustrated by an egg taken from a Linnet's nest, together with one egg of the latter bird, where the type of the Cuckoo's egg resembled that of the insectivorous Whitethroat, a bird which was exceedingly common in the locality where the egg was taken.

Mr. J. COSMO MELVILL exhibited all the species of the order *Droseraceæ* contained in his herbarium, consisting of more than half the known species throughout the world, and in which all the six genera, *Drosera*, *Drosophyllum*, *Aldrovanda*, *Dionæa*, *Roridula*, and *Byblis*, which compose the order, were represented. The differences between the genera were pointed out, and the geographical distribution was discussed (Australia being their metropolis). The affinities of the order, which are evidently with *Saxifrageæ*, were pointed out, and one or two of the most noteworthy exotic species remarked upon; e.g., *Drosera Huegelii*, *D. pallida*, and the purple-flowered *D. Menziesii*, from West Australia;

Roridula dentata and *R. goygonias*, with pink flowers, from the Cape; *Byblis liniflora*, with blue flowers, from North Australia; *Dionæa muscipula*, which Mr. Melvill gathered near Wilmington, North Carolina, in 1872; it being only found in two localities in the world, one in North, the other in South Carolina; the curious yellow-flowered *Drosophyllum lusitanicum*, peculiar to the Iberian peninsula; and last, but not least, the aquatic European *Aldrovanda vesiculosa*.

The assemblage of *Drosera* and allies constitute a remarkably interesting group, whether viewed æsthetically, congenerically, or geographically. Three species alone inhabit Europe, all being found on our peat moors, within a walk of Manchester.

Mr. CHARLES BAILEY expressed doubts as to whether the experiments made on these, so-called, carnivorous plants were sufficiently conclusive to establish the alleged fact that such plants absorb nourishment from the captured insects through their leaves, owing to the absence of suitable organs therein; and suggested that a more reasonable explanation of the benefit derived by the plant, from the products of decomposition, was that the nutrient matter was conveyed by rain and dew down the leaf-stalks (which were frequently channeled) and stems to the ground, whence it was absorbed through the appropriate organs in the roots. In this way, too, the insects captured by the glands on the surface of the stems of the catchflies (*Silene*), and on the stems and leaves of other plants not counted carnivorous, ultimately furnished nutriment to the plants through their roots. Similarly the pitchers of *Nepenthes*, with their engulfed insect-remains would, on the decay or rupture of the pitchers, provide the roots of the plant, through the soil, with a highly-charged liquid manure.

General Meeting, October 20th, 1896.

MR. CHARLES BAILEY, F.L.S., Vice-President,
in the Chair.

Mr John Wright, Sandiway, Whalley Road, Whalley Range; Mr. Leonard F. Massey, 4, Egerton Road, Fallowfield; Mr. W. P. Steinthal, M.Sc., Melrose, Didsbury; and Mr. Abraham Emrys Jones, J.P., M.D., M.Ch., 10, St. John Street, Manchester, were elected Ordinary Members.

 Ordinary Meeting, October 20th, 1896.

MR. CHARLES BAILEY, F.L.S., Vice-President,
in the Chair.

The thanks of the members were voted to the donors of the books upon the table.

One of the Secretaries mentioned that it appeared from the Catalogue of the British Museum that the Society had published in 1782 a quarto pamphlet containing the Rules of the Society and a List of Members at that date, and in 1783 had published another quarto pamphlet containing an account of the institution and views of the Society, which was re-published in 1784. None of these pamphlets are in the possession of the Society, and their existence appears to be generally unknown. They are not alluded to in Dr. Angus Smith's Centenary Volume. If any member found that he possessed a copy of either of the pamphlets, he was requested to allow the Secretaries to have a transcript made for re-publication.

Mr. FRANCIS NICHOLSON exhibited, and presented to the Society, a copy of the earlier pamphlet entitled "Rules established for the government of the Literary and Philosophical Society of Manchester, and a List of the Members,

1782," which he had found among papers which had belonged to his relative, Mr. Matthew Nicholson, one of the early members of the Society. Under the same cover was an anonymous paper, dated March 30, 1771, entitled "An attempt to account for the different quantities of rain which fall at different heights over the same spot of ground." A note states that the paper was intended only for the inspection of the author's philosophical friends.

The following papers were read :—

"On the Viscosity and Electrolytic Resistance of a Gelatine Solution." By ALBERT GRIFFITHS, M.Sc., Demonstrator in Physics at the Owens College, Manchester.

(Communicated by Professor Schuster, F.R.S.)

It has been thought by some physicists that a connection exists between the viscosity of a liquid and its electrolytic resistance, and that, other things being the same, the one will prove to vary directly as the other. The chief object of the following experiments is to test whether any such relation is indicated in the case of a gelatine solution containing salt.

E. Fraas, in Wied. Ann. 53, 1894, has shown that the elasticity of a gelatine jelly, as measured by Young's Modulus, increases with time; and that common salt not only diminishes the rate of increase, but also the elasticity ultimately attained. It seemed to me likely that the salt would exercise a retarding influence on the changes at work, even before the solution sets, and experiments, made with a 1 per cent. solution of gelatine in water, have proved that the viscosity of the solution without salt increases at a distinctly more rapid rate than when 5 per cent. of salt is present.

It is known that gelatine is a body of somewhat variable composition, but in many respects its properties are of an inert character, and it seems likely that a small quantity of gelatine dissolved in water will, in general, not have a great influence on the degree of dissociation of a salt also dissolved in it, and hence concurrent experiments on the

electrolytic resistance and the increase of viscosity of such a solution may afford an indication whether there is, or is not, any direct connection between the two physical quantities. One part of gelatine, and 5 of sodium chloride were dissolved in 100 parts, by weight, of water, and the whole was kept at a temperature of about 50°C. for two or three hours. The solution was then cooled rapidly to about 20°C., about one quarter of an hour afterwards its resistance measured by the Kohlrausch apparatus was 8.5 per cent. *less* than a corresponding solution free from gelatine; since the degree of dissociation of the latter is over 70 per cent., it is very probable that the greater part of the salt in the gelatine solution was in a state of dissociation; in an hour and a half its resistance had increased and was only 4 per cent. *less* than that of the salt solution free from gelatine; its resistance then diminished, and in 5½ hours was about 8 per cent. *less* than that of the salt-free solution, after which it remained practically stationary.

Concurrent determinations by Poiseuille's method were made of the viscosity, which was found to increase at a continually augmenting rate. In order to be sure that the liquid was in the same state when used for the determination of resistance as for that of viscosity, all the solution was mixed together every hour and well stirred. Stirring doubtless affects the rate of increase of the viscosity. In 8½ hours the viscosity was 12 times as great as near the beginning, and was increasing at a rapid rate; I was then compelled to leave the work for the night. By morning the solution had set into a jelly, and further experiments were thereby rendered impossible. Doubtless, before setting, the viscosity became very great, but there was no indication of any corresponding change in the electrolytic resistance, for it was practically the same as the night before.

The experiments indicate that, in the case of the particular gelatine solution considered, there is probably no direct connection between the viscosity in mass and the resistance which the ions experience in their motion.

“On a Mixture whose Electric Resistance depends on the Magnetic Field in which it is placed.” By ALBERT GRIFFITHS, M.Sc.

(Communicated by Professor Schuster, F.R.S.)

The idea of examining this mixture originated in an attempt to elucidate certain obscurities in the process of electric conduction, such, for instance, as occur in the case of bismuth, whose resistance increases in the magnetic field. The mixture consists of a gelatine jelly containing ferrous sulphate, iron filings, and powdered graphite; the object aimed at being the production of a conducting solid with magnetic particles scattered throughout its mass.

The jelly was allowed to set in a glass tube, copper terminals being inserted before the solidification of the jelly. The resistance so prepared was placed between the poles of a large electro-magnet, whose field, with the current used, was about 4,000 C.G.S. units. The tube was so arranged that the electric current through it ran at right angles to the lines of magnetic force.

The experimental resistance was connected up with the Wheatstone Bridge in the ordinary way, and measurements were made both during the activity of the magnet and when the magnet was unexcited. The results were fairly concordant, and indicated a fall of the resistance in the magnetic field of about 25 per cent.

Mr. C. H. LEES and Mr. P. J. HARTOG took part in the discussion on the papers.

General Meeting, November 3rd, 1896.

EDWARD SCHUNCK, Ph.D., F.R.S., President, in the Chair.

Mr. J. H. Lynde, M.Inst.C.E., Buckland, Ashton-on-Mersey; Mr. J. Crowther, Assoc. R.S.M., Assistant Lecturer in Metallurgy, Owens College; Mr. William Milligan, M.D., 28, St. John Street; Mr. Edward Hopkinson, D.Sc., M.Inst.C.E., Salford Ironworks; and Mr. John Burke, B.A., Berkeley Fellow, Owens College, Manchester, were elected ordinary members.

Ordinary Meeting, November 3rd, 1896.

EDWARD SCHUNCK, Ph.D., F.R.S., President, in the Chair.

The thanks of the members were voted to the donors of the books upon the table.

In answer to a request for information from Mr. C. L. Barnes regarding the form of top referred to in Garnett's Life of Clerk Maxwell, under the name of "The Devil on Two Sticks," Professor REYNOLDS said he had used the top to illustrate gyrostatic stability, and that practice was necessary to acquire skill in its use.

Professor OSBORNE REYNOLDS, F.R.S., then read a paper entitled, "**On Methods of determining the Dryness of Saturated Steam and the Condition of Steam Gas.**"

The paper is printed in full in the *Memoirs*.

Professor LAMB, Mr. C. H. LEES, and Mr. P. J. HARTOG took part in the discussion.

General Meeting, November 17th, 1896.

EDWARD SCHUNCK, Ph.D., F.R.S., President, in the Chair.

Rev. Alexander Gordon, M.A., Memorial Hall, Albert Square, Rev. Arthur W. Fox, M.A., Albion House, The Downs, Bowdon, Mr. Lonsdale Broderick, F.C.A., Somerby, Wilmslow, Mr. Hermann Emil Schmitz, B.A., B.Sc., Manchester Grammar School, Mr. John Henderson, B.Sc., Municipal Technical School, and Mr. Edwin Jacob, 6, Mauldeth Road West, Withington, were elected ordinary members.

Ordinary Meeting, November 17th, 1896.

EDWARD SCHUNCK, Ph.D., F.R.S., President, in the Chair.

The thanks of the members were voted to the donors of the books on the table.

Dr. PANKHURST expressed his opinion that the Society, by containing among its members persons of various professions, and engaged in different scientific pursuits, was in a favourable position to undertake the investigation of some of the very numerous problems which present different aspects, according as they are regarded from one or from another point of view. He named as an important instance of the kind of problem he meant, the question of the responsibility of the insane, upon which medical men and lawyers hold widely different opinions.

Mr. GWYTHER exhibited two distribution-curves showing the comparative results of examinations which he had held during the last three years, in which the same persons had been examined in both Algebra and Geometry at about the same standard. It was pointed out that information of considerable value would be obtained if distribution-curves

could be got representing results based on a much larger number of candidates, so as to obtain a comparison of the normal distributions in the different subjects of school-leaving examinations.

Mr. PETER CAMERON'S paper entitled "**Hymenoptera Orientalia, or Contributions to a knowledge of the Hymenoptera of the Oriental Zoological Region,**" Part V., was communicated by Mr. J. Cosmo Melvill.

The paper is printed in full in the *Memoirs*.

General Meeting, December 1st, 1896.

EDWARD SCHUNCK, Ph.D., F.R.S., President, in the Chair.

Mr. George Wilson, M.Sc., Demonstrator in the Whitworth Engineering Laboratory, Owens College, was elected an ordinary member.

Ordinary Meeting, December 1st, 1896.

EDWARD SCHUNCK, Ph.D., F.R.S., President, in the Chair.

The thanks of the members were voted to the donors of the books upon the table.

Dr. SCHUNCK said that as he had paid some attention to the chemical properties of carminic acid, the colouring matter of cochineal, it had appeared to him that it might be of interest to ascertain whether the colouring matter is secreted by the insect or whether it is merely absorbed and collected from the juices of the plant on which it feeds. Having, through the kindness of a friend in the Canary Islands, obtained some specimens of *Cactus opuntia*, which were quite fresh-looking, he had stripped off the thick fleshy epidermis and treated the interior surface, as well

as the inside, with water, alkalis, and other re-agents, but could, in no case, see any indication of the presence of a red colouring matter. From this it would appear that the colouring matter is an animal secretion and does not pre-exist in the plant.

Professor WEISS joined in the discussion, and took some of the specimens for microscopic examination.

Dr. C. H. LEES called attention to the experiments of E. Wiedemann on the specific heats of vapours and their variation with the temperature. Since in all the vapours that have been experimented on the specific heats increase with the temperature, it is probable that this is the case for all vapours, including steam. Hence the value of the specific heat of steam between given temperatures, required in Rankine's formula for the total heat necessary to raise water from any temperature to steam gas at another temperature, is still unknown. Professor Reynolds, Professor Dixon, and Mr. R. L. Taylor took part in the discussion.

Mr. HERBERT BOLTON, F.R.S.E., read a paper entitled "**Descriptions of New Species of Brachiopoda and Mollusca from the Millstone Grit and Lower Coal Measures of Lancashire.**"

The paper is printed in full in the *Memoirs*.

Mr. C. L. BARNES, M.A., read a paper entitled "**On some Errors in Science.**"

It was suggested by Roger Bacon that there are four causes of human ignorance, viz., authority, custom, popular opinion, and the pride of supposed knowledge. Long after his time Francis Bacon, in the same spirit, conceived his Idols of the Tribe, of the Cave, the Market-place, and the Theatre. By the first of these are meant the errors which are common to the whole race of mankind, since they arise from the nature of human understanding. Such sayings as "Nature abhors a vacuum," "Nature always works by the simplest means," are really so many cloaks under which the old philosophers used to hide their ignorance. There is a

tendency to invent well-rounded and symmetrical systems, and to ignore or minimise troublesome facts which will not fall in with them. The idols of the Cave are those peculiar to each individual mind, prompting it to accept narrow or distorted views in preference to taking a survey from a wide and open standpoint. The idols of the Market-place are those which arise from a perverted use of language, elevating such words as Fate, Fortune, Nature, &c., into realities, and ascribing functions to them which a little consideration would show they cannot bear. Lastly, the idols of the Theatre are the visionary and sophistical systems of philosophy, founded on a few hasty generalisations of facts, or upon unwarranted speculations or superstition.

Following the lines thus suggested, it is possible to classify scientific errors under four heads, viz., General and Historic, Productive, Obstructive, and Occasional errors. No hard and fast lines can be laid down, but the four classes are sufficient, and in most cases it is not difficult to decide upon the heading under which any particular error should go. In the first class are included Astrology, Alchemy, the ancient cosmogonies, especially the Ptolemaic, and several minor "idola" or phantoms which, to use a simile of Bunyan's, have lured many a good intellect "to the top of the hill called Error, which was very steep on the farthest side"; as, for instance, squaring the circle, and finding a source of energy which would work continually without replenishing, commonly known as the perpetual motion.

Among Productive errors we may reckon the doctrine of Phlogiston and Prout's hypothesis in Chemistry, the imponderable fluids of Magnetism, Electricity, and Heat in Physics, the theory of Epigenesis in Biology, and of Catastrophism in Geology. All these have borne good fruit by stimulating inquiry and controversy, and it is noticeable how in several cases what seemed to be a well-founded doctrine has for a time fallen into disrepute, to be afterwards revived with modifications. Thus Phlogiston or the principle of combustion died a very hard death, and no

wonder, for there was vitality in it. It has risen, phoenix-like, out of its own ashes, to live henceforth under the name Potential Energy. So also the theory of Epigenesis, first propounded by Aristotle and defended by Harvey, that an organism grows by differentiation of a comparatively homogeneous germ into the parts and structures which are found in the adult, was strongly opposed, if not supplanted for a time, by the rival theory that all the organs are not only potentially but actually present in the germ, and grow by accretion. The latter has now disappeared for ever, according to the best authorities, and the pendulum has swung back, as it were, to the old idea again.

By Obstructive errors are meant those which under the shadow of a deservedly great name have retarded progress for a time, such as the physical theories of Aristotle, the Corpuscular Theory of Light, the Proportionality of Refraction and Dispersion, the Wernerian theories of Geology, and so on.

Lastly, Occasional errors are the *obiter dicta* of scientific men, freaks of the imagination, or ill-considered deductions from observation, which are soon exploded, and leave no legacy to posterity except a feeling of amusement whenever they are met with. Among these may be mentioned the once-renowned Urschleim or Bathybius, by which an acute intellect was for a time deceived; the hot ice, unaccompanied, however, by "wonderous strange snow," as Shakespeare puts it, which was sprung upon an astonished world in 1880; and lastly, the misdirected efforts of an astronomer to find, amongst other things, the dimensions of the solar system, certain mathematical constants and relations, and even a foreshadowing of our chaos of weights and measures, in the length and breadth and height of the passages and vaults of the Great Pyramid.

Ordinary Meeting, December 15th, 1896.

Professor DIXON, M.A., F.R.S., in the Chair.

The thanks of the members were voted to the donors of the books upon the table.

Mr. NICHOLSON presented to the Society a copy of the Society's first publication, entitled "Rules, established for the Government of the Literary and Philosophical Society of Manchester; and a List of the Members," 1782; a copy of "Anthropologia," by Dr. Thomas Jarrold, a member of the Society; and a manuscript, written by Matthew Nicholson, of the paper "On the Comparative Excellence of the Sciences and Arts," by William Roscoe, printed in Vol. III. of the Society's Memoirs. The thanks of the members were voted to Mr. Nicholson for these gifts.

The Secretaries announced that Mr. HENRY WILDE, F.R.S., had completed his gift of the electric installation in the Society's house by the donation of an electric lamp for use with the lantern. It was resolved unanimously that the Secretaries convey to Mr. Wilde the hearty thanks of the Society for his useful gift.

Professor S. J. HICKSON, F.R.S., exhibited two eggs taken a few years ago from a blackbird's nest, of which one was very small and without yolk, the other a large egg with two yolks, and inquired whether this was of common occurrence in the case of the first eggs of a young bird. Mr. Nicholson thought that it was quite unusual.

Mr. FARADAY remarked that, having just returned from a visit to the Pont du Gard, amongst other Roman works in the South of France, he was induced to refer to that wonderful structure in relation to the theories as to the erosion of river valleys. The Pont du Gard was built without cement in the time of Agrippa, about 19 B.C., across the valley of the Gard or Gardon, a tributary of the Rhone, as part of an aqueduct, originally $25\frac{1}{2}$ miles long, to convey

water from some springs near Uzès to the town of Nîmes. The bridge itself is said to be 880 feet long, and 160 feet high from the bed of the river, and it consists of three tiers of arches of immense stones, the lowest tier having six, the next 11, and the topmost 35 arches. The river being apparently rather low at the time, he was able to step on to a platform of rock in the bed on which one of the piers of the lowest series of arches rested. It did not appear to present any indication of having been eroded below the level of the portion beneath the pier itself, nor did the bridge, which he was able to cross, from one side of the valley to the other, along the old channel or conduit at the top, present any appearance of having sunk since the foundations were laid. On the whole he should say that neither the bridge nor its foundations in any way suggested that the bed of the river had been lowered since the structure was erected. He admitted that his examination in this respect had been rather cursory, as at the time of his visit, on a winter afternoon, dusk was rapidly coming on. But he mentioned the matter because he had not observed that bridges had ever been referred to as affording evidence of the erosion or the rate of erosion of river valleys. He supposed there were not many cases in which a bridge 2,000 years old could be examined as a witness, and he, therefore, thought it worth while to inquire whether any attention had been given to the Pont du Gard with the object indicated.

Mr. J. COSMO MELVILL, M.A., read a paper entitled "Descriptions of New Species of Marine Mollusca from the Indian Ocean and Persian Gulf, dredged by Mr. F. W. Townsend."

The paper is printed in full in the *Memoirs*.

Professor S. J. HICKSON, F.R.S., read a paper entitled "On the Ampullæ in some Specimens of Millepora in the Manchester Museum."

The paper is printed in full in the *Memoirs*.

Ordinary Meeting, January 12th, 1897.

Professor REYNOLDS, LL.D., F.R.S., Vice-President,
in the Chair.

The thanks of the members were voted to the donors of the books upon the table.

Mr. FARADAY exhibited an enlarged photograph of the Pont du Gard, showing the points referred to at the last meeting of the Society, and specially referred to the circumstance that, though the South of France and the Riviera generally seemed to have the character of an earthquake district, and many earthquakes and earth-tremors might be reasonably assumed to have occurred during the 2,000 years since the bridge was built, no cracks nor indications of displacement or sinking were presented by the structure.

Mr. LINDSAY JOHNSON, M.D., F.R.C.S. (introduced by Mr. William H. Johnson) exhibited and remarked upon a series of drawings of the *fundus oculi* of animals, which he has given much time during the last five years in preparing, and also an enlarged photograph (6 ft. long) of the yellow spot in the human eye, a copy of which he presented to the Society.

[*Microscopical and Natural History Section.*]

Ordinary Meeting, November 9th, 1896.

Mark Stirrup, F.G.S., President of the Section,
in the Chair.

A paper by Mr. Peter Cameron on "**Hymenoptera Orientalia, or Contributions to a knowledge of the Hymenoptera of the Oriental Zoological Region,**" Part V., was read, and is published in full in the Society's *Memoirs*.

Mr. J. C. MELVILL exhibited a (European) specimen of *Calophasia platyptera* Esper, one individual of which species has been captured for the first time in this country by Mr. John T. Carrington, and the full record of this discovery has been given by him in the November number of *Science Gossip* for this current year (p. 141). It was found last summer flying out of a rough hedge surrounding a brickfield and other waste ground, on the south side of the old Shoreham Road, three miles from Brighton, and not far from Portslade Station, Sussex.

It is allied to the Shark Moths, *Cucullia*, of which Great Britain possesses several species, and may be known from any of that genus by its smaller size, the wings expanding only 1 in. to 1¼ in., the ashy grey forewings having a brownish patch running across the inner margin to the tip, and there being a few black transverse streaks in the marginal area. No stigmata, as usual in the Noctuina, and which are present in *C. lunula*, are perceptible; the hindwings are greyish brown, paler towards the base of the wings.

Staudinger, in his *Catalogue des Lépidoptères d'Europe*, p. 121, gives eight species of *Calophasia*; the majority of them are very local and barely known species from Beyrout, Armenia, Bithynia, and Castille, leaving, besides the subject of the present notice, only *C. casta* Bork. (= *opalina* Esper), a

beautiful and widely distributed Central European species, being also found in Asia Minor and Turkey, and *C. lunula* Hufn. (better known by the name of *C. linariæ* W.V.), even more widely extended in its range, and probably found as far east as Siberia. This latter was till lately included in all British lists (received in 1817 by the late Mr. Stephens, from Woodside, Epping Forest). The range of *C. platyptera* is very similar, viz., Central and Southern Europe, Crete, Camida, and extending to Bithynia in Asia Minor. It is quite likely to be established on our southern coasts, and we trust *C. lunula* Hufn. may again reappear also.

The food-plants of the larva are members of the order *Scrophularineæ*, e.g., the Toadflax and Figwort.

[*Microscopical and Natural History Section.*]

Ordinary Meeting, December 7th, 1896.

Mark Stirrup, F.G.S., President of the Section,
in the Chair.

Mr. H. FISHER, botanist attached to the Jackson-Harmsworth Polar Expedition, sent for exhibition a large collection of Arctic Plants collected by him from the Franz Joseph Archipelago. Mr. J. Cosmo Melvill and Mr. Th. Rogers also showed, for comparison, large collections of plants from Greenland, Spitzbergen, and the west side of Baffin's Bay.

A vote of thanks to Mr. H. C. Harmsworth for lending these plants (which only reached this country during the autumn) for exhibition, was proposed and carried unanimously.

The following is a list of the plants exhibited:—

1. *Ranunculus nivalis* L. Cape Flora, Northbrook Island,
11th July, 1896.
2. *Papaver nudicaule* L. Cape Flora, August, 1895; and
11th July, 1896.

3. *Cardamine bellidifolia* L. Cape Flora, 9th July, 1896; Mabel Island, 11th August, 1895; and 'Tween Rocks, 1895.
4. *Cochlearia anglica* L. (= *fenestrata* Br.) Cape Stephen, Zichy Land, 7th August, 1895; Bell Island, 10th August, 1895; Cape Neale, Zichy Land, 23rd July, 1895; and Cape Flora, 5th July, 1896.
5. *Cerastium alpinum* L. Cape Grant, Zichy Land, 5th August, 1895; and 'Tween Rocks, 7th August, 1895.
6. *Cerastium alpinum*, var. *glabratum* Hartm. Cape Flora, 13th August, 1895.
7. *Sagina Linnaei* Presl. Cape Neale, 24th July, 1895.
8. *Stellaria longipes* Gold (= *Edwardsii* Br.) Bell Island and Cape Flora, August, 1895.
9. *Arenaria sulcata* Schlecht (= *rubella* Whlbn.) Cape Neale, 24th July, 1895.
10. *Potentilla emarginata* Psh. 'Tween Rocks, 7th August, 1895; and Cape Stephen, 9th August, 1895.
11. *Saxifraga caespitosa* L. Cape Neale, 24th July, 1895; 'Tween Rocks, 7th August, 1895; and Cape Crowther, 1895.
12. *Saxifraga cernua* L. Cape Flora, 15th August, 1895; and Bell Island, 10th August, 1895; f. *vulgata*, Cape Flora, 15th August, 1895.
13. *Saxifraga nivalis* L. 'Tween Rocks, 7th August, 1895; Cape Neale, 1895; Cape Crowther, 24th July, 1895; and Bell Island, 10th August, 1895.
14. *Saxifraga oppositifolia* L. Cape Neale, 24th July, 1895; and Cape Flora, 14th August, 1895.
15. *Saxifraga rivularis* L. Cape Grant, 13th August, 1895.
16. *Saxifraga stellaris* L. var. *comosa* Poir. Cape Stephen, 8th August, 1895; Cape Gertrude, Northbrook Island, 7th July, 1895; and Mabel Island, 10th August, 1895.
17. *Juncus biglumis* L. Cape Neale, 24th July, 1895.

18. *Luzula hyperborea* Br. Cape Neale, 24th July, 1895; and Mabel Island, 10th August, 1895.
19. *Phippsia algida* Br. Cape Grant, 5th August, 1895.
20. *Pleuropogon Sabinii* Br. Mabel Island, 10th August, 1895.
21. *Poa flexuosa*, Wahl. Cape Stephen, 9th August, 1895; and Cape Grant, 5th August, 1895.

Mr. W. R. SCOWCROFT exhibited a collection of New Zealand ferns, and Mr. ROGERS showed specimens of *Sacoglottis amazonica*, with fruit, recently collected in Trinidad, by Mr. W. Lunt.

[Microscopical and Natural History Section.]

Ordinary Meeting, January 18th, 1897.

Mark Stirrup, F.G.S., President of the Section,
in the Chair.

Mr. C. H. SCHILL exhibited a selection from his collection of Elateridæ, which form a remarkably difficult group to study. Mr. Schill regretted that the group has not attracted more attention, and pointed out the extreme variation and diversity of coloration which occur in some of the species, increasing the difficulties of correctly naming the specimens. Mr. Schill also exhibited examples of mimicry between two butterflies, one a Pierid, *Dismorphia orisi*, the other a Danaid, *Ituna ilione*, of which the latter only is nauseous.

Mr. P. H. SCHILL (introduced by Mr. C. H. Schill) exhibited a collection of Palæarctic Parnassius, comprising a complete set of the Christoff collection, including a number of unique type specimens of new species described by Christoff.

Mr. B. H. CRABTREE (introduced by Mr. C. H. Schill) showed a collection of British Clearwings, containing specimens of 14 out of the 16 species known in Great Britain.

Mr. ROGERS exhibited a specimen of a curious caterpillar from Rio de Janeiro, and read the following letter from Mr. Bower :—

“ In walking through one of the beautiful hillside woods [of Rio de Janeiro] the other day, I saw what I took to be a patch of a dark-coloured moss, growing on the trunk of a tree. This patch was approximately circular, and about 6 in. in diameter. Near it, at a distance of about 4 in., was a smaller patch, about 2 in. in diameter, of the same nature. The moss, as it appeared to be, was in fruit, as I thought. I reached forward to get a little of it, but upon touching it, I observed a curious quivering motion which caused me to withdraw my hand. On touching it again I noticed the same thing, and only after the most careful examination at the best visual distance of about 10 in. I saw that what I thought to be patches of moss were congregations of caterpillars, closely and densely crowded together. Even after I had assured myself of the fact, I remained quite astonished at the resemblance.

“ The neighbouring trees were clothed with moss and hepatics of various kinds, and I have no doubt that this was a striking case of protective mimicry. As you will see by the few specimens I enclose, these creatures are covered with hairs, more or less resembling the leaves of a moss, and have besides a number of longer hairs tipped with tufts which, in life, looked exactly like the spore case and peristome of a moss. These stalks were erect and crowded together, and even when examined obliquely or sideways preserved their extraordinary resemblance. It is difficult to realise, from isolated specimens, how close and successful was the mimicry of a patch of dark-coloured moss, and good enough to deceive the very elect.”

Mr. STIRRUP exhibited a number of diagrams of fossil insects found in the coal measures of France, which prove the extreme antiquity of the *Insecta*.

Mr. CHORLTON described a swarm of minute dung-beetles which, at King Arthur's Castle, last summer, compelled his party to leave the peninsula on which the castle stands. They had, even then, difficulty in getting rid of the beetles from their hair and clothing.

[*Microscopical and Natural History Section.*]

Ordinary Meeting, February 15th, 1897.

John Boyd, Vice-President of the Section, in the Chair.

Mr. JOHN BUTTERWORTH, of Shaw, read a paper on "**Some further investigation of Fossil Seeds of the genus *Lagenostoma* (Williamson) from the Lower Coal Measures, Oldham,**" and illustrated it with a large number of specimens, microscopic sections, and photographs.

Mr. BUTTERWORTH also described his method of obtaining several photographs from the same specimen by successive grindings and polishing.

General Meeting, January 26th, 1897.

Professor Harold B. Dixon, F.R.S., in the Chair.

Mr. J. Grossmann, Ph.D., Harpurhey Chemical Works, Manchester, and Mr. J. F. Tristram, M.A., Hulme Grammar School, were elected ordinary members.

Ordinary Meeting, January 26th, 1897.

Professor Harold B. Dixon, F.R.S., in the Chair.

The thanks of the members were voted to the donors of the books upon the table.

Mr. ALFRED R. BENNETT, M.I.E.E., read a paper entitled: "**A Convection Scope and Calorimeter,**" which was communicated by Mr. William Thomson, F.C.S.

Mr. BENNETT described how he had devised a small and exceedingly sensitive motor, which begins to revolve the moment it is exposed to daylight in the open air, whether the sun be shining or not, and which will also work all night in clear weather. The delicacy of the motor is such that it is affected by the radiant heat of moonlight. The motive power is due to convection currents caused by the radiant heat of daylight striking through a glass shade, with which the instrument is covered; the glass is not heated, but the metal surfaces of the instrument are, and air is consequently expanded on the motor surfaces, and condensed on the glass, the resulting difference of temperature setting up a convection current which does not cease so long as the instrument is exposed to the radiant heat due to visible rays.

Descriptions were given of modifications by which surplus heat is automatically stored during the day and employed to

drive the instrument at night. During the months of May, June, and July last, such a storage instrument continued in motion without stopping day or night; and in fine climates, like Egypt, much longer periods of continuous movement could undoubtedly be secured. The speed of the instrument is affected by barometrical pressure and hygroscopic conditions. It is capable of marking the dew-point, and works well, even when its glass shade is completely coated with ice, or half-buried in snow. Mr. Bennett has succeeded in adapting the instrument to act as a calorimeter by first cooling the whole of the instrument to a given temperature, when rotation ceases, and then suspending pieces of heated metal inside. In this way the specific heats of substances can be accurately compared, since the number of rotations caused is in direct proportion to the amount of introduced heat. The instrument can also be used to measure the comparative heat-retaining power of textile fabrics, boiler compositions, &c., and the relative heat conductivities of thin threads and wires. Mr. Bennett has also instituted a series of experiments, as yet incomplete, into the comparative sensitiveness to convection effects of various gases, which promise interesting results, since the differences already noted are unexpectedly great, and, moreover, do not bear any direct relation to the densities or other known physical properties of the gases tried.

Ordinary Meeting, February 9th, 1897.

Edward Schunck, Ph.D., F.R.S., President, in the Chair.

The thanks of the members were voted to the donors of the books upon the table.

The PRESIDENT nominated Dr. C. H. LEES and Mr. FRANK SOUTHERN to be the auditors of the Society's accounts for the current Session.

Mr. R. L. TAYLOR, F.C.S., read a paper "**On Hypoiodous Acid and Hypoiodites.**"

The paper is printed in full in the *Memoirs*.

The PRESIDENT, Dr. G. H. BAILEY, and Dr. A. HARDEN took part in the discussion which followed.

Ordinary Meeting, February 23rd, 1897.

J. Cosmo Melvill, M.A., F.L.S., Vice-President, in the Chair.

The thanks of the members were voted to the donors of the books upon the table.

Dr. PANKHURST invited the attention of the Society to the insufficient assistance rendered by the Patent Office to inventors and to the public. He suggested that the Patent Office should provide in respect of each order of invention: in the first place, information as to the existing state of knowledge; next, a clear and full examination as to the invention; and finally, a comprehensive report of the result of the examination.

There should be provision for putting on record, in the Patent Office, these reports, which would mark the advance of science along the lines of invention represented by the patents applied for.

As time goes on, these records would become valuable material on which to found a history of scientific progress.

Dr. PANKHURST thought that the Society might properly make a representation, claiming that the Patent Office should be so organised as to carry out this view, which he thought would prove of great public utility.

Mr. JOHN BUTTERWORTH read a paper entitled: "**Some further investigation of Fossil Seeds of the genus *Lagenostoma* (Williamson) from the Lower Coal Measures, Oldham,**" which was communicated by Mr. John Boyd.

The paper is printed in full in the *Memoirs*.

Ordinary Meeting, March 9th, 1897.

Professor Osborne Reynolds, F.R.S., Vice-President,
in the Chair.

The thanks of the members were voted to the donors of the books on the table.

The CHAIRMAN announced that, as April 20th falls in Easter week, the Council had, by resolution under Rules 28 and 38, determined that the Ordinary and Annual General Meetings put down for that date on the card of meetings, should be held on Tuesday, April 27th, at half-past six o'clock.

Dr. C. H. LEES gave a short account of Zeeman's experiments on the effect of a magnetic field on the vibrations emitted by a source of light, and gave a short explanation of the results from the point of view of the later developments of Maxwell's electro-magnetic theory of light.

Professor REYNOLDS and Professor LAMB took part in a discussion which followed.

Dr. F. H. BOWMAN described the method of working of the Marconi telegraphic receiver, which, he said, could be easily carried about without disturbing its sensitiveness or the arrangements to make its period synchronous with that of the transmitter. By this apparatus messages might be received at a distance of two miles without wires, and it seemed to be capable of practical use, for instance, in communicating between lighthouses and ships or with the shore.

Professor HORACE LAMB, F.R.S., read a paper entitled: "**On Continuity.**"

This paper is printed in full in the *Memoirs*.

Professor REYNOLDS, Dr. LEES, Dr. F. H. BOWMAN, Mr. ANGELL, and Mr. GWYTHYER took part in the discussion which followed.

Mr. A. W. FLUX read two papers entitled: "**The Costs of Sea Transport in proportion to Values of Cargoes,**" and "**The Fall in Prices during the past Twenty Years.**"

These papers are printed in full in the *Memoirs*.

Mr. FARADAY made some remarks upon the subject of the papers.

Ordinary Meeting, March 23rd, 1897.

Charles Bailey, F.L.S., Vice-President, in the Chair.

The thanks of the members were voted to the donors of the books upon the table.

Mr. F. NICHOLSON exhibited a copy of Gilbert White's "Naturalist's Calendar" (1795), and made some remarks upon the history of the book, and on its contents.

Mr. J. COSMO MELVILL communicated a paper from Mr. PETER CAMERON, entitled: "**Hymenoptera Orientalia, or contributions to a knowledge of the Hymenoptera of the Oriental Zoological Region,**" Part VI.

This paper will be printed in full in the *Memoirs*.

A discussion followed, mainly on the subject of the degree of difference necessary to constitute distinct species in animals and plants. Messrs. BAILEY, HOYLE, MELVILL, NICHOLSON, FARADAY, and Dr. F. H. BOWMAN took part in the discussion.

[*Microscopical and Natural History Section.*]

Ordinary Meeting, March 15th, 1897.

MARK STIRRUP, F.G.S., President of the Section,
in the Chair.

Mr. J. F. ALLEN and Mr. W. R. SCOWCROFT were elected auditors.

A paper was contributed by Mr. PETER CAMERON on the "**Chrysididæ of the Oriental Region**," illustrated by specimens.

Mr. MARK STIRRUP exhibited a drawing of a bird *Pteridophora Alberti* Meyer. During the breeding season the male has two feathers depending from the eyes several times the length of the bird (see *Bulletin du Museum d'histoire Naturelle*, Année 1895, No. 2).

Mr. ROGERS exhibited a fungus *Torrubia gracilis* growing out of the chrysalis of a moth found near Marple.

[*Microscopical and Natural History Section.*]

Annual Meeting, April 12th, 1897.

MARK STIRRUP, F.G.S., President of the Section,
in the Chair.

The Annual Report of the Council and the Treasurer's Financial Statement were submitted and adopted.

The following officers and Council were elected for the session 1897-98: President, MARK STIRRUP, F.G.S.; Vice-Presidents, JOHN BOYD, J. COSMO MELVILL, M.A., F.L.S.;

Treasurer, C. OLDHAM; Secretary, THEODORE SINGTON; Council: J. F. ALLEN, CHAS. BAILEY, F.L.S., G. H. BROADBENT, M.R.C.S., ALEXANDER HODGKINSON, M.B., B.Sc., W. E. HOYLE, M.A., M.Sc., HENRY HYDE, FRANCIS NICHOLSON, F.Z.S., THOMAS ROGERS.

The evening was devoted to microscopy. The PRESIDENT read a paper on the "**Ostracoda of the Coal Measures**," and exhibited a large number of specimens under the microscope; for comparison Mr. ROGERS brought a large collection of slides of existing *Ostracoda*, collected by the late Dr. Robertson, of Cumbrae.

Mr. CHAFFERS, introduced by Mr. ROGERS, exhibited several exceptionally interesting and crowded slides of "Plankton," marine life collected from the Sulu Sea and off New Guinea; the specimens appeared to have been instantaneously killed, and mounted as they appeared when alive. A number of species of *Holothurida*, showing spiculæ, were also exhibited.

Ordinary Meeting, April 6th, 1897.

Professor OSBORNE REYNOLDS, LL.D., F.R.S.,
Vice-President, in the Chair.

The thanks of the Society were voted to the donors of the books upon the table.

Mr. W. E. HOYLE exhibited the album of photographs and autographs presented to Dr. John Murray by the contributors to the "Challenger" Reports.

ANNUAL GENERAL MEETING, APRIL 27TH, 1897.

EDWARD SCHUNCK, Ph.D., F.R.S., President,
in the Chair.

Sir HENRY ENFIELD ROSCOE, LL.D., D.C.L., F.R.S.,
was elected an honorary member.

The Annual Report of the Council and the statement of the accounts were presented, and it was moved by Professor F. E. WEISS, seconded by Dr. PANKHURST, and resolved:—"That the Annual Report, together with the statement of accounts, be adopted, and be printed in the Society's *Proceedings*."

Professor REYNOLDS made reference to the letter from Dr. Schunck included in the Annual Report, in which he expressed his wish to be relieved from holding office in the Society, and it was moved by Dr. PANKHURST, seconded by Professor WEISS, and resolved:—"That this meeting of the Society heartily approves of the resolution of the Council expressing its regret at the retirement of Dr. Schunck from the office of President, and putting on record its high sense of his services to the Society and of the value of his contributions in the domain of organic chemistry."

It was moved by Mr. JOHN BOYD, seconded by Mr. J. COSMO MELVILL, and resolved:—"That the system of electing Associates of the Sections be continued during the ensuing session."

The following members were elected officers of the Society and members of the Council for the ensuing year:—

President: JAMES COSMO MELVILL, M.A., F.L.S.

Vice-Presidents: OSBORNE REYNOLDS, M.A., LL.D., F.R.S.;
ARTHUR SCHUSTER, Ph.D., F.R.S.; CHARLES BAILEY, F.L.S.;
WILLIAM HENRY JOHNSON, B.Sc.

Secretaries : REGINALD FELIX GWYTHER, M.A.; FRANCIS JONES, F.C.S.

Treasurer : J. JACKSON ASHWORTH.

Librarian : W. E. HOYLE, M.A., M.Sc., M.R.C.S.

Other Members of the Council : HAROLD B. DIXON, M.A., F.R.S.; HORACE LAMB, M.A., F.R.S.; ALEXANDER HODGKINSON, M.B., B.Sc.; FRANCIS NICHOLSON, F.Z.S.; JOHN EDWARD KING, M.A.; R. L. TAYLOR, F.C.S.

Ordinary Meeting, April 27th, 1897.

EDWARD SCHUNCK, Ph.D., F.R.S., President,
in the Chair.

The thanks of the members were voted to the donors of the books upon the table.

Dr. ARTHUR HARDEN read a paper "**On the composition of some ancient Bronze and Iron Implements found in Thebes.**"

Among the implements examined were two iron chisels, apparently dating from about 600 B.C.; both the implements contain a very small amount of carbon, and could not be rendered very hard by tempering.

A specimen of bronze dating from about 1500 B.C. was found to resemble modern bronze in its composition consisting of copper alloyed with tin.

The paper is printed in full as a *Memoir*.

It was stated that a paper on "The Principles and Policy of the Patent Law" would be contributed by Dr. Pankhurst and Dr. F. E. Bowman conjointly.

Special Meeting, July 2nd, 1897.

EDWARD SCHUNCK, Ph.D., F.R.S., Past-President,
in the Chair.

The meeting was held for the purpose of presenting the Wilde Medals for the years 1896 and 1897, announcing the award of the premium for 1897, and for the delivery of the Wilde Lecture by Sir George Gabriel Stokes, Bart., F.R.S., and there was a large attendance.

Dr. SCHUNCK said: We are met to-day on a special occasion. Some time ago Mr. Henry Wilde, F.R.S., a distinguished member of this Society, whose work is well known in scientific circles, resolved to endow the Society with a fund, to be invested in the name of the Society, the income derived from which should be devoted to the advancement of literature, science, and philosophy, and to the recognition of meritorious work in the following manner, viz.:—

(1) By the providing of a Gold Medal, to be called the Wilde Medal, to be awarded annually to a person to be selected by the Council, who is the author or originator of any discovery in natural science, or of any valuable invention in applied science, or is the author of any original paper or essay on a literary, scientific, or philosophical subject, which shall have either been published or accepted by the Council for publication in the *Memoirs* of the Society, or have been published elsewhere.

(2) By the payment of a premium of £15. 15s., with which a "Dalton Medal," in silver or bronze, may or may not be awarded by the Council annually to a person to be selected by the Council, who is the author of any original paper on a literary, scientific, or philosophical subject which shall have been published or accepted by the Council for publication in the *Memoirs* of the Society.

(3) The annual sum of £15. 15s. to be awarded as an honorarium or acknowledgment to be presented to such literary or scientific man of eminence as the Council may select for the delivery by him of a lecture before the members of the Society, and the receipt of such honorarium shall not in any way render the recipient thereof ineligible for the award at the same time of any of the Medals referred to.

In accordance with the regulations I have just read the Council have selected Sir George G. Stokes as the recipient of the Wilde Medal for 1896. They have done so (1) on account of his pre-eminent services to Mathematical and Physical Science, and (2) having regard to the standing which he occupies in relation to leading physicists of this and other countries.

As regards the first head it seems unnecessary to enumerate in detail merits which have been so universally recognised both here and abroad. It will be enough to recall that he was the pioneer in the great modern development of Hydrodynamics, and has made permanent contributions both to the general theory and its applications; that he is the author of many highly original papers on questions of Physical Optics, a subject on which he is still a leading authority; that he has made at least one experimental research of first-rate importance, viz., that on the nature of fluorescence; and that his papers on the "Figure of the Earth" and on "Fourier's Theorem" have taken rank as classics in subjects which are especially remarkable for the number and eminence of the mathematicians who have been engaged on them.

As regards the second head it may be remarked that Sir George Stokes was the senior, and, to some extent, the teacher, of such men as Lord Kelvin, Maxwell, and Professor Tait, who have all recorded in the highest terms their admiration of Stokes' work and the assistance which they have themselves received from his writings. Similar appreciation has been shown by distinguished men of

science in other countries, notably by Von Helmholtz. In short, Sir George Stokes' labours, though rarely of a popular character, have advanced science in the best possible way, through the influence which they have exercised on men who have since followed, with conspicuous success, similar lines of research.

Dr. SCHUNCK then presented the Medal to Sir GEORGE STOKES.

On receiving the Medal Sir GEORGE STOKES replied: "I feel highly this recognition by the Council of the Literary and Philosophical Society of such work as I have been able to perform. I am getting to be an old man now, and I am afraid that for many years back my work has been but small. Still, I am thankful to say that I have been blessed with remarkably good health, and I hope that my powers are not yet quite extinct."

Dr. SCHUNCK then proceeded to say: The Council have awarded the Wilde Medal for 1897 to Sir William Huggins, K.C.B., F.R.S., on the following grounds:—

(1) For the accurate mapping of the spectra of the metals.

(2) For the first successful application of spectrum analysis to the light of the stars, nebulae, and comets, whereby he proved—

That the vapours of a number of terrestrial elements are present in the atmospheres of the stars;

That many nebulae differ from stars in having spectra of bright lines only, which show that they consist of incandescent gases;

That comets (when near the sun) have a nucleus which gives a bright line spectrum;

That the approach or recession of stars in relation to the solar system can be measured by the displacement of the lines in the spectrum. His measurements are still considered to be the standard determinations of star motions.

(3) For the first successful photographs of star spectra, in which he discovered a series of hydrogen lines in the ultra-violet.

Mr. GWYTHER read the following letter, which he had received from Sir William Huggins:—

“90, UPPER TULSE HILL, S.W.,

“June 29th, 1897.

“DEAR SIR,

“I have delayed writing in the hope of being
“able to come on Friday. I regret to say that I am not
“so well as I hoped I might be; and I am sure that it
“would be scarcely prudent for me to take just now the
“fatigue of the journey to Manchester.

“I do hope that you and the Council will accept the
“assurance of my very high appreciation of the high
“honour of being the recipient of the Wilde Medal, and
“that I value much the distinction thereby conferred upon
“me by the Society.

“With renewed thanks,

“Very faithfully yours,

“WILLIAM HUGGINS.”

The SECRETARIES undertook to forward the Medal to Sir William Huggins.

The CHAIRMAN announced that a premium of £15. 15s. under the Wilde Trust, had been awarded by the Council to Mr. PETER CAMERON for his series of papers on “**Hymenoptera Orientalia.**”

After the presentation of the Medals the members assembled in the Library, where Sir GEORGE STOKES delivered the Wilde Lecture on “**The Nature of the Röntgen Rays.**”

The Lecture is printed in full in the *Memoirs*.

At the conclusion of the Lecture,

Professor OSBORNE REYNOLDS moved a vote of thanks to Sir GEORGE STOKES for his address. "I wish," he said, "to express our great appreciation of the honour which Sir George Stokes has conferred upon the Society in delivering the first Wilde Lecture. He has made it an honour for any subsequent lecturer to succeed to the office. The lecture to which we have listened is, I am sure, a model of what a lecture on an abstruse subject may be made in the hands of one who is a master of the subject."

Annual Report of the Council, April, 1897.

The Society began the session with an ordinary membership of 150. During the present session 21 new members have joined the Society; 6 resignations have been received, and the deaths have been 4, viz.: Mr. William Brockbank, F.G.S., F.L.S.; Mr. Samuel Cottam, F.R.A.S.; Mr. Thomas Hick, B.Sc.; and Mr. James Parlane. This leaves on the roll 161 ordinary members. The Society has also lost 6 honorary members by death, viz.: Professor Du Bois-Reymond, F.R.S.; Sir Joseph Prestwich, F.R.S.; Professor Henri Rézal; Professor J. J. Sylvester, F.R.S.; Mons. A. Trecul; and General F. A. Walker.

The Treasurer reports that he has thought it advisable so far to alter the arrangement of the accounts as to agree better with the deed of endowment made by Mr. Wilde. In order to conform with the wish expressed in the deed that the accounts of this Trust should be kept separately, the receipts and expenditure have been placed in a separate account, and the accounts of the Society as a whole entered simply under the heads of Receipts and Expenditure, as is the case with the accounts of the Royal Society.

The Treasurer commenced the year with a balance in favour of the Society of £357. 2s. 7d., and is pleased to report that the total balance, including the Wilde and Joule Funds, and not including the amount still owing by the Natural History Fund, in hand and at the Bankers, at the close of the year, is £375. 4s. 3½d.

The Treasurer also wishes to call attention to the fact that the sum of £74. 15s. od., including the estimated cost of designing the Gold Medal of the Society, making the die, and stamping two gold medals, together with the premium for the Lecturer, as voted in the minutes of the Council for

this session, has been charged in the accounts, and will be retained in the Treasurer's hands until the invoices are received and duly receipted. This course has been adopted in order that the Bank Pass Book and Invoice Book should show the actual expenditure authorised by the Council for the session 1896-7 as required by the Trust deeds.

The Council has approved a design for the Wilde Gold Medal, and the die is now being prepared by Messrs. Elkington.

The work of re-cataloguing the library, which was begun on the 13th of August, 1896, has made satisfactory progress. The total number of volumes catalogued amounts to 2,681; of these, 1,862 are serial publications, and 819 separate works; for, as was stated in the last Report, the library is now divided into these two distinct categories. Every volume that passes through the hands of the cataloguer is duly stamped and press-marked, and a great number of the catalogue-cards, to which reference was made in the last Report, has now been written both for serials and separate works, 493 being due to the former, 781 to the latter, making a total of 1,274 cards. The separate works catalogued belong to the following branches of science: Mathematics, Physics, Chemistry, and Zoology.

The shelf list, which was in contemplation last session, has now been commenced, and will be found most useful, as showing what books on the various subjects the library contains.

In the last Report the hope was expressed that funds would shortly be forthcoming for the binding of volumes, which, owing to the expenditure necessitated by the provision of new shelving, had been postponed. This hope has now been fulfilled, and 374 volumes have been bound in 362, while 11 volumes have been suitably repaired.

It has not yet been possible to catalogue the inaugural dissertations contained in the library and amounting to some hundreds. But in the meantime, in order to facilitate

reference to them, they have been arranged separately in alphabetical order under the authors' names, awaiting the time when they will be incorporated in the catalogue.

There is every reason to hope that the new system adopted in the re-arrangement of the library and in the compilation of this catalogue will be fully justified; indeed, the best proof of its advantages lies in the fact that during this session twice as many volumes have been borrowed from the library, as during the last.

A list of the serial publications received by the Society has been drawn up, and will shortly be printed.

The donations during the past session (exclusive of the usual exchanges) amount to 62 volumes; and one book has been purchased (in addition to the periodicals on the regular subscription list).

In accordance with the resolution passed by the members at the last annual meeting, with reference to the most suitable hour for the meetings of the Society, the Council issued a circular to all members asking whether it was more convenient to meet in the afternoon, the evening, or alternately in the afternoon and evening. The number of replies received was 94, of which 42 were in favour of afternoon meetings only, 20 in favour of evening meetings only, 23 in favour of alternate afternoon and evening meetings, and 9 were neutral. It appeared to the Council that the wishes of the members would be best met by reverting to the plan of alternate afternoon and evening meetings. The evening meetings have been held at half-past six, instead of at seven o'clock. The average attendance of members during the session at afternoon meetings has been 21, and at evening meetings 15. There have been twice as many visitors at the afternoon as at the evening meetings.

A complete list of the members and officers of the Society from its institution, with bibliographical lists of its

publications, and with two appendices, containing reprints of the earliest publications of the Society, was issued to the members in November last.

The last volume of the *Memoirs and Proceedings* was the tenth of the Fourth Series, and it would have been in accordance with the practice of the Society to have started a new Series with the present session. Instead of beginning a new Series, the Council has decided to count the volumes from the commencement, and has given to the current volume the number xli. At the same time, other changes have been made in the volume. The *Proceedings* are printed in a type different from that of the *Memoirs*, and are consecutively paged, so that in the bound volume they will be continuous and separate from the *Memoirs*. The running headings of the *Memoirs* are altered in form, so that the right-hand page-heading now gives the proper form for giving a reference to the paper, and for this purpose the title *Manchester Memoirs*, which has been in use since Dalton's time, has been definitely adopted as the official name.

The Society was represented by Professor Schuster on the occasion of the Jubilee of the Professorship of Lord Kelvin. The address sent to Lord Kelvin, and his reply, have already been printed in the *Proceedings*.

The first awards of the Wilde Medal have been made by the Council. The Medal for 1896 has been awarded to Sir George Gabriel Stokes, for his eminent services to mathematical and physical science; and that for 1897 to Dr. William Huggins, for his researches on the application of spectrum analysis to solar and stellar physics. Arrangements are in progress for fixing a date for the presentation of these Medals, and for the delivery of the Lecture under the Wilde Trust. The first award of the premium under the Wilde Trust has been made to Mr. Peter Cameron, for his papers on *Hymenoptera Orientalia*, which have been published in the *Memoirs*.

It is with great regret that the Council informs the Society that the following letter has been received from Dr. Schunck:—

“ KERSAL, 6th April, 1897.

“ DEAR MR. GWYTHYR,

“ I hardly think you will be surprised when I tell you that the purport of these lines is to inform you, and through you the Society, that I wish to resign the office of President, which I have held during the present session, that is, that I decline to hold it for longer than the present session. Before the last election of officers, I was urged by two parties in the Society to accept the position I now hold. I did so with great reluctance, but with the hope that the cause of peace might thereby be promoted. This has, I believe, to a certain extent been effected, and I, therefore, think I may now be relieved from the burden and obligations of office.

“ It is but seldom that, at my age, any man is able or can be expected to take an active interest in the affairs of an important Society such as this—the interest he takes must be more or less of a *pococurante* character. At my age many men can do little more than write a few almost unintelligible phrases in almost illegible lines. I can, thank heaven, do a little more than that. Still the exertion of doing what I was wont to do becomes great, and the desire for quiet and repose constantly increases.

“ I have been a member of this Society for more than 50 years, and for the greater part of the time engaged in some official capacity, either as Secretary, Vice-president, or President. I think, therefore, the time has come for me to respectfully decline any office the Society, or any majority of the Society, may wish to confer on me.

“ In looking back over the years I have been a member of the Society, I may say that I never knew the business of the Society to be more efficiently conducted than it is at present.

“ In one respect a change has taken place in the constitution of the Society which is still in progress. I mean the gradual effacement of what, without giving offence, may be called the *dilettante* element, of men who carried on science and literature not as a profession but as an intellectual diversion, and the substitution of men who cultivate science in a strictly professional spirit. This may be regretted—I regret it—but considering the great and ever increasing specialisation of science, and the difficulties attending its cultivation, this tendency must be ever on the increase.

“ Parting is always sad, especially when it may be presumed it is for ever; but when it is accompanied, as I hope it is in this case, by sentiments of mutual esteem, some compensation for sorrow may be found.

“ You will please to convey to the Society my wish that this my decision may be considered final and irrevocable, and also that, in severing my official ties, I bid them an affectionate farewell.

“ I am, dear Mr. Gwyther,

“ Yours very truly,

“ EDW. SCHUNCK.”

The Council has passed the following resolution:—

“ The Council has received with great regret the letter of Dr. Schunck, stating his inability to hold office any longer; and desires to place on record this expression of its most grateful appreciation of Dr. Schunck’s eminent services to the Society—services rendered for more than 50 years—and not least during the present session.

“ Not only has Dr. Schunck undertaken arduous duties as Secretary and President of the Society, in which offices he has won the esteem and affection of all our members by his uniform patience and courtesy, but he has, by his original investigations in the domain of

“Organic Chemistry, given a high value to our meetings
“and conferred lustre on our Society, which will ever
“connect his name with those of Dalton and Joule.”

EMIL DU BOIS-REYMOND, though he was born and died at Berlin, and will always rank as a German physiologist, was, as his name indicates, of Celtic origin. His father was a native of Neufchatel, and his mother was of Huguenot stock; as he himself has said, he “was of pure Celtic blood.” Born on November 7, 1818, at Berlin, where his father was then residing, he studied for some time at the French College there, but subsequently at Neufchatel. At 18 years of age he entered at the University of Berlin, and after studying science and medicine there and at Bonn, took his doctor's degree in medicine at the former place. His father, though of slender means, seems to have assisted him to devote himself to science rather than to practical life, and in 1840 he became assistant to Johannes Müller, then Professor at the University of Berlin. Müller, great both as a physiologist and as an anatomist, had, as Professor, charge both of physiology and anatomy; but as assistant, Du Bois-Reymond seems to have been specially intrusted with physiology. In his graduation thesis he had dealt with “electric fishes,” and he early devoted himself to what proved to be his life's work, the investigation of the electrical phenomena presented by living beings. Some of his results he communicated to scientific periodicals, but the main exposition of his inquiries, and of the views to which these led him, are to be found in his *Researches in Animal Electricity* (*Untersuchungen über thierische Electricität*), the 1st and part of the 2nd volume of which appeared in 1848-9, which was continued in 1860, but was not concluded until 1884.

Upon the death of Johannes Müller in 1858, the chair held by him of Anatomy and Physiology was divided into a chair of Anatomy with Comparative Anatomy and a chair of Physiology. The former was given to Reichert;

Du Bois-Reymond was placed in the latter, and at the same time made director of the Royal Physiological Laboratory. He remained the Professor of Physiology until his death, and the small physiological laboratory with which he began the duties of his chair increasing in usefulness under his fostering care, was in 1877 replaced by the present palatial Physiological Institut. In 1869 he was made Rector of the University; and having joined the Berlin Academy of Sciences in 1851, he became its perpetual secretary in 1867.

He visited England more than once: in 1852, in 1855, when he lectured at the Royal Institution in London, in 1866, and again in 1882, when he attended a meeting of the British Association for the Advancement of Science at Southampton. Among the many honours which fell to his lot, may be mentioned the Foreign Membership of the Royal Society in 1877, and that of the Literary and Philosophical Society of Manchester in 1892.

In attempting to estimate the value of Du Bois-Reymond's scientific work, it should be remembered that he was a pupil of Johannes Müller. That great man is often spoken of as a "Vitalist," and in a certain sense he was; no one, however, recognised more clearly than he did the importance of pushing as far as possible the chemical and physical analysis of the phenomena of living beings. And it was largely upon his encouragement that the young Du Bois-Reymond devoted himself to the study of animal electricity. When he began, though Matteucci in Italy was working at the subject, it may be said that very little was known about it. And if at the present day it can be said that these phenomena have been subjected to a more exact and successful analysis than most of the phenomena exhibited by living beings, the exactitude and success are in a very large measure due to Du Bois-Reymond's labours.

Much of his work lay in devising adequate instruments for properly observing the phenomena. In no part of physiology, perhaps, is a greater use made of instruments,

often extremely complicated, characterised by extreme delicacy and precision. And if other hands than those of Du Bois-Reymond have added to these some finishing touches, to him belongs the credit of having brought them first into general use.

The outcome of his long continued labours consists on the one hand in the determination of facts in the enunciation of the principal laws according to which living beings develop electric currents, and on the other hand in the construction of a theory to account for the facts and explain the laws. Of the former part of his labours, very much indeed remains as a permanent addition to science. The latter part has not been so fortunate. Du Bois-Reymond was led to believe in the existence of electrical molecules as an essential and integral part of living tissues, and to attribute the development of electric currents to these. Other observers, among whom L. Hermann, himself a pupil of Du Bois-Reymond, is prominent, explain the existence of the currents as due to the changes, the chemical changes, necessarily taking place whenever a tissue enters in a state of activity. And though the older views have still their supporters, the conceptions of Hermann are those which have gained the greater adhesion among physiologists. But even the strongest partisans of the school of Hermann fully admit that Du Bois-Reymond is virtually the founder of this particular branch of science.

Though Du Bois-Reymond attacked problems in physiology other than those of electricity, yet his main work lay in these. He published his collected papers as "Gesammelte Abhandlungen" in 1875-7. His usefulness in the world, however, was not limited to these various specific and technical inquiries. At Berlin he became a man of power, and did much to raise and maintain the high reputation in which science is held in the German kingdom and empire. During the latter years of his life he and Helmholtz were conspicuous personages in German society. His influence was due not alone to his original inquiries, but also to his varied and many public utterances on scientific and other

topics. These, in which his Celtic nature gave a fineness and incisiveness to the intellectual results of his thorough German training, produced a marked effect wherever they were heard or read ; and in particular the rectorial address which he delivered in August, 1870, at the time of the great Franco-German war, and which was in part a political harangue, attracted great attention. These various discourses were published as "Reden" in 1886-7.

Thus, during his later years, working at times at his old subject even till near the end, but more especially influential as a powerful personage aiding the development of science, more particularly of German, he lived full of honour and respect until the end came. He passed away on the 26th December, 1896.

M. FOSTER.

Sir JOSEPH PRESTWICH, M.A., D.C.L., F.R.S., F.G.S., the descendant of an old Lancashire family, was born at Pensbury, Clapham, near London, on March 12, 1812. He received his early education at Paris, Reading, and, finally, at University College, London. For more than 40 years he was closely connected with the business of his father, a wine merchant in Mark Lane, but in 1874 he was appointed Professor of Geology at Oxford, in succession to the late Professor Phillips. This post he held until the year 1888, when he retired, the University at the same time conferring on him the honorary degree of D.C.L.

His life's work in the advancement of his favourite study of geology, is attested by a series of important memoirs on the Tertiary formations of Europe, a branch of geology of which he was an acknowledged master. His papers published in the *Quarterly Journal of the Geological Society of London*, "On the Structure of the Crag Beds of Suffolk and Norfolk," and on other collateral subjects, as, the Valley Gravels of the South of England, the Drift and its organic contents, volcanic phenomena and their causes, show the wide range of his researches.

In 1858 and the following year, Prestwich, in company with some of the most notable English geologists, Flower, Godwin-Austen, Dr. Falconer, Lyell, Evans, and others, paid the famous visits to the valley of the Somme in Northern France, to investigate the evidence of the antiquity of man—evidence which had been gradually accumulating for 10 years or more previously under the hands of the late Boucher de Perthes. Prestwich's work in the valley gravels of the South of England enabled him to give an authoritative opinion on the age of the similar deposits of the valley of the Somme, an opinion which established, after much heated controversy, the doctrine of the antiquity of man and man's co-existence with an extinct fauna.

Prestwich served on the Royal Coal Commission of 1866 and on the Royal Commission on Water Supply of 1867. In 1849 he was awarded the Wollaston Medal by the Geological Society for his researches at Coalbrook Dale and in the London Basin. In 1853 he was elected a Fellow of the Royal Society, and in 1865 one of the Royal Medals was awarded him for his contributions to geological science. The value of his paper on "The Geological Conditions affecting the Construction of a Tunnel between England and France," published in 1874, was recognised by the Institution of Civil Engineers awarding him a Telford Medal and premium. Amongst the many honours which fell to him may be mentioned the Corresponding Membership of the Académie des Sciences; the Foreign Membership of the K. K. Geologische Anstalt (Vienna), and of the Reale Accademia dei Lincei (Rome); whilst in 1888 he filled the important office of President of the fourth session of the International Geological Congress, held in London for the first time. He was elected an honorary member of this Society on January 23, 1866, and his services, both to Science and the State, were recognised by the honour of knighthood being conferred on him at the beginning of 1896.

Sir Joseph Prestwich—the Nestor, as he has been called, of British geologists—was occupied in his later years with the production of his “Manual of Geology,” a work which bears the impress of his wide knowledge and incessant industry. He died at his home at Shoreham, Kent, on June 23, 1896, full of honours and respected by all who had the privilege of his acquaintance.*

HENRI AIMÉ RÉSAL was born at Plombières (Vosges) on January 27, 1828, and died August 25, 1896. He was the author of numerous books on mining mechanics, and various papers on geology and applied mathematics were published by him in the *Annales des Mines* and the *Mémoires de la Société d'Émulation du Doubs*. From 1875-1884 he edited the *Journal de Mathématiques pures et appliquées*. In 1870 Résal was appointed to be Professor of Mechanics at the École Polytechnique, and in 1888 received the post of Inspector-General of Mines. He was President of the Société Mathématique de France, a member of the Académie des Sciences, and an officer of the Légion d'Honneur. Résal was elected an honorary member of this Society on April 30, 1889.

JAMES JOSEPH SYLVESTER was born in London on September 13, 1814. He was educated at the Liverpool Institute, and at St. John's College, Cambridge. In the Mathematical Tripos of 1837 he appeared second in a list which is otherwise memorable as containing the name of Green. His religious disability (he was of Jewish origin) prevented him from proceeding to a degree, and from gaining the Fellowship which would have naturally followed. His subsequent career was somewhat varied. After holding for a short time teaching posts in London and in Virginia, he supported himself by actuarial work, until in 1855 he was appointed Professor of Mathematics

* For fuller notices, see *Proc. Roy. Soc.*, Vol. 60, pp. xii.-xvi.; *Quart. Journ. Geol. Soc.*, Vol. 53, pp. xlix.-lii.; and *Nature*, Vol. 54, pp. 202-3.

at Woolwich. This post was held by him till 1870, when, in consequence of some reorganisation, his services were dispensed with. There was a widespread feeling that the Government of the day were dealing in a narrow and illiberal spirit with a man of Sylvester's scientific eminence and long service. The case was taken up by the *Times* newspaper, and in consequence of the pressure brought upon them the Government were induced to accord a substantial pension. A few years afterwards he was called to the Professorship of Mathematics in the newly-founded Johns Hopkins University at Baltimore. He discharged the duties of this post with great spirit and enthusiasm, and the present active school of American mathematicians may be said to have originated under his leadership. The *American Journal of Mathematics*, which has taken rank among the great mathematical serials, was also founded and for a long time conducted by him. Sylvester returned to this country in 1883, to fill the vacancy which had been caused by the death of Henry Smith in the Savilian Chair of Geometry at Oxford. He held this office till his death, but increasing infirmities led to his practical retirement in 1892, when a substitute was appointed. Thenceforward he resided chiefly in London, where he died on March 15, 1897.

The detailed appreciation of Sylvester's position as an original investigator must be sought for elsewhere.* That he occupied a place in the foremost rank of the mathematicians of his generation cannot be questioned. He was endowed with great acuteness, a bright enthusiasm, and the power of sustained labour. His most notable achievements were, perhaps, those in Algebra, and in the Theory of Numbers. He witnessed the birth and powerfully contributed to the growth of the Theory of Invariants. The nomenclature of this subject is, indeed, almost entirely due to him, and he could justly claim to rank with Boole and

* See the obituary notice in *Nature*, March 25, 1897, by

Major MacMahon, F.R.S.

Cayley as one of the fathers of the "*église invariante*." His intellectual sympathies, however, were by no means narrow; his earliest paper was on Fresnel's Theory of Double Refraction, and one of the most remarkable productions of his middle life consisted in some extremely elegant additions to Poinso't's Theory of Rotation. His diction was marked by a strong individuality, and at times by a genuine eloquence. To the lay reader his characteristics are perhaps most attractively and clearly revealed in the address which he delivered to the members of the British Association in 1869. This was framed in vindication of his chosen science from some strictures which had been recently passed upon it by an eminent biologist. It was universally recognised that a great controversialist had for once met his match; but the address has a more permanent interest in that it discloses to the outer world something of the *vis motrix* of the pure mathematician. We are not without indications of the way in which such men as Gauss, Jacobi, and Henry Smith have thought of their subject, but in no case perhaps has the revelation been so complete or appealed to so wide a circle as in the present instance.

Sylvester had the satisfaction of seeing his work fully honoured both at home and abroad. From the Royal Society he received a Royal Medal in 1861 and the Copley Medal in 1880. The University of Cambridge repaired to some extent the injustice which he had suffered in his earlier years by conferring on him in later life the honorary degree of Doctor of Science; he was also made an Honorary Fellow of St. John's. Amongst innumerable foreign distinctions may be mentioned the Foreign Membership of the Institute of France, and of the Royal Academy of Berlin. He was added to our own roll of Honorary Members in 1861.

H. L.

AUGUSTE ADOLPHE LUCIEN TRÉCUL was born at Mondoubleau (Loir-et-Cher) on January 8, 1818. He studied pharmacy in Paris, and became a hospital pharmacist in

1841. About this time Trécul was attracted by the study of botany, and shortly afterwards devoted his time entirely to it. He was one of the highest authorities on vegetable organogeny, and published a large number of papers in the *Annales des Sciences Naturelles*, the *Comptes Rendus*, &c. *Treculia*, a genus of the order Artocarpeæ, was named in his honour by Decaisne. M. Trécul also occupied himself with the study of fermentations, and his conclusions, differing from those of M. Pasteur, provoked some stormy discussions at the meetings of the Académie des Sciences (1871-72). He was a Chevalier of the Legion d'Honneur, and became a member of the Académie des Sciences in March, 1896. Trécul was elected an honorary member of this Society on April 30, 1872. During nearly forty years he lived a very retired life, and died on October 17, 1896, at the age of 78.

By the death of General FRANCIS AMASA WALKER, which occurred at his home in Boston, U.S.A., on January 5, 1897, the world has lost the most distinguished, original, and attractive American writer on economics. General Walker was himself an expression of that national taste for economic science which has made provision for economic teaching essential in every American college. It is not necessary to make economics a compulsory subject in any academic curriculum in the United States; the demand for the teaching forces the subject on the attention of all academic authorities as a requirement from any student who aspires to public life. General Walker was also an expression of that freedom from doctrinal prejudice, and of that freshness of thought in the interpretation of experience, which are the natural characteristics of a great Republic whose Constitution is less the result of growth than of a deliberate attempt to create a political, economic, and social system on a scientific basis. What we are accustomed to regard as the peculiarity, not only of American humour, but of the American mental attitude generally, a certain

matter-of-fact literalness, was not wanting in Walker; he had a wide, practical, and, to some extent, hereditary familiarity with business life and public affairs, and he constantly kept his reasoning in touch with them. As a student and, eventually, a teacher of history—he was appointed Professor of History as well as of Political Economy in the Sheffield Science School of Yale College in 1873—the bent of his mind was in sympathy with that of the historical school of economists founded by the publication, in 1843, of Roscher's treatise on the historical method of economic inquiry; and, though a teacher from observation and experience, rather than a mere commentator on abstractions, Professor Walker was not second to any contemporary writer in his power of generalising and, so to speak, intellectualising his practical knowledge. The absence from his writings of anything like American mannerism is not the least of their charms; and to their academic style, not less than to their other qualities, may probably be attributed the position which they long since gained as University text-books throughout the world. Walker was an economist by descent. He was the son of Professor Amasa Walker, whose ancestors settled in Massachusetts in 1641. The elder Walker engaged in business in early life, subsequently filled various offices in the State Legislature, including that of Secretary of State, and was a strong supporter of the temperance and anti-slavery movements. He published a book on the "Nature and Uses of Money" in 1857, became lecturer on Political Economy at Amherst College, in Massachusetts, in 1861, and in 1866 published a second widely read and much quoted work, entitled "The Science of Wealth." His son, Francis Amasa Walker, was born in Boston, the centre of American literary culture, in 1840, and graduated at Amherst in 1860 on the eve of the American Civil War. During that great struggle he served as a staff officer in the Federal army, and was wounded at Chancellorsville.

It may have been to some extent merely in consequence of the influences of these early associations that the younger Walker remained an avowed member of the Republican party to the close of his life, notwithstanding the fact that, though far from being an extreme advocate of the doctrine of *laissez-faire*, but on the contrary, admitting, with Jevons, the beneficial influence in economics of State regulation in certain directions, he was certainly not in sympathy with the purely Protectionist beliefs of the Republican party. We may assume also that his personal connection with the Civil War, and, therefore, with the slavery problem which was solved by the war, and his father's anti-slavery teaching, were not without influence in directing his attention to the question of wages. It was a treatise on the "Wages Question," published in 1876, which first won for him an international reputation as an economist, and, as Professor Foxwell said on the occasion of Walker's last appearance in this country in the summer of 1896, "brought about a revolution in the opinion of the world." In this work Walker deals with wages as a question in the distribution of wealth. Amongst the most special features of the treatise are the overthrow of the "wages fund" theory, which for so long a time tyrannised over all thought on the subject; the examination of the conditions which make for the permanent degradation of labour under free competition unrestrained by the State, and in the absence of an effective mobility of labour; the demonstration of the influence of the habits of the community and of the general standard of living in promoting, on the one hand, such economic degradation or, on the other hand, the elevation of labour, and the effects on the efficiency of labour in the production of wealth; the assertion of the doctrine that wages are paid out of the product of present industry and, hence, that production, and not pre-existing capital, furnishes, in a philosophical view of the subject, the true measure of wages; the elucidation of the truth that the labourer provides a considerable portion of the capital

employed in production; and finally, the clear definition of the function of the employer as distinct from the capitalist. It is undoubtedly to the revolution in public opinion brought about by Francis Walker's "Wages Question," and to the further emancipation of thought from many of the crystallised formulæ of the merely *a priori* school of economists which it effected, that the full recognition, not only of the right but, even of the economic wisdom—within certain limits—of labour combinations, the legislation for the State protection of labour and for free education, and the general improvement in the economic *status* of the working classes during the past 20 years are very largely due. Indeed, it may be said that even the possibility of contemplating at the present day such doctrines as that of a minimum "living wage" or of an eight hours' limitation of labour, as being reconcileable in principle with a strictly scientific system of economics, and with the maximum production of wealth is due to the mental liberation effected by a book which has undoubtedly won a permanent place in the literature of economics. In his latest published work, moreover, "International Bimetallism," not the least interesting chapter is one in which Walker considers the relation between slavery and the production of the precious metals in the ancient world.

Quitting the army, in consequence of broken health, in 1865, with the rank of brigadier-general of volunteers, Francis Walker devoted his energies to Republican journalism, until, in 1869, he was appointed chief of the Bureau of Statistics at Washington. His familiarity with the statistics of industry and trade in the United States, and with the general economic position of that country, was further increased by his appointment as superintendent of the American census of 1870, an office which he again filled in 1880. In 1881 he was elected president of the Massachusetts Institute of Technology at Boston, a position which he still held at the time of his death. His "Political Economy," which has become internationally recognised as a standard

work on the science, was published in 1883. In recent years he has been perhaps best known as an advocate of an international bimetallic monetary system. His opinions on this subject were, however, far from being of recent formation. He began to write in the newspapers on money—a favourite topic of his father's—as far back as 1858, when a youth of 18, and his latest opinions were held at least co-extensively with his career as a teacher of political economy. In 1878 he attended the Paris Monetary Conference as a delegate of the American Government, and in an address to the Conference in support of bimetallism he opposed M. Feer-Herzog's prediction that a solution of the problem would be found in a natural division of the world into two great groups of nations using gold and silver respectively as money, on the ground that the dislocation of the exchanges between such groups would be attended by intolerable economic evils. He also contended that not more than three territorially extensive countries in the world could possibly maintain a single gold standard on true economic principles. In the same year he published a large treatise on "Money," consisting of the substance of lectures delivered in the Johns Hopkins University at Baltimore, in which he traced the history of monetary doctrines, and introduced the student to the literature of the subject. The book is a masterly exposition, and is characterised by an eminently fair and judicial tone. In it Walker discusses issues of paper money very fully, and supports the doctrine taught by his father that nominally, or even practically, convertible notes are liable to be issued in excess, and that "the tendency to a divergence of demand and supply leading to an over-production (of commodities) which is never fully utilised" must be "in a greater or less degree, but always with unfortunate results, aggravated by the issue of paper money not based, cent. per cent., on the money of international commerce." This book was followed in 1879 by a work entitled "Money in its relations to Trade and Industry," which is to some extent an abridg-

ment of the previous work, and consists of the substance of lectures delivered at the Lowell Institute of Boston. It does not profess to deal with the literature of the subject like the former work, but, on the other hand, it deals more fully with the relation of money to general economics. In it Walker reaffirms, with reference to fiduciary issues, the opinion that "the evils caused by even the slightest variation from the metallic standard far outweigh the saving in cost effected by reducing the specie basis, and, consequently, such money is neither good nor cheap." In his last work, "International Bimetallism," published in 1896, and consisting of the substance of lectures in the Harvard University, he remarks with reference to the earlier works mentioned: "I do not know that I have had occasion to change a single one of the opinions expressed in those volumes. The subject seems to me, as it has always seemed, a perfectly simple one if prejudice and passion are not allowed to obscure it"; and he closes the book with the statement that, though the working classes have gained through improvements in the arts and the discovery of new resources in nature since 1873, yet—as production has not increased as much as it ought to have done and would have done had it not been for the dislocation of international exchanges—they "have suffered, and have suffered greatly, from demonetisation." It may be pointed out, in conclusion, that General Walker's objections to the division of the world into silver- and gold-using States respectively have been justified by the fact that this arrangement, put forward as a "natural" solution of the problem by the monometallists in 1878, finds no advocates to-day. The closing of the Indian Mints to silver in 1893, to say nothing of the similar steps taken by Japan, Peru, Roumania, and others of the poorer nations, has demonstrated its rejection even as a theory. In the next place, notwithstanding the increased output of gold, the soundness of Walker's contention respecting the inadequacy of the supply of that metal has been proved by the practical

acceptance of the doctrine of fiduciary issues—"a gold standard with *or without* a gold currency" was Mr. Bertram Currie's pronouncement at the Brussels Monetary Conference in 1892—by the increased proportion of the fiduciary issues to the central gold reserves in Germany, France, and the United States, and by the embarrassments of the last-named Power. Such fiduciary issues are, of course, in direct opposition to the teaching of Walker. In short, whatever may be the future course of events, the facts so far illustrate the essential points of Walker's monetary conclusions, the inadequacy of gold, the evils attending fiduciary supplements whose currency is limited to the issuing country, and the desirableness of the adoption of gold and silver as the joint full-powered money of international commerce and the cent. per cent. basis of all note issues. Other works, in addition to those already mentioned, from Walker's pen, were: "The Indian Question," 1873 (he was appointed Indian Commissioner in 1871); "The World's Fair," 1876; "Land and its Rent," 1883; and "History of the Second Corps: Army of the Potomac," 1886. General Walker was elected an honorary member of the Manchester Literary and Philosophical Society in 1892, and in 1895 the University of Edinburgh conferred upon him the honorary degree of LL.D.

F. J. F.

SAMUEL COTTAM was one of a family whose members have for a hundred years or more filled prominent positions in Manchester. He was born on December 3rd, 1828, the only son of S. E. Cottam and his first wife Elizabeth. His mother, a Swedenborgian, died in his infancy, and his father, not willing either to bring him up as a mystic or to disregard what he knew to be the wishes of his dead wife, brought him up on the understanding that he should choose his faith when of age. In course of time he was baptised in 1849, and remained a Churchman to the end, and, although deaf, he attended service without fail every Sunday morning.

At an early age he succeeded his father as head of the firm S. E. Cottam & Son, chartered accountants, and carried on the business with marked ability and success. In 1858 he married Mary Southam, youngest child of John Justice Southam, physician, and leaves two children, a son a clergyman and a daughter an artist.

Mr. Cottam was elected a member of this Society on January 25, 1853. He was a man of many interests and some activity, though less active than his father. He was always interested in Science, especially in Astronomy, Botany, and Photography. Although his great deafness made conversation with him difficult, he was a clever and interesting talker, of wide reading and full of information. His accomplishments included music and several modern languages. At a time when travelling was not so general as it has now become, he had visited several European countries, but of late years he was too deeply attached to his home to travel far away from it. The few who were admitted to intimacy with him found him a steadfast friend of a kind and generous disposition. He died on September 17, 1896, and was buried in the family vault in the churchyard of St. Paul's, Kersal Moor.

THOMAS HICK was born May 5th, 1840, and died July 31st, 1896. A Yorkshireman by birth, Mr. HICK was educated at the Royal Lancasterian School at Leeds, in which institution he was made assistant master in 1861, and of which he was elected the head master from 1863 to 1873. During those years he prepared for and passed the Examinations for the degrees of Bachelor of Arts and Bachelor of Science of the University of London. He also attended classes at the Royal College of Science, South Kensington, under Professor Huxley and Thiselton-Dyer.

In 1873 he was appointed Science and Mathematical Master at the Pannal College, near Harrogate, and at the same time taught Botany and Physiology at the Mechanics' Institute in Bradford. In 1886 he was appointed Demon-

strator and Assistant Lecturer in Botany at the Owens College, a post which he held up to the time of his death.

Mr. Hick's critical faculty was as well developed as his keen power of observation, as is evidenced by his published papers, of which those on the continuity of protoplasm in seaweeds and the more numerous notes on fossil plants are his most important contributions to Botany.

On the strength of his original investigations Mr. Hick was elected an Associate to the Linnæan Society in 1894, and he became a member of the Manchester Literary and Philosophical Society in 1895.

In Mr. Hick the science of Botany loses a thorough and accurate worker, and his personal friends and acquaintances miss a hearty and congenial companion.

LIST OF PAPERS.

On Fossil Fungi from the Lower Coal Measures of Halifax and Notes on *Traguaria*. (In conjunction with W. Cash.)

Proceedings Yorkshire Geol. Soc., 1874.

The Sexual Reproduction of Fungi.

Naturalist, 1878.

Contributions to the Flora of the Lower Coal Measures of the Parish of Halifax. (In conjunction with W. Cash.)

Proceedings Yorkshire Geol. Soc., 1878.

On the Designation of certain functions of Plants.

Naturalist, 1882.

On the Caulotaxis of British Geraniums.

Journal of Botany, 1882.

Notes on *Ranunculus Ficaria*.

Journal of Botany, 1883.

On Protoplasmic Continuity in the Floridææ.

Journal of Botany, 1884.

Protoplasmic Continuity in the Fucaceæ. Part I. and Part II.

Journal of Botany, 1885.

On the Caulotaxis of British Fumariaceæ.

Journal of Botany, 1885.

Strasburger's New Investigations on the Process of Fertilisation in Phanerogams.

Naturalist, 1885.

Strasburger on Foreign Pollination.

Naturalist, 1886.

- Structure and Affinities of *Lepidodendron*. (Together with Mr. Cash.)
Proceedings Yorkshire Geol. Soc., 1889.
- The Mechanical Tissues of Plants.
Transactions Manch. Microscopical Soc., 1889.
- Ludwig Klein on the Genus *Volvox*.
Naturalist, March, 1890.
- Volvox* in Yorkshire.
Naturalist, 1891.
- Volvox*.
Transactions Manch. Microscopical Soc., 1891.
- On a New Fossil Plant from the Lower Coal Measures.
Journal of the Linnean Society, 1891.
- On the present state of our knowledge of the Yorkshire *Calamitæ*.
Proceedings Yorkshire Geol. Soc., 1891.
- The Fruit Spike of *Calamites*.
Natural Science, 1893.
- On a New Sporiferous Spike from the Lancashire Coal Measures.
Memoirs of the Manch. Lit. and Phil. Soc., 1894.
- Calamostachys Binneyana*.
Proceedings Yorkshire Geol. Soc., 1894.
- On the Primary Structure of the Stem of *Calamites*.
Memoirs of the Manch. Lit. and Phil. Soc., 1894.
- On the Structure of the Leaves of *Calamites*.
Memoirs of the Manch. Lit. and Phil. Soc., 1895.
- On *Kaloxylon Hookeri* (Will) and *Lyginodendron Oldhamium*.
Memoirs of the Manch. Lit. and Phil. Soc., 1895.
- On some Recent Advances in British Palæobotany.
Journal Yorkshire Geol. Soc., 1895.
- On *Rachiopteris cylindrica* (Will).
Memoirs of the Manch. Lit. and Phil. Soc., 1896.

F. E. W.

JAMES PARLANE was born on January 7th, 1833, in Glasgow. He was the only son of John Parlane, a well-known South American merchant, whose firm was established in the River Plate for many years, and who came to Manchester with his family in 1835. James Parlane was educated at Ferris's school in Victoria Park, where he had for his contemporaries many who afterwards became well-known citizens of Manchester. From there he proceeded to Glasgow University to complete his education. When a young man he went to Buenos Aires to his father's firm; he remained there four years, and on his

return founded the firm of Grey & Parlane, who carried on a successful business as shippers of Manchester goods to South America. Mr. Parlane retired from business in 1870, and from that time devoted himself to many public and philanthropic institutions, and to the management of several companies of which he was a director.

He acted for many years as Consul for Paraguay in this city, and took a very active interest in several of our leading hospitals, notably the Manchester Royal Eye Hospital, of which he was a member of the Board of Management for 32 years and Honorary Secretary for 23. For some years he was a governor of the Cotton Districts' Convalescent Fund.

Mr. Parlane's tastes were always literary, and he spent much time in forming a valuable collection of books and old tracts and pamphlets, which, in accordance with his wish, was dispersed after his death. He was himself the author of several very interesting pamphlets, which were printed for private circulation only; they included one on the "Scots Darien Expedition," one on "Books and Printing," and several smaller ones.

Mr. Parlane became a member of this Society in 1861, and always took a great interest in its welfare. He died on July 7, 1896.

An obituary notice of the late William Brockbank, F.G.S., will appear in the next volume.

NOTE.—The Treasurer's Accounts of the Session 1896-97, of which the following two pages (lxviii. and lxix.) are summaries, have been endorsed as follows:—

April 21st, 1897. Audited and found correct.

We have also seen, at this date, the certificates of the following Stocks, &c., held in the name of the Society, viz.: £1,225 Great Western Railway Company 5 % Consolidated Preference Stock, Nos. 12,293, 12,294, and 12,323; £258 Twenty years' loan to the Manchester Corporation, redeemable 25th March, 1914 (No. 1,564); £3,000 Gas Light and Coke Company [London], Certificate No. 47,544, Ordinary A Consolidated Stock, Transfer No. 73,627, 5th July, 1895; and also the deeds of the Natural History Fund and of the Wilde Endowment Fund, as well as the deeds conveying the land on which the Society's premises stand, and the Declaration of Trust.

(Signed)

CHARLES H. LEES.
FRANK SOUTHERN.

PHILOSOPHICAL SOCIETY.

Society, from 1st April, 1896, to 31st March, 1897.

Cr.

	£	s.	d.	£	s.	d.
1897.—March 31st :—						
By Charges on Property:						
Chief Rent (Income Tax deducted)	12	9	8			
Income Tax on Chief Rent	0	8	7			
Insurance against Fire	13	17	6			
Repairs to Building, &c.	4	8	10			
By House Expenditure:—						
Coals, Gas, Electric Light, Water, Wood, &c.	38	4	0	31	4	7
Tea, Coffee, &c., at Meetings	12	8	8			
Cleaning, Sweeping Chimneys, &c.	2	0	2½			
By Administrative Charges:—						
Housekeeper	62	8	0	52	12	10½
Postage, and Carriage of Parcels and of "Memoirs"	35	2	3			
Stationery, Cheques, Receipts, and Engrossing	9	10	3½			
Printing Circulars, Reports, &c.	16	16	1			
Legal Charges	4	11	10			
Illuminated Address to Lord Kelvin	5	5	0			
Miscellaneous Expenses.. .. .	6	10	5			
By Publishing:—						
Honorarium for Editing the "Memoirs," 1896-97	50	0	0	140	3	10½
Printing "Memoirs and Proceedings"	147	0	4			
Binding "Memoirs"	3	12	6			
Wood Engraving and Lithography (except Natural History Plates)	6	2	6			
By Wilde Endowment Fund:—						
(Items shown in the Balance Sheet of this Fund).. .. .				206	15	4
By Natural History Fund:—						
(Items shown in the Balance Sheet of this Fund)				383	12	3
By Joule Memorial Fund:—						
(No Expenditure this Session)				0	0	0
By Balance at Bank	370	4	3			
" " in Treasurer's hands	5	0	0½			
				375	4	3½

£1,227 19 1¼

FUND, 1896—1897.

	£	s.	d.	£	s.	d.
By Assistant Secretary's Salary, April 1896, to March, 1897.. .. .				120	0	0
By Maintenance of Society's Library:—						
Books and Periodicals	37	0	11			
Binding Books in Library	51	14	6			
Library Appliances	8	1	10			
By Cost of Die for Medals				96	17	3
By 2 Gold Medals				23	0	0
By Wilde Premium for Selected Memoir.. .. .				36	0	0
By Premium to Lecturer				15	15	0
By Transfers to the Society's Funds:—				15	15	0
Subscriptions of Members	13	13	0			
Entrance Fees	12	12	0			
Use of Society's Rooms	50	0	0			
By Balance, April 1st, 1897				76	5	0
				63	4	2
				<u>£446 16 5</u>		

FUND, 1896—1897.

	£	s.	d.	£	s.	d.
By Balance against, April 1st, 1896.. .. .				61	12	4
Natural History Books and Periodicals				22	18	11
Plates for Papers on Natural History in "Memoirs"				15	7	0
				<u>£99 18 3</u>		

FUND, 1896—1897.

	£	s.	d.	£	s.	d.
(No Expenditure this Session)				0	0	0
By Balance, April 1st, 1897				23	0	2
				<u>£23 0 2</u>		

**Annual Report of the Council of the Microscopical
and Natural History Section.**

The Session 1896-97 has been a successful one, due to the large number of interesting papers and exhibits submitted both by members and friends. In especial is to be noted a large collection of Arctic plants from the Franz Josef's Land Archipelago, lent by Mr. A. C. HARMSWORTH, supplemented by collections of Mr. MELVILL and Mr. ROGERS; an important paper with exhibits of certain Coal Measure Plants (*Lagenostoma*) by Mr. BUTTERWORTH, of Shaw, and collections of insects by Messrs. P. H. SCHILL and B. H. CRABTREE (*Parnassius* and Clearwings).

Two voluminous papers, with exhibits of new species of Oriental Hymenoptera, were contributed by Mr. PETER CAMERON, and a large collection of beetles was shown by Mr. C. H. SCHILL. Other papers and exhibits have been contributed by Messrs. COWARD, MELVILL, ROGERS, SCOWCROFT, STIRRUP, and HYDE.

At the commencement of the Session Mr. MARK STIRRUP, F.G.S., was elected President, and Mr. OLDHAM Treasurer, in place of Mr. BAILEY and Mr. STIRRUP. One resignation (Prof. WEISS) has been received.

The Section now consists of 16 Members: Messrs. J. J. ASHWORTH; CHARLES BAILEY, F.L.S.; J. BOYD; G. H. BROADBENT, M.R.C.S.; H. BROGDEN; A. BROWN, M.A., M.D.; ED. COWARD, J.P., M.Inst.C.E.; R. E. CUNLIFFE; H. C. DENT, F.L.S.; C. J. HEYWOOD; A. HODGKINSON, M.B., B.Sc.; W. E. HOYLE, M.A., M.Sc., M.R.C.S.; J. COSMO MELVILL, M.A., F.L.S.; F. NICHOLSON, F.Z.S.; C. H. SCHILL; M. STIRRUP, F.G.S.; and 11 Associates: Messrs. J. F. ALLEN; W. BLACKBURN, F.R.M.S.; P. CAMERON; T. A. COWARD; P. CUNLIFFE; H. HYDE; C. OLDHAM; TH. ROGERS; W. R. SCOWCROFT; T. SINGTON; J. WATSON.

Microscopical and Natural History Section Accounts. lxxi.

Chas. Oldham, Treasurer, in account with the Microscopical and Natural History Section of the Manchester Literary and Philosophical Society.

Dr.	Session 1896-97.	Cr.	
1897.—April 12th.	£ s. d.	1897.—April 12th.	£ s. d.
To Cash in hand and at Bankers,		By Books and Periodicals	13 17 7
April 9th, 1896.....	64 16 10	Tea, Coffee, &c., at Meetings	2 13 3
Bank Interest	0 10 3	Printing	5 6 6
Subscriptions and Arrears from		Sectional Subscription to Parent	
April 9th, 1896, to April 12th,		Society	5 5 0
1897	14 10 0	Petty Cash and Postages	1 15 6
		Secretary's Expenses	0 7 10
		Balance, April 12th, 1897	50 11 5
	<u>£79 17 1</u>		<u>£79 17 1</u>
1897.—April 13th.			
To Cash in hand and at Bankers	£50 11 5		

The Microscopical and Natural History Section of the Manchester Literary and Philosophical Society in account with the Parent Society, for Grant for Books from Natural History Fund.

Dr.	Session 1896-97.	Cr.	
1897.—April 12th.	£ s. d.	1896.—April 9th.	£ s. d.
To Balance due to section	28 3 9	By Balance due to Section.....	18 9 6
		"Journal de Conchyliologie,"....	0 14 3
		"Fauna und Flora des Golfes	
		von Neapel." Monographs 22	
		and 23, and Atlas 23	9 0 0
	<u>£28 3 9</u>		<u>£28 3 9</u>
		1897.—April 13th.	
		By Balance due to Section	£28 3 9

THE COUNCIL AND MEMBERS.

President.

JAMES COSMO MELVILL, M.A., F.L.S.

Vice-Presidents.

OSBORNE REYNOLDS, M.A., LL.D., F.R.S.

ARTHUR SCHUSTER, Ph.D., F.R.S., F.R.A.S.

CHARLES BAILEY, F.L.S.

W. H. JOHNSON, B.Sc.

Secretaries.

R. F. GWYTHYER, M.A.

FRANCIS JONES, F.C.S., F.R.S.E.

Treasurer.

J J. ASHWORTH.

Librarian.

W. E. HOYLE, M.A., M.Sc., M.R.C.S.

Of the Council.

HAROLD B. DIXON, M.A., F.R.S.

HORACE LAMB, M.A., F.R.S.

ALEXANDER HODGKINSON, M.B., B.Sc.

FRANCIS NICHOLSON, F.Z.S.

J. E. KING, M.A.

R. L. TAYLOR, F.C.S.

ORDINARY MEMBERS.

Date of Election.

- 1870, Dec 13. Angell, John, F.C.S., F.I.C. 6, *Beaconsfield, Derby Road, Withington.*
- 1861, Jan. 22. Anson, Rev. George Henry Greville, M.A. *Birch Rectory, Rusholme.*
- 1896, Jan. 21. Armstrong, Frank. *The Rowans, Harboro' Grove, Harboro' Road, Ashton-on-Mersey.*
- 1895, Jan. 8. Armstrong, Geo. B. *Clarendon, Sale, Cheshire.*
- 1837, Aug. 11. Ashton, Thomas, LL.D. 36, *Charlotte Street, Manchester.*
- 1887, Nov. 16. Ashworth, J. Jackson. 39, *Spring Gardens, Manchester.*
- 1865, Nov. 14. Bailey, Charles, F.L.S. *Ashfield, College Road, Whalley Range, Manchester.*
- 1888, Nov. 13. Bailey, G. H., D.Sc., Ph.D. *Owens College, Manchester.*
- 1868, Feb. 7. Bailey, Alderman Sir W. H. *Sale Hall, Sale.*
- 1835, Jan. 8. Barnes, Charles L., M.A., F.C.S. 10, *Nelson Street, Chorlton-on-Medlock.*
- 1894, Jan. 9. Beckett, J. Hampden, F.C.S. *Corbar Hall, Buxton.*
- 1896, April 14. Behrens, George B. *The Acorns, 4, Oak Drive, Fallowfield.*
- 1895, Mar. 5. Behrens, Gustav. *Holly Royde, Withington.*
- 1868, Dec. 15. Bickham, Spencer H., F.L.S. *Underdown, Ledbury.*
- 1896, April 14. Bindloss, James B. *Elm Bank, Eccles.*
- 1896, April 28. Bolton, Herbert, F.R.S.E. 94, *Dickenson Road, Rusholme.*
- 1861, Jan. 22. Bottomley, James, D.Sc., B.A., F.C.S. 220, *Lower Broughton Road, Manchester.*
- 1896, Oct. 6. Bowman, F. H., D.Sc., F.R.S.E. *Mayfield, Knutsford.*
- 1896, Feb. 18. Bowman, George, M.D. 594, *Stretford Road, Old Trafford.*
- 1875, Nov. 16. Boyd, John. *Barton House, Didsbury Park, Didsbury.*
- 1889, Oct. 15. Bradley, Nathaniel, F.C.S. *Sunnyside, Whalley Range.*
- 1894, Mar. 6. Broadbent, G. H., M.R.C.S. 8, *Ardwick Green, Manchester.*
- 1896, Nov. 17. Broderick, Lonsdale, F.C.A. *Somerby, Wilmslow.*
- 1861, April 2. Brogden, Henry, F.G.S., M.Inst.M.E. *Hale Lodge, Altrincham.*
- 1889, April 16. Brooks, Samuel Herbert. *Slade House, Levenshulme.*
- 1844, Jan. 23. Brooks, Sir William Cunliffe, Bart, M.A. *Bank, 92, King Street, Manchester.*
- 1860, Jan. 24. Brothers, Alfred, F.R.A.S. 26, *Brown Street, Manchester.*

Date of Election.

- 1886, April 6. Brown, Alfred, M.A., M.D. *Sandycroft, Higher Broughton.*
- 1846, Jan. 27. Browne, Henry, M.A. (Glas.), M.R.C.S. (Lond.), M.D. (Lond.) *The Gables, Victoria Park, Manchester.*
- 1889, Jan. 8. Brownell, T. W., F.R.A.S. 64, *Upper Brook Street, Manchester.*
- 1889, Oct. 15. Budenburg, C. F., M.Sc., M.Inst.M.E. *Bowdon Lane, Marple, Cheshire.*
- 1872, Nov. 12. Burghardt, Charles Anthony, Ph.D. 35, *Fountain Street, Manchester.*
- 1896, Nov. 3. Burke, John, B.A. *Owens College, Manchester.*
- 1894, Nov. 13. Burton, Wm., F.C.S. *The Hollies, Clifton Junction, near Manchester.*
- 1893, Jan. 10. Chadwick, W. I. 2, *St. Mary's Street, Manchester.*
- 1854, April 18. Christie, Richard Copley, M.A. *Ribsdon, near Bagshot, Surrey.*
- 1895, April 9. Claus, Wm. H. 31, *Mauldeth Road, Fallowfield.*
- 1896, April 14. Clayton-Chorlton, James. *Didsbury Priory, Didsbury.*
- 1895, April 30. Collett, Edward Pyemont. 7, *Wilbraham Road, Chorlton-cum-Hardy.*
- 1884, Nov. 4. Corbett, Joseph. *Town Hall, Salford.*
- 1895, April 30. Cornish, James Edward. *Stone House, Alderley Edge.*
- 1859, Jan. 25. Coward, Edward, Assoc.Inst.C.E., M.Inst.M.E. *Heaton House, Heaton Mersey, near Manchester.*
- 1895, Nov. 12. Crossley, Wm. J., M.Inst.M.E. *Openshaw.*
- 1896, Nov. 3. Crowther, J., A.R.S.M. *Owens College, Manchester.*
- 1876, April 18. Cunliffe, Robert Ellis. *Halton Bank, Pendleton.*
- 1853, April 19. Darbshire, Robert Dukinfield, B.A., F.S.A. *St. James' Square, Manchester.*
- 1895, April 9. Dawkins, Wm. Boyd, M.A., F.R.S., Professor of Geology. *Owens College, Manchester.*
- 1894, Mar. 6. Delépine, Sheridan, M.D., Professor of Pathology. *Owens College, Manchester.*
- 1879, Mar. 18. Dent, Hastings Charles, F.L.S., F.R.G.S. 20, *Thurloe Square, London, S.W.*
- 1887, Feb. 8. Dixon, Harold Bailey, M.A., F.R.S., Professor of Chemistry. *Owens College, Manchester.*
- 1896, Oct. 20. Drey, Oscar. *Carill Drive, Fallowfield.*
- 1883, Oct. 2. Faraday, F. J., F.L.S., F.S.S. *Ramsay Lodge, Slade Lane, Levenshulme.*

Ordinary Members.

lxxv.

Date of Election.

- 1895, April 30. Flux, A. W., M.A., Lecturer in Political Economy. 10, *Amherst Street, Fallowfield.*
- 1896, Nov. 17. Fox, Rev. Arthur W., M.A. *Albion House, The Downs, Bowdon, Cheshire.*
- 1886, Feb. 9. Gee, W. W. Haldane, B.Sc. *Technical School, Princess Street, Manchester.*
- 1896, Nov. 17. Gordon, Rev. Alexander, M.A. *Memorial Hall, Albert Square, Manchester.*
- 1881, Nov. 1. Greg, Arthur. *Eagley, near Bolton.*
- 1888, Feb. 7. Grimshaw, William. *Stoneleigh, Sale, and 75, Princess Street, Manchester.*
- 1897, Jan. 26. Grossmann, J., Ph.D. *Harpurhey Chemical Works, Harpurhey, Manchester.*
- 1892, Nov. 15. Groves, W. G. *The Larches, Alderley Edge.*
- 1875, Feb. 9. Gwyther, Reginald F., M.A., Fielden Lecturer in Mathematics. *Owens College, Manchester.*
- 1896, April 14. Harden, Arthur, M.Sc., Ph.D., Demonstrator in Chemistry. *Ashville, Upper Chorlton Road, Manchester.*
- 1896, Oct. 6. Hardie, James, M.D., F.R.C.S. 15, *St. John Street, Manchester.*
- 1890, Feb. 18. Harker, Thomas. *Brook House, Fallowfield.*
- 1895, Nov. 12. Hartog, Philippe Joseph, B.Sc., F.C.S., Demonstrator in Chemistry. *Owens College, Manchester.*
- 1873, Dec. 16. Heelis, James. 71, *Princess Street, Manchester.*
- 1890, Nov. 4. Heenan, H., M.Inst.C.E., M.Inst.M.E. *Manor House, Wilmslow Park, Wilmslow.*
- 1890, Mar. 4. Henderson, H. A. *Eastbourne House, Chorlton Road, Manchester.*
- 1896, Nov. 17. Henderson, John, B.Sc. *St. Ronans, Cavendish Road, Chorlton-cum-Hardy.*
- 1889, Jan. 8. Heywood, Charles J. *Chaseley, Pendleton.*
- 1833, April 26. Heywood, James, F.R.S., F.G.S., F.S.A. 26, *Kensington Palace Gardens, London, W.*
- 1895, Mar. 5. Hickson, S. J., M.A., D.Sc., F.R.S., Professor of Zoology. *Owens College, Manchester.*
- 1884, Jan. 8. Hodgkinson, Alexander, M.B., B.Sc. 18, *St. John Street, Manchester.*
- 1896, Nov. 3. Hopkinson, Edward, D.Sc., M.Inst.C.E. *Oakleigh, Timperley, Cheshire.*
- 1889, Oct. 15. Hoyle, William Evans, M.A., Keeper of the Manchester Museum. *Owens College, Manchester.*

Date of Election.

- 1896, Nov. 17. Jacob, Edwin. 6, *Mauldeth Road West, Withington.*
- 1870, Nov. 1. Johnson, William H., B.Sc. 26, *Lever Street, Manchester.*
- 1896, Oct. 20. Jones, A. Emrys, M.D. 10, *St. John Street, Manchester.*
- 1878, Nov. 26. Jones, Francis, F.R.S.E., F.C.S. *Manchester Grammar School.*
- 1890, Jan. 7. Joseland, H. L., M.A. *Manchester Grammar School.*
- 1891, Nov. 17. Joyce, Samuel, Electrical Engineer. *Latchford House, Greenheys Lane, Manchester.*
- 1886, Jan. 12. Kay, Thomas. *Moorfield, Stockport.*
- 1891, Dec. 1. King, John Edward, M.A., High Master. *Manchester Grammar School.*
- 1895, Nov. 12. Kirkman, W. W. *The Grange, Timberley.*
- 1893, Nov. 14. Lamb, Horace, M.A., F.R.S., Professor of Mathematics. 6, *Wilbraham Road, Fallowfield.*
- 1890, Nov. 4. Langdon, Maurice Julius, Ph.D. 15, *Dickinson Street, Manchester.*
- 1884, April 15. Leech, Daniel John, M.D., Professor of Materia Medica. *Owens College, Manchester.*
- 1895, Nov. 12. Lees, Charles Herbert, D.Sc., Demonstrator in Physics. *Owens College, Manchester.*
- 1895, Mar. 5. Levinstein, Ivan. *Wilbraham Road, Fallowfield.*
- 1895, Nov. 12. Lewkowitsch, Julius, Ph.D., F.C.S. *Lancaster Avenue, Fennel Street, Manchester.*
- 1857, Jan. 27. Longridge, Robert Bewick, M.Inst.M.E. *Yew Tree House, Tabley, Knutsford.*
- 1870, April 19. Lowe, Charles, F.C.S. *Summerfield House, Reddish, Stockport.*
- 1896, Nov. 3. Lynde, James Henry, M.Inst.C.E. *Buckland, Ashton-on-Mersey, Cheshire.*
- 1866, Nov. 13. McDougall, Arthur, B.Sc. *Fallowfield House, Fallowfield.*
- 1859, Jan. 25. Maclure, John William, M.P., F.R.G.S. *Whalley Range.*
- 1875, Jan. 26. Mann, John Dixon, M.D., F.R.C.P. (Lond.), Professor of Medical Jurisprudence. 16, *St. John Street, Manchester.*
- 1896, Oct. 20. Massey, Leonard F. *Openshaw, Manchester.*
- 1864, Nov. 1. Mather, William, M.Inst.C.E., M.Inst.M.E. *Iron Works, Salford.*
- 1895, Nov. 12. Meade, Thomas de Courcy, M.Inst.C.E., M.Inst.M.E., City Surveyor. *Town Hall, Manchester.*

Ordinary Members.

lxxvii.

Date of Election.

- 1873, Mar. 18. Melvill, James Cosmo, M.A., F.L.S. *Brook House, Prestwich.*
- 1879, Dec. 30. Millar, John Bell, M.E., Lecturer in Engineering. *Owens College, Manchester.*
- 1896, Nov. 3. Milligan, William, M.D. 337, *Oxford Road, Manchester.*
- 1881, Oct. 18. Mond, Ludwig, Ph.D., F.R.S., F.C.S. *Winnington Hall, Northwich.*
- 1894, Feb. 6. Mond, Robert, M.A., F.C.S. *Winnington Hall, Northwich.*
- 1873, Mar. 4. Nicholson, Francis, F.Z.S. 84, *Major Street, Manchester.*
- 1889, April 16. Norbury, George. *Hillside, Prestwich Park, Prestwich.*
- 1862, Dec. 30. Ogden, Samuel. 10, *Mosley Street West, Manchester.*
- 1884, April 15. Okell, Samuel, F.R.A.S. *Overley, Langham Road, Bowdon*
- 1844, April 30. Ormerod, Henry Mere, F.G.S. 5, *Clarence Street, Manchester.*
- 1892, Feb. 23. Pankhurst, Richard Marsden, LL.D. (Lond.), Barrister-at Law. *St. James' Square, Manchester.*
- 1876, Nov. 28. Parry, Thomas, F.S.S. *Grafton House, Ashton-under-Lyne.*
- 1895, Nov. 12. Pennington, James Dixon, B.A., M.Sc. 254, *Oxford Road, Manchester.*
- 1892, Nov. 15. Perkin, W. H., jun., Ph.D., F.R.S., Professor of Organic Chemistry. *Owens College, Manchester.*
- 1885, Nov. 17. Phillips, Henry Harcourt, F.C.S. 183, *Moss Lane East, Manchester.*
- 1888, Feb. 21. Réé, Alfred, Ph.D., F.C.S. *Guildhall Chambers, Lloyd Street, Manchester.*
- 1869, Nov. 16. Reynolds, Osborne, LL.D., M.A., F.R.S., M.Inst.C.E., Professor of Engineering, Owens College. *Ladybarn Road, Fallowfield.*
- 1883, April 3. Rhodes, James, F.R.C.S. *Glossop.*
- 1880, Mar. 23. Roberts, D. Lloyd, M.D., F.R.S.E., F.R.C.P. (Lond.). *Ravenswood, Broughton Park.*
- 1864, Dec. 27. Robinson, John, M.Inst.C.E., M.Inst.M.E. *Westwood Hall, Leek.*
- 1893, Mar. 21. Schill, C. H. 117, *Portland Street, Manchester.*
- 1896, Nov. 17. Schmitz, Hermann Emil, B.A., B.Sc. *Manchester Grammar School.*
- 1842, Jan. 25. Schunck, Edward, Ph.D., F.R.S., F.C.S. *Kersal.*

Date of Election.

- 1873, Nov. 18. Schuster, Arthur, Ph.D., F.R.S., F.R.A.S., Professor of Physics. *Owens College, Manchester.*
- 1895, Nov. 12. Shearer, Arthur. 36, *Demesne Road, Alexandra Park.*
- 1890, Nov. 4. Sidebotham, Edward John. *Eyresdene, Bowdon.*
- 1890, Jan. 21. Sidebotham, James Nasmyth, Assoc.M.Inst.C.E. *Parkfield Groby Place, Altrincham.*
- 1886, April 6. Simon, Henry, M.Inst.C.E., M.Inst.M.E. *Lawnhurst, Didsbury.*
- 1895, Nov. 12. Southern, Frank, B.Sc. *Burnage Lodge, Levenshulme.*
- 1896, Feb. 18. Spence, David. *Pine Ridge, Buxton.*
- 1896, April 14. Stanton, Thomas E., M.Sc. 23, *Kelvin Grove, Princes Park, Liverpool.*
- 1896, Oct. 20. Steinthal, W. P., M.Sc. 7, *Brazennose Street, Manchester.*
- 1894, Jan. 9. Stevens, Marshall, F.S.S. *Bolton Lodge, Eccles.*
- 1894, Nov. 13. Stirrup, Mark, F.G.S. *High Thorn, Stamford Road, Bowdon.*
- 1892, Nov. 29. Swindells, Rupert, M.Inst.C.E. *Wilton Villa, The Firs, Bowdon.*
- 1895, April 9. Tatton, Reginald A., Engineer to the Mersey and Irwell Joint Committee. 44, *Mosley Street, Manchester.*
- 1893, Nov. 14. Taylor, R. L., F.C.S., F.I.C. *Central School, Whitworth Street, Manchester.*
- 1873, April 15. Thomson, William, F.R.S.E., F.C.S., F.I.C. *Royal Institution, Manchester.*
- 1896, Jan. 21. Thorburn, William, M.D., B.Sc. 2, *St. Peter's Square, Manchester.*
- 1889, April 30. Thornber, Harry. *Rookfield Avenue, Sale.*
- 1896, Jan. 21. Thorp, Thomas. *Moss Bank, Whitefield, near Manchester.*
- 1897, Jan. 26. Tristram, James Floyd, M.A., B.Sc. 180, *Princess Road, Moss Side, Manchester.*
- 1895, Mar. 5. Ward, Adolphus William, LL.D., Litt.D., Principal of the Owens College. *The Hollies, Fallowfield.*
- 1879, Dec. 30. Ward, Thomas. *Wadbrook House, Northwich.*
- 1873, Nov. 18. Waters, Arthur William, F.G.S. *Sunny Lea, Davos Dorf, Switzerland.*
- 1892, Nov. 15. Weiss, F. Ernest, B.Sc., F.L.S., Professor of Botany, Owens College. 4, *Clifton Avenue, Fallowfield.*
- 1895, April 9. Whitehead, James. *Linfield, Fulshaw Park, Wilmslow.*
- 1859, Jan. 25. Wilde, Henry, F.R.S. *The Hurst, Alderley Edge.*
- 1859, April 19. Wilkinson, Thomas Read. *Vale Bank, Knutsford, Cheshire.*

Ordinary Members.

lxxix.

Date of Election.

- 1888, April 17. Williams, Sir E. Leader, M.Inst.C.E., M.Inst.M.E. *Spring Gardens, Manchester.*
- 1896, Dec. 1. Wilson, George, M.Sc. *Owens College, Manchester.*
- 1889, April 16. Wilson, Thomas B. 37, *Arcade Chambers, St. Mary's Gate, Manchester.*
- 1860, April 17. Woolley, George Stephen. *Victoria Bridge, Salford.*
- 1896, Jan. 21. Wordingham, Charles Henry, A.M.Inst.C.E., M.Inst.M.E. *Hazelhurst, Urmston Lane, Stretford.*
- 1863, Nov. 17. Worthington, Samuel Barton, M.Inst.C.E., M.Inst.M.E. *Mill Bank, Bowdon, and 37, Princess Street, Manchester.*
- 1865, Feb. 21. Worthington, Thomas, F.R.I.B.A. 46, *Brown Street, Manchester.*
- 1895, Jan. 8. Worthington, Wm. Barton, B.Sc., M.Inst.C.E. 2, *Wilton Polygon, Cheetham Hill.*
- 1896, Oct. 20. Wright, John. *Sandway, Whalley Road, Whalley Range, Manchester.*

N.B.—Of the above list the following have compounded for their subscriptions, and are therefore life members:—

- Brogden, Henry.
 Johnson, William H., B.Sc.
 Bradley, N.
 Lowe, Charles, F.C.S.
 Bailey, Charles, F.L.S.
 Worthington, Wm. Barton, B.Sc., &c.
-

HONORARY MEMBERS.

Date of Election.

- 1892, April 26. Abney, Capt. W. de Wiveleslie, C.B., R.E., F.R.S.
*Rathmore Lodge, Bolton Gardens South, S. Kensington,
London, S.W.*
- 1892, April 26. Amagat, E. H., Honorary Professor, Faculty of Sciences,
Lyons. 34, Rue St. Lambert, Paris.
- 1894, April 17. Appell, Paul, Membre de l'Institut, Professor at the
Faculty of Sciences. *Paris.*
- 1887, April 19. Armstrong, Wm. George, Lord, C.B., D.C.L., LL.D.,
F.R.S. *Newcastle-on-Tyne.*
- 1892, April 26. Ascherson, Paul F. Aug., Professor of Botany. *Berlin.*
- 1892, April 26. Baeyer, Adolf von, Professor of Chemistry, For. Mem. R.S.
1, Arcisstrasse, Munich.
- 1886, Feb. 9. Baker, Sir Benjamin, K.C.M.G., F.R.S. *2, Queen's Square
Place, Westminster, S.W.*
- 1886, Feb. 9. Baker, John Gilbert, F.R.S. *Royal Herbarium, Kew.*
- 1886, Feb. 9. Berthelot, Prof. Marcellin, For. Mem. R.S., Membre de
l'Institut. *Paris.*
- 1895, April 30. Beilstein, F., Professor of Chemistry, 8th Line, N. 17,
St. Petersburg, W.O.
- 1892, April 26. Boltzmann, Ludwig, Professor of Physics. *K. K. Univer-
sität, Vienna.*
- 1892, April 26. Brioschi, Francesco, Pres. R. Accad. dei Lincei. *4, Place
Cavour, Milan.*
- 1886, Feb. 9. Buchan, Alexander, F.R.S.E. *72, Northumberland Street,
Edinburgh.*
- 1860, April 17. Bunsen, Robert Wilhelm, Ph.D., For. Mem. R.S., Prof.
of Chemistry. *Heidelberg.*
- 1888, April 17. Cannizzaro, Stanislao, For. Mem. R.S., Prof. of Chemistry.
University of Rome.
- 1889, April 30. Carruthers, William, F.L.S., F.R.S., late Keeper of
Botanical Dept., British Museum. *Central House, Central
Hill, London, S.E.*
- 1866, Oct. 30. Clifton, Robert Bellamy, M.A., F.R.S., F.R.A.S., Prof.
of Natural Philosophy, Oxford. *New Museum, Oxford.*
- 1889, April 30. Cohn, Ferdinand, Professor of Botany. *26, Schweidnitzer
Stadtgraben, Breslau.*

Honorary Members.

lxxxii.

Date of Election.

- 1887, April 19. Cornu, Professor Alfred, For. Mem. R.S., Membre de l'Institut. *École Polytechnique, Paris.*
- 1892, April 26. Curtius, Theodor, Professor of Chemistry. *Kiel.*
- 1892, April 26. Darboux, Gaston, Membre de l'Institut, Professor at the Faculty of Sciences. 36, *Rue Gay Lussac, Paris.*
- 1886, Feb. 9. Dawson, Sir John William, C.M.G., M.A., LL.D., F.R.S., F.G.S. *McGill College, Montreal.*
- 1894, April 17. Debus, H., Ph.D., F.R.S. 1, *Obere Sophienstrasse, Cassel, Hessen, Germany.*
- 1888, April 17. Dewalque, Gustave, Professor of Geology. *University of Liège.*
- 1892, April 26. Dohrn, Dr. Anton. *Zoological Station, Naples.*
- 1892, April 26. Dyer, W. T. Thiselton, C.B., F.R.S., Director of the Royal Botanic Gardens. *Kew*
- 1892, April 26. Edison, Thomas Alva. *Orange, N.J., U.S.A.*
- 1895, April 30. Elster, Julius, Ph.D. 6, *Lessingstrasse, Wolfenbüttel.*
- 1889, April 30. Farlow, W. G., Professor of Botany. *Harvard College, Cambridge, Mass, U.S.A.*
- 1889, April 30. Flower, Sir William Henry, K.C.B., LL.D., F.R.S., Director of the British Museum (Natural History). *Cromwell Road, London, S.W.*
- 1889, April 30. Foster, Michael, M.A., M.D., LL.D., Sec. R.S., Professor of Physiology. *Trinity College, Cambridge.*
- 1860, April 6. Frankland, Sir Edward, K.C.B., Ph.D., M.D., LL.D., D.C.L., V.P.C.S., F.R.S., Corr. Mem. Inst. F.R. (Acad. Sci.), &c. *The Yews, Reigate Hill, Reigate, Surrey.*
- 1892, April 26. Friedel, Ch., D.C.L., Membre de l'Institut, Professor at the Faculty of Sciences. 9, *Rue Michelet, Paris.*
- 1892, April 26. Fürbringer, Max, Professor of Anatomy. *Jena.*
- 1892, April 26. Gegenbaur, Carl, For. Mem. R.S., Professor of Anatomy. *Heidelberg.*
- 1895, April 30. Geitel, Hans. 6, *Lessingstrasse, Wolfenbüttel.*
- 1892, April 26. Gibbs, J. Willard, Professor of Mathematical Physics, Yale University. *Newhaven, Connecticut, U.S.A.*
- 1894, April 17. Glaisher, J. W. L., D.Sc., F.R.S. *Trinity College, Cambridge.*
- 1894, April 17. Gouy, A., Professor at the Faculty of Sciences. *Lyons.*
- 1894, April 17. Guldberg, Cato, M., Professor of Applied Mathematics. *Christiania, Norway.*

Date of Election.

- 1894, April 17. Harcourt, A. G. Vernon, F.R.S. Lee's Reader in Chemistry
Christ Church. *Cowley Grange, Oxford.*
- 1894, April 17. Heaviside, Oliver, F.R.S. *Bradley View, Newton Abbot.*
- 1892, April 26. Hermite, Ch., For. Mem. R.S., Membre de l'Institut.
2, *Rue de la Sorbonne, Paris.*
- 1892, April 26. Hill, G. W. *West Nyack, N.Y., U.S.A.*
- 1888, April 17. Hittorf, Johann Wilhelm, Professor of Physics. *Polytech-
nicum, Münster.*
- 1892, April 26. Hoff, J. van't, Professor of Chemistry. *Amsterdam.*
- 1892, April 26. Hooker, Sir Joseph Dalton, F.R.S. *Sunningdale, Berks.*
- 1869, Jan. 12. Huggins, Sir William, K.C.B., LL.D., D.C.L., F.R.S.,
F.R.A.S., Corr. Mem. Inst. Fr. (Acad. Sci.) 90, *Upper
Tulse Hill, Brixton, London, S.W.*
- 1851, April 29. Kelvin, William Thomson, Lord, M.A., D.C.L., LL.D.,
F.R.S., F.R.S.E., Prof. of Nat. Phil. in Univ. of
Glasgow, For. Assoc. Inst. Fr. (Acad. Sci.) 2, *College,
Glasgow.*
- 1892, April 26. Klein, Felix, For. Mem. R.S., Professor of Mathematics.
3, *Wilhelm Weber Strasse, Göttingen.*
- 1894, April 17. Königsberger, Leo, Professor of Mathematics. *Heidelberg.*
- 1895, April 30. Lacaze-Duthiers, Henri de, Membre de l'Institut, Prof.
à la Sorbonne. 7, *Rue de l'Estrapade, Paris.*
- 1892, April 26. Ladenburg, A., Professor of Chemistry. 3, *Kaiser Wilhelm
Strasse, Breslau.*
- 1887, April 19. Langley, S. P. *Smithsonian Institution, Washington, U.S.A.*
- 1894, April 17. Lie, M. Sophus, Professor of Mathematics. *Leipsic.*
- 1892, April 26. Liebermann, C., Professor of Chemistry. 29, *Matthäi-
Kirch Strasse, Berlin.*
- 1887, April 19. Lockyer, Sir J. Norman, K.C.B., F.R.S., Corr. Mem.
Inst. Fr. (Acad. Sci.) *Science School, Kensington, London,
S.W.*
- 1889, April 30. Lubbock, Sir John, Bart., M.P., D.C.L., LL.D., F.R.S.
15, *Lombard Street, London, E.C.*
- 1892, April 26. Marshall, Alfred, Professor of Political Economy. *Balliol
Croft, Madingley Road, Cambridge.*
- 1892, April 26. Mascart, E., For. Mem. R.S., Membre de l'Institut, Pro-
fessor at the Collège de France. 176, *Rue de l'Université,
Paris.*
- 1889, April 30. Mendeléeff, D., For. Mem. R.S. *St. Petersburg.*

Honorary Members.

lxxxiii.

Date of Election.

- 1895, April 30. Mittag-Leffler, Gösta, Professor of Mathematics. *Djursholm, Stockholm.*
- 1892, April 26. Moissan, H., Membre de l'Institut, Professor at the *École Supérieure de Pharmacie. 7, Rue Vauquelin, Paris.*
- 1894, April 17. Murray, John, LL.D., D.Sc., F.R.S. *Challenger Lodge, Wardie, Edinburgh.*
- 1894, April 17. Neumayer, Professor G., Director of the Seewarte. *Hamburg.*
- 1887, April 19. Newcomb, Simon, For. Mem. R.S., Professor of Mathematics and Astronomy. *Johns Hopkins University, Baltimore, U.S.A.*
- 1894, April 17. Ostwald, W., Professor of Chemistry. *34, Brüderstrasse Leipsic.*
- 1892, April 26. Perkin, W.H., F.R.S. *The Chestnuts, Sudbury, Harrow.*
- 1894, April 17. Pfeffer, W., Professor of Botany. *Botanisches Institut, Leipsic.*
- 1851, April 29. Playfair, Lyon, Lord, K.C.B., LL.D., Ph.D., F.R.S., F.G.S., V.P.C.S., &c. *68, Onslow Gardens, London, S.W.*
- 1892, April 26. Poincaré, H., Membre de l'Institut, Professor at the Faculty of Sciences. *63, Rue Claude Bernard, Paris.*
- 1892, April 26. Quincke, G. H., Professor of Physics. For. Mem. R.S. *60, Hauptstrasse, Heidelberg.*
- 1892, April 26. Raoult, F., Dean of the Faculty of Sciences. *2, Rue des Alpes, Grenoble.*
- 1849, Jan. 23. Rawson, Robert, F.R.A.S. *Havant, Hants.*
- 1886, Feb. 9. Rayleigh, John William Strutt, Lord, M.A., D.C.L. (Oxon.), LL.D. (Univ. McGill), F.R.S., F.R.A.S. *Tirling Place, Witham, Essex.*
- 1897, April 27. Roscoe, Sir Henry Enfield, B.A., LL.D., D.C.L., F.R.S., F.C.S. *10, Bramham Gardens, Wetherby Road, London, S.W.*
- 1889, April 30. Routh, Edward John, Sc.D., F.R.S. *Newnham Cottage, Cambridge.*
- 1894, April 17. Rowland, Henry A., For. Mem. R.S., Professor of Physics. *Johns Hopkins University, Baltimore, U.S.A.*

Date of Election.

- 1872, April 30. Sachs, Julius von, Ph.D., For. Mem. R.S., Professor of Botany. *Würzburg.*
- 1889, April 30. Salmon, Rev. George, D.D., D.C.L., LL.D., F.R.S. Regius Professor of Divinity. *Provost's House, Trinity College, Dublin.*
- 1892, April 26. Salvin, Osbert, F.R.S. *Hawksfold, Fernhurst, Haslemere, Surrey.*
- 1894, April 17. Sanderson, J. S. Burdon, F.R.S., Regius Professor of Medicine. *Oxford.*
- 1892, April 26. Sharpe, R. Bowdler, LL.D. *British Museum (Natural History), Cromwell Road, London, S.W.*
- 1892, April 26. Solms, H. Graf zu, Professor of Botany. *Strassburg.*
- 1869, Dec. 14. Sorby, Henry Clifton, LL.D., F.R.S., F.G.S., &c. *Broomfield, Sheffield.*
- 1851, April 29. Stokes, Sir George Gabriel, Bart., M.A., LL.D., D.C.L., D.Sc., F.R.S., Lucasian Professor of Mathem. Univ. Cambridge, Corr. Mem. Inst. Fr. (Acad. Sci.), &c. *Lensfield Cottage, Cambridge.*
- 1894, April 17. Stone, Professor E. J., M.A., F.R.S. *Radcliffe Observatory, Oxford.*
- 1886, Feb. 9. Strasburger, Eduard, D.C.L., Professor of Botany. *Bonn.*
- 1895, April 30. Suess, Eduard, For. Mem. R.S., Professor of Geology. *9, Africanergasse, Vienna.*
- 1868, April 28. Tait, Peter Guthrie, M.A., F.R.S.E., &c., Professor of Natural Philosophy, Edinburgh. *38, George Square, Edinburgh.*
- 1895, April 30. Thomson, Joseph John, Sc.D., F.R.S., Professor of Experimental Physics. *6, Scrope Terrace, Cambridge.*
- 1894, April 17. Thorpe, T. E., Ph.D., F.R.S. *Laboratory, Somerset House, London, W.C.*
- 1894, April 17. Turner, Sir William, F.R.S., Professor of Anatomy. *Edinburgh.*
- 1886, Feb. 9. Tylor, Edward Burnett, F.R.S., D.C.L. (Oxon), LL.D. (Univ. St. And. and McGill), Keeper of University Museum. *Oxford.*
- 1894, April 17. Vines, Sidney Howard, F.R.S., Sherardian Professor of Botany. *Headington Hill, Oxford.*
- 1894, April 17. Waage, P., Professor of Chemistry. *Christiania, Norway.*
- 1894, April 17. Warburg, Professor E. *Physikalisches Institut, Neue Wilhelmstrasse, Berlin.*

Honorary Members.

lxxxv.

Date of Election.

- 1894, April 17. Ward, H. Marshall, Sc.D., F.R.S., Professor of Botany,
Cambridge.
- 1894, April 17. Weismann, August, Professor of Zoology. *Freiburg-i.-B.*
- 1892, April 26. Wiedemann, G., For. Mem. R.S., Prof. of Physics. 35,
Thalstrasse, Leipsic.
- 1889, April 30. Williamson, Alexander William, Ph.D., LL.D., F.R.S.,
Corr. Mem. Inst. Fr. (Acad. Sci.) *High Pitfold, Shotter-
mill, Haslemere, Surrey.*
- 1886, Feb. 9. Young, Charles Augustus, Professor of Astronomy. *Princeton
College, N.J., U.S.A.*
- 1888, April 17. Zirkel, Ferdinand, Professor of Mineralogy. *University of
Leipsic.*
- 1895, April 20. Zittel, Carl Alfred von, Professor of Palæontology and
Geology. *University of Munich.*
-

CORRESPONDING MEMBERS.

Date of Election.

- 1866, Jan. 23. De Caligny, Anatole, Marquis, Corr. Mem. Accad. Sc. Turin and Caen, Socc. Agr. Lyons, Sci. Cherbourg. *Liège.*
- 1850, April 30. Harley, Rev. Robert, Hon. M.A., Oxford, F.R.S., F.R.A.S., Hon. M.R.S. Queensland. *Rosslyn, Westbourne Road, Forest Hill, London, S.E., and The Athenæum Club, London, S.W.*
- 1882, Nov. 14. Herford, Rev. Brooke. 91, *Fitzjohn's Avenue, Hampstead, London, N.W.*
- 1859, Jan. 25. Le Jolis, Auguste-François, Ph.D., Archiviste-perpétuel and late President of the Soc. Nat. Sci., Cherbourg, &c. *Cherbourg.*
- 1857, Jan. 27. Lowe, Edward Joseph, F.R.S., F.R.A.S., F.G.S., Mem. Brit. Met. Soc., &c. *Shirenewton Hall, near Chepstow, Monmouthshire.*
-

*Awards of the Wilde Medal under the conditions of the
Wilde Endowment Fund.*

1896. Sir GEORGE G. STOKES, Bart.

1897. Sir WILLIAM HUGGINS, K.C.B.

*Award of the Premium under the conditions of the Wilde
Endowment Fund.*

1897. PETER CAMERON.

37 75 (40)

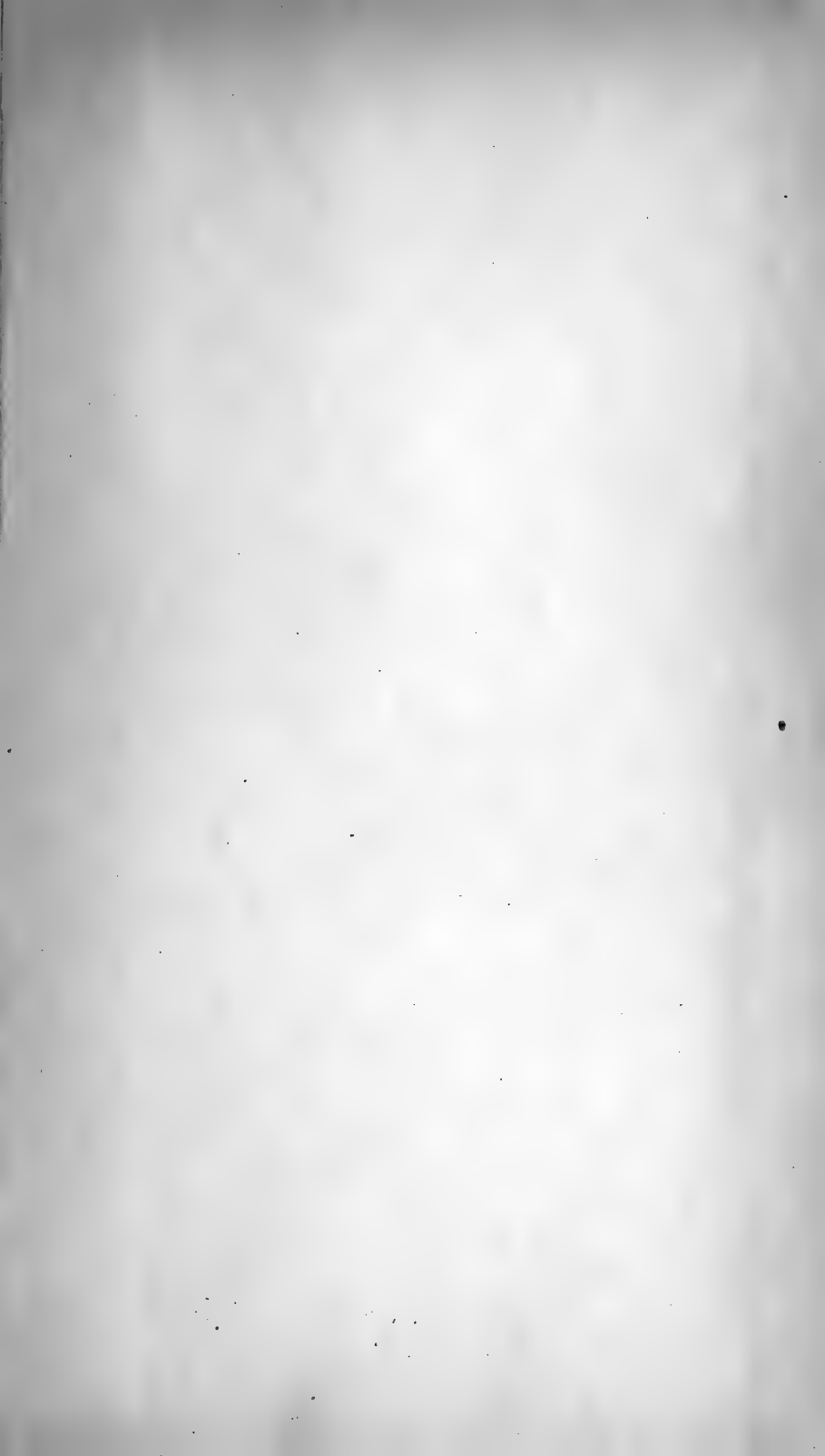



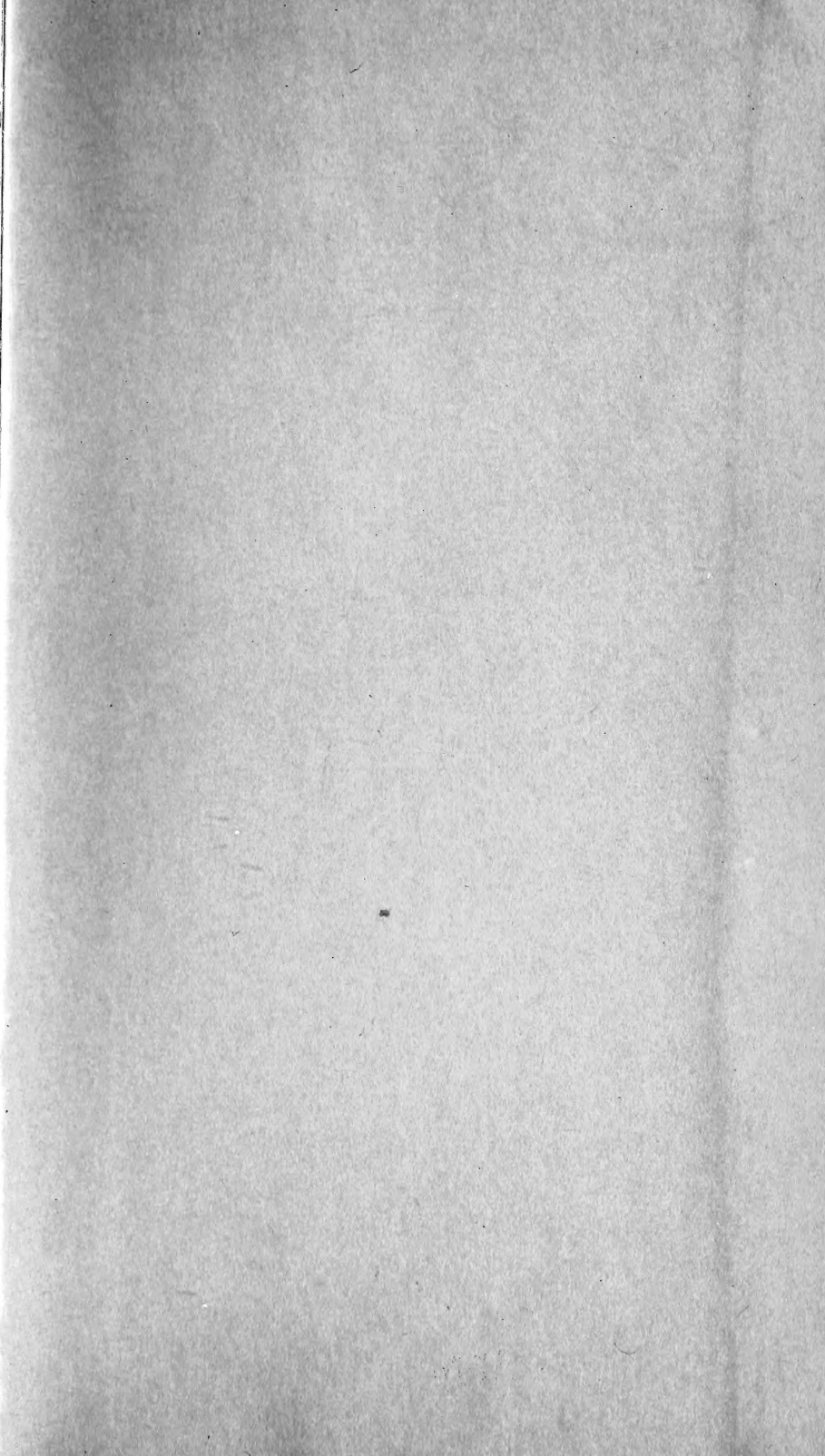





SMITHSONIAN INSTITUTION LIBRARIES



3 9088 01303 5837