



3/15/16

FOR THE PEOPLE  
FOR EDUCATION  
FOR SCIENCE

LIBRARY  
OF  
THE AMERICAN MUSEUM  
OF  
NATURAL HISTORY

Bound at  
A.M. N.H.







5,06.03.12  
MEMOIRS AND PROCEEDINGS

OF THE

MANCHESTER

LITERARY & PHILOSOPHICAL

SOCIETY.

*(MANCHESTER MEMOIRS.)*

VOLUME XLVII. (1902-1903.)

MANCHESTER:  
36, GEORGE STREET,  
1903



## NOTE.

---

The authors of the several papers contained in this volume are themselves accountable for all the statements and reasonings which they have offered. In these particulars the Society must not be considered as in any way responsible.



## CONTENTS.

### MEMOIRS.

- I. On the Reaction of Iodine with Mercuric Oxide in Presence of Water. By R. L. TAYLOR, F.C.S. . . . . pp. 1—6
- II. On the Adventitious Vegetation of the Sandhills of St. Anne's-on-the-Sea, North Lancashire (Vice-County 60). By CHARLES BAILEY, M.Sc., F.L.S. *Plates 1 to 3* . . . pp. 1—8
- III. On the Action of Alkalies on Glass and on Paraffin. By FRANCIS JONES, M.Sc., F.R.S.E., F.C.S. . . . . pp. 1—17
- IV. A Contribution to our Knowledge of the Mole (*Talpa europæa*). By LIONEL E. ADAMS, B.A. . . . . pp. 1—39
- V. Notes on some Marine Turbellaria from Torres Straits and the Pacific, with a description of new species. By F. F. LAIDLAW, B.A. . . . . pp. 1—12
- VI. The Chemical Researches of Edward Schunck, D.Sc., Ph.D., F.R.S. By W. H. PERKIN, Junr., Ph.D., F.R.S. pp. 1—8
- VII. On the Production of Polished Metallic Surfaces having the Properties of Japanese "Magic" Mirrors. By THOMAS THORP, F.R.A.S. . . . . pp. 1—5
- VIII. Parallax Determinations by Photography. By C. E. STROMEYER, M.Inst.C.E. . . . . pp. 1—4
- IX. Notes on the Type Specimen of *Loligo eblanæ*, Ball. By WILLIAM E. HOYLE, M.A., F.R.S.E. *With Plate.* pp. 1—10
- X. Report on the Plants collected by Mr. Rupert Vallentin in the Falkland Islands, 1901-1902. By J. COSMO MELVILL, M.A., F.L.S. . . . . pp. 1—8
- XI. The Atomic Theory. (The Wilde Lecture.) By Professor F. W. CLARKE, D.Sc. . . . . pp. 1—32
- XII. I. On a Higher Oxide of Cobalt. II. A Method for the Volumetric Determination of Cobalt. By R. L. TAYLOR, F.C.S. . . . . pp. 1—10

- XIII. A Factor in the Safety of High Speed Torpedo-Boat Destroyers.  
By GEORGE WILSON, D.Sc., and A. T. WESTON ... pp. 1—13
- XIV. Hymenoptera Orientalia, or Contributions to the Knowledge  
of the Hymenoptera of the Oriental Zoological Region. Part  
IX. The Hymenoptera of the Khasia Hills. Part II.  
Section 2. By P. CAMERON ... .. pp. 1—50
- XV. Further Investigation on the Detection and Approximate  
Estimation of Minute Quantities of Arsenic in Malt,  
Beer, and Food Stuffs. By WILLIAM THOMSON,  
F.R.S.E., F.I.C. *Plates 1 and 2* ... .. pp. 1—10

## PROCEEDINGS.

- ADAMSON, A., A.R.C.S.—A simple form of vernier microscope ... xi
- BAILEY, CHARLES, M.Sc., F.L.S.—Reference to the death of Dr.  
Edward Schunck ... .. xviii
- Reference to the death of Sir George Stokes, Bart. ... .. xx
- BAILEY, SIR WILLIAM II.—Exhibit of the model of the switchback  
centrifugal railway invented and made by Richard Roberts vi
- BARNES, C. L., M.A.—Experiments illustrating Hawksbee's law ... viii
- BARON, W. B., M.Sc.—The influence of hydrogen in fuel on the com-  
position of the resulting flue gases ... .. xxi
- BICKHAM, SPENCER II., F.L.S.—Exhibit of specimens of Caoutchouc xxxiii
- BROTHERS, ALFRED.—Note on Japanese 'Magic' mirrors ... .. xv
- DAWKINS, W. BOYD, M.A., D.Sc., F.R.S.—On the discovery of an  
ossiferous cavern of Pleiocene age, at Dove Holes, Buxton,  
Derbyshire .. .. xxv
- ELLISON, R. W.—Exhibit of, and remarks on, a series of eggs of the  
Common Guillemot (*Uria troile*) ... .. xi
- Notes on the breeding habits and distribution of the Common  
Buzzard (*Buco vulgaris*) in the Northern Counties of  
England. (*With a Plate.*) ... .. xxxv
- FARADAY W. BARNARD, LL.B.—Exhibit of perforated stones found  
near Kirkly Lonsdale ... .. xxxii

HOYLE, W. E., M.A., D.Sc., F.R.S.E.—Exhibit of coloured photographs prepared by the Sanger Shepherd process ..	vii
— Exhibition of lantern slides illustrating the structure of the luminous organs of a cuttle-fish ... ..	xxii
JONES, FRANCIS, M.Sc., F.R.S.E., F.C.S.—Remarks on the bending of marble ... ..	xxiii
KOLP, N.—Extract from a letter of Ottavio Pisani to Galileo written in 1614 ... ..	xxi
LEES, CHARLES H., D.Sc.—Exhibit of apparatus used in the determination of the thermal conductivities of solids over wide ranges of temperature .. ..	viii
— Exhibit of a large magic mirror ... ..	xi
— On Lummer and Gehrcke's spectrum apparatus ... ..	xxiii
MELVILL, J. COSMO, M.A., F.L.S.—Exhibit of two holograph letters of Linnæus ... ..	xxiv
— Exhibit of a Wedgwood plaque of Linnæus ... ..	xxv
— Exhibit of a holograph letter of Sir James Edward Smith ..	xxv
NICHOLSON, FRANCIS, F.Z.S.—On the arrival of our migratory birds ... ..	xxx, xxxii
— Exhibit, and presentation to the Society, of framed engraved portraits of Dr. Edward Holme and Mr. John Kennedy ...	xxxii
PINCHES, T. G., LL.D.—Hymns to Tammuz, inscribed on a tablet in the Manchester Museum, Owens College ... ..	xxx
REYNOLDS, OSBORNE, M. A., F.R.S.—Exhibit of models illustrating his mechanical theory of the structure of the universe ...	xx
SOUTHERN, FRANK, B.Sc.—Exhibit of a Japanese magic mirror ..	viii
— Exhibit of, and remarks on, two Japanese magic mirrors ...	ix
STROMEYER, C. E., M.Inst.C.E.—The growth of miniature volcanoes in boiler scale ... ..	ii
— The graphic computation of lenses ... ..	xi
THORP, THOMAS, F.R.A.S.—Remarks on the explosive property of celluloid ... ..	ii

— Exhibit of specimens of soldered aluminium	...	...	...	vi
— Exhibit, and presentation to the Society, of a cast of a Japanese magic mirror	..	...	...	xxii
— Exhibit of an apparatus for facilitating the sighting of a gun	...			xxii
WEISS, F. E., D.Sc.—Account of some of the botanical features of Western America	...	...	...	xvi
Remarks on the pollination of the primrose	...	...	...	xxxiv
General Meetings	...	...	...	i, v, xv, xix
Annual General Meeting	...	...	...	xxxiii
Special Meeting for the delivery of the Wilde Lecture	...	...	...	xxxvi
Report of Council, 1903, with obituary notices of Sir George G. Stokes, Bart., F. B. Bengier, R. E. Cunliffe, John Robinson, and Edward Schunck	...	...	...	xlii
Treasurer's Accounts	...	...	...	liv—lvi
List of the Council and Members of the Society	...	...	...	lvii
List of the Awards of the Wilde and Dalton Medals and of the Premium				lxxii
List of the Wilde Lectures	...	...	...	lxxiii



## I. On the Reaction of Iodine with Mercuric Oxide in Presence of Water.

By R. L. TAYLOR, F.C.S.

*Received and read October 7th, 1902.*

In a former paper, read in 1897 before this Society (*Memoirs*, Vol. 41, No. 8), on "Hypiodous Acid and Hypiodites," I described some experiments which I had made on the preparation of hypiodous acid by the action of iodine in presence of water on mercuric oxide. My experiments led me to the conclusion that, when an aqueous solution of iodine (1 part in 5,000) is shaken up with precipitated mercuric oxide, the reaction proceeds exactly as it does with chlorine and bromine under similar circumstances, with the production of hypiodous acid, probably according to the following equation:—

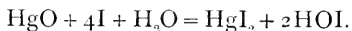

If the reaction proceeds according to this equation, one-half of the total amount of iodine employed is converted into hypiodous acid (or else a hypiodite). I found that, when the liquid was filtered immediately after shaking, the iodine present in the filtrate as hypiodous acid amounted to from 40 to 45 per cent. of that originally used,—that is, from 80 to 90 per cent. of the possible amount. I also pointed out that, using even such an excessively dilute solution as 1 part in 5,000, the hypiodous acid was extremely unstable, and that the filtrate rapidly began to turn brown, owing to the liberation of iodine. With larger amounts of iodine (in proportion to the water) the rate of decomposition was much greater—so rapid, indeed, as to make it difficult to determine the amount of hypiodous acid which the filtrate contained.

*December 15th, 1902.*

1903.

Some time after the publication of the paper above referred to, Messrs. K. J. P. Orton and W. L. Blackman described some experiments (*Journ. Chem. Soc.*, Vol. 77 (1900), p. 835) which led them to the conclusion that "the solutions obtained from iodine and mercuric oxide contain only a small quantity of hypoiodite, and that the iodine is chiefly present as iodate." The experiments by which the authors arrived at this conclusion were of such a character as to make it evident that they were not aware of the extremely unstable nature of hypoiodous acid, and that they were not acquainted with the results of my experiments. They do not mention the quantities of iodine (in proportion to the water employed) which they used, although that would have much to do with the results of the experiments. They do state, however, that they used iodine which had been finely powdered, that they shook up with water and mercuric oxide for "a few minutes" (in one case "for 15 minutes"), and that the filtering of the liquid usually took 10 minutes. Experiments extending over such a long time were not likely to be successful where a highly unstable body like hypoiodous acid was concerned. As the results thus described by Orton and Blackman were so very different from my own, I decided to make some further experiments, this time using considerably larger amounts of iodine (in proportion to the water) than I had formerly used.

In these further experiments I always used *precipitated* iodine, which is much more finely divided than that obtained by powdering, no matter how long, in a mortar. Some of the iodine used was precipitated by pouring a very strong solution of iodine in potassium iodide into excess of water, and some by adding bromine water to a solution of potassium iodide. In both cases, it is needless to say, the iodine was well washed, and that portion which

was used for the quantitative experiments was dried by long standing over strong sulphuric acid. The quantities used varied from 2 to 5 parts of iodine to 1,000 of water.

The method I employed was to shake up from 100 cc. to 150 cc. of water, containing a weighed quantity of iodine, with precipitated mercuric oxide (no definite amount). The shaking did not occupy, as a rule, more than a few seconds, and then the whole, or nearly the whole, of the liquid was thrown on to a large folded filter, so as to filter it as rapidly as possible.

The solution of hypoiodous acid obtained by using these comparatively large quantities of iodine rapidly decomposes and turns brown owing to the liberation of iodine. Indeed, it is impossible to filter the whole, or nearly the whole, of the liquid before decomposition begins. I found, however, that even with the largest amounts of iodine employed, it was possible to filter one-half of the total quantity before there was any sign of decomposition, and it was with this first half of the filtrate that all my determinations were made.

As quickly as possible, the first half of the filtrate was poured into a beaker containing a little alkali (sometimes the filtrate was allowed to run into a measured quantity of alkali, as a hypoiodite is more stable than hypoiodous acid); a little solution of potassium iodide was next added, and then a considerable amount of soda-water was run in from a syphon. (Free carbonic acid liberates iodine from a mixture of iodide and hypoiodite, but has no effect upon a mixture of iodide and iodate. The action may be represented as follows:—



The quantity of iodine liberated is manifestly twice the amount which existed in the solution as hypoiodite.)

The liberated iodine was determined by titrating with

N/10 arsenite, and allowance was of course made for the fact that only one-half of the filtrate was used, and that the iodine liberated was twice that which existed as hypoiodite. The whole of the above operations—shaking with mercuric oxide, filtering from 50 to 75 cc. of the liquid, adding alkali, potassium iodide, and soda-water—usually occupied not more than a minute and a quarter.

Using iodine in the proportions of 2, 3, 4 to 5 parts per 1,000 of water, I found that, as was to be expected, the best results were obtained with the first. In that case the iodine existing in the filtrate as hypoiodite amounted to from 44 to 52 per cent. of the total possible amount. (Compare with the 80 to 90 per cent. of the possible amount obtained with aqueous iodine.) With the larger proportions of iodine, while the filtered liquid contained, as a rule, a greater amount of iodine as hypoiodite, the percentage of the possible amount was less,—generally from 30 to 40 per cent.

After titration of the iodine liberated by soda-water, the addition of a little dilute hydrochloric or sulphuric acid to the liquid usually liberates more iodine. This is due to the *iodic acid* or *iodate* in the solution, and is produced by the interaction of iodic and hydriodic acids:—

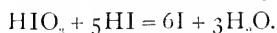

From the amount of iodine liberated in this way the quantity present in the liquid as iodate or iodic acid is easily found. This second amount of iodine was determined in the same way as the first, after neutralising the added acid with sodium hydrogen carbonate. As the result of a number of experiments I have found that, of the total iodine in the filtered liquid, the amount existing as hypoiodite (or hypoiodous acid) varied from 90 to 95 per cent., while that existing as iodic acid was never more than 10 per cent.

These results are very different indeed from those of Orton and Blackman, and the difference is entirely due to the different methods of procedure. In the first place, the iodine they used was not sufficiently finely divided. I have tried the experiment using iodine which had been powdered for a long time in a mortar, with the result that the amount of iodine in the filtrate as hypoiodite was only from 10 to 20 per cent. of the possible amount, showing that powdered iodine is not half so good as the precipitated.

In the second place, they took too long over their experiments. I have tried experiments where the shaking with the mercuric oxide was continued for varying lengths of time, up to 15 minutes, using precipitated iodine. The following Table shows the results obtained in one set of five experiments :—

No.	Time of shaking (in minutes).	Percentage of possible hypoiodite.
1	1	42
2	2	37
3	5	24
4	10	11
5	15	4

It is evident that the amount of iodine present as hypoiodite diminishes rapidly as the time of shaking with the mercuric oxide is extended.

The filtrate always contains a little mercury, which usually separates out as mercuric iodide on long standing. The mercury possibly exists at first as hypoiodite. I have made one determination of the amount of mercury

present in the filtrate as compared with the iodine present as hypoiodite, and the amount is so small that, even if all of it existed in the filtrate as hypoiodite of mercury, it would only account for one-third of the total iodine. We may therefore conclude that at least two-thirds of the iodine exists in the filtrate as hypoiodous acid.

The filtrate, when it has been allowed to stand for a considerable time, so as to become completely decomposed, illustrates remarkably well the fact, which was first pointed out by Mylius (*Ber. Deut. Chem. Ges.*, Bd. XX., p. 688) that iodine, in complete absence of hydriodic acid or a soluble iodide, gives no blue compound with starch. According to Mylius, the blue iodide of starch always contains hydriodic acid. The filtrate referred to contains free iodic acid, which would immediately decompose any hydriodic acid or soluble iodide, so that the liquid is quite free from either of those bodies; consequently, although containing free iodine, it gives no blue colour with starch. The addition of almost any salt of the alkalis will at once produce the well-known blue compound.

One can only surmise as to what course the decomposition of the hypoiodous acid solution follows when allowed to stand. In all probability some of it simply decomposes into hydriodic and iodic acids:—



Of course these two acids would immediately decompose each other (see above), with liberation of iodine, and the hydriodic acid would also decompose part of the remaining hypoiodous acid. When complete decomposition has taken place, the filtrate consists practically of a solution of free iodine and iodic acid.







## II. On the Adventitious Vegetation of the Sandhills of St. Anne's-on-the-Sea, North Lancashire (Vice-County 60).

By CHARLES BAILEY, M.Sc., F.L.S.

*Received and read October 21st, 1902.*

The shore-line north and south of St. Anne's-on-the-Sea is bounded by a series of drifted sandhills, behind which lies flat land of but slight elevation above the sea-level, and unbroken by any pronounced irregularity of surface due to hills, valleys, brooks, or dikes. There is an absence of agricultural soil upon its surface, and the sandy nature of the soil gives little expectation of yielding the rich flora which subsists upon it.

Until quite recent years the district was almost uninhabited; in a Poulton-printed book of two generations back the site of St. Anne's [the Star-hills] is thus described by the Rev. William Thornber, A.B. :—"The currents of the winds whistling among the Star-hills cannot fail to remind us, as we wander amidst their winding solitudes, of the awful moans of the 'Phantom Voice,' especially as we approach the Cross-slack" (*An historical and descriptive account of Blackpool and its Neighbourhood*," page 342, Poulton, 1837).<sup>\*</sup> Even yet St. Anne's contains no windmills or cornmills, from the refuse of which so many vegetable waifs get distributed. No local industries are in operation which are likely to lead to the introduction of foreign seeds. No ships stay on its portless shore to

<sup>\*</sup> Its author was the incumbent of Blackpool, which he describes on page 112 as a hamlet, and on pages 229 and 266 as a village. He records the census of the visitors and inhabitants of Blackpool on the 17th August, 1837, as 2,566, of which 1,856 were visitors, thus leaving 710 adults and children as the number of permanent inhabitants.

*December 15th, 1902.*

discharge the ballast which they had taken in in foreign lands. And yet its adventitious vegetation is somewhat remarkable. Excluding the escapes of cultivation—which are numerous—I confine the following remarks to the four aliens which are the special subject of this paper.

Its sandhills and waste places yield an abundant supply of one of the North American evening primroses, *Oenothera biennis*, Linn. How long this plant has been growing in the district is not known, but it has been established in other parts of the Lancashire coast for the last seventy or eighty years. Whenever the land is disturbed, or the sand removed to form new roads, this plant is one of the earliest to grow upon it, and, although its conspicuous flowers make it an easy prey for constant plucking, it survives these depredations and continues to spread more and more.

The roadsides and sandhills furnish a home for large numbers of another colonist, the *Sisymbrium pannonicum* of Jacquin, belonging to central and eastern Europe, and from western Asia to India. It is an annual plant, growing from two to three feet in height, and fruiting freely, so that it is likely to become more disseminated than at present. Compared with my last year's observation of the plant, it occupies a larger area this year, and it is extending inland. Mr. J. A. Wheldon, of Walton, tells me that it occurs about Preston, and that he has seen it this summer in the neighbourhood of the corn-elevators at Fleetwood. Its general habit may be seen from the living and dead plants now shown to the members, which were collected a day or two ago.

I have now to report the occurrence of a third alien which, though not occupying anything like the extent of ground possessed by the *Oenothera* and *Sisymbrium*, has every appearance of having been established for some

years although, so far as I know, no record of its occurrence at St. Anne's has been published. I have had it under continuous observation since March last, but was unable to give it a name, awaiting further developments. The first indication of its inflorescence appeared when I conducted the Manchester Field Club to its station at St. Anne's, on the 26th July last, when one of the members of the Club picked up a plant with an undeveloped flowering-spike. It was then seen to be a species of *Ambrosia*, very like *Ambrosia maritima*, Linn., but the foliage was scarcely hoary enough for that species; with the advance of the season and the maturity of its characters I have satisfied myself that it is a dwarf form of the American ragweed, *Ambrosia artemisiæfolia*, Linn. This plant is a great nuisance to agriculturists on the other side of the Atlantic, where it is regarded as a pernicious weed difficult to eradicate; the reason for this will be seen from what is said further on respecting its mode of growth. Besides ragweed it has received the names of Roman wormwood, hogweed, stickweed, bitterweed, stammerwort, wild tansy, and carrot-weed. It is found all over the North American continent from Nova Scotia in the north to Florida in the south, and westward to British Columbia and Mexico. It also passes over into South America, and into the West Indian Islands.

*Ambrosia artemisiæfolia* has already established itself on the European continent; I have examples of it in my herbarium from:—

- France; Loire, Saint Galmier, September, 1883.  
Leg. Frère Anthelme.  
„ Allier, Moulins, 31 August, 1883.  
Leg. A. Pérard.  
Switzerland; Zürich, Oberlikon, 23 September, 1878.  
Leg. C. Hofstetter.

Brunswick ; Steberburg,            September, 1881.

Leg. E. Krummel.

Spain ; Andalusia, Malaga,    29 August, 1889.

Leg. E. Reverchon.

Tyrol ; Innsbrück. Hölting,    29 September, 1883.

Leg. J. Murr.

It has been found in Denmark, and also as a casual in England either as a garden weed or with ballast. The late date of its flowering is remarkable in all these continental examples, and corresponds with what takes place at St. Anne's.

The genus *Ambrosia* forms a portion of a somewhat aberrant group of the Compositæ, by reason of its species possessing a superior ovary, by the absence of some portions of their floral envelopes, and by the anthers not being truly syngenesious as they are in the other groups of that natural order ; hence some systematists form the group into a separate natural order. It has a wide distribution in both hemispheres ; the larger number of species belong to North America, while the rest are found in tropical Africa and India, as well as in the countries whose shores are washed by the Mediterranean.

*Ambrosia artemisiifolia* is monœcious, both male and female flowers being found upon the same plant ; but in the St. Anne's plants a curious arrangement of the flowers at one time led me to think that the plant was diœcious, because spikes bearing conspicuous male flowers would be found growing by themselves, and other plants bearing conspicuous female flowers grew by themselves ; but a little examination disclosed the fact that the other sex was present, though in much less proportion. The great mass of the plants bore the male flowers in profusion on the upper portion of the flowering spike, while the female flowers were below in greatly reduced numbers.

Both kinds of flowers are found in little heads or buttons, which are borne on erect spikes at the terminations of the branches, and the whole plant has an aromatic odour like that of wormwood, and from its external resemblance thereto it derives its specific name. The separate flowers are tubular, there being from a dozen to sixteen male flowers in each little head; and, generally below them, little verticils separated by bracts, each verticil containing about three or four female flowers; sometimes the spikes contain pistilliferous flowers only. The male flowers have a corolla, but no calyx; their anthers are conspicuous in the throat of the corolla, and they contain an abundance of nearly spherical pollen grains bearing very short spines over their surface; an abortive pistil, consisting only of its style, rises from the centre of the five anthers of each flower. The female flowers have a calyx, but no corolla, and their most conspicuous feature is the protruding halves of their bifid style, which curve over as far down as the base of the pistil while the stigma is fresh, but after fertilisation they curl up into the shape of a bishop's crozier.

As a rule the St. Anne's plants show a tendency to produce antheriferous flowers only, but occasional patches occur in which all the flowers of the spike are pistilliferous, no staminiferous flowers occurring upon them; the accompanying *Plate 1* is photographed from a sheet of herbarium specimens in which the free portions of the spikes contain staminiferous flowers with very few pistilliferous flowers below; while *Plate 2* represents two similar examples of plants upon which there are no staminiferous flowers—these pistilliferous spikes forming less than one per cent. of the whole.

*Ambrosia artemisiæfolia* grows at St. Anne's in patches several yards in diameter, and it monopolises the rough

portions of the hollows of the sandhills, almost to the exclusion of the native vegetation in the midst of which it occurs. Although the American "Floras" describe this plant as an annual, it is only the aerial shoots which die down before winter; but there is an underground portion which ensures that new plants shall spring up the following summer, even if mature seeds be not produced. While the species may have originally started at St. Anne's, from the germination and growth of a few mature fruits brought to the locality by some unknown agency, the subsequent growths would seem to be the product of the slender stolons which proceed from the roots. These thread-like processes start at right angles from the thick portion of the root, and proceed in straight lines; they are of extreme length, many being over four feet, and I exhibit one which is rather more than three feet long taken from the ground three days ago. These hair-like stolons give off, at intervals of every few inches, upright shoots which make their way to the surface as young stems, and ultimately grow into separate plants. They are analogous to the runners of the strawberry, but instead of being found on the surface of the soil, as in that plant, they run underground. These processes are clearly seen in the herbarium specimens before the Society, and in the two plates photographed therefrom.

The fine hair-like stolons are well shown in the four or five lines from the lowermost of the three plants shown on *Plate 1*; while the left-hand example of *Plate 2* shows them at a later stage when they have become stouter, and where four or five shoots are seen rising at right angles from the stolon; the right-hand example on *Plate 2* has no connection with this stolon, the plant being laid over it to fix it to the sheet.

This account of its mode of growth explains the

circumstance of its gregariousness, and it is also an index of the persistence of the plant in its present locality. It must have been established for several years to account for the size of the patches, and it is surprising that it has not been detected and described earlier. As far as my observation has gone the species is confined to that portion of the sandhills which lies off the South Drive both to the north and to the south of St. Thomas's Church. But it is only a question of time how soon the locality will be built over, as the plot is on sale, and three of its sides already front roads or dwelling-houses. It may occur on other parts of the sandhills which I have not yet explored, such as the parts near to Fairhaven and Common Side, and the long stretch of level land which lies to the south of the Golf House ; but from the railway certain parts of the land look quite suitable for the occurrence of the plant.

It is not easy to determine in what way it has established its foot-hold at St. Anne's. The older residents inform me that at one time the site was used for hen-pens and hen-runs, similar to those which are found at the southern end of the same group of sandhills, and I hazard the conjecture that the fowls have been fed, at times, with the grain-sweepings of the docks, from Fleetwood or Liverpool, in which fruits of the *Ambrosia* have been included.

There are a number of interesting native plants associated with it on the St. Anne's sandhills, besides the ubiquitous *Salix repens*, L., and *Rubus cæsius*, L., viz. : *Reseda lutea*, L. ; *Viola Curtisii*, Forster ; *Cichorium Intybus*, L. ; *Hieracium umbellatum*, L. ; *Convolvulus arvensis*, L. ; *Echium vulgare*, L. ; *Bartsia viscosa*, L. ; *Thymus Serpyllum*, Fr. ; *Polygonum Convolvulus*, L., &c. But there are several others growing with the *Ambrosia*

which, though native plants, may have been introduced in the same way, viz.: *Lepidium rudera*l, L. ; *Lactuca virosa*, L. ; and *Marrubium vulgare*, L., the first and last of which I have also found in other localities in the neighbourhood.

Besides these species there is a fourth alien which may have been established as long as the *Ambrosia*, but of which I have met with but three or four flowering examples of what I take to be *Vicia villosa*, Roth, and probably Koch's variety *glabrescens* of that species = *V. dasycarpa*, Ten. It is allied to the purple-tufted vetch (*V. Cracca*, L.) but with fewer flowers in the spike, more separated one from the other and much less pendent. In the dried state in which it appears in the herbarium example now before the members, and of which *Plate 3* is a photographic reproduction, the handsome spikes of flowers are of a dark royal blue colour, but in their living state on the sandhills they are of a rich claret colour unlike that of any of our native vetches. The flower spikes do not show up very well on the plate compared with their appearance on the herbarium sheet to which they are affixed, but they may be identified from the leaves by their much longer stalks and by the absence of the prehensile tendrils which are so characteristic of the upper part of the leaves. The handsome flowers are sure to be gathered almost as soon as they are produced, as the locality is a favourite resort for children ; certainly none of the flowers reached the fruiting stage this season.

*Vicia villosa*, Roth, is native in all European countries except Great Britain, and the present is probably the first record of its occurrence in this country. There is no antecedent reason why it should not be native here, but its occurrence with the other aliens named is against its being considered aboriginal.





## EXPLANATIONS OF PLATES.

*Plate I.* Adult examples of *Ambrosia artemisiifolia*, Linn., in which the flowering spikes contain antheriferous flowers, almost to the exclusion of pistilliferous flowers. (See p. 5.)

The long slender processes, from which new plants originate, are shown in the four horizontal stolons of the lowermost plant; several other stolons are also seen hanging from the base of the stems of the three plants on the sheet. (See p. 6.)

*Plate II.* Adult examples of *Ambrosia artemisiifolia*, Linn., in which the flowering spikes contain pistilliferous flowers, to the exclusion of all antheriferous flowers— even at the tip of the inflorescence. The flowers extend for an inch and a half down the inflorescence of the left-hand plant, and for three inches on the right-hand plant, the flowers lying in the axils of the spreading bracts which separate each verticil. (See p. 5.)

The left-hand example has a stolon of older growth than any of those shown in *Plate I.*: this stolon is twenty inches long and extended much further in the ground but broke off when being removed therefrom: the portion attached to the plant shows five upward growths which would have formed new plants in the following year. (See p. 6.) The right-hand example has no organic connection with this stolon: it merely lies over it on the sheet.

*Plate III.* Flowering example of *Vicia villosa*, Roth, bearing ten flowering spikes not all equally developed. In the growing state the flowers are of a full claret colour, the standard and wings showing no contrasts in colour. The plant has not been observed in fruit this season. (See p. 8.)

---

All three plates photographed from herbarium specimens derived from the sandhills near St. Thomas's Church, St. Anne's-on-the-Sea, Lancashire. In the living state the plants were  $2\frac{1}{2}$  times the size of their representations on the plates.



*Ambrosia artemisiifolia*, L.  
with the inflorescence mainly stamiferous;

Locality : In rough places in the sandhills off  
St. Thomas's Road, St. Anne's-on-the-Sea.  
County : West Lancashire, England.  
Top Botany : Vice-Co. 60 West Lancaster.  
Coll : Charles Bailey 23rd August, 1902.



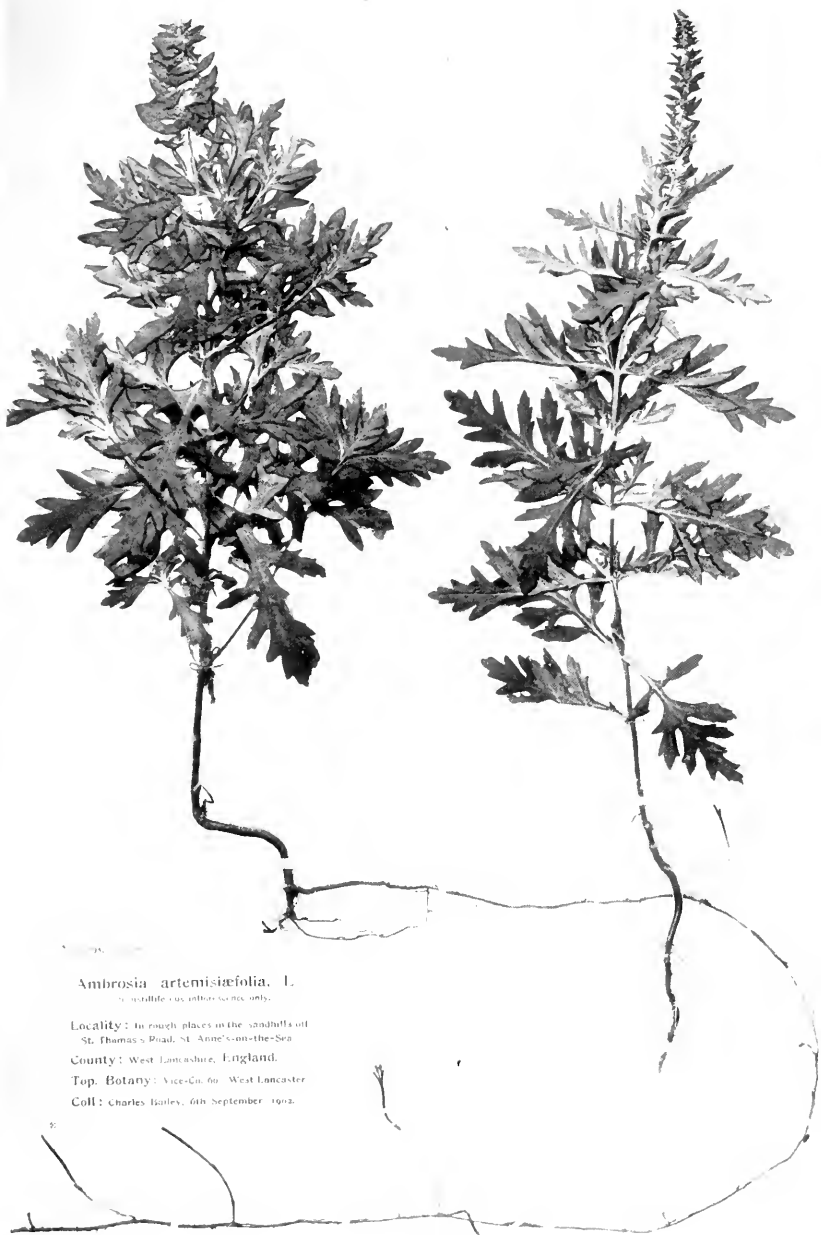

*Ambrosia artemisiifolia*, L.

*in wild life & in cultivated gardens only.*

Locality: In rough places in the sandhills off  
St. Thomas's Road, St. Anne's-on-the-Sea

County: West Lancashire, England.

Top. Botany: Vice-Ga. 66 West Lancaster

Coll: Charles Bailey, 6th September 1902.





No. 3964 L.

*Vicia villosa*. Roth

Locality: Sandhills ne St Thomas's Church, St. Anne's-on-the-Sea

County: West Lancashire, England.

Top. Botany: Vice-Co. 6n West Lancaster.

Coll: Charles Bailey, 23rd August 1902.





### III. On the Action of Alkalies on Glass and on Paraffin.

By FRANCIS JONES, M.Sc., F.R.S.E., F.C.S.

*Received and read November 4th, 1902.*

#### **Action on Glass.**

Many investigations have been made on the action of water and of alkalies on glass, both at the ordinary temperature and with boiling solutions, and there is a general agreement that the glass is acted on sooner or later by water, and still more by alkaline solutions. Recently the subject has received much attention, owing to the extensive use of a test for determining the amount of carbon dioxide in air, which involves the use of alkaline solutions in contact with glass vessels. The method was originally proposed by Dalton\* in a paper read before this Society in 1802, and has since been modified and improved. Dalton used a bottle of about seven litres capacity, filled it with rain water, and, by emptying this out, obtained a specimen of the air he wished to examine. In this bottle he then placed some lime water of known strength, and, after a certain lapse of time, estimated the diminution of alkalinity by means of dilute sulphuric acid, also of known strength. From this he calculated the amount of carbon dioxide which had been removed from the air. Hadfield,† a pupil of Dalton's, improved the process (1828-30) by filling the bottle with air by means of a bellows pipe and another pupil, H. H. Watson,‡ also improved the process in 1834.

\* *Manchester Memoirs*, Ser. 2, Vol. I. (1805), p. 244.

† *Ibid.*, 1842, p. 10.

‡ *Brit. Assoc. Reports*, 3 (1834), p. 583.

*December 15th, 1902.*

The method is now generally attributed to Pettenkofer,\* who in 1858 described a process identical in principle with Dalton's. Pettenkofer, who appears to have had no knowledge of Dalton's work, employed a special form of bellows, used lime water to absorb the carbon dioxide, and estimated the excess by means of standard oxalic acid, using turmeric paper as indicator. Subsequently he substituted baryta for lime water. Both these methods involve contact for some time between the glass bottle and the alkaline liquid, and it is obvious that if the latter diminishes in strength owing to its action on glass, the accuracy of the carbon dioxide determination must be interfered with.

On this point there is considerable difference among chemists who have used the method, some affirming that the action is immaterial, others, that it greatly affects the accuracy of the method. Thus, Reiset† states that the glass is attacked, but that the titre of the solutions is not affected, and Dr. T. E. Thorpe informs me that he "has records of the titre (taken once a week) of baryta solutions which have been standing in stock bottles for upwards of two years, which show absolutely no indication of such a loss of alkalinity as is made out." On the other hand, Spring‡ maintains that the glass is attacked and that the strength of the baryta diminishes. Ebermeyer§ states that baryta is removed from the solution and combines with the silica of the glass, and Messrs. Letts and Blake,|| in an elaborate and important memoir, point out that the action on glass is so serious that it is necessary to use vessels coated with

\* *Chem. Soc. Journal*, 10 (1858), p. 292.

† *Annales de Chimie et de Phys.* [5] 26 (1852), p. 175.

‡ *Mém. Acad. roy. Belgique*, t. 37, p. 73.

§ *Die Beschaffenheit der Waldluft*, Stuttgart, 1885.

|| *Proc. Roy. Dublin Soc.*, Vol. IX. (N.S.), Part II., No. 15.

paraffin wax to protect the glass from the action of the alkaline solution.

As I had employed Pettenkofer's method for a long series of determinations of carbon dioxide in air,\* in which unprotected glass vessels were used, I thought it worth while to re-investigate the subject, and endeavour to settle the disputed point.

That glass, exposed for a long time to the action of baryta, is acted on, cannot be doubted. I possess a flask in which baryta water was kept for at least fifteen years, which has, to a great extent, lost its transparency, while its original smooth surface is roughened. The question at issue, therefore, is not whether glass is attacked by baryta water, but whether, in the short period required for a Pettenkofer test, there is any loss in strength of the baryta solution which can affect the determination of carbon dioxide.

In my first experiments lime and baryta water alone were used and their action tested, not only on the bottles but also on finely divided silica and on powdered glass. Three bottles of green glass (such as "Winchester" quarts are usually made of) of 350 c.c. capacity were thoroughly cleaned, rinsed with clear lime water of known strength, and then half filled with the solution. To the first, nothing else was added, to the second, 0.1 gramme of finely divided silica, and to the third, 1 gramme of powdered glass of the same quality as the bottles used. A similar set of three bottles was prepared, but containing baryta instead of lime water. After standing a week, with occasional shaking, 10 c.c. of the clear liquid from each bottle were removed by means of a pipette, and titrated with half deci-normal hydrochloric acid. Phenol-phthalein was used as indicator. The tests were repeated at intervals, and the results are recorded in the following table :—

\* *The Air of Rooms*, Taylor, Garnett, Evans & Co., Manchester.

TABLE A. FIRST SERIES.  
Lime Water.

1900-1901.	Volume of Lime Water used.	Bottle.	+0.1 gr. Silica.	+1 gr. powd. glass.
	c.c.	c.c.	c.c.	c.c.
Nov. 2 ...	10	9.30 <sup>*</sup>	9.30 <sup>*</sup>	9.30 <sup>*</sup>
.. 9 ...	10	9.30	8.75	9.35
.. 16 ...	10	9.22	7.55	9.10
.. 23 ...	10	9.10	6.70	9.00
Dec. 10 ...	10	8.95	5.60	8.80
Jan. 17 ...	10	8.80	5.20	8.40 <sup>†</sup>
Mar. 11 ...	10	8.50	4.80	7.80
.. 26 ...	10	8.30	4.75	7.30
Apr. 15 ...	10	8.10	4.60	7.10

\* Strength at starting.

† Flocculent precipitate noticed floating above powdered glass.

Baryta Water.

1900-1901.	Volume of Baryta Water used.	Bottle.	+0.1 gr. Silica.	+1 gr. powd. glass.
	c.c.	c.c.	c.c.	c.c.
Nov. 2 ...	10	5.10*	5.10*	5.10*
„ 9 ...	10	5.10	4.90	5.00
„ 16 ...	10	5.00	4.70	4.85
„ 23 ...	10	4.95	4.60	4.65
Dec. 10 ...	10	4.90	4.55	4.60
Jan. 17 ...	10	4.90	4.60	4.40
Mar. 11 ...	10	5.00	4.60	4.00
„ 26 ...	10	5.00	4.55	3.85
Apr. 15 ...	10	5.05	4.50	3.45

These experiments, being made with alkaline solutions of very different strengths, cannot be readily compared, but they indicate clearly (*a*) that lime water in contact only with the glass of the bottle loses strength much more rapidly than baryta water in the same circumstances, and (*b*) that lime water combines with silica more rapidly than baryta water. Further, it was noticed on January 17th, after ten weeks contact, that the precipitate in the lime water bottle containing powdered glass was very bulky and flocculent as compared with the corresponding baryta bottle.

In the next series of experiments alkaline solutions were used of practically the same strength, and the

\* Strength at starting.

quantity of silica was raised to one gramme. Some experiments were made with strontia water, but as they were not commenced at the same time as the others, they are not conveniently comparable.

TABLE B. SECOND SERIES.

**Lime Water.**

1901-1902.	Volume of Lime Water used.	Bottle.	+ 1 gr. Silica.	+ 1 gr. powd. glass.
	c.c.	c.c.	c.c.	c.c.
Mar. 27 ..	10	9'45*	9'45*	9'45*
„ 28 ...	10	9 45	7'70	9'55
„ 29 ...	10	9'40	—	9'55
Apr. 11 ...	10	9'50	5'15	9'50
„ 25 ...	10	9'50	0'70	9'55
May 3 ...	10	9'40	0'60	9'50
„ 16 ...	10	9'40	0'60	9'40
„ 23 ...	10	9'40	0'55	9'40
June 13 ..	10	9'35	0'52	8'80
„ 24 ..	10	9'35	0'50	8'40
July 4 ..	10	9'20	0'50	7'80
Nov. 25 ..	10	8'70	0'45	3'85
Jan. 16 ...	10	8'55	0'50	3'80
Feb. 27 ...	10	8'35	0'50	Liquid used up

\* Strength at starting.

**Strontia Water.**

1901-1902.	Volume of Strontia Water used.	Bottle.	+ 1 gr. Silica.	+ 1 gr. powd. glass.
	c.c.	c.c.	c.c.	c.c.
June 13 ..	10	9'55*	9'55*	9'55*
„ 14 ..	10	9'55	7'35	9'55
„ 17 ..	20	9'55	7'20	9'60
„ 21 ..	10	9'50	7'00	9'50
„ 24 ..	10	9'55	6'90	9'50
July 4 ..	10	9'50	6'60	9'50
Nov. 25 ..	10	9'50	4'65	9'25
Jan. 16 ..	10	9'55	4'30	Liquid used up
Feb. 27 ..	10	9'30	4'00	

\* Strength at starting.

**Baryta Water.**

1901-1902.	Volume of Baryta Water used.	Bottle.	+ 1 gr. Silica.	+ 1 gr. powd. glass.
	c.c.	c.c.	c.c.	c.c.
Mar. 27 ...	10	9'00 <sup>20</sup>	9'00 <sup>3</sup>	9'00*
„ 28 ...	10	9'00	8'65	9'10
„ 29 ...	10	8'95	8'40	9'10
Apr. 11 ...	10	8'95	8'35	9'10
„ 25 ...	10	9'00	8'10	9'05
May 3 ...	10	9'00	8'00	9'05
„ 16 ...	10	9'00	7'90	9'05
„ 23 ...	10	8'95	7'90	9'05
June 13 ..	10	9'00	7'70	9'05
„ 24 ..	10	9'00	7'70	9'00
July 4 ...	10	8'95	7'60	9'00
Nov. 25 ...	10	8'95	6'90	9'00
Jan. 16 ..	10	9'00	6'90	8'90
Feb. 27 ...	10	9'00	6'80	Liquid used up

These experiments confirm the previous results. They were carried on for nearly double the time—six months in the first and eleven months in the second series—and it will be noticed that the silica (increased from 0·1 to 1 gramme) had nearly neutralised the lime water completely. The strontia water in the glass bottle maintained its strength remarkably well, and did not act nearly so energetically either on the silica or the powdered

\* Strength at starting.



glass. In the case of the baryta water, the strength in the glass bottle remained still more constant, and was absolutely the same at the end of eleven months, while the action on silica was less than with either of the other alkalies, and in the case of the powdered glass, the strength had only fallen 0·1 of a cubic centimetre.

The third series of experiments was an exact repetition of the second, and confirms the results in every respect. In some cases it will be noticed that the strength of the alkaline liquid in contact with powdered glass is *increased* at the beginning of the experiment. This is no doubt due to the fact that powdered glass has an alkaline reaction. It can be detected with reddened litmus, but is much more readily shown by the exceedingly sensitive reagent phenol-phthalein.

TABLE C. THIRD SERIES.

Lime Water.

1902.	Volume of Lime Water used.	Bottle.	- 1 gr. Silica.	+ 1 gr. powd. glass.
	c.c.	c.c.	c.c.	c.c.
Feb. 27 ...	10	9·45*	9·45*	9·45*
„ 28 ..	10	9·45	6·30	9·35
Mar. 6 ...	10	9·35	5·35	9·30
Apr. 10 ..	10	9·30	0·75	9·30
May 15 ...	10	9·15	0·60	8·50
July 24 ..	10	9·05	0·60	4·20
Sept. 18 ..	10	8·90	0·60	3·80
Oct. 6 ...	10	8·80	0·60	3·55

\* Strength at starting.

**Strontia Water.**

1902.	Volume of Strontia Water used.	Bottle.	+ 1 gr. Silica.	+ 1 gr. powd. glass.
	c.c.	c.c.	c.c.	c.c.
Feb. 27 ...	10	9'45	9'45*	9'45*
„ 28 ...	10	9'45	7'10	9'30
Mar. 6 ...	10	9'35	6'95	9'30
Apr. 10 ..	10	9'45	6 60	9'35
May 15 ..	10	9'40	6 10	9'30
July 24 ...	10	9'50	5'30	9'10
Sept. 18 ..	10	9'50	4'95	9'05
Oct. 6 ..	10	9'50	4'80	8'95

**Baryta Water.**

1902.	Volume of Baryta Water used.	Bottle.	+ 1 gr. Silica.	+ 1 gr. powd. glass.
	c.c.	c.c.	c.c.	c.c.
Feb. 27 ...	10	9'15*	9'15*	9'15*
„ 28 ..	10	9'15	7'05	8'9
Mar. 6 ..	10	9'15	7'00	8'95
Apr 10 ...	10	9'10	6'70	8'95
May 15 ...	10	9'10	6'45	8'95
July 24 ...	10	9'15	6'12	9'10
Sept. 18 ..	10	9'10	6'05	9'20
Oct. 6 ..	10	9'15	5'95	9'10

\* Strength at starting.

In all the experiments in which lime water was in contact with powdered glass, the very bulky and flocculent precipitate resulting was very noticeable after six or eight weeks contact, still more after very prolonged contact. A similar precipitate is noticeable, but not nearly so distinctly, when strontia and baryta solutions are left in contact with powdered glass. *Fig. 1* shows the appearance of three flasks containing lime, strontia, and baryta water respectively, in contact with powdered glass for a period of nine months. Unaltered powdered glass is seen both in the

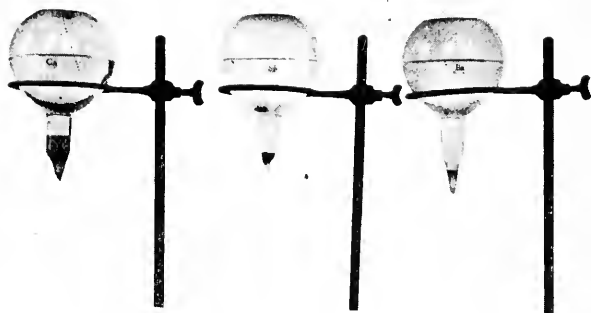

*Fig. 1.*

strontia and baryta water flasks, but in the case of the lime water flask the action went on so completely that no particles of glass appeared to remain, although in the early stages the powdered glass is easily distinguished from the flocculent precipitate by its greater density and shining appearance. The precipitate cannot be expected to be very definite in composition, but a quantity was obtained for analysis, separated as completely as possible from the powdered glass and thoroughly washed. It was dried at  $120^{\circ}\text{C}$ ., and then appeared as a nearly white powder, easily

fusible in the Bunsen flame, which was tinged bright yellow. On analysis it was found to contain silica 65.74, alumina and iron 3.26, and lime 14.11 per cent. There was also combined water. On reviewing these results it appears clear that none of the three alkaline solutions experimented on exerts any appreciable action on glass bottles in the first few hours, and it seems therefore difficult to

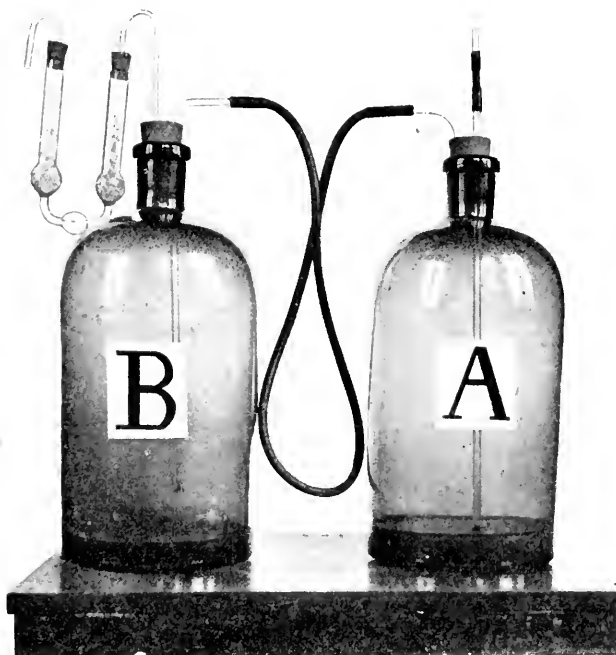

*Fig. 2.*

believe that the accuracy of the Pettenkofer test for carbon dioxide can be appreciably affected by the use of any one of them.

On prolonged contact in a glass bottle there is a marked action in the case of lime water, but not in the case of the two other alkaline solutions, which lose very little of their alkalinity even when in contact with powdered

glass. When more dilute solutions of baryta water were employed, the action on powdered glass was distinct, but this has no bearing on the Pettenkofer test. Solutions of all three alkaline earths acted on silica, lime to the greatest extent and baryta least, strontia, as in so many of its reactions, standing mid-way between lime and baryta.

It may be objected that the preceding experiments, carried on in bottles of small capacity, cannot be fairly compared with those carried on in the large bottles required for the Pettenkofer test. To settle this point the following experiment was made. Baryta water was placed in a large bottle (A), *Fig. 2*, such as is commonly, used for the test, it was closed with a doubly bored india rubber stopper, through which passed two tubes, one leading below to the baryta water (the upper end being closed with a cap), and the other terminating just below the stopper. This shorter tube was connected by india rubber tubing with a second large bottle (B) containing potash solution, and the exit was connected with a U tube, also containing potash, so that the air in this bottle was kept free from carbon dioxide. After standing 24 hours, 10 c.c. of the baryta in A were withdrawn by means of a pipette, the cap immediately replaced and the solution titrated. The tests were repeated at intervals during twenty months. When started on 13th March, 1901, 10 c.c. of the baryta required 13.6 c.c. of the half deci-normal hydrochloric acid, and on October 31st, 1902, 10 c.c. of the baryta required 13.45 c.c. of the acid, a very trifling difference after such a prolonged contact. I ought to add that on two occasions, for which it is difficult to account, the strength diminished so that only 13.2 c.c. of the acid were required, but after that it rose again, and on April 25th was of the same strength as when started. The details are given in the subjoined table.

TABLE D.

## Action of Baryta Solution on Glass.

1901-1902.	Volume of Baryta used.	Acid required.
	c.c.	c.c.
Mar. 13 ... ..	10	13'60
„ 14 ... ..	10	13'60
„ 15 ... ..	10	13'20
„ 18 ... ..	10	13'50
„ 19 ... ..	10	13'52
„ 20 ... ..	10	13'55
„ 25 .. ...	10	13'55
April 11 ... ..	10	13'60
„ 25 ... ..	10	13'60
May 16 ... ..	10	13'55
„ 23 ... ..	10	13'50
June 13 .. ...	10	13'45
Nov. 25 .. ...	10	13'30
Jan. 14 ... ..	10	13'20
Feb. 6 ... ..	10	13'40
„ 7 ... ..	10	13'30
May 1 ... ..	10	13'40
„ 15 ... ..	10	13'40
June 5 ... ..	10	13'50
July 16 ... ..	10	13'35
Sept. 15 ... ..	10	13'50
Oct. 23 ... ..	10	13'45
„ 31 ... ..	10	13'45

### **Action on Paraffin Wax.**

I now proceed to describe some experiments made to determine whether or not the alkaline solutions have any action upon paraffin, which, as already stated, has been suggested by Messrs. Letts and Blake as a suitable substance with which to coat the inner surface of the test bottles, and so protect the baryta solution from contact with glass. Two similar bottles were used for this purpose, one of which was coated internally with paraffin,\* the other was unprotected. Each was rinsed with the same baryta solution, and then half filled with it, and the contents of each bottle at once titrated. 10 c.c. of each required 9.1 c.c. of the standard acid. After standing 24 hours the solutions were again tested, and 10 c.c. of each required 8.95 c.c. of standard acid. After 18 days the solutions were slightly weaker, but still of the same strength. In eleven weeks there was a marked difference, 10 c.c. of the baryta in the unprotected bottle required 8.5 c.c. of acid, while the baryta in the paraffined bottle required only 6.95 c.c. In four months, when the liquids in each bottle were exhausted, the unprotected bottle required 8.25 c.c., and in the paraffined bottle only 5.0 c.c. of the acid solution.

In the appendix to Messrs. Letts and Blake's paper, it is stated that after 40 days' contact with baryta water in a paraffined bottle, the baryta solution suffered an almost inappreciable loss in strength. It amounted to 0.37 per cent. In my experiments I find that in a similar test the loss amounted in 18 days to 4.39 per cent. In Table E the complete results are given.

\*Known commercially as "paraffin wax." The specimen used melted at 52.7° C.

TABLE E.  
Action of Baryta Solution on Paraffin Wax.

1902.	Volume of Baryta used.	Acid required.	
		Unprotected bottle.	Paraffined bottle.
	c.c.	c.c.	c.c.
Feb. 6 .....	10	9·10*	9·10*
„ 7 .....	10	8·95	8·95
„ 10 .....	10	8·75	8·95
„ 14 .....	10	8·70	8·85
„ 24 .....	10	8·70	8·70
Apr. 25 .....	10	8·55	6·95
May 14 .....	10	8·30	5·40
June 5 .....	10	8·25	5·00

It is evident from these experiments that the action of baryta water on paraffin does not begin for some time, but ultimately the action is considerable, so that while a paraffined bottle may be safely used for the Pettenkofer test, the storage of standard baryta solution in paraffined bottles is quite inadmissible.

The next set of experiments shows the action of lime, strontia, and baryta water in similar circumstances on paraffin shavings, which were used to increase the surface of paraffin exposed to the alkaline solutions. Two grammes were added to each bottle. The results given in Table F show that, while all three solutions act on paraffin, the baryta acts far more energetically than either of the others, and indeed its alkalinity had all but disappeared after five months' contact.

\* Strength at starting.



What the nature of the reaction is has not yet been determined, but the residue in the baryta water bottle on October 16th, consisting of a little liquid and the paraffin shavings, was examined in the following way: the liquid was poured off, filtered into a platinum basin, and evaporated to dryness on the water bath. The residue was ignited but did not char. The paraffin shavings remaining in the bottle were washed repeatedly by decantation, transferred to a platinum basin, and heated till all water was expelled. The remaining paraffin was then burned off and a small amount of a white residue remained, in which barium was easily detected. These results indicate that no soluble compound derived from the paraffin is formed, but that the barium unites with the paraffin in some way yielding a compound insoluble in water.

TABLE F.

**Action of Alkaline Solutions on Paraffin Shavings.**

1902.	Volume of Alkali used.	Acid required.		
		Lime Water.	Strontia Water.	Baryta Water.
	c.c.	c.c.	c.c.	c.c.
May 9 ...	10	8·90*	9·00*	9·30*
„ 9 ...	10	8·80†	8·95†	9·25†
„ 15 ...	10	8·70	9·00	8·85
June 5 ...	10	8·40	8·60	6·25
„ 13 ...	10	8·35	8·35	5·60
„ 30 ...	10	8·25	8·30	5·40
July 23 ...	10	8·10	8·25	3·20
Sept. 15 ..	10	7·50	7·25	1·80
Oct. 16 ...	10	6·90	6·25	0·10

\* Before adding paraffin.

† After adding paraffin.



#### IV. A Contribution to our Knowledge of the Mole (*Talpa europæa*).

By LIONEL E. ADAMS, B.A.

(*Communicated by W. E. Hoyle, M.A., F.R.S.E.*)

*Received November 11th. Read November 18th, 1902.*

Perhaps the habits of no land quadruped are so difficult to observe as those of the mole. Since the time of Le Court, very few people seem to have attempted to study the habits of this interesting animal, or, at any rate, to have recorded their observations.

The present paper is written in the hope that some other naturalists, with more time and opportunity than I can command, will take up this most interesting study and solve some of the remaining puzzles. Except when otherwise stated, my work has been carried on within a few miles of Stafford, and has extended over the last four years. The figures are selections from my field note-book.

Since the time when Aristotle described the mole, no one seems to have studied its habits till Le Court set up as a scientific mole-catcher in France about 1798. He imparted his knowledge to Cadet de Vaux, who in 1803 published the information thus gained in a small work entitled, "De la Taupe, de ses mœurs, de ses habitudes, et des moyens de la détruire." This work is extremely interesting, and is on the whole a trustworthy record of

*January 13th, 1903.*

Le Court's observations, though here and there imagination is evidently a considerable factor.

Geoffroy Saint-Hilaire, who was also in correspondence with Le Court, copied most of Cadet de Vaux's work, especially the imaginative parts, which have been copied and handed down by every subsequent writer. But Saint-Hilaire\* also published the results of his anatomical studies of the mole, and these form the most important and interesting portions of his work. These studies have been hitherto ignored, and, as far as I know, are not even referred to in any text-book, but they deserve recognition, and will be referred to in the course of this paper.

Blasius,† Macgillivray,‡ Bell§ and subsequent writers have apparently been content to copy the information given by Le Court to Cadet de Vaux and to Saint-Hilaire, without any attempt to verify the statements of those writers.

In an interesting treatise,|| M. Flourens deals with his experiments on the mole's voracity, among which we have the often-quoted one of the mole attacking a live sparrow, where the mystery of the proceeding is explained when we read that the wing feathers were first pulled out to prevent the bird's escape.

A most amusing treatise on the mole is one by the Rev. James Grierson,¶ who gives the 'facts' as related to

\* *Cours de l'Histoire naturelle des Mammifères*, Paris, 1829.

† *Naturgeschichte der Säuge-thiere Deutschlands*, 1857.

‡ *A History of British Quadrupeds*, 1838. (*Jardine's Naturalist's Library, Mammalia*, vol. vii.)

§ *A History of the British Quadrupeds*, 1874.

|| "Observations pour servir à l'histoire naturelle de la Taupe." *Mém. Mus. Hist. Nat.*, Tome xvii. (1828).

¶ "Some Observations on the Natural History and Habits of the Mole." By the Rev. James Grierson, M.D., M.W.S., Minister of Cockpen. *Mem. Wernerian Soc.*, Vol. iv., pt. i., pp. 218—236. 1822.

him by a mole-catcher, whose chief recommendation for accuracy seems to have been that he invented a garden rake! This treatise is a splendid example of inconsequent reasoning and errors of every sort. It is amusing to find how quite recent writers repeat the old admiration for the cylindrical shaped body, ossified nasal cartilage, reversible fur, &c., as being so well adapted to the mole's habits of life. This was natural enough for Buffon in pre-evolutionary days, but we might just as well admire the way our bodies fit our clothes and the adaptability of our erect position to the doors of our houses.

I owe many thanks to numerous friends and correspondents who have helped my researches with the loan of books, references, &c., especial thanks being due to Messrs. A. Trevor-Battye, C. Oldham, W. E. Hoyle, C. E. Wright, and the Rev. E. A. Woodruffe-Peacock.

#### THE MOLE'S FORTRESS.

I have found a spade the best implement for dissecting fortresses. Generally it is possible to borrow one from a cottage near the spot, but I have often found it save time and trouble to take a small light spade on my cycle. The surfaces of the fortress may be carefully sliced away till a run is visible, and this run can be followed and opened with the hands till it descends to a deeper level, when further slicing is necessary. Before this is done a plan of the exposed run can be made on paper, and then another layer of runs exposed, always taking care to preserve the connections (if any exist) between the upper and lower runs; the lower runs should then be drawn on the plan. These plans should, of course, be made on the spot, as it is hopeless to attempt to draw them accurately

from memory. I have about 100 such plans, and have never found two exactly alike, though naturally they have a certain general resemblance to each other.

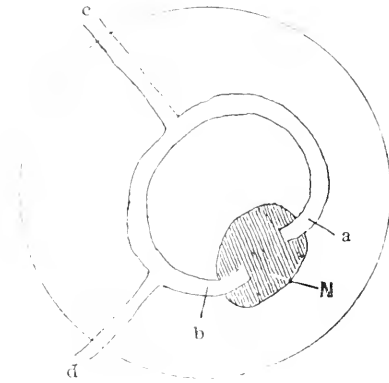

*Fig. 1.*—Plan of tunnels of simple fortress seen from above.  
*a, b.*—Tunnels made in excavating nest.  
*c, d.*—Tunnels made for forming protecting heap.  
*N.*—Nest.

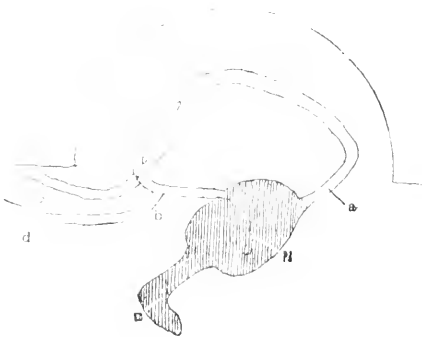

*Fig. 2.*—Horizontal view of same.  
*D.*—Downshaft.  
*N.*—Nest.

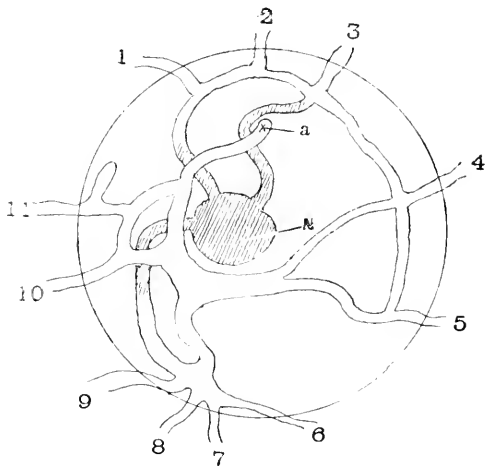

Fig. 3.—Complicated fortress with 11 exits.  
*a.*—Apex of the tunnels.  
*N.*—Nest.

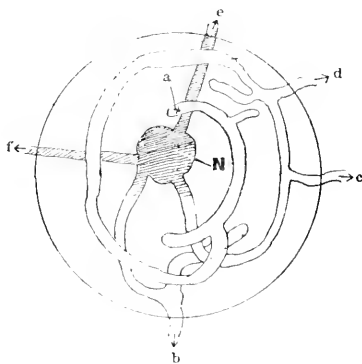

Fig. 4.—Complicated fortress with several blind terminals.  
*a.*—Apex of tunnels.  
*N.*—Nest.

These plans show that sometimes the fortresses are extremely complicated, and sometimes very simple, but in no case have I found one to tally exactly with the time-

honoured figure originating from Geoffroy Saint-Hilaire, elaborated by Blasius, and copied from him by every succeeding writer, apparently without the slightest attempt at verification. The oldest figure of all, *viz.*, that in Cadet de Vaux's work, is evidently drawn from an actual dissection, and not from memory aided by imagination, as is evidently that of Saint-Hilaire.

The text-books all speak of the fortress as if it were made on a pre-arranged plan of labyrinthine escapes from enemies above and below, whereas my observations tend to show that the more or less complicated galleries are purely incidental and without any reference whatever to premeditated escape, except in the case of the bolt-run, which will be described presently.

That there should be a general resemblance in structure is of course natural, and is the case, and the dissection of only one or two fortresses might well give the observer the idea that the galleries were splendid examples of a wonderful instinct of preservation.

But, by watching the erection of these structures from day to day, the conclusion forces itself upon one that *these galleries are the natural, incidental, and inevitable outcome of the work of excavating the nest-cavity and piling up the superincumbent mound.*

The site for the fortress having been determined, a circular cavity as a receptacle for the nest is made from two to six inches below the original surface of the ground, except in boggy soil or low-lying land liable to floods, where the nest is often above the ground level in the centre of a heap of earth which is thrown up from converging runs (*Figs. 5, 6, 7*). Now, the easiest way to dispose of the earth when the nest-cavity is being excavated is to push it upwards on to the surface, and in order to do this a tunnel must be made. *Fig. 8* shows



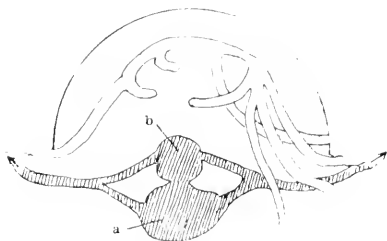

Fig. 5.—*a*.—Old nest } On marshy ground.  
*b*.—New nest }  
*c, c*.—Bolt-runs.

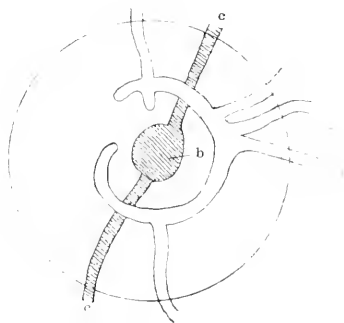
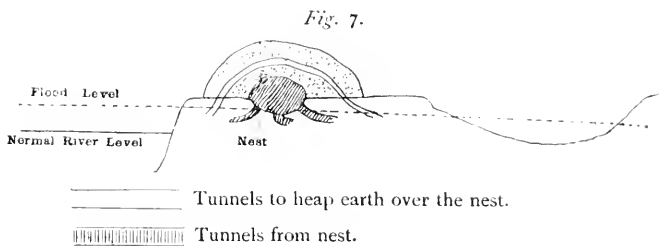
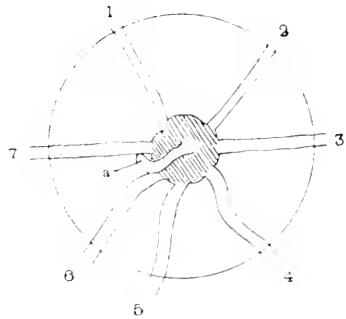
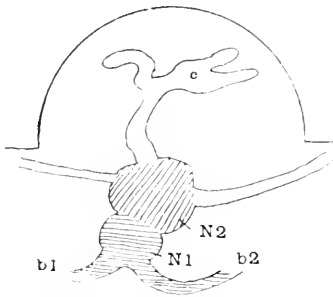

Fig. 6.—View from above of Fig. 5.



the whole heap made entirely by this tunnel. *Fig. 9*



*Fig. 8.*—*N 1.*—Old nest with 2 bolt-runs. *Fig. 9.*—*a.*—tunnel by which the entire heap was formed.  
*N 2.*—New nest. 1, 2, 3, 4, 5, 6, 7.—Outlets direct from the nest.  
*C.*—Upward tunnel by which the entire heap was formed.

illustrates a low fortress on boggy ground, the whole heap being formed by a single tunnel (*a*) leading upwards from the nest. This nest had seven outlets just below the soil. There was no other tunnel or bolt-run.

When this superincumbent earth has reached an inconvenient height another tunnel is made, sometimes from another part of the nest-cavity (*Figs 1, 2, a, b*), but more often sideways from the first upward tunnel. All this takes time, and the mole meanwhile makes fresh runs from the fortress, the seat of its labour, in various directions in search of food. Much of the earth displaced in making these fresh runs falls into the nest-cavity, and has to be disposed of in the same way as before, and also the soil displaced in making the bolt-run (see p. 13) and the downshaft (see p. 13) when this latter occurs. Now the tunnel (or tunnels) leading upwards from the nest-cavity becomes longer and longer, winding round under the surface of the growing fortress. When this removal of

earth becomes too fatiguing on account of the length of the tunnel, the mole will often begin to make new tunnels from runs close to the edge of the fortress (Figs. 5, 6). Sometimes these new runs break into those leading from the nest-cavity, but not very often ; usually they lie above them.\*

The tunnels in the fortress are for two distinct purposes :—

(a) Tunnels to eject earth from the nest-cavity and bolt-run. These are generally in the shape of a corkscrew ascending from the nest, and often diverging into blind terminals (Fig. 10).

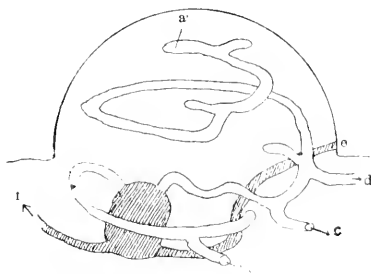

Fig. 10.—Vertical plan of fortress shown in Fig. 4, showing spiral gallery and blind terminals.

*b, c, d.*—Outlets.

*e, f.*—Two bolt-runs.

(b) Tunnels not connected directly with the nest-cavity, but traversing the fortress from runs outside it. Through these tunnels the mole has brought earth to heap over the nest, and they seldom occur except in boggy land, where the nest is of necessity near the surface of

\* In sandy soil, if the weather is dry, all the tunnels fall in as soon as formed, and the mole pushes the material right through the loose heap, but if the weather is damp, the superincumbent sand hardens, and the tunnels remain. The same thing happens in peaty soil.

the ground or even in the centre of the piled-up mound (*Figs. 5, 6, 7, 11, 12*). Cadet de Vaux and all following him represent the fortress with two distinct circular

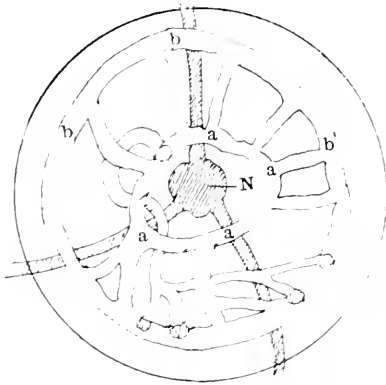

*Fig. 11.*—*a.*—Upper circular gallery.  
*b.*—Lower circular gallery.  
*N.*—Nest.

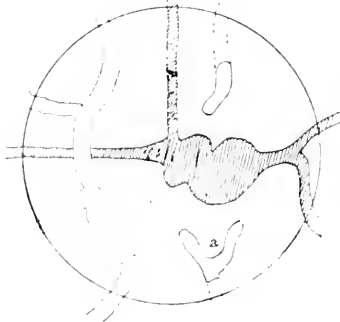

*Fig. 12.*—*a, a.*—Portions of tunnels which subsequently fell in.  
 .....showing probable course of these tunnels.

galleries with inter-connections on a fixed and universal plan. It is true that rarely the spiral tunnels might give one this idea if only one fortress were dissected, but after dissecting some 300 of them I can only say that no two were exactly alike. I give a figure (*Fig. 11*) of an extremely rare case of the spiral tunnel assuming the form of an "upper circular gallery." This fortress was a very large one, and I much regret that time would not allow my investigating the very numerous exits from the complete lower circular gallery into the meadow. It is noticeable that the upper runs do not communicate with the nest or with the three tunnels leading from the nest.

Now, as has been described, it often happens that from runs at the foot of the fortress several up-shafts will be found. These often become connected at their base in the following manner:—The frequent tunnelling close to the fortress often loosens a large portion of turf (often 18×12 inches in area), and as this is heaved up a connection is opened from run to run, and becomes what the books call the "lower circular gallery." This is very seldom complete, as in *Fig. 11*. If the turf is very loose, as we find it on peaty or marshy land, much larger pieces are heaved up (*Fig. 14*), and I once found a nest of young beneath the unbroken turf which was slightly raised (*Fig. 13*). The average fortress is one foot in height and

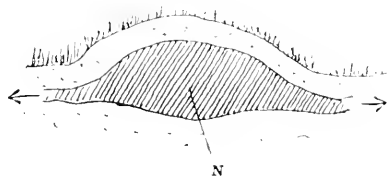

*Fig. 13.*—N.—Nest under turf.

three feet in diameter, but I have measured one 15 inches in height and five feet in diameter.

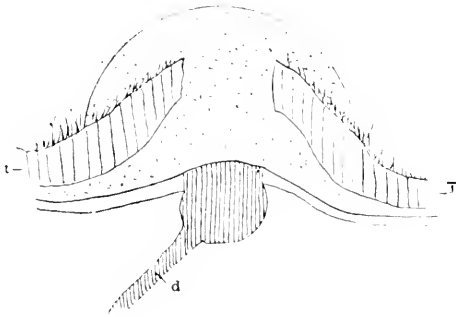

Fig. 14.—*d*.—Downshaft.  
*t*.—Turf.

The nest-cavity is roughly spherical, about the size of a large cottage loaf, and quite smooth from constant friction and use. The nest, which completely fills the nest-cavity, is a ball of grass or leaves or a mixture of both. I have found a nest made entirely of dead beech leaves, others entirely of dead oak leaves, and when it is remembered that this material must all be brought in by the mouth the amount of labour required can be appreciated. When the nest is taken out bodily, it has to be unwound (if made of grass) to find the centre. There is never a hole apparent, and not only is the nest always found closed when the young are within, but in all cases, even when old and long deserted. When dry grass is not obtainable fresh green grass is used, which soon withers and gets dry with the heat of the mole's body. The inside of the nest is warm to the touch when the animal has not long quitted it. When a nest containing young is found it is invariably infested with fleas and mites.

Nearly every fortress has a bolt-run, by which the mole can escape when surprised in the nest. This run leads downwards from the bottom of the nest, and then turns upward and out of the fortress by a tunnel of its own and is very rarely connected with any of the other numerous exits of the fortress. The only fortresses that I have seen without the bolt-run have been on marshy land, where such a tunnel would have led to water. (See *Figs. 7 and 13.*)

Occasionally one comes upon a downshaft, leading directly from the nest downwards almost perpendicularly for sometimes nearly three feet. The use of these downshafts is puzzling. Where the land is low-lying



*Fig. 15.*—N.—Nest in marshy land.

*a.*—Downshaft, 18 inches deep measuring from bottom of nest, full of water when found.

*b.*—Probable escape hole in flood.

and the soil moist they may be intended to drain the nest, but this is inconceivable in the Bunter sandstone on high ground above the level of the highest floods, where I have found them on more than one occasion. It has been stated that they are deliberately sunk as wells to supply the mole with water, a notion

which, I imagine, has arisen from a flooded fortress having been explored. *Figs. 2, 14 and 15* illustrate such fortresses which came under my notice, but it is ridiculous to suppose that the mole foresees the possible rise of water from below, and equally ridiculous to suppose that he digs the well through the water when it has risen.

I assume that it is in these shafts where collections of paralysed worms have been found, though I have always found them quite empty. I have never come across these "stores of worms" which some writers aver are contrived by the mole with "malice prepense," but I have often found in early spring a knot of three or four worms in a semi-torpid state embedded in the solid earth of fortresses (not in the tunnels), where I imagine they had collected of their own free will; and I see nothing unusual in this, for in digging my garden I have frequently come across similar knots or bunches of pallid, sickly-looking, semi-torpid worms, which I surmise hibernate together as do the frogs in the mud at the bottom of a ditch. The conclusion that I have come to is that, where these "stores of worms" have been found in "cavities" (*e.g.*, the bolt-run or the downshaft), the worms had fallen in and were unable to get out or burrow into the earth in their enfeebled torpid state.

Is it not possible that these downshafts are abortive bolt-runs, which have been abandoned when the mole found that the right point to turn upwards had been missed? This seems all the more probable, as we find that when these downshafts occur the bolt-run is absent. On one occasion, in digging up a nest of young moles, I found one of these downshafts full of loose fresh earth, which I cleared for about 18 inches but had no time to explore further, and the idea has since occurred to me that the



mother mole, being surprised on the nest, had burrowed straight down, and was perhaps boring away below while I was exploring the nest above.

The Rev. J. Grierson, already mentioned, describing the mole's dwelling, says, "a jakes, or place for retiring to when about to evacuate the fæces, is always found at a little distance from the nest, say nine or ten inches." This I have never been able to discover, nor do I expect to do so.

Cadet de Vaux says (p. 196) that the nest is lined with fur, which is recognisable by its tawny colour as that torn from the mole's belly. This may possibly refer to the other species, *T. caeca*, but I have never observed this peculiarity with our English mole. He also asserts (and my observations confirm his) that the mole never resorts to his last year's nest (*gîte*), but one

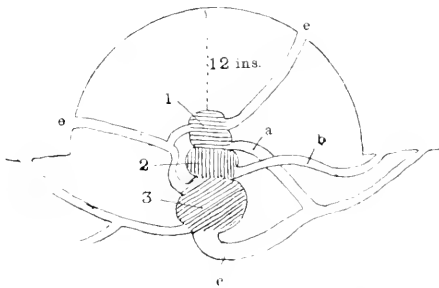

After C. E. Wright.

Fig. 16.—1.—Latest nest, *a*—bolt-run.  
2.—Previous nest, *b*—bolt-run.  
3.—First nest, *c*—bolt run.  
*e, e*.—Exits in floods.

frequently finds two or even three nests in close conjunction in the same fortress. Only one of these is fresh and inhabited, the others being old and discarded. The

new nests are generally built on the top of the others, but not invariably (*Fig.* 16). The material of an old nest is never used to make a new one, but fresh grass and leaves are brought from outside. I fancy that in such cases the same mole returns to his former fortress.

Cadet de Vaux says, on the authority of Le Court, and all the text books have copied him more or less literally, "The mole places his habitation in the most favourable spot in his cantonment ; he studies everything, and never does he make a mistake except under circumstances which he has been unable to foresee, such as continuance of rains, [or] a flood ; then he makes up his mind promptly and establishes himself elsewhere. It is by preference that he places his fortress in the foundation of a wall, under a hedge, [or] at the foot of a tree."

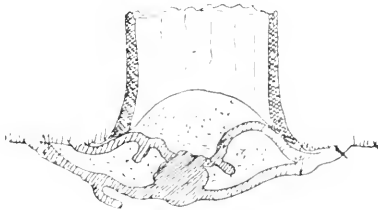

*Fig.* 17.—Fortress in old tree trunk.

Now, in the vast majority of cases the fortress is placed in the open field and seldom in the situations indicated above, though very occasionally I have found fortresses in hedge banks, but only when a ditch ran alongside ; and this partiality for the proximity of water seems to determine the position of the fortress to a certain extent. Now and then a fortress may be found under a tree, but most probably the mole knows nothing

about the tree at all; however, the hollows among the roots of old trees are sometimes utilised. *Fig. 17* represents a fortress in the hollow trunk of a tree, which my friend Mr. C. E. Wright discovered near Kettering.

Abundance of food and water does influence the mole in his choice of habitation more than anything else, nor is this to be wondered at when we consider his phenomenal voracity. But with regard to a deliberate choice of "the most favourable spot" after a survey of the cantonment by a practically blind animal of the mole's impatient disposition and subterranean habits, there can be no question as to its absurdity.

The low-lying land about Aqualate Mere, Staffordshire, in which district I have excavated 109 fortresses and breeding nests, is especially prolific in moles. In damp weather, when the black peaty soil is moist, the runs and galleries are very perfect and the whole structure is easy to dissect, but in dry weather, when the soil is simply black powder, the galleries fall in and the whole structure is a homogeneous heap without galleries of any sort. When these heaps begin to dry they are very often scored by surface cracks radiating from the apex, which cracks Saint-Hilaire supposed to be deliberately made by the mole to drain off the rain!

I give illustrations of fortresses on boggy land, where the nests were above the surface of the ground, in the centre of the superincumbent heaps (*Figs. 7 and 18*). *Fig. 18* shows an interesting fortress on marshy ground and liable to floods. The lower nest was made above the surface of the ground with a shallow bolt-run. Then came a flood and rendered this untenable. The mole then made the second nest, with its accompanying runs, on the top of the first nest. The dotted lines show the fortress as it then appeared. Then came a second flood,

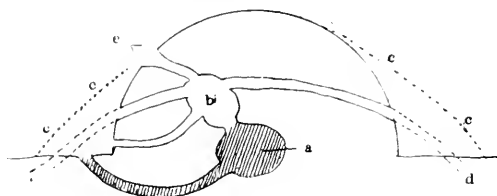

*Fig 18.*—Fortress in boggy low land.

- a.*—Nest in heap raised above surface of ground.  
*b.*—Second nest made after a flood had covered the old one.  
*c, c, c, c.*—Original outline of fortress.  
*d.*—.....original tunnel formed by heaping up the fortress.  
*e.*—Exit made when a second flood had surrounded the heap.

and the mole had to make an escape hole through the top. When I found the fortress the last flood had freshly subsided. In the same field I found other similar fortresses. The state of the two nests clearly showed that they had been made within a short period.

In the neighbourhood of Acton Hill, Stafford, where my friend Mr. Patteson kindly gave me leave to explore, the soil is stiff clay and the galleries of the fortresses are remarkably perfect and easy to follow, and their smooth surfaces are often found scored by the mole's claws. It is especially noticeable, too, that, in excavating galleries in clay land, one's hands become smeared with a slimy substance which I can only suppose to be the slime of worms.

It is truly marvellous how runs are made at all in such difficult ground as Bunter sandstone, where the spade will hardly penetrate, yet the mole will make his accustomed runs, and turn out among the heaps of sand stones weighing over 4 oz., which is the maximum weight of a mole. Worms in this ground must be comparatively scarce, and, one would think, mostly found at the roots of

the grass at the surface, yet in this formation the runs are always very deep, often nearly a foot below the surface and very wide. As a rule, the softer the soil the nearer are the runs to the surface.

I have not been able to actually see how a mole pushes the soil out of the ground in making a heap, but I fancy this is performed by using the snout and top of the head, and not backwards by the hind feet as has been asserted. I have often observed that when burrowing on the surface, a mole, while working with his front paws, always keeps lowering and raising his head to clear the way before him, which the powerful muscles of the neck enable him to do with little exertion. Imagine the position requisite for the mole 3 or 4 inches below the surface to kick out backwards the large mass of earth which often comes out solid like a sausage. Besides, the set of the forelegs would not allow them to give leverage for the backward push. Again, the earth as it rises from below comes in little jerks, exactly corresponding to the raising and lowering of the head as the mole burrows.

---

#### SEXUAL CHARACTERISTICS.

For some time I had been extremely puzzled at the seemingly enormous proportion of males to females among those that I caught or had sent me. The explanation, however, was found in the work of Saint-Hilaire, who had himself been puzzled precisely in the same way. As the following facts are not given in any of our English text-books, nor indeed, as far as I know, in any other except that of Saint-Hilaire, and as I suspect they are new to most naturalists, I think them of sufficient interest to be given at length.

Saint-Hilaire discovered by dissection that the virgin mole has the same external appearance as the male with respect to the genital organs, the vagina being closed, not by an internal hymen, but by the skin of the belly covering the orifice. Micturition is effected by the clitoris, which externally resembles the penis of the male, and has the same function of micturition, which is easy of verification by passing a bristle from the bladder through the extremity of the clitoris. Of course, the glans penis of the male, if extruded, will show the sex at once, but superficial examination will not determine this, and though Saint-Hilaire points out that the clitoris is nearer to the anus than is the penis, this difference is often too slight to be of any practical value, and dissection alone can decide the point.

Saint-Hilaire goes on to assert that to effect penetration of the virgin an ossicle or os penis is used.\* This, I am convinced, is not the case. At the end of the glans penis, but covered with integument, there is a flexible cartilaginous body corresponding to the os penis of the carnivora, which doubtless strengthens the penetrating



*Fig.* 19.—View of glans penis from above. *o*—os penis.



*Fig.* 20.—Side view of glans penis. *o*—os penis, *u*—urethra, *m*—meatus.

organ but is certainly not capable of rupturing the skin covering the vagina of the virgin mole. The length of this piece of cartilage is 2.75mm. My observations show that about March 1st a wrinkle appears at the base of

\* “Cet osselet aigu, véritable tarière.”

the clitoris, which in a few days assumes a purple hue, and by the middle of March a perforation appears in this livid wrinkle on each side of the median line. Towards the end of March these two perforations coalesce, and the vagina is then open for penetration in the usual way. I have not found any internal hymen whatever. It is exactly at this time that males are caught with unmistakable signs of recent copulation. I have observed that, before the vagina is open, and before even the wrinkle appears, the vagina and uterus are enormously developed (*Figs. 21—24*).\*

The proportion of males to females seems equal.

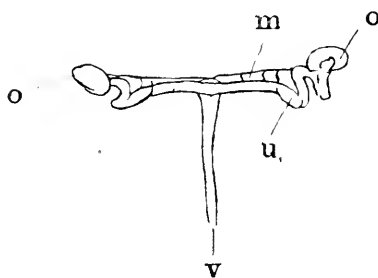

*Fig. 21.*— ♀ Generative organs not in the breeding season (actual size).

*o, o*—ovaries.

*m*—membrane.

*u*—uterus.

*v*—vagina.

\* The Rev. F. Jourdain has brought to my notice a remarkable parallel between the female generative organs of the mole and those of *Hyena crocuta* as described by Morison Watson (*Proc. Zool. Soc.*, 1877, p. 369; 1878, p. 416; and 1881, p. 516). Briefly, in *H. crocuta* the sexes are barely distinguishable; the female possesses a clitoris  $6\frac{1}{2}$  inches from root to tip, which is perforated by the urino-genital canal; the vulvae are absent. After parturition the lower side of the clitoris opens out. The likeness is further heightened by the scrotum of the male being imitated in the female, and there is no appearance of a vagina.

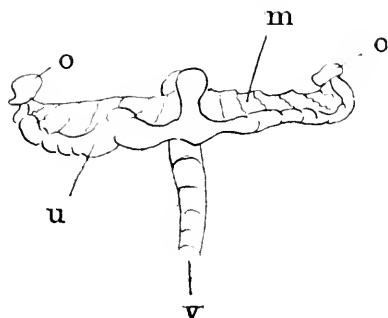

Fig. 22.—♀ organs expanding, but not yet impregnated (actual size).

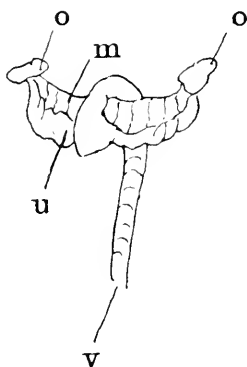

Fig. 23.—♀ organs expanding, oblique view showing the folding over of the vagina (actual size).

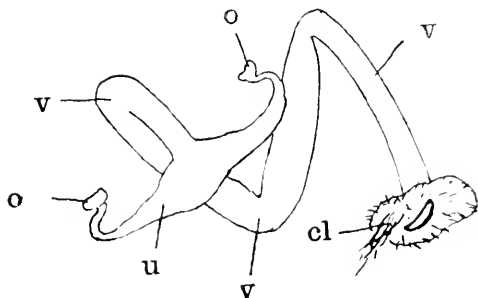

Fig. 24.—Showing enormously enlarged vagina [and atrophied ovaries after impregnation, but before the fetus are visible in the uterus (actual size). *cl*—clitoris.



Cadet de Vaux speaks quite correctly when he says that the long straight runs are those made by the males and the winding tunnels those made by the females. This I have repeatedly tested by trapping.

The female makes a separate fortress and nest in which to bring forth her young. This is usually much more simply constructed than the fortress of the male, and seldom possesses a bolt-run.

Though Cadet de Vaux says, without hesitation, that moles live in pairs in the habitation of the male till the female leaves her spouse to prepare her nursery, I am by no means convinced that this is the case. I have never been able to trap a female in or close to a male's fortress, and if we are to judge from the analogy of the rabbit (which makes a separate nursery, presumably to protect her young from the voracious father or fathers), we may suppose the mole to be polyandrous.

As far as my information goes, no mammal prepares a nursery till well advanced in pregnancy; if this holds good with regard to the mole, six weeks is nearer the actual period of gestation than one month, as some fortresses from which I have taken the young have been made about one month previously.

#### NUMBER OF LITTERS; TIME OF BREEDING.

Hitherto it has been a matter of speculation as to whether the female has one or more litters a year. I believe that the following evidence is sufficient to enable us to assert that only one litter is brought forth.

Dissection of hundreds of moles at all times of the year shows that an enormous development of testes, prostate, and corpus spongiosum takes place in the male, commencing late in January, and culminating about the

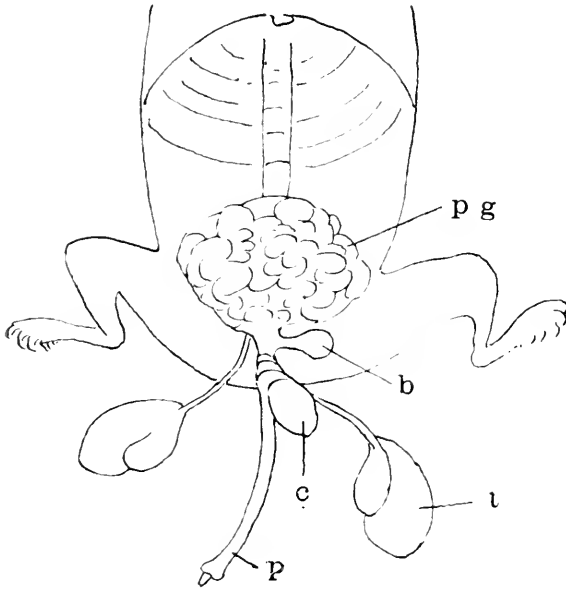

*Fig. 25.*—Showing enormous development of ♂ organs in breeding season (actual size). *c*—corpus spongiosum; *b*—bladder; *p*—penis; *p g*—prostate gland; *t*—testis.

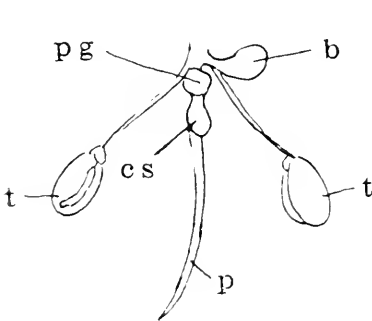

*Fig. 26.*—Normal size of ♂ organs out of the breeding season.

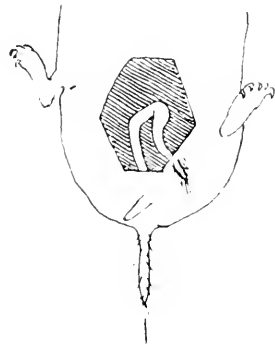

*Fig. 27.*—Showing how the penis is coiled up under the skin after the manner of the common shrew.

end of March or beginning of April when pairing takes place. After this date these organs decrease in size, till by the end of May they have regained their normal size, and retain it for the rest of the year (*Figs. 25 and 26*).

In the case of the female a similar enlargement takes place of the vagina and uterus corresponding with the organs of the male in time of waxing, culminating and waning, and disappearing when the litter is cast (*Figs. 21—24*).

Thus there is only one short rutting season, practically confined to the latter part of March, April, and perhaps occasionally the beginning of May, after which both sexes are completely exhausted. The earliest personal record I have for a fetal litter (which was within 3 or 4 days of birth) is April 13, and the latest young I have seen in the nest were taken on June 25. These were quite ready to leave the nest.

Thus, calculating that the period of gestation is four weeks (and I think it is rather more), it is evident that the female would not have time to breed twice within the the period mentioned during which young are found, even if she were in condition to do so, which she is not. Moreover, these limits are not those of the same year or locality, so they may be fairly curtailed, and a month of courtship may be presumed to be the limit of the mole's capacity.

Of course it is possible that some young moles of both sexes come into use later than adults and occasionally breed later. Aflalo says,\* "I have seen young in August," and the Rev. Dr. Grierson says that his informant, Mr. Fletcher, "had seen young in September."

The only mention that I have come across as to the number of teats is by Blasius, p. 113, who gives the number

\* *A Sketch of the Natural History (Vertebrates) of the British Islands.*

as *six*, whereas there are *eight* (*Fig. 28*). This is curious, as the maximum number in a litter appears to be seven, but may be accounted for by the fact that the mammary

*Fig. 28.*

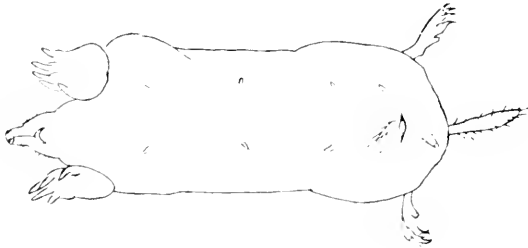

glands are mere fasciæ, hardly noticeable, and are spread over a larger surface of the body than usual, to allow the mole more freedom of action. I have never seen the fur surrounding the teats worn away by the sucking young, as is the case with rats, &c.

The average number of young in a litter works out at rather more than  $3\frac{1}{2}$ . The smallest number that I have ever found in a pregnant female is two, which is very rare, and the greatest number is six, which is also very occasional. I have heard of seven.

The following table gives my personal records:—

Number of litters containing	2	...	4
"	"	"	3 ... 20
"	"	"	4 ... 31
"	"	"	5 ... 4
"	"	"	6 ... 1

I have not been able to discover whether copulation takes place above or below ground. I have frequently trapped moles in their runs with evident signs of recent copulation, and I think that if they came above ground for this purpose they would become an easy prey for owls and other enemies. The open surface runs termed

“rutting runs” are certainly more frequently met with about the pairing season than at other times, but on damp soft land they may occasionally be seen at any time of the year.

#### ENEMIES OF THE MOLE.

Blasius says, “The mole is eaten by various beasts and birds of prey, storks and snakes. The birds of prey and storks wait for him by his heaps; stoats, weasels, the common adder penetrate his runs and dwellings and follow him therein.” However this may be in Continental Europe, the mole’s natural enemies in Great Britain are few and incidental. Our native snakes are not able, I imagine, to tackle so large a prey successfully, though a writer in *Science Gossip*, 1878, says that, near Ventnor, he killed a large adder out of which he extracted a full-grown mole. Mr. G. R. Leighton\* says, “The dietary [of adders] usually given, consists of mice, . . . moles . . . .” but no authorities are quoted and “usually given” is indefinite. Personally, I should be inclined to think the mole more likely to prey upon the adder.

The weasel has often been caught in mole-traps set in the runs, and doubtless the larger stoat preys upon moles occasionally, but it is not likely that the stoat follows the mole along the runs.

The heron probably snaps one up now and then by the water-side, as I have known this bird to swallow a nearly full-grown water vole. I have found moles’ skulls and bones in owls’ pellets, and my friend Mr. C. Oldham has had a similar experience. Owls doubtless catch them when they come to the surface at night to get grass for the nest.

A fox terrier of mine would hunt moles successfully.

\* “*Life History of British Serpents,*” p. 84.

It would move about a "mole town" till it had located a mole working, and then quickly scratch out the animal, play with it, throw it up in the air, roll on it when it fell, and amuse itself thus till its victim died; but it never shook them as it did rats, nor did it ever attempt to eat them. My friend Mr. C. E. Wright had a dog which used to bring home moles which it had caught.

Sir Thomas Boughie, of Aqualate, tells me that foxes sometimes dig out moles and eat them, and a mole-catcher once told me that foxes carry away dead moles. Cadet de Vaux asserts that the fox extracts young moles from their nest, and takes them to feed its own young. Another mole-catcher informed me that pigs will eat dead moles—but then pigs will eat anything! The same man has known badgers dig up traps and eat the dead moles out of them.

In the *Globe*, Feb., 1901, a correspondent says:—"Few people have realised that the hedgehog is a liberal consumer of moles." I am certainly one of the many who do not realise the fact, though I presume the writer had some reason for what he wrote. In May, 1901, I kept a fine large hedgehog in an empty fowl-house. One day I gave it the entrails of a freshly caught mole which were devoured during the night. A few days afterwards I placed a freshly caught dead mole in his way and gave him nothing else to eat. I found by marks on the sanded floor that during the night he had dragged the mole all over the place, but had not penetrated the skin. I then supplied a freshly caught mole which I had been dissecting, which had the belly slit open. I found next morning the skin of this turned inside out with every particle of flesh and bone gone up to the tip of the snout, with the paws and tail attached. I tried, in turn, fresh dead moles entire

and dead moles slit open, with invariably the same results. The entire moles were always dragged about, in the evident endeavour to feed upon them, but invariably the thick tough coat was proof against the hedgehog's incisors, while the slit moles were invariably eaten up and the skin empty and clean and turned inside out.

I do not think rooks prey on moles as a rule (though crows may do so), for I have noticed that opposite to an extensive rookery near Stafford trapped moles are often hung up on a hedge, but never seem to disappear. The larger hawks may account for a few moles when they come above ground for water on summer evenings, or when they emerge in search of grass and leaves to make their nests, but these occasions must be rare and incidental.

#### CAN THE MOLE SEE?

Geoffroy Saint-Hilaire, who, with the assistance of others, examined carefully the mole's eye, gives his opinion (*op. cit., leçon 16, p. 26*) that, owing to the extreme convexity of the crystalline lens, the animal is short-sighted. He also comes to the conclusion (*leçon 16, p. 37*) that the mole "has very good sight" (doubtless meaning as far as the sight reaches). He also makes the statement (*leçon 16, p. 27*) that "the eye of the mole is more developed in the fœtus than in the adult," which is very interesting, if true, as it points to the conclusion that the sight of the animal is deteriorating through disuse. Saint-Hilaire describes the following experiment performed by Le Court to demonstrate the mole's power of sight (*leçon 16, p. 8*). Several moles were introduced one after another into one end of an empty drain pipe. Le Court waited at the other end, and as long as he kept still the moles ran out, but "a single movement of his thumb was enough to check the mole; it reached the edge of the

exit, and startled by an apparent and unexpected movement, went back again." Blasius (doubtless following Saint-Hilaire) merely says—"We are convinced that he directs his course by power of sight" (p. 114).

I cannot refrain from quoting verbatim an account of a mole which saw an island in a Scotch lake 150 yards distant from the shore, and nearly reached it by swimming! This account is quoted by the Rev. Dr. Grierson, already mentioned, in the following letter, of whose author Dr. Grierson says, "I beg to copy his *ipsissima verba*. Indeed I should not in any other way do justice to the subject."

"To Dr. GRIERSON.

"Manse of Clunie, 25th March, 1822.

"Dear Sir,

"I have your favour of the 19th current, and, in reply to your queries respecting the mole mentioned to you by our friend, Dr. Baird, I beg leave to state the following particulars.

"Though the fact, alluded to by the Principal, did not fall under my own observation (it having happened about two months previous to my coming to reside here) it was repeatedly confirmed to me by the verbal testimony of three honest men, on whose veracity I had no hesitation in relying. They all three saw the mole, handled it, examined its eyes, etc., but did not observe whether it was a male or a female. Two of the men are since dead, the third is still alive, and has been my next-door neighbour for these thirty-seven years past, and had I no other authority but his own for the truth of the fact referred to, I should have regarded it as altogether satisfactory. He has been long settled here as gardener and nurseryman to the Earl of Airly,—has himself been the death of many moles in his day, and was himself the death of the very



individual mole in question. He has this very day, and not an hour ago, told me, that he recollects the circumstances that attended its death, more perfectly than many thousand things that have happened to him since.

“It was in the year 1785, within a day or two of the summer solstice, on a calm, mild evening, between nine and ten o'clock, when the surface of the lake was as smooth as a mirror, he, and another of the men above-mentioned, had rowed about fifty yards from the island towards the mainland, when they observed the creature steering its course from the mainland towards the island, and approaching to their boat. The gardener took off one of the oars, arrested the poor little voyager on its passage, struck it with the oar, killed it with the stroke, took it up, and handed it to his companion in the boat. Next day they shewed it to the other man, when all three became, for the first time, converts to the belief, that moles could swim. The animal was killed about 100 yards from the mainland, and about 50 yards from the island.

“Previous to this interesting catastrophe, molecasts had been observed on the island, and the people were at a loss to account for them. I have myself repeatedly observed them there; and it is consistent with my own personal knowledge, that two moles have been trapped on the island within the last two years, one by our mole-catcher, and another by a son of the gardener.

“The island, since the commencement of my incumbency here, has been frequently overflown. I remember, one year, the whole surface of the island lay, for nearly twenty-four hours, under water, from one foot to eighteen inches in depth. Whether the whole race of moles then existing on the island might have shared the fate of the antediluvians, or not, I cannot tell. It is not unlikely

that a remnant (as in the days of Noah) were saved, since my friend the gardener (Alexander Duff) finds a difficulty in getting them extirpated. It is, I think, by no means improbable, that these curious animals carry on a sort of clandestine intercourse betwixt the mainland and the island. These few particulars, stated and authenticated as above, may serve to corroborate and illustrate some of your remarks on the history and habits of the *Talpa europæa*, which I should like very much to peruse. I mentioned the above circumstances many years ago to my worthy deceased friend, Mr. Arthur Bruce, who was some time ago secretary to the Natural History Society of Edinburgh, whether he published them or no, I have not learned. In the meantime, if you find them of any service to you, *his utere meum*, and believe me to be, with cordial wishes for your success in every laudable investigation,

“ Dear sir,

“ Yours sincerely,

“ W. MACRITCHIE.”

Mr. Trevor-Battye says in a footnote to p. 68 of Mr. Lydekker's "British Mammals":—"With regard to the question of vision, I can state that a mole which I kept for some time in captivity would take worms from my fingers. When I swung a worm about in front of his face he would—nose in air—follow it backward and forward with his head. Whether he saw it or only smelt it (in which case his quickness of scent was simply marvellous), I am unable to say."

I am inclined to think that the mole is practically blind. A mole which I once placed in an empty packing case ran its nose against the side frequently, and took no notice of obstacles placed in its way. When the daylight had nearly gone I held a lighted taper close in front of its

nose and dodged it about, but the mole took no notice of it whatever, and would have run into the flame if I had not withdrawn it. On another occasion I placed worms before a captive mole. It quickly became aware of their presence, but from the random way it poked about for them I was convinced that it was seeking them by scent and not sight.

That a mole can see anything much further than its nose, even if possessed with average sight, is extremely unlikely. The low position of its head would in its ordinary haunts among grass prevent the animal seeing beyond an inch or so, even were the eyes not covered with fur. Blasius, following Saint-Hilaire and Cadet de Vaux, says that when a mole is thrown into water the fur radiates from the eye and so makes vision possible. I have not been able to detect this, though I have experimented on purpose to do so. The only occasion that has come under my notice of the fur radiating and exposing the eye was when I was holding a dying mole in my hand--during its last convulsions I noticed the fur radiate.

#### HABITS.

I have watched a captive mole swim. The entire head and back to within half an inch from the tail are high out of water, and the end of the tail protrudes above the surface. The movements of the limbs are very rapid, downward and backward, after the manner of the dog. The little creature attains a pace equal to that of the water vole.

I have the following interesting note from Mr. C. E. Wright, of Kettering, respecting the mole eating partridges' eggs. Writing July 8th, 1902, he says: "The keepers here tell me they are sure moles are great destroyers of partridges' and pheasants' eggs, and have noticed them in the act of eating them. For some time

I had noticed the moles working under pheasants' and partridges' nests, but thought it was by accident that they burrowed under them when working for food, &c. This year I have made notes of this, and found numbers of nests 'let down,' as the keepers call it. I found nine nests at different times and places, some in hedgerows, some in long grass in the fields, others (pheasants') in the woods. One nest I found (a partridge's) with twelve eggs in a deep hedgerow, no dyke or water near. I watched this nest, as moles were working in the field, and there was no run near the nest then. Several days afterwards I visited the nest, and found that a mole had 'let it down,' and was feeding on the eggs, nine of which were broken and the rest were in the mole's run. I had often previously found the nests 'let down' and the contents gone, but thought that the bird had deserted the nest because of the disturbance to it, and that rats or rooks had taken the eggs. I am quite sure it is the mole that takes the eggs, not by accidentally coming across them in its working, but working up to them to get at them."

It has been asserted that the mole dies from a very slight tap on the nose. This is not always so. I once caught a mole alive in an iron forceps trap, which had crushed the loins, and, wishing to kill it, I struck it a sharp blow on the nose with a heavy sheath knife which I used to cut holes in the ground for the traps. It bled profusely at the ears and appeared dead, but after a few minutes showed signs of life. I again struck it across the nose with the heavy knife, but several blows were necessary to kill it. I think this mole took as much killing as a full-grown rat. This tenacity of life is the more remarkable when it is remembered that the hind limbs were quite paralysed by the iron trap.

Most certainly the mole does not hibernate. All

through the winter it is active, and fresh heaps may commonly be seen pushed through the snow. Of course, when the ground is frozen solid for some inches below the surface the mole does not so often struggle through, but has perforce to confine himself to a deeper level. I have, moreover, occasionally seen moles' tracks in the snow. They resemble the impression that might be made by a  $2\frac{1}{2}$  inch rope flung down on the snow. At the edges of the track marks of the front claws were sometimes visible, and indicated the direction of the wanderings. It puzzled me to guess what the mole wanted above ground where food was not, and I could discover no track of pursuing weasel or other enemy.

The time when the mole is least in evidence is June, July, and August, presumably because worms are busiest at this time of year, and he finds plenty of food in the tunnels he has already made, and perhaps he comes to the surface of the ground where the worms are pairing in multitudes. It is curious that moles' bones are not more frequently found in owls' pellets, when we consider that they have to come to the surface for the material for their nests, and also frequently to drink.

The accounts of the short periods of starvation necessary to kill a mole are borne out by my observations. On one occasion I caught a vigorous mole, quite unhurt, and fed him at intervals during the day with about a third of a pint of worms, besides which he had several drinks of water. At night, about eight o'clock, I dug about a third of a pint of worms, and put them into his den (a packing case with earth at the bottom) and left him. In the morning I found him very feeble, thin and cold. I took him up in my hand and put his nose to some water, which he seemed to enjoy, but he was too feeble to tackle a worm, and presently, after a gentle convulsion, he died

in my hand. I found on dissecting him that the stomach was absolutely empty, in spite of the fact that he had eaten every worm left for him. Baby moles, on the contrary, live a surprisingly long time without food; in fact, their capabilities of resisting starvation vary inversely as their size, the irregularity being perhaps accounted for by some having fasted longer than others before being taken from the nest.

In the following table the ages of the babies are of course roughly guessed at:—

Date.	Age.	Length.	Weight.	Sex.	Survival.	Remarks.
		Ins.	Oz.		Hours.	
May 25	1 day	$1\frac{3}{4}$	$\frac{1}{8}$	...	54	4 in litter, died within an hour of each other.
„ 19	2 days	$1\frac{3}{4}$	$\frac{1}{4}$	...	54	} Same litter.
„ 19	2 „	$1\frac{3}{4}$	$\frac{1}{4}$	..	59	
„ 19	2 „	$1\frac{3}{4}$	$\frac{1}{4}$	...	69	
„ 25	7 „	$2\frac{1}{4}$	$\frac{1}{2}$	...	30	
„ 24	9 „	$2\frac{1}{2}$	$\frac{1}{2}$	1 ♂	50	1 experimented on.
„ 24	2 wks.	$3\frac{1}{2}$	1	2 ♂	41	No fur.
„ 24	3 „	4	$1\frac{1}{16}$	2 ♂ 1 ♀	41	No fur.
„ 24	$3\frac{1}{4}$ „	4	$1\frac{1}{16}$	3 ♂ 1 ♀	41	Microscopic fur.
June 5	?	3	$\frac{3}{4}$	...	36—40	4 in litter, microscopic fur.
„ 25	5 wks.	4	$1\frac{1}{8}$	1 ♀	18	There were 2 other ♂ in this litter. Length $4\frac{1}{2}$ ins, weight $1\frac{3}{4}$ oz. Killed accidentally. They were fully furred and their eyes were open.

Without entering upon the question of good or evil that moles do, which is entirely a matter of circumstances, I may remark that, if mole-catchers really did their best to get rid of them, they would dig out the nests containing young as well as trap some of the adults, but then of course their occupation would soon be gone!

I cannot refrain from giving a receipt for poisoning the mole quoted by the Rev. Dr. Grierson:—"Take a handful of oatmeal, and pour so much water on it (stirring it all the while) as to bring it into the consistence of porridge, or thin brose. With every English pint of this, mix ten grains of corrosive sublimate. Pour a small quantity of this mixture on a piece of board, and lay it close by the mole's hill. Drop on it twenty drops of the oil of rhodium, or the oil of thyme, which has had a grain or two of musk mingled with it. The poison is to be put down at night, and in dry weather."

I have eaten many strange dishes in many strange places, and I must say that an extensive experience tends to warn one against animals with dark flesh like that of the mole. Shrews, tom-tits, and other insectivorous creatures have a bitter taste, and hitherto I have been content with the musky odour of the adult mole. But, when I considered the baby mole about ten days old, fed solely on milk, and resembling a miniature sucking pig, I could not refrain from a trial. So I had a couple boiled accordingly, and ate them without salt or other condiment which might conceal their flavour, and I found them excellent, much like rabbit, the flesh being white and very tender. I must admit, however, that I have not made a single convert to my view, even among my intimate friends, which shows how deterrent prejudice may be to scientific research, not to speak of household economy.

## FOLKLORE.

It is not strange that this animal, with its curious appearance and mysterious habits, should give rise to superstitions and fables.

A writer in *Science Gossip*, 1867, relates the following: "A curious mode of treatment for ague is practised in Marshland. . . . 'You must catch a mole, and it must be a male mole, one of those little creatures they hang on trees. Well, sir, you must then skin it and dry the body in the oven, and then powder it, and you must take as much of the powder as will lie on a shilling every day in gin. You must take it for nine days running, and then miss nine, and then take it nine days more, and then miss nine. By this time you are cured.'"

The Rev. Woodruffe-Peacock writes in the *Naturalist*, Sept., 1900: "Lincolnshire folklore says the mole leaves the ground but once a year, to take a little fresh air in the daylight."

My friend Mr. J. R. B. Masefield, of Cheadle, Staffordshire, tells me that at Cheadle a working man told him that a mole has only one drop of blood. This notion has most likely arisen from the fact that if a mole is so wounded as to show a very little blood, the wound is really very serious, the thick tough skin preventing the escape of blood from an ordinary hurt.

Dr. Addenbrooke, of Birmingham, informs me that in Smethwick, S. Staffs., there is a superstition that moles which are found wandering about in the daytime are "moonstruck."

An old mole-catcher at Clifton, Derby, once informed me that moles were blind, but *they had eyes on the soles of their feet*.

Mole-hills are locally known in Staffordshire as



“heaves,” in Herefordshire and the western counties as “tumps.”

Under the head of folklore the well-known story of the “trotting horse” must be placed. I suppose no treatise on the mole would be deemed complete without a reference to the experiment which Saint-Hilaire relates as having been performed by Le Court before some friendly witnesses, and which has been solemnly handed down without question or reflection. I have often seen moles try to escape at their best speed. This is a hurried scuttling trot, never faster than a slow walk, *i.e.*, about  $2\frac{1}{2}$  miles an hour. Granted that this might be slightly exceeded in their accustomed tunnels, we must admire the imagination of those who solemnly assert that “la course d’une taupe pouvait égaler à peu près en vitesse la marche d’un cheval dans son trot le plus rapide.”

---



**V. Notes on some Marine Turbellaria from Torres Straits and the Pacific, with a description of new species.**

By FRANK FORTESCUE LAIDLAW, B.A. (Cantab.)

*Assistant Lecturer and Demonstrator in Biology, Owens College.*

*Read November 18th. Received November 24th, 1902.*

Some time ago Dr. Harmer entrusted me with a small collection of Planarians made by Professor Haddon whilst in the neighbourhood of the Torres Straits during the year 1889. Shortly afterwards Dr. Gardiner kindly permitted me to describe his fine collection from the Maldives and Laccadives, and with them a few specimens from Rotuma and Funafuti, in the Pacific. My account of the Maldivian and Laccadive material has already been published [9]; the Rotuma and Funafuti specimens, together with those from the Torres Straits, are described in the present communication.

But little is at present known of the Planarian fauna of tropical seas. Since the publication of Lang's monograph of the Polycladida of the Gulf of Naples, several important memoirs dealing with this group have been published; the greatest additions have been made by Verrill for the coasts of New England [6] and by von Plehn [4].

I have not been able to find any record of Polyclads from Torres Straits. Dr. Collingwood, however, records

*January 13th, 1903.*

a number of species from Malay seas, mostly from Singapore, but some few from the coasts of Borneo [10]. As he did not examine the anatomy of the reproductive organs of the species described by him, it is difficult in some cases to determine precisely to which of Lang's genera his specimens are to be referred, or whether they belong to distinct genera. It is, however, possible to recognise two species of *Thysanozoon*; *Typhlolepta byerleyana* I have identified from the Maldives, and have created a new genus *Pericelis* for its reception [9]. Collingwood's *Elasmodes obtusum* is probably a Leptoplanid; *Proceros* should probably be referred to *Pseudoceros*. The remaining species are a *Eurylepta* and a *Stylochopsis*. The former Lang refers to *Pseudoceros*, doubtfully, and the latter to *Prosthecceraeus*.

Saville Kent, in his work on the Great Barrier Reef of Australia [8], figures three species which were named for him by von Graff. These are *Pseudoceros kentii*, *Ps. dimidiatus*, and *Prosthecceraeus flavomaculatus*. Von Plehn has recorded species from Java and Sumatra [4]; these include two species of *Thysanoplana* (? = *Thysanozoon*) and a new genus of Leptoplanidæ with one species *Semonia maculata*, all from Java, and a very remarkable form, the type of a new family, *Diplopharynx filiformis*, from off the north coast of Sumatra. This latter belongs, however, rather to the Indian Ocean fauna.

Lastly, von Stummer-Traunfels has described three new species of *Thysanozoon* from Amboina and two from Batavia [5].

Our knowledge of the Pacific fauna is equally fragmentary. Excluding the coasts of New Zealand, Japan, China and the Philippines, from each of which one or two species are known, Lang was acquainted with only eight species from the Pacific Islands which could be definitely

referred to known families, as well as one or two problematic forms of unknown affinities. In addition to these, three or four species had been described from the Australian coasts.

Since the publication of Lang's monograph, Woodworth has described three interesting new forms from the Barrier Reef of Australia [7], whilst von Plehn [4] has recorded a number of new species from the Pacific coasts of South America, as well as the previously known *Planocera pellucida* and *Pseudoceros superbus*, the latter from the Galapagos Islands.

It is, then, not a little remarkable to find amongst the few specimens collected by Mr. Gardiner that one, from Funafuti, is apparently identical with my *Leptoplana pardalis* described from the Maldives, and that another, from Rotuma, is *Pericelis byerleyana*, referred to above.

Of the other species, *Paraplanocera rotumanensis* and *Latocestus pacificus* are the most interesting. For the former I have created a new genus, which should include the species from the Maldives that I have described as *Planocera langii* [9].

#### Systematic List.

Professor Haddon's collection includes the following:—

1. *Planocera*, sp.
2. *Pseudoceros haddoni*, sp. n.
3. „ *regalis* (Haddon), sp. n.

Dr. Gardiner's specimens belong to the following species:—

1. *Paraplanocera rotumanensis*, sp. n.
2. *Leptoplana pardalis*.
3. *Latocestus pacificus*, sp. n.
4. *Pericelis byerleyana*.

## Sub-Order ACOTYLEA.

## Family PLANOCERIDÆ.

PLANOCERA, *sp.*

One specimen from 15-20 fathoms between Dauer and Murray Island, January 6th, 1889.

Unfortunately this specimen is too immature to permit of the structure of the genital apparatus being satisfactorily studied. Consequently, although I can scarcely doubt that it is a new species, I do not venture to describe it. So far as I have been able to judge, it belongs to the genus *Planocera*. There are seven pairs of gut branches; the total length is about 16 mm. and breadth 9 mm.; the mouth opening is in the middle of the body.

PARAPLANOCERA, *gen. nov.*

Closely allied to *Planocera*, differing in the following particulars:—Male genital apparatus with a pair of vesiculæ seminales, penis long, coiled, cylindrical, its lumen lined with small, rather distant chitinous spines. In connection with the female organs a thin-walled sac runs back from the vagina and appears to function as a receptaculum seminis. Another sac, with muscular walls, runs forward from the antrum femininum, alongside the penis; this is the bursa copulatrix.

Type.—*Paraplanocera langii* (Laidlaw).

PARAPLANOCERA ROTUMANENSIS, *sp. n.*

Two specimens from Rotuma.

Total length about	-	-	-	25	mm.
„ breadth	„	-	-	15	„
Mouth opening from anterior end	15	„			
Tentacles	„	„	„	8	„ about 1 mm. apart.
♂ aperture from mouth	-	-	-	3	„
♀ „ „ male	-	-	-	1.5	„

Colour (no note on the living animal) white, with a small number of scattered brownish spots, due to the presence of dorsal pigment containing gut diverticula of the same character as those which I have elsewhere described for *Planocera armata* [8].

Eye-spots in two thick clusters, one at the base of either tentacle, and in four groups of brain-eyes, two on either side of the middle line between the tentacles. The hinder pair of these consist of but few spots; the anterior pair are each of them, roughly, an elongated band of eye-spots, extending in front of the tentacles. In addition to the eye-spots and the pigmented diverticula already referred to, there is a 'cloud' of minute black spots collected in the mid-dorsal region, especially over the pharynx. A similar feature was observed in *P. langii*.

*Male Organs.* The prostate and penis lie within the outer muscular sheath. The prostate, which is a large, roughly spherical gland, very similar to that of other species, occupies the upper proximal end of the sheath, and communicates by a muscular, rather thick-walled duct with the penis, which receives the duct at its proximal end on the ventral surface. The penis is a coiled muscular tube; at its distal end its walls become continuous with the outer sheath. Its lumen is lined with small, rather widely separated spines, which increase in size as the antrum is approached. This layer of chitinous spines is interrupted at about the middle of the length of the penis by large folds of the wall coated with a thin layer of chitin. These folds have caused tearing of the sections, and consequently it is not possible to describe their exact arrangement. They are precisely similar in character to the folds described in the penis of *P. langii*. The antrum masculinum is very small, lined with secretory epithelium.

Immediately after it leaves the prostate, the duct

running from this gland to the penis is joined by the common duct running from the vesiculae seminales. These organs are merely the ends of the vasa differentia, slightly dilated, and supplied with a thin coating of muscle fibres.

The outer sheath is very thin and consists simply of a few circular fibres; the muscle wall of the penis consists of circular and diagonal fibres. There are apparently no retractor muscles, but at its distal end the penis, as already stated, comes into contact with the outer sheath. This contact is most pronounced, and continued furthest back from the aperture, on the ventral side.

*Female Organs.* These resemble in detail those of *P. langii*. The aperture leads into a wide muscular cavity from which a large muscular bursa copulatrix runs forward, after first bending to the right, alongside the penis just outside the outer muscular sheath. From the dorsal part of the cavity of the antrum femininum a short narrow duct runs back, receiving the openings of the uteri on either side, then, turning ventral-wards, it widens into a large elongated sac which has non-muscular walls and runs for some distance backwards. This sac I call the receptaculum seminis. Owing to the preservation of the tissues being rather poor, I cannot determine accurately the characters of the epithelium lining the walls of these chambers, but, so far as I can see, it appears precisely similar to that of *P. langii*. Both the bursa copulatrix (which has its inner walls much folded) and the receptaculum are filled with dense masses of spermatozoa.

This species is readily distinguished from *P. langii* by the possession of dorsal pigment-containing gut diverticula, as well as by the arrangement of the eye-spots.

The most noteworthy feature presented by species of this genus is the occurrence of the remarkable bursa



copulatrix, which cannot be homologized with that found in the true *Planocera*. In fact, not only is it impossible to derive the type of structure found in the female apparatus of *Paraplanocera* from the type found in *Planocera*, but it further seems impossible to suppose that they can have been derived from a common primitive type. On the other hand, the fairly close resemblance that exists between the no less complicated male organs of the same two genera obliges us to assume that a real relationship exists between them.

Amongst other Polyclads, a bursa copulatrix similar to that found in *Paraplanocera* only exists in *Eustylochus*, a new genus founded by Verrill for *Stylochus ellipticus* (Gerard) [6]. Verrill believes that a similar organ exists in *Stylochoplana maculata* (Quat.), for which species he proposes a new genus, *Heterostylochus*, but an examination of de Quatrefage's account and beautiful figure of the anatomy of this species makes it clear to me that the median forwardly-directed vesicle of this species, which lies over the penis, is rather to be compared to the vagina and accessory vesicle (which in *Paraplanocera* I term the receptaculum seminis), as the oviducts open into it. Consequently, this organ is quite distinct from the bursa copulatrix of *Paraplanocera* and from the organ which Verrill regards as a "spermatheca," or seminal receptacle, in *Eustylochus*. The latter genus can be readily distinguished from *Paraplanocera* by its styliform penis and by the possession of marginal eyes.

Family LEPTOPLANIDÆ.

LEPTOPLANA PARDALIS, Laidlaw.

Five specimens from Funafuti.

Family LATOCESTIDÆ, *nov.*

Von Plehn [4] has not, I believe, commented on the

striking resemblance between the genital apparatus of the two genera *Latocestus* and *Acelis*, which she refers respectively to the families Cestoplanidæ and Leptoplanidæ.

I believe that the resemblances are strong enough to outweigh the striking external differences in shape, etc., and indicate a connection between the two genera. The possession of a pair of vesiculæ seminales is exceptional in the Leptoplanidæ and the typical *Cestoplana* have only one. Further, I do not know of any Leptoplanid in which the prostate gland is segmented off so distinctly from the sperm duct, whilst in *Cestoplana* the prostate cells line part of the lumen of the duct. In fact, I believe that the relationship between *Cestoplana* and certain Leptoplanids is distinctly closer than between *Cestoplana* and *Latocestus*. Accordingly, I propose to constitute an independent family to receive these two genera, *Latocestis* and *Acelis*.

#### LATOCESTUS PACIFICUS, *sp. n.*

Two specimens, both immature, from Rotuma. An interesting new species, very distinct from *L. atlanticus*, the only member of the genus hitherto described. Unfortunately, the gonads are undeveloped, and it is consequently impossible to ascertain whether the same peculiarity obtains with regard to the position of the testes that was noticed by von Plehn [4] in *L. atlanticus*.

The terminal parts of the ducts are sufficiently developed to show that this species is closely allied to *L. atlanticus*.

Total length about	-	-	12 mm.?
„ breadth „	-	-	2.5 „
Brain from anterior margin	-	4	„

The mouth opening and sexual apertures lie close to the hinder end of the body. The anterior margin of the

body is rounded, the arrangement of the numerous eye-spots being shown in the accompanying figure.

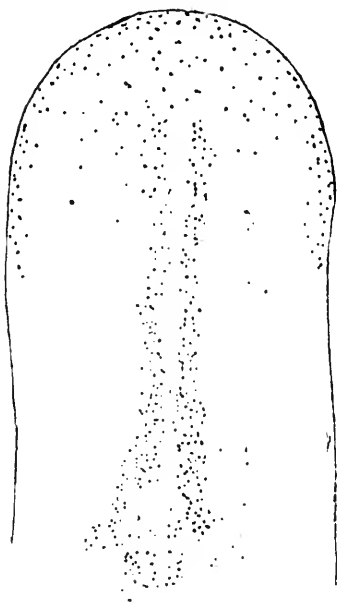

Anterior end of *Latocestus pacificus*, sp. n., showing the arrangement of the eye-spots. ( $\times 14$ .)

This genus is probably fairly abundant in tropical seas. I am inclined to believe that the species I have described as *Cestoplana? maldivensis* [9] should be referred to it, but an examination, by sections, of the single specimen known is unfortunately impossible. I have also an undescribed species belonging to this genus from Penang, very distinct from either of the others.

Sub-Order *COTYLEA*.

Family PERICELIDÆ.

PERICELIS BYERLEYANA (Coll.).

A single large specimen from Rotuma, indistinguishable, so far as I can discover, from the Maldivian specimens.

## Family PSEUDOCERIDÆ.

PSEUDOCEROS REGALIS, Haddon (in MS.), *sp. n.*

A single specimen from Mēr Reef, January 8th, 1889.

Length about	-	-	-	-	-	17 mm.
Breadth	„	-	-	-	-	11 „
Mouth opening from anterior margin	-					6 „
♂ aperture behind mouth	-	-	-	-	-	1·5 „
♀	„	„	♂	-	-	1 „
Sucker behind ♀ aperture	-	-	-	-	-	1·5 „
Brain-eyes from anterior margin	-	-	-	-	-	1·5 „

Colour a rich brick-red, becoming intense toward the margin, which is lined with a very fine black line. As in the following species, the tentacles are small, and the eye-spots difficult to distinguish owing to the dense pigmentation. The cluster of brain-eyes is very small. Colour of the under surface dull yellow. Penis single. Evidently somewhat closely allied to *Ps. kentii*, von Graff [8].

PSEUDOCEROS HADDONI, *sp. n.**Planaria nigrocincta*, Haddon, in MS. (nom. preocc.)

One specimen, immature, Mēr Reef, January 12th, 1889.

Length about	-	-	-	-	-	17 mm.
Breadth	„	-	-	-	-	12 „
Mouth opening from anterior margin						5 „
Sucker from mouth	-	-	-	-	-	4 „
The marginal band is about 1·5 mm. deep.						

Colour dull orange-yellow, with a fairly broad marginal band running completely round the body, black. This black band is edged on its outer side by a very narrow yellow border. Tentacles small; brain-eyes few, in a minute circular cluster; pharynx large, much folded.

In addition to the foregoing species, Prof. Haddon

collected a *Pseudoceros* of larger size (about 30 mm. in length) entirely black, and evidently allied to specimens from the Maldives referred by me to *Ps. buskii* (Coll.) and *Ps. flavomarginatus*. It resembles still more closely Lang's figure of *Ps. velutinus*, var. *violacea* of Schmarda [2], from the coasts of Ceylon. There is also a small specimen of a black, yellow-margined species from Rotuma, and others from Zanzibar are in Mr. Crossland's collection, which I hope to describe shortly. I cannot feel certain of the identity of these two specimens with any described form, but, as these black *Pseudoceros* are evidently numerous in tropical seas and possibly very variable, I cannot undertake at present to name either of these specimens. This group of black species is very difficult to examine owing to the dense pigmentation. Probably *Ps. dimidiatus* [8] belongs to the same group.

Von Plehn [4] has found *Ps. superbus* in the Pacific, off the Galapagos Islands.

There remain two species, one from Rotuma and one from Torres Straits, the former represented by a single imperfect specimen, the latter by two individuals too immature to admit of a satisfactory diagnosis. Both species have the typical folded pharynx of the Pseudoceridæ and are probably referable to the genus *Pseudoceros*, but I believe that under the circumstances it is advisable to leave them undescribed. There are, in addition to these, one or two other species from the Torres Straits which are unfortunately so macerated that no evidence as to their position is obtainable.

#### LITERATURE CONSULTED.

1. QUATREFAGES, A. DE. "Mémoires sur quelques planariées marines." *Ann. Sci. Nat., (Zool.)* IV. (1845), pp. 129—184, pls. 3—8.

2. LANG, A. "Die Polycladen, etc." *Fauna und Flora des Golfes von Neapel*, XI. (1884.)
  3. GRAFF, L. VON. "Pelagische Polycladen." *Zeits. Wiss. Zool.*, LV. (1892), pp. 189—219, pls. 7—10.
  4. PLEHN, MARIANNE VON. "Neue Polycladen, etc." *Jena. Zeits.*, XXX. (1896), pp. 137—176, pls. 8—13.
  5. STUMMER-TRAUNFELS, R. VON. "Tropische Polycladen." *Zeits. Wiss. Zool.*, LX. (1895), pp. 689—725, pls. 35—37.
  6. VERRILL, A. E. "Marine Planarians of New England." *Trans. Connect. Acad.*, VIII. (1892), pp. 459—520, pls. 40—44.
  7. WOODWORTH, W. MCM. "Some Planarians from the Great Barrier Reef of Australia." *Bull. Mus. Comp. Zool.*, XXXII. (1898), pp. 63—67, 1 pl.
  8. KENT, W. SAVILLE. "Great Barrier Reef of Australia." (1893.)
  9. LAIDLAW, F. F. "The Marine Turbellaria." *Fauna and Geography of the Maldive and Laccadive Archipelagoes*, I., 3 (1902), pp. 282—312., pls. 14—15.
  10. COLLINGWOOD, C. "On thirty-one species of Marine Planarians, etc." *Trans. Linn. Soc. (Zool.)*, [2] I. (1876), pp. 83—98, pls. 17—19.
-

**VI. The Chemical Researches of Edward Schunck,  
D.Sc., Ph.D., F.R.S.**

By W. H. PERKIN, Junr., Ph.D., F.R.S.,  
*Professor of Organic Chemistry, Owens College, Manchester.*

*Read January 20th. Received March 2nd, 1903.*

In endeavouring to give a brief survey of the work of Dr. Schunck, I should like to call attention to the opening sentences of a paper "On some of the substances contained in the Lichens employed for the preparations of Archil and Cudbear." This important paper was read before the Chemical Society of London on January 4th, 1842, and is published in the first volume of the *Memoirs* of that Society. It begins thus: "Our knowledge concerning that department of organic chemistry which embraces the colouring matters, and other principles nearly allied to them, is of the most imperfect kind. Though many other branches of organic chemistry have been so thoroughly and accurately investigated, that little or nothing remains to be known concerning them, this may be called an unexplored field." These words and many other statements in the same memoir are very interesting reading, as they show that at that early date the particular section of organic chemistry which deals with colouring matters had special attractions for Dr. Schunck. And indeed this investigation, which he states was commenced at Liebig's suggestion and in the celebrated Giessen laboratory, may be said to have had a fundamental influence on his life's work, because we find that nearly all of the investigations which he subsequently published deal with colouring matters, and especially with the colouring matters which occur in plants.

*April 23rd, 1903.*

In the memoir just mentioned, Schunck succeeded in isolating from the lichens of the *Lecanora* and *Variolaria* section, which he was then investigating, a crystalline substance which he named *lecanorin*. Although accurate organic analysis was a matter of considerable difficulty in those days, he was nevertheless successful in correctly determining the composition of this important substance, and the formula  $C_{16}H_{14}O_7 + 2H_2O$  which he gave to lecanorin has been repeatedly confirmed, and is the one in use at the present day.

Rochleder and Heldt, who soon afterwards (in 1843) obtained the same substance from *Evernia prunastri*, altered the name to *lecanoric acid* in order to indicate that it was an acid, and subsequently it was shown by Stenhouse, Hesse, and others, that Schunck's lecanorin is very widely distributed, and occurs as an important constituent of many of the principal lichens. A definite clue to the constitution of lecanoric acid was obtained through the observation of Stenhouse that this substance is hydrolysed on boiling with water and converted into two molecules of orsellinic acid, a decomposition which clearly proves that the constitution of the acid is represented by the formula

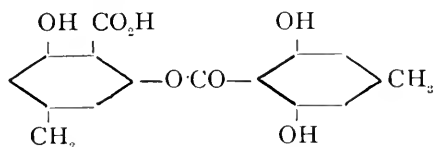

But the isolation of lecanorin was not the only important discovery which Schunck made in the course of his researches on the lichens. Heeren (in 1830) had made the observation that the lichens *Rocella tinctoria* and *Lecanora tartarea* (which were at that time, and indeed are now, largely used in the preparation of litmus and



archil) contain a crystalline substance which he named *erythrin*, on account of its property of yielding a red colouring matter when its solution in ammonia is exposed to the air. He further observed that when boiled with alcohol it is converted into a different crystalline substance which does not show this colour reaction, and this he named *pseudoerythrin*. The determination of the nature of these substances was largely due to Schunck, who showed that his lecanorin (lecanoric acid), when boiled with alcohol, is very readily etherified, yielding a substance which is evidently identical with Heeren's pseudoerythrin; this latter substance is therefore, in all probability, the ethylic ester of lecanoric acid. When boiled with water, erythrin is decomposed into orsellinic acid and picroerythrin—a bitter substance which had already been obtained by Heeren—and, since this latter substance, on hydrolysis with lime water, is converted into orsellinic acid and erythrol, it follows that it is an ester derived from *one* molecule of orsellinic acid and *one* molecule of erythrol. The constitution of erythrin itself is thus shown to be that of an ester derived from *two* molecules of orsellinic acid and *one* molecule of erythrol.

The next subject to which Schunck turned his attention was the investigation of the colouring principles of the madder root (*Rubia tinctorum*), and in this field also he obtained remarkable and important results which at once attracted the attention of chemists. The madder root has been employed for dyeing purposes from very early times, but nothing was known as to the active principle contained in it until the year 1826, when Colin and Robiquet succeeded in isolating a colouring matter from it, and to this they gave the name *alizarin*. In 1828 Zenneck published a paper in which he made the remarkable suggestion that the alizarin was not con-

tained in the madder root as such, but was present in combination with sugar or some similar substance. Schunck, in 1847, carefully investigated this matter, and was successful in isolating a bitter substance which he called *rubian*, and he showed that this substance, on boiling with dilute sulphuric acid, is decomposed with formation of alizarin and a sugar, and he was thus able to confirm Zenneck's suggestion.

A few years later (in 1851) Rochleder succeeded in obtaining this glucoside in a crystalline condition, and he then named it *ruberythrinic acid*. Græbe and Liebermann were the first to show that this crystalline ruberythrinic acid, when hydrolysed by boiling with dilute hydrochloric acid, yields, besides alizarin, glucose as the sugary constituent, and they represent the decomposition as taking place according to the equation

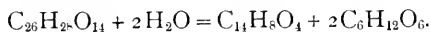

In 1876 Schunck discovered that, when anthraquinone disulphonic acid is fused with soda, a new dihydroxy-anthraquinone was formed, which he named *anthraflavic acid*. He subsequently isolated this same substance from the bye-products which had accumulated in the manufacture of artificial alizarin, and by fusing anthraflavic acid with potash he obtained a new and very interesting trihydroxyanthraquinone which he called *flavopurpurin*.

Schunck submitted both anthraflavic acid and flavopurpurin to an exhaustive examination, and converted them into a number of beautifully crystalline derivatives, all of which he obtained in a state of great purity.

In the year 1876 Schunck associated himself with Roemer, and together they published an important series of papers on some of the di- and tri-hydroxyanthraquinones. They worked out a method for preparing pure purpurin or

1, 2, 4, trihydroxyanthraquinone, and devised an ingenious method for showing the presence of small quantities of alizarin in mixtures of this substance with purpurin. This consists in exposing the alkaline solution of the mixture to the air, when the purpurin is rapidly oxidised and destroyed. Any alizarin present remains unchanged, and can be readily detected by examining the absorption spectrum of the solution.

Schunck and Roemer were also the first to show that purpurin, when heated gradually to 300°, is converted, by a remarkable process of reduction, into chinizarin or 1, 4, dihydroxyanthraquinone.

At as recent a date as 1893 Schunck again took up the investigation of madder root, and in a paper published in conjunction with Marchlewski he describes the isolation of a new glucoside of the formula  $C_{21}H_{20}O_9$ , which he called *rubiadingleucoside*. This new glucoside crystallises in yellow needles, and is hydrolysed by dilute acids with formation of rubiadin and glucose.

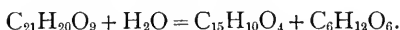

The constitution of rubiadin was also carefully investigated, and it was found that this substance is a dihydroxymethylanthraquinone or methylpurpuroxanthin of the formula

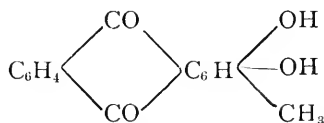

We may next notice the important researches which Schunck carried out on the nature of the constituents of the plants *Indigofera tinctoria*, *Isatis tinctoria* and *Polygonum tinctorium*. All of these yield indigo when their leaves are macerated with water in contact with air, and the first-mentioned is grown in India and China in

immense quantities, and serves as the source of nearly all the natural indigo which comes into the market.

It was known from very early times that indigo is not contained as such in the leaves of *Indigofera tinctoria*, and that, in order to produce indigo, it is necessary that the extract of the leaves shall undergo oxidation. In order to explain this, it was at first supposed that the leaves contained indigo white, and that this on oxidation was then converted into indigo. Schunck, however, showed that this could not be the case, because the clear aqueous extract of the leaves which deposits indigo on standing in the air is *acid*, and indigo white is only soluble in *alkaline* aqueous solutions. On investigating this matter, Schunck succeeded, in 1853, in extracting from *Isatis tinctoria* an unstable syrupy glucoside which he named *indican*, and which, when warmed with dilute acids in contact with air, readily yielded indigo.

In 1900 Hoogewerff and H. ter Meulen succeeded in obtaining the glucoside in a crystalline condition, but Marchlewski and Radcliffe, in 1898, were the first to give a satisfactory explanation of the composition of this glucoside and its behaviour with acids.

There can be little doubt that Schunck's indican is, in reality, a glucoside of indoxyl, and that, on hydrolysis, it is first converted into glucose and indoxyl, and this latter in contact with air is at once oxidised to indigo. These changes may be represented thus :

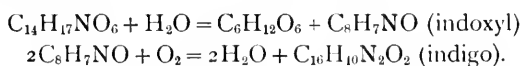

In connection with his researches on indigo, Schunck cultivated for some years the plant *Polygonum tinctorium* in his garden at Kersal, and a short time since he published a very interesting monograph entitled 'The action of reagents on the leaves of *Polygonum tinctorium*.' This

monograph is illustrated with very beautiful coloured plates, which are designed to show the influence of various agents in bringing about the formation of indigo in the leaves of this plant.

During the last few years of his life Dr. Schunck devoted his energies to investigating the great problem of the nature of chlorophyll, the colouring matter which occurs in the green leaves of plants, and which plays such an all-important part in their development. Partly alone and partly in conjunction with Dr. Marchlewski, he published probably the most important papers which have appeared on this difficult subject. These papers contain the description of the best method yet devised for preparing chlorophyll, and there can be no doubt that this method, if it does not yield the pure colouring matter, certainly enables it to be prepared in a much purer condition than it was ever obtained before. In possession of this highly purified product, Schunck and Marchlewski submitted chlorophyll to a careful spectroscopical examination, and at the same time studied its chemical properties, and made a most valuable investigation into the nature of the highly important products which are obtained when chlorophyll is submitted to the action of reagents. From the point of view of the future possibility of determining the actual constitution of chlorophyll, the experiments on the preparation of phylloxanthin, phyllocyanin, and the beautifully crystalline phyllotaonin, and the examination of their properties and mapping out of their absorption spectra, indicate that there is a possibility of acquiring a clear insight into the nature of the colouring matter at a not far distant date.

But probably the most far-reaching result which was obtained, certainly from a biological point of view, is the proof that *phylloporphyrin*—a crystalline substance

which results from the action of alcoholic potash on phyllotaonin—is evidently closely allied to *hæmatoporphyrin*, a substance obtained from the hæmoglobin of the blood. Not only are the spectra of these two substances practically the same, but they also show similar chemical reactions.

It is probable that chlorophyll may play a similar part in the plant to that which hæmoglobin plays in the animal economy, and that its principal function is to convey carbonic acid to the plant in much the same way as hæmoglobin acts as a carrier of oxygen. The proof of the great similarity between chlorophyll and hæmoglobin must go far to break down any sharp line of demarcation which may, by some, still be thought to exist between the animal and vegetable kingdoms.

One thing is most noticeable in all the work which Dr. Schunck did, and that is the extreme care and accuracy with which all his experiments were carried out. The problems which he attempted to solve were among the most difficult in the whole range of organic chemistry, and his results were frequently called in question, but in nearly all cases it was subsequently found that his statements were correct. Anyone who has had the opportunity of examining his magnificent collection of the specimens of the substances he had discovered and investigated during the course of his many researches will, at once, realise the great trouble he always took to obtain everything in its purest possible form.

His work was always a labour of love, and his researches will always remain as models of what skill and perseverance can do in elucidating the most difficult of chemical problems. There can be no doubt that Science, and especially Organic Chemistry, has lost in Dr. Schunck an investigator of the front rank, whose place it will be very difficult to fill.

**VII. On the Production of Polished Metallic Surfaces  
having the Properties of Japanese "Magic"  
Mirrors.**

By THOMAS THORP, F.R.A.S.

*Read January 20th. Received February 17th, 1903.*

On pp. 51 to 53 of *Light, Visible and Invisible*, by Prof. Silvanus Thompson, the following passages occur :—

“ For many years it was supposed that these mirrors  
“ were produced by some trick. But the extraordinary  
“ fact was discovered by Professor Ayrton in Japan that  
“ the Japanese themselves were unaware of the magic  
“ property of the mirrors. It results, in fact, from an  
“ accident of manufacture. Not all Japanese mirrors show  
“ the property : those that show it best are generally thin,  
“ and with a slightly convex face. It was demonstrated  
“ by Professor Ayrton, and I have since accumulated some  
“ other proofs, that the effect is due to extremely slight  
“ inequalities of curvature of surface. These arise acci-  
“ dentally in the process of polishing. The mirrors are  
“ cast in moulds. To polish their faces they are laid down  
“ on their backs by the workman, who scrapes them  
“ violently with a blunt iron tool, using great force . . .  
“ During this process they become slightly convex. The  
“ polishing is completed by scouring with charcoal and  
“ scrubbing with paper, after which they are “silvered” by  
“ application of an amalgam of tin and mercury. Now  
“ during the violent scraping with the iron tool the mirror  
“ bends, but the thin parts yield more under the pressure  
“ than the thick parts do ; hence the thick parts get worn

*April 23rd, 1903.*

"away rather more than the thin parts, and remain relatively concave, or at least less convex."

It would appear from this explanation of the production of the reflecting surface of Japanese mirrors that "scraping" tools are necessary, or, at least, it is not suggested that the "magic" effect may be produced in any other way.

With a view to test the effect of simply grinding and polishing the surface, a casting was made of hard bronze (about 73% copper, 23% tin, and 4% zinc) from a Japanese mirror having the magic properties in a slight degree, the surface being protected by a sheet of paper during the process of moulding, which was done in sand in the usual way. The replica was not very perfect, but, as it was only required to experiment upon, the few sand holes on the plane surface were of little consequence.

The surface was now ground with various grades of emery, the grinding tool, a lead block some 5in. diameter and  $\frac{3}{4}$ in. thick, being uppermost. As it approached a surface fine enough for commencing the polishing process, the workman who was engaged upon it, on his own account and contrary to instructions, finished the grinding with *cross* strokes only. The slight roughness of surface left by this procedure was partially removed by fine grinding, but the effects remaining were plainly to be seen after polishing, on reflecting a beam of light, and a very good example was thus afforded of the effect of a very small irregularity of surface.

Polishing with rouge was now commenced, and, this proving a very slow process by hand, a machine was roughly fitted up for the purpose. The polishing block was simply a large cork, some 3 inches in diameter, covered with felt and then with chamois skin, and the weights used varied from 2 to 6 lbs., the heavier the better,



it was found, if the "magic" effect was to be produced. As the polishing proceeded, the mirror (which, by the way, is a hand one, about 7in. in diameter) was repeatedly examined and found to possess the "magic" property, and increasingly so as the polishing continued.

It now occurred to me that this property might be the result of either of two things, or both combined, *viz.*, (1) the varying resistance to flexure, due to the different thicknesses of the metal (by reason of the raised design at the back), causing the surface to assume an unequal curvature, and thus exposing some portions of the surface to the grinding and polishing actions more than others; or (2) that the metal itself, again by reason of the raised design, might be more easily polished in some portions than in others. With the object of determining to which of these two causes the effect was due, an area of about 9 square inches was reground and polished by hand, using the least possible pressure. The result over this area was an almost total absence of "magic" effect. This result was not a little surprising, as the writer had rather held that the effect was due, to a great extent at least, to a difference of density, and of course it is quite possible that this is a factor, but a very slight one, in view of the results afterwards obtained.

The mirror was now repolished in the machine for several hours, using considerable pressure, with the result that the "magic" effect was fairly good over the whole surface, and this can only have resulted from the first named cause, *viz.*, varying resistance to flexure, as the previous polish by hand was about equal on the limited surface to that on the main one.

It now occurred to me, seeing that the effect was undoubtedly due, for the most part at least, to the unequal flexure during polishing, that straining the mirror might

reveal some peculiarities, and this proved to be the case. By making the mirror more or less convex by hand pressure, although only in one direction, the design in the one case started out in a wonderfully vivid manner, and in the other a blurring was the result. It was now only the work of an hour or so to have an arrangement fitted to the back of the mirror, whereby more or less pressure could be brought to bear on it, and with this the effects produced were very pronounced.

In order to absolutely determine whether, after all, some of the effect produced may not be due to the varying density of the metal, the back of another mirror casting was thickly coated with resin so as to prevent any flexure whatever during grinding and polishing—the polishing in this case also, to make assurance doubly sure, being done by the hand alone, no polishing block being used. The effect produced was that only the faintest indication of the design appeared on reflection, until the mirror was strained, when it became lighter or darker than the surrounding surface according as the reflecting surface was more or less convex than in the normal state.

On soldering an arrangement to the back in order to show the effects, a slight strain was put upon the mirror, rendering it more convex, and thus a decided effect was produced which did not exist when the edge of the mirror was free. A curious fact is brought out by means of this arrangement, but one quite to be expected, *viz.*, that, when the surface is rendered less convex than the normal condition, the principal features at all events appear dark with a bright border. This, again, can easily be shown to be the result of unequal flexure.

A third mirror casting was next fitted with a chamber from which the air was partially exhausted. On grinding and polishing the mirror whilst in this condition of flexure,

the "magic" effect did not appear until the strain was relieved, when the effect was very marked, as is shown in the accompanying illustrations, *Fig. 1* being the raised



*Fig. 1.*



*Fig. 2.*

design at the back of the mirror, and *Fig. 2* the "magic" effect produced by reflection from the polished surface.



## VIII. Parallax Determinations by Photography.

By C. E. STROMEYER, M.Inst.C.E.

*Received and read February 3rd, 1903.*

When announcing my intention to read a paper on this subject, I was not aware that our member, Mr. Thorp, had brought the matter before the British Astronomical Association, and that Mr. Pickering was employing the same method or a similar one for certain purposes at the Harvard Observatory. My application of the method to land surveying is I think new, and will, I believe, interest engineers.

The method consists in superposing the image of a negative photograph taken at one period or position and the image of a transparency taken at another period or position. If the two images were identical then the result of the combination would be a field of view of uniform tint ; if, however, there are changes of position, then the two images will register only locally and the relative displacements of two objects can be measured micrometrically by noting the amount of displacement of the two images.

It is not my intention to deal with the reduction of these measurements, except to mention that the most convenient conditions for taking surveying photographs is to arrange to have the two negatives on one plane. Then, as in the present instrument, one negative and one positive can be placed in contact, or these plates can be placed in two separate lanterns, and their images be thrown on one screen or into an eye-piece. In either

*April 23rd, 1903.*

case the normal distance of any object measured along the axis of the photographic objective is exactly equal to the product of the base line into the focal length divided by the micrometric displacement. Thus, in the case of landscape views, if we shift one of the slides relatively to the other so as to be set for a certain distance, say 1,000 yards, we can draw a curve through those regions which register correctly, and which appear of uniform shade. This curve would be a section line corresponding to a distance of 1,000 yards. This process can be repeated for every 100 yards or other intervals.

If the cameras are placed in front of each other, the planes of the negatives still being parallel, the contours obtained are intersections of hyperboloids of rotation with the undulating land, and it is difficult, but not impossible, to reduce these results.

If the two cameras are placed at an angle, the reduction of the resulting photographs has to be made by the present rather tedious methods, or a negative and a transparency have to be illuminated by two lanterns tilted to the right angle. In this case there will be much inconvenience due to the photographs not being in focus over their whole surfaces.

The instrument now shown has been made of sufficiently small dimensions to be used in one lantern. It consists of two light frames with clamping arrangements, the negative being clamped to one frame and the transparency to the other. One of the frames carries two vertical adjusting screws and one horizontal one, with which the other frame can be tilted, lifted, or moved horizontally.

The accuracy of even this very simple instrument is such that the turning of the micrometer screw through one-hundredth revolution is detected on the screen; this represents an angle of only 5" on an 8 in. focus, and far

exceeds in accuracy the angular measurement of ordinary 6 in. theodolites. Using a telescope with a focus of 160 ins. for producing the photographs, angular displacements of  $\frac{1}{4}$ " could be detected, and doubtless the accuracy could be greatly increased, if every precaution were employed to make the transparency a direct counterpart of its negative, and if two lanterns, instead of one, were used.

One of the advantages of this method of comparing photographs seems to be that the positions of hazy objects, such as nebulæ or comets, can be determined with the same accuracy as those of stars. If the negative and positive images of such an object register correctly, their region is of a uniform grey tint; the very smallest shift produces a mottled appearance, and a slightly increased shift shows a dark and bright nucleus in juxtaposition.

Another very important purpose to which this method can be applied is the rapid surveying of stellar photographs, with a view to picking out such stars as have undergone any changes of brightness or position, and I believe that for this purpose the most suitable arrangement will be not the superimposing of the negative on the transparency, but the use of two lanterns with which to project the images on the screen, adjusting the plates till the desired agreement is attained. By slightly tilting one of the plates one would get over the difficulty of atmospheric refraction, and by altering the relative illumination of the two plates one could readily detect changes of brightness in stars and perhaps even in nebulæ.

Another purpose to which I think this method could be applied is the measurement of the angular distance of two close binaries. Their combined star discs, although appearing circular in the eye-piece or on the photographic plates, must be slightly oval, which irregularity could, I think, be detected by turning one of images through an

4 STROMEYER, *Parallax Determinations by Photography.*

angle of  $90^\circ$ , using the very obvious precaution of also turning the objective of the telescope through an angle of  $90^\circ$  when taking the second photograph.

Seeing how admirably this method is adapted for determining the correct positions of hazy images, I believe that it would be found very convenient for measuring the displacement of lines of the spectrum.

When superimposing two plates, it is essential that their shades should be complementary, but when using two lanterns this is not necessary. During my early experiments with this apparatus I was unable to get the negatives and positives to be truly complementary. I therefore prepared a water-colour drawing in which eight different shades of white to grey and black were placed side by side. This drawing was photographed, and transparencies were made by exposing to an 8 cub. ft. fish-tail gas-burner at 3 ft. distance. The first transparency was exposed for 10 seconds, fully developed in pyro soda, and resulted in the high lights being too light and the shadows being too dark. The next was exposed for 30 seconds, and under-developed in pyro soda; the high lights were correct but the shadows were too pale. The next was exposed for 30 seconds, and developed in pyro soda with 16 drops 10% bromide per ounce; the high lights and medium shades were correct, but the shadows were too dark. The last was exposed 90 seconds, and under-developed in amidol; the result was practically correct.

---



## IX. Notes on the Type Specimen of *Loligo eblanæ*, Ball.

By WILLIAM E. HOYLE, M.A., F.R.S.E.

*Received and read February 17th, 1903.*

Thanks to the courtesy of my friend Dr. R. F. Scharff, of the Science and Art Museum, Dublin, I have recently had an opportunity of examining the cephalopod described so long ago as 1841 by the Irish naturalist, Robert Ball, under the name of *Loligo eblanæ*. As the result of the investigation has been to confirm an opinion which had been formed by others as well as myself, that this was not distinguishable from another species described by Girard under the name of *Todaropsis veranyi*, I have thought it worth while to set down the facts upon which this view is based.

The distinctive characters on which the genus *Todaropsis* is based are as follow :—

Funnel groove smooth ; tentacles without connective apparatus ; horny rings of the large tentacular suckers with numerous subequal short acute teeth ; the terminal suckers of the tentacle in four rows ; lateral arms without a membranous expansion.

The genus has been accepted as valid by Jatta, Posselt, Nichols, and Pfeffer, and the only doubtful point is whether it contains two species or only one.

In the first place it seems desirable to give a description of the specimen as full as its state of preservation permits, accompanied by figures of some of the more critical parts.

*The Body (fig. 1)* is bluntly fusiform, its greatest

diameter being about one-fourth backwards from the anterior margin. It tapers gradually to the posterior end, which is very blunt. The *fin* is very broad, its total breadth being nearly equal to the length of the mantle and more than twice its own extreme length. It is notched at its anterior insertion into the body; the extreme margin is very thin and shrivelled, so that the exact outline is difficult to determine. The *mantle-margin* presents a blunt angle in the nuchal region and is somewhat emarginate on the lower aspect opposite the funnel. The *mantle-connective* is of the type usual in the genus *Ommastrephes*. There is a well-marked valve in the opening of the *funnel*, which reaches forward about as far as the posterior margin of the eye-opening, and is connected with the head by two long suspensory ligaments.

*The Head* is rather flattened from above downwards, and not quite so wide as the opening of the mantle. On the lower surface is a shallow depression, which has no striated area, for the funnel. The *eyes* are very much shrunk; the ocular opening is roughly circular, with an angular notch in front. The *radula* (*fig. 6*), which was fortunately intact, has been mounted for me by the Rev. H. M. Gwatkin; it agrees well with that of *T. veranyi* as figured by Girard.

*The Arms* are unequal, the order of length being:—2, 3, 4, 1. The longest are of about the same length as the mantle and the shortest about three-quarters of this length. They are rounded and present traces of a keel or narrow swimming membrane along the outer aspect, excepting in the fourth pair, and there are also traces of a narrow delicate keel along either side of the sucker-bearing face, but the surface is in rather bad condition and these features are not very clear. The *suckers* are arranged in two series and are placed obliquely

on delicate tapering peduncles which arise from the tips of obliquely placed warts. The *horny ring* (*fig. 3*) has six to eight pointed teeth in the distal half of its circumference, the proximal half being smooth. The bases of the arms are not connected by any web. Both the ventral arms are *hectocotylised* (*fig. 2*); at about 1.5 cm. from the proximal end is a prominence rising gradually from the arm and bounded distally by a sharp elevated wavy margin; next comes a similarly shaped but smaller prominence, bearing a small sucker which is succeeded by three or four similar gradually diminishing prominences which bear suckers gradually increasing in size. The arrangement thus merges by degrees into the normal structure of the arm. The *buccal membrane* is smooth and is produced at regular intervals into five triangular prominences which are connected with the bases of the arms by ligaments in the usual way. The *outer lip* is thin and smooth, the *inner* thicker and corrugated, having the appearance of being made up of a single series of papillæ.

The *Tentacles* are about double the length of the body and have slender, somewhat flattened, cylindrical stems. The *club* (*fig. 4*) is about 5 cm. in length and is but little thicker than the stem. The proximal part bears about six small *suckers*, beyond which the suckers rapidly increase in size, until about the middle of the club there are four very large ones. These are succeeded by three or four gradually diminishing in size, whilst the tapering extremity of the club bears four series of small suckers, which become smaller and smaller to the distal end. Between the large suckers there arises from the sucker-bearing face of the club a series of ridges which pass transversely outwards, and, on arriving at the margin, are continued as a thickened rib along the edge of a membrane continuous with the margin of the club. Each of these ribs has,

at about one-third of its length from the base, a kind of papilla which bears a small sucker. These suckers alternate with the large ones in the centre of the club. The *horny ring* of the largest suckers (*fig. 5*) bears about thirty teeth which are slender, acutely pointed, and separated by interspaces about twice as wide as the teeth.

*Dimensions.*

Length, total (excluding tentacles) ...	...	160	mm.	
End of body to mantle margin ...	...	77	"	
Breadth of body ...	...	35	"	
Breadth of head ..	...	23	"	
Length of fin ...	...	30	"	
Breadth of fin ...	...	67	"	
Diameter of largest sucker on sessile arm		1·8	"	
Diameter of largest sucker on tentacle ...		3·5	"	
		<i>Right.</i>	<i>Left.</i>	
Length of first arm ...	...	65	mm.	60
Length of second arm...	...	80	"	75
Length of third arm ...	...	70	"	70
Length of fourth arm ...	...	60	"	65
Length of tentacle ...	...	150	"	160

The specimen is in rather bad condition and appears to have been somewhat macerated. It has been opened down the middle to extract the pen, which has not been preserved with the specimen. The incision has been stitched up and the mantle has been attached to the head by sutures, and it is very likely that the outline of the body has been somewhat modified by these operations. Nearly all the suckers have lost their horny rings, and on the tentacles I only succeeded in finding one *in situ*, and this was so loose that it fell out during examination. I have compared this specimen with examples received from the Zoological Station at Naples, as well as with several others in the Dublin Science and Art Museum. In

connection with this examination I desire to acknowledge the courteous assistance of Mr. A. R. Nichols.

On comparing this description with that of Girard (1890, p. 251) the principal points of difference are seen to be as follow :—

1. A slight divergence in the outline of the fin. This, I think, may be accounted for partly by the fact that this organ is variable in shape, partly by the bad condition of Ball's type (see above), and partly by the fact that a correct outline of the fin is not so easy to draw as might be imagined, because it is often so bent and twisted as not to be readily laid down on a plane surface.
2. The funnel-mantle connective is rather longer than indicated by Girard's phrase "s'inscrivant dans un triangle équilatéral."

The typical male specimen of Girard agrees fairly well in proportional dimensions with that of Ball; the former is considerably larger, the length of the mantle measuring 130 mm. as against 77 mm.

The more important measurements reduced to percentages of the length of the mantle are as follow :—

		<i>Girard's</i>		<i>Ball's</i>	
		<i>type.</i>		<i>type.</i>	
Mantle, length	...	100	...	100	
„ breadth	...	45	...	45	
Head, breadth	...	32	...	30	
Fin, length	...	50	...	39	
„ breadth	...	81	...	87	
		<i>Right.</i>	<i>Left.</i>	<i>Right.</i>	<i>Left.</i>
Arm, first	...	65	...	65	...
„ second	...	88	...	84	...
„ third	...	81	...	104	...
„ fourth	...	81	...	91	...
	...	71	...	69	...
			...	78	...
				84	...

It will be seen that in Ball's specimen the fin is proportionately shorter and the arms are proportionately longer than in Girard's type, but this is what would be expected in a less mature example.

3. Girard records the first arm as shorter than the fourth, whereas in Ball's specimen I have entered them as equal, but, as the differences are no greater between the pairs of arms in the one case than between two arms of the same pair in the other, the matter cannot be regarded as of any material consequence.
4. The hectocotylisation is about equally developed in the two arms of the fourth pair in Ball's specimen, but this is a sign of immaturity, as I have shown elsewhere (1891).
5. The apical group of suckers in the tentacle is not visible owing to the shrinking of the tip, but I do not find it present as a separate group distinct from the normal four series in well-preserved specimens of approximately the same size from Naples.

Dr. Jatta (1896, p. 76) has given a long and elaborately illustrated description of Neapolitan examples, which he refers to *T. veranyi* Girard. The principal points which call for notice in his description are as follow:—

(1). The head is stated to be *much broader* ("molto più largo") than the mantle-opening. This agrees with his figure and with the specimens I have received from Naples, though not with Girard's description nor with Ball's type, but it must be remembered that this latter has had the jaws removed, so the head may have shrunk.

(2) The horny ring of the arm-suckers is represented as toothed all round the circumference (*pl. 12. fig. 10*);

this, however, I feel justified in regarding as an error of the draughtsman, for specimens received from the Naples Zoological Station agree with Girard's description and with Ball's specimen (compare *fig.* 3).

(3) The horny ring of the large tentacular suckers is not described by Jatta, but the figure (*pl.* 12, *fig.* 13, 13*b*) shows the teeth of the horny ring neither so acute nor so widely separated as they appear to be in reality (see *fig.* 5).

The discrepancies above recorded are for the most part explicable as due to state of preservation or difference of age, and do not appear to be suitable for specific distinction. I therefore conclude that all the specimens of the genus *Todaropsis* are referable to one species, which, in accordance with the rules of nomenclature, should bear the name *T. eblanæ* (Ball).

Subjoined is a table of the synonymy, with references to descriptions and figures. References marked thus \* give no additional information.

1841. *Loligo Eblanæ*, Ball, On a species of *Loligo* found on the shore of Dublin Bay, *Proc. R. Irish Acad.*, vol. 1, p. 362-4, *figs.* 1-7.
1842. „ „ Ball, Acetabuliferous Cephalopoda of Ireland, *Op. cit.*, vol. 2, p. 192.
1844. *Loligo Eblanæ*, Thompson, Rep. Fauna Ireland, *Rep. Brit. Assoc.* for 1843, p. 248.\*
1845. *Loligo Eblanæ*, d'Orbigny, Moll. viv. et foss., p. 353.\*
1849. *Ommastrephes? Eblanæ*, Gray, Cat. Moll. Brit. Mus., part 1, p. 65.\*
1851. *Loligo sagittata*, Vérany, Moll. médit., céph., *pl.* 31.
1852. *Ommastrephes Eblanæ*, Forbes and Hanley, Brit. Moll., vol. 4, p. 235, *pl.* sss, *fig.* 2, 1853.
1856. *Loligo Eblanæ*, Thompson, Nat. Hist. Ireland, vol. 4, p. 270.

1869. *Ommatostrephes sagittatus*, Jeffreys, Brit. Conch., vol. 5, p. 130.
1880. *Omm.?* *Eblanæ*, Steenstrup, De Ommatostreph. Blæksprutters Forhold, *Oversigt K. Dansk Vid. Selsk. Forh.*, 1880, p. 27 (97).
1886. *Ommastrephes eblanæ*, Hoyle, Rep. Cephalopoda, Challenger Exped., p. 33; Catal. Rec. Ceph., *Proc. Roy. Phys. Soc. Edin.*, vol. 9, p. 243.
1889. *Todaropsis Veranyi*, Girard, Cephalopodes de Portugal, *Jorn. Sci. Lisboa* (2), vol. 1, p. 204, 1889.
1890. *Ommastrephes (Todaropsis) Veranyi*, Girard, Rév. Céph. Mus. Lisbonne, *Jorn. Sci. Lisboa* (2) vol. 1, p. 261, pl.; *op. cit.*, vol. 2, p. 43, photo.
1890. *Ommastrephes eblanæ*, Norman, Rev. Brit. Moll., *Ann. Mag. Nat. Hist.* (6) vol. 5, p. 476.
1891. *Illex eblanæ*, Hoyle, Note Brit. Ceph., *Journ. Mar. Biol. Assoc., N.S.*, vol. 2, p. 189, figs. 1, 2.
1891. *Todaropsis Veranyi*, Posselt, *Todarodes sagittatus*, *Vid. Medd. Naturh. Forening* for 1890 (1891), p. 357 (59).
1892. *Todaropsis Veranyi*, Girard, Céph. côtes de l'Espagne, *An. Soc. Esp. Hist. Nat.*, vol. 21, p. 10.
1893. *Todaropsis Eblanæ*, Posselt, Krit. Bemærkn. om "Loligo Eblanæ Ball," *Vid. Medd. Naturh. Forening*, 1892 (1893), p. i.
1896. *Todaropsis veranyi*, Jatta, Cefalopodi viv. Golfo di Napoli, *Fauna des Golfes von Neapel*, part 23, p. 76-80, pl. 2, fig. 7, pl. 12, figs. 4-19.
1897. *Todaropsis Veranyi*, Hoyle, Catal. Rec. Ceph., Suppl., *Proc. Roy. Phys. Soc. Edin.*, vol. 12, p. 371.
1897. *Todaropsis eblanæ*, Hoyle, *Loc. cit.*
1900. *Todaropsis Eblanæ*, Nichols, Mar. Moll. Ireland, *Proc. Roy. Dublin Soc.*, (3) vol. 5, p. 495.



1900. *Todaropsis eblancæ*, Pfeffer, Synopsis d. œgopsid. Ceph.,  
*Jahrb. Hamburg. Wiss. Anst.*, 17, p. 179.
1901. *Todaropsis eblancæ*, Hoyle, Brit. Mar. Moll., *Journ. Conch.*,  
vol. 10, p. 26.\*

The *Geographical Distribution* of the species as recorded up to the present time is as follows :—Dublin Bay (Warren *vide* Ball ; Ball ; Nichols) ; Belfast Bay, Bangor, Holywood, Carrickfergus (Thompson) ; Strangford Lough (Jeffreys) ; North-East of Ireland (Nichols) ; North Sea (Captain Gray *vide* Hoyle) ; Plymouth (Hoyle) ; Spain, Sanlúcar de Barrameda (Girard) ; Portugal, Cape de Roca (Girard) ; Mediterranean (Vérany) ; Bay of Naples (Jatta).

EXPLANATION OF PLATE.

*Fig. 1.* Outline sketch of the dorsal aspect of the head and body ; natural size.

*Fig. 2.* The inner aspect of the ventral arms, showing the hectocotylistation ;  $\times 2$ .

*Fig. 3.* The horny ring of a sucker from the middle of one of the lateral arms ;  $\times$  about 12.

*Fig. 4.* The right tentacular club ;  $\times \frac{3}{2}$ .

*Fig. 5.* The horny ring of one of the large tentacular suckers  $\times$  about 12.

*Fig. 6.* A single row of teeth from the radula ;  $\times 54$ .

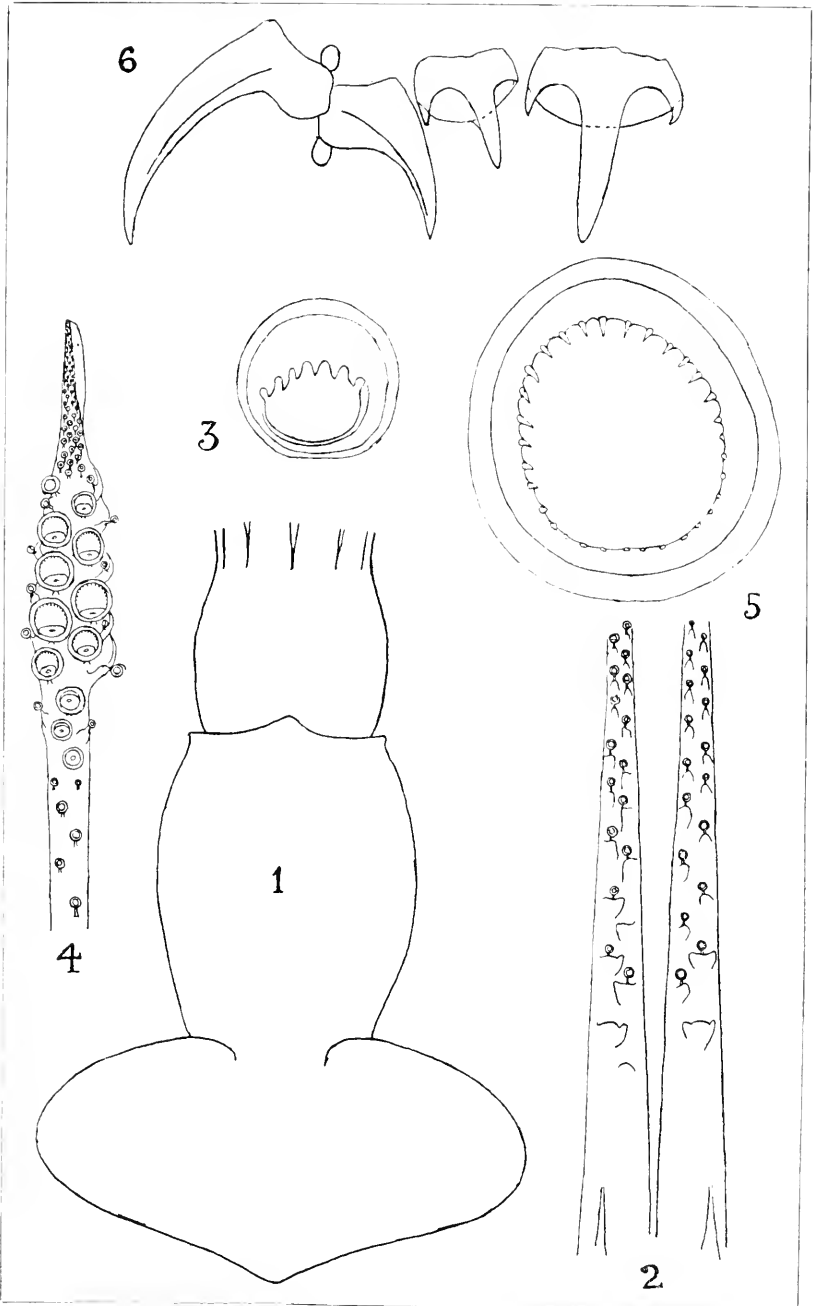

*Loligo eblanæ*, Type Specimen.



**X. Report on the Plants obtained by Mr. Rupert Vallentin in the Falkland Islands, 1901-1902.**

By J. COSMO MELVILL, M.A., F.L.S.

*Received and read March 17th, 1903.*

The Falkland Islands have been so fully described and their chief botanical distinctions so amply characterised in the exhaustive *Flora Antarctica* of Sir Joseph Dalton Hooker, that very little remains to be said on the subject. Mr. Rupert Vallentin has made two expeditions to this most interesting group, the first some four years ago, and the second last year, during which, at my request, he kindly collected for me a small series of (mostly endemic) species. In the accompanying catalogue I have appended all Mr. Vallentin's remarks as to individual species; these add considerably to their interest and value.

Mr. Vallentin's chief study was zoology, and Mr. Standen and I have already published\* the account of the Mollusca obtained during his first voyage, while others have described the Crustacea, etc. On this, his second expedition, he collected a few interesting Mollusks, which have yet to be worked out, and, as already remarked, the collection I am now exhibiting, which includes nearly one-half of the whole native flora of the Falkland Islands.

The most striking plants are undoubtedly the *Azorella*

\* *Journal of Conchology*, Vol. X., pp. 43 *sqq.*

or *Bolax glebaria* Comm., or Balsam-Bog, called "Gommier" by Pernetty. This is a plant almost impossible to preserve as a botanical specimen, appearing to consist of huge mounds of pale yellowish-green colour, almost as hard as stone. As remarked by Sir W. J. Hooker, a pleasant aroma arises from these mounds on a warm, sunny day. They stand alone, though gregarious, often as high as 5 feet from the ground, and frequently 8 feet in breadth. These mounds, when examined, are found to consist of closely imbricating leaves and young shoots, the older portions still adhering having died away from beneath, so that frequently these conglomerate masses resemble large balls. It is estimated that some of them must be many hundred years old. Each of them is, however, the product of a single seed. The plant has a tendency always to send out lateral ramifications, these dividing, and again subdividing, soon render the plant inextricably involved, and ultimately the surface becomes quite smooth. Lichens and mosses, and other parasitic plants make themselves a home whenever any inequality in the plant allows it. A gum, aromatic and healing, exudes from every part, and has been used as a styptic with some measure of success.

Another plant as conspicuous, and quite as interesting, descanted upon by every traveller who has visited these islands, is the famed Tussack (or Tussock) grass (*Poa caespitosa*), formerly considered a *Dactylis*.

This was discovered by Gaudichaud as a native of the Falkland Islands, and is also a native of the Straits of Magellan and Tierra del Fuego. It attains a height of six or seven feet. The report of the Botany of the Antarctic Voyage in H.M.S. 'Erebus' and 'Terror,' under the command of Sir James Clark Ross, written by Sir William Hooker,\* gives an exhaustive account of

\* Hooker, *London Journal of Botany*, Vol. II., pp. 285 sqq.

this grass, and expresses the conviction, quoting the report of Lieut. R. C. Moody, R.E., to the Colonial Office, that it is a most valuable pasture grass, if not *the* most valuable one known, and will grow well on soil unfitted for other plants, such as the most rank black peat bogs, etc., and Dr. (now Sir J. D.) Hooker, the botanist of the expedition, remarks that "with proper attention to its propagation "and locality near the coast, and preservation from being "entirely eaten down where it abounds already, the "Tussack grass would, alone, yield abundant pasturage "for as many cattle as there is ever likely to be a demand "for in the Falklands." It is the inner part of the stem, as far as 6 inches up from the root, that is most succulent, palatable, and wholesome. It has been suggested that the North of Scotland, where there are acres of moorland and peat bog, with the Orkney and Shetland Isles, not to mention Ireland, would be able to produce this grass with commercial success for the rearing of cattle. It has been pointed out, however, that the plant must learn that the northern seasons are diametrically opposed to those it is accustomed to in the Antarctic zone.

Mr. Darwin visited the Falklands in the memorable voyage of the 'Beagle' in 1834, and, while not particularly alluding to the Tussack grass, remarks on the extensive peat bogs and inhospitable climate of the islands, and also calls attention to the causes of its treeless wastes.

Dr. R. O. Cunningham, in 1866-1869, as naturalist during the voyage of H.M.S. 'Nassau' to the Straits of Magellan and the Falkland Islands, devotes several pages\* to an account of the *P. caespitosa*; we quote the following:—  
"This was the first opportunity that I enjoyed of visiting "a Tussac Grove, and it made a most striking impression

\* "Natural History of the Strait of Magellan," by R. O. Cunningham, pp. 296-399.

“on my mind as I wended my way along the narrow  
“winding natural pathways between the separate clumps  
“of grass, the leaves of which waved high overhead in  
“graceful curves. The average height of the plants I  
“should estimate as between 10 and 12 feet, while the  
“mass of roots belonging to each varied from a foot to a  
“foot and a half, by two to three feet diameter. Among  
“the roots, jackass penguins had formed their burrows  
“in numbers, and as we walked through the groves we  
“were accompanied by numerous individuals of a little  
“dusky brown bird, the *Opetiorynchus antarcticus*, which,  
“when we sat down, came quite close to us; the  
“military starling also was common, and hardly less  
“tame.”

The plants in following list, between 40 and 50 species, all found by Mr. Vallentin, are mostly also found in the Magellanic region; the Falklands possessing a very meagre flora, so far as absolutely peculiar species are concerned. As already shown, nothing approaching a tree is to be seen, *Chiliotrichum amelloideum*, a shrubby composite, the Tussack Grass, and *Bolax glebaria* being the only plants that are otherwise than stunted or prostrate.

Sir J. D. Hooker found about 110 species in the islands, some being of very wide distribution, e.g., *Cerastium vulgatum*, *C. arvense*, *Capsella bursa-pastoris*, and *Cardamine hirsuta*. No members of the families Leguminosæ and Labiatæ occur in the Falklands, with the exception of *Ulex europæus* L., the common Furze, which has been introduced by the colonists at a recent date.



CATALOGUE OF PLANTS FROM THE FALKLAND ISLANDS,  
COLLECTED BY MR. RUPERT VALLENTIN, IN 1901-02.\*

*Ranunculus biternatus* Sm.

"Grows near marshes and running streams in both the East and West Falklands." (R. V.)

*Caltha sagittata* Cav.

"A dwarf specimen. When growing by ponds, this species attains a larger size than our native marsh marigold (*C. palustris* L.)" (R. V.)

*Cardamine hirsuta* L.

*Cerastium arvense* L.

*Cerastium vulgatum* L.

*Sagina procumbens* L.

"Very local and always near settlements." (R. V.)

*Oxalis enneaphylla* Cav.

"Scurvy Grass, common." (R. V.)

*Ulex europæus* L.

"Another familiar plant, reminding one of home, was the common furze, which seemed to take very kindly to these chilly climes. Great bushes of it were in full flower soon after my arrival (in November), the masses of yellow forming a pleasing contrast to the universal greens and greys when viewed from the north side of the Harbour." (R. V.)

N.B.—This species is not mentioned in the "Flora Antarctica," so it must have been introduced comparatively lately.

*Rubus geoides* Sm.

"Wild Strawberry. Stone runs and valleys, very local." (R. V.)

*Acaena ascendens* Vahl.

"Growing near the sea and by streams of fresh water. Port Louis, E. Falkland, and Ray Cove, West Falkland." (R. V.)

\* *c.f.* "Notes of a Naturalist on his Voyage to the Falklands and back," by Rupert Vallentin. *Journ. Roy. Inst. Cornwall*, No. xlvii. These notes are mainly zoological, but contain allusions to the *Drosera* and *Taraxacum*.

*Drosera uniflora* Willd.

“By far the most interesting plant to me was a small species of Sundew, probably *D. uniflora*, which abounded in certain places near the town. It is of almost microscopical dimensions, and may be easily passed over by the pedestrian. I examined numberless specimens, but never detected any insects adhering to the leaves.” (R. V.)

*Gunnera magellanica* Lamk.

“Pig Olive, very common, E. and W. Falklands.” (R. V.)

*Myrtus Nummularia* Poir.

“Common in both the islands.” (R. V.)

*Montin fontana* L.

*Azorella lycopodioides* Gmel.

*Bolax glebaria* Comm.

*Apium graveolens* L.

“Celery, growing near the sea.” (R. V.)

*Nertera depressa* Banks.

*Chiliotrichum amelloideum* Cass.

“Fachino-bush.” (R. V.)

*Aster VahlII* Hook.

“Falkland Daisy. Common in marshy places, and distributed over both E. and W. Falklands.” (R. V.)

*Baccharis magellanica* Pers.

“A creeping shrub, common E. and W. Falklands, flowering at Christmastide.” (R. V.)

*Abrotanella emarginata* Cass.

*Senecio candidans* D. C.

“Sandy sea-shore, above high water mark. Scarce. Lake Point, E. Falklands, and Port North, W. Falklands.” (R. V.)

*Senecio falklandicus* Hook. f.

*α typicus*. “Common at Ray Cove, W. Falklands, not often found much above sea level.” (R. V.)

*β* var. “Common in both islands, called ‘Fachino’ by the colonists.” (R. V.)

*Senecio littoralis* Gaud.

“Common both in the E. and W. Falklands.” (R. V.)

*Nassauvia Gaudichaudii* Cass.

*Leuceria (Chabraea) suaveolens* D. C.

“Vanilla Daisy. Common on heaths in both the E. and W. Falklands.” (R. V.)

*Perezia (Homoianthus) echinulatus* Cass.

“Flowers white and lavender. Abundant on sandy ground.” (R. V.)

*Taraxacum officinale* Wigg.

“A form flourished on the cultivated ground in Stanley.” (R. V.)

*Gaultheria microphylla* Hook. f. (= *antarctica* Hook. f.)

This is the *Arbutus microphylla* Forst., and therefore this specific name has preference.

*Gentiana magellanica* Gaud.

“A common plant growing in marshes.” (R. V.)

*Primula farinosa* L.  $\beta$  *magellanica* Lehm.

*Empetrum rubrum* Vahl.

Conspecific with *E. nigrum* L. of the Northern Hemisphere, only differing in the colour of its berries. This is the ‘Diddle-Dee’ plant of the colonists.

*Pogonia (Codonorchis) Lessonii* Lindl.

*Sisyrinchium filifolium* Gaud.

“Pale Maidens. A spring flower, blooming in November, very generally distributed. The great majority of the wild flowers of the Falklands are *white*, this being due, I suppose, to the absence of continuous sunshine.” (R. V.)

*Callixene marginata* Comm.

*Astelia pumila* Br.

*Rostkovia grandiflora* Hook. f.

“On both hill-sides and marshy ground. Common in both E. and W. Falklands.” (R. V.)

*Gaimardia australis* Gaud.

Common in peaty swamps.

*Carex indecora* Kunth.

“Fairly common, but very local. At Roy Cove, W. Falklands only.” (R. V.)

*Poa caespitosa* Benth. and Hook. f.\*

(*Dactylis* ,, Forst.)

“Tussac Grass.” (R. V.)

*Triticum repens* L.

“Blue Grass, once common, now scarce. Very rare in Roy Cove, W. Falklands, hardly found except in unstocked islands.” (R. V.)

*Lomaria alpina* Steg.

“Very common in both E. and W. Falklands.” (R. V.)

*Lomaria magellanica* Desv.

“The commonest fern in both islands equally.” (R. V.)

*Gleichenia cryptocarpa* Hook.

“A tree fern, rare, Roy Cove, West Falklands.” (R. V.)

*Lycopodium clavatum* L. var. *magellanica*.

“Common in marshy places.” (R. V.)

A few marine Algæ were also collected, which are not yet worked fully out. *Macrocystis pyrifera* is most abundant on these shores, and attains gigantic proportions. On these Algæ Mr. Vallentin remarks (*loc. cit.*): “Under the euphonious name of Kelp, two species of *Lessonia* and *D'Urvillea*, and one of *Macrocystis*, are included. The two former seaweeds flourish along the shores of the open ocean, where they are swayed about in the surge; while the latter luxuriates in the many sheltered fiords, where it grows to an almost incredible length.”

\* No specimens existed in the collection of *Festuca Arundo* Hook. f. or *F. antarctica* Kunth, equally abundant in the islands, the former of which sometimes rivals the *F. caespitosa* in huge growth.

## THE WILDE LECTURE.

### XI. The Atomic Theory.

By Professor F. W. CLARKE, D.Sc.

*Delivered May 19th, 1903.*

One hundred years ago, on October 21, 1803, John Dalton gave this Society the first announcement of his famous atomic theory. It was only a slight preliminary notice, a mere note appended to a memoir upon another subject, and it attracted little or no attention. In 1804 Dalton communicated his discovery to Dr. Thomas Thomson, who at once adopted it in his lectures, and in 1807 gave it still wider publicity in a text-book. A year later Dalton published his "New System of Chemical Philosophy," and since then the history of chemistry has been the history of the atomic theory. To celebrate Dalton's achievement, to trace its influence upon chemical doctrine and discovery, is the purpose of my lecture. It is an old story, and yet a new one; for every year adds something to it, and the process of development shows no signs of nearing an end. A theory that grows, and is continually fruitful, cannot be easily supplanted. Despite attacks and criticisms, Dalton's generalisation still holds the field; and from it, as from a parent stem, spring nearly all the other accepted theories of chemistry.

Every thought has its ancestry. Let us briefly trace the genealogy of the atomic theory. In the very beginnings of philosophy men sought to discover the nature of the material universe, and to bring unity out of

*May 29th, 1903.*

diversity. Is matter one thing, or many? Is it continuous, or discrete? These questions occupied the human mind before recorded history began, and their vitality can never be exhausted. Final answers may be unattainable, but Thought will fly beyond the boundaries of knowledge, to bring back, now and then, truly helpful tidings.

To the early Greek philosophers we must turn for our first authentic statements of an atomic theory. Other thinkers in older civilisations, doubtless, went before them ; perhaps in Egypt or Babylonia, but of them we have no certain knowledge. There is a glimpse of something in India, but we cannot say that Greece drew her inspiration thence. For us Leucippus was the pioneer, to be followed later by Democritus and Epicurus. Then, in lineal succession, came the Roman, Lucretius, who gave to the doctrine the most complete statement of all. In the thought of these men the universe was made up of empty space, in which swam innumerable atoms. These were inconceivably small, hard particles of matter, indivisible and indestructible, of various shapes and sizes, and continually in motion. From their movements and combinations all sensible matter was derived. Except that the theory was purely qualitative and non-mathematical in form, it was curiously like the molecular hypothesis of modern physics, only with an absolute vacuum where an intermediary ether is now assumed. This notion of a vacuum was repellent to many minds; to conceive of a mass of matter so small that there could be none smaller was unreasonable; and hence there arose the interminable controversy between plenists and atomists which has continued to our own day. It is, however, essentially a metaphysical controversy, and some writers have ascribed it to a peculiar distinction between two

classes of minds. The arithmetical thinker deals primarily with number, which is, in its nature, discontinuous, and to him a material discontinuity offers no difficulties. The geometer, on the other hand, has to do with continuous magnitudes, and a limited divisibility of anything in space is not easy for him to conceive. But be this as it may, the controversy was one of words rather than of realities, and its intricacies have little interest for the scientific student of to-day. It is always easier to reason about things as we imagine they ought to be, than about things as they really are, and the latter procedure became practicable only after experimental science was pretty far advanced. The Greeks were deficient in physical knowledge, and therefore their speculations remained speculations only, mere intellectual gymnastics of no direct utility to mankind. They sought to determine the nature of things by the exercise of reason alone, whereas science, as we understand it, being less confident, seeks mainly to coördinate evidence, and to discover the general statement which shall embrace the largest possible number of observed relations. The man of science may use the metaphysical method as a tool, but he does so with the limitations of definite, verifiable knowledge always in view. Intellectual stimulants may be used temperately, but they need not be discarded altogether.

From the time of Lucretius until the seventeenth century of our era, the atomistic hypothesis received little serious attention. The philosophy of Aristotle governed all the schools of Europe, and scholastic quibblings took the place of real investigation. All scholarship lay under bondage to one master mind, and it was not until Galileo let fall his weights from the leaning tower of Pisa that the spell of the Stagirite was broken. Experimental science now came to the fore, and it was seen that even

Aristotelian logic must verify its premises. The authority of evidence began to replace the authority of the schools.

Early in the seventeenth century the atomic philosophy of Epicurus was revived by Gassendi, who was soon followed by Boyle, by Newton, and by many others. One other important step was taken also. Boyle, in his "Sceptical Chymist," gave the first scientific definition of an element, a conception which was more fully developed by Lavoisier later, but which received its complete modern form only after Davy had decomposed the alkalies and shown the true nature of chlorine. Without this preliminary work of Boyle and Lavoisier, Dalton's theory would hardly have been possible. An elementary atom can be given no real definition unless we have some notion of an element to begin with. But the strongest impulse came from Newton, who accepted atomism in clear and unmistakable terms. Coming before Newton, Descartes had rejected the atomic hypothesis, holding that there could be no vacuum in the universe, and making matter essentially synonymous with extension. True, Descartes, in his famous theory of vortices, imagined whirling particles of various degrees of fineness; but they were not atoms as atoms and molecules are now conceived. It may be dangerous to pick out landmarks in history, and to assert that such and such a movement began at such and such a time. Nevertheless, we may fairly say that the turning point in physical philosophy was Newton's discovery of gravitation, for that indicated mass as the fundamental property of matter. For any given portion of matter which we can segregate and identify, extension is variable and mass is constant; when that conclusion was established, the dominance of atomism became inevitable. Boyle, Newton, and Lavoisier were legitimate precursors of Dalton, but whether Boscovich should be so considered



is more than doubtful. His points of force were too abstract a conception to admit of direct application in the solution of real problems. Dalton certainly owed nothing to Boscovich, and would just as surely have developed his theory, had the brilliant Dalmatian never written a line.

To Boyle and Newton the atomic hypothesis was a question of natural philosophy alone; for, in their day, chemistry, as a quantitative science, had hardly begun to exist. Attempts were soon made, however, to give it chemical application, and the first of these which I have been able to find was due to Emanuel Swedenborg. This philosopher, whose reputation as a man of science has been overshadowed by his fame as a seer and theologian, published in 1721 a pamphlet upon chemistry, which is now more easily accessible in an English translation of relatively recent date.\* It consists of chapters from a larger unpublished work, and really amounts to nothing more than a sort of atomic geometry. From geometric groupings of small, concrete atoms, the properties of different substances are deduced, but in a way which is more curious than instructive. Between the theory and the facts there is no obvious relation. The book was absolutely without influence upon chemical thought or discovery, and therefore it has escaped general notice. It is the prototype of a class of speculative treatises, considerable in number, some of them recent, and all of them futile. They represent efforts which were premature, and for which the fundamental support of experimental knowledge was lacking.

In 1775, Dr. Bryan Higgins, of London, published the prospectus of a course of lectures upon chemistry, in

\* "Some specimens of a work on the Principles of Chemistry with other treatises." London, 1847. Originally published at Amsterdam, in Latin.

which the atomic hypothesis was strongly emphasised. It was still, however, only an hypothesis, quite as ineffectual as Swedenborg's attempt, and it led to nothing. Dr. Higgins recognised seven elements: earth, water, alkali, acid, air, phlogiston, and light; each one consisting of "atoms homogeneal," these being "impenetrable, immutable in figure, inconvertible," and all "globular, or nearly so." He speculated upon the attractions and repulsions between these bodies, but he seems to have solved no problem and to have suggested no research. William Higgins, on the other hand, whose work appeared in 1789, showed more insight into the requirements of true science, and had some notions concerning definite and multiple proportions. His conception of atomic union to form molecules was fairly clear, but the distinct statement of a quantitative law was just beyond his reach. In 1814, however, when Dalton's discoveries were widely known and accepted, Higgins published a reclamation of priority.\* In this, with much bitterness, he claims to have completely anticipated Dalton, a claim which no modern reader has been able to allow. In Robert Angus Smith's "Memoir of John Dalton and History of the Atomic Theory,"† the work of Bryan and William Higgins is quite thoroughly discussed, and therefore we need not consider the matter any more fully now. We see that atomic theories were receiving the attention of chemists long before Dalton's time, although none of them went much beyond the speculative stage, or was given serviceable form. They were dim foreshadowings of science; nothing more.

\* "Experiments and Observations on the Atomic Theory and Electrical Phenomena." By William Higgins, Esq, etc., Dublin, 1814.

† *Memoirs of the Literary and Philosophical Society of Manchester*, Second Series, Volume 13, 1856.

In order that a new thought shall be acceptable, certain prerequisite conditions must be fulfilled. If the ground is not prepared, the seed cannot be fruitful; if men are not ready, no harvest will be reaped. Only when the time is ripe, only when long lines of evidence have begun to converge, can a new theory command attention. Dalton's opportunity came at the right moment, and he knew how to use it well. Elements had been defined; the constancy of matter was established; pneumatic chemistry was well developed, and great numbers of quantitative analyses awaited interpretation. The foundations were ready for the master builder, and Dalton was the man. His theory could at once be tested by the accumulated data, and when that had been done it was found to be worthy of acceptance.

It is not my purpose to discuss in detail the processes of Dalton's mind. The story is told in his own notebooks, which have been given to the public by Roscoe and Harden,\* and it has been sufficiently discussed by others. We now know that Dalton was thoroughly imbued with the corpuscular ideas of Newton, and that, when studying the diffusion of gases, he was led to the belief that the atoms of different substances must be different in size. Upon applying this hypothesis to chemical problems, he discovered that these differences were in one sense measurable, and that to every element a single, definite, combining number, the relative weight of its atom, could be assigned. From this, the law of definite proportions logically followed, for fractions of atoms were inadmissible; and the law of multiple proportions, which Dalton worked out experimentally, completed the generalisation. The

\* "A new view of the origin of Dalton's Atomic Theory," etc. By Sir Henry E. Roscoe and Arthur Harden. London, 1896.

See also Debus, in *Zeits. Physikal. Chem.*, Bd. 20, p. 359, and a rejoinder by Roscoe and Harden in Bd. 22, p. 241.

conception that all combination must take place in fixed proportions was not new, and, indeed, despite the objections of Berthollet, was generally assumed; but the atomic theory gave a reason for the law, and made it intelligible. The idea of multiple proportions had also occurred, although incompletely, to others; but the determination of atomic weights was altogether original and novel. The new atomic theory, which figured chemical union as a juxtaposition of atoms, coördinated all of these relations, and gave to chemistry, for the first time, an absolutely general quantitative basis. The tables of Richter and Fischer, who preceded Dalton, dealt only with special cases of combination, but they established regularities which rendered easier the acceptance of the new and broader teachings. The earlier atomic speculations were all purely qualitative, and incapable of exact application to specific problems; Dalton created a working tool of extraordinary power and usefulness. Between the atom of Lucretius and the Daltonian atom the kinship is very remote.

Dalton was not a learned man, in the sense of mere erudition, but perhaps his limitations did him no harm. Too much learning is sometimes in the way, and clogs the flight of that imagination by which the greatest discoveries are made. The man who could not see the forest because of the trees was a good type of that scholarship which never rises above petty details. It may compile encyclopædias, but it cannot generalise. In some ways, doubtless, Dalton was narrow, and he failed to recognise the improvements which other men soon introduced into his system. The chemical symbols which he proposed were soon supplanted by the better formulæ invented by Berzelius, and his views upon the densities of gases were set aside by the more exact work of Gay Lussac, which Dalton never fully appreciated. As an experi-

menter he was crude, and excelled by several of his contemporaries ; his tables of atomic weights, or rather equivalents, were only rough approximations to the true values. These defects, however, are only spots upon the sun, and in no wise diminish his glory. Dalton transformed an art into a science, and his influence upon chemistry was never greater than it is to-day. The truth of this statement will appear when we trace, step by step, the development of chemical doctrine. The guiding clue, from first to last, is Dalton's atomic theory.

Although Dalton first announced his theory in 1803, the publication of his "System" in 1808 marks the culmination of his labours. The memorable controversy between Proust and Berthollet had by this time exhausted its force, and nearly all chemists were satisfied that the law of definite or constant proportions must be true. The idea of multiple proportions was also easily accepted ; and as for the combining numbers, they, after various revisions, came generally into use. The atomic conception, however, made its way more slowly, for the fear of metaphysics still governed many acute minds. Davy especially was late in yielding to it, but in time even his conversion was effected. Thomson, as we have already noted, was the earliest and most enthusiastic disciple of the new system, and Wollaston, although cautiously preferring the term "equivalent" to that of atomic weight, made useful contributions to the theory. These names mark the childhood of the doctrine, before its vigorous growth had thoroughly begun.

The development of the atomic theory followed two distinct lines, the one chemical, the other physical in direction. On the chemical side the leader was Berzelius, who began in 1811 the publication of his colossal researches upon definite proportions. At first he seems to have

been influenced by Richter rather than by Dalton, but that bias was only temporary. For more than thirty years Berzelius continued these labours, inventing symbols, establishing formulæ, and determining atomic weights. He, above all other men, made the atomic theory applicable to general use, a universal tool suited to practical purposes. Turner, Penny, Erdmann and others did noble work of the same order, but Berzelius overshadowed them all. Throughout his long career he was almost the dictator of chemistry.

It was on the physical side, however, that the theory of Dalton was most profoundly modified. First came the researches of Gay Lussac, who in 1808 showed that combination between gases always took place in simple relations by volume, and also that all gaseous densities were proportional either to the combining weights of the several substances, or to rational multiples thereof. In 1811 Avogadro generalised the new evidence, and brought forward the great law which is now known by his name. Equal volumes of gases, under like conditions of temperature and pressure, contain equal numbers of molecules. Mass and volume were thus covered by one simple expression, and both were connected with the weights of the fundamental atoms. Avogadro, moreover, distinguished clearly between atoms and molecules, a distinction which is of profound importance to chemistry, although it is not always properly appreciated by students of physics. The molecule of to-day, which is usually, but not always, a cluster of atoms, is identical with the atom of the pre-Daltonian philosophers; while the chemical unit represents a new order of divisibility which the Ancients could never have imagined. A molecule of water was easily conceived by them, but its decomposition into smaller and simpler particles of oxygen and hydrogen, the chemical atoms,

was far beyond the range of their knowledge. That the distinction is not always borne in mind by physicists is illustrated by the fact that in Clerk Maxwell's article "Atom," in the *Encyclopædia Britannica*, Dalton is not even mentioned, and that the phenomena there selected for discussion are molecular only. Maxwell was surely not ignorant of the difference between atoms and molecules, but his knowledge had not reached the point of complete realisation. His thought was of molecules, and so Maxwell unconsciously neglected the real subject of his chapter, the atom. Of late years many essays upon the atomic theory have been written from the physical side, and few of them have been free from this particular ambiguity. At first, a similar error was committed by chemists, who paid small attention to Avogadro's law, and so the latter failed to exert much influence upon chemical thought until more than forty years after its promulgation. The relation discovered by Dulong and Petit in 1819, that the specific heat of a metal was inversely proportional to its atomic weight, was more speedily accepted; but even this law did not receive its full application until many years later. To apply either of these laws to chemical theory involved a clearer discrimination between atomic weights and equivalents than was possible at the beginning. A long period of doubt and controversy was to work itself out before the full force of the physical evidence could be appreciated. Mitscherlich's researches upon isomorphism were more fortunate, and gave immediate help in the determination of atomic weights and the settlement of formulæ. For the moment we need only note that the chemical atom was the underlying conception by means of which all these lines of testimony were to be unified.

From Dalton and Gay Lussac to Frankland and

Cannizzaro was a time of fermentation, discussion, and discovery. In chemistry, contrary to the saying of the preacher, there were many new things under the sun, and some of the discoveries were most suggestive. First it was found that certain groups of atoms could be transferred from compound to compound, almost as if they were veritable elements; and radicles such as ammonium, cyanogen and benzoyl were generally recognised. I say "groups of atoms" advisedly, for as such they were regarded, and they could hardly have been interpreted otherwise. Then came the discovery of isomerism; of the fact that two substances could be strikingly different, and yet composed of the same elements in exactly the same proportions. This was only explicable upon the supposition that the atoms were differently arranged within the isomeric molecules, and it led investigators more and more to the study of chemical or molecular structure. Without the atomic theory the phenomena would have been hopelessly bewildering; with its aid they were easy to understand, and fertile in suggestions for research. Still another link in the chain of chemical reasoning was forged by Dumas, when he proved that the hydrogen of organic compounds was often replaceable, atom for atom, by chlorine. Sometimes the replacement was complete, sometimes it was only partial, and the latter cases were the most significant. In acetic acid, for example, one, two, or three fourths of the hydrogen could be successively replaced, but the last fourth was permanently retained. Hydrogen, then, was combined in acetic acid in two different ways, one part yielding its place to chlorine, the other being unaffected. This behaviour was soon found to be by no means exceptional; indeed, it was very common, and it opened a new line of attack upon the problems of chemical constitution. The existence of



radicles, the formation of isomers, and the substitution of one element by another, were facts which strengthened the atomic theory and seemed to be incapable of reasonable interpretation upon other terms. Their connection with one another, however, was not well understood, and wearisome discussions preceded their coördination under one general law.

With the tedious controversies which distracted chemists between 1830 and 1850, we have nothing now to do; they were important in their day, but they do not come within the scope of the present argument. Theory after theory was advanced, prospered for a time, and then decayed; and chemical literature is crowded with their fossil remains. Each one, doubtless, indicated an advance in knowledge, but each one also exaggerated the importance of some special set of relations, and so overshot the mark. During this period, however, Faraday discovered the law of electrolysis which is now known by his name, and the chemical equivalents were thereby given another extension of meaning. The electrochemical theories of Berzelius had fallen to the ground, but Faraday's law came as a permanent addition to the physical side of chemistry.

During the sixth decade of the nineteenth century, two important forward steps were taken. The kinetic theory of gases gave new force to Avogadro's law, and made its complete recognition by chemists necessary. Atoms, molecules, equivalents, and atomic weights needed to be more sharply defined, and in this work many chemists shared. Berzelius had proposed a system of atomic weights which differed, except in the value taken for its base, but little from the one now in use. This was abandoned for a table devised by Gmelin, in which the laws of Avogadro and of Dulong and Petit were almost

if not entirely ignored. Laurent and Gerhardt attempted to reform the system, but it was left for Cannizzaro, in 1858, to succeed. By doubling some of the currently accepted atomic weights, order was introduced into the prevailing chaos, and the chemical constants were brought into harmony with the physical laws. The modern atomic weights and our present chemical notation may be dated from this time, even though the preliminary anticipations of them were neither few nor inconspicuous.

The second great step forward was accomplished through the labours of several men. Frankland and Kekulé were foremost among them, but Couper, Odling, Williamson, Wurtz, and Hofmann all contributed their share to the upbuilding of a new chemistry, of which the doctrine of valency was the corner stone. A new property of the chemical atom was brought to light, and structural or rational formulæ became possible. Each atom was shown to have a fixed capacity for union with other atoms, a capacity which could be given numerical expression; and from this discovery important consequences followed. An atom of hydrogen unites with one other atom only; the atom of oxygen may combine with two; that of nitrogen with three or five; while carbon has capacity for four. All unions of atoms to atoms within a molecule are governed by conditions of this order, and the limitations thus imposed determine the possibilities of combination in a given class of compounds. In organic chemistry the conception of valency has been most fruitful, and it has shown the prophetic power which is characteristic of all good theories. It explains radicles and isomers; it predicts whole classes of compounds in advance of their actual discovery; and it has guided economic investigations from which great industries have sprung. The former partial theories regarding chemical

constitution fell into their proper places under the new generalisation, for that was broad enough to comprehend them all. All constitutional chemistry depends upon this property of the atoms, and any other adequate foundation for it would be difficult to find.

I have said that the discovery of valency explained the phenomena of isomerism. Indeed, it enabled chemists to foresee the existence of new isomers, and it established the conditions under which such compounds could exist. And yet, in one direction at least, its power was limited, and substances were found which the theory could not interpret. Tartaric acid, for example, exists in two modifications, differing in crystalline form and in their action upon polarised light. One acid was dextro-, the other laevorotatory, while a mixture of the two in equal proportions was neutral to the polarised beam, and gave no rotation at all. Their crystals exhibited a similar difference in the arrangement of certain planes, one set being right-handed, the other left-handed; and each crystal resembled its isomer like a reflection in a mirror, alike, but reversed. For a long time this physical isomerism, as it was called, remained inexplicable, for the rules of valency gave to both molecules the same structure, and offered no hint as to the cause of difference. Structural formulæ, however, said nothing of the arrangement of the atoms in tridimensional space, and it was soon suspected that the root of the difficulty was here. The mere linking of the atoms with one another could be represented in a single plane, but that was obviously an imperfect symbolism.

In 1874 van't Hoff and Le Bel, working independently of each other, suggested a solution of the problem. One simple assumption was enough; merely that the quadrivalent carbon atom was essentially a tetrahedron, or, more

precisely, that its four units of chemical attraction were exerted, from a common centre, in the direction of four tetrahedral angles. Atoms of that kind could be built up into structures in which righthandedness and lefthandedness of arrangement appeared, provided only that each one was united with four other atoms or groups all different in nature. Stereo-chemistry was born, the anomalies vanished, and many new substances showing optical and crystalline properties analogous to those of tartaric acid were soon prepared. The theory of van't Hoff and Le Bel was fertile, and therefore it was justified; it interpreted another set of phenomena, but, in order to do so, something like atomic form had first to be assumed. It was only a new extension of Dalton's atomic theory, but it has suggested a future development of extraordinary significance. If we can determine, not merely the linking of the atoms, but also their arrangement in space, we should be able, sooner or later, to establish a connection between chemical composition and crystalline form. The architecture of the molecule and the architecture of the crystal must surely, in some way, be related. But the problem is exceedingly complex, and we may have to wait many years before we reach its solution. The atomic theory still has room to grow.

Let us now turn back in time, and consider another phase of our subject. In 1815 Prout suggested that the atomic weights of all the elements were even multiples of that of hydrogen. It was only a speculation on the part of Prout, and yet it led to important consequences, for it opened a discussion upon the nature of the chemical elements, and it pointed to hydrogen as the primal matter of the universe. Prout's hypothesis, therefore, became a subject of controversy; it found many supporters and also many antagonists; but, fortunately, one aspect of it was

capable of experimental investigation. Some of the most exact and elaborate determinations of atomic weight have been made with the direct purpose of testing the truth or falsity of Prout's speculation, and science thereby has been notably enriched. The marvellous researches of Stas, for instance, had this specific object in view. The verdict was finally unfavourable to Prout; at least, the best measurements fail to support his idea; but it still has advocates who believe that the experimental data are vitiated by unknown errors, and that future investigations will reverse the decision. In science there is no court of last appeal.

Prout's hypothesis, then, stimulated the determination of atomic weights, and so helped us to a more accurate knowledge of them. It also led to a search for other relations between these constants, and thus paved the way for important discoveries. Döbereiner, Kremers, Dumas, Pettenkofer, Cooke and many other chemists published memoirs upon this theme, but not one of them was general or conclusive.\* Groups of elements were compared and relations were brought to light, but an exhaustive study of the question was hardly possible until after Cannizzaro had revised the atomic weights and indicated their proper values.

In 1865, Newlands presented before the London Chemical Society a communication upon the law of octaves, in which he showed that the elements, when arranged in the order of their atomic weights, exhibited a certain regular recurrence of properties. Unfortunately, his views were not given serious attention, and even met with ridicule, but they contained the germ of a great truth.

\* A very full account of these attempts is given in Venable's book, "The Development of the Periodic Law." Published at Easton, Pennsylvania, in 1896.

It was reserved for the Russian, Mendeléeff, four years later, to completely formulate the famous periodic law.

Mendeléeff arranged the elements in tabular form, still following the order of their atomic weights. A periodic variation of their properties, including the property of valency, at once became evident; and although the scheme was, and still is, open to some criticism, its importance could hardly be denied. In the table, certain gaps appeared, presumably belonging to unknown elements, and for three of these some remarkable predictions were made. The hypothetical elements were described by Mendeléeff, their atomic weights were assigned and their physical properties foretold, and in due time the prophesies were verified. The three metals gallium, scandium and germanium have since been discovered, and they correspond very closely with Mendeléeff's anticipations. His general conclusion was that all of the physical properties of the chemical elements are periodic functions of their atomic weights, and this conclusion, I think, is no longer seriously doubted. The curves of atomic volumes and melting points which Lothar Meyer afterwards constructed, give strong support to this view.

The periodic system, then, gives to the numbers discovered by Dalton a much more profound significance than he ever imagined, and is destined to connect a great mass of physical data in one general law. That law we now see, "as in a glass, darkly"; its complete mathematical expression is yet to be found, but I believe that it will be fully developed within the near future. We may have a spiral curve to deal with, as in the schemes proposed by Stoney or by Crookes, or else a vibratory expression like that suggested by Emerson Reynolds in his presidential address before the Chemical Society last year; but in some form the periodicity of

the elements must be recognised, and one set of relations will connect them all. In the arrangement proposed by Reynolds the inert gases, the elements of zero valency, appear at the nodes of a vibrating curve, a circumstance which gives this method of presentation a peculiar force. But for the consideration of physical properties the curves drawn by Lothar Meyer seem likely to be the most useful. In one respect, however, the periodic system is still defective; it fails to take adequately into account the numerical relations between the atomic weights, a phase of the problem which should not be ignored. Such relations exist; some of them have been indicated by your distinguished fellow-member, Dr. Wilde; and, elusive as they may seem to be, they are surely not meaningless. The final law must cover the entire ground, and then atomic weights, physical properties and valency will be completely correlated. Prout's hypothesis is discredited, and yet it may prove to be a crude first approximation to some deeper truth, as the probability calculations of Mallet\* and of Strutt† would seem to indicate. The approaches of the atomic weights to whole numbers are too close and too frequent to be regarded as purely accidental. But this is aside from our main question. The real point to note is, that the physical properties of the elements are all interdependent, and that the fundamental constants are the atomic masses.

Do I seem to exaggerate? Then look for a moment at the present condition of physical chemistry, and see how moderate my statements really are. We have not only the laws already mentioned, of Avogadro, of Dulong and Petit, of Faraday and of Mendeléeff, but also a multitude of relations connecting the physical constants of bodies with their chemical character. Even the wave-

\* *Phil. Trans.*, vol. 171, 1881, p. 1003. † *Phil. Mag.*, (6) 1, p. 311.

lengths of the spectral lines are related to the atomic weights of the several elements, as has been shown by the researches of Runge and his colleagues, of Rummel,\* and of Marshall Watts,† If we try to study the specific gravity of solids or liquids, the only clues to regularity are furnished by the atomic ratios. Atomic and molecular volumes give us the only approximations to anything like order. Similarly, we speak of atomic and molecular refraction, of molecular rotation for polarised light, of molecular conductivity, and the like. In Trouton's law, the latent heat of vapourisation of any liquid becomes a function of the molecular weight. And, finally, all thermochemical measurements are meaningless until they have been stated in terms of gramme molecular weights; then system begins to appear. Chaos rules until the atomic or molecular weight is taken into account; with that considered, the reign of order begins.

Even to the study of solutions the same conditions apply. Substances in solution exert pressure, and in this respect they closely resemble gases van't Hoff has shown that equal volumes of solutions, having under like conditions equal osmotic pressures, contain equal numbers of molecules, and thus Avogadro's gas law is curiously paralleled. The two laws are even equivalent in their anomalies. The abnormal density of a gas is explained by its dissociation, and the variations from van't Hoff's law are explicable in the same way. The theory of ionic or electrolytic dissociation, proposed by Arrhenius, shows that certain substances, when dissolved, are split up into their ions, and through this conception the analogy between gases and solutions is made absolutely complete. The ions, however, are atoms or groups of atoms; and

\* *Proc. Roy. Soc. Victoria*, vol. 10, part I., p. 75.

† *Phil. Mag.* (6), 5, 203.



just as Avogadro's law is applied to the determination of molecular weights among gases, so van't Hoff's rules enable us to measure the molecular weights of substances in solution. The atom, the molecule, and the molecular weight enter into all of these new generalisations. In short, if we take the atomic theory out of chemistry, we shall have little left but a dust-heap of unrelated facts.

I have now indicated, briefly and in outline only, the influence of the atomic theory upon the development of chemical thought. Details have been purposely omitted; the salient facts are enough for my purpose, and they make, at least for chemists, an exceedingly strong case. The convergence of the testimony is remarkable, and when we add to the chemical evidence that which is offered by physics, the theory becomes overwhelmingly strong. This side of the question I cannot attempt to discuss, but I may in passing just refer to Professor Rücker's presidential address before the British Association in 1901, which covers the ground admirably. The atomic theory has had no better vindication.

And yet, from time to time, we are told that the theory has outlived its usefulness, and that it is now a hindrance rather than a help to science. Some of the objectors are quite dogmatic in their utterances; some only seek to evade the theory, without going to the extreme of an absolute denial; and still others, more timid, assume an apologetic tone, as if the atom were something like a poor relation, to be recognised and tolerated, but not to be encouraged too far. Now caution is a good thing, if it is not allowed to degenerate into indecision; when that happens, mental obscurity is the result. In science we must have intellectual resting-places; something to serve as a foundation for our thinking; something concrete and tangible in form. No theory is immune

against hypercriticism ; none is absolute and final ; with these considerations borne in mind we may ask whether a doctrine is serviceable or not, and we can use it without fear. When we say that matter, as we know it, behaves as if it were made up of very small, discrete particles, we do not lose ourselves in metaphysics, and we have a definite conception which can be applied to the correlation of evidence and the solution of problems. Objections count for nothing against it until something better is offered in its stead, a condition which the critics of the atomic theory have so far failed to fulfil. They give us no real substitute for it, no other working tool, and so their objections, which are too often metaphysical in character, command little serious attention. Criticism is useful, just so far as it helps to clarify our thinking ; when it becomes a mere agent of destruction it loses force.

Broadly speaking, then, the modern critics of the atomic theory have shaken it but little. Still, some serious attempts have been made towards forming an alternative system of chemistry, or at least a system in which the atom shall not avowedly appear. The most serious, and perhaps the most elaborate of these devices was that brought forward in 1866 by Sir Benjamin Brodie,\* in his "Calculus of Chemical Operations," which he defended later (1880) in a little book entitled "Ideal Chemistry." In this curious investigation, Brodie tries to avoid hypotheses, and to represent chemical acts as operations upon the unit of space by which weights are generated. This notion is a little difficult to grasp, but Brodie's procedure was perfectly legitimate. His one fundamental assumption is that hydrogen is so generated by a single operation, and upon this he erects a system of symbols, which, treated mathematically, lead to some remarkable

\* *Phil. Trans.*, 1866. A second part in 1877.

conclusions. For instance, chlorine, bromine, iodine, nitrogen, and phosphorus become compounds of hydrogen with as many unknown or "ideal" elements, which no actual analysis has yet identified. That is, the known phenomena of chemistry seem to be less simply interpreted by Brodie's calculus than in our commonly accepted theories, and certain classes of phenomena are not considered at all. It is true that Brodie never completed his work, but it is not easy to see how his notation and reasoning could have accounted for isomerism, much less for the facts which stereochemistry seeks to explain.

Just here we find the prime difficulty of all attempts to evade the atomic theory. Up to a certain point we can easily dispense with it, for we can start with the fact that every element has a definite combining number, and then, without any assumptions as to the ultimate meaning of these constants, we can show that other constants are intimately connected with them. So far, we can ignore the origin of the so-called atomic weight; but the moment we encounter the facts of isomerism or chemical structure, and of the partial substitution of one element by another, our troubles begin. The atomic theory connects all of these data together, and gives the mind a simple reason for the relations which are observed. We cannot be satisfied with mere equations; our thoughts will seek for that which lies behind them; and so the anti-theorist fails to accomplish his purpose because he leaves the human mind out of account. The reasoning instrument has its own laws and requirements, and they, as well as the empirical observations of science, must be satisfied. Even in astronomy the law of gravitation is not enough; men are continually striving to ascertain its cause; and no number of failures can prevent them from trying again and yet again to penetrate into the heart of the mystery. In

the atomic theory the same tendency is at work, and the very nature of the atom itself, that thing which we can neither see nor handle, has become a legitimate subject for our questionings. Shall we, having gone so far, assume that we can go no further?

“All roads lead to Rome.” If we accept the atomic theory, we sooner or later find ourselves speculating about the reality of the atom, and at last we come face to face with the old, old problem of the unity or diversity of matter. We can, if we choose, employ the theory as a working tool only, and shut our ears to these profounder questions; but it is not easy to do so. What is the chemical atom? Is all matter ultimately one substance? We may be unable to solve either problem, and yet we can examine the evidence and see which way it points.

I think that all philosophical chemists are now of the belief that the elements are not absolutely distinct and separate entities. In favour of their elementary nature we have only negative evidence, the mere fact that with our present resources we are unable to decompose them into simpler forms. On that side of the argument there is nothing more. On the other hand we see that the elements are bound together by the most intimate relations, so much so that unknown elements can be accurately described in advance of their discovery, and facts like these call for an explanation. Something belonging to the elements in common seems to underlie them all. If, however, we study the atomic weights, we are forced to observe that the elements do not shade into one another continuously, but that they vary by leaps which are sometimes relatively large, and sometimes quite small. To Mendeléeff this irregular discontinuity is an argument against the unity of matter, or, rather, an indication that the periodic law lends no support to the belief; but such

a conclusion is unnecessary. If the fundamental matter, the "protyle," as Crookes has called it, is itself discontinuous and atomic in structure, the same property must be shown in all of its aggregations, and so the difficulties seen by Mendeléeff disappear. The chemical atoms become clusters of smaller particles, whose relative magnitudes are as yet unknown.

That bodies smaller than atoms really exist, is the conclusion reached by J. J. Thomson\* from his researches upon the ionisation of gases. According to him, this phenomenon "consists in the detachment from the atom of a negative ion," this being "the same for all gases." He regards "the atom as containing a large number of smaller bodies," which he calls "corpuscles," and these are equal to one another. "In the normal atom this assemblage of corpuscles forms a system which is electrically neutral." It must be borne in mind that these conclusions are drawn by Thomson from the study of one class of phenomena, and it is of course possible that they may not be finally sustained. Their value to us at the present moment lies in their suggestiveness, and in the curious way in which they reinforce other arguments of similar purport. The possibility that the chemical atoms can be actually broken down into smaller particles of one and the same kind, is, to say the least, startling, but it cannot be disregarded. The evidence obtained by Thomson is, so far as it goes, positive, and it is entitled to receive due weight in all discussions of our present problem. It is the first *direct* testimony that we have been able to obtain, all previous evidence being either negative or circumstantial. It may be misinterpreted, but it is not to be pushed aside.

\* *Phil. Mag.*, (5), 48, p. 547. Also *Popular Science Monthly*, August, 1901.

In direct line with the inferences of Thomson are the results obtained by Rutherford and Soddy in their researches upon radio-activity. Here, again, we have a subject so new that all opinions concerning it must be held open to revision, but so far as we have yet gone the evidence seems to point in one way. Rutherford and Soddy\* have studied especially the emanations given off by thorium, and conclude that from this element a new body is continually generated, in which the radio-activity steadily decays. This loss of emanative power is in some sort of equilibrium with the rate of its formation. When thorium is "de-emanated," it slowly regains its emanative power. The emanation is a "chemically inert gas, analogous in nature to the members of the argon family." The final conclusion is, that radio-activity may be "considered as a manifestation of sub-atomic chemical change." This word "sub-atomic" is one of ominous import. It implies atomic complexity, and it also suggests something more. The property of radio-activity is most strikingly exhibited by the metals radium, thorium and uranium; and these have the highest atomic weights of any elements known. If the elements are complex, these are the most complex, and therefore, presumably, the most unstable. Are they in the act of breaking down? Is there a degradation of matter comparable with the dissipation of energy? We can ask these questions, but we may have to wait long for a reply. There is, however, another side to the shield; and the universe gives us glimpses of a generative process, an elementary evolution.

The truth or falsity of the nebular hypothesis is still an open question. It is a plausible hypothesis, however, and commands many strong arguments in its favour. We can see the nebulae, and prove them to be clouds of

\* *Phil. Mag.*, (6) 4 pp. 395, and 581.

incandescent gas ; we can trace a progressive development of suns and systems, and at the end of the series we have the habitable planet upon which we dwell. The nebular hypothesis accounts for the observed condition of things, and is therefore, by most men, regarded as satisfactory. But this is not all of the story. Chemically speaking, the nebulae are exceedingly simple in composition ; the whiter and hotter stars are a little more complex ; then come stars like our sun, and finally the finished planets with their many chemical elements and their myriads of compounds. Here again we have evidence bearing upon our problem, evidence which led me,\* more than thirty years ago, to suggest that the evolution of planets from nebulae had been accompanied by an evolution of the elements themselves. This thought, stated in a reversed form, has since been developed and amplified by Lockyer, and it is doubtless familiar to you all. In the development of the heavenly bodies we seem to see the growth of the elements ; do we, in the phenomena of radio-activity, witness their decay ? This is a startling, possibly a rash speculation, but it rests upon evidence which must be considered and weighed.

We have, then, various lines of convergent testimony, and there are more which I might have cited, all pointing to the conclusion that the chemical atoms are complex, and that elemental matter, in the last analysis, is not of many kinds. That there is but one fundamental substance only, is not proved ; and yet the probability in favour of such an assumption must be conceded. Assuming it to be true, what then is the nature of the Daltonian atom ?

To the chemist, the simplest answer to this question is that furnished by the researches of J. J. Thomson, to

\*“ Evolution and the Spectroscope.” *Popular Science Monthly*, January, 1873.

which reference has already been made. A cluster of smaller particles or corpuscles satisfies the conditions that chemistry imposes on the problem, their ultimate nature being left out of account. For chemical purposes we need not inquire whether the corpuscles are divisible or indivisible, although for other lines of investigation this question may be pertinent. But no matter how far we may push our analysis, we must always see that something still lies beyond us, and realise that nature has no assignable boundaries. That which philosophers call "the absolute" or "the unconditioned" is for ever out of our reach.

Through many theories men have sought to get back a little farther. Among these, Lord Kelvin's theory of vortex atoms is perhaps the most conspicuous, and certainly the best known. It pre-supposes an ideal perfect fluid, continuous, homogeneous, and incompressible; portions of this in rotation form vortex rings, which, when once set in motion by some creative power, move on indestructively for ever. These rings may be single, or linked or knotted together, and they are the material atoms. The assumed permanence of the atom is thus accounted for, and given at least a mathematical validity, but we have already seen that the chemical units may not be quite so simple. The ultimate corpuscles, to use J. J. Thomson's word, may be vortex rings; the chemical atom is much more complex. On this theory, chemical union has been explained by supposing that vortices are assembled in rotation about one another, forming groups which are permanent under certain conditions, and yet are capable of being broken down. The vortex ring is eternal, its groupings are transitory. This is a plausible and fascinating theory; if only we can imagine the ideal perfect fluid and apply to it the laws of motion; that done, all else follows. Unfortunately, however, the fundamental conception is difficult to grasp, and



still more difficult to apply. So far, it has done little or nothing for chemistry; it has brought forth no discoveries, nor stimulated chemical research; we can only say that it does not seem to be incompatible with what we think we know. In a certain way it unifies the two opposing conceptions of atomism and plenism, and this may be, after all, its chief merit.

But there are later theories than that of Kelvin, and some of them are most daring. For instance, Professor Larmor regards electricity as atomic in its nature, and supposes that there are two kinds of atoms, positive and negative electrons. These electrons are regarded as centres of strain in the ether, and matter is thought to consist of clusters of electrons in orbital motion round one another. Still more recently, Professor Osborne Reynolds, in his Rede lecture,\* has offered us an even more startling solution of our problem. He replaces the conventional ether by a granular medium, generally homogeneous, closely packed, and having a density ten thousand times that of water. Here and there the medium is strained, producing what Reynolds calls "singular surfaces of misfit" between the normally piled grains and their partially displaced neighbours. These surfaces are wave-like in character, and constitute what we recognise as ordinary matter. Where they exist there is a local deficiency of mass, so that matter is less dense than its surroundings; and this, as Reynolds has said, is a complete inversion of the ideas which we now hold. Matter is measured by the absence of the mass which is needed to complete a normal piling of the grains in the medium. In other words, it might be defined as the defect of the universe. The "singular surfaces" already mentioned are

\* "On an Inversion of Ideas as to the Structure of the Universe." Cambridge, 1903. The Rede Lecture, delivered June 10th, 1902.

molecules, which may cohere, but cannot pass through one another, and they preserve their individuality. Possibly I may misapprehend this theory, for it has been published in a most concise form, and the reasoning upon which it rests is not given in detail. I cannot criticise it, but I may offer some suggestions. If matter consists of waves in a universal medium, how does chemical union take place? Shall we conceive of hydrogen as represented by one set of waves and nitrogen by another, the two differing only in amplitude? If so, when they combine to form ammonia there should be either a superposition of one set upon the other, or else a complex system might be found showing interference phenomena. But would not the latter supposition imply a destruction of matter as matter is defined by the theory? Could one such wave coalesce with or neutralise another? To conceive of a union of waves without interference is not easy, but the facts of chemical combination must be taken into account. When we remember that compounds exist containing hundreds of atoms within the molecule, we begin to realise the difficulties which a complete theory of matter must overcome. Chemical and physical evidence must be taken together; neither can solve the problem alone. At present, the simplest conception for the mind to grasp is that of an aggregation of particles. Beyond this all is confusion, and mathematical devices can help us only a little. In speaking thus I assign no limit to the revelations of the future; some theory, now before the world, may prove its right to existence and survive; but none such, as yet, can be taken as definitely established. The theory which stands the test of time will not be a figment of the imagination; it must be an expression of observed realities. But enough of speculation; let me, before I close, say a few words of a more practical character.

Dalton's statue stands in Manchester, a fitting tribute to his fame. But it is something which is finished, something on which no more can be done, something to be seen only by the few. As a local memorial it serves a worthy purpose, but Dalton's true monument is in the set of constants which he discovered, and which are in daily use by all chemists throughout the world. Here is something that is not finished ; and here Dalton's memory can be still further honoured, by good work, good researches, honest efforts to increase our knowledge. We have seen that the atomic weights are the fundamental constants of all exact chemistry, and that they are almost as important also to physics ; but the mathematical law which must connect them is still unknown. Every discovery along the line of Dalton's theory is another stone added to his monument, and many such discoveries are yet to be made.

What, now, is needed ? First, every atomic weight should be determined with the utmost accuracy, and what Stas did for a few elements ought to be done for all. This work has more than theoretical significance ; its practical bearings are many, but it cannot be done to the best advantage along established lines. So far the investigators have been a mob of individuals ; they need to be organised into an army. Collective work, coöperative research, is now demanded, and the men who have hitherto toiled separately should learn to pull together. Ten men, working on a common plan, in touch with one another, can accomplish more in a given time than a hundred solitaries. The principles at issue are well understood ; the methods of research are well established ; but the organising power has not yet appeared. Shall this be a great institution for research, able to take up the problems which are too large for

individuals to handle, or a voluntary coöperation between men who are unselfishly inclined to attempt the work? This question I cannot answer; doubtless it will solve itself in time; but I am sure that a method of collective investigation will be found sooner or later, and that then the advance of exact knowledge will be more rapid than ever before. When the atomic weights are all accurately known, the problem of the nature of the elements will be near its solution. Some of the wealth which chemistry has created might well be expended for this purpose. Who will establish a Dalton laboratory for research, and so give the work which he started a permanent home?

---

**XII. I. On a Higher Oxide of Cobalt. II. A Method for the Volumetric Determination of Cobalt.**

By R. L. TAYLOR, F.C.S., F.I.C.

*Received and read March 31st, 1903.*

*I. On a Higher Oxide of Cobalt.*

In a paper read before this Society last year,\* I described a rapid method for the separation of cobalt from nickel. This method, which is a modification of Rose's, consists in mixing the somewhat dilute but *perfectly neutral* solution of the two metals with barium or calcium carbonate and an excess of bromine water, and allowing to stand, with occasional shaking, for about five or ten minutes, when the cobalt is precipitated as a black oxide. I pointed out that Rose's original method was unsuccessful because he used a solution which was strongly acid, and I showed that the precipitation of the cobalt was greatly retarded by the carbonic acid which was produced by the action of the free acid upon the added carbonate.

At that time I had in my mind the idea that, if the composition of the precipitated oxide was uniform, it would be possible to use the reaction as a means for the volumetric determination of cobalt by the method indicated by Bunsen.† This depends upon the fact that any oxide of cobalt higher than the monoxide  $\text{CoO}$  would dissolve in a mixture of hydrochloric acid and potassium iodide, liberating an amount of iodine which would

\* *Memoirs*, Vol. xlvi., (1902), No. 11.

† *Ann. Chem. Pharm.*, LXXXVI., 265.

depend upon the amount of oxygen in the oxide greater than that required by the formula  $\text{CoO}$ . The action of the acid and potassium iodide upon the sesquioxide, for example, would be as follows:—

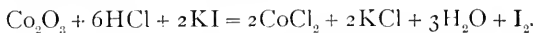

The amount of iodine liberated could then be determined by titration with a solution of sodium thiosulphate.

In my former paper I had assumed that the precipitated oxide was the sesquioxide, and referred to it as such. I very soon found, however, that the oxide produced in the above reaction was certainly higher than  $\text{Co}_2\text{O}_3$ , and, on investigation, I found that a considerable number of higher oxides of cobalt have been described by various observers. It appears, in fact, that the genuine sesquioxide is really very seldom obtained by precipitation.

The first description of an oxide of cobalt higher than  $\text{Co}_2\text{O}_3$  which I have been able to find is by Thomas Bayley, A.R.C.S., Ireland,\* who, determining the composition of the oxide by the method indicated above, found that an oxide as high as  $\text{Co}_3\text{O}_5$  is produced when a solution of sodium hypochlorite is added to a solution of cobalt. Bayley also found that, if the liquid containing the precipitate is boiled for some time, the oxide loses oxygen, changing to another oxide which he describes as  $\text{Co}_{12}\text{O}_{19}$ ! More recently, Bayley† has repeated some of his experiments, determining the composition of the oxide by its oxidising action upon ferrous sulphate. He finds, as before, that a hypochlorite or hypobromite, at the ordinary temperature, precipitates  $\text{Co}_3\text{O}_5$ , but that oxides of varying composition are precipitated by other oxidising agents, or by boiling the solution. Incidentally, I have

\* *Chem. News*, Vol. 39, 1879, p. 81.

† *Chem. News*, Vol. 82, 1900, p. 179.

confirmed Bayley's conclusions with regard to the oxide  $\text{Co}_3\text{O}_5$ , which I have obtained by adding an alkali, and afterwards bromine in excess, to a solution of cobalt. If, however, the bromine is added first, and then the alkali, the oxide is always slightly lower than  $\text{Co}_3\text{O}_5$ .

Numerous other experimenters have described various oxides of cobalt, some apparently very complicated. Thus, Carnot\* obtained two oxides by precipitation with sodium hypochlorite and with bromine and alkali respectively, which have the composition represented pretty closely by the formulæ  $\text{Co}_5\text{O}_8$  and  $\text{Co}_8\text{O}_{13}$ ,—both slightly lower than  $\text{Co}_3\text{O}_5$ .

Schröder† obtained the same results as Bayley,—that is,  $\text{Co}_3\text{O}_5$ , in the cold, and other oxides between that and  $\text{Co}_2\text{O}_3$  on boiling, or when, as I have also noted, the cobalt solution is treated with bromine first and then with alkali.

Vortmann,‡ adding an alkali and solution of *iodine* to cobalt sulphate, obtained oxides varying from a little above  $\text{Co}_3\text{O}_5$  to almost  $\text{CoO}_2$ .

F. Mawrow,§ by the action of potassium persulphate on cobalt solutions, obtained  $\text{Co}_3\text{O}_4$ , but in presence of alkali  $\text{Co}_2\text{O}_3$ .

E. Hüttner|| also obtained  $\text{Co}_2\text{O}_3$  by the action of a persulphate in presence of alkali. With sodium hypochlorite he obtained  $\text{Co}_{13}\text{O}_{19}$ , approximately. Cobalt sulphate with alkali and excess of iodine gave the oxide  $\text{CoO}_2$ . According to both Vortmann and Hüttner iodine, in presence of alkali, appears to give the highest oxide.

McConnell and Hanes¶ describe the formation, by

\* *Compt. Rend.*, T. 108, p. 610-12.

† *Chem. Centr.*, 1890, I., 931.

‡ *Ber. Deut. Chem. Ges.*, Bd. 24, p. 2744.

§ *Zeits. anorg. Chem.*, Bd. 24, 1900, p. 263.

|| *Zeits. anorg. Chem.*, Bd. 27, 1901, p. 81.

¶ *Journ. Chem. Soc.*, Vol. 71, 1897, p. 584.

the action of hydrogen dioxide on the monoxide of cobalt in presence of potassium or sodium hydrogen carbonate, of salts containing cobalt as  $\text{CoO}_2$  (cobaltites), which have a green colour when in solution, and are moderately stable. They also conclude that cobalt dioxide is soluble in water to a certain extent, forming an acid solution.

From all of this it is plain that there is a wide irregularity in the composition of the precipitated oxides of cobalt. As I have already mentioned, that particular oxide which is precipitated from a neutral solution of cobalt by barium or calcium carbonate in presence of bromine water is certainly higher than the sesquioxide. I have made a great many determinations of the oxygen in it, over and above that in the monoxide (all by Bunsen's method), and I find that it is fairly constant in composition, and that its composition approximates pretty closely to that represented by the formulæ  $\text{Co}_7\text{O}_{11}$  and  $\text{Co}_9\text{O}_{14}$ . Which of these two more correctly represents the composition of the oxide I am not able to say.

In the following Table are given the results of eleven

Cobalt present.	Iodine liberated.	Calculated for		
		$\text{Co}_7\text{O}_{11}$ .	$\text{Co}_9\text{O}_{14}$ .	$\text{Co}_2\text{O}_3$ .
·102	{ ·248 ·242 ·246 ·251 ·246 }	·251	·244	·220
·068	{ ·168 ·165 ·167 ·164 ·163 ·164 }	·167	·163	·146



different experiments, taken almost at random from the much greater number which I have tried. Solutions of cobalt of two different strengths were used. I have represented in each case the actual amount of iodine liberated by dissolving the oxide in hydrochloric acid and potassium iodide, and, for comparison, have added the calculated amounts of iodine for the two oxides mentioned above, and also for the sesquioxide.

The cobalt solutions were prepared by dissolving an indefinite amount of pure cobalt chloride in water, and determining the amount of cobalt present by electrolytic deposition. The electrolysis was performed by the current from three Daniell's cells, the liquid, to which a considerable amount of ammonium oxalate had been added,\* being kept warm during the whole time, which extended to about six or seven hours. The metallic cobalt was deposited in a weighed platinum basin.

Bayley (*loc. cit.*) recommends, for the purpose of preparing a solution of cobalt of definite strength, heating the pure crystallised sulphate to dull redness, in order to expel the water of crystallisation, and dissolving a weighed quantity of the dried salt. I have tried that method, but do not consider it so satisfactory as the method of electrolytic deposition. During the heating I strongly suspected that some decomposition of the sulphate occurred, and this supposition was confirmed by a subsequent determination of the cobalt in the solution by electrolytic deposition, which gave slightly more cobalt than that calculated from the amount of the dried sulphate.

In the following Table of the various higher oxides of cobalt which have been described, they are arranged in ascending order, and, in order to show more clearly

\*The solution of the double oxalate of cobalt and ammonium is one of the best for the electrolytic deposition of cobalt.

their relation to each other, I have given the ratio of oxygen in each to one atom of cobalt.

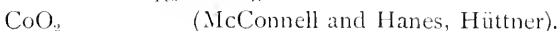
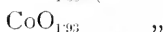
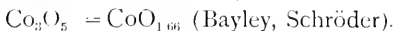
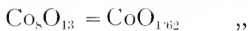
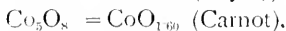

The probability is that all the oxides intermediate between  $\text{Co}_2\text{O}_3$  and  $\text{CoO}_2$  are mixtures or compounds of those two. Thus,  $\text{Co}_3\text{O}_5 = \text{Co}_2\text{O}_3, \text{CoO}_2$ ;  $\text{Co}_7\text{O}_{11} = 3\text{Co}_2\text{O}_3, \text{CoO}_2$ ;  $\text{Co}_9\text{O}_{14} = 4\text{Co}_2\text{O}_3, \text{CoO}_2$ , &c. McConnell and Hanes (*loc. cit.*) suggest that they are all—including, I suppose, the sesquioxide—compounds of the monoxide with the dioxide in varying proportions.

#### HIGHER OXIDES OF NICKEL.

Many of the experimenters to whom I have referred in connection with the higher oxides of cobalt, describe very similar, and almost as many, oxides of nickel, mostly produced by similar methods. I pointed out in my former paper that nickel is also precipitated, as a black oxide, by barium or calcium carbonate and bromine water at a temperature of  $80^\circ$ — $100^\circ$  C. I have made numerous experiments to try and find the composition of the oxide thus precipitated, but have been unable to obtain any uniform results. The composition of the oxide varies between somewhat wide limits, depending on the time of heating, the amount of bromine water used, and whether the bromine is added before or during the heating. Generally speaking, the oxide is higher than  $\text{Ni}_2\text{O}_3$ , some-

times approximating pretty closely to  $\text{Ni}_3\text{O}_5$ , but, especially after boiling for some time, it occasionally falls *below* the sesquioxide.

---

## II. *A Method for the Volumetric Determination of Cobalt.*

Although it is evident, from the experiments described in the first part of this paper, that the black oxide of cobalt which is precipitated by the carbonates of barium and calcium in presence of bromine is not the sesquioxide, yet it is plainly fairly constant in composition. It is therefore possible to use it as a means for the volumetric determination of cobalt by the method of Bunsen already referred to. I now proceed to describe how, so far as my own experiments suggest, the process is best carried out.

The solution to be operated upon must be moderately dilute, and it must be *as nearly neutral as possible*. It is best that no other metals than cobalt and nickel should be present in the solution. Nickel does not interfere, but iron, lead, and manganese would, under the conditions of the experiment, precipitate higher oxides capable of liberating iodine; aluminium and chromium are both precipitated as hydroxides by the carbonate employed, and, as this reaction would liberate carbonic acid, the precipitation of the cobalt would be prevented. It is remarkable that zinc also interferes materially with the reaction. A minute quantity of that metal sensibly retards the precipitation of the cobalt, and a considerable amount nearly stops it altogether.

A moderate amount of precipitated calcium carbonate (previously made into a thin paste with water) is added to the solution, and excess of bromine water. The total

amount of liquid in my experiments, with from .07 to .1 of cobalt present, has generally been about 150 c.c. The solution is then stirred at intervals for ten minutes, at the end of which time the whole of the cobalt is precipitated. The liquid is now filtered (preferably by the aid of a filter-pump) and the precipitate washed, partly by decantation, until the washings give no blue coloration on the addition of potassium iodide and starch, together with a few drops of acid. The precipitate settles and washes fairly well; it is much finer and denser than that produced in cobalt solutions by alkalis and bromine water. The filter paper and precipitate together are then transferred to a moderately large beaker, a little water poured on, and then some solution of potassium iodide and dilute hydrochloric acid, which must be added gradually. If a great excess of calcium carbonate has been used there will be a violent effervescence on the addition of the acid, and care must be taken that this does not cause a loss of iodine. The oxide of cobalt, as well as the excess of carbonate, rapidly dissolves and liberates a corresponding amount of iodine. The filter paper may be broken up by a stirring rod so as to admit the acid and iodide more freely to the precipitate. The process may now be finished by diluting with more water and then titrating in the usual way with a decinormal solution of sodium thiosulphate. Usually, however, I have preferred to pour off the iodine solution from the fragments of paper into another beaker, washing these until they are quite white and free from iodine by successive quantities of water containing a little potassium iodide, and then titrating the moderately clear solution. The whole process, from the time of adding the carbonate and bromine water, can easily be finished within an hour.

As already stated, my experiments have not enabled me to decide definitely the composition of the pre-

cipitated oxide,—whether it must be represented as  $\text{Co}_7\text{O}_{11}$  or  $\text{Co}_9\text{O}_{14}$ , so for the purpose of this analytical method I have taken the mean of the two (which would correspond to an oxide  $\text{Co}_{16}\text{O}_{26}$ ) and, in calculating the amount of cobalt present, it may be taken that each cubic centimetre of the decinormal thiosulphate corresponds to '005244 of metallic cobalt, or to '0066 of the monoxide,  $\text{CoO}$ .

Mr. J. H. Davidson, B.Sc. (Vict.), chemist at the Goldenhill Cobalt, Colour and Chemical Works, Staffordshire, has been good enough to test this volumetric process in the assay of some of the cobalt ores which he has to deal with, and I have to thank him for kindly giving me permission to append his results.

The four samples (see following Table) were New Caledonian ores. Column A gives the result by Mr. Davidson's usual method (Clarke's Phosphate process); column B gives the check assays by the analyst for the brokers, and column C gives the results by my proposed volumetric method. The results are all in percentages of cobalt monoxide,  $\text{CoO}$ .

No.	A.	B.	C.
I.	4'90	5 00	4'87
II.	4'87	4'83	4'83
III.	3'80	4'00	3 85
IV.	5'32	5'35	5'30

Mr. Davidson has also performed three separate assays of a specimen of spess by three different methods. In method A the cobalt was separated as phosphate and

weighed as pyrophosphate. In method B the cobalt was separated by the well-known nitrite method, precipitated by potash, and weighed as metal. Method C was the volumetric method I have described. The results are again in percentages of monoxide :—

A.	B.	C.
23·8.	23·65.	23·5.

In this last experiment the result by the volumetric method is rather low, as compared with the others. In the other series of four experiments, also, the results in column C are on the whole lower than the others. If we assume, however, the composition of the precipitated oxide to be represented by the formula  $\text{Co}_2\text{O}_3$ , then the factors for the thiosulphate become '00531 of metallic cobalt, and '00675 of the monoxide. Using these factors instead of those previously given, the amount for the method C in the last experiment becomes 23·8, and those in column C in the series of four experiments (see page 9) become

4·93  
4·89  
3·90  
5·37

In either case the results by the volumetric method are evidently fairly accurate, and, as the process itself is very short indeed compared with the other methods used (the nitrite process takes 2 or 3 days), I have no doubt it will be useful to chemists engaged in the analysis of cobalt ores.

### **XIII. A Factor in the Safety of High Speed Torpedo-Boat Destroyers.**

By GEORGE WILSON, D.Sc.,

AND

A. T. WESTON.

*Read and received April 28th, 1903.*

From time to time attention has been drawn to the question of the strength of vessels whose length is considerable, in proportion to their beam, and which are designed to travel at high speeds.

In such vessels the amount and manner of distribution of the weight will naturally be subjected to a most severe scrutiny, since there is every reason to avoid carrying unnecessary material at the expense of speed. It is, therefore, of great importance that all possible causes of stress should be comprehended, in order that their effects may be estimated and due allowance made for them where necessary ; for every cause of uncertainty in this respect involves either the addition of unnecessary material or the taking of irregular risks.

The importance of carefully balancing the inertia forces in the driving machinery, when possible, has long been understood, and the effects of these forces are well known to naval engineers. It is, however, not so clear that any estimate has been made of the effect of another set of periodic forces which may be called into play, when such a vessel is travelling at high speed across a sea, the surface of which is covered with waves, themselves possessing a definite velocity, depending on their length and the depth of the water.

*July 30th, 1903.*

It is, therefore, to these effects that the authors would draw attention, since it appears to them that in the case of a vessel unsuitably designed, the stresses might be largely augmented, even so far as to severely strain, if not actually rupture, the vessel. At the same time a further element of danger is introduced, owing to the constant reversal and repetition of such stress, which is going on during the motion. This reversal and repetition, which in a highly strained material might not be of primary importance if the material were uniform in structure, may become a serious factor in the case of any arrangement of rivetted plates and beams.

When a vessel of this class is at rest on a sea, the surface of which is covered with waves approaching the vessel in a regular manner, the motion would be one of combined pitching and tossing, depending on the relation between the length of the waves and that of the boat. If the length of the waves is short, compared with the length of the vessel, the vertical motion and the pitching motion will be inappreciably small. If, however, the wave-length is nearly equal to the length of the vessel, the vertical motion and the pitching motion will be considerable. If, in addition, the boat is moving at a definite rate across waves of this nature, the inertia of the vessel would tend to diminish the pitching motion ; for the interval of time during which the disturbing couple would act decreases as the speed of the vessel, relatively to the waves, increases. The authors are led to believe that this fact is also substantiated by actual experience with this class of vessel.

At the outset of the following investigation, it was thought advisable to take into consideration the disturbing forces caused by the pitching motion, but, on forming the equations of motion for the boat considered as a



rigid body, it appeared that the effect of these forces became almost negligible at high speeds, and it was afterwards determined to neglect the vertical motion of the C.G. and assume the pitching small, since, according to the experience cited above, no appreciable departure from the actual case would be made.

Proceeding in accordance with this assumption, the shearing force at the ends of the vessel may either be regarded as zero, when the solution may include a small pitching motion,\* or may have such a magnitude, with due regard to sign, as to ensure that the boat shall be horizontal and free from pitching.

In the solution we have applied the first of these conditions, but the application of the second, which involves the neglect of a term which is small in comparison with other terms in the expressions, produces the same stress at the middle section.

In this analysis the manner of distribution of the load has been assumed uniform throughout the length, in order to simplify the work as much as possible. Hence the problem finally resolves itself into one of determining the stresses, in a uniform beam of hollow rectangular section, uniformly loaded, and supported throughout its length by a continuous distribution of periodic forces, whose period is that of the waves relatively to the vessel. Since every point of the beam is subjected to a periodic force, the forced vibration will not be of any simple character. From the result, however, it appears that the lowest critical period occurs when the forced vibration is equal to the period of free vibration of the bar with the ends free.

The actual form of the wave surface will not be of great importance, so long as the height and length are

\* See Note, Appendix I.

correct, and a continuous variation is secured between them. The authors have, therefore, assumed that the wave surface may be represented by a curve of sines, and the boat is supposed to cross this surface at right angles to the crest line of each wave, with a relative velocity of  $v$  feet per second.

It appears that the effect of the wave surface will be worst when the wave-length is about the same as the length of the boat, otherwise the vibration or deflection of the boat from its horizontal centre line will be less, although the pitching and tossing may or may not be greater. When the wave-length is equal to the length of the vessel and its depth equal to the (draught + free-board) the maximum stress in the plates, at the middle section of the vessel is given by the following expression :

$$\frac{f}{dE} = \frac{wBA}{\frac{4\pi^2 EI}{L^2} - \frac{w'v^2}{g}} \left\{ 1 + \frac{\sin \frac{nl}{2} + \sinh \frac{nl}{2}}{\sinh \frac{nl}{2} \cos \frac{nl}{2} + \cosh \frac{nl}{2} \sin \frac{nl}{2}} \right\} \dots (1)^*$$

where

$$n = \sqrt[4]{\left(\frac{w'}{gEI} \cdot \frac{4\pi^2 v^2}{L^3}\right)}$$

and

$f$  = maximum stress in the frame of the vessel.

$d$  = draught or freeboard.

$E$  = Young's modulus of elasticity for the structure.

$w$  = density of sea water.

$w'$  = weight of the vessel per foot run.

$I$  = maximum moment of inertia of cross section.

$L$  = length of vessel.

\*When  $\frac{nl}{2}$  is small, as it usually is for velocities up to 60 miles per hour, the term in the brackets reduces to

$$\left\{ 1 + 1 + \frac{\left(\frac{nl}{2}\right)^4}{24} \right\} = \left\{ 2 + \frac{w'\pi^2 v^2 L^3}{96gEI} \right\}.$$

$A$  = semi-amplitude of the wave surface, a maximum when equal to draught or freeboard.

$$B = \text{mean beam} = \frac{\tau w'}{d\tau w}$$

From this it is evident that the stress may become large in either of two ways, either

(a) By reason of the term

$$\left( \frac{4\pi^2 EI}{L^2} - \frac{\tau w'}{g} v^2 \right)$$

becoming small, and ultimately zero, giving for a critical velocity

$$v = \frac{2\pi}{L} \sqrt{\frac{gEI}{\tau w'}} = \frac{6.28}{L} \sqrt{\frac{gEI}{\tau w'}}, \text{ or}$$

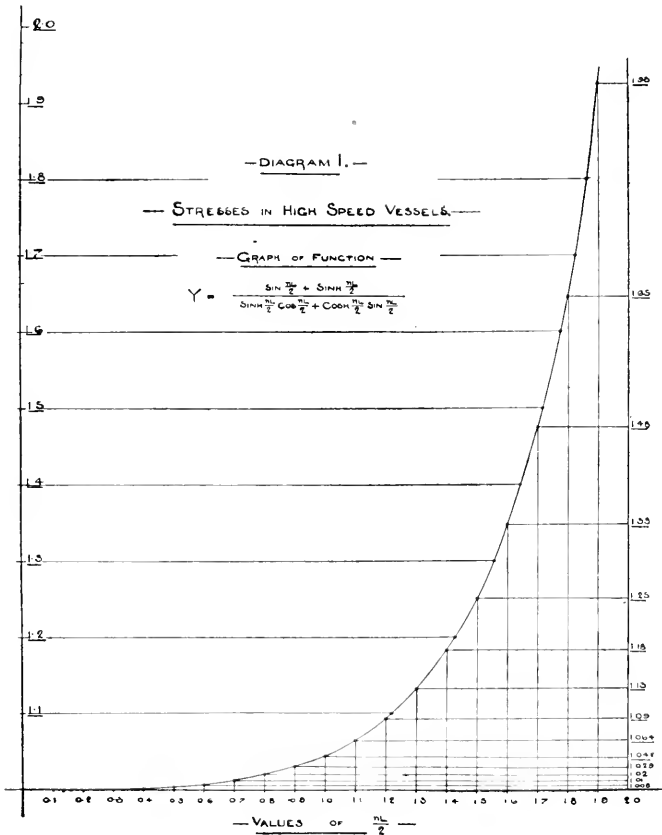

(β) By reason of the term under the bracket becoming great. On reference to Diagram 1 it will be seen that this term becomes infinite in magnitude when  $\frac{nL}{2} = 2.36$ .

Hence a second critical velocity

$$v = \frac{3.54}{L} \sqrt{\left(\frac{gEI}{\tau w'}\right)^*}$$

which is a considerably lower velocity than the one above. In actual practice it appears that the term  $\frac{\tau w' v^2}{g}$  is small compared with  $\frac{4\pi^2}{L^2} EI$  for all ordinary velocities, and may be neglected, in which case the coefficient outside the bracket in equation (1) becomes equal to half the statical stress, calculated on the assumption that the vessel is supported on a wave of length equal to its own length, with the crest in the centre (see Diagram 2).

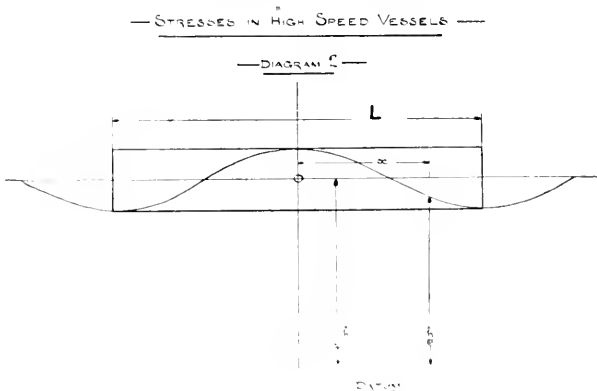

\* The time of free vibration of a bar ends free-free is

$$\frac{2\pi l^2}{m^2} \sqrt{\frac{w'}{gEI}}$$

and in its gravest mode this becomes

$$\frac{L^2}{3.55} \sqrt{\frac{w'}{gEI}}$$

The second value of  $v$  gives for the period of the waves

$$T = \frac{L}{v} = \frac{L^2}{3.54} \sqrt{\frac{w'}{gEI}}$$

i.e., the first critical period is when the period of the forced vibration = period of free vibration of the bar as a whole. See Rayleigh's *Sound*, Vol. I., p. 273.

Hence

$$f = \frac{f_s}{2} \left\{ 1 + \frac{\sin \frac{nl}{2} + \sinh \frac{nl}{2}}{\sinh \frac{nl}{2} \cos \frac{nl}{2} + \cosh \frac{nl}{2} \sin \frac{nl}{2}} \right\} \dots \dots (2)$$

where

$$f_s = \frac{27wBADL^2}{4\pi^2I} = \frac{2WAL}{4\pi^2I} = \text{maximum statical stress,}$$

giving a value for  $I$  in terms of  $f_s$ .

Substituting this value in the expression for  $u$  we get

$$\frac{nl}{2} = \pi \sqrt{\left( \frac{v^2 f_s}{2dEg} \right)} \dots \dots \dots (3)$$

Hence, if it is required to estimate the maximum dynamical stress induced in a vessel of this class designed so that the greatest statical stress = 10 tons □" we get from equation (3)  $\frac{nL}{2} = 1.14$ , where the maximum possible relative velocity of the waves to the vessel is taken as 88 feet per second. This high value for the velocity is taken in order to be on the safe side, inasmuch as waves whose velocity is as great as 50 feet per second\* are met

\*Abercromby (*Phil. Mag.*, Vol. 25, 1888), measures the length and velocity of ocean waves and gives a velocity of 28.5 ft. per second, with a wave-length of 358 feet and a height of 26 feet.

Rankine, *Civil Engineering*—

- Max. wave length = 560 feet.
- „ velocity = 53 feet per sec.
- „ height = 43 feet.

Lamb, *Hydrodynamics*, p. 377. Quotes Airey

Depth of Water.	Length of Wave.	
	100 ft.	1,000 ft.
100 ft.	22.62 f. s.	53.39 f. s.
1,000 ft.	22.62 f. s.	71.54 f. s.

with in great storms in mid-ocean. On substituting this value for  $\frac{nL}{2}$  in equation (2) the maximum dynamical stress  $f = \frac{f_s}{2} (2 \cdot 08) = 10 \cdot 4$  tons per  $\square''$ .

The conclusion drawn from this result is that, if the section of the vessel is strong enough to resist the statical stress, then for all ordinary velocities and depths it is strong enough to resist any increment of stress due to the periodic nature of the motion. However, to ensure that this shall be the case, it is necessary that the workmanship in the construction of the frame of the vessel should be of the highest possible character, in order that the modulus of elasticity may be as large as possible.

The authors next investigated the vibrations which occur when the vessel crosses the waves in a direction making an angle  $\theta$  with a normal to the crest lines. In this case the motion divides itself into a vibration in a vertical plane, through the longitudinal axis of the vessel, and a torsional vibration about that axis.

It is found that the combined effects of torsional and bending stress are less than in the case previously investigated, for the standard dimensions of vessel kindly supplied by Mr. Watts, Director of Naval Construction.

This appears in Appendix II., whilst in Appendix III. these conclusions are applied to the case of a typical destroyer of the British Navy.

---

#### APPENDIX I.

The equation of the wave surface is

$$h = h_0 + A \sin \frac{2\pi}{\lambda} (x + vt).$$

The axes of coordinates are the centre line of vessel when

uniformly supported and the vertical through the centre of gravity  $G$ .

$h$  = height of any point of the wave surface above datum, at a distance  $x$  from  $G$ .

$h_o$  = mean height of wave surface.

$\lambda$  = length of wave from crest to crest.

Let  $\bar{y}$  = height of  $G$  above datum.

$z$  = deflection of any point  $x$  in the centre line of the vessel from the axis of  $x$ .

The upward pressure on any element of length  $\delta x$ , whose distance from the origin =  $x$ , is

$$x = wB(h - \bar{y} + d)\delta x$$

$\therefore$  total upward pressure

$$= \int_{-\frac{L}{2}}^{+\frac{L}{2}} wB(h - \bar{y} + d)dx = W \text{ [displacement]}$$

if  $\bar{y}$  is assumed constant, *i.e.*, any small vertical motions neglected.

When  $\lambda = L$  this becomes

$$W = wBL(h_o - \bar{y} + d);$$

or, finally,

$$wBd = w' [\bar{y} = h_o] \quad . \quad . \quad . \quad . \quad (4)$$

The equation expressing the equilibrium of the beam at any point, neglecting the term involving the rotary inertia of the cross section, is

$$\begin{aligned} \frac{w'}{g} \frac{d^2 z}{dt^2} + EJ \frac{d^4 z}{dx^4} &= wB(h - \bar{y} + d) - w' \\ &= wBA \sin \frac{2\pi}{\lambda}(x + vt) \quad . \quad . \quad . \quad . \quad (5)^* \end{aligned}$$

\*Equation 5 is only strictly correct as long as the angular displacement in a vertical plane is zero. Since otherwise the upward pressure would largely depend on the angle assumed by the boat at any instant, but as this is small it has been assumed that the difference is negligible.

A particular solution is

$$z = H \sin \frac{2\pi}{\lambda}(x + vt) \dots \dots \dots (6)$$

where

$$H = \frac{wBAL^2}{4\pi^2 \left( EI \frac{4\pi^2}{L^2} - \frac{w'}{g} v^2 \right)} \text{ when } \lambda = L$$

One form of complementary function for (5) which is well-known, may be expressed as follows:—

$$z = \cos \frac{2\pi vt}{L} (M_1 \sin nx + M_2 \cos nx + N_1 \sinh nx + N_2 \cosh nx) + \sin \frac{2\pi vt}{L} (M_1' \sin nx + M_2' \cos nx + N_1' \sinh nx + N_2' \cosh nx) \quad (7)$$

where  $M_1, M_2, \&c.$ , are constants to be determined by the necessary conditions, viz. :—

- (a) Stress is zero at the ends ;
- (β) Shearing force is zero at the ends ;

These require

$$\frac{d^2 z}{dx^2} = 0 \text{ for } x = \pm \frac{L}{2}, \quad \frac{d^3 z}{dx^3} = 0 \text{ for } x = \pm \frac{L}{2},$$

from which

$$\begin{aligned} M_2' \cos \frac{nl}{2} - N_2' \cosh \frac{nl}{2} &= H \frac{4\pi^2}{L^2 n^2}, \\ M_1' \sin \frac{nl}{2} &= N_1' \sinh \frac{nl}{2}, \\ M_1 \sin \frac{nl}{2} &= N_1 \sinh \frac{nl}{2}, \\ M_2 \cos \frac{nl}{2} &= N_2 \cosh \frac{nl}{2}, \\ M_1 \cos \frac{nl}{2} - N_1 \cosh \frac{nl}{2} &= \frac{H.8\pi^3}{n^3 L^3}, \\ M_2 \sin \frac{nl}{2} &= -N_2 \sinh \frac{nl}{2}, \\ M_1' \cos \frac{nl}{2} &= N_1' \cosh \frac{nl}{2}, \\ M_2' \sin \frac{nl}{2} &= -N_2' \sinh \frac{nl}{2}. \end{aligned}$$



To satisfy these equations for all values of  $n$  requires  $M_2 = N_2 = M_1' = N_1' = 0$ , and then  $M_1, M_2', N_1, N_2'$  are determinate and we obtain for the stress on the middle section

$$f = - \frac{wBAdE}{EI4\pi^2 - \frac{w'v^2}{s}} \left\{ 1 + \frac{\sinh \frac{nl}{2} + \sin \frac{nl}{2}}{\sinh \frac{nl}{2} \cos \frac{nl}{2} + \cosh \frac{nl}{2} \sin \frac{nl}{2}} \right\}$$

where  $n = \sqrt[4]{\left( \frac{w'}{sEI} \quad 4\pi^2 \frac{v^2}{L^2} \right)} \dots \dots \dots (8)$

The statical stress in the plates of the middle section, when the vessel is supported as shown in Diagram 2, is

$$f_s = \frac{Md}{I} = \frac{2wBAdL^2}{4\pi^2 I} = \frac{2w'dL^2}{4\pi^2 I} \quad [w' = wBd].$$

APPENDIX II.

When the vessel is proceeding across the waves at an angle  $(90 - \theta)$ , then

$$\lambda = L \cos \theta \text{ and } h = h_0 + A \sin \frac{2\pi}{\lambda} \cos \theta (x + vt) W = wBdL$$

as before . . . (9)

and, by integrating, we find that the pressure per unit length of boat is

$$P = wB \left[ (h_0 - \bar{y} + d) + A' \sin \frac{2\pi}{L} (x + vt) \right] dx,$$

where

$$A' = \frac{AL \cos^2 \theta}{B\pi \sin \theta} \sin \frac{2\pi}{L} \frac{B}{2} \frac{\sin \theta}{\cos^2 \theta} \dots \dots \dots (10)$$

Hence, if we replace  $A$  by  $A'$ , the preceding investigation will hold as before, and normal stress at centre = (normal stress  $\theta = 0$ )  $\times \frac{A'}{A}$ .

The twisting couple

$$T = wMA \cos \frac{2\pi}{L}(x + vt)$$

where

$$M = \frac{2\sin\left(\frac{2\pi}{L} \frac{\sin\theta}{\cos^2\theta} \frac{B}{2}\right)}{\frac{4\pi^2}{L^2} \frac{\sin^2\theta}{\cos^4\theta}} - \frac{B\cos\left(\frac{2\pi}{L} \frac{\sin\theta}{\cos^2\theta} \frac{B}{2}\right)}{\frac{2\pi}{L} \frac{\sin\theta}{\cos^2\theta}}$$

= 0 when  $\theta = 0 \dots \dots \dots$  (11)

The equation of motion is

$$\frac{w'}{g} k^2 \frac{d^2\phi}{dt^2} - CI \frac{d^2\phi}{dx^2} = wMA \cos \frac{2\pi}{L}(x + vt) \dots \dots (12)$$

$k^2$  = (radius gyration of weight about longitudinal axis)<sup>2</sup>.

$I$  = geometrical moment of inertia of the section multiplied by the proper factor to allow for shape of section.

$\phi$  = angle of deviation of a line in section originally vertical.

$C$  = modulus of rigidity.

Then

$$\phi = \frac{wMA}{a^2 \left( CI - \frac{w'}{g} k^2 v^2 \right)} \cos \frac{2\pi}{L}(x + vt)$$

$$+ \cos \frac{2\pi vt}{L} (R \sin nx + S \cos nx) + \sin \frac{2\pi vt}{L} (P \sin nx + Q \cos nx)$$

where

$$n = \pm \frac{2\pi v}{L} \sqrt{\frac{w' k^2}{CIg}} \dots \dots \dots (13)$$

End condition is the shearing force = 0 when  $x = \pm \frac{L}{2}$  whence  $S = Q = 0$  and  $R$  and  $P$  are determinate, and we find shear force at centre

$$= Cd \frac{d\phi}{dx} = - \frac{Cd w M \cos \theta LA}{2\pi \left( CI - \frac{w'}{g} k^2 v^2 \right)} \left( 1 + \frac{1}{\cos \frac{nL}{2}} \right) \dots (14)$$

The corresponding velocities when the stress becomes infinite are

$$v = \sqrt{\frac{CIg}{w'k^2}} \text{ or period} = L\sqrt{\frac{w'k^2}{CIg}} \quad \dots \quad (15)$$

$$v = \frac{1}{2}\sqrt{\frac{CIg}{w'k^2}} \text{ or period} = 2L\sqrt{\frac{w'k^2}{CIg}}$$

The latter period = time of vibration of a free free rod.  
 The former period = time of vibration of a free free rod of half the length.\*

---

### APPENDIX III.

Dimensions of a typical destroyer kindly furnished by Philip Watts, Esq., Director of Naval Construction.

$W = 497$  tons.  $d = 7$  ft.  $L = 224$  ft.  $I = 305$  foot units, Maximum breadth = 20 ft. 6".  $B = 11.5$  ft.  $E = 10,000$  tons  $\square''$ .  $f_s = 9.02$  tons  $\square''$ .  $\frac{nl}{2}$  at 60 miles per hour (relative velocity) = 1.11. Maximum dynamical stress at centre = 9.32 tons  $\square''$ . Increase of stress = 3%.

Stress due to twisting when  $\theta = 45^\circ$ .

$$\frac{nL}{2} = 4\frac{1}{2} \quad I = 100 \text{ foot units.} \quad C = 10^7 \text{ lbs. per } \square''.$$

Stress due to twisting = 0.04 tons per  $\square''$ .

Stress due to bending = 95% of stress when  $\theta = 0$ .

$\therefore$  Total stress is less.

---

\* Rayleigh's *Sound*, p. 247, Vol. I.



XIV. Hymenoptera Orientalia, or Contributions to the  
Knowledge of the Hymenoptera of the Oriental  
Zoological Region. Part IX.

The Hymenoptera of the Khasia Hills. Part II.  
Section 2.

By P. CAMERON.

[*Communicated by J. Cosmo Melville, M.A., F.L.S.*]

*Received October 10th, read October 31st, 1899.*

CRYPTINÆ.

SILSILA, *gen. nov.*

Areolet small, narrow, twice longer than broad; the transverse cubital nervures are faint; the recurrent nervure is received in the middle; the transverse median nervure is received shortly behind the transverse basal. Eyes large, parallel, reaching near to the base of the mandibles. Clypeus roundly convex, its apex transverse in the middle. Mandibles with two large apical teeth. Parapsidal furrows deep; the base of the thorax transverse; its sides tuberculate. Metathorax longish; the metanotum with a gradually rounded slope; closely punctured throughout; there is only one transverse keel; its spiracles about three times longer than broad, rounded at the base and apex. Legs normal; the hinder tarsi spinose. Petiole not much longer than the second segment, becoming gradually wider (but not much) towards the apex; the spiracles are placed at the base of the apical third; its curve is not very distinct; the gastrocœli are shallow, triangularly narrowed at the base; the apical segment obliquely

*July 30th, 1903.*

narrowed from the apex to the base; the ovipositor projecting obliquely upwards.

This genus has the alar neuration of *Ceratocryptus* and agrees with it in some other respects, but may be separated from it by the front not being depressed and wanting the tubercles; and by the median segment having a gradual, not an abrupt, oblique slope on the apex. It comes also near to *Gotra*; but that genus has not the mesonotum so deeply trilobate and is opaque, not smooth and shining; the pronotum is rounded, not projecting into tubercles laterally at the base.

SILSILA FULVIPES, *sp. nov.*

*Nigra*; *albo-maculata*; *facie, annulo late antennarum, medio apiceque metanoti, flavis*; *pedibus fulvis, coxis trochanteribusque flavis*; *alis hyalinis, stigmatate nigro.* ♀.

Long. 11; terebra fere 3 mm.

Antennæ thickened towards the apex, black, brownish at the apex, the eighth to the sixteenth joints white. Face, clypeus, and mandibles, whitish-yellow; the face and clypeus broadly, distinctly and roundly dilated in the middle; the rounded centre of the face strongly punctured, the sides with only a few punctures; the clypeus only very obscurely punctured, roundly projecting in the middle; at the top in the middle not separated from the face, but the sides bordered by a narrow, but deep, furrow. The mandibular teeth are black; the palpi pallid yellow. Thorax black, a broad line in the centre of the pronotum, the scutellum and post-scutellum, the middle of the median segment broadly and the apical fourth still more broadly, yellow; on the base of the propleuræ there is a broad line, the tegulæ, a small oblique mark under them, a larger one on the lower side of the mesopleuræ at the apex (broad at the base, gradually

triangularly narrowed to the apex), a line on the top of the metapleuræ at the base and a large mark on the top near the apex (transverse above, roundly narrowed below), yellow. Parapsidal furrows distinct, the middle lobe distinctly raised above and separated from the lateral; the three lobes bearing rather deep, distinctly separated punctures; the sides smooth; the scutellum and post-scutellum smooth. Median segment closely and strongly punctured; the punctures behind the keel more widely separated, the apex in the middle transversely striated; there are no teeth; the yellow part is distinctly bordered, especially the apical part, and the segment is covered with long fuscous hair. Pro- and mesopleuræ strongly punctured, except the former at the base and the latter at the apex; metapleuræ, if anything, more strongly punctured, except on the yellow part at the base above. Mesosternum closely punctured; the furrow becomes much and triangularly widened at the apex. The four anterior legs are pale fulvous, the coxæ and trochanters pallid-yellow; the hinder pair are of a deeper fulvous; the coxæ are black, yellow in the middle behind; the apical joint of the trochanters and the knees black; the apex of the tarsi and of the tibiæ fuscous. Wings hyaline, iridescent; the space between the base of the stigma and the transverse basal nervure, pale; the areolet very narrow, the transverse cubital nervures pale in the middle; the recurrent nervure is received almost in the centre of the areolet; the transverse basal nervure is interstitial. Abdomen black; the base of the petiole broadly, its apex more narrowly, the base of the second segment, its apex more narrowly and the apices of the other segments, yellow; the petiole is smooth and shining, tuberculated at the base of the dilated part, its middle with an oval fovea. The second and following segments are closely

and minutely punctured; the gastroceci long, narrow, shallow, and wider at the base.

SILSILA BILINEATA, *sp. nov.*

*Nigra; flavo-maculata; pedibus fulvis; coxis trochanteribusque anterioribus flavis, coxis trochanteribusque posticis, apicibus femorum tibiaramque nigris; alis hyalinis, stigmatе nervisque nigris. ♂.*

Long. 13 mm.

Antennæ longer than the body; black, thickly covered with short stiff black pubescence; the seventh to sixteenth joints clear white. Head smooth and shining, the face covered sparsely with short, white pubescence; the face, clypeus (except at the apex), the mandibles, palpi, inner orbits narrowly above, and the lower half of the outer more broadly, lemon-yellow; the ocellar region is raised; the front bluntly keeled. Thorax black, shining; the projecting middle of the pronotum, the scutellar keels, the scutellum (except at the apex), the post-scutellum and its lateral keels, a large mark, rounded at the base, incised on the inner side at the apex, a large mark on either side of the apex of the median segment, produced into a narrowed point on the inner side at the top and bottom, the tubercles, a large mark on the base of the mesopleuræ next the sternum, narrowed roundly above towards the apex, and a curved mark on the sides of the mesosternum, lemon-yellow. Mesonotum smooth and shining; the middle lobe is distinctly raised and separated from the lateral; its apex is bordered on the depression by six short, stout, keels. The depression at the sides of the post-scutellum is stoutly keeled, the median segment is smooth at the base; the rest stoutly and closely transversely striated. The propleuræ stoutly longitudinally striated; the mesopleuræ more closely striated at the base



above, the striations being continued as a narrower band round the yellow mark; the metapleuræ stoutly punctured, the punctures round and deep; above and near the apex they run into striations; the mesosternum is smooth and shining; its furrow wide and crenulated. The wings have a slight fuscous tinge; the transverse median nervure is received distinctly behind the transverse basal; the four anterior tarsi are infuscated; the hinder coxæ are black, yellow at the apex, and, at the base above, there is a yellow trilobate mark; the outer lobe being the longer; the hinder trochanters, the apices of the femora and of the tibiæ, the base of the tarsi narrowly and the apical half of the end joint, black. The abdomen smooth and shining, black; the petiole, except for a black band before the apex, and the apices of the other segments, lemon-yellow.

This is a larger species than *S. fulvipes*, from which it may be further known by the median segment having two yellow marks, not one, and by the hinder trochanters, the apices of the femora and tibiæ being broadly black.

#### CERATOCRYPTUS, *gen. nov.*

Allied to *Mesostenus*, but may be known from it by the front having two short conical spines, as in the Neotropical genus *Polyænus*. From my genus *Suvalta*, it may be known by the much longer and more slender petiole which is, further, not so widely and distinctly dilated at the apex; also by the mesonotum being distinctly trilobate.

Antennæ annulated with white, stouter than in *Mesostenus*, and slightly thickened and compressed beyond the middle. Clypeus separated from the face. Front with two short, distinct, conical teeth placed side

by side near the middle. Head not developed behind the eyes. Mandibles bidentate. Mesonotum trilobate, the sutures deep. Scutellum large, convex. Metathorax nearly as long as the pro- and mesothorax united; the apex with an oblique slope; before the middle is a transverse keel; its spiracles large, linear, rounded at the base and apex. Legs longish, slender; the tarsi spinose; the claws simple. Wings reaching to the middle of the abdomen; the areolet smaller, about three times longer than wide, the recurrent nervure is received shortly beyond the middle, the transverse median behind the transverse basal. Petiole long and slender, the apical half distinctly, but not much, dilated; its apex obliquely depressed; it is longer than the second segment, which has an oblique depression on either side at the base; the spiracles are small and round, and are placed between the middle and the apex. The apex of the abdomen is straight up and down as in *Pimpla*, the ovipositor arising from its lower side, received in a vertical groove or cleft, and standing upwards above the dorsum of the abdomen. The ventral surface has a central fold.

The characteristic features of this genus are the front with the two spines, the clypeus distinctly separated from the face, the small, elongated areolet and the long abdomen. The antennæ are stouter and the metathoracic spiracles are longer than in either *Cryptus* or *Mesostenus*.

CERATOCRYPTUS BITUBERCULATUS, *sp nov.*

*Niger; albo-maculatus; mesonoto laevo; pedibus rufis; coxis trochanteribusque anterioribus albis; coxis posticis nigro-maculatis; abdomine quam thorace duplo longiore; alis fulvo-hyalinis, stigmatate nigro.* ♀.

Long. 19 mm.; terebra 11 mm.

Antennæ black; the scape in the middle above, and

a broad band (7-8 joints) shortly beyond the middle, clear white. Face, clypeus, mandibles and palpi, yellowish-white; the front and vertex black, except for a yellow line along the orbits; and the outer orbits, except above, yellow. The face is strongly punctured, broadly rounded in the middle, thickly covered with white hair; the clypeus roundly projecting, smooth. Thorax black; the scutellum broadly at the base, the post-scutellum, the sides of the median segment on the oblique apical part, the base of the pronotum, the tubercles, a mark on the apex of the mesopleuræ, obliquely truncated behind a large curved mark, obliquely truncated at the apex on the base of the metapleuræ, and a mark immediately under the hinder wings, yellow; the middle lobe of the mesonotum raised, clearly separated from the lateral at the apex and sides, the depression at its apex being large. Scutellum and post-scutellum smooth. The median segment behind the transverse keel is smooth; the rest of it to the apex strongly transversely striated; the striae finer and closer on the basal region. The pronotum raised, tuberculated at the base on the yellow part; the upper part has some scattered shallow punctures; the middle longitudinally striolated, the base not quite so strongly perpendicularly striated, the rest smooth. On the mesopleuræ, the tubercles, and the middle and the lower part behind are smooth, the rest striated; there is a curved furrow on the lower part next the sternum. The metapleuræ are rugosely punctured, thickly covered with long pale fulvous hair; at the apex before the hinder coxæ is a yellow tubercle-like mark. The mesosternum is obliquely truncated at the base and apex where it is smooth; the central part punctured, with a crenulated furrow; the base keeled. Legs fulvous, the coxæ and trochanters white, the hinder coxæ white, broadly black

on the apex above and more broadly black below ; the hinder trochanters, the apex of the femora, the base of the tibiæ narrowly, the apex somewhat more broadly, the metatarsus broadly at the base, the apex of the fourth joint and the fifth entirely, black ; the rest white ; the tarsi spinose. Wings short compared with the length of the body, being distinctly longer than the head and thorax united (8 as against 11 mm.) ; the areolet small, narrow, longer than broad, of equal width throughout ; the second transverse cubital nervure faint ; the transverse median nervure is received distinctly behind the transverse basal ; the recurrent shortly beyond the middle. Petiole slender, longer than the second segment ; smooth ; the part between the base and middle above and the apex yellow ; the yellow mark on the latter is dilated in the middle at the base ; at the base of the dilated apical part is, in the middle above, a large, deep fovea ; the base of the second segment is shining, shagreened, its base at the sides obliquely depressed ; the rest of it and the third and the fourth segments closely punctured ; the apex of the second, of the third, and the others on the sides at the apices, yellow ; the last is entirely yellow at the apex ; the yellow on the lower sides of the apical segments is more extended.

CERATOCRYPTUS TIBIALIS, *sp. nov.*

*Niger ; flavo-maculatus ; pedibus rufis, tibiis posticis fuscis, coxis trochanteribusque anticis flavis ; alis fulvo-hyalinis, nervis stigmatæque nigris.* ♀.

Long. 19 mm.

Apart from the differences in coloration this species may be known from *C. bituberculatus* by having two short, thick keels in the middle of the median segment at the base.

Antennæ stout, black, the ninth to fourteenth joints clear white; the scape sparsely covered with black hair; the flagellum more thickly with short, thick pile. Head black; the inner orbits narrowly, the outer more broadly on the lower portion, a large mark on the upper part of the face, narrowed slightly towards the apex, which is triangularly incised, the clypeus (except a triangular mark in the middle), the mandibles, except the teeth, the labrum and the palpi, pallid yellow. The face smooth, obscurely punctured above, the clypeus smooth; both are sparsely covered with white hair. The front and vertex obscurely shagreened, sparsely covered with blackish hair; the ocellar region raised; in front of it there is a short, blunt keel, which projects at the apex into a curved tooth; on either side of this is a blunt, short tubercle. Thorax black; a broad line on the pronotum, the scutellar keels, a large mark in the middle of the scutellum, rounded at the base, gradually widened towards the apex which is transverse, the post-scutellum, a large mark on the sides of the median segment (sharply narrowed at the apex on the inner side, then becoming gradually narrowed from the broad part to the apex), the tegulæ, tubercles, a large mark, longer than broad, bluntly rounded at the base and apex, a curved mark below the furrow and a small mark above the four hinder coxæ, pallid yellow. Mesonotum smooth, impunctate, at the base and apex sparsely covered with long black hair; the scutellar depression deep, stoutly longitudinally striolated; the scutellum and post-scutellum smooth. The base of the median segment behind the transverse keel smooth; in the middle are two stout tubercles, which are longer than broad and which have a distinct lateral slope. The rest stoutly transversely striolated, the upper part of the propleuræ punctured, the middle striolated, finely

above, more coarsely below. Mesopleuræ strongly punctured; the middle and apex coarsely, irregularly striolated, running into reticulations; behind the tubercles is a conical depression. Mesosternum punctured, its central furrow shallow, wide, smooth; the lateral deeper and finely punctured. The areolet is narrow, gradually widened towards the apex; the transverse cubital nervures faint; the recurrent nervure is received close to the apex; the transverse median before the transverse basal. The anterior coxæ and trochanters are more or less yellowish, the anterior tarsi infuscated; the hinder tibiæ blackish, the tarsi white, the basal half of the metatarsus and the apex of the terminal joint black. Abdomen smooth and shining, the apices of the segments banded with yellow.

GOTRA\* CARINIFRONS, *sp. nov.*

Long. 5 mm.; terebra 2 mm. ♀.

Comes near to *G. fulvipes*; but may be known from it by the mesopleuræ having two separate yellow marks, not one large one, by the edge of the pronotum projecting more distinctly, and by the front being keeled in the middle.

Head black; the face, the clypeus, inner orbits, the outer orbits broadly below, the base of the mandibles and the palpi, yellow. Face strongly punctured, covered sparsely with white hair; the clypeus sparsely punctured; its apex and the lateral depressions black. Mandibles black; their base yellow; the middle punctured; palpi yellow. Thorax black; the raised edge of the pronotum, a mark on the apex of the middle lobe of the mesonotum, the scutellum and its keels, the post-scutellum, a band round the apex of the metanotum (the top roundly dilated, the

\*Gotra, Cam., *Ann. and Mag. Nat. Hist.*, ser. 7, vol. 9 (1902), p. 206.

sides narrow), the marks on the apex broader and roundly narrowed on the inner side at the apex, the lower edge of the propleuræ, two somewhat conical marks on the lower side of the mesopleuræ, the tubercles, two marks under the hind wings, a large oblique conical mark on the metapleuræ, and the sides of the mesosternum largely, yellow. Mesonotum opaque, strongly and closely punctured. Scutellum and post-scutellum impunctate, shining. Median segment closely and strongly punctured; the basal median area is smooth and shining; the transverse keel is curved backwards and is united to its apex. Propleuræ shining; the base smooth, the rest strongly striated; mesopleuræ closely punctured, except a small space under the hind wings; under the tegulæ closely striated; the metapleuræ more coarsely punctured and longitudinally striated at the base. Mesosternum closely and distinctly punctured; the middle furrow with eight stout transverse keels. Legs fulvous; the front ones paler, more yellowish; the coxæ and trochanters yellow; the hinder coxæ broadly black at the base, laterally and beneath, and with a smaller, irregular mark on the apex above; the hinder trochanters are blackish; the apex of the hinder femora, the base of the hinder tibiæ, more narrowly, and their apex more broadly, black; the tarsi yellowish, the apex black. Wings hyaline; the stigma and nervures black. Abdomen black, shining; the apices of all the segments lemon-yellow.

HADROCRYPTUS, *gen. nov.*

Head large, almost transverse behind and in front. Eyes large, parallel, not reaching to the base of the mandibles. In the centre of the face, below the antennæ, is a large, distinct protuberance, separated from the sides by a furrow; it is longer than broad, rounded behind,

and oblique at the apex. Clypeus separated from the face only at the sides, not behind, its apex obliquely depressed; at the sides bounded by a sharp oblique keel, which projects slightly on to the labrum, which is large and rounded at the apex. Mandibles unequally bidentate at the apex. The second joint of the maxillary palpi dilated gradually towards the apex. Mesonotum trilobate, the middle lobe not greatly raised, flat. Scutellum large, flat. Median segment with only one transverse keel; the spiracles linear, rounded at the base and apex; the teeth are large; legs long, especially the hinder, the tarsi spinose, the fourth joint armed with six long spines on either side beneath; the claws long, simple. Areolet large, broader than long, the recurrent nervure is received very shortly beyond the middle; the transverse median nervure in the costal cellule distinctly before the transverse basal. Petiole slender, gradually, but not much, widened towards the apex; the spiracles are received shortly beyond the middle. Gastrocœli small.

Belongs to the *Cryptides* and comes near to *Ceratocryptus*, but it wants the frontal tubercles. *Ceratocryptus* wants the facial tubercle and the keels on the sides of the clypeus, while its areolet is small as in *Mesostenus*: in the present genus large as in *Cryptus*.

#### HADROCRYPTUS NASUTUS, *sp. nov.*

*Niger; flavo-maculatus; pedibus anterioribus flavis, posticis fulvis; apice metanoti late flavo; alis fulvo-hyalinis.* ♀.

Long. 12 mm.

Head wider than the thorax; black; the face, clypeus, labrum, mandibles and palpi, yellow; the inner orbits to the end of the ocelli and the outer, narrowly above, broadly below, the oblique apex of the clypeus, a mark



under the tubercles (rounded at the base, gradually widened towards the apex), and the apex of the mandibles, black ; the face and clypeus strongly punctured, finely transversely striated below the tubercle ; the black apex of the clypeus and the labrum smooth. Thorax black ; a line on the base of the propleuræ (narrow above, widened below), a line on the sides of the middle lobe of the mesonotum, a transverse one at its apex ; the scutellum (except for a somewhat triangular black mark at its base), the post-scutellum, a large mark on the apex of the median segment, square at the base, widened towards the apex ; the tegulæ, tubercles, a large mark on the lower side of the mesopleuræ, dilated upwards at the apex, and a large oblique mark on the middle of the metapleuræ near the apex, yellow. Mesonotum closely punctured ; the depression at the base of the scutellum deep, the bottom flat, shining, finely longitudinally striated. Scutellum sparsely covered with long, white hair, coarsely, but not closely, punctured ; the post-scutellum smooth. There is a deep, narrow furrow at the base of the median segment, which is smooth in the middle, the rest closely and finely longitudinally striated ; the part behind the transverse keel closely, but not strongly, punctured, smooth at the base ; the rest of the segment rugosely punctured, almost reticulated in parts, the sides transversely striated ; the apex has a distinct keel on the sides below, the keels continued on to the centre obliquely and rounded at the top. Propleuræ smooth, finely punctured above, the middle striated. Mesopleuræ punctured, more strongly at the base behind the keel ; under the tubercles, at their base, are three short, curved keels ; the middle above is striolated ; the furrow on the lower side is deep and extends to the middle ; the part behind it is striated. The base of the metapleuræ smooth, the rest punctured.

Mesosternum closely punctured ; the base broadly depressed, the depression rounded at the apex ; the middle has a crenulated furrow. The areolet is broader than long, and is slightly narrowed above ; the recurrent nervure is received in its middle ; is straight and largely bullated in the middle, as is also the second transverse cubital ; hyaline, iridescent, the costa, stigma and nervures black ; the transverse median nervure is received shortly before the transverse basal. The anterior legs are pale yellow ; the middle pair are darker, with a more fulvous hue ; the tarsi fuscous ; the hinder coxæ black ; the apex broadly behind, more narrowly on the outer side, pale-yellow ; the trochanters black ; the femora and tibiæ dark rufous, the apex and base of the femora above and the apex of the tibiæ, broadly, blackish ; the tarsi white, the basal two-thirds of the metatarsus and the apical joint black. Abdomen smooth, shining ; the petiole black, the sides and apex pale yellow ; the other segments black, narrowly yellow on the apices ; the centre of the second segment slightly, the third, fourth, and fifth more broadly at the base, and the sixth and seventh almost entirely—only the sides being narrowly black—brownish. The ventral surface whitish yellow, the apical segments brownish ; the ventral fold is distinct.

LEPTOCRYPTUS, *gen. nov.*

Resembles *Ceratocryptus* in the form of the body and wings, but it wants the frontal tubercles ; the apical mandibular tooth is longer and sharper ; the prothorax above is more widely and deeply depressed, or incised in the middle ; the metathoracic spiracles are oval, not linear ; the spiracles on the petiole are placed shortly behind the middle, not, as in *Ceratocryptus*, between the middle and the apex ; and the ovipositor originates from the ventral

end of the segment, as in *Cryptus*, not from its apex and turned upwards as in *Ceratocryptus* and *Pimpla*. Further differences are to be found in its smooth, not striated, median segment, and in the presence of a stout spine on the sides of the mesosternum.

Head dilated below the antennæ, the clypeus separated from the face by a narrow suture. Mandibles with one long, sharp, apical tooth. Occiput not margined. Palpi long, the joints not dilated. Mesonotum trilobate; metathorax large, smooth, nearly as long as the mesothorax; has a gradually rounded slope to the apex, and has one transverse keel; the spiracles are twice longer than broad, rounded at base and apex. Abdomen long and narrow, nearly twice the length of the head and thorax united; petiole long, narrow, not much dilated towards the apex; the spiracles are small, round, and situated near the middle; the gastrocœli are elongate, narrow. Legs long and slender, the fore tarsi are more than twice the length of the tibiæ, and are incised at the base. Areolet minute, the outer nervure faint; the recurrent nervure is bullated in the middle, and is received shortly beyond the middle of the areolet.

LEPTOCRYPTUS LONGIVENTRIS, *sp. nov.*

*Niger; late albo-maculatus; pedibus fulvis, apice dimidio apicali tibiæ posticarum nigro; tarsis posticis albis, basi nigro. ♀.*

Long. 9; terebra 1 mm.

Antennæ black; the scape rufous beneath; the flagellum to the middle thickly covered with short, black hair: the apical part broken off. Head yellowish-white; the middle of the front and vertex and the occiput, except at the orbits, black. Face smooth, shining and

impunctate, sparsely covered with short fuscous hair ; the face broadly projecting in the middle, the dilated part bordered on the lower two-thirds by a wide furrow ; the furrow at the base of the clypeus narrow ; the apex of the clypeus has an oblique slope ; the mandibular teeth are black. Thorax black, smooth ; the edge of the pronotum (except at the base), the scutellum, post-scutellum, the apex of the median segment, a broad band down its middle extending from the transverse keel to the transverse apical band, the lower side of the propleuræ, this band being united to the one at the top by a short perpendicular one, the apex of the mesopleuræ, a broad band on the apical two-thirds on the lower side, the upper part of the metapleuræ, and a band on the apex of the mesosternum, yellow. Mesonotum shining, covered with a short down ; the depression at the base of the scutellum is deep and wide ; the scutellum rounded and slightly narrowed at the apex where there is a curved, moderately stout keel between it and the post-scutellum, which is slightly curved inwardly at the apex and has a slight oblique slope. Median segment smooth, shining, with only a few shallow minute punctures visible on the black parts at the sides ; behind the keel sparsely covered with short white hair. The propleuræ almost impunctate ; the meso- and metapleuræ closely punctured ; the furrow on the apex of the propleuræ crenulate ; the furrow on the lower side of the mesopleuræ curved, deep at the base, shallower and wider at the apex. The base of the mesosternum is oblique, smooth, and shining ; its sides in the middle, armed with a large, somewhat triangular tooth ; the central furrow at the base is narrow ; on the rest wider and becoming much wider towards the apex, where it is bounded by a stout transverse partition. Wings short, clear hyaline ; abdomen : a spot in the middle of the

second, and the other segments broadly testaceous ; the testaceous colour more extended on the apical ones.

ETHA, *gen. nov.*

Areolet quadrangular, large ; below scarcely angled ; the transverse cubital nervures parallel ; the recurrent nervure received in the middle ; the third discoidal cellule elongate, its base two-thirds of the width of the apex ; arched above ; the cubital nervure in its middle with a short branch. Antennæ longish, slightly thickened beyond the middle ; the first joint of the flagellum distinctly longer than the second. Eyes large, parallel, not reaching to the base of the mandibles. Mandibles stout, with two large, triangular, equal teeth on the apex ; the second joint of the maxillary palpi dilated. Parapsidal furrows distinct. Median segment large ; its spiracles linear ; there are two transverse keels. Petiole narrow, curved, not much dilated towards the apex ; its spiracles small, round, and placed near the base of the apical third ; the second and third segments become gradually dilated towards their apices ; the other segments become gradually narrowed. Legs longish ; the anterior slightly curved ; the tarsi twice the length of the tibiæ, incised at the base ; the penultimate joint largely projecting at the apex beneath, the projection ending in some stout spines ; the hinder tarsi spinose, the penultimate joint ending, on each side, in a bunch of long stiff spines ; the claws dilated at the base ; their apex simple.

The affinities of this genus are clearly with *Ospyrnotus*, from which it may be known by the less elongated face, by the shorter bidentate mandibles, by the larger, more quadrate areolet, much longer third discoidal cellule, through the cubital nervure originating nearer the transverse basal, by the stouter, less elongated petiole ;

the antennæ are more slender and longer ; the fore tarsi longer compared with the tibiæ, with the base of the tarsi more sharply incised ; the head is more sharply oblique behind the eyes ; the clypeus roundly convex, with the apex oblique ; the labrum shorter than the clypeus, its apex bluntly rounded, and the fore tibiæ are distinctly narrowed at the base.

This genus also comes near to *Ceratocryptus* described in this paper, it having the same form of thorax and abdomen, but differs in the much larger areolet, in the smooth median segment, which has the spiracles less elongated, in the shorter petiole, which has not the post-petiole so distinctly narrowed from the rest of it ; the antennæ are more slender, with the third joint longer compared with the fourth ; the metathorax is shorter and more rounded at the apex. The transverse median nervure is interstitial. The species have a considerable resemblance to *Heterocryptus*, which may be distinguished by the smaller, round metathoracic spiracles.

ETHA STRIATIFRONS, *sp. nov.*

*Nigra; annulo antennarum, ore, linea pronoti, scutello, apicque metanoti late flavis; pedibus pallide fulvis; alis hyalinis, stigmatate testaceo. ♀.*

Long. 15 ; tenebra 4 mm.

Antennæ not quite so long as the body ; filiform, slightly shorter than the body ; the scape beneath and the seventh to twelfth joints white. Head black ; the face, clypeus (except the apex), labrum, mandibles (except the teeth), the upper inner orbits narrowly, and the lower outer broadly, yellow. The face obscurely striated ; the front, except near the antennæ, irregularly striated, somewhat obliquely above, transversely below, the vertex

shagreened, finely and closely punctured between the ocelli. Thorax black; a line on the pronotum, roundly narrowed on the lower side, at the base and more broadly in the middle, the tegulæ, tubercles, scutellum, a mark on the sides of the median segment at the base and the oblique apex, yellow. Mesonotum closely and finely punctured, obscurely transversely striated near the furrows at the base where there is a small yellow mark on the inner side of the outer lobes; the scutellum black and punctured at the base; its basal depressions large, smooth and marked with a few keels; post-scutellum shining, its base striated in the middle. Median segment closely striated behind the keel; the rest strongly transversely striated and thickly covered with long, white hair. Propleuræ irregularly and rather strongly striated, the top and bottom more finely and punctured. Mesopleuræ finely rugose, the apex longitudinally striated, coarsely above, more closely and finely below. Metapleuræ closely and almost uniformly punctured; all the pleuræ thickly covered with short, white hair. Mesosternum shining, closely punctured; its apex obliquely depressed; the central furrow wide and stoutly crenulated. The four anterior legs are uniformly pale fulvous-yellow; the hinder are deeper in tint; the coxæ are broadly black on the outer side; the trochanters are black above; the femora are infuscated on the top, as is also the apex of the tibiæ; the tarsi are pallid-yellow, black at the base and apex, spinose, the bunches of spines on the penultimate joint long and thick. Wings hyaline, iridescent; the stigma obscure testaceous, the costa and nervures blackish; the transverse median nervure is received shortly in front of the transverse basal and is curved; the areolet is almost square; the transverse cubital nervures straight, parallel; the recurrent nervure is

received in the middle. Abdomen black; the sides and apices of the segments and the ventral surface yellowish.

ETHA LEVIFRONS, *sp. nov.*

Long. 15; terebra 5 mm. ♀.

Agrees closely in form, size, and coloration, with *E. stratifrons*; may be known from it by the front being smooth, not striated, by the mesonotum being alutaceous, not punctured, by the pronotum being entirely black, by the scutellum being more widely yellow, the oblique base only being black, and by the apex of the median segment being not so strongly punctured, being almost smooth, and it bears distinct teeth on the sides.

Head black; the face, clypeus, labrum, mandibles, palpi, a large mark, triangularly narrowed on the lower side, on the inner orbits above, and the lower orbits on the outer side, yellow; the front and vertex have a plumbeous hue, and are smooth and shining; the front is depressed in the middle; the lower ocellus is surrounded by a deep furrow; the inner orbits are sharply margined. The face is closely punctured, thickly covered with white hair; the clypeus is sparsely punctured. Thorax black, with a distinct plumbeous hue that is less distinct on the mesonotum, which is dull in tint and thickly covered with short, pale pubescence; the furrows distinct, smooth. Scutellum yellow, except at the base, and covered with longish pale hair; post-scutellum smooth, yellow, black and largely bifoveate at the base; the lateral depression strongly striated at the apex. The basal region of the median segment smooth; the basal transverse keel is narrowly bent backwards in the middle; the second is more broadly bent backwards; between the two keels on either side of the middle are some transverse keels which become gradually longer; the second keel becomes raised



and plate-like at the sides ; the segment is thickly covered with longish pale hair. The pleuræ are smooth ; the apex of the propleuræ is furrowed ; the base of the mesopleuræ is depressed on the lower side, irregularly, stoutly striated and keeled behind ; the middle is obliquely depressed and bears a few keels ; the metapleuræ smooth, except for some short striæ below the upper curved keel. The wings have a faint fulvous tint ; the stigma is testaceous ; the areolet is large, almost square ; the transverse cubital nervures are parallel ; the recurrent nervure is received in the middle ; the second transverse cubital nervure is faint ; the recurrent nervure is largely bullated in the middle. The legs are dull fulvous ; the four anterior coxæ and trochanters are paler ; the hinder coxæ are black, except at the base above ; the femora above, the apex of the tibiæ broadly, and the base of the tarsi are black ; the rest of the tarsi white. Abdomen black above ; the apices of all the segments narrowly yellow.

ETHA PLUMBEA, *sp. nov.*

*Plumbea ; facie, ore, apiceque metanoti flavis ; pedibus flavis, coxis posticis, femoribus supra, tibiis basi que tarsorum posticorum nigris ; alis hyalinis, stigmatate nigro. ♂.*

Long. 10 mm.

Antennæ black, annulated with white beyond the middle ; the scape dirty testaceous beneath ; the flagellum thickly covered with short, stiff hair. Head black ; the face, clypeus, the lower inner orbits, a line on them above the antennæ, and the lower orbits on the outer side, yellow ; the face and clypeus thickly covered with short, white hair ; the clypeus roundly dilated in the middle ; the raised part bordered by a blackish line. The front and vertex are very smooth and shining ; the front is widely furrowed below the ocelli. Thorax smooth and

shining, almost glabrous; the metanotum sparsely covered with white hair; the scutellum is broadly yellow in the middle; post-scutellum yellow; the two foveæ at its base deep. The curved furrow on the side of the mesosternum is wide, deep, and obscurely crenulated; the mesosternal furrow is smooth. Over the four hinder coxæ is a narrow curved keel. The stigma and apical nervures are fuscous; the second transverse cubital nervure is faint. The two front legs are entirely pallid yellow, as are also the middle pair, but the femora and tibiæ are darker above; the middle tarsi are black; the hind legs are black above; the tibiæ black all round towards the apex; the tarsi white; the basal half of the metatarsus black. Abdomen black, shining; the second and following segments narrowly lined with white. The white mark on the apex of the metanotum does not extend to the middle of the segment, and is square at the base, with the sides dilated.

Characteristic of this species are the black, immaculate pleuræ and petiole.

ETHA FUSCIVENTRIS, *sp. nov.*

*Nigra; flavo-maculata; apice metanoti late maculisque pleuralis flavis; pedibus sordide fulvis, posticis fusco-maculatis, tarsis albis; alis hyalinis, stigmatè testacco. ♀.*

Long. 12; terebra 3 mm.

Antennæ black; the scape and the base of the flagellum dirty testaceous; the seventh to thirteenth joints clear white; head black; the face, clypeus, labrum, mandibles (except their teeth), palpi, the inner orbits narrowly from the front ocellus to the base of the antennæ, and the outer orbits broadly on the lower half, yellow. The face punctured, strongly and more closely on the middle, which is roundly projecting; the clypeus

almost impunctate ; the large labrum (which is rounded at the apex) dull rufous (perhaps discoloured). The base of the mandibles yellow, the middle rufous, the teeth black; the front and vertex smooth and impunctate. Thorax black, with a plumbeous hue; a line on the middle of the pronotum, the tegulæ, a mark on the apex of the middle lobe, the scutellum, post-scutellum, the apex of the median segment broadly (the mark broadly dilated backwards in the middle and to a less extent on the sides), the base of the propleuræ, a mark immediately under the hind wings, a larger mark on the lower side of the mesopleuræ (oblique at base and apex and slightly narrowed on the top and bottom in the middle), a smaller mark above this (roundly curved and narrowed towards the apex above), a larger mark of almost equal width behind this, and a large oblique mark, slightly and gradually narrowed towards the apex in the middle of the metapleuræ, yellow. Mesonotum impunctate, covered with a short pale down; the furrows smooth, deep; the base of the scutellum is black; the black part of the metanotum has a distinct plumbeous hue; the two transverse keels are distinct and curved backwards in the middle; the segment is covered with long pale hair. Pleuræ impunctate; behind the basal keel on the mesopleuræ are some short keels; shortly behind the middle is a belt of striations; the apex is stoutly crenulated, as is also the apex of the metapleuræ; on the depression on the base of the latter at the top are two narrow keels. Mesopleuræ very smooth and shining, the furrow crenulated. Wings hyaline, with a slight fulvous tinge; the stigma fuscous, paler in the middle; the nervures fuscous; the areolet almost square, receiving the recurrent nervure in the middle, where the cubital nervure is slightly angled in the middle; the second transverse cubital nervure is faint; the transverse

median nervure is interstitial. Legs obscure fulvous; the four anterior coxæ and trochanters are yellow; the hinder coxæ are darker and are broadly black on the outer side, more narrowly at the base, the mark being narrowed on the upper side at the base; the femora are infuscated above; the apex of the tibiæ broadly black; the tarsi white, black at the base, and thickly spinose. Abdomen black, shining, the apices of the segments yellow.

---

The following species agrees with the other species of *Etha* in all respects, except that the areolet is smaller, it being almost square, with the second transverse cubital nervure faint; the recurrent nervure is received shortly behind the middle: the basal abscissa of the radius is straight, oblique; the apical has a slight, rounded curve upwards; the sub-discoïdal nervure is received shortly, but distinctly, above the middle of the discoïdal; on the base of the median segment in the centre is a small triangular depression; the second transverse keel is indistinct in the middle and ends in a short, triangular projection.

ETHA TESTACEIPES, *sp. nov.*

*Nigra; facie, ore, apice scutelli, post-scutelloque pallide flavis; pedibus flavo-testaceis; coxis, femoribus tibiisque posticis nigro-maculatis; tarsis posticis albis, basi nigro; alis hyalinis, stigmatate testaceo.* ♀.

Long. 12 mm.

Antennæ black; the eighth to twelfth joints white below; the scape shagreened, aciculate, almost bare, testaceous in the middle; the flagellum bare, slightly thickened from the middle. Head black; the face closely

punctured ; broadly projecting in the middle ; the projection depressed in the middle above ; the face is covered with a short, sparse, white pubescence ; the clypeus is roundly convex, smooth ; surrounding it on the top is a black line ; its apex has a narrow, but distinct, border. Mandibles and palpi pallid yellow ; the mandibular teeth deep black ; the inner orbits are narrowly yellow to near the front ocellus ; there is a narrow line on them near the top of the eyes, and the outer orbits are somewhat more broadly yellow on the lower half. Thorax black, opaque, the sides and apex of the scutellum, the post-scutellum, the lower side of the propleuræ, and the tubercles, yellow. Mesonotum opaque, granular ; the parapsidal furrows are distinct to near the apex ; the scutellum is more shining and smoother. Median segment closely, rugosely punctured, more finely and closely at the base, where, next to the keel, it is obscurely striated ; in the centre are two oblique keels, forming an enclosed area ; the central and apical parts are thickly covered with short, white pubescence ; the lateral spines are distinct, and bluntly triangular. The upper part of the propleuræ and the apical, more particularly in the middle, are stoutly striated, the upper part strongly aciculated, the base smooth. Mesopleuræ opaque, coarsely aciculated ; the apical part finely striated ; the lower furrow is wide and stoutly striated. Metapleuræ closely, rugosely punctured, the punctuation running into striations towards the apex. Mesosternum shining, aciculated ; the central furrow crenulated. Legs pale fulvous ; the anterior coxæ and trochanters pallid yellow ; the middle coxæ infuscated, the anterior broadly black in the middle behind ; the hinder femora are lined with black above ; the apex of the tibiæ and the base of the tarsi are black ; the remainder of the tarsi white ; the

hinder tibiæ and tarsi are distinctly spined. Wings hyaline; the nervures fuscous; the stigma pallid on the lower side; the areolet is square; the second transverse cubital nervure is faint; the recurrent nervure is received shortly beyond the middle, and is largely bullated in the centre; the transverse median nervure is received shortly behind the basal. Petiole shining and smooth; the dilated part depressed in the middle above; the other segments are more opaque, obscure testaceous at the apex; the gastrocelli are shallow, testaceous at the apex, the base with a shining, smooth keel.



The following two species agree with the foregoing in neururation and in the form of the spiracles; but differ in having the metathorax closely, distinctly, and finely rugose. In *E. dentata* the median segment is depressed in the middle and armed with two teeth; there is one transverse keel on it; the parapsidal furrows are distinct; the apex of the abdomen is white; the tarsi spinose.

ETHA DENTATA, *sp. nov.*

*Nigra; linea pronoti maculaque medio scutelli flavis; alis hyalinis, stigmatate fusco. ♂.*

Long. 9 mm.

Antennæ black; the scape below, and the middle of the flagellum broadly, except above, white. Head black; the eye orbits all round, narrowly on the top on the outer side, the antennal tubercles and a mark on the face, broadest below, the clypeus, base of mandibles, labrum and palpi, yellow. The face and clypeus closely and uniformly punctured, and thickly covered with short white pubescence. The front and vertex closely and finely rugosely punctured, the front closely transversely below,

and narrowly above on either side of the keel ; the front slightly depressed in the middle, which has a narrow but distinct keel. Mandibles black, their base testaceous above and below. Thorax black ; a narrow line on the pronotum, the lower edge of the propleuræ, a mark, narrowed at base and apex, and longer than broad on the middle of the scutellum, yellow. Mesonotum opaque, but not punctured ; the parapsidal furrows transversely striated ; the scutellum closely distinctly punctured ; its basal depression wide and deep, and stoutly longitudinally striated ; the space at its sides and at the sides of the post-scutellum coarsely striated. The median segment at the base behind the transverse keel opaque, granular ; the central area closely and finely rugose ; the rest of the segment finely rugose ; the base closely, but not very distinctly, obliquely striated ; the second transverse keel is indistinct ; the spines are about three times longer than broad, and rounded at the apex. Propleuræ covered with stout, slightly curved, striations, except at the top and bottom. Mesopleuræ closely rugosely punctured, the punctures running into reticulations in the middle ; the metapleuræ closely obliquely striated, the striæ stronger and more distinct at the base. Mesosternum strongly aciculated ; the central furrow widely, triangularly enlarged at the apex ; the lateral furrow curved, deep and striated at the base ; its apical part shallow, indistinct except at the end. Legs dark ferruginous ; the coxæ and trochanters black, except the anterior at the apex ; the hinder tarsi spinose, yellowish-white ; the basal two-thirds of the metatarsus black. Areolet slightly longer than broad, of equal width throughout ; the second transverse cubital nervure faint ; the recurrent nervure is received in the middle. The middle segments of the abdomen rufous at the apices.

ETHIA RUFO-FEMORATA, *sp. nov.*

*Nigra; tibiis tarsisque anterioribus testaceis; femoribus posticis rufis; tarsis posticis late albo annulato; alis hyalinis, stigmatе fusco. ♂.*

Long. 9 mm.

Antennæ entirely black, thickly covered with a short black pile. Head black, thickly covered with short, white pubescence; a mark on the mandibles before the teeth above and the palpi white. Face and clypeus opaque, finely and closely punctured; the vertex somewhat more coarsely punctured; there is a thin keel below the ocelli. Thorax black; a conical mark (the broad end at the apex) on the apex of the scutellum, and the post-scutellum, yellow. Mesonotum closely punctured, thickly covered with short, pale pubescence; the parapsidal furrows wide and deep at the base, and stoutly transversely striated. Scutellum shining, the punctures, especially at the base, not quite so close together as on the mesonotum; its basal depression wide and deep, and with two keels in the middle. Median segment at the base closely punctured; the rest of the segment more coarsely and rugosely punctured; in the middle at the base are two oblique keels. Propleuræ strongly, obliquely striated; the upper part in the middle coarsely punctured; the base coarsely aciculated. Meso- and metanotum coarsely rugose, opaque. Mesosternum closely punctured; the central furrow shallow, wide. Legs black; the apices of the anterior femora, the tibiæ and tarsi testaceous, those of the middle legs darker in tint; the hinder femora ferruginous, except at the extreme apex; the extreme base of the tibiæ, and the second to fourth joints of the tarsi, yellowish-white. Areolet large, almost square; the second transverse cubital nervure is faint; the recurrent nervure is received in the middle; the stigma and



nervures are fuscous. Petiole aciculated; an oval, transverse yellow mark on its apex, the apex of the second segment and of the third more narrowly, fulvous; the last segment largely white.

DAGATHIA, *gen. nov.*

Areolet large, longer than broad; the transverse cubital nervures straight, parallel; the radial cellule elongate; the transverse median nervure is received behind the transverse basal. Antennæ stout, the joints elongate. Eyes large, parallel. Clypeus with a distinct margin, which is slightly dilated laterally. Occiput sharply margined. Parapsidal furrows distinct. Median segment with two transverse keels; the spiracles elongate. Petiole elongate; the apical half dilated, curved; the spiracles placed near the base of the dilated part. Legs stout; the anterior tibiæ distinctly narrowed at the base; the tarsi twice their length; the hinder tarsi spinose; the fourth joint with a bunch of stiff, stout spines on the apex.

This genus comes nearest to *Etha*, but may be known from it by the rugose, not smooth, median segment, by the post-petiole being distinctly separated and defined, by the scutellum being broader than long, and by the transverse median nervure being received behind the basal.

DAGATHIA BRUNNEA, *sp. nov.*

*Brunnea; flavo nigroque maculata; pedibus pallide flavis, apicibus femorum tarsorumque posticorum nigris; tarsis posticis albis; alis hyalinis, stigmatate fusco.* ♀.

Long. 14 mm.

Antennæ black; the middle of the flagellum with a broad whitish-yellow band; the scape punctured, sparsely

covered with short, white hair. Head yellow, the front, vertex, and occiput broadly in the middle, black ; the face is sparsely covered with short, white hair ; its middle is rough ; the front and vertex closely rugose ; the former most strongly and furrowed down the middle. Mandibles yellow, the teeth black. Thorax dark rufous ; the base of the mesonotum, a line in the centre of the middle lobe, its apex entirely, the apex of the scutellum, a spot in the middle of the median segment, the greater part of the propleuræ, the base and apex of the mesopleuræ narrowly, its lower part broadly, the base of the meta-pleuræ broadly and the mesosternum, black. The middle of the pronotum, the tubercles, the sides of the scutellum (except at the apex), the apex of the median segment, the tubercles, a large and a smaller mark on the apex of the mesopleuræ, a mark under the hinder wings, and an oblique mark on the apex of the metapleuræ in the middle, yellow. The mesonotum is granular ; the median segment is closely rugose behind the first transverse keel ; the rest of it much more strongly rugosely punctured, running into striations on the sides ; the second transverse keel is narrow and curved backwards in the middle ; the sides are expanded. Pleuræ closely punctured ; the middle and lower part of the apex of the propleuræ stoutly striated ; the apex of the mesopleuræ finely and irregularly striated ; the furrow on the lower edge wide and striated. The four front legs are pallid yellowish-fulvous ; the apex of the front and the middle tarsi entirely, black ; the hinder coxæ are broadly black on the outer side and to a less extent on the inner side at the apex ; the femora are broadly black above ; the apical fourth entirely, the apical third of the tibiæ, and the apex of the tarsi, black. Wings hyaline, with a slight fulvous tinge ; the basal abscissa of the radius straight ; the apical

curved upwards at the base ; the areolet is longer than broad ; the nervures parallel ; the recurrent nervure is received near the apical third ; the transverse median behind the basal. Abdomen dark brown ; the petiole black, with a yellow mark in the middle at the apex ; the dilated apex of the petiole is strongly and closely punctured.

AGLAOCRYPTUS, *gen. nov.*

Metathoracic spiracles round, small. Antennæ annulated with white, longer than the body, not tapering towards the apex ; the third joint a little longer than the fourth. Eyes large, distinctly distant from the base of the mandibles. Clypeus rounded at the apex ; the labrum projecting distinctly in the middle, and broadly rounded. Mandibles large, and with two equal teeth at the apex. Parapsidal furrows distinct. Scutellum roundly convex and not carinate. Median segment opaque, finely and closely rugose ; it has two transverse keels. Areolet converging at the top ; the second transverse cubital nervure is faint ; the transverse basal nervure is interstitial. Petiole curved, not much dilated towards the apex ; the spiracles are placed shortly beyond the middle.

AGLAOCRYPTUS CURVIMACULATUS, *sp. nov.*

*Niger; late flavo-maculatus; apice metanoti flavo; pedibus rufis; coxis trochanteribusque anterioribus pallide flavis; alis hyalinis, nervis stigmatique pallide flavis.* ♀.

Long. 9 ; terebra 3 mm.

Antennæ slightly thickened towards the apex ; the middle of the flagellum and the under side of the scape white. The face (except a small triangular mark under the antennæ), and two small marks on the sides above

the clypeus, the clypeus, labrum, a mark on the base of the mandibles, the palpi and the orbits, yellow. The face and clypeus smooth, impunctate and covered with short white pubescence; the front finely and closely obliquely striated on either side of the middle, which has no keel or furrow. Mandibles finely and closely striated. Mesonotum strongly and closely shagreened; the parapsidal furrows transversely striated. Scutellum closely punctured, thickly covered with short, fuscous hair; the post-scutellum impunctate; both are lemon yellow; the lateral depressions strongly striated. The basal region of the median segment strongly aciculated, opaque; the rest closely punctured; the sides at the base longitudinally striated; the basal transverse keel is distinct; the second only distinct at the sides; the spines are broad and not much raised. Except for a spot in the middle at the apex, the apical part of the median segment is yellow; the yellow at the base being dilated backwards in the middle; there is a yellow line on the pronotum, a broader one on the underside of the propleuræ, the tubercles, the greater part of the lower half of the mesopleuræ, the latter mark broadly turned upwards at the base, the lower part of the turned-up part roundly incised on the lower side at the apex; an elongated mark on the median segment on the sides behind the wings, this mark being rounded at the base, and a large, somewhat conical mark on the middle of the metapleuræ, lemon-yellow. Legs rufous, the four anterior coxæ and trochanters and the hinder coxæ at the middle behind, yellow; the apex of the hinder tibiæ, the basal half of the metatarsus and the apical joint, black; the rest of the tarsi white. Wings clear hyaline, slightly narrowed at the top, where it is about one half the length of the bottom; the second transverse cubital nervure is faint, but clearly defined; the recurrent

nervure is received very shortly before the middle. Abdomen black ; the apex of the segments broadly pale yellow ; the two last segments entirely so.

AGLAOCRYPTUS STRIATIFRONS, *sp. nov.*

*Niger, flavomaculatus; linea late medio metanoti flava; pedibus rufis; coxis trochanteribusque anterioribus flavis; alis hyalinis, stigmatate testaceo.* ♀.

Long. 10 mm. ; terebra 3 mm.

Antennæ black ; the scape, the apex of the sixth and the seventh to the twelfth joints beneath, white. Head black ; the orbits (the outer more narrowly than the inner), a large mark on the face, narrowed roundly on the lower side, immediately under the antennæ, the clypeus, the mandibles (except at the apex), and the palpi, pallid yellow. The face in the middle is closely and distinctly punctured and sparsely covered with short, white hair ; the front is keeled down the middle, the sides closely transversely striated ; the vertex in the middle closely punctured. Thorax black ; a line on the pronotum, the scutellum, post-scutellum, the tubercles, a broad line on the middle of the median segment, squarely turned up at the top and at the sides including the broad spines ; the lower edge of the propleuræ broadly ; the tegulæ, tubercles, a somewhat oblong mark immediately under the hind wings ; a mark longer than broad, on the lower side of the mesopleuræ at the base, a longer perpendicular mark on the apex, and a large, elongate mark on the middle of the metapleuræ, yellow. Mesonotum closely punctured, finely striated on either side of the furrows ; the base of the median segment behind the keel finely rugose ; the rest of the segment much more strongly and closely, rugosely punctured ; in front of the middle of the transverse keel are some longitudinal striations ; there is also a row of short keels at

the apex. Propleuræ strongly obliquely striated above; the base is smooth. Mesopleuræ closely rugose, irregularly striated; the metapleuræ finely rugose, striated towards the apex. Mesosternum shining, closely punctured; the central furrow deep, marked with some keels on the oblique apex. Legs rufous; the four anterior coxæ and trochanters pallid yellow; the hinder coxæ marked with yellow on the base above; the apex of the hinder femora, the base of the tarsi more narrowly and their apical joint, black; the rest of the tarsi white. The apices of all the abdominal segments are yellow; the basal two with the yellow bands slightly larger.

A larger and stouter species than *A. curvamaculatus*; may be known from it by the marks on the mesopleuræ being separated, not united, by the yellow mark on the median segment being narrower, by the front being much more strongly striated and by the apical two segments of the abdomen not being entirely yellow.

#### CHLOROCRYPTUS, *gen. nov.*

Antennæ stout, slightly dilated and compressed beyond the middle. Eyes parallel, distinctly separated from the base of the mandibles. Clypeus roundly convex, not separated from the face by suture. Mandibles with two subequal teeth on the apex; the second joint of the maxillary palpus dilated compared to the others. Mesonotum trilobate at the base. Scutellum rather flat. Median segment coarsely transversely striated all over, without areæ or prominent keels; the spiracles linear, elongated, rounded at the base and apex. Apical third of the petiole distinctly dilated, slightly curved, the spiracles small, round, placed near the base of the post-petiole. Ovipositor projecting. Legs long and slender, the tarsi spinose at the apices of the joints, the claws simple, the fore tarsi

twice the length of the tibiæ. Areolet small, square, complete; receiving the recurrent nervure at the apex; the transverse median nervure almost interstitial; the third discoidal cellule is much narrowed at the base; the cubital nervure curved.

This genus does not fit well into any of the tribes into which Thomson divides the *Cryptidæ*, but comes nearest the *Cryptina*, from which it differs in the median segment having no keels but being strongly transversely striated all over. It has the small areolet of *Mesostenus* and, like it, receives the recurrent nervure in the apex; the transverse basal nervure is straight, oblique, and is almost parallel with the transverse basal for the most part: the costa is narrow, elongate; the parapsidal furrows are obsolete; but the middle of the mesonotum is raised. The antennæ are stouter, especially towards the apex, than in *Cryptus* or *Mesostenus*.

CHLOROCRYPTUS METALLICUS, *sp. nov.*

*Coeruleus; nigro-maculatus; antennis nigris, medio albo-annulato, apice fusca; alis hyalinis, nervis stigmatæque fuscis.* ♀.

Long. 12; terebra 4 mm.

The scape of the antennæ dark metallic green, the five basal joints of the flagellum black; the eighth to thirteenth joints for the greater part white; the apical brownish. The face and base of the clypeus closely punctured, the apex of the clypeus smooth and shining, impunctate and of a lighter green. Mandibles black, their middle dark piceous, the palpi dark fuscous, the second joint for the greater part whitish. Mesonotum black, green in the middle; the sides of the middle lobe with some stout transverse keels; the middle with large, deep, clearly separated punctures; the apex irregularly reticu-

lated in the middle ; the lateral lobe smooth in the middle towards apex, which is itself entirely smooth. The scutellar depression deep, wide and smooth. The scutellum is smooth, except for some scattered punctures ; the sides behind have stout, slightly oblique, keels, the post-scutellum smooth and impunctate ; the depression at its sides with stout keels. Median segment stoutly uniformly and closely transversely striated. Pro- and mesopleuræ closely punctured ; the lower and posterior part of the former stoutly longitudinally striated ; the middle of the latter closely obliquely striated, and with a smooth space behind ; the mesosternum laterally bounded by a shallow, slightly oblique, furrow ; its central furrow with a few stout transverse keels ; the surface shining, closely, but not very strongly, punctured. The metapleuræ strongly, closely and slightly obliquely, striolated. Legs coloured like the thorax, except that the tibiæ and tarsi are darker, almost black and not metallic ; the apex of the front femora and the tibiæ fuscous. Petiole shining and bearing scattered punctures ; the dilated apex with them more numerous than the base ; the second, third, and fourth segments closely punctured, the others almost smooth, the apical black, with a purple tinge.

CHLOROCRYPTUS COERULEUS, *sp. nov.*

*Coeruleus ; nigro-maculatus ; mesonoto striolato ; alis fere hyalinis.*

Long. 18 ; terebra 5 mm. ♀.

Face dark blue, darker at the sides ; the middle roundly concave, depressed in the centre ; closely punctured, thickly covered with short, white hair. Mandibles closely and distinctly punctured at the base ; dark blue, the apex black and smooth ; the palpi blackish, thickly covered with short white hair. The front over the antennæ de-



pressed, smooth, shining, blue, greenish above ; the upper part furrowed down the middle, its lower side with two stout, transverse keels, with an oblique one above them ; above these, laterally, are two or three irregular keels ; the sides are closely punctured ; the vertex is closely punctured, much less strongly laterally. The middle of the mesonotum is closely irregularly punctured ; its apex furrowed in the middle, the furrow with a central keel ; this central part is bordered at the base with irregular keels, which form reticulations ; laterally by two stout keels, which curve obliquely round its apex ; the apex is stoutly irregularly reticulated ; the sides are smooth, except at the tegulæ, where they are punctured. Scutellum with widely separated punctures. Post-scutellum smooth, bifoveate at the base. Median segment strongly reticulated at the base ; the middle and apex more closely and regularly reticulated ; the apex has an oblique slope, is slightly hollowed in the middle, bordered above by a keel, which is larger at the sides. Propleuræ strongly obliquely striated, the base on the lower part smooth. The upper and lower apical parts of the mesopleuræ irregularly striated ; the base closely punctured ; the sternal furrow is wide, deep, does not reach much beyond the middle, and bears some stout keels. Mesosternum finely and closely punctured ; its apex oblique and bearing some stout, oblique striæ in the middle. Wings hyaline with fuscous tint, lightly iridescent ; the stigma and nervures are black ; the areolet small, almost square ; the second transverse cubital nervure is largely bullated in the middle ; the recurrent nervure is received in the middle. Legs dark blue ; the tibiæ and tarsi darker, the fore tibiæ and femora dark testaceous in front ; the tarsi closely spinose. Abdomen smooth and shining ; the sides and apex of the petiole closely punctured.

A larger species than *C. metallicus*; may easily be known from it by the median segment being closely reticulated, not transversely striated, by the darker coloured wings with black nervures, and by the distinct projecting keel on the middle of the metanotum.

CNEMOCRYPTUS, *gen. nov.*

Has the median segment areolated, as in the *Hemitelina* and *Phygadneuonina*. From the former it may be known by the second transverse cubital nervure being distinct, by the antennæ being larger and not so stout towards the apex, and the areolet larger and more distinctly square in shape; from the *Phygadneuonina* by the longer and more slender antennæ, by the larger square areolet, which receives the recurrent nervure before the middle, and by the spiracles on the petiole being received nearer the middle.

Antennæ as long as the body, thickened towards the apex; the basal joints of the flagellum elongate, clypeus large, deeply foveate laterally above, where it is separated from the face by a suture. Mandibles bidentate. Occiput margined. Parapsidal furrows distinct at the base. Median segment completely areolated; the spiracles small, oval. Areolet square, large; not narrowed above; the recurrent nervure received shortly before the middle; the transverse median nervure interstitial; the cubital nervures in the hind wings pellucid. Legs stout, the hinder tarsi annulated with white. Petiole longer than the second segment, not much dilated towards the apex; the spiracles placed shortly beyond the middle; the apical segment white above; the ovipositor exerted.

CNEMOCRYPTUS VALIDICORNIS, *sp. nov.*

*Niger; abdominis apice annuloque antecornarum albis; scutello flavo; femoribus, tibiis tarsisque anterioribus*

*testaceis ; femoribus posticis rufis ; tarsis posticis nigris, late albo annulato ; alis hyalinis, stigmatè pallide testacco. ♀.*

Long. 8 ; terebra 2 mm.

Antennæ black ; the seventh to eleventh joints white, except above ; beyond the seventh slightly, but perceptibly, thickened ; the scape with a faint microscopic pile ; obscurely punctured. Head with the mandibles entirely black ; the palpi pale testaceous, black at the base. Head opaque, aciculated ; the face thickly covered with a silvery pubescence ; the clypeus shining, sparsely punctured. Thorax black ; the mesonotum strongly aciculated ; the parapsidal furrows wide and distinct at the base ; the scutellum and post-scutellum yellow ; the scutellum on the outside obliquely striated. Median segment finely rugose ; the base strongly aciculated ; the suprmedian area is three times longer than wide, the basal half becoming gradually narrowed towards the apex ; the apical half of equal width ; the other areæ are distinct ; the middle transversely striated. The upper part of the propleuræ strongly aciculated ; the lower longitudinally striated ; the mesopleuræ strongly aciculated, the middle running into striations ; the metapleuræ coarsely aciculated ; the upper part behind the spiracles strongly, obliquely striated ; the keel on the middle of the metapleuræ stout, curved ; the part immediately above it with a row of short keels. The four anterior legs dark testaceous ; the coxæ and trochanters black ; the hinder femora fulvous ; the tarsi testaceous, darker towards the apex, which is itself black ; the hinder tarsi white, except the basal and the apical two joints, which are deep black. Wings clear hyaline, the stigma pale testaceous ; the nervures pale fuscous ; the areolet square ; the recurrent nervures received almost in its centre. Abdomen black ; the apex of the first and second segment rufous ; the apex of the penultimate and the

whole of the last segment white; the apical half of the petiole depressed laterally, the depression forming almost a groove; the second and third segments are pale testaceous.

ODONTOCRYPTUS, *gen. nov.*

Head transverse; the eyes large, projecting in front, not reaching to the base of the mandibles. Clypeus separated from the face; its apex ending in two stout, triangular teeth. Mandibles stoutly bidentate, the upper the larger. Mesonotum with the parapsidal furrows complete. Scutellum flat; its sides at the base stoutly keeled. Median segment completely areolated, and with stout spines; its spiracles small, oval. Petiole longish, dilated, but not abruptly, at the apex; the spiracles small, round. Wings large; the areolet pentangular; the basal nervure interstitial. Legs longish; the hinder tarsi elongate, spinose; the fore tarsi incised at the base; the tibiæ twisted at the apex. Ovipositor exerted. The antennæ in the ♀ are longer than usual; the third and fourth joints are equal in length.

The noteworthy points of this genus are the stoutly bidentate clypeus, stoutly carinate scutellum, unusually long and slender antennæ, distinctly areolated median segment, and small, round, metathoracic spiracles. In form it agrees best with the *Cryptina*, but it differs from that group in the areolated median segment; it comes nearer to *Hemiteles*, but that genus may be known from it, apart from its clypeus not being bidentate, by the incomplete areolet, by the shorter antennæ, &c.

ODONTOCRYPTUS BIDENTATUS, *sp. nov.*

*Niger; late flavo-maculatus; antennis nigris, medio albo annulato; pedibus rufo-fulvis, coxis trochanteribusque*

*anterioribus flavis, coxis posticis nigris; alis hyalinis, stigmatè pallido, nervis fuscis.* ♀.

Long. 8 mm.

Antennæ black; the apex of the sixth, and the seventh to tenth joints of the flagellum, white; the scape yellowish beneath. Head black; the face, clypeus broadly at the base, the base of the mandibles broadly and the eye orbits narrowly above, broadly on the outside below, yellow; the apex of the clypeus with the teeth, and the teeth of the mandibles, black. The face finely punctured in the middle, closely covered with short pubescence; the palpi yellow. The front and vertex shining, smooth and impunctate; the ocelli are bordered laterally by a furrow. Thorax black, the edge of the pronotum broadly; two narrow lines on the mesonotum placed nearer the apex than the base, the scutellum, post-scutellum, the sides of the median segment below and including the spines, the top of the posterior median area, the base of the prothorax broadly, the tubercles, a large mark on the upper part of the mesopleuræ ending above in a hook-shaped piece, the greater part of the lower side, a small mark on the side of the mesosternum, a small mark under the hinder wing and the greater part of the metapleuræ between the keels, yellow. Mesonotum closely and finely punctured; the scutellum smooth; the basal depression deep, smooth; the keels stout; the keel on the sides of the scutellum extending to shortly beyond the middle. Median segment smooth and shining; all the areæ complete, the keels stout; the basal median area large, obliquely narrowed towards the apex; the suprmedian somewhat longer than wide; transverse at the base and apex; the sides obliquely narrowed at the base; the posterior median area rounded at the base; the keels

indistinct towards the middle and apex; the spines are large, broad, rounded at the top. The propleuræ stoutly striated behind; the mesopleuræ above near the middle longitudinally striated; beneath this is a small belt of large, deep punctures, below this again are some stout, longitudinal furrows; the keel over the mesosternum is deep and clearly defined at the base, shallow and broader at the apex, where it is rough and bordered by some stout keels. The mesosternum is largely oblique at the base; the furrow there is wide and crenulated; the sternum is smooth and shining; the keel on the apical part is narrower than on the basal. Legs rufo-fulvous; the four anterior coxæ and trochanters yellow; the hinder coxæ black, yellow at the base above and at the apex below; the hinder tarsi white; the basal half of the metatarsus and the terminal joint, black. Areolet pentangular, narrow, the lower part twice the length of the upper; the lower part angled, receiving the recurrent nervure shortly beyond the middle; the latter is broadly curved and is bullated at the top and bottom; the transverse basal nervure is interstitial. Abdomen black; the apices of the segments banded with yellow; the petiole smooth; the sides above keeled, the keel curving up above the spiracles; the gastro-cœli are shallow, indistinct.

ODONTOCRYPTUS SULCATUS, *sp. nov.*

Long. 8 mm. ♂.

Very similar in coloration to *O. filicornis*, but may be easily separated from it by the form of the supramedian area which is longer than broad, while in *O. filicornis* it is broader than long.

Antennæ black to the twelfth joint, the remaining joints being broken off; the scape yellow beneath; the flagellum thickly covered with short, stiff, black pubescence. Head

black ; the face, clypeus, labrum, mandibles (except the teeth), palpi, the inner orbits narrowly above to the end of the eyes, and the lower orbits more broadly, from near the top, yellow ; the apex of the clypeus, with the teeth, black. The face is closely and rather strongly punctured, especially in the middle ; the clypeus more sparsely and finely punctured ; the mandibular teeth deep black. Thorax black ; the prothorax, scutellum (except at the apex), the post-scutellum, the median segment from shortly above the teeth, the mesopleuræ (except round the edges), the metapleuræ, except at the base—above from the spiracles, and a line on the sides of the mesosternum (not extending to the apex), yellow. The mesonotum is shagreened ; the scutellum is smooth ; the median segment very smooth and shining ; the basal central area is large, obliquely narrowed towards the apex ; the supramedian is longer than broad ; transverse at the base, where its sides are oblique ; the apex is rounded inwardly ; the spines are long, sharp, broad at the base. The propleuræ are smooth, except for a band of stout striations on the apex ; the base and apex of the mesopleura crenulated ; in the middle is a shallow, irregularly striated furrow ; on its lower side is a wide and deep furrow which is irregularly and indistinctly striated. Legs pale fulvous ; the coxæ and trochanters pallid yellow ; the hinder legs of a darker and deeper fulvous colour ; the coxæ yellow, with a large black irregular mark on the apex, above ; the trochanters broadly at the base above, the base and apex of the femora narrowly, the apex of the tibiæ more broadly, black ; the tarsi white ; the base and apex blackish. Wings hyaline, iridescent ; the stigma and nervures dark fuscous ; the areolet, at the top, is about one half the length it is at the bottom ; below it is angled where the recurrent nervure is received near the middle ; the second

transverse cubital nervure is fainter than the first. Abdomen black ; the apices of the segments pallid yellow ; the petiole with two narrow keels on the sides above, the upper not reaching to the apex ; the gastrocoeli at the base finely and distinctly punctured ; the apex on the inner side obscure testaceous.

### HEMITELINA.

#### HEMITELES KHASIANUS, *sp. nov.*

*Niger ; prothorace, mesopleuris, mesosterno metathoraceque rufis ; pedibus rufis, tibiis tarsisque posticis fuscis ; ais hyalinis, stigmatе nervisque fuscis. ♂.*

Long. 6 mm.

Antennæ absent ; the front and vertex are smooth and shining ; the vertex behind the ocelli thickly covered with fuscous hair ; the face opaque, alutaceous, thickly covered with short pale hair ; clypeus smooth and shining ; mandibles rufous, yellowish in the middle ; the palpi pallid yellow. Thorax rufous, smooth and shining ; the mesonotum black. Metanotum tinged with yellow in the middle ; all the areæ complete ; the supramedian is longer than broad, transverse at the base and apex ; pleuræ smooth and shining ; the oblique furrow on the mesopleuræ is obscurely striated at the base. Wings clear hyaline ; the stigma narrowed at the top ; triangularly produced on the lower side, where the roundly curved recurrent nervure is received in the middle. The four anterior coxæ and trochanters are pallid yellow ; the hinder coxæ marked with black on the outer side ; the hinder tibiæ are paler on the inner side. Petiole black, long and slender ; the base above smooth ; the rest closely, longitudinally striated, more irregularly and strongly at the apex ; the second strongly, closely longitudinally punctured ; the third less strongly ; the others still less



strongly; all the segments are rufo-testaceous on the apex.

HEMITELES INTERMEDIUS, *sp. nov.*

*Niger; annulo flagello antennarum, orbitis oculorum supra, tegulis scutelloque albis; metathorace petioloque rufis; pedibus rufis; coxis trochanteribusque albis; tibiis tarsisque posticis fuscis; alis hyalinis, stigmatè pallido.* ♀.

Long. 8 mm.

Antennæ black; the middle with a broad white ring. Head black; the inner orbits above on the inner side white in the middle; the white bands narrowed at the top and bottom. The face closely punctured; the clypeus with the punctures much more widely separated; the mandibles broadly dirty testaceous in the middle; the palpi white; the front and vertex closely and uniformly punctured. Thorax with the metathorax entirely rufous, as is also the post-scutellum; the scutellum yellow: the middle of the mesopleuræ behind obscure rufous. Mesonotum closely and uniformly punctured; the parapsidal furrows are indicated at the extreme base; the lateral scutellar depression stoutly keeled. The median segment is distinctly areolated; the basal central area is large, broader than long; the supra-median is slightly longer than broad and rounded at the base; the entire segment is closely and strongly punctured; the apical area closely transversely striated; there are no teeth. The pro-, meso-, and metapleuræ closely punctured; the propleuræ striated behind. Mesosternum closely punctured; the middle furrow deep, of equal width throughout and closely crenulated. The four anterior legs obscure rufo-testaceous; the coxæ and trochanters white; the femora are darker; the hinder coxæ and trochanters are rufous, largely marked with black below and laterally towards the apex; the

hinder tibiae are broadly black towards the apex; the tarsi black, the joints narrowly testaceous at the base and apex. The areolet is narrowed above; the second transverse cubital and the upper part of the first pale; the recurrent nervure is received in the middle. The petiole rufous; the post-petiole raised in the middle and closely punctured; the second segment black; the sides at the base rufous and closely striated; the apical third obscure yellowish-testaceous; the apical two segments are clear white.

PHYGADNEUON PULCHRIPES, *sp. nov.*

*Nigrum; pedibus abdominisque medio rufis; clypeo, mandibulis palpisque albis; alis hyalinis, nervis stigmatumque fuscis. ♂.*

Long. 7 mm.

Antenna: stout, thickly covered with short, microscopic pile, the thirteenth to sixteenth joints white; head black; the clypeus, labrum, the mandibles to near the base of the teeth, and the palpi, white; the face, clypeus, and base of mandibles thickly covered with longish white hair; the face finely and closely punctured; the front and vertex closely and distinctly punctured, and thickly covered with short fuscous hair. Thorax black, except the pronotum above; the mesonotum closely punctured, thickly covered with short fuscous hair; the scutellum is not quite so closely punctured; its sides roughly shagreened. Median segment opaque, coarsely aciculated in the middle, the sides closely, finely rugose; the sides at the apex closely, irregularly striated; the basal areæ not clearly defined through the keels being interrupted, this being also the case with the apical keel.

The pleuræ closely, uniformly punctured, thickly covered (as is also the breast) with short, fuscous pubes-

cence, the lower furrow not clearly crenulated. The coxæ are black; the four anterior white at the apex; the four anterior trochanters white; the apex of the hinder tibiæ and the tarsi black; the apex of the basal joint and the second, third and fourth joints white; abdomen black; the apex of the petiole and the second and third segments rufous. The areolet is not much narrowed above; the second transverse cubital nervure is faint; the recurrent nervure is received in the middle.

This species has the antennæ of *Phygadneuon*, but the second transverse cubital nervure is faint as in *Hemitcles*; the lateral areæ are not clearly defined through the keels being indistinct.

JAVRA, *gen. nov.*

♂. Antennæ short, not longer than the abdomen, stout, the basal joint of the flagellum not much longer than the second. Head small, narrower than the mesothorax, not much narrowed behind the eyes; the occiput not margined. Eyes large, parallel, not touching the base of the mandibles. The clypeus separated from the face by a suture; its apex bluntly rounded. Mandibles with two large, nearly equal teeth. Palpi slender. Mesonotum with distinct parapsidal furrows. Scutellum large, its apex distinctly narrowed. Median segment with a rather elongated slope; areolated; the basal areæ not complete, being open at the base; the spiracles small, roundish. Petiole slender, not much thickened towards the apex; the spiracles are placed in the middle where the segment is tuberculate.

I have unfortunately only a ♂; but its characteristics appear to be sufficiently distinct from *Phygadneuon* by *e.g.*, the smaller head with its occiput not margined, by the more distinct parapsidal furrows, by the more slender

petiole, with its spiracles placed in the middle, by the longer and more slender legs, and by the longer abdomen.

JAVRA PARVICEPS, *sp. nov.*

*Nigra; annulo antennarum, facie, ore, mandibulis, palpis, tegulis, scutello, post-scutello coxisque anterioribus albis; alis hyalinis, stigmatibus fuscis. ♂.*

Long. 8 mm.

Antennae black; the scape and the fourteenth to twentieth joints white; the base of the flagellum brownish; thickly covered with stiff hairs, which are shorter towards the apex. Head black; the entire face, the clypeus, mandibles (except at the apex), and the palpi, clear white; the face and clypeus smooth and impunctate, sparsely covered with short white hair; the rest of the head also smooth and impunctate, almost glabrous. Thorax black; the base of the prothorax, the scutellum, post-scutellum, tubercles and tegulae, clear white. Mesonotum shining, covered with a microscopic fuscous pubescence; the parapsidal furrows only distinct on its basal half. Scutellum smooth, covered with short, pale hairs. Median segment thickly covered with longish white hair; the basal area with the keels interrupted and consequently they are not defined; the posterior median area is wide, rounded at the base, slightly narrowed towards the apex. Propleurae smooth, the upper part with a narrow furrow; the base behind the white line and the apex stoutly striated; mesonotum smooth, the lower part in the centre with a broad, slightly oblique, striated band; the lower half of the metapleurae closely and finely punctured. Mesosternum smooth, shining; thickly covered with short, pale pubescence; the lateral furrow reaches shortly beyond the middle; the centre is widely depressed, especially on the

apical half, and has a distinct furrow in the middle. The four anterior legs are bright fulvous, their coxæ and femora white; the hinder femora are of a darker fulvous colour, darkened towards the apex; the coxæ paler at the base; their apex broadly infuscated; the tibiæ blackish, the base pale testaceous; the tarsi white, the basal third of the metatarsus black. The areolet is nearly square; the second transverse cubital nervure is faint; the recurrent nervure is largely bullated in the middle, and is received shortly before the middle. Abdomen black; the base of the petiole broadly, its apex more narrowly, almost the apical halves of the second and third segments, and the apical segments entirely, pale white.

---

The following species agrees closely in body form with the preceding, and in the form and position of the spiracles, but it differs in the antennæ being much longer (longer than the body), the joints being more elongate; the recurrent nervure is received near the base of the areolet, which is longer. The base of the thorax is not so distinctly raised above the head, which is as wide as the thorax, and the median segment has the areæ much more distinctly defined.

JAVRA LONGICORNIS, *sp. nov.*

*Nigra; facie, clypeo, basi mandibularum late, palpis, tegulis, scutello, maculisque duobus metanoti albis; pedibus anterioribus pallide fulvis; femoribus posticis, apice tiliarum basique tarsorum nigris; alis hyalinis, stigmatate fusco. ♂.*

Long. 7 mm.

Antennæ filiform, longer than the body; the under side of the scape and a band of eleven joints beyond the middle white; the flagellum densely covered with stiff

microscopic hair. The face, clypeus, labrum, the mandibles (except at the apex), and the palpi, white; the face and clypeus smooth, sparsely covered with long hair; the front and vertex smooth, impunctate, glabrous; on the inner orbits, above the antennæ, is a yellow band, which is narrowed considerably on the lower part. Thorax black, shining; the tegulæ, tubercles, scutellum, the apex of the post-scutellum, two slightly oblique marks on the apex of the metanotum, longer than broad, and bluntly rounded at the apex, white. Mesonotum minutely punctured; the parapsidal furrows only defined on the basal half. Scutellum smooth: the basal keels acute, not extending on to it; the post-scutellum with a distinct depression bordered by oblique keels at its base. On the base of the median segments are two large, curved keels which do not, in the middle, reach to the base of the segment. The supra-median area is almost completely defined; the posterior median completely so and is bluntly rounded at the top; the part beyond the large basal area is irregularly closely striated. Propleuræ smooth, the apex with a narrow striated belt; the mesopleuræ finely and closely obliquely striated, smooth above and on the apex; the metapleuræ coarsely aciculated, smooth at the base above; the tooth is not very conspicuous, is white and somewhat triangular; the four anterior legs are pale fulvous; the coxæ and trochanters are white; the hinder coxæ and femora are black, their base and the trochanters fulvous; the tibiæ dark fulvous, the apical third black; the claws black; the tarsi white, the basal half of the metatarsus black. Wings clear hyaline; the stigma fuscous on the lower side; the areolet moderately large, very slightly wider on the anterior end; the recurrent nervure is received near the apex of the basal third. Abdomen black; the apices of all the segments white; the gastrocæli shallow, fulvous on the apex.

**XV. Further Investigation on the Detection and Approximate Estimation of Minute Quantities of Arsenic in Malt, Beer, and Food Stuffs.**

By WILLIAM THOMSON, F.R.S.E., F.I.C.

*Received and read March 3rd, 1903.*

Since my paper on this subject, read before the Manchester Section of the Society of Chemical Industry on the 2nd May, 1902, and published in the *British Food Journal*, Vol. IV., Nos. 44 and 45 (1902), and in the *Medical Chronicle* for October, 1902, I have continued the investigation with the view of improving on the process there described for detecting and estimating minute quantities of arsenic.

*Wrapping the heated portion of the tube in copper wire gauze.*

It was recommended by the Joint Committee of the Society of Chemical Industry and of the Society of Public Analysts, that a piece of copper wire gauze about one inch square be wrapped round the tube which receives the mirror at the point at which it is heated (immediately before the drawn-out portion). I directed my attention to find what advantage this offered over the heating of the naked glass tube, and ascertained that the use of the copper wire gauze was a positive disadvantage, the mirrors being less distinct with, than without, the wire gauze.

*September 29th, 1903.*

*Fig. 2 (a)* shows photographic production of the mirrors in three tubes, which were obtained from 50 c.c. of a solution containing  $\frac{1}{500}$  of a grain per gallon of arsenic trioxide  $As_2O_3$  in which the naked tube was heated, whilst *Fig. 2 (b)* shows photographic productions of mirrors in three tubes in the production of each of which 50 c.c. of the same solution were used, but where the heated portion of the tube was wrapped in one layer of copper wire gauze, as recommended by the Joint Committee. It will be seen, on comparing these two series of tubes, that in each case more distinct and reliable mirrors are obtained by heating the naked tube than by heating it when wrapped in wire gauze.

I tried to determine the temperature at which small quantities of arsenic would be deposited from arseniuretted hydrogen, mixed with free hydrogen by placing the tube for receiving the mirror at right angles through an iron tube, underneath which was a Bunsen flame which was gradually raised, but I found that when heated to the full safety range of my thermometer, *viz.*,  $393^{\circ}C.$ , no trace of arsenic mirror was produced on the cooled part of the drawn-out portion of the tube. This result does not confirm the statement made in D. Mendeléeff's "The Principles of Chemistry," (English edition, 1897), Vol. II., p. 182, where he says, in speaking of arseniuretted hydrogen—"But its presence in the most minute quantities may be easily recognised from the fact that it is *easily decomposed* by heat ( $200^{\circ}C.$  according to Brunn) into metallic arsenic and hydrogen."

The gas containing arseniuretted hydrogen requires to be heated to a very high temperature before all the arsenic is deposited as a mirror, and it appears evident that the wire gauze prevents the attainment of the necessary temperature for the complete decomposition of all the arseniuretted hydrogen present.



*Influence of temperature at the drawn-out portion of the tube on which the mirror is deposited.*

With the view of obtaining information as to this, I used for each of the following tests 50 c.c. of a solution containing  $\frac{1}{86}$  of a grain of arsenic trioxide per gallon.

The tubes used are rather wider at the drawn-out parts than those which I now prefer to use, the first mirrors forming at a point having an internal diameter of about  $\cdot 063$  of an inch (1.6 mm.).

Tube No. 1, *Fig. 3*, shows the photographic representation of the mirror obtained in the ordinary way, by heating the naked tube with the top of a Bunsen flame 4 inches long, protected from draughts by a conical chimney to within an inch of the top of the flame, as previously described by me. It will be observed that two deposits have formed near to each other. The first has a brownish metallic appearance and the second is black.

The result of the second experiment is shown in tube No. 2 in this series. This tube was enclosed in another tube between the points (*a*) and (*b*), kept at 100° C. by passing a current of steam through it, and half-an-inch from the end of the steam jacket the tube was cooled by means of a piece of tissue paper over which a current of cold water was kept rapidly dropping.

It is remarkable that the temperature of boiling water prevented the formation of the mirror altogether. The small ring of mirror formed just outside the beginning of the steam jacket, whilst the uncondensed arsenic passed for half-an-inch along the tube outside the steam jacket without depositing, and only made its appearance as a black deposit at the point (*c*) where it came in contact with the cooling effect of the stream of cold water.

The outside of the tube No. 3 in the series was

covered with one layer of tissue paper from (*d*) to (*e*) and a stream of water at 50° C. was kept flowing over it. It is remarkable that at this temperature the bulk of the arsenic was deposited at the point where the comparatively hot water flowed over the tube, and it is curious to observe that on the further portion of the tube heated to this temperature no further mirror formed, but when the gas passed along the tube to the part which was not heated (to 50° C.) a second faint black deposit was formed, and, after leaving an interval of the tube free from deposit, a third, still fainter, black deposit made its appearance.

The tube No. 4 in this series was cooled by placing over it between the points (*f*) and (*g*) a single layer of tissue paper, which was cut into a triangular shape at the bottom, and over which water at 15° C. was kept rapidly dropping, as shown in *Fig. 1*. In this tube only one mirror was formed at the point where it came in contact with the cooled tube.

It was evident, then, first, that the cooling of the tube was an important condition for obtaining the largest mirrors; secondly, that when the tube was cooled to about 15° C. only one mirror formed; thirdly, that that mirror had a metallic lustre, and no second or third black deposit ever formed on any other part of the tube.

Since making these experiments I find that two other chemists have drawn attention to the importance of cooling the portion of the tube arranged for receiving the mirror, the first being Gabriel Bertrand, who employs a strip of filter paper 4 to 5 mm. wide wrapped two or three times round the tube and fed with water drop by drop; and the second A. Gautier, whose method (*Bull. Soc. Chim.*, 1902, p. 27 (20, 21)) consists in applying a brass rider, the lower part of which is kept immersed in crushed ice.

My experience has shewn that the best results have

been given by a piece of tissue paper 3 or 4 inches long by  $\frac{3}{4}$  inch wide, folded in the centre and hung over the tube for receiving the mirror, over which water is allowed to drop rapidly, the two hanging folds being cut to a point to allow the water to run off in a single stream into a glass placed underneath. A roll of several layers of filter paper is not so effective for cooling, as the cold water takes some time to penetrate the several layers of paper.

*Brown - metallic looking mirrors and black arsenic deposits.*

It has been suggested by the Joint Committee above mentioned, and by other chemists, that the presence of oxygen or air, if mixed with the hydrogen from the generating apparatus, tends to produce black deposits rather than metallic arsenic mirrors; this seems to be so, but the explanation appears to be that the heat produced by the burning of the oxygen and hydrogen at the red-hot portion of the tube, evaporates the mirror after it has been deposited in the brown-metallic condition, and it then deposits a little further on in the black form. On gently warming the brown-metallic mirror with a small Bunsen flame, whilst the hydrogen is still flowing, the metallic mirror is evaporated and deposited a little further on as a black deposit. I have tried thus converting the metallic mirrors into black deposits, with the view to ascertain whether such deposit would form a better measure of the quantity of arsenic present than the metallic mirror, but have found that the quantities are better indicated by the brown-metallic mirrors than by the black deposit.

I have studied somewhat more minutely these two forms of arsenic. The first, or brown form, with metallic

lustre, is that which is crystalline and firmly adherent to the glass tube ; the second, or black form, is amorphous, and can easily be removed from the tube by gentle rubbing.

I was led to believe that the amorphous form contained occluded gaseous matter, and I have spent some time in collecting a quantity of it (several grammes) which was placed in a tube from which the air was exhausted by a Töpler pump, which is the method employed by Sir William Ramsay for removing helium from various minerals. After the tube was exhausted till no further gas could be drawn from it, the black arsenic was heated and it volatilized and condensed in the crystalline form, but no trace of gaseous matter was liberated from it.

*Internal diameter of the tube upon which the arsenic mirror is deposited.*

As the tubes used by me are all drawn out in the same manner from previously selected tube, they are found to be very closely the same in the internal diameter of the bore, but, as these tubes are slightly conical, I devised a simple measuring arrangement for obtaining the mirrors on exactly the same internal diameter of tube. This consists of an iron wire with the one end thinner than the other ; the thicker end is first put into the drawn-out portion of the tube and then the thinner end, to see that the difference in the distance between which they enter is about  $\frac{1}{4}$  of an inch, which it generally is, although the distance of the wider portion from the beginning of the drawn-out part varies slightly ; the tissue paper for cooling is then placed so that the edge nearer the flame is exactly at the point where the entrance of the thicker end of the wire is arrested, and the mirrors, being

all deposited at this point in the different tubes (where the cold water comes in contact with the glass), more accurate measures of the quantities of the deposits are obtained.

With the view of keeping the tubes hot to the point at which the cold water comes in contact with the narrow glass tube, to prevent the formation of a mirror before the portion of the tube is reached on which it should be deposited, I put a small coil of copper or platinum gauze  $\frac{5}{8}$  of an inch square around the tube, so as to cover the rounded part of the drawn-out portion and part of the narrow tube to within  $1\frac{1}{2}$  mm. of the paper. I use a flat Bunsen flame *one* inch wide, the flame acting on about  $\frac{3}{4}$  of an inch of the uncovered glass tube, with the end of the flame playing on the wire gauze.

*Fig. 4* shows mirrors obtained by the cooling process on the tubes of accurately measured internal diameter.

The apparatus employed for carrying out the process is shown in *Fig. 1*.

#### *Fading of the arsenic mirrors and black deposits.*

In my previous papers on the approximate estimation of arsenic, I have mentioned that I had not observed that any of my arsenic mirrors had faded even when exposed to air and light, but, as other chemists had had experience of fading, and had recommended the sealing of the mirrors in an atmosphere of hydrogen to prevent it, I considered it desirable to carry out this process, and have since done so.

I was much surprised, however, to find that the mirrors which were made by the old process, and the original photographs of which are seen in *Fig. 5*, faded after

exposure to the light for six weeks ; a second photograph of the same, taken after exposure, is shown in *Fig. 6*.

It is difficult to imagine why these arsenic mirrors and deposits should have wholly or partially disappeared after being sealed up in an atmosphere of hydrogen. It is curious, however, that, whilst the mirror from the middle tube has entirely disappeared, those in the first and third tubes have only partially faded.

Other instances of fading are shown in the photographs *Figs. 7* and *8*, all the deposits being obtained by the old process, in which the tubes were not cooled with water. The tubes Nos. 1 and 2 were unsealed, 3 and 4 were sealed in air, 5 and 6 in hydrogen, 7 and 8 in nitrogen, and 9 and 10 in carbon dioxide, the mirrors being from the same amount of arsenic solution. The tubes 2, 4, 6, 8, and 10 were detached from the card and exposed to the light for one month, the others being kept in the dark ; they were then remounted and again photographed. It will be seen in *Fig. 8* that the mirrors in tubes 2 and 4 (exposed to the air) and in 8 (exposed to pure nitrogen prepared by heating ammonium nitrite, and passing the same through a tube containing copper gauze heated to redness) have faded considerably, while in tubes 6 and 10 (in hydrogen and in carbon dioxide) the black or second portion of the deposit only has faded. The mirrors formed by the cooling process appear to have suffered no change in hydrogen.

My modified and new process affords a much more accurate method of approximately estimating minute quantities of arsenic, and it is much more delicate than the process previously employed ; it is, in fact, so delicate that I have now failed to get any zinc which is absolutely free from any trace of arsenic. A very distinct mirror is formed with the  $\frac{1}{2000}$ th of a grain of arsenic trioxide per

gallon, when working with 50 c.c., that is, one part in 140,000,000 parts of liquid, and half that amount can be detected, that is, 1 part in 280,000,000, which is equivalent to 1 grain of arsenic trioxide dissolved in 4,000 gallons of beer, *i.e.*, 1 grain dissolved in 111 barrels of beer of 36 gallons each, which is equivalent to 18 tons weight of beer.

## EXPLANATION OF PLATES.

## PLATE I.

*Fig. 1.* Apparatus employed.

*Fig. 2.* Photographic production of mirrors.  $\frac{1}{500}$ th gr. per gallon of  $\text{As}_4\text{O}_6$  when using 50 c.c.

(*a*) With the naked tube, heated directly with Bunsen flame.

(*b*) With the heated portion of the tube wrapped in wire gauze.

*Fig. 3.* Showing the effect of temperature on the formation of the mirrors and arsenic deposits in a solution containing  $\frac{1}{500}$  of a grain per gallon of  $\text{As}_4\text{O}_6$ , when using 50 c.c.

1. Ordinary Marsh test method (without special cooling).
2. Enclosed in a steam jacket from (*a*) to (*b*), and cooled with cold water at (*c*).
3. With current of water at  $50^\circ\text{C}$ . passing over the outside of the tube between (*d*) and (*e*).
4. With current of water at  $15^\circ\text{C}$ . passing over the outside of the tube between (*f*) and (*g*).

## PLATE II.

*Fig. 4.* Standard bore tubes, using 50 c.c. with different quantities of  $\text{As}_4\text{O}_6$ . Cooling method.

*Fig. 5.* Arsenic mirrors before exposure to the light.  $\frac{1}{200}$ th gr. per gallon  $\text{As}_4\text{O}_6$  using 50 c.c.

*Fig. 6.* The same mirrors seen in *Fig. 5*, after exposure to the light for six weeks.

*Fig. 7.* Photographs of five pairs of arsenic deposits, made by old method, respectively unsealed, and sealed in air, hydrogen, nitrogen, and carbon dioxide.  $\frac{1}{100}$ th gr. per gallon using 50 c.c.

*Fig. 8.* Photographs of same after the right hand one of each pair had been exposed to the light for six weeks.



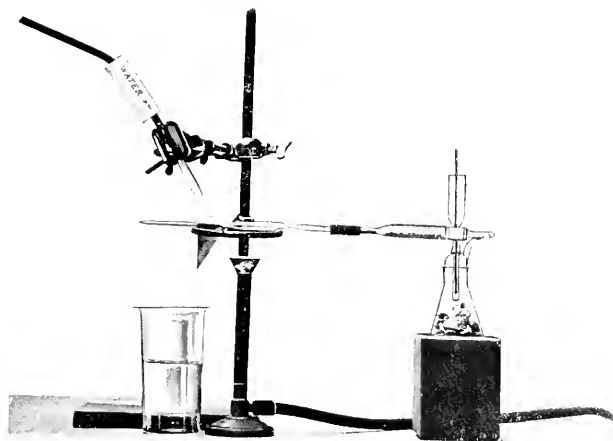

Fig. 1.

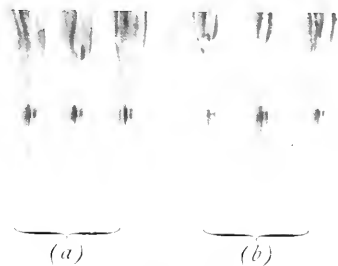

Fig. 2.

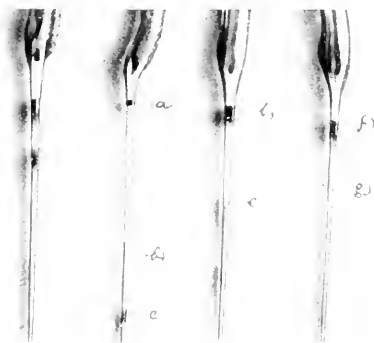

Fig. 3.



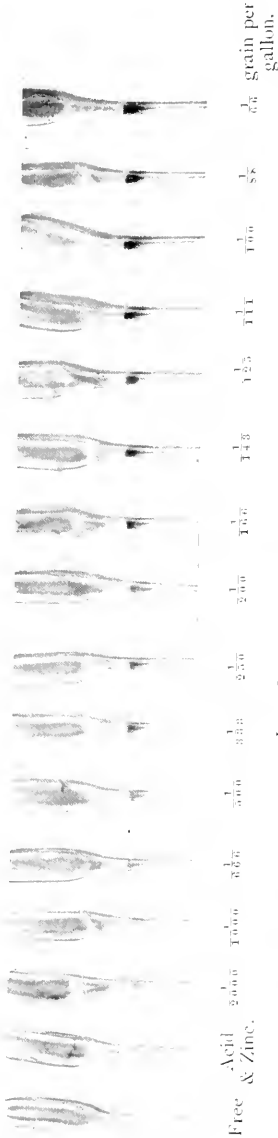

Fig. 4.

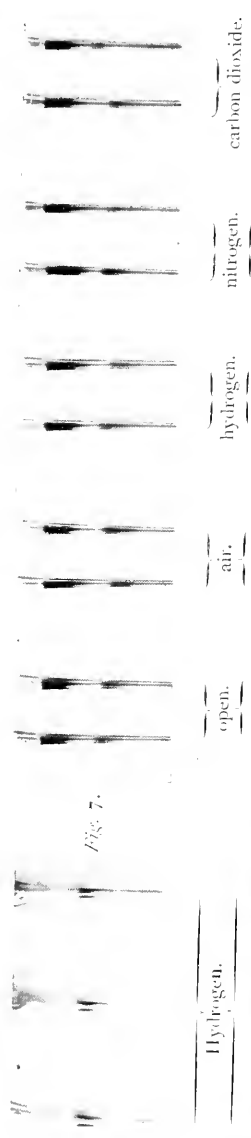

Fig. 5.



Fig. 6.



PROCEEDINGS  
OF  
THE MANCHESTER LITERARY AND  
PHILOSOPHICAL SOCIETY.

---

Ordinary Meeting, October 7th, 1902.

CHARLES BAILEY, M.Sc., F.L.S., President, in the Chair.

The thanks of the members were voted to the donors of the books upon the table.

Mr. R. L. TAYLOR, F.C.S., read a paper entitled, "**On the Reaction of Iodine with Mercuric Oxide in Presence of Water.**"

---

General Meeting, October 21st, 1902.

CHARLES BAILEY, M.Sc., F.L.S., President, in the Chair.

Mr. WALTER WOOLLCOTT, Attorney, Manchester; Mr. F. A. BRUTON, M.A., Assistant Master at the Manchester Grammar School; and Professor W. JACKSON POPE, F.R.S., F.C.S., Professor of Chemistry at the Municipal School of Technology, Manchester, were elected ordinary members of the Society.

---

## Ordinary Meeting, October 21st, 1902.

CHARLES BAILEY, M.Sc., F.I.S., President, in the Chair.

The thanks of the members were voted to the donors of the books upon the table.

Mr. THOMAS THORP, F.R.A.S., stated that he had recently demonstrated the explosive property of celluloid in a striking manner. He withdrew the cordite from a small ball cartridge, replaced it with powdered celluloid, and with this charge fired the bullet through a board one inch in thickness.

Mr. C. E. STROMEYER, M.Inst.C.E., read the following communication on "**The Growth of Miniature Volcanoes in Boiler Scale,**" and exhibited several specimens of scale.

The samples of boiler scale which are shewn this evening are of rare occurrence, and resemble, as will be seen, miniature volcanoes, their growth being I think very similar to the growth of real volcanoes, except that, instead of the added matter around the vents being thrown up as dust and lava, it is extracted from the boiler water in which it was held in solution. Probably the raising of the land around mineral springs is the exact counterpart of the growth of these vents in boiler scale.

Mr. Yarrow once made an experiment on circulation by suspending a U tube from a reservoir filled with water. Having heated, say, the right leg until circulation was set up, the circulation was not reversed when the flame was transferred to the left leg. If, therefore, good circulation by heating is once established, these conditions would have to change considerably before the current of steam and water is reversed.

In the case of hot springs, surface water enters into a porous stratum, and under favourable conditions descends to a depth where it acquires a considerable temperature. Should there be openings here to the surface, this warm water will rise and overflow, carrying with it soluble and even insoluble matter, which

under favourable circumstances deposits itself around the vent, whose top level may easily be raised to the level of the intake without in the least reducing the flow, even if the process illustrated by Mr. Yarrow is at work. In nature, the underground temperature contours must adapt themselves to the surface contours of the rising land around the vents, and the greatest heat will then be applied to the up-flowing water in the vent and not to the down-flowing water in the porous strata.

Thus far the action in hot springs and in the miniature volcanoes is identical, for wherever in a boiler the scale is thickest, there will the underlying boiler plate with its fire on the outside be the hottest, and, of course, the temperature of thick scale will be hotter than that of the surrounding thin scale.

Should the action of the hot spring continue for a considerable length of time, then its vent might rise to a considerable height above the intake, but only if the downtake channels descend to considerable depths. For obvious reasons this condition is most generally to be found near ocean shores, and it is here also that high volcanoes are most frequent. On first thoughts it might seem impossible for volcanoes like Chimborazo to have been built up in this manner, for the difference of pressure represented by a height of 27,000 feet above sea level, is greater than the difference of pressure due to down-flowing cold water and up-rushing superheated water and steam. Suppose, however, that this volcano had not grown; suppose that it had once been a mountain and that imprisoned superheated water and steam had blown off its cap, then it is necessary to explain why this water, which must have been led downwards through some natural channel, should not flow back into the ocean instead of overcoming an earth pressure represented by at least twice the height of the mountain. It is possible to conceive this action with low mountains, and it is notorious that the most violent eruptions have occurred with them, but it is impossible that high volcanoes should have been formed in this manner.

One notable feature of high volcanoes is that they are always active and their vents are always open; under such conditions,

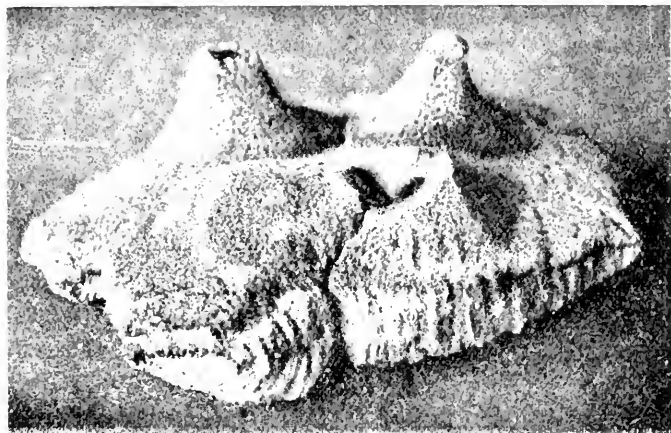

*Fig. 1.*

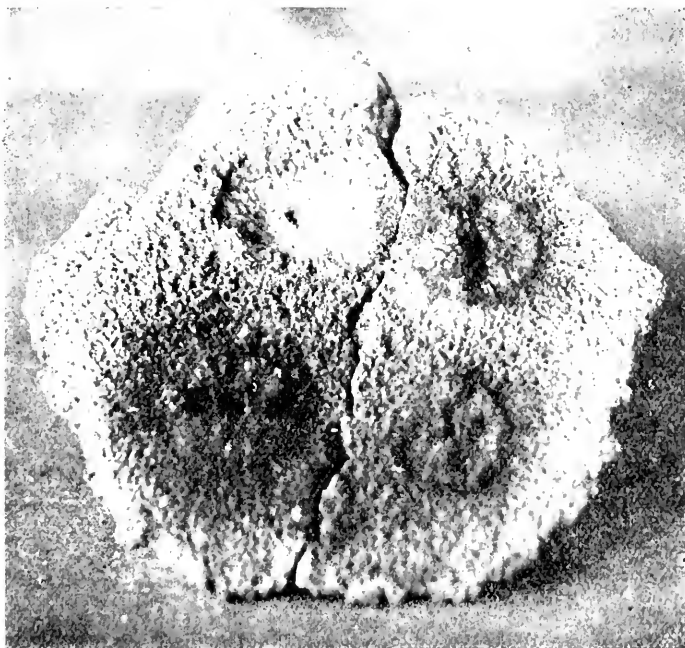

*Fig. 2.*



particularly as the core of such mountains must be very hot, these vents act almost like warm chimneys and produce an upward draught which assists the already highly heated steam to escape. Should such a vent get closed, then most probably the superheated steam would be capable of exerting sufficient pressure to burst out at the base of the mountain. It is also possible that the gradual adjustment of the internal temperature may cause the mountain crust to crack through its old vent, through which the old activity would recommence.

Amongst the specimens of boiler scale shewn is one mound cut in two. At one time the vent reached from the boiler plate to the surface; for some reason, possibly because of less heavy firing, scale has closed the vent, but should the firing have increased again, doubtless the whole mound would have been blown off the plate.

Some of the samples have been photographed. *Fig. 1* is a front view of a group of three high-peaked volcanoes and one mound (at the left front) whose vent is closed, but all four vents can be seen in *Fig. 2*, which is a view of the under side. The lower edge of *Fig. 1* corresponds to the top edge of *Fig. 2*.

The PRESIDENT read a paper "**On the Adventitious Vegetation of the Sandhills of St. Anne's-on-the-Sea.**"

---

General Meeting, November 4th, 1902.

CHARLES BAILEY, M.Sc., F.L.S., President, in the Chair.

Mr. JOSEPH EGERTON LEIGH, Didsbury; Mr. HENRY WENTWORTH BRADLEY, Wilmslow; and Mr. DUGALD CLERK, M.Inst.C.E., F.C.S., London, were elected ordinary members of the Society.

---

Ordinary Meeting, November 4th, 1902.

CHARLES BAILEY, M.Sc., F.L.S., President, in the Chair.

The thanks of the members were voted to the donors of the books upon the table. The following books were included amongst the recent donations to the Society's library:—*"The Fiction of the Ice Age or Glacial Period,"* by F. D. Longe (8vo., Lowestoft, 1902), presented by the author; *"The Pharmacological Action and Therapeutic Uses of the Nitrites and Allied Compounds,"* by the late Professor D. J. Leech, edited by Professor R. B. Wild (8vo., Manchester, 1902), presented by Mrs. Leech; *"Catalogue of the Library of the Zoological Society of London,"* 5th edition (8vo., London, 1902), presented by the Society; and *"International Engineering Congress (Glasgow), 1901. Report of the proceedings and abstracts of the papers read"* (8vo., Glasgow, 1902), presented by the Executive Committee of the Congress.

Mr. THOMAS THORP, F.R.A.S., exhibited specimens of aluminium he had soldered by the method of M. Margot mentioned in Prof. Threlfall's book "Laboratory Arts."

The aluminium is first cleaned by rubbing with warm potash and fine sand, washing off and drying. It is then heated over a clean flame, so as to melt the solder (an alloy of 92 per cent. of tin and 8 per cent. of zinc). The pieces of the metal required to be soldered are both treated in the above manner and "sweated" together. Mr. Thorp has found that no previous cleaning is required if the solder be run on to the metal and well rubbed in, whilst hot, with a stick of asbestos. When the surface appears bright, an amalgam has been formed, and the solder immediately adheres. In order to solder (say) brass to aluminium, the brass must be tinned in the usual way and flooded with pure tin. On the two metals being heated to a little above the melting points of the solders, independently, and placed together, a firm joint results.

Sir WILLIAM H. BAILEY exhibited the working model of the switchback centrifugal railway invented and made by

Richard Roberts. This model, which is thought to have been constructed about 1836 or 1838, was afterwards copied on a scale sufficiently large to convey a living traveller, and was exhibited in Manchester, Liverpool, and other places. The model is now the property of the Salford Corporation, and is deposited in the Peel Park Museum.

Mr. W. E. HOYLE, M.A., exhibited some coloured photographs prepared by the Sanger Shepherd process, which consists in taking three negatives of each picture through differently coloured screens, and then making positives which are stained with a colour complementary to that of each respective screen. When these are superposed, there results a slide which reproduces very accurately the hues of nature. The series exhibited included butterflies, shells, flowers, fruit, portraits and landscapes, taken direct from the natural objects, as well as copies of coloured prints, lithographs and illuminated manuscripts.

Mr. FRANCIS JONES, M.Sc., read a paper "**On the Action of Alkalies on Glass and on Paraffin.**"

---

Ordinary Meeting, November 18th, 1902.

CHARLES BAILEY, M.Sc., F.L.S., President, in the Chair.

The thanks of the members were voted to the donors of the books upon the table.

A paper by Mr. LIONEL E. ADAMS, B.A., entitled "**A Contribution to our Knowledge of the Mole (*Talpa europæa*),**" was communicated by Mr. W. E. HOYLE, M.A., F.R.S.E.

Mr. F. F. LAIDLAW, B.A., read a paper entitled "**Notes on some Marine Turbellaria from Torres Straits and the Pacific, with a description of new species.**"

---

Ordinary Meeting, December 2nd, 1902.

CHARLES BAILEY, M.Sc., F.L.S., President, in the Chair.

The thanks of the members were voted to the donors of the books upon the table.

Mr. FRANK SOUTHERN, B.Sc., exhibited and remarked upon a Japanese magic mirror.

Dr. C. H. LEES showed a small piece of apparatus used by him in the determination of the thermal conductivities of solids over wide ranges of temperature. It consists in principle of a differential hydrogen thermometer, one bulb of which is heated by an electric current either in a flat strip of metal wound round it or passing through the material of the bulb itself.

Mr. C. L. BARNES, M.A., showed a number of experiments depending on Hawksbee's law, *viz.*, that the pressure on the walls of a tube containing a fluid is less when the fluid is in motion than when it is at rest. Several of these are well known, *e.g.*, the apparent attraction which results when a current of air, radial or other, passes between two parallel discs, and the suspension of a ball on a jet of air or water. Other illustrations of the principle are that it is impossible to blow a celluloid ball, or even an inflated toy balloon, out of a funnel held in the ordinary upright position, though, if the funnel be reversed the ball or balloon can be supported without difficulty. Also, if a couple of celluloid balls are placed on a kind of railway made by fastening two rods to one another, they cannot be separated by blowing between them. The experiment of forcing a celluloid ball out of a tall glass cylinder by blowing downwards upon it was also performed, as were also several others of a similar character.

---

Ordinary Meeting, December 16th, 1902.

CHARLES BAILEY, M.Sc., F.L.S., President, in the Chair.

The thanks of the members were voted to the donors of the books upon the table, amongst the recent accessions being the following:—“*Manchester Museum. Museum Handbooks. Descriptive Catalogue of the Embryological Models*,” by the late A. Milnes Marshall, 2nd edition (8vo., London, 1902), presented by the Director; “*Publications of the Maharaja Takhtasingji Observatory. Vol. I. Report on the Total Solar Eclipse of January 21-22, 1898, as observed at Jeur in Western India*” (4to., Bombay, 1902), presented by the Government of Bombay; “*Fauna, Flora and Geology of the Clyde Area*,” edited by C. F. S. Elliott, M. Laurie and J. B. Murdoch (8vo., Glasgow, 1901), presented by Dr. Charles H. Lees; and “*Natural Law in Terrestrial Phenomena*,” by W. Digby (8vo., London, 1902), presented by Sir Isaac Pitman and Sons, Ltd.

The PRESIDENT announced that the Council had awarded the Wilde Medal for 1903 to Professor F. W. Clarke, of the United States Geological Survey, and a Dalton Medal to Professor Osborne Reynolds, F.R.S. In view of the fact that next year will be the centenary of the discovery of the atomic theory by Dalton, the Council have arranged that the Wilde Lecture for 1903 shall be delivered by Professor Clarke, whose writings on the atomic weights are so well known. The presentation of the medals and the delivery of the lecture will probably take place in May, 1903.

Mr. FRANK SOUTHERN exhibited two Japanese magic mirrors. These mirrors are of cast metal, circular in shape, slightly convex on the face, and have a design in relief on the back. When a bright light is reflected from the face, the design on the back is reproduced in the reflection. The face is not,

however, uniformly convex, the portions opposite the relief on the back being approximately plane. Writing with reference to the peculiar property of these mirrors, Person says :—“The rays “reflected from the convex portion diverge, and give but a “feebly illuminated image, while, on the contrary, the rays “reflected from the plane portions of the mirror preserve their “parallelism, and appear on the screen as an image by reason “of their contrast with the feebler illumination of the rest of “the disc.” Professors Ayrton and Perry give the following explanation :—“A preliminary operation in polishing the surface “consists of scoring the cast disc in every direction with a sharp “tool. The thicker portions with relief ornament offer more “resistance to the pressure of the tool than the thin flat portions “which tend to yield and form at first a concave surface, but “this, by the reaction of its elasticity, rises afterwards and forms “a slightly convex surface, while the more rigid thick portions “are comparatively little affected.” This explanation was accepted by Professor Sylvanus Thompson at a recent lecture on the subject.

Mr. SOUTHERN thought that, if this explanation were correct, it would be difficult to see how a very small area of thin metal lying in the middle of a thick area could be reproduced in the reflection, since it would be strongly supported by the thick metal and would not yield appreciably under the pressure of the scoring tool ; moreover, the rim, which is of the same thickness as the thicker portions of the design, would be distinctly shown in the reflection, which is not the case ; again, in some large specimens the portions of the surface opposite broad areas of relief on the back appear to be very slightly concave, for which the above explanation would not account.

It seems probable, therefore, that there must be some other or additional explanation, and Mr. SOUTHERN suggested that the peculiar properties of the mirrors might be caused by the varying densities of the thick and thin portions of the casting, due to unequal cooling ; the thicker portions, having cooled more slowly, would be softer and more readily abraded in the process

of polishing. This explanation would account for the irregular reflection of the rim, consisting of bright spots and patches, by the slight crumpling which would be caused by the stress of solidification ; also for the concavities representing the comparative softness of the inner parts of the thick area.

Dr. CHARLES H. LEES showed a large magic mirror, from which an excellent reflection was obtained, and an interesting discussion ensued on the subject of these mirrors.

Mr. R. W. ELLISON exhibited a series of eggs of the Common Guillemot (*Uria troile*), showing great variety in coloration and design of markings, eggs of various shades of green, blue, yellow, brown and red being prominent. The light coloured eggs predominate, fully 90 per cent. being shades of green and blue variously marked with brown or black, the dark shades of brown and red being only occasionally met with. The eggs are not provided with a protective colouring, but their shape prevents them from rolling off the narrow sloping ledges on which they are deposited. The birds breed in colonies on rocky headlands, and each bird lays one egg on the ledges of the cliffs. If the egg be taken or destroyed whilst it is fresh, a second egg is laid a fortnight later, but, should incubation have commenced, no more eggs are laid during the season. While incubating, the bird sits facing the cliff and holding the egg between its legs, but, should the egg be removed, the bird will then turn and face the sea. The eggs of each individual bird do not vary in the ground colour, that is to say, a bird that has once laid a green egg will not lay eggs of any other colour. It has also been noticed that each bird invariably returns to the same spot on the cliff to lay its eggs.

The following paper was read :—

### “The Graphic Computation of Lenses.”

By C. E. STROMEYER, M.INST.C.E.

[*Abstract.*]

Having drawn attention to a remark in Lummer's "Optics" to the effect that the computation of oblique rays which do not

cross the optic axis of a lens system "would frighten off even a practised computer," he pointed out that this difficulty is largely due to the method adopted, according to which one has to find the intersection points of rays, which method is generally tedious and breaks down for lateral rays passing through imperfectly designed lenses. A very much simpler method would be to find the paths in a system of lenses of various rays of a beam of light, to compute their focal lengths accurately, and if these foci do not fall at the same distance together,—in which case the focal region is reduced, as it should be, to a point (the apex of a cone),—to treat them as if they were tangents of a caustic. This process is only correct for those rays which may be supposed to pass through elementary radial apertures. The paths of those rays which may be supposed to pass through elementary tangential apertures coincide with the paths of those just mentioned, but the focal lengths of the two systems of rays are not necessarily the same. The tangential rays must, however, be looked upon as tangents to the caustics of the lateral rays. With the help of this explanation and a few simple formulæ given in the paper, it is possible to draw the radial and lateral caustics for two sheets of light placed normally to each other, and, with the help of the figures thus obtained, it is then a simple matter to obtain an enlarged representation of the focal region of a beam of light. This focal region, as already mentioned, should be the point of a cone.

The following paper was communicated by Mr. R. L. TAYLOR, F.C.S.:—

### **A Simple Form of Vernier Microscope.**

By A. ADAMSON, A.R.C.S.

This apparatus is specially devised to suit the elementary student in a physical laboratory who is familiar with the use of the vernier, and who wishes to calibrate or determine the bore of a glass tube by measuring the length of a mercury thread within it. The ordinary form of vernier, or micrometer, microscope used for this purpose is expensive, and usually too



elaborate for the elementary student, who is probably not familiar with the principle or use of a compound microscope.

In the simple apparatus to be described, no new principles of measurement are introduced, nor is any attempt made to attain the accuracy of the better instruments; but the parts are all clearly visible and easy to understand, readings can be taken by verniers to one-hundredth part of a centimetre or inch, and two methods of avoiding parallax errors are employed.

The apparatus consists of a wooden base, on the upper surface of which are fixed horizontally two parallel scales half a metre long, divided in tenths of inches and centimetres respectively (*Fig. 1*). Between the two scales the base has a longitudinal

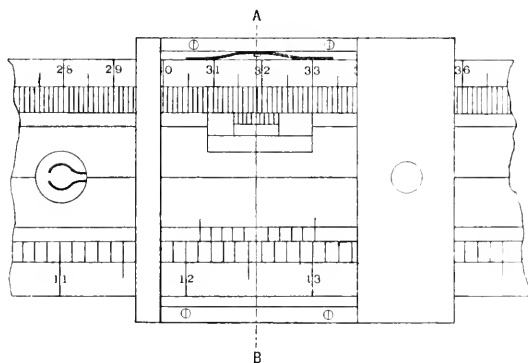

*Fig. 1.* Plan (lens removed).

V-shaped groove, in which the tube to be calibrated rests, the sides of the groove being made white for illuminating purposes (*Fig. 2*). A circular hole is cut through the base at one part of

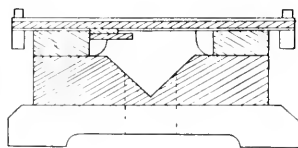
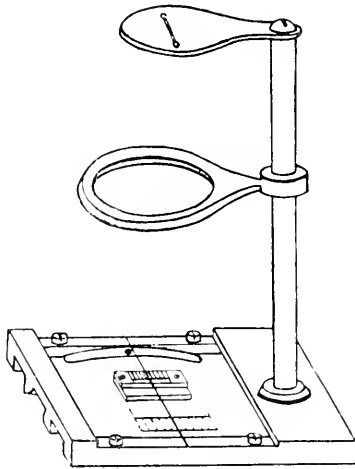

*Fig. 2.* Section at AB.

the groove, and a spring clamp is arranged for holding in this hole

a piece of tube of fairly wide bore with its axis vertical, so that its diameter may be measured directly.

The arrangement for reading is similar to the cursor used with a slide-rule. A thin plate of transparent celluloid is fixed in a metal frame which can slide freely and steadily over the scales and groove (*Fig. 3*). On the under surface of the celluloid is



*Fig. 3.* Sketch of slider, lens, &c.

marked a fine transverse straight line, which is adjusted, by sliding the metal frame, so as to be exactly over the end of the mercury thread to be measured. A short strip of mirror glass is fixed to the under surface of the celluloid, so that parallax errors may be avoided. The readings on the scales are taken by the aid of two verniers attached to, or engraved on, the under surface of the celluloid plate, each vernier having ten divisions corresponding to nine divisions on the main scales.

The observations are made through a simple microscope, or reading lens, carried by the sliding frame. The lens is supported by a vertical pillar so that its centre is exactly over the cross line on the celluloid plate, and at a suitable height

above it. The pillar also supports, above the lens, a metal disc in which is cut a narrow slot parallel to the cross line and vertically over it. By observing the cross line through the slot and lens, parallax is entirely avoided.

---

General Meeting, January 6th, 1903.

CHARLES BAILEY, M.Sc., F.L.S., President, in the Chair.

Mr. CHARLES OLDHAM, Knutsford, and Mr. ALEXANDER L. MELLANBY, M.Sc., Manchester, were elected ordinary members of the Society.

---

Ordinary Meeting, January 6th, 1903.

CHARLES BAILEY, M.Sc., F.L.S., President, in the Chair.

The thanks of the members were voted to the donors of the books upon the table. The following works were included amongst the recent donations to the Society's library:—“*The Hepaticæ of the British Islands*,” by W. H. Pearson, 2 vols. (4to., London, 1902), presented by Mr. Fred H. Smith; “*Midland Churches: a History of the Congregations on the Roll of the Midland Christian Union*,” by G. E. Evans (4to., Dudley, 1899), presented by the author; “*Un seul Champignon sur le Globe!*” by L. Hugues (8vo., Port Louis, Mauritius, 1902), presented by the author; “*Histoire de la Société Dunkerquoise, 1876-1900*,” by M. E. Debacker (8vo., Dunkerque, 1901), presented by the Society.

Mr. ALFRED BROTHERS sent the following “**Note on Japanese ‘Magic’ Mirrors**,” which was read by the Hon. Secretary.

In the report of the discussion on Japanese “magic” mirrors it is stated that the probable cause of the pictures

reflected from the polished surfaces of some specimens is that, the thick parts of the pattern cooling more slowly than the thin parts, the density would be different, and the raised pattern would be reproduced on the polished front of the mirror in plane surfaces. The mirrors are of different sizes and may vary in thickness according to size, but, as they are cast in moulds, those of each size would be approximately of the same thickness; therefore the explanation can scarcely be correct, as all specimens of the mirrors do not produce the reflected or "magic" pictures. A dealer in Japanese goods once informed me that he had examined many dozens of mirrors, and out of more than 100 only two were of the "magic" sort.

Professor F. E. WEISS, D.Sc., gave an account of some of the botanical features of Western America, based upon observations made during his recent visit to that country. Westward of Winnipeg lie the fertile plains of Manitoba, representing the floor of a great inland sea of a former geological epoch. These are admirably suited for wheat raising, and at present successive wheat crops can be obtained without having resort to rotation of crops or manuring. Summer fallowing from time to time is sufficient for the recuperation of the soil. Many experiments have been made at the Government experimental farms to provide the settlers in Manitoba with fruit trees suited to the rigour of the climate, and Dr. Saunders has been successful in obtaining several valuable hybrids by crossing the Siberian Crab (*Pyrus baccata*) with different varieties of the apple. Many thousands of trees, chiefly of the Manitoba Maple (*Negundo aceroides*), are distributed yearly to farmers to form shelter belts around their homesteads.

In the Canadian Rockies the dominant trees are the White and Black Spruces, the Canadian Hemlock, the Arbor Vitae (*Thuja occidentalis*) and the Balsam Fir, yielding the Canada balsam.

Crossing the "Great Divide" the vegetation becomes more luxurious, owing to the greater rainfall and to the milder climate resulting from the warm ocean current on the Pacific Coast.

In the Selkirk range the Douglas Spruce and the Giant Cedar (*Thuja gigantea*) become abundant, and increase in size nearer the coast, culminating in trees with a girth of 40 to 50 ft. in Stanley Park, Vancouver. Going South, along the Pacific Coast, the Californian Cedar (*Libocedrus decurrens*) replaces the Giant Cedar of the North, and other interesting trees with a limited distribution are met with. Thus the Californian Redwood (*Sequoia sempervirens*) is restricted to the moist valleys of the Coast Range, while the Big Trees (*Sequoia gigantea*) occur in a few scattered groves in the drier Sierra Nevada, even at altitudes of 6,000 ft. Here they grow to a height of 200 to 300 ft., attaining a girth of over 100 ft., and reaching an age of 1,500 to 2,000 years. The forests in which the Big Trees occur contain for the most part Yellow and Sugar Pines.

The foothills of the Sierra Nevada, with a smaller rainfall, have a sparse vegetation consisting largely of evergreen shrubs and trees, including several species of "Live Oak." Shrubby Composites, Evening Primroses, and many plants with very sticky leaves, so-called tar-weeds, are among the interesting forms of vegetation. East of the Sierra Nevada the rainfall is very slight, and large tracts of land and desert country extend as far as the Great Salt Lake. The vegetation here is very scanty indeed, consisting only of small spiny bushes of Sagebrush (*Artemisia tridentata*) and two or three members of the Chenopodiaceae, a natural order characteristic of salt-plains.

Professor WEISS illustrated his remarks with a number of lantern slides, and exhibited herbarium specimens of many of the plants referred to.

---

Ordinary Meeting, January 20th, 1903.

CHARLES BAILEY, M.Sc., F.L.S., President, in the Chair.

The thanks of the members were voted to the donors of the books upon the table.

The PRESIDENT read a letter which had been received from Professor F. W. Clarke, and announced that the Council had arranged for the Wilde Lecture to be delivered on Tuesday, May 19th, 1903.

The PRESIDENT also referred to the great loss the Society had sustained through the death of Dr Edward Schunck, F.R.S., who, at the time of his death, was the oldest member of the Society, having been elected in 1842. For the long period of 61 years, therefore, Dr. Schunck had been a member of this Society, administering its affairs when in office with efficiency and with the greatest acceptance to the members, contributing to it the results of many of his famous researches, and taking, up to the last, the keenest interest in all its affairs. When he was occupying the Presidential chair eleven years ago, he was warmly congratulated by his fellow-members upon the occasion of the completion of the jubilee of his connection with the Society, and many well remember the feeling acknowledgments which he then made, when he said that his association with the Society had been one of the chief pleasures of his life. The most affectionate regard for his work and memory will be retained by those who had the honour of knowing Dr. Schunck, and they will remember him as a wise, kind, and generous friend, whose extreme urbanity, kindness of spirit, and natural modesty, were unaffected by his brilliant achievements in original research.

The PRESIDENT added that he and Mr. FRANCIS JONES (Hon. Secretary) represented the Society at the funeral of Dr. Schunck on Saturday, the 17th inst., and that he had been requested by the Council to send a letter of condolence to Mrs. Schunck.

Mr. L. G. RADCLIFFE and Dr. G. H. BAILEY also testified to the pleasure they had derived from association with Dr. Schunck in chemical investigations.

Professor W. H. PERKIN, jun., F.R.S., then read a paper entitled "**The Chemical Researches of Edward Schunck, D.Sc., Ph.D., F.R.S.**"

Mr. THOMAS THORP, F.R.A.S., read a paper entitled "**On the Production of Polished Metallic Surfaces having the Properties of Japanese 'Magic' Mirrors,**" and gave a practical demonstration of the fact that the "magic" property can be varied at will, by subjecting the mirror to pressure or to a vacuum.

---

General Meeting, February 3rd, 1903.

CHARLES BAILEY, M.Sc., F.L.S., President, in the Chair.

Mr. L. G. RADCLIFFE, F.C.S., and Professor EDMUND KNECHT, Ph.D., of the Manchester Municipal School of Technology, were elected ordinary members of the Society.

---

Ordinary Meeting, February 3rd, 1903.

CHARLES BAILEY, M.Sc., F.L.S., President, in the Chair.

The thanks of the members were voted to the donors of the books upon the table. The recent accessions to the Society's library included the following:—"*Le Opere di Galileo Galilei*," vol. 12 (4to., Firenze, 1902), presented by the Italian Government; "*Subject List of Works on Chemistry and Chemical Technology*" (8vo., London, 1901); "*Subject List of Works on certain Chemical Industries, etc.*" (8vo., London, 1901); "*Class List and Index of the Periodical Publications*" (8vo., London, 1902); "*Subject List of Works on Domestic Economy, Foods, and Beverages, etc.*" (8vo., London, 1902); "*Subject List of Works on the Textile*

*Industries and Wearing Apparel, etc.*" (8vo., London, 1902); "*Subject List of Works on General Science, Physics, Sound, Music, Light, Microscopy, and Philosophical Instruments*" (8vo., London, 1903), presented by the Patent Office, London.

Dr. GEORGE WILSON and Mr. H. E. SCHMITZ, B.A., were nominated auditors of the Society's accounts for the session 1902-1903.

The PRESIDENT referred to the loss sustained by the Society through the death of Sir George Stokes, Bart., who was elected an honorary member of the Society in 1851. The first Wilde Lecture was delivered by Sir George Stokes, and he was also the first recipient of the Wilde Medal.

PROFESSOR OSBORNE REYNOLDS, F.R.S., and Professor HORACE LAMB, F.R.S., spoke with reference to the scientific labours of Sir George Stokes. Professor LAMB pointed out that the work of the French mathematicians of the early part of the nineteenth century had been continued by Sir G. Stokes, by whose death there was thus removed a link between the French school of mathematicians and those of the present day.

PROFESSOR OSBORNE REYNOLDS, F.R.S., exhibited and explained some models illustrating his mechanical theory of the structure of the universe, propounded in his paper "On the Sub-Mechanics of the Universe," read before the Royal Society.

Mr. C. E. STROMEYER, M.Inst.C.E., read a paper on "**Parallax Determinations by Photography**," and illustrated it by a series of lantern slides.

One of the pairs of slides represented a man's face, the eyes, beard, and other parts alternately disappearing as the one plate was slid over the other. Another pair showed a landscape at Whitby, from which the distances of various objects could be measured by making them disappear; then followed a pair of stellar photographs, which were of interest as showing how easily the position of even a hazy object, such as a comet, can be determined, and measurements were also made of the path of an electric spark.



Mr. W. B. BARON, M.Sc., read a paper (communicated by Mr. Stromeyer) on "**The Influence of Hydrogen in Fuel on the Composition of the resulting Flue Gases.**" He showed that by making the gas analysis, usually undertaken in boiler trials, with little more than ordinary care, and applying various corrections thereto, the relation of hydrogen to other combustible in the fuel can be accurately found.

The method was put to a practical test at a twelve hours' boiler trial at the Salford Electricity Works on December 7th, 1902, and was found to give a result identical with that obtained in the ordinary way. By applying the result to an ultimate analysis of the coal, it was shown that it effects an important reduction of the labour involved.

---

Ordinary Meeting, February 17th, 1903.

CHARLES BAILEY, M.Sc., F.L.S., President, in the Chair.

The thanks of the members were voted to the donors of the books upon the table. Amongst the recent additions to the Society's library were the following:—"*United States Magnetic Declination Tables and Isogonic Charts for 1902*," by L. A. Bauer (4to, Washington, 1902), presented by the U.S. Coast and Geodetic Survey; "*Time and Time-Tellers*," by J. W. Benson (8vo, London, 1902), presented by Messrs. J. W. Benson, Ltd.; "*The Records of the Woolwich District*," by W. T. Vincent, 2 vols. (8vo., Woolwich, [1888-90]), presented by the author.

Mr. N. KOLP read an extract from Vol. 12 of "*Le Opere di Galileo Galilei*," consisting of Galileo's correspondence. In a letter written to Galileo in 1614, his friend Ottavio Pisani claims to have drawn the first map of the world in hemispheres, and also announces his invention of the opera glass, attributed to Galileo, in the following words:—"*..... Io ho fatto una nova sorte di mappamondi, mettendo in un cerchio tutto il globo in piano, cosa non fatta da nullo ancora. Io ho fatto uno di*

“quelli occhiali che V. S., quasi nuovo et celeste Americo, have  
 “rivolto al cielo; ho fatto, dico, uno telescopio *a due occhi*, come  
 “li altri sono ad uno: il corpo è poco, e di figura ovale.”  
 [*Translation: I have made a new kind of map of the world by  
 putting the whole globe flat in a circle, a thing which nobody  
 has done before. I have made one of those eye-glasses that  
 you—like a new and divine Americus—have directed to the  
 heavens; I mean that I have made a telescope with two eyes,  
 while the others have one: the body is small, and oval in shape.*]

Mr. THOMAS THORP, F.R.A.S., showed a copy of a Japanese  
 magic mirror he had cast. He had had it ground and polished  
 with a partial vacuum behind it, with the result that the  
 reflection showed the design on the back of the mirror very  
 distinctly. Mr. THORP believed this to be the first mirror to be  
 made in that way, and he afterwards presented the mirror to the  
 Society.

Mr. THORP also exhibited a small apparatus for attaching to  
 a gun to facilitate sighting. Two images—one normal and the  
 other inverted—of the object sighted are seen through the  
 instrument, and the gun is accurately sighted when the two  
 images are made to coincide.

Mr. W. E. HOYLE, M.A., showed on the lantern screen a  
 number of microscopic sections illustrating the structure of the  
 luminous organs of a cuttle-fish which he had described to the  
 Society during the previous session. The sections showed that  
 these organs, which are situated under the eyes, at the roots of  
 the gills, and in the siphon, are of very complex structure. In  
 the centre is a granular mass, supplied with nerves, which is  
 believed to be the source of light. Behind is a kind of mirror  
 composed of superposed scales, and in front a convex lens.

Mr. HOYLE also read a paper entitled, “**Notes on the  
 Type Specimen of *Loligo eblanæ*, Ball,**” in which was  
 demonstrated the identity of a Squid from Dublin Bay, described  
 by the late Dr. Robert Ball, with one recorded by M. Girard  
 from the coast of Portugal and also found in the Mediterranean.

Ordinary Meeting, March 3rd, 1903.

CHARLES BAILEY, M.Sc., F.L.S., President, in the chair.

The thanks of the members were voted to the donors of the books upon the table. The recent accessions to the Library included the following:—“*A Biseriate Halonial Branch of Lepidophloeus fuliginosus*,” by Prof. F. E. Weiss (4to., London, 1903), presented by the author; and “*List of Papers published in the Bulletin and Memoirs of the American Museum of Natural History, Vol. 1—16, 1881-1902*” (8vo., New York, 1902), presented by the Museum.

The PRESIDENT announced that the title of the Wilde Lecture, to be delivered by Professor F. W. Clarke on May 19th, 1903, is “The Atomic Theory.”

Dr. CHARLES H. LEES called attention to a simple apparatus, described in the current number of the *Annalen der Physik*, by means of which Messrs. Lummer and Gehrcke had been able to decompose several of the spectral lines of mercury and cadmium, supposed to be single, into groups of from 4 to 20 lines.

Mr. FRANCIS JONES, M.Sc., referred to the recent observations on the bending of marble, made by Professor See, of Washington, who believed that the phenomenon was unique and indicated that marble is in reality a fluid of enormous viscosity. Similar phenomena have, however, long been known, and many examples are to be seen among the tombstones in Edinburgh churchyards. Many of these consist of a framework of solid masonry, in the centre of which is a marble slab, about an inch in thickness, which soon loses its polish, and ultimately becomes porous and powdery, and bent or bulged according to circumstances.

Lantern slides were shown of such tombstones, particularly that erected to the memory of Professor Black, the marble portion of which, after about 80 years' exposure to the weather, fell to pieces and was renewed—but not in marble—in 1894.

Mr. WILLIAM THOMSON, F.R.S.E., read a paper entitled "**Further Investigation of the Detection and Approximate Estimation of Minute Quantities of Arsenic in Malt, Beer, and Food Stuff**," in which he pointed out that he had greatly improved the process which he had already published.

The apparatus described was exhibited, and a series of lantern slides was also shown in illustration of the paper.

---

Ordinary Meeting, March 17th, 1903.

CHARLES BAILEY, M.Sc., F.L.S., President, in the Chair.

The thanks of the members were voted to the donors of the books upon the table. The recent additions to the Library included the following:—"*Notes on Sampling and Testing*" (8vo., Manchester, 1903), presented by the Manchester Chamber of Commerce; "*Memorials of Robert Spears, 1825-99*" (8vo., London, 1903), presented by Mr. F. J. Burgoyne; and "*Instructions to Observers of the Indian Meteorological Department*," by J. Eliot, 2nd edition (8vo., Calcutta, 1902), presented by the Department.

Mr. J. COSMO MELVILL, M.A., F.L.S., exhibited two holograph letters of Linnæus, written in 1758 and 1769 respectively, the former to Mr. Richard Warner, of Woodford, the latter to Professor David van Royen, of Leyden. These letters had recently come into Mr. Melvill's possession through the medium of Mr. R. Morton Middleton, F.L.S., who had re-discovered them, they having been missing for over 80 years. A full account of the contents of the letters is given in the *Proc. Linn. Soc.*, Session 1901-1902, p. 48.

Mr. MELVILL also showed a Wedgwood plaque of Linnæus, given to him by Sir Joseph Hooker, with the information that it had been pronounced by Dr. Solander to be "a better likeness of his master than any ever painted."

Mr. MELVILL also exhibited a long holograph letter of Sir James Edward Smith, founder of the Linnean Society. This was addressed to Dr. Nathaniel Wallich, of Calcutta, and bears date March, 1820. In connection with this, Mr. Melvill mentioned that he possesses a large herbarium of New South Wales plants collected about the year 1792-3, in which all the new species described by Smith in *Rees' Cyclopædia* are present, mostly with autograph descriptions and notes. This is evidently a secondary collection to that specially selected by Sir J. E. Smith for his own herbarium, now in the possession of the Linnean Society, and was most probably used as a duplicate set of co-types by the describer, its then owner.

Mr. MELVILL read a paper entitled: "**Report on the Plants obtained by Mr. Rupert Vallentin in the Falkland Islands, 1901-2,**" and exhibited the plants mentioned. This collection contained about one-half of the species hitherto recorded as inhabiting these desolate and treeless islands, where the most conspicuous plants are the Balsam Bog (*Bolax glebaria*), Tussack Grass (*Poa caespitosa*), and, off the coast, the Giant Alga (*Macrocystis pyrifera*).

The following paper was read.—

**"On the Discovery of an Ossiferous Cavern of Pleiocene age, at Dove Holes, Buxton, Derbyshire."**  
By W. BOYD DAWKINS, M.A., D.Sc., F.R.S., *Professor of Geology in Owens College, Victoria University, Manchester.*

The carboniferous limestone, riddled with fissures and pot-holes, in the neighbourhood of Dove Holes, has from time to time, in the course of the working of the quarries, yielded remains of the extinct mammalia of the Pleistocene age. The latest discovery of a group of mammalia, of far higher antiquity than the Pleistocene, is now brought before this Society. The Victory Quarry, Bibbington, in which the discovery was made,

is excavated in a rolling plateau of carboniferous limestone, from 1,100 to 1,189 feet above the sea, and forming at this spot the water parting between the tributaries of the Goyt, flowing past Chapel-en-le-Frith westwards into the Mersey, and those flowing southwards and eastwards, past Buxton, to join the Wye and Derwent. It is a little to the north of the centre of the divide. On the western side the limestone dips at an angle of  $15^{\circ}$  underneath the Yoredale sandstones and grits, which form the lower half of a range of hills, extending southwards to Buxton and beyond, the upper half being composed of shales and sandstones of the Millstone Grit series, that rise in Black Edge to a height of 1,662 feet. The drainage of the eastern slope of these hills passes downwards until it arrives at the limestone, where it sinks into the rock, through the many swallow holes which mark the upper boundary of the limestone. There are no surface streams in the limestone in the immediate neighbourhood of the Victory quarry, which, from its position on the divide, could not, under existing geographical conditions, receive the drainage from this western range of hills.

In the course of the working of the quarry, in the beginning of 1901, a cave was discovered, and was fully exposed in the course of 1902. It was about 90 feet long, 15 feet high, and 4 feet broad. It ran nearly horizontally north and south, and consisted of a large chamber and a small passage, both eroded in a master joint traversing the limestone. On the south it contracted to a dead end, now quarried away. Its continuation to the north is obscured by a great accumulation of broken rock and clay, which has not yet been removed. It was filled with a horizontally stratified red clay, containing angular and rolled pebbles of limestone, and a few sandstone pebbles from the Millstone Grits and Yoredales. There were also pebbles of white vein quartz. Scattered through the mass were mammalian bones and teeth, some water worn, and others with sharp fractures. The contents had clearly been introduced into the cave by water, flowing under geographical conditions which no longer exist.

The mammalian remains belong to the following species :—

*Machairodus crenatidens*, Fabrini.

*Hyæna*.

*Mastodon arvernensis*, Croiset and Jobert.

*Elephas meridionalis*, Nesti.

*Rhinoceros etruscus*, Falconer.

*Equus stenorhis*, Nesti.

*Cervus etueriarum*? Croiset and Jobert.

All these species are found in the upper Pleiocene deposits of France and Italy, and undoubtedly belong to that age. The mastodon, elephant, rhinoceros, and horse occur also in Britain in the upper Pleiocene deposits of the Crag:

Some of the bones present the characteristic teeth marks of the hyænas, and the preponderance of the remains of the young over the adult mastodons, points to a selection by the hyænas, who could easily master the calves, while they did not as a rule attack the large and formidable adults. The author has observed a similar selection in the case of mammoths in hyæna dens, into which the remains had been brought by those cave-haunting animals. The author therefore concludes that the animal remains have been washed out of a hyæna-den, which then existed at a higher level, and carried down deep into the rock, into the cave in which they were found, along with the clay and pebbles brought down in flood time from the Yoredale and Millstone Grit hills. The area of the Victory quarry must then have been at the bottom of a valley instead of in its present position on the divide. The denudation of the limestone which has taken place since that time is estimated as not less than 330 feet, an amount sufficient to destroy the ravine formed by the streams above the bone cave, and all the caves and rock shelters in the district which were accessible to the upper Pleiocene mammalia.

The physical geography of the British Isles in the Upper Pleiocene age was as follows: The British area was joined to the continent by a barrier of land, extending from the Straits of

Dover, westward, as far as the 100-fathom line in the Atlantic, which sweeps southwards from Scandinavia, off the west of Ireland, into the Bay of Biscay. There were no physical barriers to forbid the migration of the *Machairodus*, *Mastodon*, *Elephas meridionalis*, and the rest, from central and southern France into Britain. They could find their way freely from the valleys of the Loire and Garonne, across the valley now occupied by the English Channel, into England and, it may be added, Ireland. Over this area the animals migrated in the Upper Pleiocene age. The discovery of a few of them in Derbyshire is to be looked upon as an indication of their former existence over the whole of this area. It is also a striking example of the great destruction of the surface which has taken place since that time, and of the imperfection of the geological record. This is the only cave in Europe which has yielded remains of the remote Pleiocene age.

The mammalian remains referred to in the paper were exhibited to the meeting.

---



Ordinary Meeting, March 31st, 1903.

CHARLES BAILEY, M.Sc., F.L.S., President, in the Chair.

The thanks of the members were voted to the donors of the books upon the table. Amongst the recent additions to the Society's library were the following:—“*List and Catalogue of the Publications issued by the U.S. Coast and Geodetic Survey, 1816-1902*” (4to., Washington, 1902), presented by the Survey; “*The Sub-mechanics of the Universe,*” by Professor O. Reynolds (8vo., Cambridge, 1903), presented by the Royal Society; and “*Ueber das farbige Licht der Doppelsterne,*” von C. Doppler (8vo., Prag, 1903), presented by the K. Böhmisches Gesellschaft der Wissenschaften.

The members present were asked to consider the proposals of the Council with regard to the election of Officers and members of Council, as stated in a circular which had been sent to each member, and of which the following is a copy:—

*March, 1903.*

In response to the desire expressed by the members of the Society at the last Annual Meeting, that some better method of electing the Officers and Council of the Society than that at present in use should be devised, the Council decided to adopt the following procedure:—

1. The existing Council to issue to the members of the Society, two weeks before the Annual Meeting, a list of suggested Officers and Council for the ensuing year.
2. The list to include at least two names not on the list of existing Officers and Council.
3. The list to be printed in a convenient form for use as a balloting list, and the Members to be informed on it that they may, if they desire, substitute other names for those suggested by the Council.

The members having signified their approval of these proposals, the PRESIDENT announced that this procedure would be followed in connection with the forthcoming election of the Council.

Mr. FRANCIS NICHOLSON, F.Z.S., stated that the recent stormy weather did not appear to have delayed the arrival of our migratory birds, some of which had, indeed, been noticed at an earlier date than usual. The Wheatear was first noticed at Southport on March 22nd, and the Redshank had been reported from a few breeding stations in Lancashire and Westmorland as early as March 15th. Nests and eggs of the Lapwing had been found on March 29th.

Mr. R. L. TAYLOR, F.C.S., read a paper entitled "**I. On a Higher Oxide of Cobalt. II. A Method for the Volumetric Determination of Cobalt.**"

Mr. W. E. HOYLE, M.A., communicated a paper by Mr. THEOPHILUS G. PINCHES, LL.D., M.R.A.S., on "**Hymns to Tammuz, inscribed on a Tablet in the Manchester Museum, Owens College.**"

These interesting compositions are inscribed in six columns on a Babylonian tablet of seemingly unbaked clay, which unfortunately is by no means perfect. The style of the writing is archaic Babylonian, closely resembling that in use at the time of the dynasty of Babylon to which the renowned king Hammurabi belonged. This establishes the date of the text as about 2,000 B.C. Tammuz was the husband of Istar, whose name occurs in the text under its Sumerian form, Innanna. Istar calls to Tammuz, the shepherd, the god of the summer sun, to return to the place of pasture, the domain of delight where he abides with her. Here the summons of Persephone (Allat, Eres-e-gala) in the underworld seems to penetrate, and is heard by Istar with sorrow and misgiving. Apparently some evil voice calls Tammuz away from Istar, and the goddess journeys to the underworld, "in night walking, in gloom walking." Then, it seems, Tammuz comes forth from the

underworld, amid songs of joy, which change to tones of apprehension as the thought occurs that the god must return to the land of shades before the year has run its course. Then comes a short section in praise of Tammuz, followed by a prayer for increase. A comparison shows that there is a great likeness between the texts referring to Tammuz hitherto known, and the interesting series of hymns preserved in the Manchester Museum.

The paper will be published in the next volume of the *Memoirs*.

---

Ordinary Meeting, April 21st, 1903.

CHARLES BAILEY, M.Sc., F.L.S., President, in the Chair.

The thanks of the members were voted to the donors of the books upon the table. The recent accessions to the Society's library included the following :—“*Tsimshian Texts*,” by F. Boas, (4to., Washington, 1902), presented by the Bureau of American Ethnology ; “*Definitive Resultate aus den Prager Polhöhen-Messungen von 1889 bis 1892 und von 1895 bis 1899*,” von L. Weinek (4to., Prag, 1903), presented by the K. K. Sternwarte zu Prag ; and “*Papers on Mechanical and Physical Subjects*.” 3 vols., by Professor O. Reynolds (8vo, Cambridge, 1900-03), presented by the author.

The PRESIDENT reported that the Society was about to lose the services of Mr. Charles Leigh, who had acted as the Society's Assistant Secretary and Librarian, and who had been appointed Deputy Librarian of the Owens College. Throughout the seven or eight years during which he had held office with the Society, Mr. Leigh had shewn conspicuous devotion to its interests, unfailing urbanity to all its members, considerable industry and skill in librarian's and secretarial work, a capital knowledge of accounts, and good business methods, all of which had relieved the acting officers of much detailed work. The PRESIDENT congratulated Mr. Leigh upon his appointment at the Owens College, and wished him a long, pleasant, and useful career in his new office.

These remarks were endorsed by Mr. J. J. ASHWORTH, Mr. W. E. HOYLE, and Mr. FRANCIS JONES.

The PRESIDENT further reported that Mr. A. P. Hunt, B.A., the Sub-Librarian of Balliol College, Oxford, had been appointed by the Council Assistant Secretary and Librarian of the Society.

MR. FRANCIS NICHOLSON, F.Z.S., exhibited, and presented to the Society, framed engraved portraits of Dr. Edward Holme and Mr. John Kennedy. The engraving of Dr. Holme is from the original portrait in oils by William Scott, in the possession of the Society. That of Mr. Kennedy is taken from a portrait by C. A. Duval, the artist, who was a member of this Society, and it is a very good likeness. Mr. NICHOLSON mentioned that John Kennedy, of Ardwick, who was elected a member of this Society in 1803, and continued so to his death in 1855, was nearly the first in this district to establish cotton-spinning mills driven by steam power. He was considered a good mechanic, making several improvements in the mule, and was the first to invent the differential motion in the jack-frame. He was a friend of Watt, of Dalton, and of Henry, as well as of other eminent men.

Mr. NICHOLSON, in continuation of his remarks at the previous meeting of the Society, stated that our summer migrants continue to arrive near Southport fully as early as in former years, notwithstanding the recent cold season. On Saturday last, April 18th, the common Sandpiper or Summer Snipe (*Totanus hypoleucus*) and the Yellow Wagtail (*Motacilla raii*) were seen, and in Westmorland the common Curlew (*Numenius arquata*) and the Golden Plover (*Charadrius plumbealis*) were at their breeding stations by the first week in this month. The dates of the arrival of the above, and the species alluded to at the last meeting, as has been previously stated, are all early, and prove how little the habits of birds are really affected by the state of the weather.

Mr. W. BARNARD FARADAY, LL.B., exhibited some perforated stones found near Kirkby Lonsdale, and remarked

upon the association of such stones with the folk-lore of the district.

Mr. SPENCER H. BICKHAM, F.L.S., exhibited over a hundred specimens of Caoutchouc, obtained from all the known sources of supply, and gave an interesting description of the methods of collection and preparation employed in the different countries where this product is obtained. He remarked upon the geographical distribution of the trees from which caoutchouc is extracted, and stated that, whilst it is obtained from various trees belonging to different natural orders of plants, the trees of different orders are never found growing together. Thus, the rubber-bearing plants of the order Euphorbiaceæ are found in the Brazils, those of the order Apocynaceæ in Central America, and so on.

---

ANNUAL GENERAL MEETING, APRIL 28TH, 1903.

CHARLES BAILEY, M.Sc., F.L.S., President, in the Chair.

Professor F. W. CLARKE, of the United States Geological Survey, was elected an honorary member of the Society.

Mr. H. SIDEBOTTOM, Cheadle Hulme, and Mr. CHARLES W. SUTTON, M.A., Chief Librarian of the Manchester Public Free Libraries, were elected ordinary members of the Society.

The SECRETARY announced, in accordance with Rule 22 of the Articles of Association, that the names of J. Grossmann and A. Shearer had been erased by the Council from the register in consequence of the non-payment of their subscriptions.

Professor F. E. WEISS gave notice that he would move the following resolution, at a general meeting previous to the next Annual General Meeting: "That the Officers and Council for the next session be balloted for *en bloc*."

Mr. W. E. HOYLE also gave notice that, in the event of Prof. Weiss' motion being carried, he would move at the same time

and place: "That two scrutineers be appointed by the meeting, and that they examine the balloting papers whilst the ordinary business is being carried on, and report the result when ascertained."

The Annual Report of the Council and the Statement of Accounts were presented, and it was moved by Dr. D. B. HEWITT, seconded by Dr. GEORGE WILSON, and resolved:—"That the Annual Report, together with the Statement of Accounts, be adopted, and that they be printed in the Society's *Proceedings*."

The following members were elected officers of the Society and members of the Council for the ensuing year:—

*President*: W. BOYD DAWKINS, M.A., D.Sc., F.R.S.

*Vice-Presidents*: SIR WILLIAM H. BAILEY; H. B. DIXON, M.A., F.R.S.; J. COSMO MELVILL, M.A., F.L.S.; CHARLES BAILEY, M.Sc., F.L.S.

*Secretaries*: FRANCIS JONES, M.Sc., F.R.S.E., F.C.S.; CHARLES H. LEES, D.Sc.

*Treasurer*: ARTHUR McDUGALL, B.Sc.

*Librarian*: W. E. HOYLE, M.A., M.Sc., F.R.S.E.

*Other Members of Council*: HORACE LAMB, M.A., LL.D., F.R.S.; FRANCIS NICHOLSON, F.Z.S.; R. L. TAYLOR, F.C.S., F.I.C.; F. E. WEISS, D.Sc., F.L.S.; C. E. STROMEYER, M.Inst.C.E.; FRANK SOUTHERN, B.Sc.

---

Ordinary Meeting, April 28th, 1903.

CHARLES BAILEY, M.Sc., F.L.S., President, in the Chair.

The thanks of the members were voted to the donors of the books upon the table.

Professor F. E. WEISS, D.Sc., made some remarks on the pollination of the primrose, and exhibited some insects which he had caught on primroses in the Church Stretton district. These included specimens of *Bombus terrester*, *Anthophora furcata*,





NEST OF THE COMMON BUZZARD.



*Andrena grynana*, and *Bombilius major*, the last two being the most frequent visitors of the primrose flowers.

Dr. GEORGE WILSON read a paper entitled "A Factor in the Safety of High-speed Torpedo Boat Destroyers," written by himself in conjunction with Mr. A. T. WESTON.

The following paper was also read.—

### Notes on the Breeding Habits and Distribution of the Common Buzzard (*Buleo vulgaris*) in the Northern Counties of England.

By R. W. ELLISON.

(With a Plate.)

The Common Buzzard is still a resident in the Lake Districts of Cumberland and Westmorland, where I have had frequent opportunity of observing the birds, and examining several of their nests. For some time it was supposed that this species had ceased to breed in England, owing to its having been subjected to the increasing persecution of gamekeepers, and to the removal of large tracts of forest. Driven from their home in the woods, the birds have now taken up their abode in remote and mountainous parts of the country, where they find a safe retreat amongst the crags.

The nest is usually constructed on a ledge of rock, and placed in such a position as to afford the sitting bird an uninterrupted view of a long valley. The birds are not always observed in their breeding haunts, as they are very apprehensive of danger, and on the approach of any intruder will silently leave their nest and disappear over the mountain top into the valley beyond. Should they become aware, however, that their nest has been discovered, they immediately appear on the scene and shew much anxiety, and, crying loudly, will occasionally feign to attack by swooping at the head of the intruder.

Early in May, 1900, I observed a nest in a tree, and, from the character of the nest and the size of the eggs, concluded they were the production of a pair of young birds, who had

adopted the plan of their ancestors in the choice of a site for their first home.

The eggs of the buzzard found in this locality are as a rule somewhat larger than the average size for eggs of this species, and many specimens are somewhat defective in coloration; several eggs in my possession are almost spotless. The birds appear to be large and strong, and under the protection now extended to them may continue to survive for some years, although I fear the buzzard can only be considered a declining species in this country.

---

Special Meeting, May 19th, 1903.

W. BOYD DAWKINS, M.A., D.Sc., F.R.S., President, in the Chair.

A special interest attached to this meeting, which was held to celebrate the centenary of the announcement of the Atomic Theory by John Dalton.

The Society was honoured by the presence of several distinguished men, including the Lord Mayor of Manchester (Councillor J. Royle), Sir Henry E. Roscoe and Dr. T. E. Thorpe, C.B. (representing the Royal and Chemical Societies), Professor W. H. Tilden, Professor P. F. Frankland, and Dr. A. Scott (representing the Chemical Society), Professor H. E. Armstrong, Mr. H. Brereton Baker, Dr. A. G. Vernon Harcourt, Dr. Arthur Harden, Professor J. H. van't Hoff, Sir James Hoy, Professor F. S. Kipping, Dr. W. H. Perkin, Sir William Ramsay, K.C.B., Professor J. Emerson Reynolds, and Professor A. Smithells.

The proceedings began by the reading of messages and addresses from scientific societies. The first of these was a telegram from the Russian Physico-Chemical Society, which ran:—

“The notion of atoms having united through chemistry the whole philosophy of nature has immortalised the name of John

“Dalton in science. Highly reverencing his memory, the Russian Physico-Chemical Society begs you to accept their congratulations on the day of the Manchester celebration in honour of the founder of modern atomism. Glory to Dalton!”  
*Presidents*, MENDELÉEFF, PETRUSHEFSKY, BEKETOFF, EGOROFF;  
*Secretaries*, TISHTCHENKO, MITKEVITCH.

Congratulations were next offered by Professor VAN'T HOFF, who, speaking on behalf of the chemists of Germany, said that they felt “deep admiration and thankfulness for the work of your great citizen.”

Professor T. E. THORPE, C.B., then presented the following address on behalf of the Royal Society of London :—

“The ROYAL SOCIETY OF LONDON for the promotion of Natural Knowledge sends fraternal greetings to the LITERARY AND PHILOSOPHICAL SOCIETY OF MANCHESTER on the occasion of the DALTON celebration.”

“The general conception that matter is constituted of atoms has come down from antiquity; and it formed an almost necessary part of the Philosophy of Descartes, Newton, and the other great modern Physicists. But it was reserved for JOHN DALTON to establish a more definite notion of specific atoms for the various elementary substances, to show how to explore through the different masses of these atoms the way they comport themselves in chemical transmutations, and to connect the properties of compound bodies with their atomic constitutions. In constructing these ideas, first announced to the world just a hundred years ago, and taking the earliest steps in their experimental development, DALTON laid the foundation on which the vast fabric of modern Chemistry has since been built. After the lapse of a century we can still enjoy the freshness and vigour and compactness of his thought, and the definiteness of the issues which he was constantly evolving for the experimental interrogation of Nature. We can follow with interest the calm appreciation of the scenery of landscape and cloud and sky that pervades his Meteorological

“Essays ; while we admire the instinct that guided his views of  
“the interactions of mixed gases and vapours, and the tenacity  
“of his faith notwithstanding the disturbances which masked his  
“efforts towards direct experimental confirmation. Thus the  
“theoretical illumination which the genius of Clerk Maxwell has  
“thrown on the nature of his law of the mutual independence of  
“mixed gaseous media has not detracted from the credit of its  
“first upholder. Nor has the want of the refined instrumental  
“equipment that is necessary for the adequate development of  
“the other fundamental principles which he affirmed ever  
“diminished the admiration of his contemporaries and his  
“successors for the achievements of his intellect.

“The ROYAL SOCIETY congratulates the LITERARY AND  
“PHILOSOPHICAL SOCIETY OF MANCHESTER on having known  
“how to embrace the privilege of providing a home for the  
“scientific activity of their illustrious Member, who was after-  
“wards for a long period their honoured President, and on  
“having been the channel for the publication to the world of  
“scientific advances that will maintain their importance through-  
“out the ages to come, at a time when their author was to  
“cutward appearance only an inconspicuous private citizen in  
“their community.”

Signed and sealed on behalf of the ROYAL SOCIETY OF  
LONDON,

WILLIAM HUGGINS,  
President.

Professor W. A. TILDEN, F.R.S., next read an address from  
the Chemical Society, which was as follows :—

“The CHEMICAL SOCIETY to the LITERARY AND PHILO-  
“SOPHICAL SOCIETY OF MANCHESTER, greeting :

“Recognising the Atomic Theory as having been the founda-  
“tion of scientific chemistry the Chemical Society desires to be  
“associated with the Literary and Philosophical Society of  
“Manchester in celebrating the Centenary of its Enunciation  
“by JOHN DALTON.

“The Century which has elapsed since the recognition of  
 “the great generalisations which led to the establishment of the  
 “Theory has afforded continuous proof of its importance through-  
 “out the whole domain of Physical Science, and especially of  
 “Chemistry, every new development of which has served to  
 “consolidate its position. The Chemical Society offers at the  
 “same time to the Literary and Philosophical Society, so much  
 “older than itself, an expression of hearty congratulations on  
 “having been the medium of the first publication of that Theory  
 “to the world, and having for upwards of a Century so honour-  
 “ably assisted in promoting Scientific, Literary, and Philosophical  
 “enquiry, more especially in those early days before the time of  
 “Dalton when the Physical Sciences were still unorganised and  
 “waiting for the firm and philosophical basis on which they  
 “now rest.

“Signed on behalf of the CHEMICAL SOCIETY,

“WILLIAM H. TILDEN, *President.*

“HORACE T. BROWN, *Treasurer.*

“ALEXANDER SCOTT, } *Secretaries.*

“W. PALMER WYNNE, }

“WILLIAM RAMSAY, *Foreign Secretary.*

“May 7th, 1903.”

The PRESIDENT, in presenting the Wilde Medal for 1903 to Professor F. W. Clarke, and a Dalton Medal (struck in 1864) to Professor Osborne Reynolds, F.R.S., said:—

“Prof. Clarke, to whom the Wilde Medal is awarded, has  
 “done distinguished work in a very wide field, ranging from  
 “Chemistry and Chemical Physics to the application of Chemistry  
 “to the purposes of the Geological Survey of the United States,  
 “in which he has held a distinguished position for the last twenty-  
 “five years. His paper ‘On the Determination of the Melting  
 “Points, Boiling Points, and Specific Gravities of Bodies,’  
 “published in 1873, indicated the direction of his researches  
 “which led to his work on ‘The Constants of Nature—a  
 “Re-calculation of Atomic Weights,’ published by the Smith-

“sonian Institution in 1882. It is for this masterpiece that, in  
“this home of John Dalton, the Wilde Medal has been awarded  
“to Professor Clarke by the Manchester Literary and Philo-  
“sophical Society, on the appropriate occasion of the Centenary  
“of the Announcement of the Atomic Theory by John Dalton  
“before this Society.”

“In dealing with the life-work of Professor Reynolds, the  
“sympathetic biographer of Joule, it is difficult to know where  
“to begin and where to end. I can but select a few of his  
“additions to knowledge which stand out from the rest.

“The first ten of his papers were communicated to this  
“Society, beginning with that ‘On the Suspension of a Ball by  
“a Jet of Water,’ in 1870. The paper ‘On the Destruction of  
“Sound by Fog,’ in 1873, was the first of a series dealing with  
“the Propagation of Sound in the atmosphere, and constituting  
“the standard authority in this field of experiment.

“His hydrodynamic work may be said to have begun in 1873,  
“when he published his ‘Experimental and Theoretical Inves-  
“tigation on the Causes of the Racing of Screw Steamers,’  
“read before the Institute of Naval Architects.

“In 1875, his paper ‘On Friction and Lubrication,’ read  
“before the Royal Society, was the beginning of a third series  
“leading up to that ‘On the Theory of Lubrication,’ which  
“shed light on a subject up to that time involved in obscurity.

“Nor must the fact be omitted that he designed an engine  
“for experimental purposes in 1889. With this he has determined  
“the Mechanical Equivalent of Heat, standing in this respect in  
“the same relation to Joule as Professor Clarke stands to Dalton.

“In 1879 Professor Reynolds made a fresh departure in his  
“paper ‘On the Dimensional Properties of Matter in the  
“Gaseous State.’ This was followed by ‘The Discovery of the  
“Criterion distinguishing the Continuous from the Discontinuous  
“Motion of a Fluid,’ and later by a third paper ‘On the  
“Dilatancy of Granular Media.’ These led to his last great  
“work, recently published by the Royal Society, ‘On the Sub-  
“Mechanics of the Universe.’ We have not yet had time to

“gauge the real value of this. It must be left to the judgment of posterity.

“On these grounds the Literary and Philosophical Society has awarded a Dalton Medal to Professor Reynolds—a singularly fitting award, since the life-work of Dalton overlapped that of Joule, and the lamp passed from the hands of Joule to those of Professor Reynolds.”

The presentations were briefly acknowledged by Professor Clarke and Professor Reynolds.

Professor CLARKE then delivered the Wilde Lecture on “**The Atomic Theory.**”

The Lecture is printed in full in the *Memoirs*.

Sir HENRY ROSCOE, in proposing a vote of thanks to Professor Clarke, reminded the meeting that this year was the diamond jubilee of a discovery by another great Manchester chemist, Joule—namely, the discovery of the mechanical equivalent of heat.

Professor H. B. DIXON seconded the resolution, which was unanimously agreed to.

Professor F. W. Clarke, Professor Osborne Reynolds and the guests of the Society were afterwards entertained at dinner by the members.

---

### Annual Report of the Council, April, 1903.

The Society began the session with an ordinary membership of 159. During the present session 16 new members have joined the Society; 12 resignations have been received, and the deaths have been 4, *viz.*: Mr. F. BADEN BENDER, F.C.S., Mr. R. E. CUNLIFFE, Mr. JOHN ROBINSON, and Dr. EDWARD SCHUNCK, F.R.S., whilst 2 members have been removed from the list for non-payment of their subscriptions. This leaves on the roll 157 ordinary members. The Society has also lost 1 honorary member by death, *viz.*: Professor Sir GEORGE GABRIEL STOKES, Bart., F.R.S., of Cambridge. Memorial notices of these gentlemen appear at the end of this report.

The Treasurer reports a decided improvement in the finances, due to the general efforts made during the last two years to increase the membership; but the unusual number of resignations received during the current session, and the needs of the Society still call for sustained exertion in the same direction.

The Society commenced the session with a total balance of £164. 15s. od., from all sources, this amount being made up of the following balances:—

At the credit of General Fund .....	£52	17	2
„ „ Wilde Endowment Fund ...	92	11	0
„ „ Joule Memorial Fund .....	41	11	4
„ „ Dalton Tomb Fund .....	31	19	2
		<hr/>	
	£218	18	8
Less the amount standing at the debit of			
the Natural History Fund .....	54	3	8
		<hr/>	
	£164	15	0
		<hr/>	



The total balance at the close of the session amounted to £304. 14s. 2d., and the amounts standing at the debit and credit of the separate accounts, on the 31st March, 1903, are the following :—

At the credit of General Fund ... ..	£143	0	5
„ „ Wilde Endowment Fund...	127	17	1
„ „ Joule Memorial Fund .....	49	5	10
„ „ Dalton Tomb Fund .....	32	14	8
			<hr/>
			£352 18 0
Less the amount standing at the debit of			
the Natural History Fund .....	48	3	10
			<hr/>
Cash in hand 31st March, 1903 .....	£304	14	2
			<hr/> <hr/>

In the ordinary receipts of the Society this session, two special items appear, one of which is a compounding fee. The needs of the Society for many years have not admitted of these fees being kept in a separate account. The number of living compounding members now stands at 6. The other item is one for £11. 5s. 9d., being the balance received from the Treasurer of the dissolved Microscopical and Natural History Section; out of this amount the Society paid £6. 6s. 6d. for natural history publications, which were subscribed for by the Section prior to its dissolution.

The Wilde Endowment Fund, which is kept as a separate banking account, shows a balance of £127. 17s. 1d., in its favour, as against £92. 11s. 0d. at the beginning of the financial year. The receipts from the invested funds are slightly less than last year, but your Council sees no reason to make any change in its investments. Owing to the Wilde Lecture this session being fixed for a date beyond that for the closing of this year's account, no items representing the honorarium and the Wilde Medal appear, and the balance left is improved to that extent over the balance at the beginning of the session.

The Natural History Fund has still a debit balance, owing to the transfer of £100 towards the cost of new bookcases, as referred to in the report of the Council for the session 1895—1896; this debit balance has been reduced from £54. 3s. 8d. last year to its present amount of £48. 3s. 10d.

No expenditure has been incurred in respect to the Joule Memorial Fund and the Dalton Tomb Fund, the balances of which remain at the amounts stated above. The Dalton Tomb Fund stands as a separate account at the Manchester and Salford Savings Bank.

The Librarian reports that during the session 736 volumes have been stamped, catalogued and pressmarked, 667 of these being serials, and 69 separate works. There have been written 329 catalogue cards, 248 for serials, and 81 for separate works. The total number of volumes catalogued to date is 26,929 for which 8,923 cards have been written.

Satisfactory use is made of the library for reference purposes, but the number of volumes consulted is not recorded. During the session, 163 volumes have been borrowed from the library, as compared with 152 volumes in the previous session.

Some attention has continued to be paid to the completion of sets, 18 volumes or parts having been obtained which render 5 sets complete, whilst 3 volumes have been acquired which partly complete one set. Most of these volumes were presented by the respective societies publishing them. Since the commencement of the re-cataloguing of the library, a total of 823 missing volumes has been obtained, resulting in the completion of 103 sets.

Comparatively little binding has been done this session, 255 volumes having been bound in 214.

A record of the accessions to the library shows that, from April, 1902, to March, 1903, 724 serials and 47 separate works were received, a total of 771 volumes. The donations during the session (exclusive of the usual exchanges) amount to 42 volumes

and 23 dissertations ; 5 books have been purchased (in addition to the periodicals on the regular subscription list).

During the past session the Society has arranged to exchange publications with the following :—University of Colorado ; Physikalisch-medicinische Gesellschaft zu Erlangen ; Museo Civico di Storia Naturale, Genoa ; Ševcenko-Gesellschaft der Wissenschaften, Lemberg ; Université de Lille ; National Physical Laboratory, Teddington ; United States National Museum, Washington.

The author-index of the papers, communications, and exhibits brought before the Society from its foundation until 1901, as recorded in the *Memoirs* and *Proceedings*, is now completed, and is available for reference.

The publication of the *Memoirs and Proceedings* has been continued under the supervision of the Editorial Committee.

The Council has received with great regret the resignation of Mr. Charles Leigh, Assistant Secretary and Librarian to the Society, who has been appointed Deputy Librarian of the Owens College, Manchester. The Council has appointed, as his successor, Mr. A. P. Hunt, B.A., Sub-Librarian of Balliol College, Oxford.

The Society is indebted to the following gentlemen for the undermentioned gifts :—

Mr. F. Nicholson, F.Z.S., for a framed engraved portrait of Peter Clare, a former Secretary of the Society ;

Mr. A. W. Waters, F.G.S., for a copy of Beer and Mädler's "Mappa Selenographica ;"

The late Mr. John Mullin, for his binocular microscope, and a series of microscopic slides ;

Mr. Fred H. Smith, for Pearson's "The Hepaticæ of the British Isles," 2 vols. (1902) ; and

Mr. Thomas Thorp, F.R.A.S., for a casting of a Japanese "magic" mirror.

The Royal Philosophical Society of Glasgow celebrated the Centenary of its foundation on November 12th, 1902, and this Society was represented by Professor A. Schuster, F.R.S.

The Council has awarded:—

The Wilde Medal for 1903 to Professor F. W. Clarke, of the United States Geological Survey, for his distinguished services to Chemical Science, and especially for the masterly judgment he has shown in his critical discussion of the atomic weight determinations of all the elements.

A Dalton Medal (struck in 1864) to Professor Osborne Reynolds, F.R.S., for his writings and researches on hydrodynamics, on the dimensional properties of matter, on the theory of lubrication, and on the mechanical equivalent of heat.

Professor F. W. Clarke has been appointed to deliver the Wilde Lecture.

The Council has arranged for the medals to be presented and the Wilde Lecture to be delivered on Tuesday, May 19th, 1903.

---

GEORGE GABRIEL STOKES was the son of the Rev. Gabriel Stokes, rector of Skreen, Ireland. He was born in 1819, and was educated at Bristol and at Pembroke College, Cambridge, where he graduated as Senior Wrangler in 1841. He was elected to a Fellowship in the same year, and entered at once on a series of investigations in mathematical physics which have long ranked as classics, and which are marked from the first by a rare combination of analytical power and physical insight, set forth with almost unflinching accuracy. He was elected to the Lucasian Chair of Mathematics in 1849, and held this post till his death, lecturing almost to the end on his favourite subjects of Hydrodynamics and Optics with undiminished vigour and enthusiasm. His period of greatest productiveness lay in the ten or fifteen years following his degree; in 1854 he accepted the Secretaryship of the Royal Society, and for the next 40 years he spared neither time nor labour in discharging the duties of that office, reading

the papers which fell within his province with the most scrupulous care, and continually assisting the authors with kindly criticism and suggestions. In 1885 he was called to the Presidential Chair, which he occupied till 1892. The most memorable occasion of his later life was the celebration of his professorial Jubilee at Cambridge in 1899, when a distinguished company of representatives of Universities and learned societies came together from all parts of the world to do honour to the veteran whose simplicity and modesty of character were in keeping with the solidity and dignity of his scientific achievements.

By our own Society Sir GEORGE STOKES had long been held in the highest regard. He had been numbered amongst our honorary members since 1851; and on the institution of the Wilde Medal and Wilde Lectureship in 1897 it was felt that the series of medallists and lecturers could not be more brilliantly inaugurated than in his person. The lecture which he gave us on the theory of the Röntgen rays (*Manch. Mem.*, vol. 41) will long be remembered for the almost boyish vivacity and delight which he showed in the subject, and which charmed even those who were unable to appreciate the acute suggestions which it contained.

STOKES was happy in retaining his intellectual powers and interests unimpaired to the last. He died after a brief illness on February 1, 1903. His funeral on February 5 was the occasion of a remarkable demonstration of regret and affection on the part of scientific and personal friends hastily gathered together from all parts of the country.

Some account of his scientific labours was given in the formal award of the Wilde Medal (*Manch. Mem.*, vol. 41, p. xxxviii). A detailed appreciation by his life-long friend and admirer, Lord Kelvin, appeared in *Nature*, February 12, 1903. H L.

FREDERICK BADEN BENDER, who died at his residence, The Grange, Knutsford, on January 28th, 1903, aged 63 years was elected a member of this Society on December 10th, 1901. He was formerly in partnership with Mr. Standen Paine, and

latterly was a director of Messrs. Benger and Company Ltd. He was a life member of the Pharmaceutical Society, and served on the Board of Examiners of that Society from 1874 to 1886.

MR. ROBERT ELLIS CUNLIFFE, whose death we have to record with regret, on 25th November last, at Ambleside, of typhoid fever, was the only son of the late Mr. Thomas Potter Cunliffe, solicitor. He was for many years partner in the well-known firm of Cunliffes, Leaf & Co., afterwards Cunliffes & Greg, of 56, Brown Street, Manchester, retiring about four years since, when he purchased the beautiful estate known as the Croft, at the head of Windermere, residing there continuously ever since. In April, 1876, he became a member of the Literary and Philosophical Society, and was for several years an active member of the Microscopical and Natural History Section, acting as Secretary from 1881-84, the first year (1881-2) jointly with the writer of this notice. The scientific work he essayed was mainly microscopical, and he frequently exhibited objects of great interest, though he rarely contributed any papers to the Society.

Of a cultivated, artistic temperament, he became an ardent admirer of Ruskin, and actively furthered the interests of the Museum at Coniston, possessing also many original drawings and exquisite water-colours painted by him, which he ranked amongst his highest treasures. His premature death at the age of 54 is sincerely lamented by his many friends. J. C. M.

JOHN ROBINSON was the son of a banker at Skipton, where he was born in March, 1823. He was educated at the Skipton Grammar School, and was afterwards sent to a School in Manchester conducted by Charles Cumber, an intimate friend of Dalton. Later he studied at the Wakefield Proprietary School, and at the age of sixteen entered the firm of Sharp, Roberts and Company, of Manchester, as an apprentice. On the dissolution of this partnership in 1843, he joined the firm of Sharp, Brothers and Company—afterwards Sharp, Stewart and Company,—of which he ultimately became Chairman of the Board of Directors.

Although he will be chiefly remembered as an eminent mechanical engineer, he had devoted much attention to the cultivation of forest trees, and was also interested in matters relating to local government and education. He was a Trustee of the Owens College, Manchester, and had held the positions successively of County Magistrate, Deputy Lieutenant, and High Sheriff of Staffordshire. He had been a member of this Society since December, 1864, and in 1872 he was elected a member of the Institution of Civil Engineers. In 1859 he became a member of the Institution of Mechanical Engineers, of which he occupied the Presidential chair in 1878 and 1879. His death occurred at his residence, Westwood Hall, Leek, on July 9th, 1902.

[A fuller notice appears in *Engineering*, July 18th, 1902, and in *Min. of Proc. Inst. Civ. Engin.*, Vol. CL., pp. 447-451.]

HENRY EDWARD SCHUNCK, though of German extraction, was born in Manchester in 1820, and throughout the whole of his long life his connection with the city was most intimate. His career is not marked by any thrilling incidents, but is a continuous record of earnest and successful work, mainly devoted to one particular branch. Sent abroad, while still a youth, to study chemistry at Berlin, and subsequently at Giessen, under Liebig, he became deeply interested in vegetable colouring matters, being attracted thereto because this was then an unknown field. The enormous production of artificial colouring matters since the aniline industry came into being almost hides the fact that dyeing is one of the oldest arts, a large number of materials having been used for this purpose since very early times; for example, Brazil wood, logwood, sandal wood, litmus, woad, archil, buckthorn, sumach, cochineal, nitric acid (for silks), quercitron, catechu, and Prussian blue, not to mention madder and indigo. Schunck, of course, did not attempt to explore the whole of this territory, but, beginning with the colouring principles of archil and cudbear, on which he read an important paper before the Chemical Society in 1842, he subsequently turned his attention

to madder and indigo, and with such success that all the work which has since been done in this connection finds its origin in his investigations. A full account of Dr. Schunck's chemical researches, by Professor W. H. Perkin, having already appeared in the *Manchester Memoirs*, (Vol. xlvii., No. 6), it will not be necessary in this place to pursue the topic any further. His researches were carried on in a private laboratory, erected near his house—Oaklands, Kersal—which was one of the most complete of its kind in existence. Under the terms of his will it has now passed into the possession of Owens College, whither it will shortly be transferred.

Dr. Schunck was elected an ordinary member of the Society on January 25th, 1842, along with Joule, Playfair, Binney, Dancer, and others whose names are now but a memory. In 1855 he took office as Secretary, a position which he retained till 1860, and thenceforward was seldom out of harness. He was four times President (1866-7, 1874-5, 1890-1, and 1896-7) and Vice-President in the intervening years. His great interest in the welfare of the Society was shewn in various ways; thus, besides contributing a large number of papers to the *Manchester Memoirs*, his minor communications were of considerable interest, and he attached great value to the open discussions which have always been a feature of the Society's meetings. To him, also, the Society is indebted for a bronze bust of Dr. Angus Smith, for portraits of the Rev. William Gaskell and the Rev. William Johns, and for a mural tablet commemorating the fact that Dalton used one of the rooms in the Society's house as a laboratory. It was fitting, therefore, that he should be awarded the Society's Dalton medal, the presentation of which, in 1898, afforded him the liveliest satisfaction. His name was known and honoured in other than local circles; thus he was elected a Fellow of the Royal Society in 1850, and many of his papers are enshrined in the *Philosophical Transactions*, the *Philosophical Magazine*, the *Chemical Society's Journal*, *Liebig's Annalen*, and other publications at home and abroad. He was awarded the Davy Medal by the Royal Society in 1899, and in the same year



the degree of D.Sc. was conferred on him by the Victoria University. Of late years the infirmities of age had prevented his taking an active part in the affairs of the Society, though his old-fashioned courtesy, or rather courtliness of manner, and the invariable kindness which he extended to all the members, will not soon be forgotten. Even more enduring will be his substantial bequests to Owens College, and the obligations under which he has placed the science of organic chemistry.

Dr. Schunck was married in 1851 to Miss Judith Brooke, of Stockport, and had a family of five sons and two daughters, of whom three sons and one daughter, together with Mrs. Schunck, survive. He died at Kersal on January 13, 1903.

The following is a complete list of his communications to the Literary and Philosophical Society:—

Papers:—

“On the Action of the Ferment of Madder on Sugar” (1854).

*Mem.* (2) xii. 109.

“On the Formation of Indigo-Blue,” Part I. (1855). *Mem.* (2)

xii. 177.

— Part II. (1856). *Mem.* (2) xiv. 181.

“On the Occurrence of Indigo-blue in Urine,” (1857). *Mem.*

(2) xiv. 239.

“On a Yellow Colouring Matter obtained from the Leaves of the *Polygonum fagopyrum* or Common Buckwheat,” (1857). *Mem.* (2) xv. 122.

— (Abstract). *Proc.* i. 1.

“On some Products derived from Indigo-blue,” (1865). *Mem.*

(3) iii. 66.

— (Abstract). *Proc.* iv. 70.

“On some Constituents of Cotton-fibre,” (1868). *Mem.* (3)

iv. 95.

— (Abstract). *Proc.* vii. 91.

“On the Chemical Formula of Alizarine,” (1869). *Proc.* viii.

- “On Anthraflavic Acid, a Yellow Colouring-matter accompanying Artificial Alizarine.” (1871). *Mem.* (3) v. 227 ; *Proc.* x. 133.
- “On Methyl-alizarine and Ethyl-alizarine,” (1873). *Mem.* (3) v. 236 ; *Proc.* xii. 86.
- “On the Colour of Nankin Cotton,” (1873). *Mem.* (3) v. 362 ; *Proc.* xiii. 22.
- “On Indigo-blue from *Polygonum tinctorium* and other Plants,” (1878). *Mem.* (3) vi. 218.
- (Abstract). *Proc.* xvii. 157.
- “Note on modified Chlorophyll from the Leaves of *Eucalyptus globulus*,” (1880). *Proc.* xix. 157.
- “Remarks on the Terms used to denote Colour, and on the Colours of Faded Leaves,” (1881). *Mem.* (3) viii. 26 ; *Proc.* xxi. 43.
- “Memoir of Robert Angus Smith, Ph.D., LL.D., F.R.S., F.C.S., &c.,” (1885). *Mem.* (3) x. 90 ; *Proc.* xxiv. 97.
- “On the Green Colouring Matter from Leaves found in one of the Cuttings for the Manchester Ship Canal,” (1889). *Mem.* (4) ii. 231.
- “Notes on some Ancient Dyes,” (1892). *Mem.* (4) v. 158.

Minor Communications :—

- “On a New Source of Indigo,” (1862). *Proc.* ii. 181.
- “On Vogelsang and Geissler’s Experiments on the Nature of the Liquids enclosed in certain Minerals,” (1869). *Proc.* ix. 4.
- “On Artificial Alizarine,” (1870). *Proc.* ix. 106.
- “On Dr. Gerhard Kruss’s Alleged Discovery of a Foreign Substance in Commercial Nickel,” (1890). *Mem.* (4) iii. 170.
- “On the New Compound of Nitrogen,” (1890). *Mem.* (4) iv. 16.
- “On a Copy of Colonel Drinkwater’s ‘History of the Siege of Gibraltar,’” (1892). *Mem.* (4) v. 139 and 141.

- “On a Specimen of Woollen Cloth of Egyptian Production of the Fifth Century,” (1892). *Mem.* (4) v. 172.
- “Extract from a Letter by Prof. Flinders Petrie on some Egyptian Fabrics,” (1893). *Mem.* (4) vii. 210.
- “On Carminic Acid,” (1896). *Mem.* xli. xiv.

The following communication was made in the names of Dr. Schunck and Hermann Roemer :—

- “On some Isomerides of Alizarine,” (1876). *Mem.* (3) vi. 37.

C. L. B.

---

MANCHESTER LITERARY AND  
Charles Bailey, Treasurer, in Account with the

Dr.	£ s. d.	£ s. d.
To Cash in hand, 1st April, 1902 .. .. .		40 4 10
To Members' Subscriptions:—		
Half Subscriptions, 1901-2, 3 at £1 1s. od. .. .. .	3 3 0	
" " 1902-3, 10 " " .. .. .	10 10 0	
Subscriptions:— 1899-1900, 3 " £2. 2s. od. .. .. .	6 6 0	
" " 1900-1, 1 " " .. .. .	2 2 0	
" " 1901-2, 6 " " .. .. .	12 12 0	
" " 1902-3, 120 " " .. .. .	252 0 0	
" " 1903-4, 1 " " .. .. .	2 2 0	
	288 15 0	
To Compounder's Fee .. .. .		26 5 0
To Balance received from the Treasurer of the Microscopical and Natural History Section .. .. .		11 5 9
To Transfers from the Wilde Endowment Fund .. .. .		31 10 0
To Sale of Publications .. .. .		15 7 0
To Dividends:—		
Natural History Fund .. .. .	57 9 9	
Joule Memorial Fund .. .. .	7 5 2	
	64 14 11	
To Income Tax Refunded:—		
Natural History Fund .. .. .	3 12 9	
Joule Memorial Fund .. .. .	0 9 4	
	4 2 1	
		£532 4 7

**NATURAL HISTORY**

To Dividends on £1,225 Great Western Railway Company's Stock .. .. .	57 9 9
To Remission of Income Tax, 1902 .. .. .	3 12 9
To Balance against this Fund, 1st April, 1903 .. .. .	43 3 10
	£109 6 4

**JOULE MEMORIAL**

To Balance, 1st April, 1902 .. .. .	41 11 4
To Dividends on £250 Loan to Manchester Corporation .. .. .	7 5 2
To Remission of Income Tax, 1902 .. .. .	0 9 4
	£49 5 10

**WILDE ENDOWMENT**

To Balance 1st April, 1902 .. .. .	92 11 0
To Dividends on £7,500 Gas Light and Coke Company's Ordinary Stock .. .. .	295 12 6
To Remission of Income Tax, 1902 .. .. .	18 7 11
To Bank Interest .. .. .	1 3 5
	£407 14 10

**DALTON TOMB**

To Balance, 1st April, 1902 .. .. .	31 19 2
To Bank Interest .. .. .	0 15 6
	£32 14 8

PHILOSOPHICAL SOCIETY.

Society, from 1st April, 1902, to 31st March, 1903.

Cr.

	£	s.	d.	£	s.	d.
By Charges on Property :—						
Chief Rent (Income Tax deducted) .. .. .	12	2	9			
Income Tax on Chief Rent .. .. .	0	16	1			
Insurance against Fire .. .. .	13	17	6			
By House Expenditure :—						
Coals, Gas, Electric Light, Water, Wood, &c. .. .. .	23	15	7	26	16	4
Tea, Coffee, &c., at Meetings .. .. .	17	6	8½			
Cleaning, Sweeping Chimneys, &c. .. .. .	3	15	3			
By Administrative Charges :—						
Housekeeper .. .. .	57	4	0	46	17	6½
Postages, and Carriage of Parcels and of "Memoirs" .. .. .	33	9	10½			
Stationery, Cheques, Receipts, and Engrossing .. .. .	6	7	4			
Printing Circulars, Reports, &c. .. .. .	10	11	6			
Bank Interest .. .. .	0	4	5			
Miscellaneous Expenses .. .. .	5	10	7			
By Publishing :—						
Printing "Memoirs and Proceedings" (Vol. 46, pt. 5, to Vol. 47, pt. 2) .. .. .	91	14	3	113	7	8½
Illustrations for "Memoirs" (except Natural History Papers) .. .. .	2	5	6			
Binding "Memoirs" .. .. .	2	0	0			
By Library :—						
Books and Periodicals (except on Natural History .. .. .	43	11	8	95	19	9
Periodicals formerly subscribed for by the Microscopical and Natural History Section .. .. .	6	6	6			
By Natural History Fund :—						
(Items shown in the Balance Sheet of this Fund below) .. .. .				49	18	2
By Joule Memorial Fund :—						
(No Expenditure this Session) .. .. .				55	2	8
By Balance at Williams Deacon's Bank, 1st April, 1902 .. .. .	134	2	5	0	0	0
.. .. . in Treasurer's hands .. .. .	10	0	0			
				144	2	5
				<u>£532</u>	<u>4</u>	<u>7</u>

FUND, 1902—1903. (Included in the General Account, above.)

	£	s.	d.	£	s.	d.
By Balance against, 1st April, 1902 .. .. .				54	3	8
By Natural History Books and Periodicals .. .. .	49	11	2			
By Illustrations for Papers on Natural History in "Memoirs" .. .. .	5	11	5			
				55	2	8
				<u>£109</u>	<u>6</u>	<u>4</u>

FUND, 1902—1903. (Included in the General Account, above.)

	£	s.	d.	£	s.	d.
(No expenditure this Session).						
By Balance, 1st April, 1903 .. .. .				49	5	10
				<u>£49</u>	<u>5</u>	<u>10</u>

FUND, 1902—1903.

	£	s.	d.	£	s.	d.
By Assistant Secretary's Salary, April, 1902, to March, 1903 .. .. .				150	0	0
By Maintenance of Society's Library :—						
Binding and Repairing Books .. .. .	33	0	2			
Periodicals to complete sets .. .. .	0	15	7			
By Repairs to Society's Premises .. .. .				33	15	9
By Transfers to Society's Funds .. .. .				14	9	6
By Cheque Book .. .. .				81	10	0
By Balance at District Bank, 1st April, 1903 .. .. .				0	2	6
				127	17	1
				<u>£407</u>	<u>14</u>	<u>10</u>

FUND, 1902-1903.

	£	s.	d.	£	s.	d.
(No Expenditure this Session).						
By Balance at Manchester and Salford Savings Bank, 1st April, 1903 .. .. .				32	14	8
				<u>£32</u>	<u>14</u>	<u>8</u>

NOTE.—The Treasurer's Accounts of the Session 1902-1903, of which the preceding pages are summaries, have been endorsed as follows :

April 23rd, 1903.

Audited and found correct.

We have also seen, at this date, the certificates of the following Stocks held in the name of the Society :—£1,225 Great Western Railway Company 5% Consolidated Preference Stock, Nos. 12,293, 12,294, and 12,323; £258 Twenty years' loan to the Manchester Corporation, redeemable 25th March, 1914 (No. 1564); £7,500 Gas Light and Coke Company Ordinary Stock (No. 6,389); and the deeds of the Natural History Fund, of the Wilde Endowment Fund, those conveying the land on which the Society's premises stand, and the Declaration of Trust.

Leases and Conveyance dated as follow .—

22nd Sept., 1797.

23rd Sept., 1797.

25th Dec., 1799.

“ ” “

22nd Dec., 1820.

23rd Dec., 1820.

Declarations of Trust :—

24th June, 1801.

23rd Dec., 1820.

30th April, 1851.

We have also verified the balances of the various accounts with the bankers' pass books.

(Signed) } GEORGE WILSON.  
                  } H. E. SCHMITZ.

THE COUNCIL  
AND MEMBERS  
OF THE  
MANCHESTER  
LITERARY AND PHILOSOPHICAL SOCIETY.

(CORRECTED TO JULY 27TH, 1903.)

---

**President.**

W. BOYD DAWKINS, M.A., D.Sc., F.R.S.

**Vice-Presidents.**

SIR WILLIAM H. BAILEY, M.I.Mech.E.

H. B. DIXON, M.A., F.R.S., F.C.S.

J. COSMO MELVILL, M.A., F.L.S.

CHARLES BAILEY, M.Sc., F.L.S.

**Secretaries.**

FRANCIS JONES, M.Sc., F.R.S.E., F.C.S.

CHARLES H. LEES, D.Sc.

**Treasurer.**

ARTHUR McDOUGALL, B.Sc.

**Librarian.**

W. E. HOYLE, M.A., D.Sc., F.R.S.E.

**Other Members of the Council.**

HORACE LAMB, M.A., LL.D., F.R.S.

FRANCIS NICHOLSON, F.Z.S.

R. L. TAYLOR, F.C.S., F.I.C.

F. E. WEISS, D.Sc., F.L.S.

C. E. STROMEYER, M.Inst.C.E.

FRANK SOUTHERN, B.Sc.

---

**Assistant Secretary and Librarian.**

A. P. HUNT, B.A.

## ORDINARY MEMBERS.

*Date of Election.*

- 1901, Dec. 10. Adamson, Harold. *Oaklands, Godley, near Manchester.*
- 1902, Mar. 18. Allen, J. Fenwick. 147, *Withington Road, Whalley Range, Manchester.*
- 1902, Jan. 21. Allott, Charles S., M.Inst.C.E. 519, *Stretford Road, Old Trafford, Manchester.*
- 1870, Dec. 13. Angell, John, F.C.S., F.I.C. 6, *Beaconsfield, Derby Road, Withington, Manchester.*
- 1896, Jan. 31. Armstrong, Frank. 88 & 90, *Deansgate, Manchester.*
- 1895, Jan. 8. Armstrong, George B. *Clarendon, Sale, Cheshire.*
- 1902, April 29. Arnold, Francis Sorell, M.B., Ch.B. (Oxon.). 468, *Moss Lane East, Manchester.*
- 1887, Nov. 16. Ashworth, J. J. 47, *Faulkner Street, Manchester.*
- 1865, Nov. 14. Bailey, Charles, M.Sc., F.L.S. *Atherstone House, North Drive, St. Annes-on-the-Sea, Lancs.*
- 1888, Feb. 7. Bailey, Alderman Sir William H. *Sale Hall, Sale, Cheshire.*
- 1895, Jan. 8. Barnes, Charles L., M.A. 8, *Swinton Avenue, Chorlton-on-Medlock, Manchester.*
- 1896, April 14. Behrens, George B. *The Acorns, 4, Oak Drive, Fallowfield, Manchester.*
- 1895, Mar. 5. Behrens, Gustav. *Holly Royde, Withington, Manchester.*
- 1898, Nov. 29. Behrens, Walter L. 22, *Oxford Street, Manchester.*
- 1868, Dec. 15. Bickham, Spencer H., F.L.S. *Underdown, Ledbury.*
- 1901, Nov. 12. Bles, A. J. S. *Palm House, Higher Broughton, Manchester.*
- 1896, April 28. Bolton, Herbert, F.R.S.E. *The Museum, Bristol.*
- 1896, Oct. 6. Bowman, F.H., D.Sc., F.R.S.E., *Spinningfield, Deansgate, Manchester.*
- 1896, Feb. 18. Bowman, George, M.D. 594, *Stretford Road, Old Trafford, Manchester.*
- 1875, Nov. 16. Boyd, John. *Barton House, 11, Didsbury Park, Didsbury, Manchester.*
- 1902, Nov. 4. Bradley, H. W. *Woodside, Wilmslow, Cheshire.*
- 1889, Oct. 15. Bradley, Nathaniel, F.C.S. *Sunnyside, Whalley Range, Manchester.*
- 1896, Nov. 17. Broderick, Lonsdale, F.C.A. *Somerby, Wilmslow, Cheshire.*



## Ordinary Members.

lix

*Date of Election.*

- 1861, April 2. Brogden, Henry, F.G.S., M.I.Mech.E. *Hale Lodge, Altrincham, Cheshire.*
- 1889, April 16. Brooks, Samuel Herbert. *Slade House, Levenshulme, Manchester.*
- 1860, Jan. 24. Brothers, Alfred. 117, *Summerfield Crescent, Edgbaston, Birmingham.*
- 1886, April 6. Brown, Alfred, M.A., M.D. *Sandycroft, Higher Broughton, Manchester.*
- 1889, Jan. 8. Brownell, T. W., F.R.A.S. 64, *Upper Brook Street, Manchester.*
- 1902, Oct. 21. Bruton, F.A., M.A. 56, *Central Road, West Didsbury, Manchester.*
- 1889, Oct. 15. Budenberg, C. F., M.Sc., M.I.Mech.E. *Bowdon Lane, Marple, Cheshire.*
- 1894, Nov. 13. Burton, William, F.C.S. *The Hollies, Clifton Junction, near Manchester.*
- 
- 1899, Feb. 7. Chapman, D.L., B.A., Demonstrator and Assistant Lecturer in Chemistry. *Owens College, Manchester.*
- 1901, Nov. 26. Chevalier, Reginald C., M.A., Mathematical Master at the Manchester Grammar School. 43, *Lansdowne Road, West Didsbury, Manchester.*
- 1902, Nov. 4. Clerk, Dugald, M.Inst.C.E., F.C.S. 18, *Southampton Buildings, Chancery Lane, London, W.C.*
- 1901, Nov. 12. Coignou, Caroline, Science Mistress at the Manchester High School for Girls. 60, *Cecil Street, Greenheys, Manchester.*
- 1895, April 30. Collett, Edward Pyemont. 8, *St. John Street, Manchester.*
- 1884, Nov. 4. Corbett, Joseph. *Town Hall, Salford.*
- 1895, April 30. Cornish, James Edward. *Stone House, Alderley Edge, Cheshire.*
- 1859, Jan. 25. Coward, Edward, Assoc.Inst.C.E., M.I.Mech.E. *Heatherlea, Bowdon, Cheshire.*
- 1895, Nov. 12. Crossley, W. J., M.I.Mech.E. *Openshaw, Manchester.*
- 
- 1901, Nov. 26. Darbishire, Francis V., B.A., Ph.D., Assistan Lecturer and Demonstrator in Chemistry at the Owens College. *Hulme Hall, Plymouth Grove, Manchester.*

*Date of Election.*

- 1895, April 9. Dawkins, W. Boyd, M.A., D.Sc., F.R.S., Professor of Geology. *Owens College, Manchester.*
- 1894, Mar. 6. Delépine, A. Sheridan, M.B., B.Sc., Professor of Pathology. *Owens College, Manchester.*
- 1887, Feb. 8. Dixon, Harold Baily, M.A., F.R.S., F.C.S., Professor of Chemistry. *Owens College, Manchester.*
- 1898, Oct. 18. Donovan, E. W., M.I.Mech.E. *Hilton House, Prestwich, Lancs.*
- 1899, April 11. Earle, Hardman A. 40, *Oughton Road, Birkdale, Lancs.*
- 1902, May 13. Ellison, Robert William. 40, *Lincroft Street, Moss Side, Manchester.*
- 1883, Oct. 2. Faraday, F. J., F.L.S., F.S.S. *Ramsay Lodge, Slade Lane, Levenshulme, Manchester.*
- 1897, Oct. 19. Faraday, W. Barnard, LL.B. *Ramsay Lodge, Slade Lane, Levenshulme, Manchester.*
- 1895, April 30. Flux, A. W., M.A., Professor of Political Economy. *McGill University, Montreal, Canada.*
- 1897, Nov. 30. Freston, H. W. *Westfield, Poynton, Cheshire.*
- 1898, Nov. 29. Gamble, F. W., D.Sc., Demonstrator and Assistant Lecturer in Zoology. *Owens College, Manchester.*
- 1900, Feb. 6. Goldthorpe, William. *Brook House, Burnage Lane, Levenshulme, Manchester.*
- 1896, Nov. 17. Gordon, Rev. Alexander, M.A. *Memorial Hall, Albert Square, Manchester.*
- 1900, Oct. 16. Grindley, J. H., D.Sc. *Technical College, Huddersfield.*
- 1890, Feb. 18. Harker, Thomas. *Brook House, Fallowfield, Manchester.*
- 1895, Nov. 12. Hartog, Philippe Joseph, B.Sc., F.C.S., Demonstrator and Assistant Lecturer in Chemistry. *Owens College, Manchester.*
- 1902, April 29. Herbert, Arthur M., B.A. *Park Avenue, Timperley, Cheshire.*
- 1902, Jan. 7. Hewitt, David B., M.D. *Oakleigh, Northwich, Cheshire.*

*Date of Election.*

- 1889, Jan. 8. Heywood, Charles J., *Chaseley, Pendleton, Manchester.*
- 1895, Mar. 5. Hickson, Sydney J., M.A., D.Sc., F.R.S., Professor of Zoology. *Owens College, Manchester.*
- 1901, Dec. 10. Hiles, Isa L., M.Sc., Science Mistress at the Manchester High School for Girls. *Stanton Avenue, Didsbury, Manchester.*
- 1884, Jan. 8. Hodgkinson, Alexander, M.B., B.Sc. 18, *St. John Street, Manchester.*
- 1898, Nov. 29. Hopkinson, Alfred, K.C., M.A., LL.D., Principal of the Owens College. *Fairfield, Victoria Park, Manchester.*
- 1896, Nov. 3. Hopkinson, Edward, D.Sc., M.Inst.C.E. *Oakleigh, Timperley, Cheshire.*
- 1889, Oct. 15. Hoyle, William Evans, M.A., D.Sc., F.R.S.E., Director of the Manchester Museum. *Owens College, Manchester.*
- 1900, Oct. 16. Hutton, R. S., M.Sc., Demonstrator and Assistant Lecturer in Electro-Chemistry. *Owens College, Manchester.*
- 1899, Oct. 17. Ingleby, Joseph, M.I.Mech.E. *Summer Hill, Pendleton, Manchester.*
- 1901, Nov. 26. Jackson, Frederick. 14, *Cross Street, Manchester.*
- 1870, Nov. 1. Johnson, William H., B.Sc. 26, *Lever Street, Manchester.*
- 1878, Nov. 26. Jones, Francis, M.Sc., F.R.S.E., F.C.S. *Manchester Grammar School.*
- 1886, Jan. 12. Kay, Thomas. *Moorfield, Stockport, Cheshire.*
- 1891, Dec. 1. King, John Edward, M.A., High Master, *Manchester Grammar School.*
- 1895, Nov. 12. Kirkman, W. W. *The Grange, Timperley, Cheshire.*
- 1903, Feb. 3. Knecht, Edmund, Ph.D., Professor of Tinctorial Chemistry at the Municipal School of Technology, Manchester. 5, *Station Road, Crumpsall, Manchester.*
- 1902, Feb. 4. Kolp, N. *Woodthorpe, Victoria Park, Manchester.*
- 1901, Oct. 29. Laidlaw, Frank F., B.A., Demonstrator and Assistant Lecturer in Zoology at the Owens College. 8, *Parsonage Road, Withington, Manchester.*
- 1893, Nov. 14. Lamb, Horace, M.A., LL.D., F.R.S., Professor of Mathematics. 6, *Wilbraham Road, Fallowfield, Manchester.*

*Date of Election.*

- 1902, Jan. 7. Lange, Ernest F. *Fairholme, 3, Willow Bank, Fallowfield, Manchester.*
- 1899, Feb. 7. Lawrence, W. T., B.A., Ph.D., Demonstrator and Assistant Lecturer in Organic Chemistry. *Owens College, Manchester.*
- 1895, Nov. 12. Lees, Charles Herbert, D.Sc., Lecturer in Physics at the Owens College. *Chevy Chase, Lorne Grove, Fallowfield, Manchester.*
- 1902, Nov. 4. Leigh, Joseph Egerton. *The Towers, Didsbury, Manchester.*
- 1902, Jan. 7. Longridge, Michael, M.A., M.Inst.C.E. *Linkvretten, Ashley Road, Bowton, Cheshire.*
- 1857, Jan. 27. Longridge, Robert Bewick, M.I.Mech.E. *Yew Tree House, Tabley, Knutsford, Cheshire.*
- 1898, Nov. 29. McConnel, J. W., M.A. *Wellbank, Prestwich, Lancs.*
- 1866, Nov. 13. McDougall, Arthur, B.Sc. *Lynahurst, The Park, Buxton.*
- 1902, Mar. 4. Mandleberg, G. C. *Carlton House, Broom Lane, Higher Broughton, Manchester.*
- 1875, Jan. 26. Mann, J. Dixon, M.D., F.R.C.P. (Lond.), Professor of Medical Jurisprudence at Owens College. *16, St. John Street, Manchester.*
- 1901, Dec. 10. Massey, Herbert. *Ivy Lea, Burnage, Didsbury, Manchester.*
- 1896, Oct. 20. Massey, Leonard F. *Openshaw, Manchester.*
- 1864, Nov. 1. Mather, Sir William, M.P., M.Inst.C.E., M.I.Mech.E. *Iron Works, Salford.*
- 1903, Jan. 6. Mellanby, Alexander L., M.Sc., Lecturer in Engineering at the Municipal School of Technology, Manchester. *33, Keppel Road, Chorlton-cum-Hardy, Manchester.*
- 1873, Mar. 18. Melvill, James Cosmo, M.A., F.L.S. *Brook House, Prestwich, Lancs.*
- 1896, Nov. 3. Milligan, William, M.D. *Westbourne, Wilmslow Road, Rusholme, Manchester.*
- 1881, Oct. 18. Mond, Ludwig, Ph.D., F.R.S., F.C.S. *Winnington Hall, Northwich, Cheshire.*
- 1894, Feb. 6. Mond, Robert Ludwig, M.A., F.R.S.E., F.C.S. *Winnington Hall, Northwich, Cheshire.*
- 1899, Mar. 7. Morris, Edgar F., M.A., F.C.S. *Grey House, Barrington Road, Altrincham, Cheshire.*

*Date of Election.*

- 1902, Feb. 18. Moss, William E., B.A. *C/o Messrs. Davies, Benachi & Co., 7, Rumford Street, Liverpool.*
- 1873, Mar. 4. Nicholson, Francis, F.Z.S. *84, Major Street, Manchester.*
- 1900, April 3. Nicolson, John T., D.Sc., Professor of Engineering at the Municipal School of Technology, Manchester. *Nant-y-Glyn, Marple, Cheshire.*
- 1889, April 16. Norbury, George. *Hillside, Prestwich Park, Prestwich, Lancs.*
- 1884, April 15. Okell, Samuel, F.R.A.S. *Overley, Langham Road, Bowdon, Cheshire.*
- 1903, Jan. 6. Oldham, Charles. *Brook Cottage, Knutsford, Cheshire.*
- 1901, Nov. 26. Paine, Standen. *Devisdale, Bowdon, Cheshire.*
- 1892, Nov. 15. Perkin, W. H., jun., Ph.D., F.R.S., Professor of Organic Chemistry. *Owens College, Manchester.*
- 1901, Oct. 29. Petavel, J. E. *Owens College, Manchester.*
- 1885, Nov. 17. Phillips, Henry Harcourt, F.C.S. *9, Crawford Avenue, Bolton, Lancs.*
- 1902, Oct. 21. Pope, W. J., F.R.S., F.C.S., Professor of Chemistry at the Municipal School of Technology, Manchester. *16, Hope Street, Higher Broughton, Manchester.*
- 1901, Nov. 12. Pratt, Edith M., M.Sc. *Peak House, Dukinfield, Cheshire.*
- 1903, Feb. 3. Radcliffe, L. G., F.C.S., Lecturer in Chemistry at the Municipal School of Technology, Manchester. *6, Alma Terrace, Old Trafford, Manchester.*
- 1900, Feb. 20. Ragdale, J. R. *The Beeches, Whitefield, near Manchester.*
- 1901, Dec. 10. Ramsden, Herbert, M.D. (Lond.), M.B., Ch.B. (Vict.). *Sunnyside, Dobcross, near Oldham, Lancs.*
- 1888, Feb. 21. Réé, Alfred, Ph.D., F.C.S. *15, Mauldeth Road, Withington, Manchester.*
- 1901, Oct. 15. Reynolds, J. H., M.Sc., Principal, *Municipal School of Technology, Sackville Street, Manchester.*
- 1869, Nov. 16. Reynolds, Osborne, M.A., LL.D., F.R.S., M.Inst.C.E., Professor of Engineering, Owens College. *19, Ladybarn Road, Fallowfield, Manchester.*
- 1880, Mar. 23. Roberts, D. Lloyd, M.D., F.R.S.E., F.R.C.P. (Lond.). *Ravenswood, Broughton Park, Manchester.*
- 1897, Oct. 19. Rothwell, William Thomas. *Heath Brewery, Newton Heath, near Manchester.*

*Date of Election,*

- 1893, Mar. 21. Schill, C. H. 117, *Portland Street, Manchester.*
- 1896, Nov. 17. Schmitz, Hermann Emil, B.A., B.Sc. *Manchester Grammar School.*
- 1873, Nov. 18. Schuster, Arthur. Ph.D., F.R.S., F.R.A.S., Professor of Physics. *Kent House, Victoria Park, Manchester.*
- 1898, Jan. 25. Schwabe, Louis. *Hart Hill, Eccles Old Road, Pendleton, Manchester.*
- 1902, Jan. 21. Shann, T. T. *Meadow Bank, Heaton Norris, Stockport.*
- 1890, Nov. 4. Sidebotham, Edward John, M.A., M.B., M.R.C.S. *Erlesdene, Bowdon, Cheshire.*
- 1903, April 28. Sidebottom, H. *The Hall Cottage, Cheadle Hulme, near Stockport.*
- 1901, Oct. 29. Sinclair, W. J., M.D., Professor of Obstetrics and Gynecology. *Owens College, Manchester.*
- 1895, Nov. 12. Southern, Frank, B.Sc. 6, *Park Avenue, Timperley, Cheshire.*
- 1896, Feb. 18. Spence, David. *Honeyhanger, Haslemere, Surrey.*
- 1901, Dec. 10. Spence, Howard. *Audley, Broad Road, Sale, Cheshire.*
- 1896, April 14. Stanton, Thomas E., D.Sc. *National Physical Laboratory, Bushey House, Teddington, Middlesex.*
- 1894, Jan. 9. Stevens, Marshall, F.S.S. 18, *Exchange Street, Manchester.*
- 1897, Nov. 30. Stromeyer, C. E., M.Inst.C.E. *Steam Users' Association, 9, Mount Street, Albert Square, Manchester.*
- 1903, April 28. Sutton, Charles W., M.A. *Free Reference Library, King Street, Manchester.*
- 1895, April 9. Tatton, Reginald A., M.Inst.C.E. Engineer to the Mersey and Irwell Joint Committee. 44, *Mosley Street, Manchester.*
- 1893, Nov. 14. Taylor, R. L., F.C.S., F.I.C. *Central School, Whitworth Street, Manchester.*
- 1873, April 15. Thomson, William, F.R.S.E., F.C.S., F.I.C. *Royal Institution, Manchester.*
- 1896, Jan. 21. Thorburn, William, M.D., B.Sc. 2, *St. Peter's Square, Manchester.*
- 1896, Jan. 21. Thorp, Thomas, F.R.A.S. *Moss Bank, Whitefield, near Manchester.*
- 1899, Oct. 31. Thorpe, Jocelyn F., Ph.D., Demonstrator in Organic Chemistry. *Owens College, Manchester.*
- 1899, Oct. 17. Todd, W. H. *Greenfield, Flixton, near Manchester.*

*Date of Election.*

- 1873, Nov. 18. Waters, Arthur William, F.L.S., F.G.S. *Sunny Lea, Davos Dorf, Switzerland.*
- 1892, Nov. 15. Weiss, F. Ernest, D.Sc., F.L.S., Professor of Botany, Owens College. 20, *Brunswick Road, Withington, Manchester.*
- 1895, April 9. Whitehead, James. *Lindfield, Fulshaw Park, Wilmslow, Cheshire.*
- 1901, Oct. 1. Wild, Robert B., M.D., M.Sc., M.R.C.P., Professor of Materia Medica and Therapeutics, Owens College. *Broome House, Fallowfield, Manchester.*
- 1859, Jan. 25. Wilde, Henry, D.Sc., F.R.S. *The Hurst, Alderley Edge, Cheshire.*
- 1888, April 17. Williams, Sir E. Leader, M.Inst.C.E., M.I.Mech.E. *Spring Gardens, Manchester.*
- 1896, Dec. 1. Wilson, George, D.Sc., Demonstrator in Engineering, Owens College, *Manchester.*
- 1901, Nov. 26. Wilson, William, M.A., Principal, *Royal Technical Institute, Salford.*
- 1902, Oct. 21. Woolcott, Walter. *Westinghouse Works, Trafford Park, Manchester.*
- 1860, April 17. Woolley, George Stephen. *Victoria Bridge, Manchester.*
- 1863, Nov. 17. Worthington, Samuel Barton, M.Inst.C.E., M.I.Mech.E. *Mill Bank, Bowdon, and 37, Princess Street, Manchester.*
- 1865, Feb. 21. Worthington, Thomas, F.R.I.B.A. 46, *Brown Street, Manchester.*
- 1895, Jan. 8. Worthington, Wm. Barton, B.Sc., M.Inst.C.E. 2, *Wilton Polygon, Cheetham Hill, Manchester.*
- 1897, Oct. 19. Wyatt, Charles H., M.A., *Chelford, Cheshire.*

---

N.B.—Of the above list the following have compounded for their subscriptions, and are therefore life members :—

- Bailey, Charles, M.Sc., F.L.S.  
 Bradley, Nathaniel, F.C.S.  
 Brogden, Henry, F.G.S.  
 Ingleby, Joseph, M.I.Mech.E.  
 Johnson, William H., B.Sc.  
 Worthington, Wm. Barton, B.Sc.
-

## HONORARY MEMBERS.

*Date of Election.*

- 1892, April 26. Abney, Sir W. de W., K.C.B., D.Sc., F.R.S. *Rathmore Lodge, Bolton Gardens South, South Kensington, London, S.W.*
- 1892, April 26. Amagat, E. H., For. Mem. R.S., Corr. Memb. Inst. Fr. (Acad. Sci.), Examinateur à l'École Polytechnique. *Avenue d'Orléans, 19, Paris.*
- 1894, April 17. Appell, Paul, Membre de l'Institut, Professor of Theoretical Mechanics. *Faculté des Sciences, Paris.*
- 1892, April 26. Ascherson, Paul F. Aug., Professor of Botany. *Universität, Berlin.*
- 1889, April 30. Avebury, John Lubbock, Lord, D.C.L., LL.D., F.R.S. *High Elms, Down, Kent.*
- 1892, April 26. Baeyer, Adolf von, For. Mem. R.S., Professor of Chemistry. *1, Arcisstrasse, Munich.*
- 1886, Feb. 9. Baker, Sir Benjamin, K.C.M.G., LL.D., F.R.S. *2, Queen Square Place, Westminster, London, S.W.*
- 1886, Feb. 9. Baker, John Gilbert, F.R.S., F.L.S. *3, Cumberland Road, Kew.*
- 1895, April 30. Beilstein, F., Ph.D., Professor of Chemistry. *8th Line, N. 17, St. Petersburg, W.O.*
- 1886, Feb. 9. Berthelot, Marcelin P. E., For. Mem. R.S., Membre de l'Institut, Professor of Chemistry, Secrétaire perpétuel de l'Académie des Sciences. *Paris.*
- 1892, April 26. Boltzmann, Ludwig, For. Mem. R.S., Professor of Physics. *Türkenstrasse 3, Vienna, IX. 1.*
- 1886, Feb. 9. Buchan, Alexander, M.A., LL.D., F.R.S., F.R.S.E. *42, Heriot Row, Edinburgh*
- 1888, April 17. Cannizzaro, Stanislao, For. Mem. R.S., Corr. Memb. Inst. Fr. (Acad. Sci.), Professor of Chemistry. *Reale Università, Rome.*
- 1889, April 30. Carruthers, William, F.R.S., F.L.S. *14, Vermont Road, Norwood, London, S.E.*
- 1903, April 28. Clarke, Frank Wigglesworth, D.Sc. *U.S. Geological Survey, Washington, D.C., U.S.A.*
- 1866, Oct. 30. Clifton, Robert Bellamy, M.A., F.R.S., F.R.A.S., Professor of Natural Philosophy. *3, Barrowell Road, Banbury Road, Oxford.*



*Date of Election.*

- 1892, April 26. Curtius, Theodor, Professor of Chemistry. *Universität, Kiel.*
- 1892, April 26. Darboux, Gaston, Membre de l'Institut, Professor of Geometry, Faculté des Sciences, Secrétaire perpétuel de l'Académie des Sciences. 36, *Rue Gay Lussac, Paris.*
- 1894, April 17. Debus, H., Ph.D., F.R.S. 4. *Schlangenweg, Cassel, Hessen, Germany.*
- 1888, April 17. Dewalque, Gustave, Professor of Geology. *Université, Liège.*
- 1900, April 24. Dewar, James, M.A., LL.D., D.Sc., F.R.S., V.P.C.S., Fullerman Professor of Chemistry. *Royal Institution, Albemarle Street, London, W.*
- 1892, April 26. Dohrn, Dr. Anton, For. Mem. R.S. *Zoologische Station, Naples.*
- 1892, April 26. Dyer, Sir W. T. Thiselton, K.C.M.G., C.I.E., M.A., F.R.S., Director of the Royal Botanic Gardens. *Kew.*
- 1892, April 26. Edison, Thomas Alva. *Orange, N.J., U.S.A.*
- 1895, April 30. Elster, Julius, Ph.D. 6, *Lessingstrasse, Wolfenbüttel.*
- 1900, April 24. Ewing, James Alfred, M.A., F.R.S., Professor of Mechanism and Applied Mechanics. *Langdale Lodge, Cambridge.*
- 1889, April 30. Farlow, W. G., Professor of Botany. *Harvard College, Cambridge, Mass., U.S.A.*
- 1900, April 24. Forsyth, Andrew Russell, M.A., Sc.D., F.R.S., Sadlerian Professor of Pure Mathematics. *Trinity College, Cambridge.*
- 1889, April 30. Foster, Sir Michael, K.C.B., M.P., M.A., M.D., LL.D., Sec. R.S., Professor of Physiology. *Trinity College, Cambridge.*
- 1892, April 26. Fürbringer, Max, Professor of Anatomy. *Grossherz. Universität, Jena.*
- 1892, April 26. Gegenbaur, Carl, For. Mem. R.S., Professor of Anatomy. 57, *Leopoldstrasse, Heidelberg.*
- 1900, April 24. Geikie, James, D.C.L., LL.D., F.R.S., Murchison Professor of Geology and Mineralogy. *Kilmorie, Cotinton Road, Edinburgh.*
- 1895, April 30. Geitel, Hans. 6, *Lessingstrasse, Wolfenbüttel.*
- 1894, April 17. Glaisher, J. W. L., Sc.D., F.R.S., Lecturer in Mathematics. *Trinity College, Cambridge.*
- 1894, April 17. Gouy, A., Professor of Physics. *Faculté des Sciences, Lyons.*

*Date of Election.*

- 1900, April 24. Haeckel, Ernst, Ph.D., Professor of Zoology. *Zoologisches Institut, Jena.*
- 1894, April 17. Harcourt, A. G. Vernon, M.A., D.C.L., F.R.S., V.P.C.S. *Cowley Grange, Oxford.*
- 1894, April 17. Heaviside, Oliver, F.R.S. *Bradley View, Newton Abbot, Devon.*
- 1892, April 26. Hill, G. W. *West Nyack, N. Y., U.S.A.*
- 1888, April 17. Hittorf, Johann Wilhelm, Professor of Physics. *Polytechnicum, Münster.*
- 1892, April 26. Hoff, J. van't, Ph.D., For. Mem. R.S., Professor of Chemistry. 2, *Uhlandstrasse, Charlottenburg, Berlin.*
- 1892, April 26. Hooker, Sir Joseph Dalton, G.C.S.I., C.B., D.C.L., F.R.S., Corr. Memb. Inst. Fr. (Acad. Sci.). *The Camp, Sunningdale, Berks.*
- 1869, Jan. 12. Huggins, Sir William, O.M., K.C.B., LL.D., D.C.L., P.R.S., F.R.A.S., Corr. Memb. Inst. Fr. (Acad. Sci.). 90, *Upper Tulse Hill, Brixton, London, S. W.*
- 1851, April 29. Kelvin, William Thomson, Lord, O.M., G.C.V.O., M.A., D.C.L., LL.D., F.R.S., F.R.S.E., For. Assoc. Inst. Fr. (Acad. Sci.). *Netherhall, Largs, Ayrshire.*
- 1892, April 26. Klein, Felix, Ph.D., For. Mem. R.S., Corr. Memb. Inst. Fr. (Acad. Sci.), Professor of Mathematics. 3, *Wilhelm Weber Strasse, Göttingen.*
- 1894, April 17. Königsberger, Leo, Professor of Mathematics. *Universität, Heuelberg.*
- 1892, April 26. Ladenburg, A., Ph.D., Professor of Chemistry. 3, *Kaiser Wilhelm Strasse, Breslau.*
- 1887, April 19. Langley, S. P., For. Mem. R.S. *Smithsonian Institution, Washington, U.S.A.*
- 1902, May 13. Larmor, Joseph, M.A., D.Sc., LL.D., Sec. R.S., F.R.A.S. *St. Jo. n's College, Cambridge.*
- 1892, April 26. Liebermann, C., Professor of Chemistry. 29, *Matthäi-Kirch Strasse, Berlin.*
- 1887, April 19. Lockyer, Sir J. Norman, K.C.B., F.R.S., Corr. Memb. Inst. Fr. (Acad. Sci.). *Science School, South Kensington, London, S. W.*
- 1902, May 13. Lodge, Sir Oliver Joseph, D.Sc., LL.D., F.R.S., Principal of the University of Birmingham. *The University, Birmingham.*
- 1900, April 24. Lorentz, Henrik Anton, Professor of Physics. *Hooigracht, 48, Leyden.*

*Date of Election.*

- 1892, April 26. Marshall, Alfred, M.A., Professor of Political Economy.  
*Balliol Croft, Madingley Road, Cambridge.*
- 1892, April 26. Mascart, E. E. N., For. Mem. R.S., Membre de l'Institut,  
Professor at the Collège de France. 176, *Rue de*  
*l'Université, Paris.*
- 1889, April 30. Mendeléeff, D., Ph.D., For. Mem. R.S. *Université, St.*  
*Petersburg.*
- 1901, April 23. Metchnikoff, Élie, D.Sc., For. Mem. R.S. *Institut Pasteur,*  
*Paris.*
- 1895, April 30. Mittag-Leffler, Gösta, D.C.L. (Oxon.), For. Mem. R.S.,  
Professor of Mathematics. *Djursholm, Stockholm.*
- 1892, April 26. Moissan, H., Membre de l'Institut, Professor of the Faculté  
des Sciences à la Sorbonne. 7, *Rue Vanquelin, Paris.*
- 1894, April 17. Murray, Sir John, K.C.B., LL.D., D.Sc., F.R.S.  
*Challenger Lodge, Wardie, Edinburgh.*
- 1894, April 17. Neumayer, Professor G., For. Mem. R.S., Director of the  
Seewarte. *Hohenzollern Strasse, 9, Neustadt an der*  
*Haardt, Germany.*
- 1887, April 19. Newcomb, Simon, For. Mem. R.S., For. Assoc. Inst. Fr.  
(Acad. Sci.), Professor of Mathematics and Astronomy.  
1620, *P Street, Washington, D.C., U.S.A.*
- 1902, May 13. Osborn, Henry Fairfield, Professor of Vertebrate Paleon-  
tology. *Columbia College, New York, U.S.A.*
- 1894, April 17. Ostwald, W., Professor of Chemistry. 2/3, *Linnéstrasse,*  
*Leipsic.*
- 1899, April 25. Palgrave, R. H. Inglis, F.R.S., F.S.S. *Belton, Great*  
*Yarmouth.*
- 1892, April 26. Perkin, W. H., LL.D., Ph.D., F.R.S., V.P.C.S. *The*  
*Chestnuts, Sudbury, Harrow.*
- 1894, April 17. Pfeffer, Wilhelm, For. Mem. R.S., Professor of Botany.  
*Botanisches Institut, Leipsic.*
- 1892, April 26. Poincaré, H., For. Mem. R.S., Membre de l'Institut,  
Professor of Astronomy. 63, *Rue Claude Bernard, Paris.*
- 1892, April 26. Quincke, G. H., For. Mem. R.S., Professor of Physics.  
*Universität, Heidelberg.*
- 1899, April 25. Ramsay, Sir William, K.C.B., Ph.D., F.R.S., Professor of  
Chemistry. 12, *Arundel Gardens, Notting Hill,*  
*London, W.*

*Date of Election.*

- 1849, Jan. 23. Rawson, Robert, F.R.A.S. *Havant, Hants.*
- 1886, Feb. 9. Rayleigh, John William Strutt, Lord, O.M., M.A., D.C.L. (Oxon.), LL.D. (Univ. McGill). F.R.S., F.R.A.S., Corr. Memb. Inst. Fr. (Acad. Sci.). *Terling Place, Witham, Essex.*
- 1900, April 24. Ridgway, Robert, Curator of the Department of Birds, U.S. National Museum. *Brookland, District of Columbia, U.S.A.*
- 1897, April 27. Roscoe, Sir Henry Enfield, B.A., LL.D., D.C.L., F.R.S., V.P.C.S., Corr. Memb. Inst. Fr. (Acad. Sci.). 10, *Bramham Gardens, Earl's Court, London, S.W.*
- 1889, April 30. Routh, Edward John, D.Sc., F.R.S. *Newnham Cottage, Queen's Road, Cambridge.*
- 1889, April 30. Salmon, Rev. George, D.D., D.C.L., LL.D., F.R.S., Corr. Memb. Inst. Fr. (Acad. Sci.). *Provost's House, Trinity College, Dublin.*
- 1894, April 17. Sanderson, Sir J. S. Burdon, Bart., M.A., M.D., F.R.S., Corr. Memb. Inst. Fr. (Acad. Sci.), Regius Professor of Medicine. *University, Oxford.*
- 1902, May 13. Scott, Dukinfield Henry, M.A., Ph.D., F.R.S., F.L.S., Honorary Keeper of the Jodrell Laboratory, Royal Botanic Gardens, Kew. *Old Palace, Richmond, Surrey.*
- 1892, April 26. Sharpe, R. Bowdler, LL.D., F.L.S., F.Z.S. *British Museum (Natural History), Cromwell Road, London, S.W.*
- 1892, April 26. Solms, H., Graf zu, Professor of Botany. *Universität, Strassburg.*
- 1869, Dec. 14. Sorby, Henry Clifton, LL.D., F.R.S., F.L.S., F.G.S. *Broomfield, Sheffield.*
- 1886, Feb. 9. Strasburger, Eduard, D.C.L., For. Mem. R.S., Professor of Botany. *Universität, Bonn.*
- 1895, April 30. Suess, Eduard, Ph.D., For. Mem. R.S., For. Assoc. Inst. Fr. (Acad. Sci.), Professor of Geology. 9, *Africanergasse, Vienna.*
- 1895, April 30. Thomson, Joseph John, M.A., Sc.D., F.R.S., Professor of Experimental Physics. 6, *Scrope Terrace, Cambridge.*
- 1894, April 17. Thorpe, T. E., C.B., Ph.D., D.Sc., LL.D., F.R.S., V.P.C.S. *Government Laboratory, Clement's Inn Passage, Strand, London, W.C.*

*Date of Election.*

- 1900, April 24. Tower, Beauchamp, M.Inst.C.E. *Warley Mount, Brentwood, Essex.*
- 1894, April 17. Turner, Sir William, K.C.B., M.B., D.C.L., F.R.S., F.R.S.E., Professor of Anatomy. 6, *Eton Terrace, Edinburgh.*
- 1886, Feb. 9. Tylor, Edward Burnett, D.C.L. (Oxon), LL.D. (St. And. and McGill Colls.), F.R.S., Professor of Anthropology. *Museum House, Oxford.*
- 1894, April 17. Vines, Sidney Howard, M.A., D.Sc., F.R.S., Sherardian Professor of Botany. *Headington Hill, Oxford.*
- 1894, April 17. Warburg, Emil, Professor of Physics. *Physikalisches Institut, Neue Wilhelmstrasse, Berlin.*
- 1894, April 17. Ward, H. Marshall, D.Sc., F.R.S., Professor of Botany. *Botanical Laboratory, New Museums, Cambridge.*
- 1894, April 17. Weismann, August, Professor of Zoology. *Universität, Freiburg i. Br.*
- 1889, April 30. Williamson, Alexander William, Ph.D., LL.D., F.R.S., V.P.C.S., Corr. Memb. Inst. Fr. (Acad. Sci.). *High Pitfold, Shottermill, Haslemere, Surrey.*
- 1886, Feb. 9. Young, Charles Augustus, Professor of Astronomy. *Princeton College, Princeton, N.J., U.S.A.*
- 1888, April 17. Zirkel, Ferdinand, For. Mem.R.S., Professor of Mineralogy. *Thralstrasse, 33, Leipsic.*
- 1895, April 20. Zittel, Carl Alfred von, Professor of Palaeontology and Geology. *Universität, Munich.*

## CORRESPONDING MEMBERS.

- 1850, April 30. Harley, Rev. Robert, Hon. M.A.(Oxon), F.R.S., F.R.A.S., Hon. Memb. R.S. Queensland. *Kasslyn, Westbourne Road, Forest Hill, London, S.E., and The Athenæum Club, London, S.W.*
- 1882, Nov. 14. Herford, Rev. Brooke, D.D. 91, *Fitzjohn's Avenue, Hampstead, London, N.W.*
- 1859, Jan. 25. Le Jolis, Auguste François, Ph.D., Archiviste-perpétuel of the Société des Sciences Naturelles, *Cherbourg, Cherbourg.*

*Awards of the Wilde Medal under the conditions of the Wilde Endowment Fund.*

1896. Sir GEORGE G. STOKES, Bart., F.R.S.  
 1897. Sir WILLIAM HUGGINS, K.C.B., F.R.S.  
 1898. Sir JOSEPH DALTON HOOKER, G.C.S.I., C.B.,  
 F.R.S.  
 1899. Sir EDWARD FRANKLAND, K.C.B., F.R.S.  
 1900. Rt. Hon. LORD RAYLEIGH, F.R.S.  
 1901. Dr. ÉLIE METCHNIKOFF, FOR.MEM.R.S.  
 1903. Prof. FRANK W. CLARKE, D.Sc.

*Awards of the Dalton Medal.*

1898. EDWARD SCHUNCK, Ph.D., F.R.S.  
 1900. Sir HENRY E. ROSCOE, F.R.S.  
 1903. Prof. OSBORNE REYNOLDS, LL.D., F.R.S.

*Awards of the Premium under the conditions of the Wilde Endowment Fund.*

1897. PETER CAMERON.  
 1898. JOHN BUTTERWORTH, F.R.M.S.  
 1899. CHARLES H. LEES, D.Sc.  
 1900. Prof. A. W. FLUX, M.A.  
 1901. THOMAS THORP.

*THE WILDE LECTURES.*

1897. (July 2.) "On the Nature of the Röntgen Rays."  
By Sir G. G. STOKES, Bart., F.R.S. (28 pp.)
1898. (Mar. 29.) "On the Physical Basis of Psychological  
Events." By Sir MICHAEL FOSTER, K.C.B.,  
F.R.S. (46 pp.)
1899. (Mar. 28.) "The newly discovered Elements ;  
and their relation to the Kinetic Theory of  
Gases." By Prof. WILLIAM RAMSAY, F.R.S.  
(19 pp.)
1900. (Feb. 13.) "The Mechanical Principles of Flight."  
By the Rt. Hon. LORD RAYLEIGH, F.R.S.  
(26 pp.)
1901. (April 22.) "Sur la Flore du Corps Humain."  
By Dr. ÉLIE METCHNIKOFF, For.Mem.R.S.  
(38 pp.)
1902. (Feb. 25.) "On the Evolution of the Mental  
Faculties in relation to some Fundamental  
Principles of Motion." By Dr. HENRY WILDE,  
F.R.S. (34 pp., 3 pl.)
1903. (May 19.) "The Atomic Theory." By Professor  
F. W. CLARKE, D.Sc. (pp. 1—32.)
-









Memoirs & PROS. Lancheeste  
S.F. 2 1874

W. J. M.

AMNH LIBRARY



100125108