

U.S. Army Coast. Eng. Res. Ctr. Tech. Rep. REMR-CO-7
Ahrens

**REPAIR, EVALUATION, MAINTENANCE, AND
REHABILITATION RESEARCH PROGRAM**



**US Army Corps
of Engineers**

TECHNICAL REPORT REMR-CO-7

**METHODS TO REDUCE WAVE RUNUP AND
OVERTOPPING OF EXISTING STRUCTURES**

by

John P. Ahrens

Coastal Engineering Research Center

DEPARTMENT OF THE ARMY
Waterways Experiment Station, Corps of Engineers
PO Box 631, Vicksburg, Mississippi 39181-0631

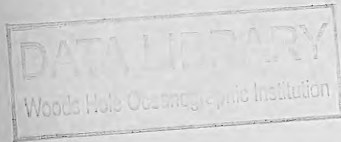

October 1988

Final Report

Approved For Public Release; Distribution Unlimited

TC
303
.1159
CO. REMR-
CO-7

Prepared for **DEPARTMENT OF THE ARMY**
US Army Corps of Engineers
Washington, DC 20314-1000

Under Civil Works Research Unit 32328

The following two letters used as part of the number designating technical reports of research published under the Repair, Evaluation, Maintenance, and Rehabilitation (REMR) Research Program identify the problem area under which the report was prepared:

<u>Problem Area</u>		<u>Problem Area</u>	
CS	Concrete and Steel Structures	EM	Electrical and Mechanical
GT	Geotechnical	EI	Environmental Impacts
HY	Hydraulics	OM	Operations Management
CO	Coastal		

Destroy this report when no longer needed. Do not return it to the originator.

The findings in this report are not to be construed as an official Department of the Army position unless so designated by other authorized documents.

The contents of this report are not to be used for advertising, publication, or promotional purposes. Citation of trade names does not constitute an official endorsement or approval of the use of such commercial products.

COVER PHOTOS:

TOP — Rib cap on breakwater at Hilo, Hawaii.

BOTTOM.— Waves overtopping seawall at Roughans Point, Mass.



Unclassified

SECURITY CLASSIFICATION OF THIS PAGE

Form Approved
OMB No 0704-0188
Exp. Date Jun 30, 1986

REPORT DOCUMENTATION PAGE

1a. REPORT SECURITY CLASSIFICATION Unclassified			1b. RESTRICTIVE MARKINGS		
2a. SECURITY CLASSIFICATION AUTHORITY			3. DISTRIBUTION / AVAILABILITY OF REPORT Approved for public release; distribution unlimited.		
2b. DECLASSIFICATION / DOWNGRADING SCHEDULE			4. PERFORMING ORGANIZATION REPORT NUMBER(S) Technical Report REMR-CO-7		
4. PERFORMING ORGANIZATION REPORT NUMBER(S) Technical Report REMR-CO-7			5. MONITORING ORGANIZATION REPORT NUMBER(S)		
6a. NAME OF PERFORMING ORGANIZATION USAEWES, Coastal Engineering Research Center		6b. OFFICE SYMBOL (if applicable)	7a. NAME OF MONITORING ORGANIZATION		
6c. ADDRESS (City, State, and ZIP Code) PO Box 631 Vicksburg, MS 39181-0631			7b. ADDRESS (City, State, and ZIP Code)		
8a. NAME OF FUNDING / SPONSORING ORGANIZATION US Army Corps of Engineers		8b. OFFICE SYMBOL (if applicable)	9. PROCUREMENT INSTRUMENT IDENTIFICATION NUMBER		
8c. ADDRESS (City, State, and ZIP Code) Washington, DC 20314-1000			10. SOURCE OF FUNDING NUMBERS		
			PROGRAM ELEMENT NO.	PROJECT NO.	TASK NO.
			WORK UNIT ACCESSION NO 32328		
11. TITLE (Include Security Classification) Methods to Reduce Wave Runup and Overtopping of Existing Structures					
12. PERSONAL AUTHOR(S) Ahrens, John P.					
13a. TYPE OF REPORT Final report		13b. TIME COVERED FROM Sep 84 TO Sep 86		14. DATE OF REPORT (Year, Month, Day) October 1988	15. PAGE COUNT 44
16. SUPPLEMENTARY NOTATION See reverse.					
17. COSATI CODES			18. SUBJECT TERMS (Continue on reverse if necessary and identify by block number)		
FIELD	GROUP	SUB-GROUP	Breakwaters Wave overtopping		
			Revetments Wave runup		
			Seawalls		
19. ABSTRACT (Continue on reverse if necessary and identify by block number)					
<p>Problems occurring on coastal structures related to wave runup and overtopping are identified and categorized. Three general problem areas include: wave runup and overtopping of breakwaters and jetties causing excessive wave action on the leese side, wave runup and overtopping of seawalls and bulkheads causing either flooding or erosion or both behind the structures, and wave runup and overtopping of revetments jeopardizing the integrity or possibly causing failure of the structure.</p> <p>A number of approaches to reducing wave runup and overtopping of coastal structures is presented. Plans to use laboratory model tests to quantify and refine the most promising approaches are discussed.</p>					
20. DISTRIBUTION / AVAILABILITY OF ABSTRACT <input checked="" type="checkbox"/> UNCLASSIFIED/UNLIMITED <input type="checkbox"/> SAME AS RPT. <input type="checkbox"/> DTIC USERS			21. ABSTRACT SECURITY CLASSIFICATION Unclassified		
22a. NAME OF RESPONSIBLE INDIVIDUAL			22b. TELEPHONE (Include Area Code)		22c. OFFICE SYMBOL

Unclassified

SECURITY CLASSIFICATION OF THIS PAGE

16. SUPPLEMENTARY NOTATION (Continued).

A report of the Coastal problem area of the Repair, Evaluation, Maintenance, and Rehabilitation (REMR) Research Program. Available from National Technical Information Service, 5285 Port Royal Road, Springfield, VA 22161.

Unclassified

SECURITY CLASSIFICATION OF THIS PAGE

PREFACE

This report was prepared as part of the Coastal Problem Area of the Repair, Evaluation, Maintenance, and Rehabilitation (REMR) Research Program. Initial work was conducted under Civil Works Research Work Unit 32328, "Techniques of Reducing Wave Runup and Overtopping on Coastal Structures."

Mr. William F. McCleese, US Army Engineer Waterways Experiment Station (WES) was overall manager of the REMR Research Program. The REMR Coastal Problem Area Technical Monitor was Mr. John H. Lockhart, Jr., Office, Chief of Engineers (OCE), and WES Coastal Problem Area Leader was Mr. D. D. Davidson, Coastal Engineering Research Center (CERC).

This work was conducted at WES during the period September 1984 to September 1986 under general supervision of Dr. James R. Houston and Mr. Charles C. Calhoun, Jr., Chief and Assistant Chief, respectively, CERC; and under direct supervision of Mr. C. E. Chatham, Jr., Chief, Wave Dynamics Division, and Mr. Davidson, Chief, Wave Research Branch (CW-R). Messrs. John P. Ahrens, Oceanographer, Dennis G. Markle, and Robert D. Carver, Lead Hydraulic Engineers, and various junior engineers and technicians of CW-R collected and organized information from Corps District offices which provided a significant contribution to this effort. This report was prepared by Mr. Ahrens, typed by Mrs. Myra Willis, Secretary, CW-R, and edited by Ms. Shirley A. J. Hanshaw, Information Technology Laboratory, Information Products Division, WES.

Commander and Director of WES during report publication was COL Dwayne G. Lee, CE. Technical Director was Dr. Robert W. Whalin.

CONTENTS

	<u>Page</u>
PREFACE.....	1
CONVERSION FACTORS, NON-SI TO SI (METRIC) UNITS OF MEASUREMENT.....	3
PART I: INTRODUCTION.....	4
PART II: WAVE RUNUP AND OVERTOPPING OF BREAKWATERS AND JETTIES CAUSING EXCESSIVE WAVE ACTION ON THE LEE SIDE.....	6
PART III: WAVE RUNUP AND OVERTOPPING OF SEAWALLS, SEA DIKES, AND BULKHEADS CAUSING FLOODING AND/OR EROSION.....	16
Methods to Reduce Wave Overtopping.....	21
Methods to Evaluate Effectiveness of Seawalls.....	32
PART IV: WAVE RUNUP AND OVERTOPPING OF REVETMENTS.....	34
PART V: SUMMARY AND CONCLUSIONS.....	37
REFERENCES.....	38
APPENDIX A: NOTATION.....	A1

CONVERSION FACTORS, NON-SI TO SI (METRIC)
UNITS OF MEASUREMENT

Non-SI units of measurement used in this report can be converted to SI (metric) units as follows:

<u>Multiply</u>	<u>By</u>	<u>To Obtain</u>
feet	0.3048	metres
inches	25.4	millimetres
pounds (mass)	0.4535924	kilograms
pounds (mass) per cubic foot	16.01846	kilograms per cubic metre
square feet	0.09290304	square metres

METHODS TO REDUCE WAVE RUNUP AND OVERTOPPING
OF EXISTING STRUCTURES

PART I: INTRODUCTION

1. Repair, Evaluation, Maintenance, and Rehabilitation (REMR) field visits conducted by the Wave Research Branch have yielded an enormous amount of information about the status of US Army Corps of Engineers (Corps) coastal structures. Summarizing this information into a coherent account requires a series of nine case history reports, one for each Corps division having ocean or Great Lakes coastline. This effort has identified approximately four hundred structures as having problems of varying type and severity caused by wave action. Over 20 percent of the structures have problems caused by wave runup and overtopping.

2. These problems can be divided roughly into three general problem areas:

- a. Wave runup and overtopping of breakwaters and sometimes jetties generating excessive wave action on the lee side. Generally, this problem is compounded by additional wave transmission through rubble mounds.
- b. Wave runup and overtopping of seawalls, bulkheads, and sea dikes causing flooding and/or erosion on the backside.
- c. Wave runup and overtopping of revetments causing backside subsidence, erosion, and sometimes collapse of the revetment. On reservoirs overtopping of a revetment may cause damage to the upstream dam face or to an embankment.

3. There is no single comprehensive source of information evaluating methods to calculate wave runup or effectiveness of various strategies to reduce runup and overtopping. The most definitive single reference on runup (Battjes 1974) was prepared for the Technical Advisory Committee on Protection Against Inundation of the Dutch Government. Allsop, Franco, and Hawkes (1985) provide an excellent literature review on wave runup and steep slopes. Some methods used to reduce wave overtopping of seawalls in Japan are discussed by Goda (1985). Douglass (1986) compares four relatively common methods to calculate irregular wave overtopping rates. References given above, along with the Shore Protection Manual (SPM) (1984), provide a broad background of information on how to compute wave runup and overtopping.

4. In the next section each of the three general problem areas will be discussed. Existing methods to repair or rehabilitate coastal structures to alleviate or eliminate problems caused by wave runup and overtopping will be presented. New methods which in most cases lend themselves to computer assistance will build on existing field expertise. Much of the existing information is oriented toward new construction rather than rehabilitation so existing methods need to be modified and will require additional laboratory work to calibrate the new approach relative to existing structures.

PART II: WAVE RUNUP AND OVERTOPPING OF BREAKWATERS AND JETTIES
CAUSING EXCESSIVE WAVE ACTION ON THE LEE SIDE

5. Numerous methods have been developed to estimate transmitted wave heights on the lee side of rubble-mound and caisson structures. Most of the methods suffer from one or more of the following limitations:

- a. They are so highly idealized that they are not useful for solving "real world" problems.
- b. They are applicable to only part of the problem, i.e., they only consider the wave energy transmitting through the structure or only consider wave transmission by overtopping.
- c. They are inherently so complex that they are difficult to use and understand; lack of understanding undermines confidence and makes it difficult to evaluate results.

Another problem common to all approaches is that they were not developed to help guide repair or rehabilitation efforts. As an example, Fuchs' equation (Johnson, Fuchs, and Morison 1951) could potentially be used to estimate the breakwater's crest height required to reduce wave transmission to a desired level. In principle this calculation would provide an estimate of the amount of repair necessary to rebuild the crest height high enough to reduce transmission to an acceptable level. However, Fuchs' equation is only applicable to submerged structures and then treats them like a plate so that the influence of the width or permeability cannot be investigated. Still Fuch's equation, like a number of other highly idealized approaches to estimating wave transmission, provides useful conceptual insight if not solutions to real problems. In the following discussion a less idealized transmission model will be used to illustrate how a model might be used to guide repair or rehabilitation work to reduce wave transmission.

6. Findings from a research study of low-crested breakwaters will be used as an example of how a wave transmission model might be applied to rehabilitation efforts. The transmission model was developed by Ahrens (1986) to predict the transmission of wave energy over and through reef breakwaters. Advantages of this model are that it:

- a. Was developed from a large number of laboratory tests having a wide range of irregular wave conditions.
- b. Can be used for both submerged and subaerial rubble mounds.
- c. Accounts for wave transmission both over and through the structure.

- d. Considers the influence of a large number of variables on wave transmission.
- e. Is simple and easy to use and does not require a large computer.
- f. Is consistent with the physics of wave transmission as currently understood.

One disadvantage of the model is that it was developed for breakwaters without a traditional multilayer cross section; therefore, the model would probably tend to overpredict the amount of energy transmitted through a traditional rubble-mound structure. Another disadvantage is that the model was not specifically designed to provide guidelines for rehabilitation. Despite these limitations, the model provides a good starting point approach for a REMR model and can demonstrate the potential that a model based on laboratory tests can have in indicating the extent to which repairs or rehabilitation will reduce wave transmission over and through a rubble structure.

7. To use the reef breakwater transmission model to predict either the transmission coefficient or the transmitted wave height, the following information is required: the incident zero-moment wave height H_{mo} *; the period of peak energy density of the incident wave spectrum T_p ; the crest height of the reef h_c ; the water depth the reef is sited in d_s ; the cross-sectional area of the reef breakwater A_T ; the median stone weight used in the reef breakwater, W_{50} ; and the unit weight of the stone w_r (Figure 1). Since all of this information is required it means that the influence of all of

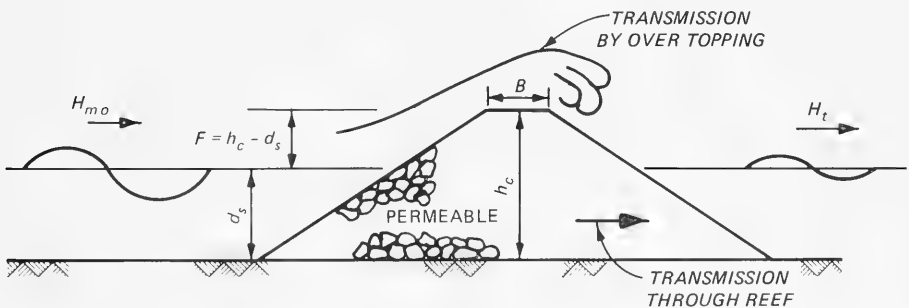

Figure 1. Definition sketch for wave transmission over and through a reef breakwater

* For convenience, symbols and abbreviations are listed in the Notation (Appendix A).

these variables on wave transmission can be investigated and that the model is realistic in recognizing that all of these variables play a role in the transmission process.

8. At this point it is necessary to consider how the model might be used to evaluate potential repair or rehabilitation strategies. Figure 2

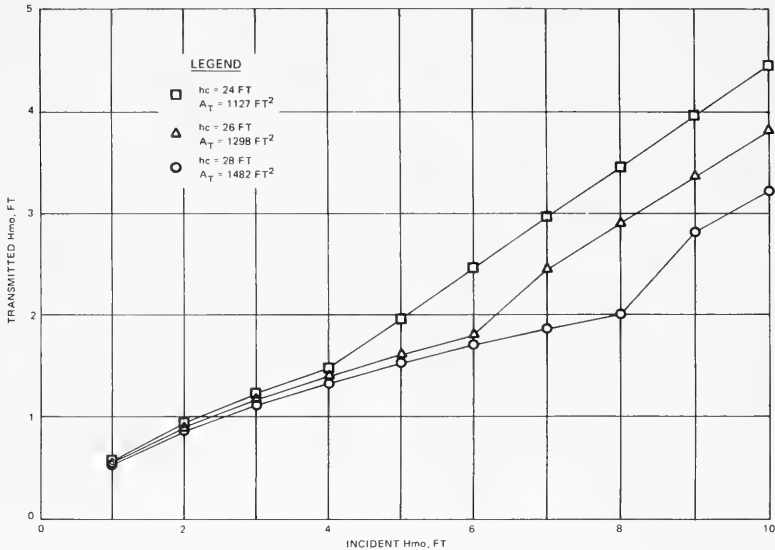

Figure 2. Transmitted wave height versus incident wave height for reef breakwaters, in a water depth of 20 ft, exposed to incident wave spectrum with period of peak energy density of 8.0 sec

shows the transmitted wave height versus the incident wave height for reef breakwaters in 20 ft* of water with crest heights of 24, 26, and 28 ft respectively, the period of peak energy density of the incident spectrum being 8.0 sec and the stone having a median weight of 5,000 lb with a unit weight of 165 lb/ft³. The three different crest heights shown in Figure 2 could be regarded as representing three different states of repair of the same breakwater such as the initial, deteriorated, and severely deteriorated, respectively. If the crest height of 24 ft represents the current state of the structure, then the reduction in transmitted wave height that can be achieved

* A table of factors for converting non-SI units of measurement to SI (metric) units is presented on page 3.

by rehabilitating the structure to crest heights of 26 and 28 ft can be readily estimated. Although the model was not developed for this particular use, data in Figure 2 logically indicate that the model is providing reasonable trends. For small incident wave heights the transmitted wave height increases at a decreasing rate, indicating that when transmission is entirely through the structure the transmission coefficient decreases with increasing wave steepness. The highest structure has the lowest transmitted wave height since it has the largest cross-sectional area which attenuates most of the wave energy passing through. As the incident wave height increases, a point is reached ($H_{mo} = 5.0$ ft) where the lowest reef (most severely deteriorated) experiences significant overtopping which causes the transmitted height for this structure to increase, abruptly breaking away from the trend for the two higher structures which have little or no overtopping at this wave height. At an incident wave height of 7.0 ft, significant overtopping occurs on the reef breakwaters with crest heights of 24 and 26 ft, and transmission trends have gone well above the trend for the reef with a crest height of 28 ft which has yet to experience significant overtopping. By comparing the transmission trends for the various crest heights, it is easy to evaluate the potential benefits of rehabilitating the crest of the structure. It should be emphasized that the data trends shown in Figure 2 as well as the trends to be shown in Figures 3, 4, 5, and 6 are not observed data but are generated by a mathematical model based on physical model tests (Ahrens 1987).

9. Figure 3 shows trends generated by the reef transmission model similar to those shown in Figure 2, except that the period of peak energy density of the incident wave spectrum was changed from 8.0 to 12.0 sec to illustrate the influence of wave period on transmission. As shown in Figure 3, the longer period tends to transmit through the structure better, and when the mode of transmission shifts at the higher incident wave heights to being dominated by overtopping, the longer period waves transmit more energy by this mode too. This occurrence leads to higher transmitted waves in Figure 3 for $T_p = 12.0$ sec compared to the transmitted waves in Figure 2 for $T_p = 8.0$ sec for all incident wave heights.

10. The reef transmission model was used to generate another set of data similar to those in Figure 2 except that the median stone weight was changed from 5,000 to 8,000 lb. These results are shown in Figure 4. If Figure 4 is compared to Figure 2, it can be seen that when transmission is primarily

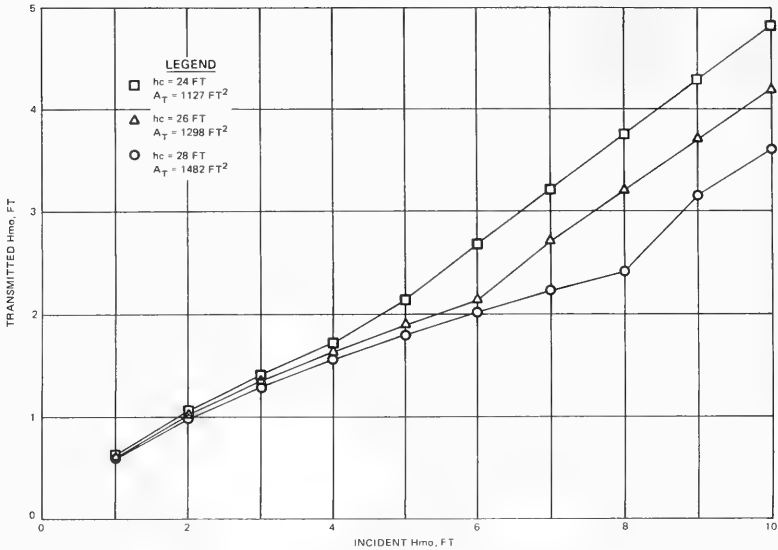

Figure 3. Transmitted wave heights versus incident wave height for reef breakwaters, in water depth of 20 ft, exposed to incident wave spectrum with period of peak energy density of 12.0 sec

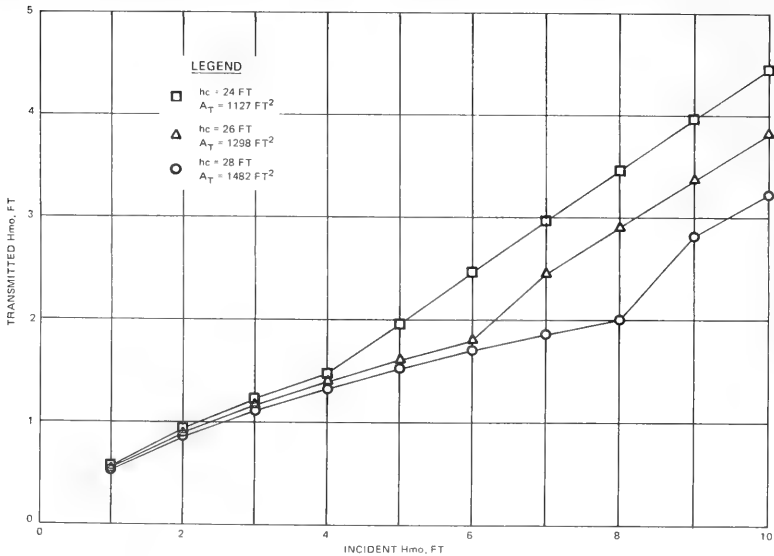

Figure 4. Transmitted wave heights versus incident wave height for reef breakwaters, in water depth of 20 ft, exposed to incident wave spectrum with period of peak energy density of 8.0 sec

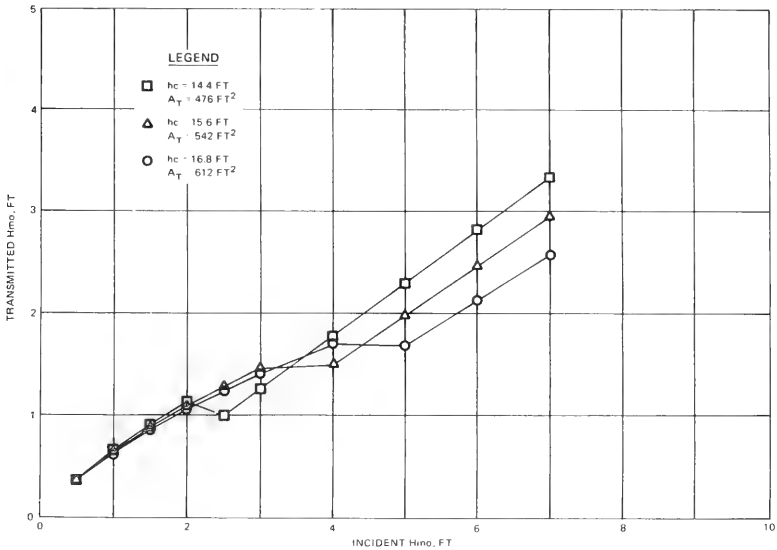

Figure 5. Transmitted wave height versus incident wave height for reef breakwaters, in water depth of 12.0 ft, exposed to incident wave spectrum with period of peak energy density of 8.0 sec

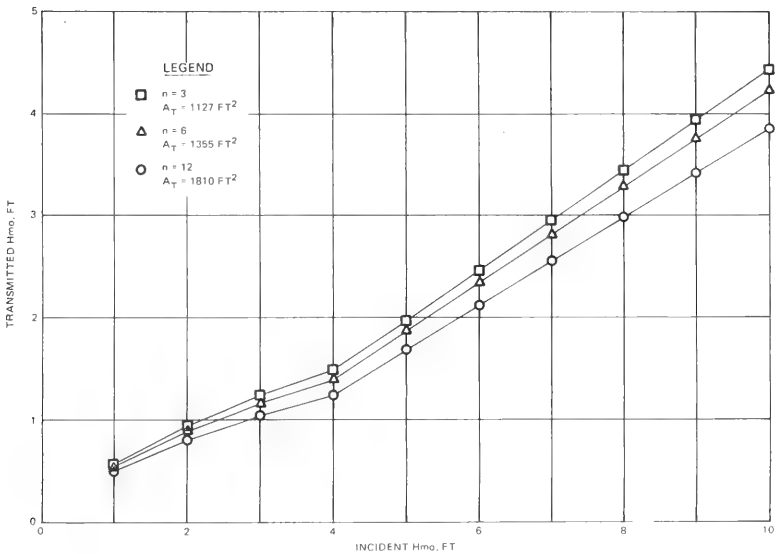

Figure 6. Transmitted wave heights versus incident wave height for reef breakwaters, in water depth of 20 ft, exposed to incident wave spectrum with period of peak energy density of 8.0 sec

through the structure that the transmitted wave heights are slightly higher for the reef breakwater with 8,000-lb stone than the reef with 5,000-lb stone. This comparison illustrates that larger stones create larger void spaces which allows slightly higher transmission through the structure (all other factors being equal). When transmission is dominated by overtopping, the transmitted wave heights are about the same.

11. Figure 5 uses the reef transmission model with wave conditions and stone size the same as those in Figure 2 but with a water depth reduced from 20 to 12 ft and the crest heights of the reefs reduced in proportion to the water depths. Comparison of Figures 2 and 5 indicates that the wave transmission is slightly greater for a reef in a 12-ft water depth than it is for a reef in a 20-ft water depth because the cross-sectional area of the structure has been reduced more in changing from a water depth of 20 to 12 ft than the reduction in wave length. The cross-sectional area of the structure is important both for transmission through the reef and for transmission by overtopping. A wider structure is more effective in reducing transmission than a narrower reef breakwater with the same height. Since it might be easier to rehabilitate a structure by increasing the width rather than by increasing the height to achieve a desired level of transmission, this approach is explored using the reef transmission model in Figure 6. Figure 6 has the same wave conditions and stone size as used for Figure 2, but in Figure 6 only one crest height of 24 ft is shown having three different cross-sectional areas. The various cross-sectional areas were obtained by using crest widths of 3, 6, and 12 stone diameters which give cross-sectional areas for the reef of 1,127, 1,355, and 1,810 ft², respectively. In Figure 2 the reef with a crest height of 28 ft (the lowest transmission trend) has a cross-sectional area of 1,482 ft². Comparison of Figures 2 and 6 shows that the reef with a height of 28 ft and a cross-sectional area of 1,482 ft² allows less wave transmission than the reef with a crest height of 24 ft and a cross-sectional area of 1,810 ft. The comparison suggests that it is more effective to reduce transmission by repairing the reef's crest than increasing its width. Of course, other factors would have to be considered such as the relative difficulty of increasing the crest height versus increasing the cross-sectional area without increasing the crest height.

12. An example of the reef transmission model applied to an existing structure is furnished by the wave transmission occurring at Burns Harbor,

Indiana, on Lake Michigan. Burns Harbor frequently experiences greater than desirable wave action in the harbor. Transmission by overtopping has increased because of high lake levels in 1985 and 1986, and transmission through the structure appears to be high due to the large size of the stone used in the armor. Unless special placement of the armor is used, large armor stone leave large void spaces, allowing greater wave transmission through the breakwater. Ahrens (1987) provides a quantitative relation for this occurrence. Figure 7 shows wave transmission caused by a storm at Burns Harbor and predicted wave transmission using the reef breakwater transmission model. Figure 8 shows wave action at the Burns Harbor breakwater generating transmitted waves in the harbor. Predicted transmission using the model is greater than the observed transmission since the reef transmission model was developed from physical model tests of very permeable rubble mounds with no core. However, the model follows the trend of the observed data quite well.

13. A physical method developed within the US Army Engineer Division, Pacific Ocean, to cope with crown stability and overtopping during heavy wave overtopping of rubble mounds is a ribbed concrete cap. Concrete armor units key into the ribs and improve the stability of the crest, and the presence of the ribs adds resistance to wave overtopping flow thereby reducing transmission (Markle 1982 and Markle and Herrington 1983). Figure 9 shows the concrete rib cap on the breakwater at Hilo, Hawaii. The reef transmission model is not applicable to concrete cap breakwaters without further experimental work.

14. Figures 2 through 7 give a rough idea of the value of a rather simple wave transmission model which was developed from conceptual ideas and calibrated and refined through the use of physical model tests. The reef transmission model makes it very easy to investigate the influence of a variety of variables on the transmitted wave height. Further, the model could be used to project how the deterioration of a rubble structure might affect wave transmission or how various rehabilitation concepts would improve the transmission characteristics of the structure. The reef transmission model was not intended as a rehabilitation tool, and many of the examples shown were using the model outside the range of calibration, i.e. outside the range of conditions of the laboratory tests. However, the model provides logical trends in Figures 2 through 7, even outside the range of calibration, because of improved understanding of the wave transmission process (Ahrens 1987). In developing a

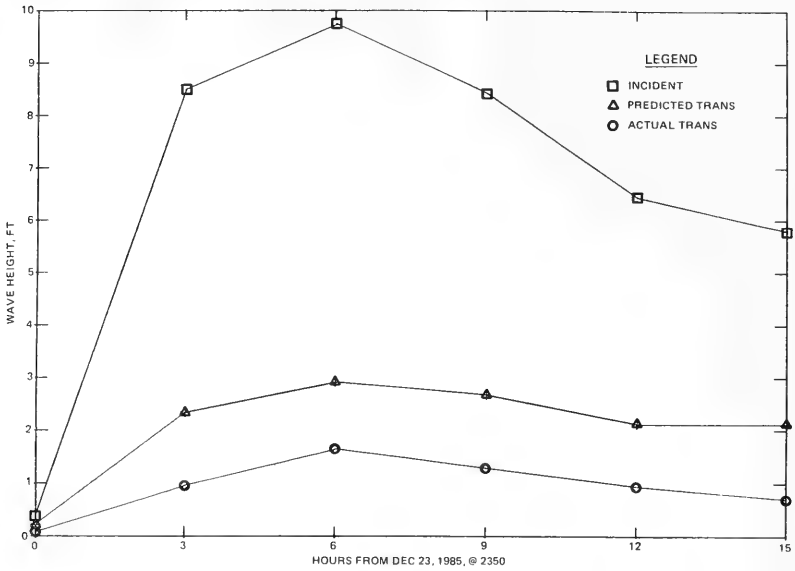

Figure 7. Incident and transmitted wave heights
Burns Harbor, Indiana



Figure 8. Wave action against breakwater at
Burns Harbor, Indiana, April 1986



Figure 9. Rib cap on breakwater at Hilo, Hawaii

wave transmission model for REMR use, the reef transmission model will provide a logical starting point. There are numerous other approaches and models for wave transmission which can provide insight for improving the reef model and adapting it for REMR use. Some of the most important sources of additional information are Calhoun (1971), Goda (1969, 1985), Keulegan (1973), Madsen and White (1976), Sollitt and Cross (1976), Johnson, Fuchs, and Morison (1951), Thornton and Calhoun (1972), and Seelig (1980). The work of these investigators and others to be identified should be coupled with proposed laboratory tests specifically oriented toward REMR objectives to provide improved guidance on methods to reduce wave transmission by overtopping.

PART III: WAVE RUNUP AND OVERTOPPING OF SEAWALLS, SEA DIKES,
AND BULKHEADS CAUSING FLOODING AND/OR EROSION

15. The approach to be used in this section will be to build on the findings made during the recent model study of wave overtopping of the Roughans Point seawall and subsequent model tests of the Cape Hatteras and Virginia Beach seawalls, (Ahrens, Heimbaugh, and Davidson 1986). Other sources of information such as that by Douglass (1986), the extensive study of seawalls and sea dikes conducted at the Hydraulic Research Station, Wallingford, England, and research at the Port and Harbor Research Institute, Yokosuka, Japan, will be investigated. Important recent foreign references are Owen (1982a, 1982b) and Goda (1985).

16. Findings from the Roughans Point and Cape Hatteras seawall tests will be summarized here because they are a starting point for study of this general problem area, and they provide a conceptual framework for further progress in developing strategies for reducing wave overtopping of seawalls and related coastal structures. The primary purpose of the Roughans Point study was to conduct laboratory tests to determine the overtopping rates for various seawall/revetment configurations. This information will be used to develop a cost-effective plan to reduce flooding due to wave overtopping in the community of Roughans Point, Massachusetts (Hardy and Crawford 1986). Additional Cape Hatteras seawall tests were conducted to extend the findings made during the Roughans Point study to somewhat different seawall profiles, including severely recurved and vertical walls. One of the most important findings from the Roughans Point study was that all of the overtopping data for a revetment/seawall configuration could be consolidated into a single, well defined trend through the use of a new dimensionless freeboard parameter. This parameter seems to be effective even for test series that included several or more water levels and a wide range of irregular wave conditions. The new freeboard parameter F' is defined as follows:

$$F' = \frac{F}{\left(\frac{H_{mo}^2 L}{p} \right)^{1/3}} \quad (1)$$

where

F = freeboard of the structure, $h_c - d_s$
 h_c = crest height of the seawall
 d_s = still-water depth at the toe of the wall or the toe of the
 revetment fronting the wall
 L_p = Airy wave length calculated using d_s and T_p
 H_{mo} = incident zero moment wave height at or near the toe of the
 structure

Equation 1 can be thought of as the ratio of the freeboard to the severity of the local incident wave conditions.

17. A very valuable characteristic of the freeboard parameter is that it combines a lot of information about the structure, water depth, and wave conditions into one variable. The parameter F' has higher correlation with the overtopping rate for the Roughans Point data than any other parameter which could be identified, including the parameter F/H_{mo} , suggested by the work of Goda (1969) and Seelig (1980) or the dimensionless freeboard parameter $F/(T_z^2 g H_s)$ used by Owen (1982b), where T_z is the zero-crossing wave period, g is the acceleration of gravity and, H_s is the significant wave height of the spectrum. Figure 10 shows a plot of the overtopping rate as a function of

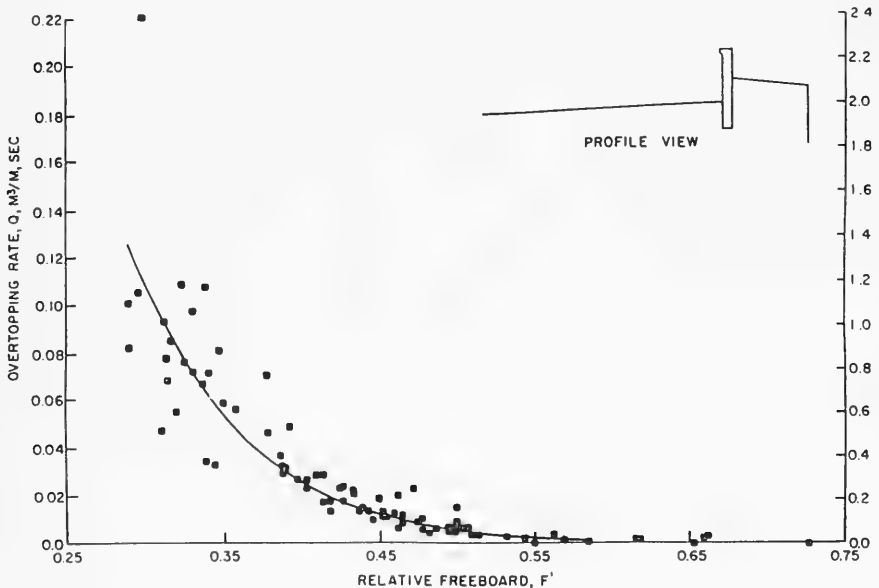

Figure 10. Overtopping rate versus relative freeboard for the Roughans Point seawall with no revetment (configuration RP-1)

F' for the existing seawall configuration at Roughans Point without a riprap revetment protecting the wall. Considering the complexity of the irregular wave overtopping process, the ability of F' to consolidate the overtopping data into a well-defined trend is surprising.

18. A simple exponential model using F' was found to be very useful for evaluating the overtopping performance of a seawall/revetment configuration or for comparing the performance of two or more configurations. The model can be written

$$Q = Q_0 \exp (C_1 F') \quad (2)$$

where Q_0 is a coefficient with the same units as the overtopping rate, i.e., volume per unit time per unit length of seawall crest, and C_1 is a dimensionless coefficient. Both Q_0 and C_1 are determined by the data for a particular seawall/revetment configuration either by regression analysis or occasionally by subjective curve fitting, if that seems more appropriate. A regression curve fit to the data using Equation 2 is shown in Figure 10. Since a regression equation of the form of Equation 2 tends to reduce the influence of the conditions with high overtopping rates, as compared to a linear equation, it was sometimes convenient to subjectively fit an equation of the form of Equation 2 to obtain a better fit to the data having high overtopping rates. In Figure 11, a comparison is shown between a regression curve and a subjectively fit curve for a seawall with a 1.0-ft cap fronted by a revetment with a berm. In Figure 11 the nonregression curve fits the data with high overtopping rates better than the regression curve. For many configurations, the regression curves seem quite satisfactory, but for some cases, a nonregression curve provides a more conservative trend which would be preferable for design purposes. Possibly a more suitable approach would be to use an equation with the form of Equation 2 with a weight function proportional to either the overtopping rate or F'. In any event the form of Equation 2 fits the data well and is similar to the form used by Owen (1982b) in a study on irregular wave overtopping of sea dikes. Data trend curves of the form of Equation 2 provide a simple way to evaluate the effectiveness of various seawall/revetment configurations, i.e, the less area under the curve the more effective the configuration is at reducing overtopping.

19. The various seawall/revetment configurations discussed in this

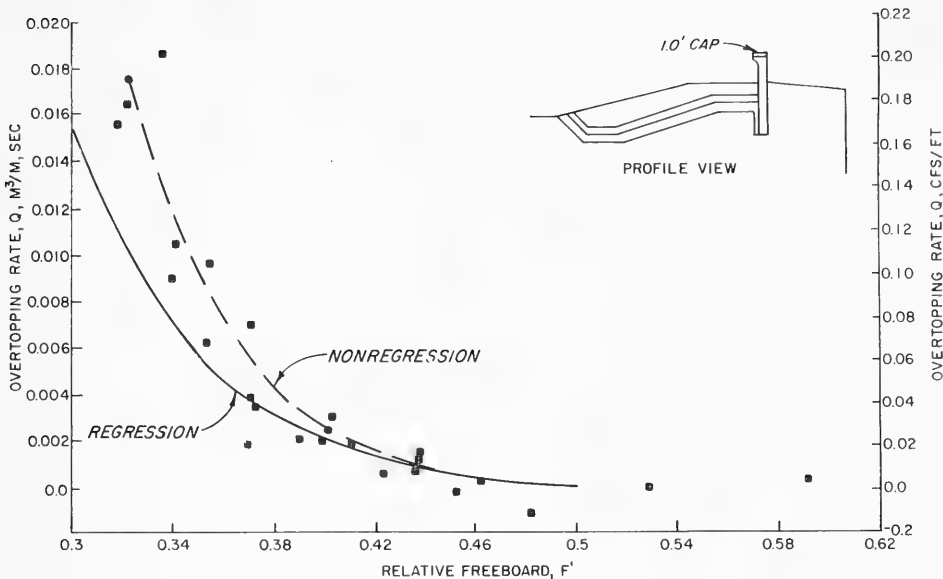

Figure 11. Overtopping rate versus relative freeboard for the Roughans Point seawall fronted by a wave absorber revetment with a berm and a 1.0-ft cap on wall (configuration RP-7)

report are listed in Table 1. Table 1 also gives the value of the overtopping coefficients used in Equation 2 and an overtopping rating coefficient for the configuration (to be discussed later). For the Roughans Point seawall tests the number in the designation is consistent with the configuration number given by Ahrens, Heimbaugh, and Davidson (1986).

20. Onshore winds can increase the overtopping rate by blowing spray over the seawall or by wind stress on the runup mass on sloped structures. If a seawall is being heavily overtopped by "green water," the additional amount carried over the crest by wind effects is probably not important. However, the portion of overtopping contributed by wind can be expected to increase as the proportion of waves overtopping the wall decreases. The only quantitative guidance on wind effects is in the SPM (1984). A recent brief study* suggests

* "Assessment of Wind Effects on Wave Overtopping of Proposed Virginia Beach Seawall," Memorandum from Donald T. Resio to Joan Pope, Coastal Engineering Research Center, US Army Engineer Waterways Experiment Station.

Table 1

Seawall Revetment Configurations and Coefficients

Study Configuration No.*	Description	Overtopping Coefficients		Hydraulic Rank Parameter
		Q_o (cfs/ft)	C_1	A_q (cfs/ft)
RP-1	Seawall with no fronting revetment	76.55	-14.08	0.0797
RP-2	Seawall fronted by a standard riprap revetment	30.54	-13.43	0.0404
RP-4	Seawall fronted by a wide berm, absorber revetment	439.22	-21.62	0.0310
RP-7	Seawall fronted by a wide berm, absorber revetment, cap on wall	305.82	-23.07	0.0131
RP-8	Seawall fronted by a wide berm, absorber revetment, double cap on wall	93.04	-22.15	0.0055
CH-1	Severely recurved wall with extensive toe protection	394.62	-20.68	0.0386
CH-2	Moderately recurved wall with extensive toe protection	93.25	-14.75	0.0757
CH-3	Vertical wall with extensive toe protection	8.80	-6.33	0.2078

* RP indicates Roughans Point seawall (Ahrens, Heimbaugh, and Davidson 1986).
CH indicates Cape Hatteras seawall (Grace and Carver 1985).

correction given in the SPM overestimates the amount of water carried over the wall by wind.

Methods to Reduce Wave Overtopping

Recurved walls

21. One method to reduce wave overtopping is to use a recurved wall instead of a vertical wall. The Roughans Point seawall is vertical with a small recurve at the crest. Observations indicate that the recurve is effective when the waves are small enough and the water depth at the wall great enough to allow a reasonably coherent standing wave system to be established. This system causes a vertical flow regime at the wall which is thrown seaward by the recurve (Figure 12). The recurve is not effective when the crest



Figure 12. Wave overtopping the seawall at
Roughans Point, Massachusetts

height of the incident wave approaches the elevation of the crest of the seawall because the large, partial clapotis which forms for a moment in front of the wall then spills over in large volumes of "green" water literally inundating the seawall for a short time.

22. For the inundation mode it is difficult to envision how any surface feature of the wall could be very effective in reducing the overtopping rate. For tests conducted in the Roughans Point study, the inundation mode of overtopping occurred frequently when F' was less than 0.3. Thus, comparisons of

the data trends for F' less than 0.3 were not made and would probably not be meaningful.

23. Data analysis of the seawall/revetment configurations referred to as the Cape Hatteras types is in a preliminary stage. This test series includes both vertical and recurved seawalls which have rather extensive revetment toe protection (Figure 13). Overtopping data trend curves of the form of Equation 2 are used in Figure 14 to compare the performance of the three Cape Hatteras seawall/revetment configurations. The poor performance of the vertical seawall compared to the walls with recurvature is clearly shown in Figure 14. Figures 15 and 16 show laboratory tests of the Cape Hatteras seawalls with a typical curve and a vertical wall, respectively, that illustrate the considerable difference in wave action that can occur at the wall for different structure geometries. It can be seen in Figure 14 that the wall with severe recurvature is somewhat better than the wall with more moderate recurvature. In Figure 17, the overtopping trend curves for the Roughans Point seawall profile shown in Figure 10 are compared to those for the vertical wall Cape Hatteras profile shown in Figure 13. Figure 17 indicates that even a rather small recurve can be effective since the Roughans Point overtopping trend curve falls considerably below the corresponding curve for the vertical Cape Hatteras seawall configuration. Figures 14 and 17 illustrate the value of the overtopping model, defined by Equations 1 and 2, for evaluating the performance of a single configuration and for making comparisons between and among configurations. It should be noted that Equation 2 does not take into account water blown over the wall by onshore winds which are usually present during overtopping conditions. Therefore, a recurve which throws water seaward and possibly even downward will control windblown overtopping better than a vertical wall that throws the water straight upward. Figure 18 shows how energetic wave action can send large quantities of spray to impressive heights when waves encounter a steep barrier. Figure 18 was taken at Neach Bay, Washington, with long-period waves propagating shoreward from the Strait of Juan de Fuca and crashing against a riprap revetment with a slope of 1 on 2.

Fronting rubble and revetments

24. A second method to reduce wave overtopping rates is to use rubble in front of the wall. The purpose of the rubble might be toe protection, but if enough rubble is used, the dissipation of wave energy will be sufficient to reduce wave overtopping. The extensive toe protection used for the

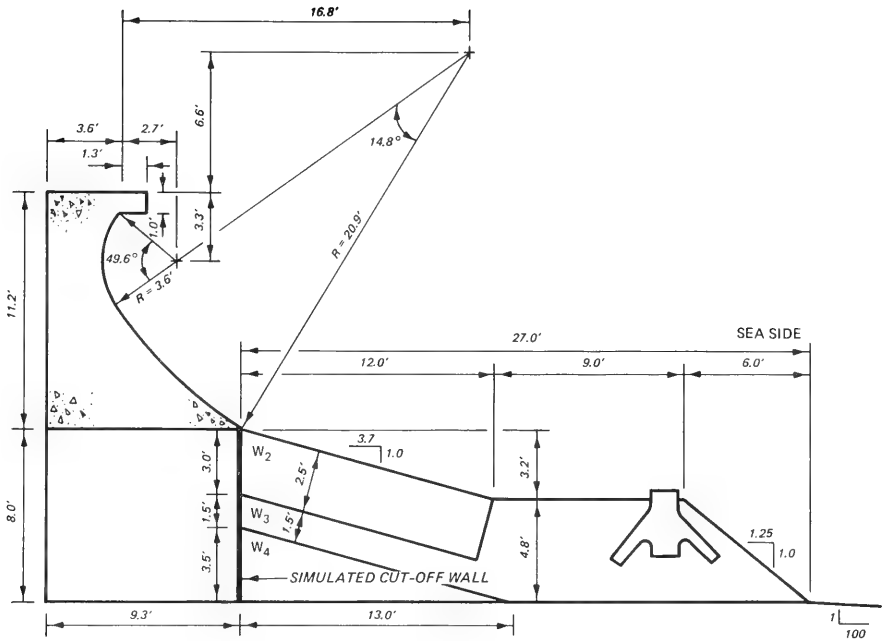

a. Configuration designation CH-1

Figure 13. Cape Hatteras seawall configurations (Continued)

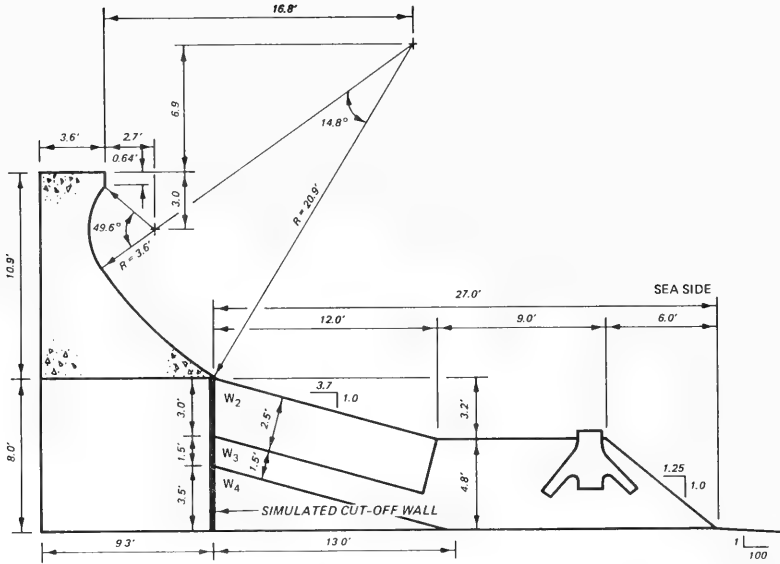

b. Configuration designation CH-2

MATERIAL CHARACTERISTICS

MODEL	PROTOTYPE
W ₁ - 0.37-LB STAPODS AT 167 PCF	W ₁ = 0.86-TON STAPODS AT 150 PCF
W ₂ = 0.71-LB STONE AT 165 PCF	W ₂ = 1.6-TON STONE AT 165 PCF
W ₃ = 0.28-LB STONE AT 165 PCF	W ₃ = 0.65-TON STONE AT 165 PCF
W ₄ = 0.01-LB STONE AT 165 PCF	W ₄ = 46-LB STONE AT 165 PCF

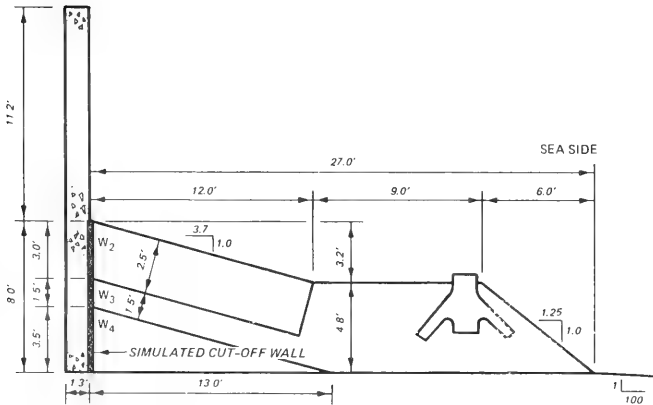

c. Configuration designation CH-3

Figure 13. (Concluded)

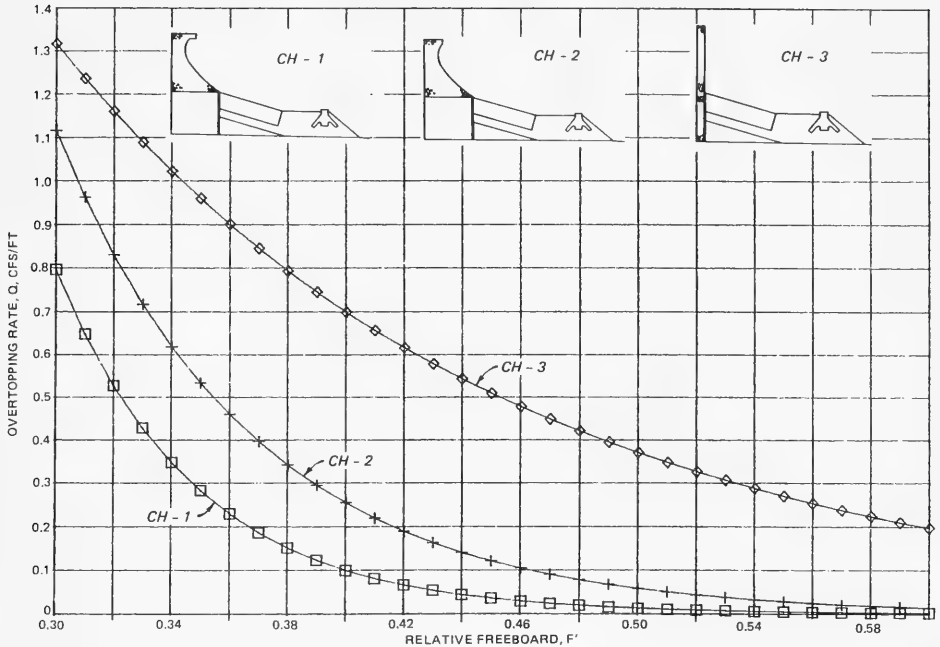

Figure 14. Comparison of overtopping trend curves for the three Cape Hatteras seawall/revetment configurations (CH-1, CH-2, and CH-3)

Cape Hatteras seawall provides an illustration of the effectiveness of toe protection rubble in reducing overtopping of the wall. Figure 19 shows overtopping data for the Cape Hatteras profile with a vertical wall. A number of the data points fall conspicuously below the overtopping trend established by regression analysis. Analysis of the data indicates that these points are all associated with the lowest water level tested. Since the dimensionless freeboard defined by Equation 1 takes the water level into consideration, data collected at all water levels should all follow the same trend in figures like Figure 19 unless there is a strong influence from another factor. Additional analysis indicates that when there is relatively shallow water over the rubble toe protection the rubble is quite effective in dissipating wave energy and reducing wave overtopping even when the wall is vertical. However, there appears to be a point when a small increase in water depth will make the toe protection rubble much less effective in reducing overtopping. This effect is demonstrated in Figure 19 where the data collected at the lowest water level

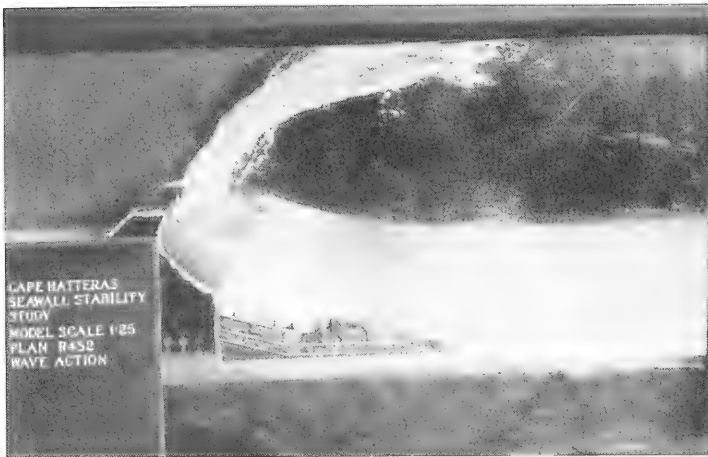

Figure 15. Laboratory tests of wave action against a Cape Hatteras seawall with a moderate recurve

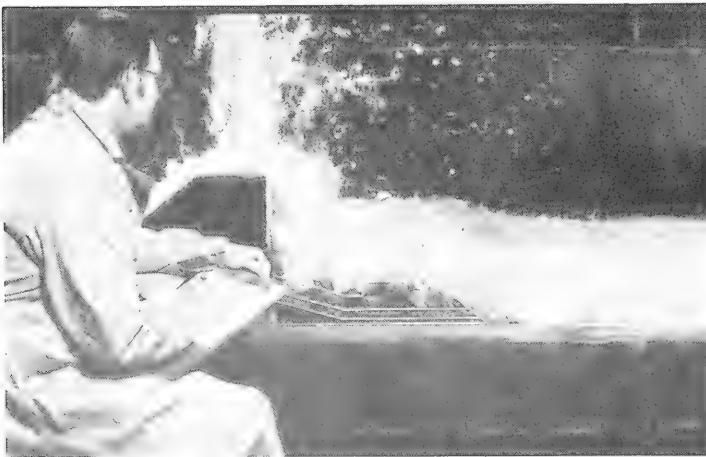

Figure 16. Laboratory tests of wave action against a Cape Hatteras seawall, vertical configuration

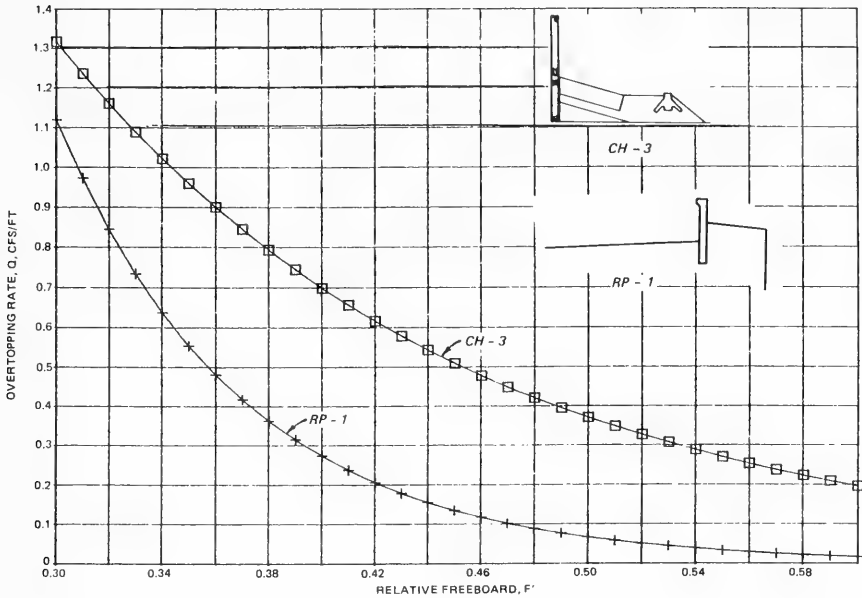

Figure 17. Comparison of overtopping trend curves for the Roughans Point seawall with no revetment (configuration RP-1) and the Cape Hatteras vertical seawall (configuration CH-3)

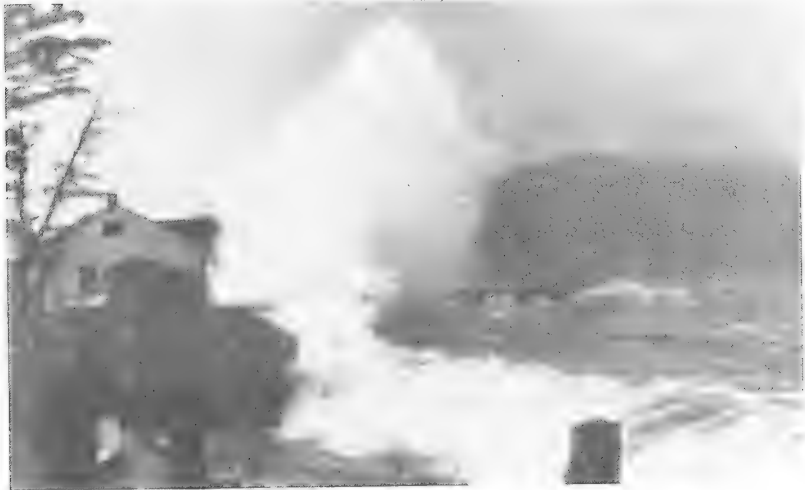

Figure 18. Storm wave action against a revetment at Nesh Bay, Washington, Nov 1948

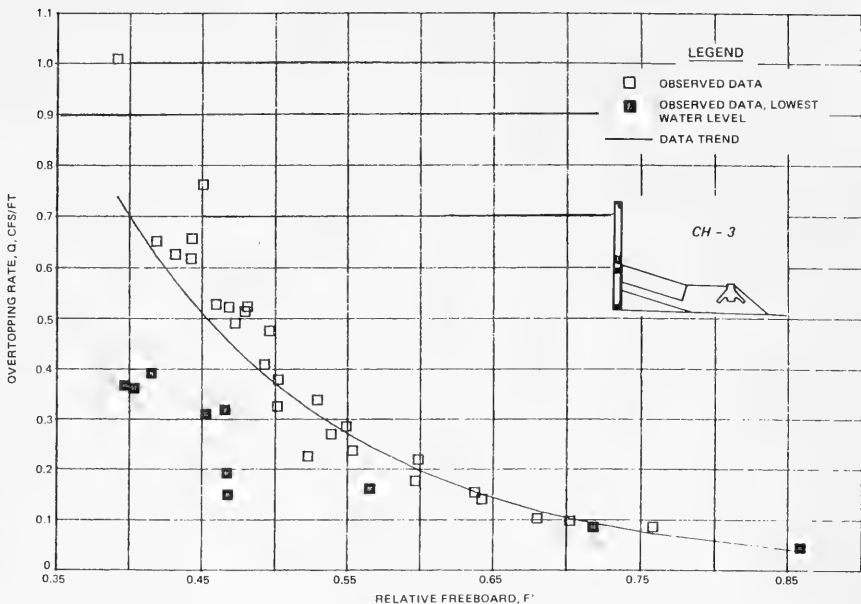

Figure 19. Overtopping rate versus the relative freeboard for the Cape Hatteras vertical seawall (configuration CH-3)

are shown with shaded symbols which follow a trend distinctly lower than that from the data collected at two slightly higher water levels.

25. During the Roughans Point study, a standard multilayered riprap revetment was built against the seawall with the top of the revetment near the top of the wall just below the recurve. The revetment reduced the overtopping rates by about 45 percent over the same seawall configuration without a revetment. Figure 20 shows a comparison of the performance of the two configurations using data trend curves developed from regression analysis. Standard riprap revetment was found to be less effective in reducing overtopping than was originally thought. Two possible reasons for the disappointing performance of the riprap were identified:

- a. When the water levels are high, waves ride over most of the revetment without much attenuation.
- b. When water levels are low, the standard revetment provides a ramp for waves to ride up and over the wall without encountering a major discontinuity to their flow.

The second factor suggests that it might be better not to build the revetment very high against the wall but to use a profile having a berm. This type of

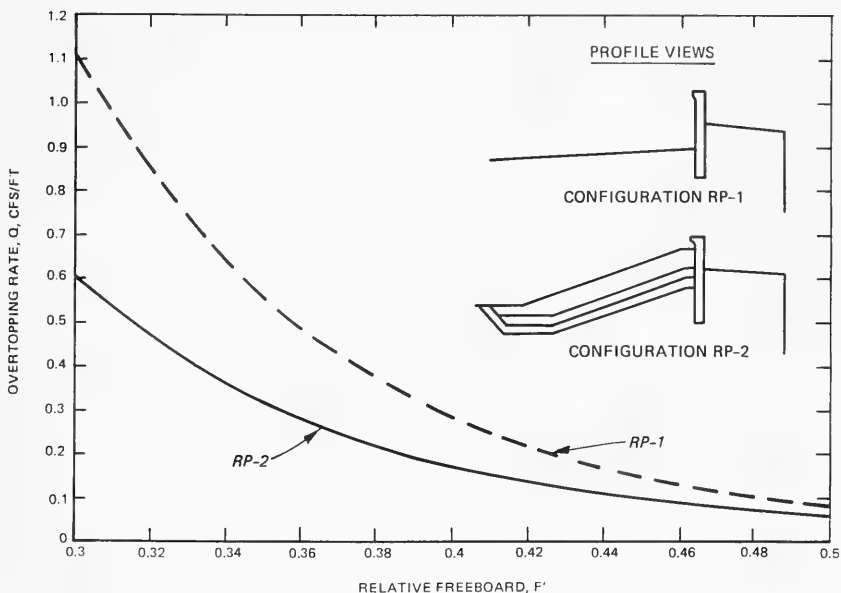

Figure 20. Comparison of overtopping trend curves for the Roughans Point seawall with no revetment (configuration RP-1) and the same seawall fronted by a standard riprap revetment (configuration RP-2)

profile would provide a major discontinuity at the wall to disrupt the wave action and runup flow and still allow the recurve to be effective. It was also felt that it would be better to build the revetment more like a wave absorber rather than using the standard riprap revetment design. The absorber revetment design would use additional armor stone out near the toe to trip the waves and dissipate the energy as far offshore as possible. These concepts led to the design of a wide berm profile wave absorber revetment.

Berms

26. The performance of the wide berm absorber revetment (configuration 4) in reducing wave overtopping of the seawall can be compared to the overtopping trends for a seawall fronted by a traditional riprap revetment (configuration 2) in Figure 21. Over most of the range of interest, as indicated, the wide berm configuration is better than the standard riprap revetment. The influence of a berm is noted also in discussion of the influence of extensive toe protection used for the Cape Hatteras vertical wall configuration and demonstrated by the data shown in Figure 19. In general, it appears that

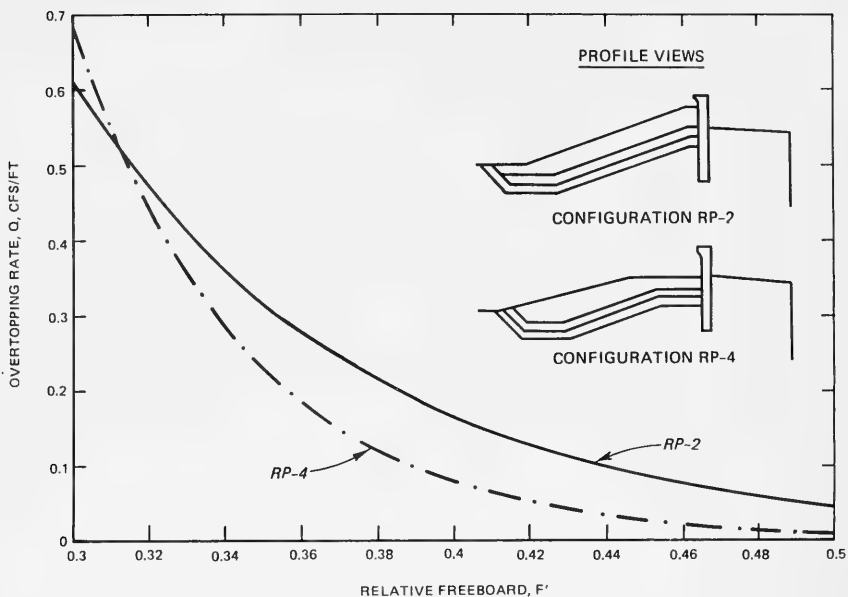
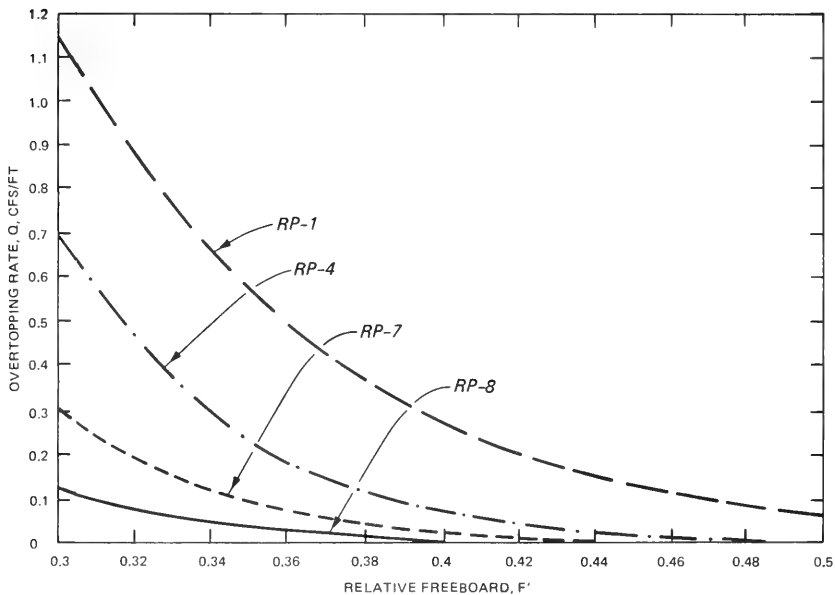

Figure 21. Comparison of overtopping trend curves for the Roughans Point seawall fronted by a standard riprap revetment (configuration RP-2) and the same seawall fronted by a wide berm, absorber revetment (configuration RP-4)

a berm located near the mean water level is effective in disrupting wave action near the seawall and in reducing overtopping rates. This finding is consistent with conclusions reached by Owen (1982b) based on laboratory tests of irregular wave overtopping of sea dikes.

Seawall crest height

27. A fourth method to reduce wave overtopping is to increase the crest elevation of the seawall. Because overtopping rates increase approximately exponentially with freeboard, the value of increasing the height of the wall can be readily appreciated. Tests were conducted during the Roughans Point study using a 1.0-ft cap and a 2.0-ft cap on the seawall. These caps were found to be very effective in reducing overtopping rates. Figure 22 shows overtopping trends for four seawall/revetment configurations, including configuration 7 with a 1.0-ft cap and configuration 8 with a 2.0-ft cap. configurations 4, 7, and 8 have the same wide berm absorber revetment profile so that the effectiveness of a cap can be easily appreciated in Figure 22 by



PROFILE VIEWS

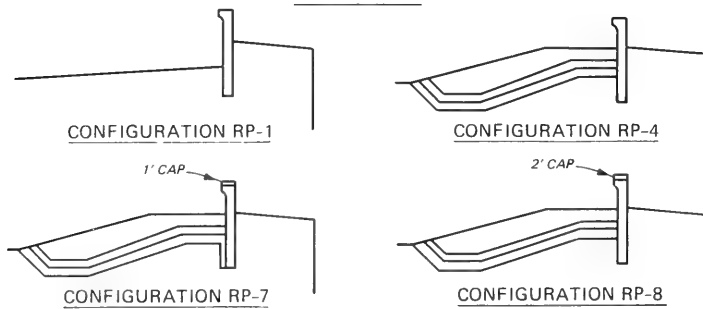

Figure 22. Comparison of overtopping trend curves for configurations RP-1, RP-4, RP-7, and RP-8

comparing the overtopping curves. Although in many situations increasing the height of a seawall would be unacceptable, Figure 22 shows that the effectiveness of a cap can be equivalent to placing a great amount of stone in front of the seawall.

Methods to Evaluate Effectiveness of Seawalls

28. Figure 22 provides an easy way to evaluate and compare the effectiveness of various strategies to reduce overtopping. An extension of using the figure to evaluate strategies would be to compare the area under the curves. The more effective the strategy the less area under the curve. The following parameter is defined to rank the various strategies based on the area under the data trend curves:

$$A = Q_o \int_{F'_{\min}}^{C_1 F'} e^{-\frac{C_1 F'}{C_1}} dF = -\frac{Q_o}{C_1} e^{-C_1 F'_{\min}}$$

The values of A_q are shown in Table 1 using $F'_{\min} = 0.3$. A minimum value of $F' = 0.3$ is used since for $F' = 0.3$ overtopping rates would probably be dominated by the inundation mode which would create serious problems in conducting the laboratory work and would probably cause difficulties in evaluating strategies which would be viable at somewhat lower water depths and wave heights. The parameter A_q is not intended to be used to calculate overtopping rates; rather, it is a measure of the hydraulic performance of a seawall/revetment configuration and can be used to roughly compare the effectiveness of various configurations.

29. Using the values of A_q in Table 1 and the data trend curves in Figure 22, it is easy to recognize the value of various strategies to reduce wave overtopping. Since most of the data shown was collected to solve a site-specific problem, this one set of data may not be ideal for quantifying the effectiveness of one strategy versus another, but the potential of the evaluation method presented in this section can be clearly perceived from this review. Further studies using this evaluation method will be used along with

a systematic laboratory test series to evaluate the effectiveness of various strategies to reduce wave overtopping of seawalls.

PART IV: WAVE RUNUP AND OVERTOPPING OF REVETMENTS

30. In some instances wave overtopping of a revetment occurs because the extent of wave runup is underestimated. Figure 23 shows a riprap revetment in New Haven, Connecticut, which was overtopped by wave action caused by Hurricane Gloria in 1985. Grouting of this riprap might have made the wave runup problem worse by making the revetment effectively smoother and thereby increasing the amount of overtopping. Ponding due to overtopping creates a hydraulic head which will cause fine particles to migrate out through the revetment if filter layers are not properly constructed. Loss of fine material from behind the revetment will eventually cause a collapse of the structure. A similar problem is shown in Figure 24 where storm waves from Hurricane Hilda (1964) overtopped the west jetty at Panama City, Florida. Ponding behind the jetty caused sand to migrate through the structure creating "sink" holes. Generally, small amounts of sand loss are not a problem since a jetty is free standing, but deep sink holes could undermine the heel of the jetty and cause the structure to slump.

31. Methods to alleviate wave overtopping of revetments obviously include increasing the thickness of the armor layer, using a quarry stone overlay (McCartney and Ahrens 1976), or possibly building a berm on the riprap revetments. The value of a berm was discussed under the topic of reducing wave overtopping of seawalls. A parapet could be used on a riprap revetment or a block revetment to reduce overtopping. An extension of the berm concept is to use an offshore breakwater in front of the revetment to reduce the severity of wave action on the revetment (Markle 1981; Powell and Allsop 1985). A modification of the offshore breakwater concept is to incorporate an underwater sill into the toe of the revetment to introduce premature wave breaking. Offshore breakwaters, sills, and berms provide a progression of possible solutions which seem promising for some situations, such as protection of El Morrow Castle, in San Juan, Puerto Rico (Markle 1982), but these solutions generally are expensive compared to the use of a parapet. The value of a parapet is probably similar to the value of a cap in increasing the height of a seawall, as shown in Figure 22.

32. In low-lying locations it is often impractical to build a revetment high enough not to be overtopped. However, even for these situations adoption of effective strategies for reducing wave runup and overtopping will improve



Figure 23. Damage to a grouted riprap revetment at New London, Connecticut, caused by waves generated by Hurricane Gloria, September 1985



Figure 24. Damage to grouted riprap revetment at Panama City, Florida, caused by waves generated by Hurricane Hilda, October 1964

the functional performance of the revetment. Often, on a revetment with a low crest elevation, the overtopping flow will cause erosion which is a problem in itself; but the erosion also can jeopardize the integrity of the entire revetment. A properly designed revetment, with carefully constructed filter and splash aprons, can probably survive moderate overtopping; but in some instances the revetment might need to be a free standing structure with an appropriate drainage channel. An effective strategy for reducing the runoff and overtopping on low-crested revetments would greatly improve their functional performance. The strategies to be investigated for this type of revetment will be the use of additional armor stone, berms, and parapets.

PART V: SUMMARY AND CONCLUSIONS

33. REMR field visits established that problems associated with runup and overtopping occurred on about 20 percent of the Corps' coastal structures. It was found that the problems could be roughly divided into three general problem areas: (a) wave runup and overtopping of breakwaters and jetties generating excessive wave action on the lee side, a problem usually compounded by additional wave transmission through the structure; (b) wave runup and overtopping of seawalls, sea dikes, and bulkheads causing flooding and/or erosion on the backside; and (c) wave runup and overtopping of revetments causing backside subsidence, erosion, and sometimes collapse of the revetment. On reservoirs, wave overtopping of revetments may cause damage to the upstream dam face or erosion of embankments.

34. A simple mathematical model is used illustrating the problem area related to wave transmission over and through rubble mounds. The model is interesting and useful because it can evaluate the potential effectiveness of various strategies to reduce wave transmission.

35. A dimensionless freeboard parameter is defined by Equation 1 and used in Equation 2 to provide a simple wave overtopping model for seawalls. The model is used to evaluate and rank the hydraulic performance of a number of seawall/revetment configurations. This model provides a logical and quantitative measure of the effectiveness of several methods to reduce overtopping of seawalls. These methods include:

- a. Use of a recurved wall in place of a vertical wall of the same height.
- b. Use of riprap revetments fronting the wall.
- c. Use of a cap to increase the crest height of the wall.

36. Some problems related to wave overtopping of revetments are noted, and potential solutions are suggested.

37. Based on the field evaluations and problems, further research is needed to develop and/or improve methodologies of predicting and reducing wave runup and overtopping on existing coastal structures. Various approaches and methods will be applied to each problem area, and laboratory tests will be an integral part of each approach.

REFERENCES

- Ahrens, J. P. 1987. "Characteristics of Reef Breakwaters," Technical Report CERC-87-18, US Army Engineer Waterways Experiment Station, Vicksburg, MS.
- Ahrens, J. P., and Heimbaugh, M. S. 1986 (Sep). "Irregular Wave Overtopping of Seawalls," Proceedings of Ocean 86 Conference, Washington, DC.
- Ahrens, J. P., Heimbaugh, M. S., and Davidson, D. D. 1986. "Irregular Wave Overtopping of Seawall/Revetment Configurations, Roughans Point, Massachusetts," Technical Report CERC-86-7, US Army Engineer Waterways Experiment Station, Vicksburg, MS.
- Allsop, N. W. H., Franco, L., and Hawkes, P. J. 1985 (Mar). "Wave Runup on Steep Slopes-A Literature Review, Report No. SR 1, Hydraulics Research Limited, Wallingford, Oxfordshire, England.
- Battjes, J. A. 1974. "Wave Runup and Overtopping," Report to the Technical Advisory Committee on Protection Against Inundation, The Hague, The Netherlands.
- Calhoun, R. J. 1971 (Mar). "Field Study of Wave Transmission Through a Rubble-Mound Breakwater," MS Thesis, U.S. Naval Postgraduate School, Monterey, California.
- Douglass, S. L. 1986. "Review and Comparison of Methods for Estimating Irregular Wave Overtopping Rates," Technical Report CERC-86-12, US Army Engineer Waterways Experiment Station, Vicksburg, MS.
- Goda, Y. 1969 (Sep). "Reanalysis of Laboratory Data on Wave Transmission Over Breakwaters," Report of the Port and Harbor Research Institute, Vol 9, No. 3.
- Goda, Y. 1985. Random Seas and Design of Maritime Structures, University of Tokyo Press, Tokyo, Japan.
- Grace, P. J., and Carver, R. D. 1985 (Dec). "Seawall and Revetment Stability Study, Cape Hatteras Lighthouse, North Carolina," Technical Report CERC-85-12, US Army Engineer Waterways Experiment Station, Vicksburg, MS.
- Hardy, T. A., and Crawford, P. L. 1986 (Sep). "Frequency of Coastal Flooding at Roughans Point, Broad Sound, Lynn Harbor, and the Saugus-Pines River System," Technical Report CERC-86-8, US Army Engineer Waterways Experiment Station, Vicksburg, MS.
- Johnson, J. W., Fuchs, R. A., and Morison, J. R. 1951. "The Damping Action of Submerged Breakwaters," Transactions of the American Geophysical Union, Vol 32, No. 5, pp 704-718.
- Keulegan, G. H. 1973. "Wave Transmission Through Rock Structures," Research Report H-73-1, US Army Engineer Waterways Experiment Station, Vicksburg, MS.

- Madsen, O. S. and White, S. M. 1976 (Mar). "Reflection and Transmission Characteristics of Porous Rubble-Mound Breakwaters," CERC Miscellaneous Report 76-5, US Army Engineer Waterways Experiment Station, Vicksburg, MS.
- Markle, D. G. 1981. "Breakwater and Revetment Stability Study, San Juan National Historic Site, San Juan, Puerto Rico," Technical Report HL-81-11, US Army Engineer Waterways Experiment Station, Vicksburg, MS.
- Markle, D. G. 1982 (Jul). "Kahului Breakwater Stability Study, Kahului, Maui, Hawaii," Technical Report HL-82-14, US Army Engineer Waterways Experiment Station, Vicksburg, MS.
- Markle, D. G., and Herrington, C. R. 1983 (Sep). "Nawiliwili Breakwater Stability, Nawiliwili Harbor, Hawaii," Technical Report HL-83-21, US Army Engineer Waterways Experiment Station, Vicksburg, MS.
- McCartney, B. L., and Ahrens, J. P. 1976 (Dec). "Overlay of Large, Placed Quarry Stone and Boulders to Increase Riprap Stability," CERC Technical Paper No. 76-19, US Army Engineer Waterways Experiment Station, Vicksburg, MS.
- Owen, M. W. 1982a (Sep). "The Hydraulic Design of Sea-Wall Profiles," Proceedings, International Coastal Engineering Conference, University of Southampton, England.
- Owen, M. W. 1982b (Sep). "Overtopping of Sea Defenses," Proceedings of International Conference on Hydraulic Modeling of Civil Engineering Structures, Coventry England.
- Powell, K. A., and Allsop, N. W. H. 1985 (Jul). "Low-Crest Breakwaters, Hydraulic Performance and Stability," Hydraulics Research Limited, Report SR 57, Wallingford, England.
- Seelig, W. N. 1980. "Two-Dimensional Tests of Wave Transmission and Reflection Characteristics of Laboratory Breakwaters," CERC Technical Report No. 80-1, US Army Engineer Waterways Experiment Station, Vicksburg, MS.
- Shore Protection Manual. 1984. 4th ed. 2 vols, US Army Engineer Waterways Experiment Station, Coastal Engineering Research Center, US Government Printing Office, Washington, DC.
- Sollitt, C. K., and Cross, R. H. 1976 (Jul). "Wave Reflection and Transmission at Permeable Breakwaters," CERC Technical Paper 76-8, US Army Engineer Waterways Experiment Station, Vicksburg, MS.
- Thornton, E. B., and Calhoun, R. J. 1972 (Nov). "Spectral Resolution of Breakwater Reflected Waves," American Society of Civil Engineers, Journal of Waterways, Harbors, and Coastal Engineering, Vol 98, No. WW4.

APPENDIX A: NOTATION

A_T	Cross-sectional area of breakwater (ft^2)
d_s	Water depth at toe of breakwater (ft)
d_{50}	$(W_{50}/W_r)^{1/3}$, typical dimension of the median stone (ft)
h_c	Crest height of reef breakwater
H_t	Zero-moment transmitted wave height (ft)
H_{mo}	Incident zero-moment wave height
L_p	Airy wave length calculated using T_p and d_s (ft)
T_p	Wave period of peak energy density of spectrum (sec)
w_r	Unit weight of stone (lb/ft^3)
W_{50}	Median stone weight, subscript indicates percent of total weight of gradation contributed by stones of lesser weight (lb)
F	$(h_c - d_3)$, freeboard of structure which for reef can be either positive or negative (ft)
B	nd_{50} , width of reef crest (ft)
n	Crest width factor
T_z	Zero-crossing wave period (sec)
H_s	Significant wave height, average of the highest one-third of the waves (ft)
F'	Dimensionless freeboard, defined by Equation 1
g	Acceleration of gravity, $32.16 \text{ ft}/\text{sec}^2$
Q	Overtopping rate (cfs/ft)
Q_o	Overtopping coefficient (cfs/ft)
C_1	Dimensionless overtopping coefficient
A_q	Hydraulic rank parameter for seawall/revetment configurations (cfs/ft)

