



MBL/WHOI



0 0301 0050257 1



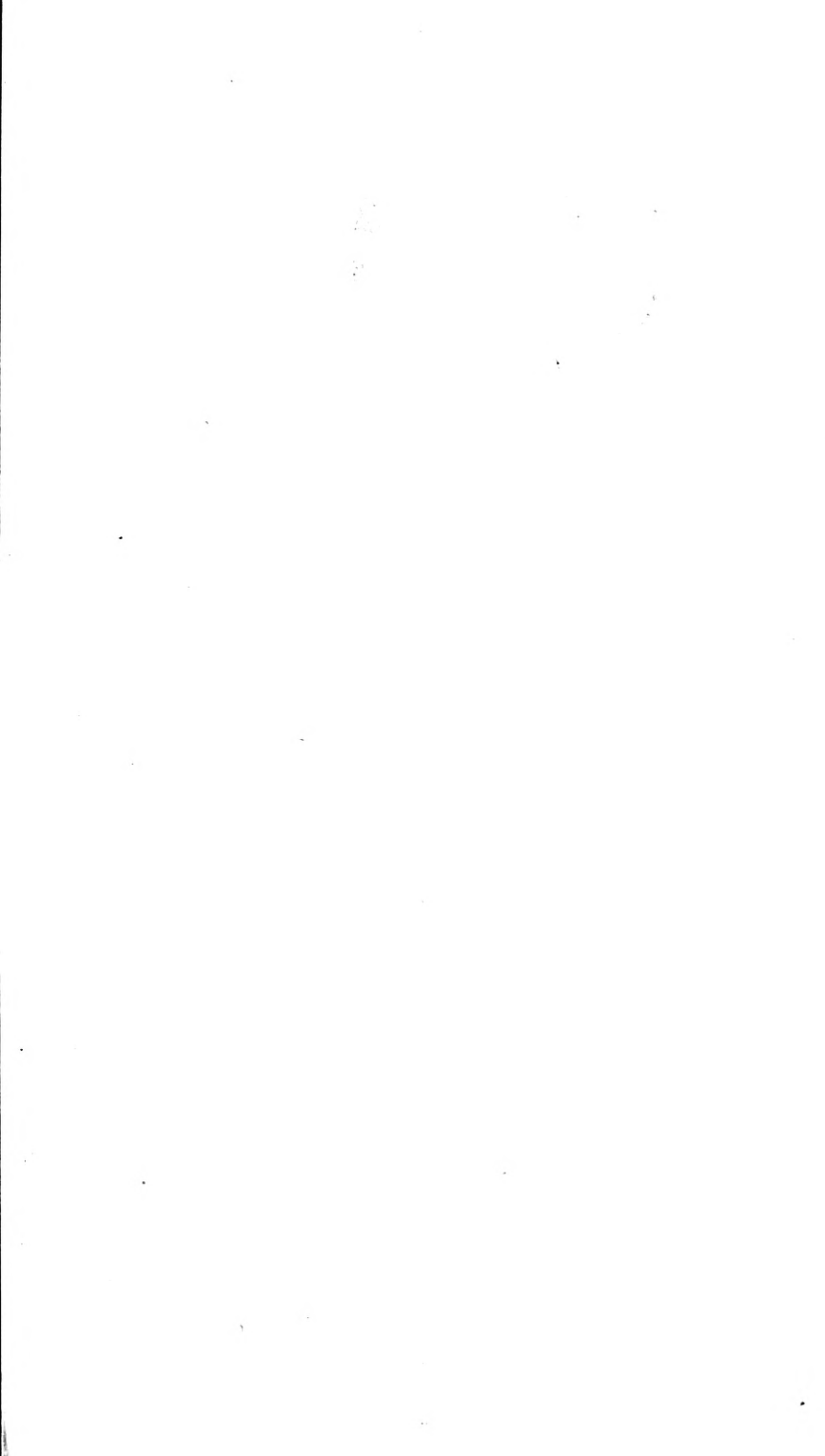

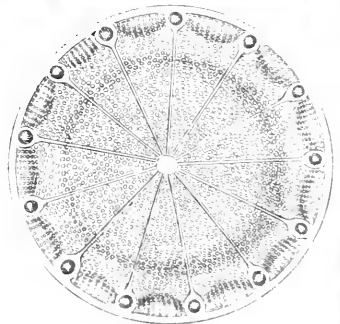
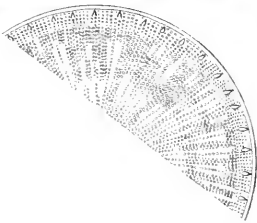
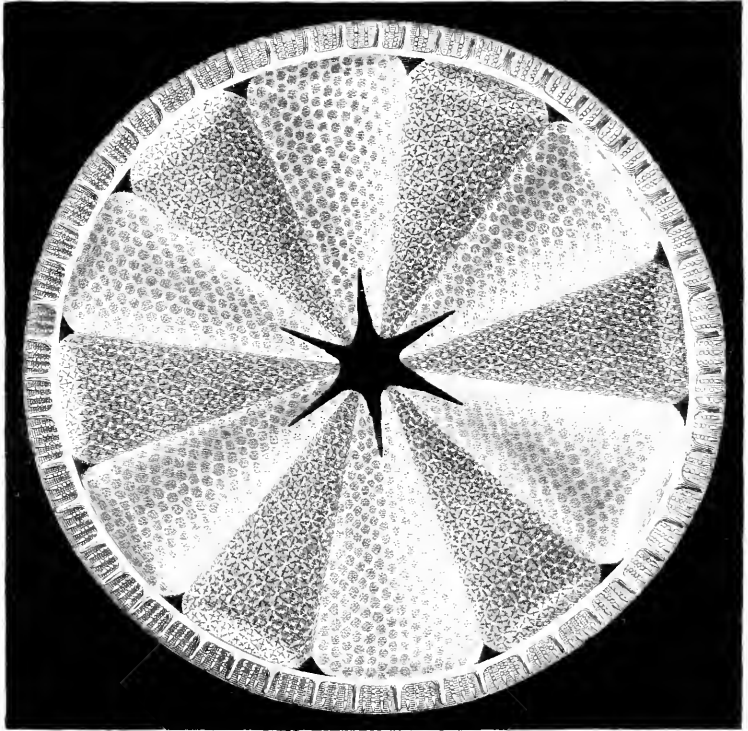
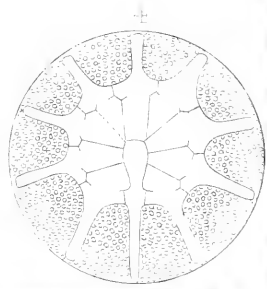
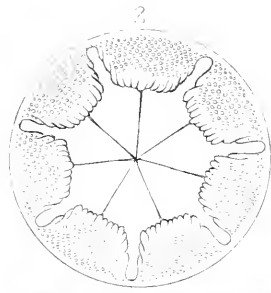

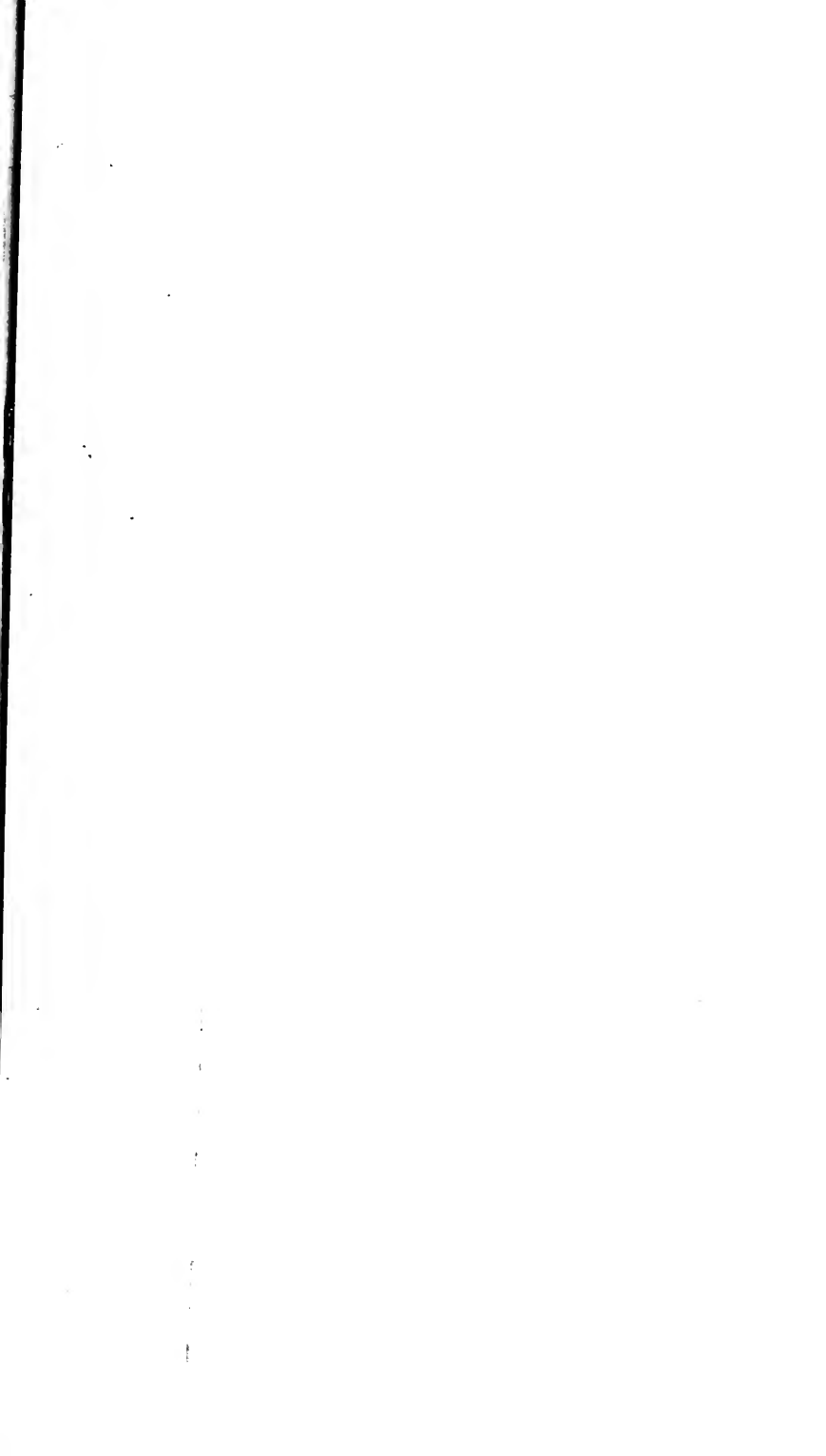

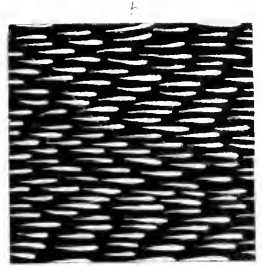
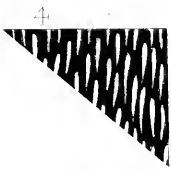
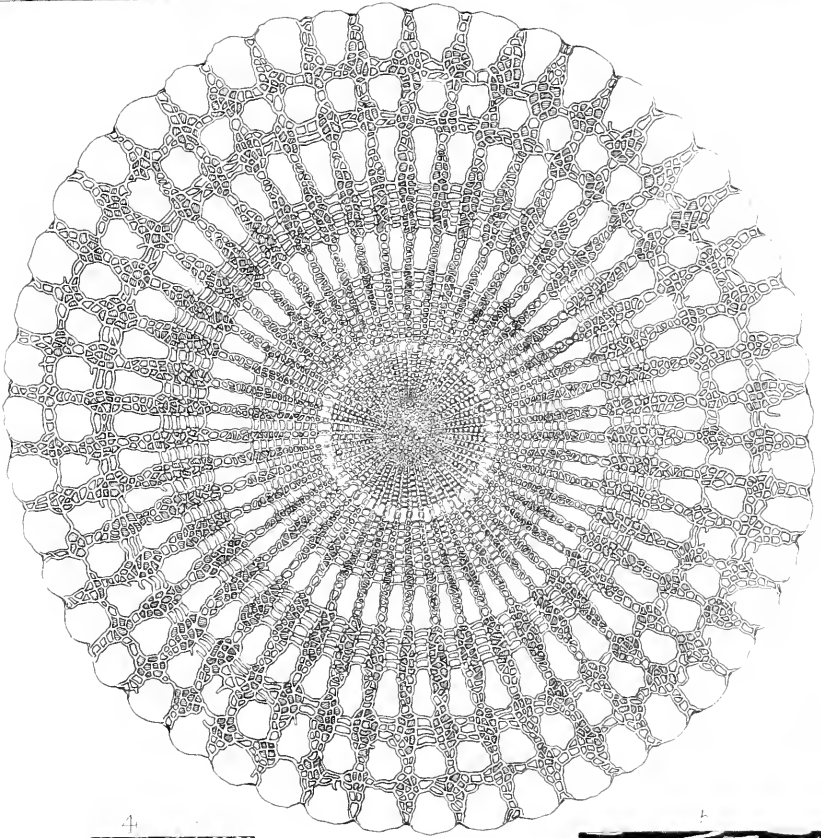
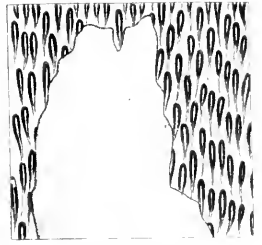
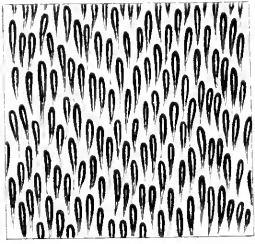

THE
MICROSCOPE
AND ITS
REVELATIONS.

BY THE SAME AUTHOR.

A MANUAL OF PHYSIOLOGY.

With numerous Illustrations on Steel and Wood.

Fourth Edition, Fcap. 8vo. cloth, 12s. 6d.

THE
MICROSCOPE

AND ITS
REVELATIONS.

BY
WILLIAM B. CARPENTER, M.D.,
F.R.S., F.G.S., F.L.S.,
REGISTRAR TO THE UNIVERSITY OF LONDON
FORMERLY PRESIDENT OF THE ROYAL MICROSCOPICAL SOCIETY
OF LONDON, ETC. ETC.



FOURTH EDITION

Illustrated by Twenty-five Plates, and Four Hundred
Wood Engravings.

LONDON:
JOHN CHURCHILL AND SONS,
NEW BURLINGTON STREET.
MDCCCLXVIII.

[The Author reserves to himself the right of Translation.]

WOODFALL AND KINDER, PRINTERS,
MILFORD LANE, STRAND, W.C.



PREFACE.

THE rapid increase which has recently taken place in the use of the Microscope,—both as an instrument of scientific research, and as a means of gratifying a laudable curiosity and of obtaining a healthful recreation,—has naturally led to a demand for information, both as to the mode of employing the Instrument and its appurtenances, and as to the Objects for whose minute examination it is most appropriate. This information the Author has endeavoured to supply in the following Treatise ; in which he has aimed to combine, within a moderate compass, that information in regard to the use of his Instrument and its Appliances which is most essential to the working Microscopist, with such an account of the Objects best fitted for his study as may qualify him to comprehend what he observes, and thus prepare him to benefit Science whilst expanding and refreshing his own mind. The sale of three large Editions of this Manual, notwithstanding the competition of several cheaper and more popular treatises, with the numerous unsought testimonies to its usefulness which the Author has received from persons previously unknown to him, justify the belief that it has not inadequately supplied an existing want ; and in the preparation of the new Edition now called-for, therefore, he has found no reason to deviate from his original plan, whilst he has endeavoured to improve its execution as to every point which seemed capable of amended treatment.

In his account of the various forms of Microscopes and Accessory Apparatus, the Author has not attempted to describe every thing which is used in this country ; still less, to go into minute details respecting the construction of foreign instruments. He is satisfied that in nearly all which relates both to the mechanical and

the optical arrangements of their instruments, the chief English Microscope-makers are decidedly in advance of their Continental rivals; but on the other hand the latter have supplied instruments which are adequate to all the ordinary purposes of scientific research, at a lower price than such could until recently be obtained in this country. Several British makers, however, are now devoting themselves to the production of Microscopes which shall be really *good* though *cheap*; and the Author cannot but view with great satisfaction the extension of the manufacture in this direction. In the selection of Instruments for description which it was necessary for him to make, he trusts that he will be found to have done adequate justice to those who have most claim to honourable mention. Nearly the whole of this portion of the work has been rewritten for the present Edition.

In treating of the Applications of the Microscope, the Author has constantly endeavoured to meet the wants of such as come to the study of the minute forms of Animal and Vegetable life with little or no previous scientific preparation, but desire to gain something more than a mere *sight* of the objects to which their observations may be directed. Some of these may perhaps object to the general tone of his work as too highly-pitched, and may think that he might have rendered his descriptions simpler by employing fewer scientific terms. But he would reply that he has had much opportunity of observing among the votaries of the Microscope a demand for such information as he has attempted to convey (of the extent of which desire, the success of the "Quarterly Journal of Microscopical Science" is a very gratifying evidence); and that the use of scientific terms cannot be easily dispensed with, since there are no others in which the facts can be readily expressed. As he has made a point of explaining these in the places where they are first introduced, he cannot think that any of his readers need find much difficulty in apprehending their meaning.

The proportion of space allotted to the several departments has been determined not so much by their Physiological importance, as by their special interest to the amateur Microscopist; and the remembrance of this consideration will serve to account for much that might otherwise appear either defective or redundant. The Author has thought it particularly needful to limit himself in treating of certain very important subjects which are fully discussed in Treatises expressly devoted to them (such, for example, as

the structure of Insects, and the Primary Tissues of Vertebrata), in order that he might give more space to those on which no such sources of information are readily accessible. For the same reason, he has omitted all reference to the applications of the Microscope to Pathological inquiry; a subject which would interest only one division of his readers, and on which it would have been impossible for him to compress, within a sufficiently-narrow compass, a really-useful summary of what such readers can readily learn elsewhere. So, again, the application of the Microscope to the detection of Adulterations in Food, &c., is a topic of such a purely-special character, and must be so entirely based on detailed descriptions of the substances in question, that he has thought it better to leave this also untouched. On the other hand, he has gone somewhat into detail in regard to various forms of Vegetable and Animal life, which the diligent Collector is not unlikely to meet with, and which will fully reward his most attentive scrutiny.

It has been the Author's object throughout, to guide the possessor of a Microscope to the *intelligent* study of any department of Natural History, which his individual tastes may lead him to follow-out, and his individual circumstances may give him facilities for pursuing. And he has particularly aimed to show, under each head, how small is the amount of reliable knowledge already acquired, compared with that which remains to be attained by the zealous and persevering student. Being satisfied that there is a large quantity of valuable *Microscope-power* at present running to waste in this country,—being applied in such desultory observations as are of no service whatever to Science, and of very little to the mind of the observer,—he will consider himself well rewarded for the pains he has bestowed on the production of this Manual, if it should tend to direct this power to more systematic labours, in those fertile fields which only await the diligent cultivator to bear abundant fruit.

In all that concerns the *working* of the Microscope, the Author has mainly drawn upon his own experience, which dates-back almost to the time when Achromatic Object-glasses were first constructed in this country. He would be ungrateful, however, if he were not to acknowledge that he has derived many valuable hints from the Practical Treatises of Mr. Quekett and Professor Beale, and from the Micrographic Dictionary of Messrs. Griffith and

Henfrey. Almost every working Microscopist, however, has methods and appliances of his own, which, having devised them for his special ends, he prefers to all others: to have noticed any considerable number of these (many of them described in recent volumes of the "Quarterly Journal of Microscopical Science") would have added too much to the bulk of his volume; and the Author has deemed it preferable to limit himself in most instances to those which he has himself tried and found to be serviceable,—his object being, not the impossible one of teaching his reader all that has to be learned, but the putting him in the way of learning it from that best of all teachers, *Experience*.

The whole Treatise has been subjected to a most careful revision; and by the sacrifice of the Introduction and the transfer of many of the Wood-cuts to separate Plates, room has been found for additional matter amounting in the whole to nearly *forty* pages,—the most important single additions being the account of *Eozöon Canadense* (pp. 517-521), and the outline of Prof. Beale's views on the Formation of the Elementary Tissues of Animals (pp. 689-693). Everywhere the number of References to the most valuable sources of more detailed information has been greatly augmented; and the number of Illustrations has again been largely increased.

UNIVERSITY OF LONDON,

March, 1868.

TABLE OF CONTENTS.

CHAPTER I.

OPTICAL PRINCIPLES OF THE MICROSCOPE.

	PAGE
Laws of Refraction :—Spherical and Chromatic Aberration	1
Simple Microscope	13
Compound Microscope	23
Principles of Binocular Vision	27
Stereoscopic Binocular Microscopes	30
Nachet's	31
Wenham's	32
Nachet's Stereo-pseudoscopic	35

CHAPTER II.

CONSTRUCTION OF THE MICROSCOPE.

General principles	42	
<i>Simple Microscopes</i>	46	Crouch's Student's Bino- cular
Ross's	46	71
Gairdner's	48	Smith and Beck's Popular
Field's	50	73
Quekett's	51	Collins's Harley Binocular
Beck's and Nachet's Binocular	53	74
<i>Compound Microscopes</i>	56	First-Class Microscopes
Third-Class Microscopes	57	76
Field's Educational	58	Ross's
Crouch's Educational	59	76
„ Student's	61	Powell and Lealand's
Pillischer's Student's	61	78
Murray and Heath's	62	Smith and Beck's
Second-Class Microscopes	64	80
Smith and Beck's Student's	64	Microscopes for Special Pur- poses
Ladd's Student's	66	82
Nachet's Student's	68	Beale's Pocket and De- monstrating
		82
		Baker's Travelling
		83
		King's Aquarium
		85
		Dr. L. Smith's Inverted
		85
		Nachet's Double-bodied
		87
		Powell and Lealand's Non- stereoscopic Binocular
		87

CHAPTER III.

ACCESSORY APPARATUS.

	PAGE		PAGE
Draw-Tube	89	Black-Ground Illuminators	114
Lister's Erector	90	White-Cloud Illuminator	117
Nacht's Erecting Prism	91	Polarizing Apparatus	118
Spectroscope Eye-piece	92	Side Illuminators for Opaque	
Micrometer	93	Objects	120
Goniometer	97	Parabolic Speculum	123
Diaphragm Eye-piece and In-		Lieberkühn	124
dicator	98	Beck's Vertical Illuminator	125
Camera Lucida	98	Stage - Forceps and Disk-	
Nose-piece	102	holders	127
Object-Marker	103	Glass Stage-Plate and Grow-	
Stage-Movement	104	ing Slide	129
Object-Finder	104	Aquatic Box	130
Diaphragm	106	Zoophyte-Trough	131
Achromatic Condenser	107	Compressorium	133
Webster Condenser	110	Dipping Tubes	135
Oblique Illuminators	111	Glass Syringe	136
Amici's Prism	112	Forceps	136
Reade's Hemispherical Con-			
denser	113		

CHAPTER IV.

MANAGEMENT OF THE MICROSCOPE.

Support	138	Arrangement for Opaque Ob-	
Light	139	jects	160
Position of Light	141	Errors of Interpretation	164
Care of the Eyes	142	Comparative Values of Ob-	
Care of the Microscope	143	ject-Glasses	170
General Arrangements	144	Test-Objects	175
Focal Adjustment	146	Determination of Magnifying	
Adjustment of Object-Glass.	149	Power	183
Arrangement for Transparent			
Objects	152		

CHAPTER V.

PREPARATION, MOUNTING, AND COLLECTION OF OBJECTS.

Microscopic Dissection	185	Chemical Actions	195
Cutting Sections of Soft Sub-		Staining Process	198
stances	188	Preparation of Specimens in	
Cutting Sections of Harder		Viscid Media	199
Substances	189		
Grinding and Polishing of		Glass Slides	201
Sections	191	Thin Glass	202

TABLE OF CONTENTS.

xi

	PAGE		PAGE
Varnishes and Cements	204	Sunk and Plate-Glass Cells	227
Mounting Objects Dry	208	Tube-Cells	228
Mounting Objects in Canada		Built-up-Cells.	230
Balsam	211	Mounting Objects in Cells	231
Preservative Media	220	Importance of Cleanliness	234
Mounting Objects in Fluid	223	Labelling and Preserving	234
Cement-Cells	225	Collection of Objects	235
Thin-Glass Cells	226		

CHAPTER VI.

MICROSCOPIC FORMS OF VEGETABLE LIFE.—PROTOPHYTES.

Boundary between Animal and Vegetable Kingdoms	230	Ulvaceæ	320
Characters of Vegetable Cell.	241	Oscillatoriaceæ	322
Life-History of Simplest Protophytes	243	Nostochaceæ	324
Volvocineæ	251	Siphonaceæ	325
Desmidiaceæ	250	Confervaceæ	330
Pediacstreæ	270	Conjugateæ	334
Diatomaceæ	273	Chætophoraceæ	336
Palmellaceæ	317	Batrachospermeæ	336
		Characeæ	338

CHAPTER VII.

MICROSCOPIC STRUCTURE OF HIGHER CRYPTOGAMIA.

Algæ	343	Mosses	369
Lichens	350	Ferns	376
Fungi	352	Equisetaceæ	383
Hepaticæ	365		

CHAPTER VIII.

MICROSCOPIC STRUCTURE OF PHANEROGAMIC PLANTS.

Elementary Tissues	386	Structure of Cuticle and Leaves	417
Structure of Stem and Root.	405	Structure of Flowers and Seeds	424

CHAPTER IX.

MICROSCOPIC FORMS OF ANIMAL LIFE:—PROTOZOA; ANIMALCULES.

Protozoa	434	Gregarinida	447
Rhizopoda	435	Thalassicollida	449
Reticularia	437	Animalcules	451
Radiolaria	438	Infusoria	452
Lobosa	442	Rotifera	469
Reproduction of Rhizopoda	446		

CHAPTER X.

FORAMINIFERA, POLYCYSTINA, AND SPONGES.

	PAGE		PAGE
Foraminifera	482	Nummulinida	506
Miliolida	489	Polycystina	523
Lituolida	498	Acanthometrina	526
Lagenida	500	Porifera (Sponges)	527
Globigerinida	500		

CHAPTER XI.

ZOOPHYTES.

Hydra	533	Acalephæ	545
Hydrozoa	537	Anthozoa	550

CHAPTER XII.

ECHINODERMATA.

Structure of Skeleton	555	Echinoderm-Larvæ	568
-------------------------------	-----	--------------------------	-----

CHAPTER XIII.

POLYZOA AND TUNICATA.

Polyzoa	576	Tunicata	584
-----------------	-----	------------------	-----

CHAPTER XIV.

MOLLUSCOUS ANIMALS GENERALLY.

Shells of Mollusca	593	Organs of Sense of Mollusks. . . .	619
Tongue of Gasteropods	606	Chromatophores of Cephalopods	620
Development of Mollusca	610		
Ciliary motion on Gills	618		

CHAPTER XV.

ANNULOSA OR WORMS.

Entozoa	621	Annelida	626
Turbellaria	624		

CHAPTER XVI.

CRUSTACEA.

Pycnogonidæ	636	Cirrhipeda	646
Entomostraca	638	Shell of Decapoda	648
Suctorina	645	Metamorphosis of Decapoda	649

CHAPTER XVII.

INSECTS AND ARACHNIDA.

	PAGE		PAGE
Number and Variety of Objects afforded by Insects	652	Wings	677
Structure of Integument	654	Feet	680
Tegumentary Appendages	655	Stings and Ovipositors	682
Eyes	661	Eggs	682
Antennæ	664	Agamic Reproduction	684
Mouth	667		
Circulation of the Blood	671	Acarida	685
Respiratory Apparatus	673	Parts of Spiders	687

CHAPTER XVIII.

VERTEBRATED ANIMALS.

Elementary Tissues	689	Epidermis	718
Bone	693	Pigment-Cells	719
Teeth	697	Epithelium	720
Scales of Fish	700	Fat	721
Hairs	704	Cartilage	722
Feathers	707	Glands	724
Hoofs, Horns, &c.	708	Muscle	725
Blood	709	Nerve	729
White and Yellow Fibres.	714	Circulation of the Blood	733
Skin, Mucous and Serous Membranes	717	Injected Preparations	739
		Vessels of Respiratory Organs	746

CHAPTER XIX.

APPLICATION OF THE MICROSCOPE TO GEOLOGY.

Fossilized Wood, Coal	751	Structure of Fossil Bones, Teeth, &c.	762
Fossil Foraminifera, Chalk	755	Inorganic materials of Rocks	765
Organic materials of Rocks	759		

CHAPTER XX.

INORGANIC OR MINERAL KINGDOM.—POLARIZATION.

Mineral Objects	768	Organic Structures suitable for Polariscopes!	774
Crystallization of Salts	769	Micro-Chemistry	776
Molecular Coalescence	774		

EXPLANATIONS OF THE PLATES.

PLATE I. (Frontispiece.)

VARIOUS FORMS OF DIATOMACEÆ.

- Fig. 1. *Actinocyclus Ralfsii*.
2. *Asterolampra concinna*.
3. *Heliopelta* (as seen with black-ground illumination).
4. *Asteromphalus Brookeii*.
5. *Aulacodiscus Oreganus*.

PLATE II. (Frontispiece).

ECHINUS-SPINE (Original), AND PODURA-SCALE (after R. Beck).

- Fig. 1. Transverse section of Spine of *Echinometra heteropora*.
2. Markings on Scale of *Podura*, as seen by transmitted light under a well-corrected 1-8th inch Objective.
3. Partial obliteration of the markings by the insinuation of moisture between the Scale and the Covering-glass.
4. Appearance of the markings, when the Scale is illuminated from above by oblique light falling at right angles to them.
5. The same, when the light falls on the Scale in the direction of the markings.

PLATE III. (p. 73).

SMITH AND BECK'S POPULAR MICROSCOPE.

PLATE IV. (p. 76).

ROSS'S LARGE MICROSCOPE.

PLATE V. (p. 78).

POWELL AND LEALAND'S SMALLER MICROSCOPE.

PLATE VI. (p. 79).

POWELL AND LEALAND'S LARGE MICROSCOPE.

PLATE VII. (p. 80).

SMITH AND BECK'S LARGE MICROSCOPE.

PLATE VIII. (p. 244).

DEVELOPMENT OF PALMOGLEA AND PROTOCOCCUS (after Braun and Cohn).

Fig. 1, A—I. Successive stages of Binary Subdivision of Palmoglaea; K—M, successive stages of Conjugation.

2, A—C. Binary subdivision of 'still' form of *Protococcus*; D—G, multiplication of 'motile' form; H—L, different phases of 'motile' condition.

PLATE IX. (p. 252).

DEVELOPMENT OF VOLVOX GLOBATOR (after Williamson).

Fig. 1. Young *Volvox*; *a*, primordial cell of secondary sphere; *b*, polygonal masses of endochrome, separated by hyaline substance.

2. The same more advanced; *a, a*, polygonal masses of endochrome; *b, b*, their connecting processes; *c*, primordial cell of secondary sphere.

3. The same more advanced, showing an increase in the size of the connecting processes, *a, a*, and a duplicative subdivision of the primordial cell.

4. The same more advanced, showing the masses of endochrome more widely separated by the interposition of hyaline substance, and each furnished with a pair of cilia; whilst the primordial cell, *f*, has undergone a second segmentation.

5. Portion of the spherical wall of a mature *Volvox*, showing the wide separation of the endochrome-masses still connected by the processes *b, b*, the lines of areolation, *c*, dividing the hyaline substance, and the long cilia, *e*.

6, 7, 8. Secondary sphere, or macro-gonidium, developed by the progressive segmentation of the primordial cell.

9. Single cell from the wall of a mature *Volvox*, showing the endochrome-mass, *b*, to contain two vacuoles, *a, a*, and to be surrounded by a hyaline envelope, *d*, having polygonal borders.

10. Portion of the wall of a young *Volvox*, seen edgeways, showing that its sphere is still invested by the hyaline envelope of the original cell, which the cilia penetrate but do not pierce.

11. Two cells from mature *Volvox*, seen edgeways, showing the enclosure of the endochrome-masses in their own hyaline investment, and the persistence of the general investment (here pierced by the cilia) around the entire sphere.

PLATE X. (p. 300).

ARACHNOIDISCUS JAPONICUS (after R. Beck).

The specimens, attached to the surface of a Sea-weed, are represented as seen under a 1.4th Objective, with Lieberkühn illumination:—A, internal surface; B, external surface; c, front view, showing incipient subdivision.

PLATE XI. (p. 332).

DEVELOPMENT AND REPRODUCTION OF SPHEROPLEA ANNULINA (after Cohn).

Fig. 1. Oo-spore, of a red colour, having its outer membrane furnished with stellate prolongations.

2, 3, 4. Successive stages of segmentation of the Oo-spore.

5. Fusiform ciliated Zoospores set free by the rupture of the coats of the Oo-spore.

- 6, 7, 8. Successive stages of its development into a filament.
9. Immature filament, showing at *a* the annulation of the Endochrome produced by the regular arrangement of vacuoles, and at *b* the frothy appearance produced by the multiplication of vacuoles.
10. More advanced stage, showing at *a* the aggregation of the Endochrome into definite masses, which become star-shaped as seen at *b*.
11. The star-shaped masses of Endochrome, *a*, draw themselves together again and become ovoidal, as at *b*; definite openings, *c*, show themselves in the cell-wall.
12. Entrance of the Antherozoids, *d*, through the openings *c*, *c*.
13. Formation of mature Oo-spores within the filament.
14. Contents of another filament, *a*, becoming converted into Antherozoids, which move about at *b* within their containing cell, and escape (as seen at *d*) through the opening *c*.
15. Antherozoids swimming freely by means of two motile filaments.

PLATE XII. (p. 409).

TRANSVERSE SECTIONS OF EXOGENOUS STEMS (Original).

- Fig. 1. Young Stem of *Clematis*:—*a*, pith; *b, b, b*, woody bundles; *c, c, c*, medullary rays.
2. Portion of stem of *Cedar*:—*a*, pith; *b, b, b*, wood; *c*, bark.
 3. Stem of *Buckthorn* (*Rhamnus*).
 4. Portion of ditto more highly magnified.

PLATE XIII. (p. 412).

TRANSVERSE AND VERTICAL SECTIONS OF EXOGENOUS STEMS (Original).

- Fig. 1. Portion of transverse section of a Fossil Wood, showing the Medullary Rays, *a a, a a, a a*, running nearly parallel to each other, and the openings of large Ducts in the midst of the Woody fibres.
2. Vertical (tangential) section of the same Wood; showing the Woody fibres separated by the Medullary Rays, and by the large Ducts, *b b, b b*.
 - 3 and 4. Transverse and vertical (tangential) sections of a Fossil Wood, showing the separation of the Woody plates, *a, a*, by the very large Medullary Rays, *b, b*.

PLATE XIV. (p. 464).

SEXUAL REPRODUCTION OF INFUSORIA (after Balbiani).

- Fig. 1. Conjugation of *Paramecium aurelia*; *a*, Ovarium (nucleus); *b*, Seminal capsule (nucleolus); *c*, oviducal canal; *d*, seminal canal; *e*, buccal fissure.
2. The same, more advanced; *a*, Ovary, showing lobulated surface; *b, b*, secondary Seminal capsules.
 3. One of the individuals in a still more advanced stage of conjugation, showing the Ovary *a, a*, broken up into fragments connected by the tube *m*; *b, b*, Seminal capsules; *v*, Contractile vesicle.
 4. *Paramecium* ten hours after the conclusion of the conjugation; *a, a*, unchanged granular masses of the Ovary; of which other portions have been developed into the Ova, *o, o*, still contained within the connecting tube *m*; *b, b*, Seminal capsules.
 5. The same, three days after the completion of the conjugation.
 - 6—12. Successive stages in the development of the Seminal capsules.
 - 13—18. Successive stages in the development of the Ovules.
 19. *Acinetæ* in different stages, A, B, C.
 20. *Paramecium* containing three *Acinetæ*-parasites, *q, q, q'*, lying in introverted pouches, of which the external openings are seen at *x, x*.
 21. *Stentor* in conjugation.

PLATE XV. (p. 483).

VARIOUS FORMS OF FORAMINIFERA (Original).

- | | |
|--|---|
| <p>Fig. 1. <i>Cornuspira</i>.
 2. <i>Spiroloculina</i>.
 3. <i>Triloculina</i>.
 4. <i>Biloculina</i>.
 5. <i>Peneroplis</i>.
 6. <i>Orbiculina</i> (cyclical form).
 7. <i>Orbiculina</i> (young).
 8. <i>Orbiculina</i> (spiral form).
 9. <i>Lagena</i>.
 10. <i>Nodosaria</i>.</p> | <p>Fig. 11. <i>Cristellaria</i>.
 12. <i>Globigerina</i>.
 13. <i>Polymorphina</i>.
 14. <i>Textularia</i>.
 15. <i>Discorbina</i>.
 16. <i>Polystomella</i>.
 17. <i>Planorbulina</i>.
 18. <i>Rotalia</i>.
 19. <i>Nonionina</i>.</p> |
|--|---|

PLATE XVI. (p. 509).

VARIOUS FORMS OF FORAMINIFERA (Original).

Fig. 1. *Cycloclypeus*, showing external surface, and vertical and horizontal sections.

2. *Operculina*, laid open to show its internal structure:—*a*, Marginal cord, seen in cross section at *a'*; *b*, *b*, external walls of the Chambers; *c*, *c*, cavities of the Chambers; *c' c'*, their Alar prolongations; *d*, *d*, Septa, divided at *d' d'* and at *d''*, so as to lay open the Interseptal Canals, the general distribution of which is seen in the septa *e*, *e*; the lines radiating from *e*, *e*, point to the secondary pores; *g*, *g*, non-tubular columns.

3. *Calcarina*, laid open to show its internal structure:—*a*, Chambered portion; *b*, Intermediate skeleton; *c*, one of the Radiating prolongations proceeding from it, with extensions of the Canal-system.

PLATE XVII. (p. 518).

STRUCTURE OF EOZÖON CANADENSE (Original).

Fig. 1. Portion of its Calcareous Shell, as it would appear if the Serpentine that fills its chambers could be dissolved away:—*A*¹, *A*¹, Chambers of lower storey, opening into each other at *a*, *a*, but occasionally separated by a septum *b*, *b*; *A*², *A*², Chambers of upper storey; *B*, *B*, proper Walls of the Chambers, formed of a finely-tubular or Nummuline substance; *c*, *c*, Intermediate Skeleton, occasionally traversed by large Stolon-passages, *D*, connecting the chambers of different storeys, and penetrated by the arborescent systems of Canals, *E*, *E*, *E*.

2. Decalcified portion, showing the Serpentine *Internal Cast* of the Chambers, Canals, and Tubuli of the original; presenting an exact model of the Animal-substance which originally filled them.

PLATE XVIII. (p. 523).

VARIOUS FORMS OF POLYCYSTINA (after Ehrenberg).

- Fig. 1. *Podocyrtis Schomburgkii*.
 2. *Rhopalocanium ornatum*.
 3. *Haliomma hystrix*.
 4. *Ptrocanium*, with animal.

PLATE XIX. (p. 526).

VARIOUS FORMS OF RADIOLARIA (after Haeckel).

- Fig. 1. *Ethmosphæra siphonophora*.
 2. *Actinomma inerme*.
 3. *Acanthometra xiphicantha*.
 4. *Arachnosphæra oligacantha*.
 5. *Cladococcus viminalis*.

PLATE XX. (p. 540).

CAMPANULARIA GELATINOSA (after Van Beneden).

A, Upper part of the Stem and Branches, of the natural size.

B, Small portion enlarged, showing the structure of the animal; *a*, terminal branch bearing Polypes; *b*, polype-bud partially developed; *c*, horny cell containing the expanded polype *d*; *e*, Ovarian capsule, containing Medusiform gemmæ in various stages of development; *f*, fleshy substance extending through the stem and branches, and connecting the different polype-cells and ovarian capsules; *g*, annular constrictions at the base of the branches.

PLATE XXI. (p. 575).

PENTACRINOID LARVA OF ANTEDON (Original).

Fig. 1. Skeleton of early Larva, as seen under Black-ground Illumination, showing its component plates:—*b, b*, Basals, articulated below to the highest point of the stem; *r¹, r¹*, First Radials, between two of which is seen the single Anal plate, *a*; *r²*, Second Radials; *r³*, Third Radials, giving off the bifurcating Arms at their summit; *o, o*, Orals.

2, 3. Back and front views of a more advanced Larva, as seen by Incident Light, one of the pair of Arms being cut away in Fig. 3, in order to bring the Mouth and its surrounding parts into view:—*b, b*, Basals; *r¹, r², r³*, First, Second, and Third Radials; *a*, Anal, now carried upwards by the projection of the Vent *v*; *o, o*, Orals; *cir*, Dorsal Cirrhi, developed from the highest joint of the Stem.

PLATE XXII. (p. 578).

STRUCTURE OF LAGUNCULA REPENS (after Van Beneden).

A, Polypide expanded; B, Polypide retracted; c, another view of the same, with the Visceral apparatus in outline, that the manner in which it is doubled on itself, with the Tentacular crown and Muscular system, may be more distinctly seen:—*a, a*, tentacula; *b*, pharynx; *c*, pharyngeal valve; *d*, œsophagus; *e*, stomach; *f*, its pyloric orifice; *g*, cilia on its inner surface; *h*, biliary follicles lodged in its wall; *i*, intestine; *k*, particles of excrementitious matter; *l*, anal orifice; *m*, testis; *n*, ovary; *o*, ova lying loose in the perivisceral cavity; *p*, outlet for their discharge; *q*, spermatozoa in the perivisceral cavity; *r, s, t, u, v, w, x*, muscles.

D, Portion of the Lophophore more enlarged:—*a, a*, tentacula; *b, b*, their internal canals; *c*, their muscles; *d*, lophophore; *e*, its retractor muscles.

PLATE XXIII. (p. 632).

STRUCTURE AND DEVELOPMENT OF TOMOPTERIS ONISCIFORMIS (Original).

- A. Portion of Caudal prolongation, containing the Spermatic sacs, *a, a*.
 B. Adult Male specimen.

c. Hinder part of adult Female specimen, more enlarged, showing Ova lying freely in the Perivisceral cavity and its caudal prolongation.

d. Ciliated Canal, commencing externally in the larger and smaller Rosette-like disks, *a, b*.

e. One of the Pinnulated Segments, showing the position of the Ciliated Canal, *c*, and its Rosette-like disks, *a, b*; showing also the incipient development of the Ova, *d*, at the extremity of the segment.

f. Cephalic Ganglion, with its pair of Sensory (?) vesicles, *a, a*, and its two Ocelli, *b, b*.

g. Very young *Tomopterus*, showing at *a, a* the Larval Antennæ; *b, b*, the incipient long Antennæ of the adult; *c, d, e, f*, four pairs of succeeding Pinnulated Segments, followed by bifid Tail.

PLATE XXIV. (p. 737).

CIRCULATION IN THE TADPOLE (after Whitney).

Fig. 1. Anterior portion of Young Tadpole, showing the External Gills, with the incipient tufts of the Internal Gills, and the pair of minute tubes between the Heart and the spirally-coiled Intestine, which are the rudiments of the future Lungs.

2. More advanced Tadpole, in which the External Gills have almost disappeared:—*a*, remnant of external gills on the left side; *b*, operculum; *c*, remnant of external gill on the right side, turned in.

3. Advanced Tadpole, showing the general course of the Circulation:—*a*, heart; *b*, branchial arteries; *c*, pericardium; *d*, internal gill; *e*, first or cephalic trunk; *f*, branch to lip; *g*, branches to head; *h*, second or branchial trunk; *i*, third trunk, uniting with its fellow to form the abdominal aorta, which is continued as the caudal artery *k*, to the extremity of the tail; *l*, caudal vein; *m*, kidney; *n*, vena cava; *o*, liver; *p*, vena portæ; *q*, sinus venosus, receiving the jugular vein, *r*, and the abdominal veins, *t, u*, as also the branchial vein, *v*.

4. The Branchial Circulation on a larger scale:—A, B, C, three primary branches of the Branchial artery; *a*, cartilaginous arches; *b*, additional framework; *c, e*, twigs of branchial Artery; *d, f*, rootlets of branchial Vein.

5. Origin of the Vessels of the Internal Gills, *g*, from the roots of those of the External.

6. The Heart, Systemic Arteries, Pulmonary Arteries and Veins, and Lungs, in the Adult Frog; the heart being turned up in the right hand figure, to show the junction of the Pulmonary Veins and their entrance into the Left Auricle.

PLATE XXV. (p. 744).

DISTRIBUTION OF CAPILLARY BLOODVESSELS, AS SHOWN IN TRANSPARENT INJECTIONS (Original).

Fig. 1. Transverse Section of Small Intestine of Rat, showing the Villi *in situ*.

2. Section of the Toe of a Mouse:—*a, a, a*, tarsal bones; *b*, digital artery; *c*, vascular loops in the papillæ forming the thick Epidermic cushion on the under surface; *d*, distribution of vessels in the matrix of the Claw.

3. Distribution of Bloodvessels in the Cortical Layer of the Brain, showing the manner in which the Arteries, carried-in by the Pia Mater, dip-down into the furrows of the Convulsions.

LIST OF WOOD-CUT ILLUSTRATIONS.

	PAGE
1. Diagram illustrating Refraction	2
2. Refraction of parallel rays by plano-convex lens	4
3. Ditto by double-convex lens	5
4. Refraction of rays diverging from distance of diameter	6
5. Refraction of Diverging Rays.	7
6. Refraction of Converging Rays	7
7. Formation of images by Convex lenses	9
8. Spherical Aberration	9
9. Chromatic Aberration	12
10. Section of Achromatic Object-glass	14
11. Effect of Covering-glass	17
12. Action of Simple Microscope	19
13. Simplest form of Compound Microscope	24
14. Complete Compound Microscope	24
15. Huyghenian Eye-piece	25
16. Stereoscopic Pyramids	29
17. Arrangement of Prisms in Nacet's Stereoscopic Binocular Microscope	31
18. Nacet's Stereoscopic Binocular	32
19. Wenham's Prism for Stereoscopic Binocular.	33
20. Sectional view of Wenham's Stereoscopic Binocular	34
21. Exterior view of Wenham's Stereoscopic Binocular	34
22. Arrangement of Prisms in Nacet's Stereo-Pseudoscopic Bino- cular	35
23. Exterior of Nacet's Stereo-Pseudoscopic Binocular	36
24. Diagram illustrating Angle of Aperture suitable for Binocular Objectives	38
25. Ditto Ditto	39
26. Ross's Simple Microscope	47
27. Gairdner's Doublet Microscope	49
28. Field's Simple Microscope	51
29. Quekett's Dissecting Microscope	5
30. Beck's Dissecting Microscope, with Nacet's Binocular Magnifier	53
31. Field's Educational Microscope	58
32. Crouch's Educational Microscope	60
33. Pillischer's Student's Microscope	62
34. Murray and Heath's Student's Microscope	63
35. Smith and Beck's Student's Microscope	65
36. Ladd's Student's Microscope	67
37. Nacet's Student's Microscope	69
38. Crouch's Student's Binocular	72
39. Collins's Harley Binocular	75
40. Beale's Demonstrating Microscope	83
41. Baker's Travelling Microscope	4
42. Dr. Lawrence Smith's Inverted Microscope	85

	PAGE
43. Diagram of Reversing Prism of ditto	86
44. Nacet's Double-bodied Microscope	87
45. Arrangement of Prism, &c., in Powell and Lealand's Binocular for high powers	88
46. Draw-tube with Erector	90
47. Diagram of Nacet's Erecting Prism	91
48. Nacet's Erecting Eye-piece	91
49. Sorby-Browning Spectroscope Eye-piece	92
50. Arrangement of Prisms in ditto	93
51. Jackson's Eye-piece Micrometer	96
52. Hartnack's Eye-piece Micrometer	97
53. Microscope arranged for Drawing	99
54. Diagram of Chevalier's Camera Lucida	101
55. Diagram of Nacet's Camera Lucida	102
56. Brooke's Nose-piece, modified by Powell and Lealand.	103
57. Collins's Graduating Diaphragm	107
58. Ross's Achromatic Condenser.	108
59. Smith and Beck's ditto	109
60. Powell and Lealand's ditto	109
61. Webster Condenser, fitted with Collins's Graduating Diaphragm	111
62. Amici's Prism	113
63. Parabolic Illuminator	115
64. Diagram of action of ditto	116
65. White-cloud Illuminator	117
66. Fitting of Polarizing Prism	118
67. Fitting of Analyzing Prism	119
68. Selenite Object-Carrier	120
69. Condensing Lens	121
70. Bull's-eye Condenser	122
71. Beck's Parabolic Speculum	123
72. Crouch's Adapter for ditto	123
73. Diagram of Lieberkühn	125
74. Beck's Vertical Illuminator	126
75. Stage-Forceps	127
76. Beck's Disk-holder	128
77. Morris's Object-holder	129
78. Aquatic Box	130
79. Zoophyte-Trough	132
80. Compressorium	133
81. Ross's Compressorium	134
82. Dipping Tubes	135
83. Glass Syringe	136
84. Forceps	137
85. Bockett-Lamp	141
86. Section of Adjusting Objective	150
87. Arrangement of Microscope for Transparent Objects	154
88. Effect of different modes of Illumination on <i>Pleurosigma for-</i> <i>mosum</i> , after Beck	159
89. Arrangement of Microscope for Opaque Objects	161
90. Hexagonal Areolation of <i>Pleurosigma angulatum</i> , after Wenham	167
91. Valve of <i>Surirella gemma</i> , after Hartnack	182
92. Spring-Scissors	187
93. Curved Scissors	188
94. Valentin's Knife	189

	PAGE
95. Section-Instrument	190
96. Lever of Contact	203
97. Spring-Clip	208
98. Wooden Slide for Opaque Objects	209
99. Smith's Mounting Instrument	213
100. Slider-Forceps	214
101. Spring-Press	215
102. Dropping-Bottle	224
103. Shadbolt's Turn-Table	226
104. Sunk Cells	228
105. Plate-Glass Cells	229
106. Tube-Cells	230
107. Built-up Cells	231
108. <i>Volvox globator</i> , after Ehrenberg	251
109. Formation of Amœboid bodies in <i>Volvox</i> , after Hicks	256
110. Various species of <i>Staurastrum</i> , after Ralfs	259
111. Circulation in <i>Closterium</i> , after S. G. Osborne	261
112. Binary Subdivision of <i>Micrasterias</i> , after Lobb	264
113. Conjugation of <i>Cosmarium</i> , after Ralfs	266
114. Ditto of <i>Closterium</i> , after Ralfs	267
115. Binary Subdivision and Conjugation of <i>Didymoprium</i> , after Ralfs	268
116. Development of <i>Pediastrum granulatum</i> , after Braun	271
117. Various forms of <i>Pediastrum</i> , after Ralfs	272
118. Portion of <i>Isthmia nervosa</i> , after Smith	275
119. <i>Triceratium favus</i> , after Smith	279
120. <i>Pleurosigma quadratum</i> , after R. Beck	281
121. <i>Biddulphia pulchella</i> , after Smith	283
122. Conjugation of <i>Epithemia</i> , after Thwaites	285
123. Conjugation of <i>Melosira</i> , after Thwaites	286
124. <i>Meridion circulare</i> , after Smith	290
125. <i>Bacillaria paradoxa</i> , after Smith	290
126. <i>Licmophora flabellata</i> , after Smith	291
127. <i>Diatoma vulgare</i> , after Smith	292
128. <i>Grammatophora serpentina</i> , after Smith	292
129. <i>Surirella constricta</i> , after Smith	294
130. <i>Campylodiscus costatus</i> , after Smith	295
131. <i>Melosira subflexilis</i> , after Smith	296
132. <i>Melosira varians</i> , after Smith	296
133. <i>Actinoptychus undulatus</i> , after Smith	299
134. <i>Isthmia nervosa</i> , after Smith	301
135. <i>Chætoceros Wighamii</i> , after T. West	303
136. <i>Bacteriastrum furcatum</i> , after T. West	303
137. <i>Rhizosolenia imbricata</i> , after Brightwell	304
138. <i>Achnanthes longipes</i> , after Smith	304
139. <i>Gomphonema geminatum</i> , after Smith	305
140. Separate frustules of ditto, after Smith	306
141. <i>Schizonema Grevillii</i> , after Smith	307
142. <i>Mastogloia Smithii</i> , after Smith	309
143. <i>Mastogloia lanceolata</i> , after Smith	309
144. Fossil <i>Diatomaceæ</i> , from Oran, after Ehrenberg	312
145. Fossil <i>Diatomaceæ</i> , from Mourne mountains, after Ehrenberg	313
146. <i>Hæmatococcus sanguineus</i> , after Hassall	318
147. Successive stages of development of <i>Ulva</i> , after Kützing	319

	PAGE
148. Zoospores of <i>Ulva</i> , after Thuret	321
149. <i>Oscillatoria contexta</i> , after D'Alquen	323
150. <i>Nostoc</i> , after Hassall	324
151. Generation of <i>Vaucheria</i> , after Pringsheim	327
152. Zoospores of <i>Achlya</i> , after Unger	328
153. Cell-multiplication of <i>Conferva</i> , after Mohl	331
154. Sexual Reproduction of <i>Ædogonium ciliatum</i> , after Pringsheim	334
155. <i>Zygnema quininum</i> , after Kützing	335
156. <i>Chatophora elegans</i> , after Thuret	336
157. <i>Batrachospermum moniliforme</i>	337
158. <i>Nitella flexilis</i> , after Slack	339
159. Antheridia of <i>Chara</i> , after Thuret	341
160. <i>Mesogloia vermicularis</i> , after Payer	343
161. <i>Sphacelaria cirrhosa</i> (original), with antheridium of <i>S. tribuloides</i> , after Pringsheim	344
162. Receptacle of <i>Fucus</i> , after Thuret	346
163. Antheridia and Antherozoids of <i>Fucus</i> , after Thuret	347
164. Tetraspores of <i>Carpocaulon</i> , after Kützing	349
165. <i>Torula cerevisiæ</i> , after Mandl	352
166. <i>Sarcina ventriculi</i> , after Robin	353
167. <i>Botrytis bassiana</i> , after Robin	355
168. <i>Enterobryus spiralis</i> , after Leidy	356
169. Structure of <i>Enterobryus</i> , after Leidy	357
170. Fungoid Vegetation from <i>Passulus</i> , after Leidy	359
171. Shell of <i>Anomia</i> penetrated by Parasitic Fungus	359
172. <i>Stysanus caput-medusæ</i> , after Payer	360
173. <i>Puccinia graminis</i>	362
174. <i>Æcidium tussilaginis</i> , after Payer	364
175. <i>Clavaria crispula</i> , after Payer	364
176. Fructification of <i>Marchantia</i> , after Payer	365
177. Stomata of <i>Marchantia</i> , after Mirbel	366
178. Conceptacles of <i>Marchantia</i> , after Mirbel	368
179. Archegonia of <i>Marchantia</i> , after Payer	369
180. Elater and Spores of <i>Marchantia</i> , after Payer	370
181. Portion of Leaf of <i>Sphagnum</i>	371
182. Structure of <i>Mosses</i> , after Jussieu	372
183. Antheridia and antherozoids of <i>Polytrichum</i> , after Thuret.	373
184. Mouth of Capsule of <i>Funaria</i>	374
185. Peristome of <i>Fontinalis</i> , after Payer	374
186. Ditto of <i>Bryum</i> , ditto	375
187. Ditto of <i>Cinclidium</i> , ditto	375
188. Section of Petiole of <i>Fern</i>	376
189. Sori of <i>Polypodium</i> , after Payer	377
190. Ditto of <i>Hemionitis</i> , ditto	378
191. Sorus and Indusium of <i>Aspidium</i>	378
192. Ditto of <i>Deparia</i> , after Payer	378
193. Development of Prothallium of <i>Pteris</i> , after Suminski	379
194. Antheridia and antherozoids of <i>Pteris</i> , after Suminski	381
195. Archegonium of <i>Pteris</i> , after Suminski	381
196. Spores of <i>Equisetum</i> , after Payer	384
197. Section of leaf of <i>Agave</i> , after Hartig	387
198. Section of <i>Aralia</i> (rice-paper)	388
199. Stellate Parenchyma of <i>Rush</i>	389
200. Cubical Parenchyma of <i>Nuphar</i>	389

	PAGE
201. Development of leaf-cells of <i>Anacharis</i> , after Wenham	390
202. Circulation in hairs of <i>Tradescantia</i> , after Slack	394
203. Testa of <i>Star-Anise</i>	396
204. Section of <i>Cherry-stone</i>	396
205. Section of <i>Coquilla-nut</i>	396
206. Spiral cells of <i>Oncidium</i>	397
207. Spiral fibres of <i>Collomia</i>	397
208. Cells of <i>Pæony</i> , filled with Starch	398
209. Starch-grains, under polarized light	399
210. Glandular fibres of <i>Coniferous Wood</i>	402
211. Vascular tissue of <i>Italian Reed</i> , after Schleiden	404
212. Transverse section of stem of <i>Palm</i>	406
213. Ditto of <i>Wanghie Cane</i>	407
214. Ditto of <i>Hazel</i>	410
215. Ditto of <i>Fossil Conifer</i>	411
216. Vertical section of <i>Fossil Conifer</i> , radial	411
217. Ditto Ditto, tangential	411
218. Ditto of <i>Mahogany</i>	412
219. Transverse section of <i>Aristolochia</i> (?)	414
220. Ditto of <i>Burdock</i>	415
221. Cuticle of <i>Yucca</i>	418
222. Ditto of <i>Indian Corn</i>	418
223. Ditto of <i>Apple</i> , after Brongniart	418
224. Ditto of <i>Rochea</i> , Ditto	419
225. Vertical Section of Leaf of <i>Rochea</i> , after Brongniart	420
226. Cuticle of <i>Iris</i> , Ditto	421
227. Vertical Section of Leaf of <i>Iris</i> , Ditto	422
228. Longitudinal Section of ditto, Ditto	423
229. Cuticle of Petal of <i>Geranium</i>	425
230. Pollen-grains of <i>Althæa</i> , &c.	428
231. Seeds of <i>Poppy</i> , &c.	432
232. <i>Gromia oviformis</i> , after Schulze	439
233. <i>Actinophrys sol</i> , after Claparède	440
234. <i>Amaba princeps</i> , after Ehrenberg	443
235. Various forms of <i>Amabina</i> , after Ehrenberg	445
236. <i>Gregarina</i> from Earthworm, after Lieberkühn	448
237. <i>Sphærozoum orodimare</i> , after Haeckel	450
238. <i>Kerona silurus</i> , and <i>Paramecium caudatum</i> , after Milne-Edwards	453
239. Group of <i>Vorticella</i> , after Ehrenberg	454
240. Fissiparous Multiplication of <i>Chilodon</i> , after Ehrenberg	458
241. Encysting process in <i>Vorticella</i> , after Stein	459
242. Metamorphosis of <i>Trichoda</i> , after Haime	461
243. <i>Brachionus pala</i> , after Milne-Edwards	470
244. <i>Rotifer vulgaris</i> , after Ehrenberg	471
245. Manducatory apparatus of <i>Euchlanis deflexa</i> , after Gosse	473
246. <i>Stephanoceros Eichornii</i> , after Ehrenberg	478
247. <i>Noteus quadricornis</i> , after Ehrenberg	480
248. <i>Rotalia ornata</i> , after Schulze	484
249. <i>Alveolina Quoyi</i>	492
250. Disk of Simple type of <i>Orbitolites</i>	493
251. Animal of ditto	494
252. Portion of animal of Complex type of <i>Orbitolites</i>	496
253. Internal casts of <i>Textularia</i> and <i>Rotalia</i> , after Ehrenberg	502
254. <i>Tinoporus baculatus</i>	503

	PAGE
255. Section of <i>Faujasina</i> , after Williamson	504
256. Internal cast of <i>Polystomella</i>	508
257. Vertical Section of <i>Nummulina</i>	511
258. Portion of ditto more highly magnified	512
259. Horizontal Section of <i>Nummulina</i>	512
260. Internal cast of <i>Nummulina</i>	513
261. <i>Heterostegina</i>	514
262. Section of <i>Orbitoides Fortisii</i> parallel to its surface	515
263. Portions of ditto, more highly magnified	515
264. Vertical Section of <i>Orbitoides Fortisii</i>	516
265. Internal cast of <i>Orbitoides Fortisii</i>	516
266. <i>Haliomma Humboldtii</i> , after Ehrenberg	524
267. <i>Perichlamydidium pratextum</i> , Ditto	524
268. <i>Stylodyctya gracilis</i> , Ditto	524
269. <i>Astromma Aristotelis</i> , Ditto	524
270. <i>Polycystina</i> , from Barbadoes, Ditto	525
271. Structure of <i>Grantia</i> , after Dobie	527
272. Portion of <i>Halichondria</i>	528
273. Siliceous spicules of <i>Pachymatisma</i>	530
274. <i>Hydra fusca</i> , after Milne-Edwards	534
275. Ditto, in gemmation, after Trembley	536
276. Medusa-buds of <i>Syncoryna</i> , after Sars	538
277. <i>Sertularia cupressina</i> , after Johnston	542
278. <i>Thaumantias pilosella</i> , after E. Forbes.	544
279. Development of <i>Medusa-buds</i> , after Dalyell.	545
280. Development of <i>Medusæ</i> Ditto	546
281. <i>Cydippe</i> and <i>Beroë</i> , after Milne-Edwards	548
282. <i>Noctiluca miliaris</i> , after Quatrefages	549
283. Spicules of <i>Alcyonium</i> and <i>Gorgonia</i>	551
284. Spicules of <i>Gorgonia guttata</i> and <i>Muricea elongata</i>	552
285. Filiferous capsules of <i>Actinia</i> , &c., after Gosse	553
286. Section of Shell of <i>Echinus</i>	556
287. Calcareous reticulation of Spine of <i>Echinus</i>	556
288. Ambulacral disk of <i>Echinus</i>	557
289. Transverse Section of Spine of <i>Acrocladia</i>	558
290. Spines of <i>Spatangus</i>	560
291. Structure of Tooth of <i>Echinus</i> , after Salter	561
292. Calcareous skeleton of <i>Astrophyton</i>	563
293. Calcareous Skeleton of <i>Holothuria</i>	566
294. Ditto of <i>Synapta</i>	567
295. Ditto of <i>Chirodota</i>	567
296. Bipinnarian larva of <i>Star-fish</i> , after Müller	569
297. Pluteus-larva of <i>Echinus</i> , after Müller	571
298. <i>Antedon rosaceus</i> (<i>Comatula rosacea</i>)	573
299. Pentacrinus-larva of <i>Antedon</i> , after Thompson	574
300. Cells of <i>Leprælia</i> , after Johnston	577
301. Bird's-head processes of <i>Cellularia</i> and <i>Bugula</i> , after Johnston and Busk	583
302. <i>Amaroucium proliferum</i> , after Milne-Edwards	586
303. <i>Botryllus violaceus</i> , Ditto	587
304. <i>Perophora</i> , after Lister	589
305. Transverse Section of shell of <i>Pinna</i>	594
306. Membranous basis of ditto	594
307. Vertical Section of ditto	595

	PAGE
308. Oblique Section of shell of <i>Pinna</i>	595
309. Section of hinge-tooth of <i>Mya</i>	598
310. Nacre of <i>Avicula</i>	599
311. Vertical Section of shell of <i>Unio</i>	600
312. Internal and external surfaces of Shell of <i>Terebratula</i>	601
313. Vertical Sections of ditto	602
314. Horizontal Section of shell of <i>Terebratula bullata</i>	603
315. Ditto ditto of <i>Megerlia lima</i>	603
16. Ditto ditto of <i>Spiriferina rostrata</i>	603
17. Palate of <i>Helix hortensis</i>	606
318. Ditto of <i>Zonites cellarius</i>	606
19. Ditto of <i>Trochus zizyphinus</i>	607
320. Ditto of <i>Doris tuberculata</i>	608
321. Ditto of <i>Buccinum</i> , under Polarized light	609
322. Parasitic Larvæ (<i>Glochidium</i>) of <i>Anodon</i> , after Houghton	611
323. Embryonic development of <i>Doris</i> , after Reid	612
324. Embryonic development of <i>Purpura</i>	615
325. Later stages of the same	616
326. Structure of <i>Polycelis</i> , after Quatrefages	625
327. Circulation of <i>Terebella</i> , after Milne-Edwards	627
328. <i>Actinotrocha branchiata</i> , after Wagener	630
329. Development of <i>Nemertes</i> from <i>Pilidium</i> , after Krohn	631
330. <i>Ammothea pycnogonoides</i> , after Quatrefages	637
331. <i>Cyclops quadricornis</i> , after Baird	640
332. Development of <i>Balanus</i> , after Bate	647
333. Metamorphoses of <i>Carcinus</i> , after Couch	650
334. Scale of <i>Morpho Menelaus</i>	656
335. Battledoor scale of <i>Polyommatus argus</i> , after Quekett	657
336. Scales of <i>Podura plumbea</i>	658
337. Hairs of <i>Myriapod</i> and <i>Dermestes</i>	659
338. Head and Eyes of <i>Bee</i>	661
339. Section of Eye of <i>Melolontha</i> , after Strauss-Durckheim	662
340. Eye of <i>Bee</i>	663
341. Antenna of <i>Cockchafer</i>	665
342. Portions of Ditto, more highly magnified	666
343. Tongue of <i>Fly</i>	668
344. Tongue, &c., of <i>Honey Bee</i>	669
345. Proboscis of <i>Vanessa</i>	670
346. Tracheal system of <i>Nepa</i> , after Milne-Edwards	674
347. Trachea of <i>Dytiscus</i>	675
348. Spiracle of <i>Fly</i>	675
349. Spiracle of Larva of <i>Cockchafer</i>	676
350. Foot of <i>Fly</i> , after Hepworth	680
351. Foot of <i>Dytiscus</i>	681
352. Eggs of Insects, after Burmeister	684
353. Foot, with combs, of <i>Spider</i>	688
354. Ordinary and glutinous threads of <i>Spider</i>	689
355. Minute structure of Bone, after Wilson	694
356. Lacunæ of ditto, highly magnified, after Mandl	695
357. Section of Bony scale of <i>Lepidosteus</i>	696
358. Vertical Section of Tooth of <i>Lamna</i> , after Owen	698
359. Transverse Ditto of <i>Pristis</i> , ditto	698
360. Ditto Ditto of <i>Myliobates</i>	699
361. Vertical Section of Human Tooth, after Mandl	700

	PAGE
362. Portion of Skin of <i>Sole</i>	701
363. Scale of <i>Sole</i>	702
364. Hair of <i>Sable</i>	705
365. Hair of <i>Musk-Deer</i>	705
366. Hair of <i>Squirrel</i> and <i>Indian Bat</i>	705
367. Transverse Section of Hair of <i>Pecari</i>	706
368. Structure of <i>Human Hair</i> , after Wilson	706
369. Transverse Section of Horn of <i>Rhinoceros</i>	709
370. Blood-corpuscles of <i>Frog</i> , after Donn�	710
371. Ditto of <i>Man</i> , ditto	711
372. Comparative sizes of Blood-corpuscles, after Gulliver	712
373. Altered White Corpuscle of Human Blood, after Beale	713
374. Fibrous Membrane of Egg-shell	714
375. White Fibrous Tissue	715
376. Portion of young Tendon, showing corpuscles of Germinal Matter, after Beale	715
377. Yellow Fibrous Tissue	716
378. Vertical Section of Skin of Finger, after Ecker	718
379. Pigment-cells of Choroid, after Henle	719
380. Pigment-cells of <i>Tadpole</i> , after Schwann	720
381. Epithelium-cells, from Mucous Membrane of Mouth, after Lebert	720
382. Ciliated Epithelium, after Mandl	721
383. Areolar and Adipose Tissue, after Mandl	722
384. Cartilage of Ear of <i>Mouse</i>	723
385. Cartilage of <i>Tadpole</i> , after Schwann	724
386. Follicles of Mammary Gland, with Secreting Cells, after Lebert	725
387. Fasciculus of Striated Muscular Fibre, after Mandl	726
388. Fibrill� of Striated Muscular Fibre of <i>Terebratula</i>	727
389. Fusiform Cells of Non-striated Muscular Fibre, after K�lliker	729
390. Nerve-cells and Nerve-fibres, after Ecker	730
391. Gelatinous Nerve-fibres, from Olfactory nerve	731
392. Distribution of Tactile Nerves in Skin, after Ecker	731
393. Capillary Circulation in Web of <i>Frog's</i> foot, after Wagner	735
394. Villi of Small Intestine of Monkey	743
395. Capillary network around Fat-cells	745
396. Capillary network of Muscle	745
397. Distribution of Capillaries in Mucous Membrane	746
398. Distribution of Capillaries in Skin of Finger	746
399. Portion of Gill of <i>Eel</i>	747
400. Interior of Lung of <i>Frog</i>	748
401. Section of Lung of <i>Fowl</i>	748
402. Section of <i>Human</i> Lung	749
403. Microscopic organisms in Levant Mud, after Williamson	754
404. Ditto ditto in Chalk, after Ehrenberg	756
405. Ditto ditto ditto ditto	757
406. Eye of <i>Trilobite</i> , after Buckland	762
407. Section of Tooth of <i>Labyrinthodon</i> , after Owen	763
408. Crystallized Silver	769
409. Radiating Crystallization of Santonine, after Davies	770
410. Radiating Crystallization of Sulphate of Copper and Magnesia, after Davies	771
411. Spiral Crystallization of Sulphate of Copper, after R. Thomas	772
412. Artificial Concretions of Carbonate of Lime, after Rainey	775

THE MICROSCOPE.

CHAPTER I.

OPTICAL PRINCIPLES OF THE MICROSCOPE.

1. *Laws of Refraction:—Spherical and Chromatic Aberration.*

1. ALL Microscopes in ordinary use, whether *Simple* or *Compound*, depend for their magnifying power on that influence exerted by Lenses, in altering the course of the rays of light passing through them, which is termed *Refraction*.* This influence takes place in accordance with the two following laws, which are fully explained and illustrated in every elementary treatise on Optics.†

I. A ray of light passing from a rarer into a denser medium, is refracted *towards* a line drawn perpendicularly to the plane which divides them; and *vice versâ*.

II. The *sines* of the angles of *incidence* and *refraction* (that is, of the angles which the ray makes with the perpendicular *before* and *after* its refraction) bear to one another a constant ratio for each substance, which is known as its *index of refraction*.

Thus the ray $E O$ (Fig. 1) passing from Air into Water, will not go on to F , but will be refracted towards the line $c c'$ drawn perpendicularly to the surface $A B$ of the water, so as to take the direction $o w$. If it pass into Glass, it will undergo a greater refraction, so as to take the direction $o g$. And if it pass into Diamond, the change in its course will be so much greater, that it will take the direction $o d$. The angle $E O C$ is termed the 'angle of incidence;' whilst the angles $w o c'$, $g o c'$ and $d o c'$ are the 'angles of refraction.' And whether the angle of incidence be

* It is not considered necessary in the present Treatise, to describe the *reflecting* Microscope of Amici; since this, although superior to the Microscopes in use previously to its introduction, has been completely superseded by the application of the Achromatic principle to the ordinary Microscope.

† See especially "Brooke's Elements of Natural Philosophy," Sixth Edition, Chaps. xvii.-xx.

large or small, its sine $e e'$ bears a constant ratio in each case to the sine $w w'$ or $g g'$ or $d d'$, of the angle of refraction; and this ratio is termed the 'index of refraction.'

The 'index of refraction' is determined for different media, by the amount of the refractive influence which they exert upon rays passing into them, not from air, but from a vacuum; and in expressing it, the sine of the angle of refraction is considered as the *unit*, to which that of the angle of incidence bears a fixed relation. Thus when we say that the 'index of refraction' of Water is 1.336, we mean that the sine $e e'$ of the angle of incidence $E o c$ of a ray

FIG. 1.

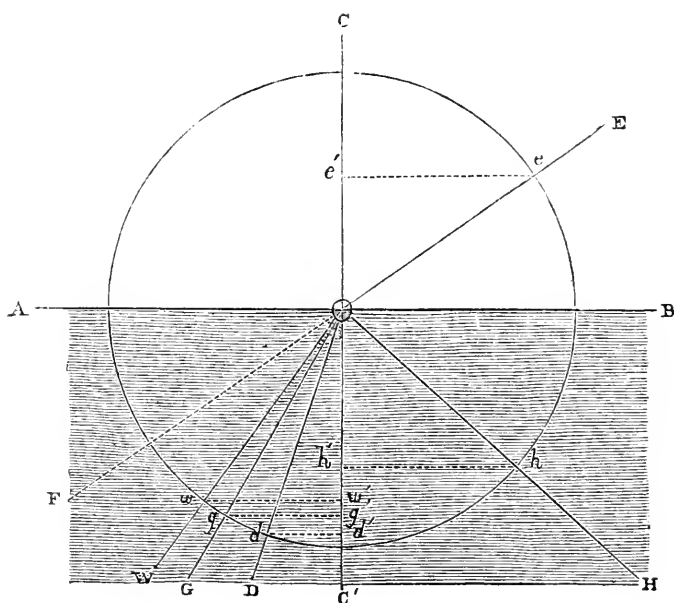

passing into water from a vacuum, is to the sine $w w'$ of the angle of refraction $w o c'$, as 1.336 to 1, or almost exactly as $1\frac{1}{3}$ to 1, or as 4 to 3. So, again, the index of refraction for (flint) Glass, being about 1.6, we mean that the sine $e e'$ of the angle of incidence of a ray $E o c$ passing into glass from a vacuum, is to the sine $g g'$ of the angle of refraction $g o c'$, as 1.6 to 1, or as 8 to 5. So in the case of Diamond, the sine $e e'$ is to the sine $d d'$ as 2.439 to 1, or almost exactly as $2\frac{1}{2}$ to 1, or as 5 to 2. Thus, the angle of incidence being given, the angle of refraction may be always found by *dividing* the sine of the former by the index of refraction, which

will give the sine of the latter. In accordance with these laws, a ray of light passing from one medium to another *perpendicularly*, undergoes no refraction; and of several rays at different angles, those nearer the perpendicular are refracted less than those more inclined to the refracting surface. When a pencil of rays, however, impinges on the surface of a denser medium (as when rays passing through Air fall upon Water or Glass), some of the incident rays are reflected from that surface, instead of entering it and undergoing refraction; and the proportion of these rays increases with the *increase* of their obliquity. Hence there is a *loss of light* in every case in which pencils of rays are made to pass through Lenses or Prisms: and this diminution in the brightness of the image formed by refraction will bear a proportion, on the one hand, to the number of surfaces through which the rays have had to pass; and on the other, to the degree of obliquity of the incident rays, and to the difference of the refractive powers of the two media. Hence in the passage of a pencil of rays out of Glass into Air, and then from Air into Glass again, the loss of light is much greater than it is when some medium of higher refractive power than air is interposed between the two glass surfaces; and advantage is taken of this principle in the construction of Achromatic combinations for the Microscope, the component lenses of each pair or triplet (§ 13) being cemented together by Canada Balsam; whilst it is also applied in another mode in the 'immersion lenses' recently brought into use on the Continent (§ 14). On the other hand, advantage is taken of the partial reflexion of rays passing from air to glass at an oblique angle to the surface of the latter, in the construction of the ingenious (non-stereoscopic) Binocular of Messrs. Powell and Lealand (§ 62).

2. On the other hand, when a ray *w* *o* emerges from a dense medium into a rare one, instead of following the straight course, it is bent *from* the perpendicular, according to the same ratio; and to find the course of the emergent ray, the sine of the angle of incidence must be *multiplied* by the 'index of refraction,' which will give the sine of the angle of refraction. Now when an emergent ray falls very obliquely upon the surface of the denser medium, the refraction which it would sustain in passing forth into the rarer medium, tending as it does to deflect it still farther from the perpendicular, becomes so great that the ray cannot pass out at all, and is reflected back from the plane which separates the two media, into the one from which it was emerging. This internal reflection will take place, whenever the product of the sine of the angle of incidence, multiplied by the index of refraction, exceeds the sine of 90° , which is the radius of the circle; and therefore the 'limiting angle,' beyond which an oblique ray suffers internal reflexion, varies for different substances in proportion to their respective indices of refraction. Thus, the index of refraction of Water being 1.336, no ray can pass out of it into a

vacuum,* if its angle of incidence exceed $48^{\circ} 28'$, since the sine $h h'$ of that angle, $n o c'$, multiplied by 1.336 , equals the radius; and in like manner, the 'limiting angle' for Flint-glass, its index of refraction being 1.60 , is $38^{\circ} 41'$.—This fact imposes certain limits upon the performance of microscopic Lenses, since of the rays which would otherwise pass out from glass into air, all the more oblique are kept back; whilst, on the other hand, it enables the Optician to make most advantageous use of glass Prisms for the purpose of *reflexion*, the proportion of the light which they throw back being much larger than that returned from the best polished metallic surfaces, and the brilliancy of the reflected image being consequently greater. Such Prisms are of great value to the Microscopist for particular purposes, as will hereafter appear. (§§ 26–29.)

3. The Lenses employed in the construction of Microscopes are chiefly *convex*; those of the opposite kind, or *concave*, being only used to make certain modifications in the course of the rays passing through convex lenses, whereby their performance is rendered more exact (§§ 10, 12).—It is easily shown to be in accordance with the

FIG. 2.

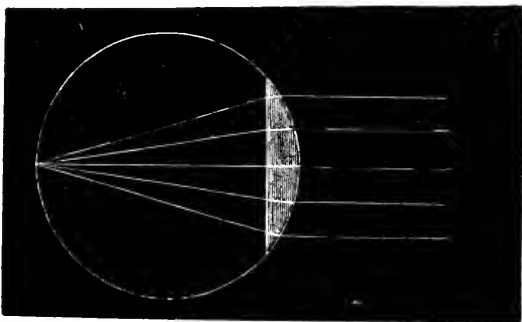

Parallel rays, falling on a *plano-convex* Lens, brought to a focus at the distance of the diameter of its sphere of curvature; and conversely, rays diverging from that point, rendered parallel.

laws of refraction already cited, that when a 'pencil' of parallel rays, passing through air, impinges upon a *convex* surface of glass, the rays will be made to converge; for they will be bent towards the centre of the circle, the radius being the perpendicular to each point of curvature. The central or axial ray, as it coincides with

* The reader may easily make evident to himself the internal reflection of Water, by nearly filling a wine-glass with water, and holding it at a higher level than his eye, so that he sees the surface of the fluid obliquely from beneath; no object held above the water will then be visible through it, if the eye be placed beyond the limiting angle; whilst the surface itself will appear as if silvered, through its reflecting back to the eye the light which falls upon it from beneath.

the perpendicular, will undergo no refraction ; the others will be bent from their original course in an increasing degree, in proportion as they fall at a distance from the centre of the lens ; and the effect upon the whole will be such, that they will be caused to meet at a point, called the *Focus*, some distance beyond the centre of curvature.—This effect will not be materially changed by allowing the rays to pass into air again through a *plane* surface of glass, perpendicular to the axial ray (Fig. 2) ; a lens of this description is called a *plano-convex* lens, and will hereafter be shown to possess properties which render it very useful in the construction of microscopes. But if, instead of passing through a plane surface, the rays re-enter the air through a second *convex* surface, turned in the opposite direction, as in a *double-convex* lens, they will be made to converge still more. This will be readily comprehended, when it is borne in mind that the contrary direction of the second surface, and the contrary direction of its refraction (this being *from* the denser medium, instead of *into* it), antagonize each other ; so that the second convex surface exerts an influence on the course of the rays passing through it, which is almost exactly equivalent to that of the first. Hence the focus of a *double-convex* lens will be at just half the distance, or (as commonly expressed) will be half the length of the focus of a *plano-convex* lens having the same curvature on one side (Fig. 3).

4. The distance of the Focus from the Lens will depend not merely upon its degree of curvature, but also upon the refracting

FIG. 3.

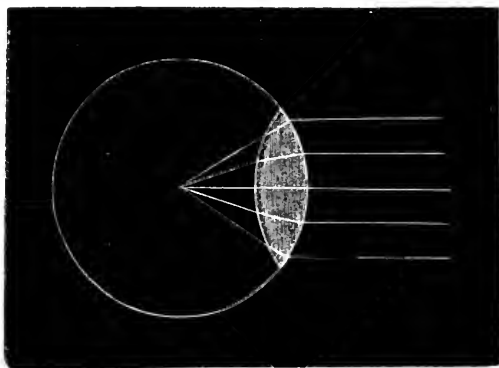

Parallel rays, falling on a *double-convex* Lens, brought to a focus in the centre of its sphere of curvature ; conversely, rays diverging from that point rendered parallel.

power of the substance of which it may be formed ; since the *lower* the index of refraction, the *less* will the oblique rays be deflected towards the axial ray, and the *more remote* will be their

point of meeting ; and conversely, the *greater* the refractive index, the *more* will the oblique rays be deflected towards the axial ray, and the *nearer* will be their point of convergence. A lens made of any substance whose index of refraction is 1·5, will bring parallel rays to a focus at the distance of its *diameter* of curvature, after they have passed through *one* convex surface (Fig. 2), and at the distance of its *radius* of curvature, after they have passed through *two* convex surfaces (Fig. 3); and as this ratio almost exactly expresses the refractive power of ordinary Crown or plate

FIG. 4.

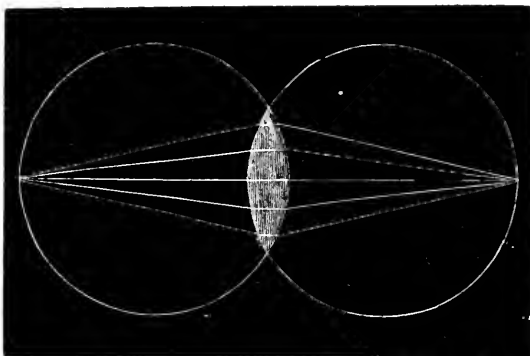

Rays diverging from the farther extremity of one diameter of curvature of a *double-convex* Lens, brought to a focus at the same distance on the other side.

Glass, we may for all practical purposes consider the 'principal focus' (as the focus for parallel rays is termed) of a *double-convex* lens to be at the distance of its Radius, that is, in the Centre of curvature, and that of a *plano-convex* lens to be at the distance of twice its radius, that is, at the other end of the Diameter of its sphere of curvature.

5. It is evident from what has preceded, that as a Double-convex Lens brings parallel rays to a focus in its Centre of curvature, it will on the other hand cause those rays to assume a parallel direction, which are diverging from that centre before they impinge upon it (Fig. 3) ; so that, if a luminous body be placed in the principal focus of a double-convex lens, its divergent rays, falling on one surface of the lens as a *cone*, will pass forth from its other side as a *cylinder*. If, however, the rays which fall upon a double-convex lens be diverging from the farther extremity of the Diameter of its sphere of curvature, they will be brought to a focus at an equal distance on the other side of the lens (Fig. 4) ; but the more the point of divergence is approximated to the centre or principal focus, the farther removed from the other side will be the point of convergence (Fig. 5), until, the point of divergence

being *at* the centre, there is no convergence at all, the rays being merely rendered parallel (Fig. 3) ; whilst, if the point of divergence be *beyond* the diameter of the sphere of curvature, the point of convergence will be within it (Fig. 5). The farther removed the point of divergence, the more nearly will the rays approach the

FIG. 5.

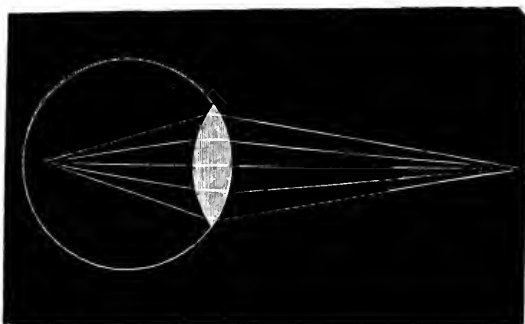

Rays diverging from points more distant than the principal focus of a *double-convex* Lens on either side, brought to a focus beyond it ; if the point of divergence be within the diameter of curvature, the focus of convergence will be beyond it ; and *vice versa*.

parallel direction : until, at length, when the object is very distant, its rays in effect become parallel, and are brought together in the principal focus (Fig. 3). If, on the other hand, the point of divergence be *within* the principal focus, they will neither be

FIG. 6.

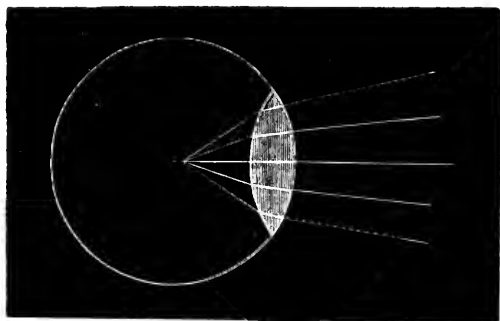

Rays already converging, brought together by a *double-convex* Lens at a point nearer than its principal focus ; and rays diverging from a point within its principal focus, still divergent, though in a diminished degree.

brought to converge nor be rendered parallel, but will diverge in a diminished degree (Fig. 6.) And conversely, if rays *already con-*

verging fall upon a double-convex lens, they will be brought together at a point nearer to it than its centre of curvature (Fig. 6).—The same principles apply equally to a Plano-convex lens; allowance being made for the double distance of its principal focus. They also apply to a lens whose surfaces have different curvatures; the principal focus of such a lens being found by multiplying the radius of one surface by the radius of the other, and dividing this product by half the sum of the same radii.—The rules by which the foci of convex lenses may be found, for rays of different degrees of convergence and divergence, will be found in works on Optics.

6. The refracting influence of *concave* Lenses will evidently be precisely the opposite of that of convex. Rays which fall upon them in a parallel direction, will be made to *diverge* as if from the principal focus, which is here called the *negative* focus. This will be, for a plano-concave lens, at the distance of the diameter of the sphere of curvature; and for a double-concave, in the centre of that sphere. In the same manner, rays which are converging to such a degree, that, if uninterrupted, they would have met in the principal focus, will be rendered parallel; if converging more, they will still meet, but at a greater distance; and if converging less, they will diverge as from a negative focus at a greater distance than that for parallel rays. If already diverging, they will diverge still more, as from a negative focus nearer than the principal focus; but this will approach the principal focus, in proportion as the distance of the point of divergence is such that the direction of the rays approaches the parallel.

7. If a Lens be convex on one side and concave on the other, forming what is called a *meniscus*, its effect will depend upon the proportion between the two curvatures. If they are equal, as in a Watch-Glass, scarcely any perceptible effect will be produced; if the Convex curvature be the greater, the effect will be that of a less powerful *convex* lens: and if the Concave curvature be the more considerable, it will be that of a less powerful *concave* lens. The focus of convergence for parallel rays in the first case, and of divergence in the second, may be found by dividing the product of the two radii by half their difference.

8. Hitherto we have considered only the effects of Lenses upon a 'pencil' of rays issuing from a single luminous point, and that point situated in the line of its axis. If the point be situated above the line of its axis, the focus will be below it, and *vice versâ*. The surface of every luminous body may be regarded as comprehending an infinite number of such points, from every one of which a pencil of rays proceeds, and is refracted according to the laws already specified; so that a complete but *inverted* Image or picture of the object is formed upon any surface placed in the Focus and adapted to receive the rays. It will be evident from what has gone before, that if the object be placed at twice the

distance of the principal focus, the Image, being formed at an equal distance on the other side of the lens (§ 5), will be of the same dimensions with the Object : whilst, on the other hand, if the object (Fig. 7, *a b*) be nearer the lens, the image *A B* will be farther from it, and of larger dimensions ; but if the object *A B* be farther from the lens, the image *a b* will be nearer to it, and smaller than

FIG. 7.

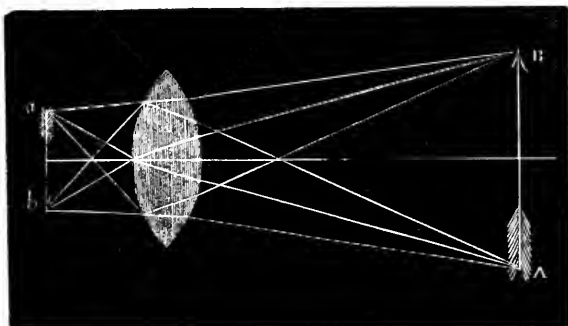

Formation of Images by Convex Lenses.

itself. Further, it is to be remarked that the larger the Image in proportion to the Object, the less bright will it be, because the same amount of light has to be spread over a greater surface ; whilst an image that is smaller than the object will be more brilliant in the same proportion.

9. A knowledge of these general facts will enable the learner to understand the ordinary operation of the Microscope ; but the

FIG. 8.

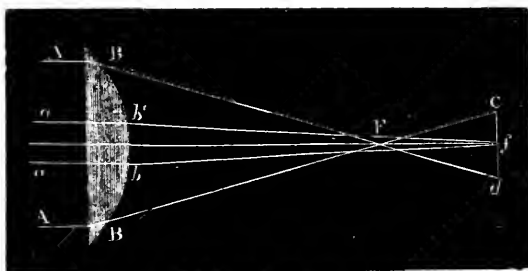

Diagram illustrating *Spherical Aberration*.

instrument is subject to certain optical imperfections, the mode of remedying which cannot be comprehended without an acquaintance with their nature. One of these imperfections results from the unequal refraction of the rays which pass through Lenses whose curvatures are equal over their whole surfaces. If the course

of the rays passing through an ordinary Convex Lens be carefully laid down (Fig. 8), it will be found that they *do not all meet exactly* in the foci already stated ; but that the focus F of the rays AB, AB , which have passed through the marginal portion of the lens, is much closer to it than that of the rays ab, ab , which are nearer the line of its axis. Hence, if a screen be held in the focus F of the marginal portion of the lens, the rays which have passed through its central portion will be stopped by it before they have come to a focus ; and if the screen be carried back into the focus f of the latter, the rays which were most distant from the axis will have previously met and crossed, so that they will come to it in a state of divergence, and will pass to c and d . In either case, therefore, the image will have a certain degree of indistinctness ; and there is no one point to which all the rays can be brought by a single Lens of Spherical curvature. The distance Ff , between the focal points of the central and of the peripheral rays of any lens, is termed its *Spherical Aberration*. It is obvious that, to produce the desired effect, the curvature requires to be increased around the centre of the lens, so as to bring the rays which pass through it more speedily to a focus ; and to be diminished towards the circumference, so as to throw the focus of the rays influenced by it to a greater distance. The requisite conditions may be theoretically fulfilled by a single lens, one of whose surfaces, instead of being spherical, should be a portion of an ellipsoid or hyperboloid of certain proportions ; but the difficulties in the way of the mechanical execution of lenses of this description are such, that for practical purposes this plan of construction is altogether unavailable ; and their performance would only be perfectly accurate for parallel rays.

10. Various means have been devised for reducing the Aberration of lenses of Spherical curvature. It may be considerably diminished, by making the most advantageous use of ordinary lenses. Thus, the aberration of a Plano-convex Lens whose convex side is turned towards parallel rays, is only $\frac{1}{100}$ ths of its thickness ; whilst, if its plane side be turned towards them, the aberration is $4\frac{1}{2}$ times the thickness of the lens. Hence, when a plano-convex lens is used to form an image by bringing to a focus parallel or slightly-diverging rays from a distant object, its *convex* surface should be turned towards the object ; but, when it is used to render parallel the rays which are diverging from a very near object, its *plane* surface should be turned towards the object. The single lens having the least spherical aberration, is a Double-convex whose radii are as *one to six* : when its flattest face is turned towards parallel rays, the aberration is nearly $3\frac{1}{2}$ times its thickness ; but when its most convex side receives or transmits them, the aberration is only $\frac{1}{120}$ ths of its thickness. Spherical Aberration is further diminished by reducing the aperture or working-surface of the lens, so as to employ only the rays that pass through its

central part, which, if sufficiently small in proportion to the whole sphere, will bring them all to nearly the same focus. Such a reduction is made in the Object-glasses of common (non-achromatic) Microscopes; in which, whatever be the size of the lens itself, the greater portion of its surface is rendered inoperative by a *stop*, which is a plate with a circular aperture interposed between the lens and the rest of the instrument. If this aperture be gradually enlarged, it will be seen that, although the image becomes more and more illuminated, it is at the same time becoming more and more indistinct; and that, in order to gain *defining power*, the aperture must be reduced again. Now this reduction is attended with two great inconveniences; in the first place, the loss of intensity of light, the degree of which will depend upon the quantity transmitted by the lens, and will vary therefore with its aperture: and, secondly, the diminution of the *angle of aperture*, that is, of the angle $a b c$ (Fig. 10) made by the most diverging of the rays of the pencil issuing from any point of an object that can enter the lens; on the extent of which angle depend some of the most important qualities of a Microscope (§ 131).—The Spherical Aberration may be got rid of altogether, however, by making use of *combinations* of lenses, so disposed that their opposite aberrations shall correct each other, whilst magnifying power is still gained. For it is easily seen that, as the aberration of a concave lens is just the opposite of that of a convex lens, the aberration of a convex lens placed in its most favourable position may be corrected by that of a concave lens of much less power in its most unfavourable position; so that, although the power of the convex lens is weakened, all the rays which pass through this combination will be brought to one focus. It is by a method of this kind that the Optician aims to correct the Spherical Aberration, in the construction of those combinations of lenses which are now employed as Object-glasses in all Compound Microscopes that are of any real value as instruments of observation. But it sometimes happens that this correction is not perfectly made; and the want of it becomes evident in the *fog* by which the distinctness of the image, and especially the sharpness of its outlines, is impaired.

11. But the spherical aberration is not the only imperfection with which the Optician has to contend in the construction of Microscopes. A difficulty equally serious arises from the unequal refrangibility of the several Coloured rays which together make up White or colourless light,* so that they are not all brought to the same focus, even by a lens free from spherical aberration. It is this difference in their refrangibility, which causes their complete separation or ‘dispersion’ by the Prism into a Spectrum; and it

* It has been deemed better to adhere to the ordinary phraseology, when speaking of this fact, as more generally intelligible than the language in which it might be more scientifically described, and at the same time leading to no practical error.

manifests itself, though in a less degree, in the image formed by a convex Lens. For if parallel rays of white light fall upon a Convex surface, the *most* refrangible of its component rays, namely, the *violet*, will be brought to a focus at a point somewhat nearer to the lens than the principal focus, which is the mean of the whole; and the converse will be true of the *red* rays, which are the *least* refrangible, and whose focus will therefore be more distant. Thus in Fig. 9, the rays of white light, $AB, A''B''$, which fall on the peripheral portion of the lens, are so far decomposed, that the violet rays are brought to a focus at c , and crossing there, diverge again and pass on towards FF ; whilst the red rays are not brought to a focus until D , crossing the divergent violet rays at EE . The foci of the intermediate rays of the spectrum (indigo, blue, green, yellow, and orange) are intermediate between these two extremes. The distance CD between the foci of the *violet* and of the *red* rays respectively is termed *Spherical Aberration*. If the image be received upon a screen placed at c —the focus of the violet rays,—

FIG. 9.

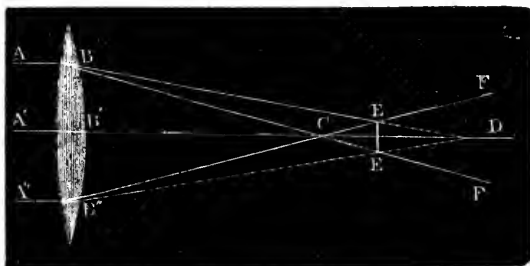
Diagram illustrating *Chromatic Aberration*.

violet will predominate in its own colour, and it will be surrounded by a prismatic fringe in which blue, green, yellow, orange, and red may be successively distinguished. If, on the other hand, the screen be placed at D —the focus of the red rays,—the image will have a predominantly red tint, and will be surrounded by a series of coloured fringes in inverted order, formed by the other rays of the spectrum which have met and crossed.* The line EE , which joins the points of intersection between the red and the violet rays, marks the 'mean focus,' that is, the situation in which the coloured fringes will be narrowest, the 'dispersion' of the coloured

* This experiment is best tried with a Lens of long focus, of which the central part is covered with an opaque stop, so that the light passes only through a peripheral ring; since, if its whole aperture be in use, the regular formation of the fringes is interfered with by the *spherical* aberration, which gives a different focus to the rays passing through each annular zone.

rays being the least. As the axial ray $A' B'$ undergoes no refraction, neither does it sustain any dispersion; and the nearer the rays are to the axial ray, the less dispersion do they suffer. Again, the more oblique the direction of the rays, whether they pass through the central or the peripheral portion of the lens, the greater will be the refraction they undergo, and the greater also will be their dispersion; and thus it happens that when, by using only the central part of a lens (§ 12), the chromatic aberration is reduced to its minimum, the central part of a picture may be tolerably free from false colours, whilst its marginal portion shall exhibit broad fringes.*

12. The Chromatic Aberration of a lens, like the Spherical, may be diminished by the contraction of its aperture, so that only its central portion is employed. But the error cannot be got rid of entirely by any such reduction, which, for the reasons already mentioned, is in itself extremely undesirable. Hence it is of the first importance in the construction of a really efficient Microscope, that the chromatic aberration of its 'Object-glasses' (in which the principal dispersion is liable to occur) should be entirely *corrected*, so that a large aperture may be given to these lenses without the production of any false colours. No such correction can be accomplished even theoretically in a single lens; but it may be effected by the combination of two or more, advantage being taken of the different relations which the *refractive* and the *dispersive* powers bear to each other in different substances. For if we can unite with a *convex* lens, whose dispersive power is *low* as compared to its refractive power, a *concave* of lower curvature, whose dispersive power is relatively *high*, it is obvious that the Dispersion of the rays occasioned by the convex lens may be effectually *neutralized* by the opposite dispersion of the concave (§ 6); whilst the Refracting power of the convex is only *lowered* by the opposite refraction of the concave, in virtue of the longer focus of the latter.—No difficulty stands in the way of carrying this theoretical correction into practice. For the 'dispersive' power of *flint-glass* bears so much larger a ratio to its refractive power than does that of *crown-glass*, that a convex lens of the former whose focal length is $7\frac{2}{3}$ inches, will produce the same degree of colour as a convex lens of crown-glass whose focal length is $4\frac{1}{2}$ inches. Hence a concave lens of the former material and curvature will fully correct the dispersion of a convex lens of the latter; whilst it diminishes its refractive power to such an extent only as to make its focus 10 inches. The correction for Chromatic Aberration in such a lens would be perfect, if it were not that although the extreme rays—violet and red—are thus brought to the same focus, the dispersion of the rest is not equally compensated; so that what is termed a *secondary spectrum* is produced, the images of objects seen through such a

* This is well seen in the large pictures exhibited by Oxy-hydrogen Microscopes.

lens being bordered on one side with a purple fringe, and on the other with a green fringe. Moreover, such a lens is not corrected for Spherical aberration; and it must of course be rendered free from this to be of any real service, however complete may be the freedom of its image from false colours. This double correction may be accomplished theoretically by the combination of *three* lenses, namely, a double-concave of flint placed between two double-convex of crown, ground to certain curvatures; and this method has long been employed in the construction of the large object-glasses of Telescopes, which are, by means of it, rendered *Achromatic*,—that is, are enabled to exert their refractive power without producing either Chromatic or Spherical aberration.

13. It has only been in comparatively recent times, however, that the construction of Achromatic object-glasses for Microscopes has been considered practicable; their extremely minute size having been thought to forbid the attainment of that accuracy which is necessary in the adjustment of the several curvatures, in order that the errors of each of the separate lenses which enters into the combination, may be effectually balanced by the opposite errors of the rest. The first successful attempt was made in this direction, in the year 1823, by MM. Selligues and Chevalier of Paris; the plan which they adopted being that of the combination of two or more pairs of lenses, each pair consisting of a double-convex of crown-glass, and a plano-concave of flint. In the next

FIG. 10.

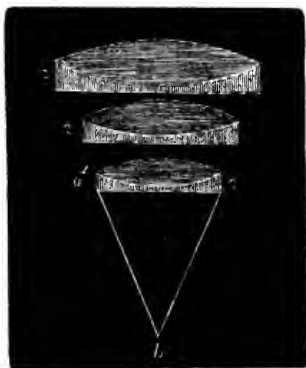

Section of an Achromatic Object-glass, composed of three pairs of lenses, 1, 2, 3, each formed of a double-convex of crown-glass and a plano-concave of flint; *a b c*, its Angle of Aperture.

year, Mr. Tulley, of London, without any knowledge of what had been accomplished in Paris, applied himself (at the suggestion of Dr. Goring) to the construction of Achromatic object-glasses for the Microscope; and succeeded in producing a single combination of three lenses (on the telescopic plan), the corrections of which were extremely complete. This combination, however, was not of high power, nor of large angular aperture; and it was found that these advantages could not be gained without the addition of a second combination. Prof. Amici at Modena, also, who had attempted the construction of microscopic object-glasses as early as 1812, but, despairing of success, had turned his attention to the application of the *reflecting* principle to the

Microscope, resumed his original labours on hearing of the success

of MM. Sellignes and Chevalier; and, by working on their plan, he produced, in 1827, an Achromatic combination which surpassed anything of the same kind that had been previously executed. From that time, the superiority of the plan of combining *three pairs** of lenses (Fig. 10, 1, 2, 3), which should be so adjusted as to correct each other's errors, to the telescopic combinations first adopted by Mr. Tulley, may be considered to have been completely established; and English opticians, working on this method, soon rivalled the best productions of Continental skill.

14. It was in this country that the next important improvements originated; these being the result of the theoretical investigations of Mr. J. J. Lister,† which led him to the discovery of certain properties in Achromatic combinations that had not been previously detected. Acting upon the rules which he laid down, practical Opticians at once succeeded in producing combinations far superior to any which had been previously executed, both in wideness of aperture, flatness of field, and completeness of correction; and continued progress has been since made in the same direction, by the like combination of theoretical acumen with manipulative skill. For the subsequent investigations of Mr. Lister have led him to suggest new combinations, which have been speedily carried into practical execution; and there is good reason to believe that the limit of perfection has now been nearly reached, since almost everything which seems theoretically possible has been actually accomplished. The most perfect Objectives at present in use for high powers, consist of as many as *eight* distinct lenses; the front and back being *triplet* combinations, with a *doublet* between. In this manner an Angular Aperture of no less than 170° has been obtained with an Objective of 1-12th inch focus; and it is obvious that as an increase of divergence of no more than 10° would bring the extreme rays into a straight line with each other, they would not enter the lens at all; so that no further enlargement of the aperture can be practically useful.—A principle of construction for Objectives of high power, first devised by Amici, has of late years been carried out by M. Hartnack (the successor of Oberhauser) of Paris, as also by MM. Nacet, with great success; that, namely, which is known as the *immersion system*. This consists in the interposition of a drop of water between the front lens of the objective and either the object itself or its covering-glass; so that the rays which leave it to enter the objective do not pass through air, but through water. It is easily shown that the loss of light dependent on the reflection of a portion of the oblique

* Some Opticians, however, prefer to place a single (uncorrected) plano-convex lens in the front of the objective, and to over-correct the combinations behind it: this method, which is believed by the Author, on the authority of Mr. Thomas Ross, to have been followed by Amici, seems particularly adapted to Objectives of about 1-4th inch focus and of moderate angular aperture.

† See his Memoir in the "Philosophical Transactions," for 1829.

rays from a surface of glass, whether they are entering or are quitting that surface, is much less when they pass from *water* into glass than from *air* into glass ; or *vice versâ*, from glass into *water* than from glass into *air*. Consequently, when the Object (the frustule of a Diatom for example) is covered with a drop of Water into which the objective dips, there is a much diminished loss of light alike at the surface of the object and at that of the lens ; and in the same manner, when a drop of water is interposed between the front lens of the objective and the covering-glass of an object mounted in balsam or in fluid, there is a much diminished loss of light at each of the glass surfaces. It is of course requisite that the corrections of the Objective should be specially adapted to the course of the rays which enter it from water, instead of from air ; and as the 'immersion-lenses' can therefore only be used *as such*, they are not universally applicable. It is perhaps in part on this account, and in part because they have succeeded in obtaining equally good results by methods of Illumination which are but little employed on the Continent, that English Opticians have not yet taken up the 'immersion-system.' The Author can bear testimony, however, to the fact that M. Hartnack is able to show most difficult Test Objects by oblique rays simply reflected from the mirror, with a brightness and definition which are only equalled by the best English objectives when used in combination with condensers and stops. And as it is of great advantage in Physiological investigation that the apparatus should be as *simple* as possible, he would strongly urge the Opticians of London, who are certainly unsurpassed either in theoretical acumen or in manipulative skill, to apply themselves to the production of 'immersion-lenses' that shall at least equal those of Parisian make.

15. The enlargement of the Angle of Aperture, and the greater completeness of the corrections, first obtained by the adoption of Mr. Lister's principles, soon rendered sensible an imperfection in the performance of these lenses under certain circumstances, which had previously passed unnoticed ; and the important discovery was made by Mr. A. Ross, that a very obvious difference exists in the precision of the image, according as the object is viewed *with* or *without* a covering of talc or thin glass ; an Object-glass which is perfectly adapted to either of these conditions, being sensibly defective under the other. The mode in which this difference arises, is explained by Mr. Ross as follows.* Let *o*, Fig. 11, be any point of an object ; *o p* the axial ray of the pencil that diverges from it ; and *o t*, *o t'*, two diverging rays, the one near *o*, the other remote from, the axial ray. Now if *g g g g* represent the section of a piece of thin glass intervening between the object and the object-glass, the rays *o t* and *o t'* will be refracted in their

* "Transactions of the Society of Arts," Vol. li.

passage through it, in the directions TR , $T'R'$; and on emerging from it again, they will pass on towards E and E' . Now if the course of these emergent rays be traced backwards, as by the dotted lines, the ray ER will seem to have issued from x , and the ray $E'R'$ from y ; and the distance xy is an aberration quite sufficient to disturb the previous balance of the aberrations of the lens

FIG. 11.

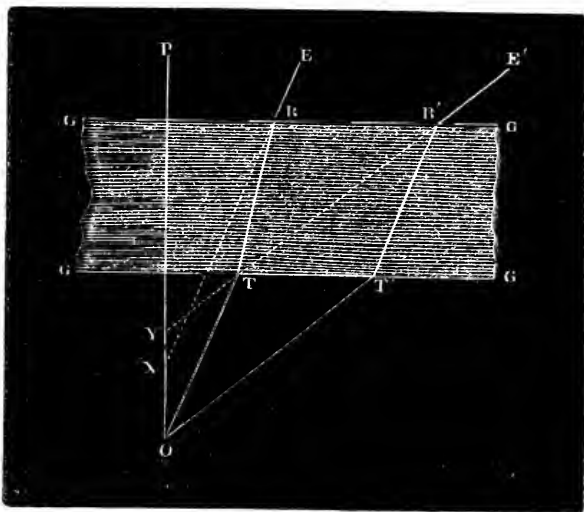

composing the object-glass. The requisite correction may be effected, as Mr. Ross pointed out, by giving to the *front* pair (Fig. 10, 1) of the three of which the Objective is composed, an excess of positive aberration (*i. e.*, by under-correcting it), and by giving to the other two pairs (2, 3) an excess of negative aberration (*i. e.*, by over-correcting them), and by making the distance between the former and the latter susceptible of alteration. For when the front pair is approximated most nearly to the other two, and its distance from the object is increased, its positive aberration is more strongly exerted upon the other pairs, than it is when the distance between the lenses is increased, and the distance between the front pair and the object is diminished. Consequently, if the lenses be so adjusted that their correction is perfect for an uncovered object, the front pair being removed to a certain distance from the others, its approximation to them will give to the whole combination an excess of positive aberration, which will neutralize the negative aberration occasioned by covering the object with a thin plate of glass.* This correction will obviously be more important

* The mode in which this Adjustment is effected will be more fitly described hereafter (§§ 113, 114).

to the perfect performance of the combination, the larger is its angle of aperture ; since the wider the divergence of the oblique rays from the axial ray, the greater will be the refraction which they will sustain in passing through a plate of glass, and the greater therefore will be the negative aberration produced, which, if uncorrected, will seriously impair the distinctness of the image. It is consequently not required for *low* powers, whose angle of aperture is comparatively small, nor for *medium* powers, so long as their angle of aperture does not exceed 50° ; and even objectives of 1-4th of an inch focus, whose angle of aperture does not exceed 70° , may be made to perform very well without adjustment if their corrections be originally made perfect for a thickness of glass of 1-100th of an inch (which is about an average of that with which objects of the finer kind are usually covered), being not much deranged by a difference of a few 1000ths of an inch, more or less, in that amount.

16. We are now prepared to enter upon the application of the Optical principles which have been explained and illustrated in the foregoing pages, to the construction of Microscopes. These are distinguished as *Simple* and *Compound* ; each kind having its peculiar advantages to the Student of Nature. Their essential difference consists in this : that in the former, the rays of light which enter the eye of the observer proceed directly from the *object* itself, after having been subjected only to a change in their course ; whilst in the latter, an enlarged *image* of the object is formed by a Lens, which image is viewed by the observer through a simple microscope, as if it were the object itself. The *Simple* Microscope *may* consist of *one* Lens ; but (as will be presently shown) it may be formed of *two*, or *even three* ; these, however, being so disposed as to produce an action upon the rays of light corresponding to that of a single lens. In the *Compound* Microscope, on the other hand, not less than two Lenses *must* be employed : one to form the enlarged image of the Object, and this, being nearest to it, is called the *Object-glass* ; whilst the other again magnifies that image, being interposed between it and the Eye of the observer, and is hence called the *Eye-glass*. A perfect Object-glass, as we have seen, must consist of a combination of lenses ; and the Eye-glass is best combined with another lens interposed between itself and the object-glass, the two together forming what is termed an *Eye-piece* (§ 21).—These two kinds of instrument need to be separately considered in detail.

2. *Simple Microscope.*

17. In order to gain a clear notion of the mode in which a Single Lens serves to ‘magnify’ minute objects, it is necessary to revert to the phenomena of ordinary Vision. An Eye free from any defect has a considerable power of adjusting itself, in such a

manner as to gain a distinct view of objects placed at extremely varying distances ; but the image formed upon the retina will of course vary in size with the distance of the object ; and the amount of detail perceptible in it will follow the same proportion. To ordinary eyes, however, there is a limit within which no distinct image can be formed, on account of the too great divergence of the rays of the different pencils which then enter the eye ; since the eye is usually adapted to receive, and to bring to a focus, rays which are parallel or but slightly divergent. This limit is variously stated at from 5 to 10 inches : but though there are doubtless many persons whose vision is good at the shorter range, yet the longer is probably the real limit for persons of ordinary vision ; who, though they may see objects much nearer the eye, see little if any more of their details, since what is gained in size is lost in distinctness. Now the utility of a convex lens interposed between a near object and the eye, consists in its reducing the divergence of the rays forming the several pencils which issue from it ; so that they enter the eye in a state of moderate divergence, as if they had issued from an object beyond the nearest limit of distinct vision ; and a well-defined picture is consequently formed upon the retina. Not only, however, is the course of the several rays in each pencil altered as regards the rest by this refracting process, but the course of the pencils themselves is changed, so that they enter the eye under an angle corresponding with that at which they would have arrived from a larger object situated at a greater distance. The picture formed upon the retina, therefore, by any object (Fig. 12), corresponds in all respects with one which would

FIG. 12.

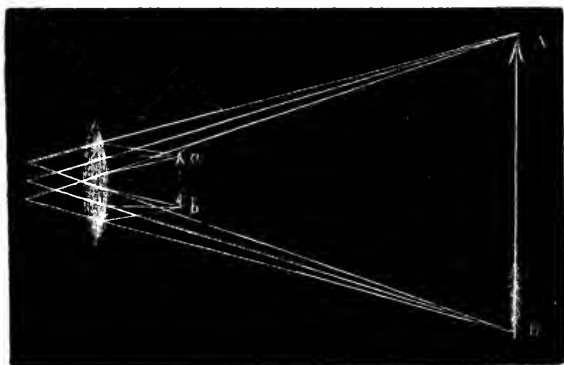

Diagram illustrating the action of the *Simple Microscope* : *a b*, object ;
 A B its magnified image.

have been made by the same object *a b* increased in its dimensions to A B, and viewed at the smallest ordinary distance of distinct vision. A 'short-sighted' person, however, who can see objects

distinctly at a distance of two or three inches, has the same power in his eye alone by reason of its greater convexity, as that which the person of ordinary vision gains by the assistance of a convex lens which shall enable him to see at the same distance with equal distinctness. It is evident, therefore, that the magnifying power of a single lens, depending as it does upon the proportion between the distance at which it renders the object visible, and the nearest distance of unaided distinct vision, must be different to different eyes. It is usually estimated, however, by finding how many times the focal length of the lens is contained in ten inches; since, in order to render the rays from the object nearly parallel, it must be placed nearly in the focus of the lens (Fig. 3); and the picture is referred by the mind to an object at the ordinary distance. Thus, if the focal length of a lens be one inch, its magnifying power for each dimension will be 10 times, and consequently 100 superficial; if its focal distance be only one-tenth of an inch, its magnifying power will be 100 linear, or 10,000 superficial. The use of the convex lens has the further advantage of bringing to the eye a much greater amount of light than would have entered the pupil from the enlarged object at the ordinary distance, provided its own diameter be greater than that of the pupil; but this can only be the case when its magnifying power is low.

18. It is obviously desirable, especially when Lenses of very high magnifying power are being employed, that their aperture should be as large as possible; since the light issuing from a minute object has then to be diffused over a large picture, and will be proportionally diminished in intensity. But the shorter the focus, the less must be the diameter of the sphere of which the lens forms a part; and unless the aperture be proportionally diminished, the Spherical and Chromatic aberrations will interfere so much with the distinctness of the picture, that the advantages which might be anticipated from the use of such lenses will be also negatived. Nevertheless, the Simple Microscope has been an instrument of extreme value in anatomical research, owing to its freedom from those errors to which the Compound Microscope, as originally constructed, was necessarily subject; the greater certainty of its indications being evident from the fact, that the eye of the observer receives the rays sent forth by the object itself, instead of those which proceed from an image of that object.—A history of the means employed by different individuals for procuring Lenses of extremely short focus, though possessing much interest in itself, would be misplaced here; since recent improvements, as will presently be shown, have superseded the necessity of all these. It may be stated, however, that Leeuwenhoek, De la Torre, and others among the older Microscopists, made great use of small globules procured by fusion of threads or particles of glass. The most important suggestion for the improvement of the Simple microscope composed of a single lens, proceeded some years ago from

Sir D. Brewster ; who proposed to substitute diamond, sapphire, garnet, and other precious stones of high refractive power, for glass, as the material of single lenses. A lens of much longer radius of curvature might thus be employed to gain an equal magnifying power ; and the aperture would admit of great extension, without a proportional increase in the spherical and chromatic aberrations. This suggestion was carried into practice by Mr. Pritchard with complete success, as regards the performance of lenses executed on this plan ; but independently of the costliness of their material, the difficulties of various kinds in the way of their execution are such as to render them very expensive ; and as they are not superior to the combination now to be described, they have latterly been quite superseded by it.—This combination, first proposed by Dr. Wollaston, and known as his *Doublet*, consists of two plano-convex lenses, whose focal lengths are in the proportion of one to three, or nearly so, having their convex sides directed towards the eye, and the lens of shortest focal length nearest the object. In Dr. Wollaston's original combination, no perforated diaphragm (or 'stop') was interposed ; and the distance between the lenses was left to be determined by experiment in each case. A great improvement was subsequently made, however, by the introduction of a 'stop' between the lenses, and by the division of the power of the smaller lens between two (especially when a very short focus is required) so as to form a *Triplet*, as was first suggested by Mr. Holland.* When combinations of this kind are well constructed, both the spherical and the chromatic aberrations are so much reduced, that the angle of aperture may be considerably enlarged without much sacrifice of distinctness ; and hence for all powers above 1-4th inch focus, Doublets and Triplets are far superior to Single Lenses. The performance of even the best of these forms of Simple microscope, however, is so far inferior to that of a good Compound microscope, as now constructed upon the Achromatic principle, that no one who has the command of the latter form of instrument would ever use the *higher* powers of the former. It is for the prosecution of observations and for the carrying on of dissections which only require *low* powers, that the Simple microscope is to be preferred ; and consequently, although doublets and triplets afforded the best means of obtaining a high magnifying power, before Achromatic lenses were brought to their present perfection, they are now comparatively little employed, except as *finders* (§ 35.)

19. Another form of Simple magnifier, possessing certain advantages over the ordinary double-convex lens, is that commonly known by the name of the 'Coddington' lens.† The first idea of

* "Transactions of the Society of Arts," Vol. xlix.

† This name, however, is most inappropriate ; since Mr. Coddington neither was, nor ever claimed to be, the inventor of the mode of construction by which this lens is distinguished.

it was given by Dr. Wollaston, who proposed to apply two plano-convex or hemispherical lenses by their plane sides, with a 'stop' interposed, the central aperture of which should be equal to 1-5th of the focal length. The great advantage of such a lens is, that the oblique pencils pass, like the central ones, at right angles to the surface; and that they are consequently but little subject to aberration. The idea was further improved upon by Sir D. Brewster, who pointed out that the same end would be much better answered by taking a sphere of glass, and grinding a deep groove in its equatorial part, which should be then filled with opaque matter, so as to limit the central aperture. Such a lens gives a large field of view, admits a considerable amount of light, and is equally good in all directions; but its power of definition is by no means equal to that of an achromatic lens, or even of a doublet. This form is chiefly useful, therefore, as a Hand-Magnifier, in which neither high power nor perfect definition is required; its peculiar qualities rendering it superior to an ordinary lens, for the class of objects for which a hand-magnifier of medium power is required. It should be stated, however, that many of the magnifiers sold as 'Coddington' lenses are not really portions of spheres, but are manufactured out of ordinary double-convex lenses, and are destitute, therefore, of many of the above advantages.—The 'Stanhope' lens somewhat resembles the 'Coddington' in appearance, but differs from it essentially in properties.—It is nothing more than a double-convex lens, having two surfaces of unequal curvatures, separated from each other by a considerable thickness of glass; the distance of the two surfaces from each other being so adjusted, that when the most convex is turned towards the eye, minute objects placed *on* the other surface shall be in the focus of the lens. This is an easy mode of applying a rather high magnifying power to scales of butterflies' wings, and other similar flat and minute objects, which will readily adhere to the surface of the glass; and it also serves to detect the presence of the larger Animalcules or of crystals in minute drops of fluid, to exhibit the 'eels' in paste or vinegar, &c. &c.—A modified form of the 'Stanhope' lens, in which the surface remote from the eye is plane instead of convex, has been brought out in France under the name of 'Stanhoscope,' and has been especially applied to the enlargement of minute pictures photographed on its plane surface in the focus of its convex surface. A good 'Stanhoscope,' magnifying from 100 to 150 diameters, is the most convenient form of Hand-magnifier for the recognition of Diatoms, Infusoria, &c.; all that is required being to place a minute drop of the liquid to be examined on the plane surface of the lens, and then to hold it up to the light.*

* See "Quart. Journ. of Microsc. Science," Vol. vii., N.S., p. 263.—Of the Stanhosopes sold by Toy-dealers at a very low price, only a part are really serviceable; care is requisite, therefore, in the selection.

3. *Compound Microscope.*

20. In its most simple form, this instrument consists of only two lenses, the *Object-glass* and the *Eye-glass*: the former, $c D$ (Fig. 13), receiving the rays of light direct from the object, $A B$, which is brought into near proximity to it, forms an enlarged and *inverted* image $A' B'$ at a greater distance on the other side; whilst the latter, $L M$, receives the rays which are diverging from this image, as if they proceeded from an object actually occupying its position and enlarged to its dimensions, and these it brings to the eye at E , so altering their course as to make that image appear far larger to the eye, precisely as in the case of the Simple microscope (§ 17).—It is obvious that, by the use of the very same Lenses, a considerable variety of magnifying power may be obtained, by merely altering their position in regard to each other and to the object; for if the *Eye-glass* be carried farther from the *Object-glass*, whilst the object is approximated nearer to the latter, the image $A' B'$ will be formed at a greater distance from it, and its dimensions will consequently be augmented. If, on the other hand, the *Eye-glass* be brought nearer to the *Object-glass*, whilst the object is removed farther from it, the distance of the image will be shortened, and its dimensions proportionably diminished. We shall hereafter see that this mode of varying the magnifying power of Compound Microscopes may be turned to good account in more than one mode (§§ 63, 64); but there are limits to the use which can be advantageously made of it. The amplification may also be varied by altering the magnifying power of the *Eye-glass*; but here, too, there are limits to the increase; since defects of the object-glass which are not perceptible when its image is but moderately enlarged, are brought into injurious prominence when the imperfect image is amplified to a much greater extent. In practice, it is generally found much better to vary the power by employing *Object-glasses* of different foci; an object-glass of *long* focus forming an image which is not at many times the distance of the object from the other side of the lens, and which, therefore, is not of many times its dimension; whilst an object-glass of *short* focus requires that the object should be so nearly approximated to it, that the distance of the image is a much higher multiple of that of the object, and its dimensions are proportionably larger (§ 8).—In whatever mode increased amplification may be obtained, two things must always result from the change: the portion of the surface of the object of which an image can be formed must be diminished; and the quantity of light spread over that image must be proportionably lessened.

21. In addition to the two lenses of which the Compound Microscope essentially consists, another (Fig. 14, $F F$) is usually introduced between the *Object-glass* and the image formed by it. The purpose of this lens is to change the course of the rays in such

a manner, that the image may be formed of dimensions not too great for the whole of it to come within the range of the Eye-glass; and as it thus allows more of the object to be seen at once, it is called the *Field-glass*. It is now usually considered, however,

FIG. 13.

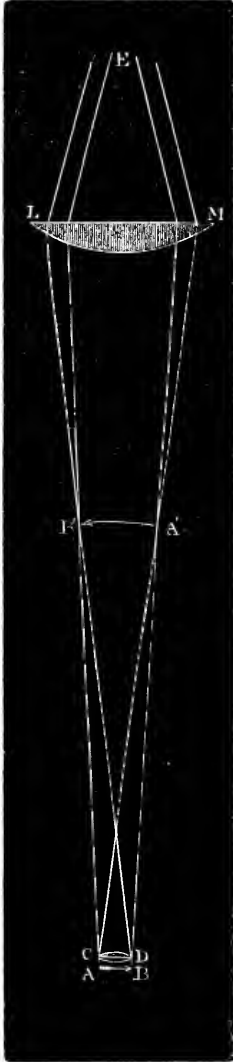

Diagram of simplest form of
Compound Microscope.

FIG. 14.

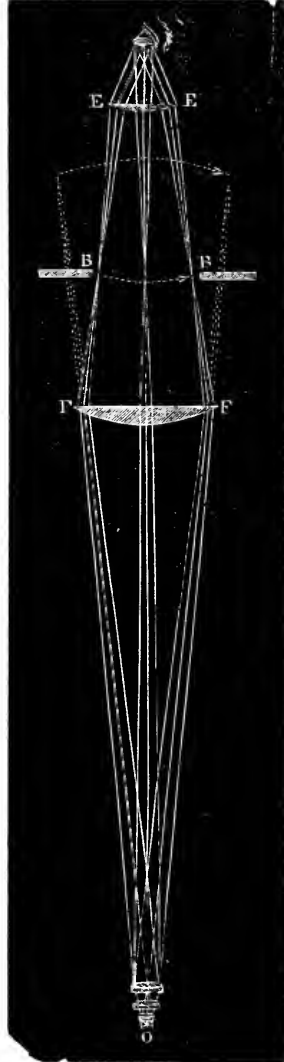
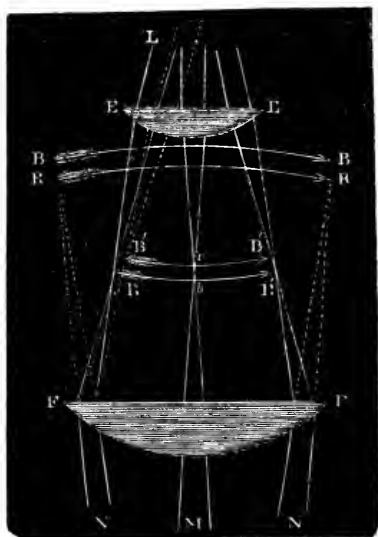

Diagram of complete
Compound Microscope.

as belonging to the ocular end of the instrument,—the *eye-glass* and the *field-glass* being together termed the *Eye-piece*. Various forms of this Eye-piece have been proposed by different Opticians ;

FIG. 15.



Section of *Huyghenian Eye-piece* adapted to over-corrected Achromatic objectives.

and one or another will be preferred according to the purpose for which it may be required. That which it is most advantageous to employ with Achromatic Object-glasses, to the performance of which it is desired to give the greatest possible effect, is termed the *Huyghenian* ; having been employed by Huyghens for his telescopes, although without the knowledge of all the advantages which its best construction renders it capable of affording. It consists of two plano-convex lenses (E E and F F, Fig. 14), with their plane sides towards the eye ; these are placed at a distance equal to half the sum of their focal lengths ; or, to speak with more precision, at half the sum of the focal length of the eye-

glass, and of the distance from the field-glass at which an image of the object-glass would be formed by it. A 'stop' or diaphragm, B B, must be placed between the two lenses, in the visual focus of the Eye-glass, which is, of course, the position wherein the image of the object will be formed by the rays brought into convergence by their passage through the field-glass.—Huyghens devised this arrangement merely to diminish the Spherical aberration ; but it was subsequently shown by Boscovich that the Chromatic dispersion was also in great part corrected by it. Since the introduction of Achromatic Object-glasses for Compound Microscopes, it has been further shown that all error may be avoided by a slight over-correction of these ; so that the blue and red rays may be caused to enter the eye in a parallel direction (though not actually coincident), and thus to produce a colourless image. Thus let L M X (Fig. 15) represent the two extreme rays of three pencils, which, without the field-glass, would form a blue image convex to the eye-glass at B B, and a red one at R R ; then, by the intervention of the field-glass, a blue image, concave to the eye-glass, is formed at B' B', and a red one at R' R'. As the focus of the Eye-glass is

shorter for blue rays than for red rays by just the difference in the place of these images, their rays, after refraction by it, enter the eye in a parallel direction, and produce a picture free from false colour. If the object-glass had been rendered perfectly achromatic, the blue rays, after passing through the field-glass, would have been brought to a focus at b , and the red at r ; so that an error would be produced, which would have been increased instead of being corrected by the eye-glass. Another advantage of a well-constructed Huyghenian eye-piece is, that the image produced by the meeting of the rays after passing through the field-glass, is by it rendered concave towards the eye-glass, instead of convex, so that every part of it may be in focus at the same time, and the field of view thereby rendered flat.*—Two or more Huyghenian Eye-pieces, of different magnifying powers, known as A, B, C, &c., are usually supplied with a Compound Microscope. The utility of the higher powers will mainly depend upon the excellence of the Objectives; for when an Achromatic combination of small aperture, which is sufficiently well corrected to perform very tolerably with a low eye-piece, is used with an Eye-piece of higher magnifying power (commonly spoken of as a 'deeper' one), the image may lose more in brightness and in definition than is gained by its amplification; whilst the image given by an Objective of large angular aperture and very perfect corrections, shall sustain so little loss of light or of definition by 'deep eye-piecing,' that the increase of magnifying power shall be almost clear gain. Hence the modes in which different Objectives of the same power, whose performance with shallow eye-pieces is nearly the same, are respectively affected by deep eye-pieces, afford a good test of their respective merits; since any defect in the corrections is sure to be brought out by the higher amplification of the image, whilst a deficiency of aperture is manifested by the want of light.—The working Microscopist will generally find the A eye-piece the most suitable, B being occasionally employed when a greater power is required to separate details, whilst C and others still deeper are chiefly useful for the purpose of testing the goodness of Objectives.

22. An Eye-piece is sometimes furnished with Achromatic Microscopes, especially for micrometric purposes, which, though composed of only two plano-convex lenses, differs essentially in its construction from the Huyghenian; the field-glass having its convex side upwards, and being so much nearer to the eye-glass that the image formed by the object-glass does not lie above (as at B B, Fig. 14), but below it. This 'positive' eye-piece, which is known as *Ramsden's*, gives a very distinct view in the central portion of

* Those who desire to gain more information upon this subject than they can from the above notice of it, may be referred to Mr. Varley's investigation of the properties of the Huyghenian Eye-piece, in the 51st volume of the "Transactions of the Society of Arts;" and to the article "Microscope," by Mr. Ross, in the "Penny Cyclopædia," reprinted, with additions, in the "English Cyclopædia."

the field ; but, as it does not, like the Huyghenian, correct the convexity of the image formed by the object-glass, but rather increases it, the marginal portions of the field of view, when the centre is in focus, are quite indistinct. Hence this Eye-piece cannot be recommended for ordinary use ; and its chief value to the Microscopist has resulted from its adaptation to receive a divided glass-micrometer, which may be fitted into the exact plane wherein the image is formed by the object-glass, so that its scale and that image are both magnified together by the lenses interposed between them and the eye. We shall hereafter see, however, that the same end may be so readily attained with the Huyghenian eye-piece (§ 68), that no essential advantage is gained by the use of that of Ramsden.—For viewing large flat objects, such as transverse sections of Wood (Plate XII.) or of Echinus-spines (Plate II. Fig. 1), under low magnifying powers, the Eye-piece known as *Kellner's* may be employed with advantage. In this construction the Field-glass, which is a double-convex lens, is placed in the focus of the Eye-glass, without the interposition of a diaphragm ; and the Eye-glass is an achromatic combination of a plano-concave of flint with a double-convex of crown, which is slightly under-corrected, so as to neutralize the over-correction given to the Objectives that are ordinarily used with Huyghenian eye-pieces (§ 21). A flat well-illuminated field of as much as fourteen inches in diameter may thus be obtained with very little loss of light ; but, on the other hand, there is a certain impairment of defining power, which renders the Kellner eye-piece unsuitable for objects presenting minute structural details ; and it is an additional objection that the smallest speck or smear upon the surface of the field-glass is made so unpleasantly obvious, that the most careful cleansing of that surface is required every time that this Eye-piece is used. Hence it is better fitted for the occasional display of objects of the character already specified, than it is for the ordinary wants of the working Microscopist.

4. *Stereoscopic Binocular Microscope.*

23. The admirable invention of the *Stereoscope* by Professor Wheatstone, has led to a general appreciation of the value of the *conjoint use of both eyes* in conveying to the mind a notion of the *solid forms* of objects, such as the use of either eye singly does not generate with the like certainty or effectiveness. And after several attempts, which were attended with various degrees of success, the principle of the *Stereoscope* has now been applied to the *Microscope*, with an advantage which those only can truly estimate, who (like the Author) have been for some time accustomed to work with the *Stereoscopic Binocular** upon objects that are

* It has become necessary to distinguish the *Binocular Microscope* which gives true *Stereoscopic* effects by the combination of two dissimilar pictures, from a *Binocular* which simply enables us to look with both eyes at images which are essentially identical (§ 62).

peculiarly adapted to its powers. As the result of this application cannot be rightly understood without some knowledge of one of the fundamental principles of Binocular vision, a brief account of this will be here introduced.—All Vision depends in the first instance on the formation of a picture of the object upon the retina of the Eye, just as the Camera Obscura forms a picture upon the ground glass placed in the focus of its lens. But the two images that are formed by the two Eyes respectively, of any solid object that is placed at no great distance in front of them, are far from being identical; the perspective projection of the object varying with the point of view from which it is seen. Of this the reader may easily convince himself by holding up a thin book in such a position that its back shall be at a moderate distance in front of the nose, and by looking at the book, first with one eye and then with the other; for he will find that the two views he thus obtains are essentially different, so that if he were to represent the book as he actually sees it with each eye, the two pictures would by no means correspond. Yet on looking at the Object with the two Eyes conjointly, there is no confusion between the Images, nor does the mind dwell on either of them singly; but from the union of the two a conception is gained of a solid projecting body, such as could only be otherwise acquired by the sense of Touch. Now if, instead of looking at the solid Object itself, we look with the *right* and *left* eyes respectively at *pictures* of the object, corresponding to those which would be formed by it on the retinae of the two eyes if it were placed at a moderate distance in front of them, and these visual pictures are brought into coincidence, the same conception of a solid projecting form is generated in the mind, as if the object itself were there. The Stereoscope—whether in the forms originally devised by Professor Wheatstone, or in the popular modification long subsequently introduced by Sir D. Brewster—simply serves to bring to the two Eyes, either by reflexion from mirrors, or by refraction through prisms or lenses, the two dissimilar Pictures which would accurately represent the solid object as seen by the two eyes respectively; throwing these on the two retinae in the precise positions they would have occupied if they had been formed there direct from the solid Object, of which the Mental Image (if the pictures have been correctly taken) is the precise counterpart.* Thus in Fig. 16 the upper pair of pictures, A, B, when combined in the Stereos-

* Although it is a comparatively easy matter to draw in outline two different perspective projections of a Geometrical Solid, such as those which are represented in Fig. 16, it would have been quite impossible to delineate landscapes, buildings, figures, &c., with the same precision; and the Stereoscope would never have obtained the appreciation it now enjoys, but for the ready means supplied by *Photography* of obtaining simultaneous pictures, perfect in their perspective, and truthful in their lights and shades, from two different points of view so selected as to give an effective Stereoscopic combination.

cope,* suggest the idea of a *projecting* truncated Pyramid, with the small square in the centre, and the four sides sloping equally away from it; whilst the lower pair, c, D (which are identical with the upper, but are transferred to opposite sides), no less vividly bring to the mind the visual conception of a *receding* Pyramid, still with the small square in the centre, but the four sides sloping equally towards it.

Fig. 16.

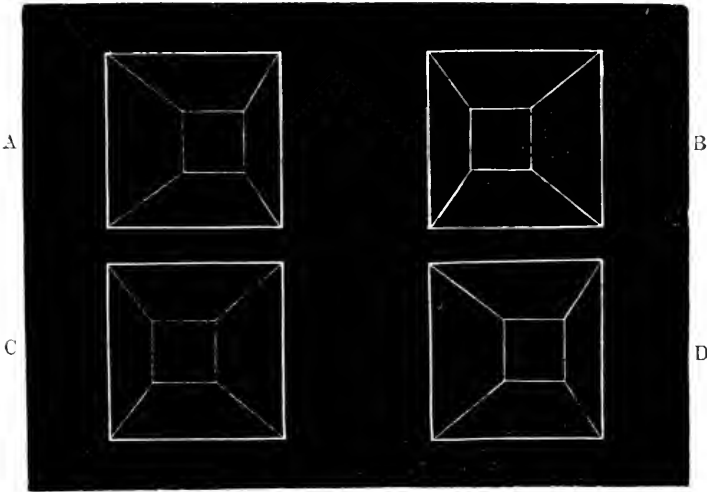

24. Thus we see that by simply *crossing* the Pictures in the Stereoscope, so as to bring before each eye the picture taken for the other, a 'Conversion of Relief' is produced in the resulting solid image; the projecting parts being made to recede, and the receding parts brought into relief. In like manner when several objects are combined in the same picture, their apparent relative distances are reversed; the remoter being brought nearer, and the nearer carried backwards; so that (for example) a Stereoscopic photograph, representing a man standing in front of a mass of ice, shall, by the crossing of the pictures, make the figure appear as if imbedded in the ice. A like conversion of relief may also be made in the case of actual solid Objects by the use of the *Pseudoscope*, an instrument devised by Professor Wheatstone, which has the effect of reversing the perspective projections of objects seen through it by the two eyes respectively; so that the interior of a basin or jelly-mould is made to appear as a projecting solid, whilst the

* This combination may be made without the Stereoscope, by looking at these figures with the axes of the eyes brought into convergence upon a somewhat nearer point, so that A is made to fall on B, and c on D.

exterior is made to appear hollow. Hence it is now customary to speak of *Stereoscopic* Vision as that in which the conception of the true natural relief of an object is called-up in the mind by the normal combination of the two perspective projections formed of it by the right and left eyes respectively; whilst by *Pseudoscopic* Vision, we mean that conversion of relief which is produced by the combination of two *reversed* perspective projections, whether these be obtained directly from the Object (as by the Pseudoscope), or from 'crossed' Pictures (as in the Stereoscope). It is by no means every Solid Object, however, or every pair of Stereoscopic Pictures, which can become the subject of this conversion. The degree of facility with which the 'converted' form can be apprehended by the Mind, appears to have great influence on the readiness with which the change is produced. And while there are some objects—the interior of a plaster mask of a face, for example—which can always be 'converted' (or turned inside-out) at once, there are others which resist such conversion with more or less of persistence.

25. Now it is easily shown theoretically, that the Picture of any projecting Object seen through the Microscope with only the *right*-hand half of an Objective having an even moderate angle of aperture, must differ sensibly from the picture of the same object received through the *left*-hand of the same objective; and further, that the difference between such picture must increase with the Angle of Aperture of the objective. This difference may be practically made apparent by adapting a 'stop' to the objective, in such a manner as to cover either the right or the left half of its aperture; and by then carefully tracing the outline of the object as seen through each half. But it is more satisfactorily brought into view by taking two Photographic pictures of the object, one through each lateral half of the Objective; for these pictures, when properly paired in the Stereoscope, give a magnified image *in relief*, bringing out on a large scale the solid form of the object from which they were taken. What is needed, therefore, to give the true Stereoscopic power to the Microscope, is a means of so bisecting the cone of rays transmitted by the objective, that of its two lateral halves one shall be transmitted to the right and the other to the left eye. If, however, the image thus formed by the *right* half of the objective of a Compound Microscope were seen by the *right* eye, and that formed by the *left* half were seen by the *left* eye, the resultant conception would be not *stereoscopic* but *pseudoscopic*; the projecting parts being made to appear receding, and *vice versa*. The reason of this is, that as the Microscope itself reverses the picture (§ 20), the rays proceeding through the *right* and the *left* hand halves of the Objective must be made to cross to the *left* and the *right* Eyes respectively, in order to correspond with the *direct* view of the object from the two sides; for if this second reversal does not take place, the effect of the first reversal of the images produced by the Microscope exactly corresponds with that produced by the

'crossing' of the Pictures in the Stereoscope, or by that reversal of the two perspective projections formed direct from the Object which is effected by the Pseudoscope (§ 24). From want of a due appreciation of this principle (the truth of which can now be practically demonstrated, § 29), the earlier attempts at producing a Stereoscopic Binocular Microscope tended rather to produce a 'Pseudoscopic conversion' of the objects viewed by it, than to represent them in their true relief.

26. *Nachet's Stereoscopic Binocular.*—The first really satisfactory solution of the problem was that worked out by MM. Nachet; whose original Binocular was constructed on the method shown in Fig. 17. The cone of rays issuing from the upper end of the Objective meets the flat surface of a Prism p whose section is an equilateral triangle; and is divided by reflexion within this prism into two lateral halves, which cross each other in its interior. For the rays of $a b$ forming the right half of the cone, impinging very obliquely on the internal face of the prism, suffer total reflexion (§ 2), emerging through its left side at right angles to its surface,

FIG. 17.

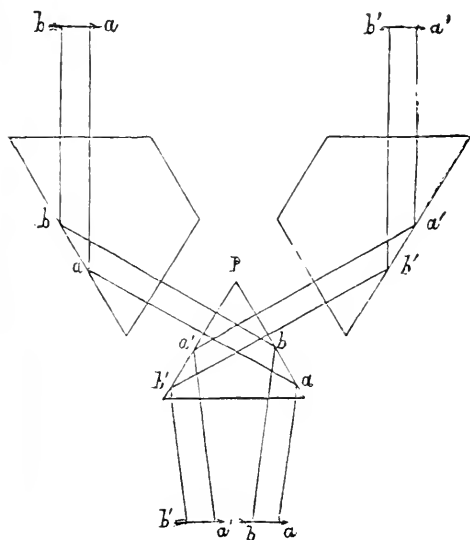

Arrangement of Prisms in Nachet's Stereoscopic Binocular Microscope.

left-hand body of the Microscope (Fig. 18), and the latter into its right-hand body. These two bodies are parallel; and by means of an adjusting screw at their base, which alters the distance between the central and the lateral Prisms, they can be

and therefore undergoing no refraction; whilst the rays $a' b'$ forming the left half of the cone, are reflected in like manner towards the right. Each of these pencils is received by a lateral Prism, which again changes its direction, so as to render it parallel to its original course; and thus the two halves $a b$ and $a' b'$ of the original pencil are completely separated from each other, the former being received into the

separated-from or approximated-towards each other, so that the distance between their axes can be brought into exact coincidence with the distance between the axes of the Eyes of the individual observer.—This instrument gives true Stereoscopic projection to the conjoint image formed by the mental fusion of the two distinct pictures; and with low powers of moderate angular aperture its

FIG. 18.

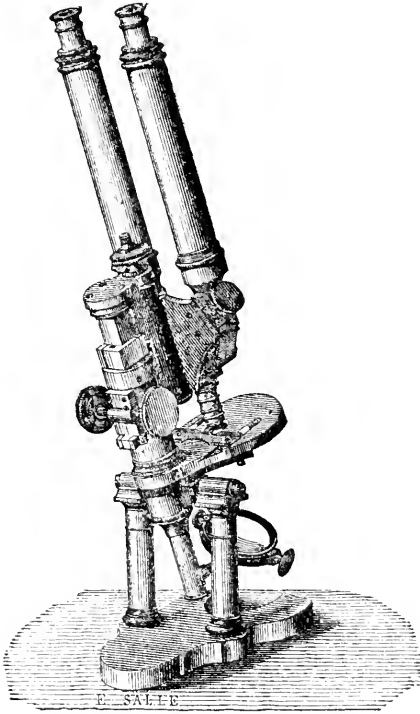

Nachet's Stereoscopic Binocular.

performance is highly satisfactory. There are, however, certain drawbacks to its general utility. First, every ray of each pencil suffers *two* reflexions, and has to pass through *four* surfaces; this necessarily involves a considerable loss of light, with a further liability to the impairment of the image by the smallest want of exactness in the form of either of the prisms. Second, the mechanical arrangements requisite for varying the distance of the bodies, involve an additional liability to derangement in the adjustment of the prisms. Third, the instrument can only be used for its own special purpose; so that the observer must also be provided with an ordinary Monocular Microscope, for the examination of objects unsuited to the powers of his Binocular. Fourth, the parallelism of the bodies involves parallelism of the axes of the observer's Eyes, the maintenance of which for any length of time is fatiguing.

27. *Wenham's Stereoscopic Binocular.*—All these objections are overcome in the admirable arrangement devised by the ingenuity of Mr. Wenham, the advantages of which are so great that no Microscope can now be considered complete which does not possess it.—In Mr. Wenham's Binocular the cone of rays proceeding upwards from the Objective is divided by the interposition of a Prism of the peculiar form shown in Fig. 19; this is so

placed in the tube which carries the objective (Figs. 20, 21, *a*), as only to interrupt one half, *a c*, of the cone, the other half, *a b*, going on continuously to the eye-piece of the principal body R, in the axis of which the objective is placed. The interrupted half of the cone (Fig. 19, *a*), on its entrance into the Prism, is scarcely subjected to any refraction, since its axial ray is perpendicular to the surface it meets; within the prism it is subjected to two reflexions at *b* and *c*, which send it forth again obliquely in the line *d* towards the eye-piece of the secondary body L; and since at its emergence its axial ray is again perpendicular to the surface of the glass, it suffers no more refraction on passing out of the prism than on entering it. By this arrangement the image received by the *right* Eye is formed by the rays which have passed through the *left* half of the Objective, and which have come on

FIG. 19.

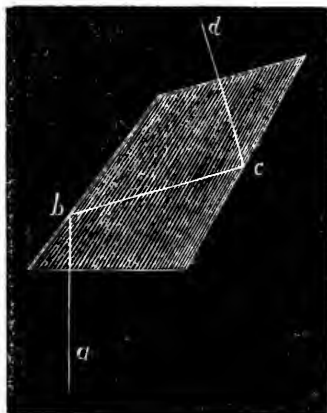

Wenham's Prism.

without any disturbance whatever; whilst the image received by the *left* Eye is formed by the rays which have passed through the *right* half of the Objective, and which have been subjected to two reflexions within the prism, passing through only *two* surfaces of glass. The adjustment for the variation of distance between the axes of the Eyes in different individuals, is made by drawing-out or pushing-in the Eye-pieces, which are moved consentaneously by means of a milled-head, as shown in Fig. 21.—Now although it may be objected to Mr. Wenham's method (1), that as the rays which pass through the prism and are obliquely reflected into the secondary body, traverse a longer distance than those which pass on uninterruptedly into the principal body, the picture formed by them will be somewhat larger than that which is formed by the other set; and (2) that the picture formed by the rays which have been subjected to the action of the prism must be inferior in distinctness to that formed by the uninterrupted half of the cone of rays,—these objections are found to have no practical weight. For it is well known to those who have experimented upon the phenomena of Stereoscopic vision, (1) that a slight difference in the size of the two pictures is no bar to their perfect combination; and (2) that if one of the pictures be good, the full effect of relief is given to the image, even though the other picture be faint and imperfect, provided that the outlines of the latter are sufficiently distinct to represent its perspective projection. Hence if, instead of the two

equally *half-good* pictures which are obtainable by MM. Nachet's original construction, we had in Mr. Wenham's one *good* and one *indifferent* picture, the latter would be decidedly preferable. But, in point of fact, the deterioration of the *second* picture in Mr. Wenham's arrangement is less considerable than that of *both* pictures in the original arrangement of MM. Nachet; so that the optical performance of the Wenham Binocular is in every way superior. It has, in addition, these further advantages over the

FIG. 20.

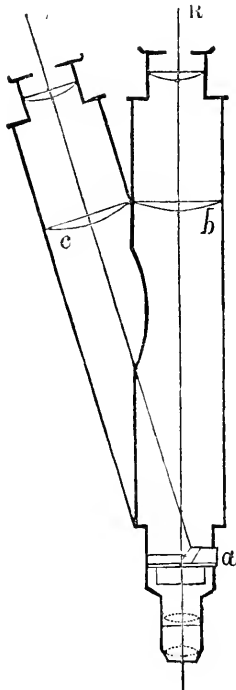
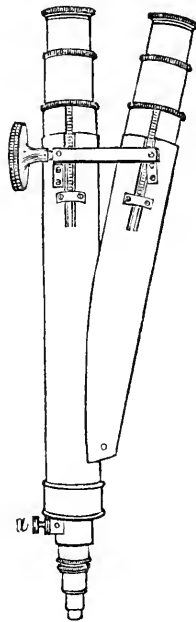

FIG. 21.



Wenham's Stereoscopic Binocular Microscope.

preceding :—*First*, the greater comfort in using it (especially for some length of time together), which results from the convergence of the axes of the Eyes at their usual angle for moderately-near objects; *second*, that this Binocular arrangement does not necessitate a special instrument, but may be applied to any Microscope which is capable of carrying the weight of the secondary body; for the prism is so fixed in a movable frame that it may in a moment be taken out of the tube or replaced therein, so that when it has been removed, the principal body acts in every respect as an ordinary

Microscope, the entire cone of rays passing uninterruptedly into it; and *third*, that the simplicity of its construction renders its derangement almost impossible.*

28. *Stereoscopic Binocular Eye-piece.*—An ordinary Microscope may be converted into a Stereoscopic Binocular, by an arrangement of prisms devised by Professor Smith, of Kenyon College, U.S. ; which corresponds in principle with that originally adopted by MM. Nacet (Fig. 17), but is made on a larger scale, and is inserted into the *upper* part of the body instead of into the lower, so as to divide the pencils of rays near the plane at which they would form the image into two lateral halves, according as they have proceeded from the opposite lateral halves of the Objective. These pencils are reflected back to their own sides by the median Prism; and each set, received and reflected upwards by one of the lateral prisms, forms its image in its own Eye-piece, the two images combining Stereoscopically, just as if the pencils which form them had been separated at the lower end of the body.—This arrangement has the advantage of being capable of use with high powers; but as it involves a decided loss of light and of definition, and as its construction is both more costly and more liable to derangement than that of Mr. Wenham, it is not likely to come into general acceptance.

29. *Nacet's Stereo-pseudoscopic Binocular.*—An ingenious modification of Mr. Wenham's arrangement has since been intro-

FIG. 22.

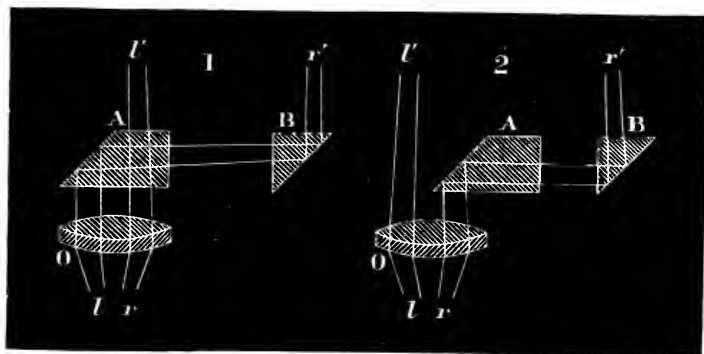

Arrangement of Prisms in Nacet's Stereo-pseudoscopic Binocular:—1, for Stereoscopic; 2, for Pseudoscopic effect.

duced by MM. Nacet, which has the attribute altogether peculiar to itself, of giving to the image either its true Stereoscopic projection, or a Pseudoscopic 'conversion of relief,' at the will of

* The Author cannot allow this opportunity to pass without expressing his sense of the liberality with which Mr. Wenham has freely presented to the Public this important invention, by which there can be no doubt that he might have largely profited if he had chosen to retain the exclusive right to it.

the observer. This is accomplished by the use of two Prisms, one of them (Fig. 22, A) placed over the cone of rays proceeding upwards from the Objective, and the other (B) at the base of the secondary or additional body, which is here placed on the right (Fig. 23). The Prism A has its upper and lower surfaces parallel; one of its lateral faces inclines at an angle of 45° , whilst the other is vertical. When this is placed in the position 1, so that its inclined surface lies over the *left half* (*l*) of the cone of rays, these rays, entering the prism perpendicularly (or nearly so) to its inferior plane surface, undergo total reflexion at its oblique face, and being thus

FIG. 23.

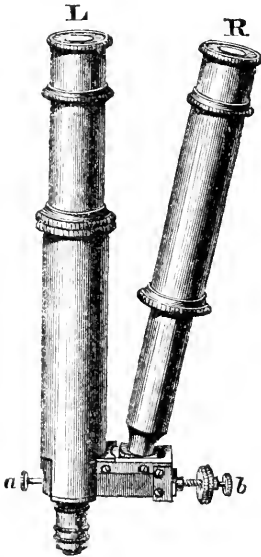

Nachet's Stereo-pseudoscopic Microscope.

turned into the horizontal direction, emerge through the vertical surface at right angles to it. They then enter the vertical face of the other Prism B; and after suffering reflexion within it, are transmitted upwards into the *right-hand* body, *r'*, passing out of the prism perpendicularly to the plane of emersion, which has such an inclination that the *right-hand* or secondary body (R, Fig. 23) may diverge from the left or principal body at a suitable angle. On the other hand, the *right* half (*r*) of the cone of rays passes upwards, without essential interruption, through the two parallel surfaces of the prism A, into the left-hand body (*l'*), and is thus crossed by the other in the interior of the prism. But if the Prism A be pushed over towards the right (by pressing the button *a*, Fig. 23), so as to leave the *left* half of the Objective uncovered (as in Mr. Wenham's arrangement), that half (*l*) of the cone of rays will go on without any interruption into the *left-hand* body (*l'*), whilst the *right* half (*r* *r'*) will be reflected by the oblique face of the prism into the horizontal direction, will emerge at its vertical face, and being received by the second prism, B, will be directed by it into the *right-hand* body (*r'*). The adjustment for the distance between the axes of the Eyes is made by turning the milled-head *b*, Fig. 23, which, by means of a screw-movement, acts upon a movable chariot that carries the prism B and the secondary body R, the base of which is implanted upon it.—Now in the *first* position, the two halves of the cone of rays being made to cross into the *opposite* bodies, true Stereoscopic relief is given to the image formed by their recombination, just as in the arrangements previously described.

When this is placed in the position 1, so that its inclined surface lies over the *left half* (*l*) of the cone of rays, these rays, entering the prism perpendicularly (or nearly so) to its inferior plane surface, undergo total reflexion at its oblique face, and being thus turned into the horizontal direction, emerge through the vertical surface at right angles to it. They then enter the vertical face of the other Prism B; and after suffering reflexion within it, are transmitted upwards into the *right-hand* body, *r'*, passing out of the prism perpendicularly to the plane of emersion, which has such an inclination that the *right-hand* or secondary body (R, Fig. 23) may diverge from the left or principal body at a suitable angle. On the other hand, the *right* half (*r*) of the cone of rays passes upwards, without essential interruption, through the two parallel surfaces of the prism A, into the left-hand body (*l'*), and is thus crossed by the other in the interior of the prism. But if the Prism A be pushed over towards the right (by pressing the button *a*, Fig. 23), so as to leave the *left* half of the Objective uncovered (as in Mr. Wenham's arrangement), that half (*l*) of the cone of rays will go on without any interruption into the

But when, in the *second* position, each half of the cone passes into the body of its own side, so that the reversal of the images produced by the Microscope itself (§ 20) is no longer corrected by the crossing of the two pencils separated by the Prism A, a Pseudoscopic effect, or 'conversion of relief,' is produced, the projections of the surface of the object being represented as hollows, and its concavities turned into convexities. The suddenness with which this conversion is brought about, without any alteration in the position either of the Object or of the Observer, is a phenomenon which no intelligent person can witness without interest; whilst it has a very special value for those who study the Physiology and Psychology of Binocular vision.* As an ordinary working instrument, however, this improved Nacet Binocular can scarcely be said to possess any point of superiority to the Wenham; whilst it must be regarded as inferior in the following particulars:—*First*, that as the uninterrupted half of the cone of rays (when the interposed prism is adjusted for Stereoscopic vision) has to pass through the *two* plane surfaces of the prism, a certain loss of light and deterioration of the picture are necessarily involved; whilst, as the interrupted half of the cone of rays has to pass through *four* surfaces, the picture formed by it is yet more unfavourably affected; *second*, that as power of motion must be given to *both* prisms—to A, for the reversal of the images, and to B for the adjustment of the distance between the two bodies—there is a greater liability to derangement than in the simpler construction of Mr. Wenham.†

30. The Stereoscopic Binocular is put to its most advantageous use, when applied either to *opaque* objects of whose solid forms we are desirous of gaining an exact appreciation, or to *transparent* objects which have such a thickness as to make the accurate distinction between their nearer and their more remote planes a matter of importance. That its best and truest effects can only be obtained by

* The result of the numerous applications which the Author has made of this instrument to a great variety of Microscopic objects, has led to a confirmation of the principle of Pseudoscopic vision, stated at the conclusion of § 24.—Where, as in the case of the saucer-like disks of the *Arachnoidiscus* (Plate x.), the real and the converted forms are equally familiar, the 'conversion' either of the convex exterior or of the concave interior is made both suddenly and completely. In more complex and less familiar forms, on the other hand, the conversion frequently requires time; being often partial in the first instance, and only gradually becoming complete. And there are some objects which resist conversion altogether, the only effect being a confusion of the two images.

† This arrangement, like Mr. Wenham's, can be adapted to any existing Microscope; and it seems peculiarly suitable to those of French or German construction, in which the body is much shorter than in the ordinary English models. For in the application of the Wenham arrangement to a *short* Microscope, the requisite distance between the Eye-glasses of its two bodies can only be obtained by making those bodies diverge at an angle so wide as to produce great discomfort in the use of the instrument, from the necessity of maintaining an unusual degree of convergence between the axes of the Eyes.

Objectives not exceeding 40° of Angular Aperture, may be shown both theoretically and practically. Taking the average distance between the pupils of the two Eyes as the base of a triangle, and any point of an object placed at the ordinary reading distance as its apex, the vertical angle enclosed between its two sides will be from 12° to 15° ; which, in other words, is the angle of divergence between the rays proceeding from any point of an object at the ordinary reading distance to the two Eyes respectively. This angle, therefore, represents that at which the two pictures of an object should be taken in the Photographic Camera, in order to produce the effect of ordinary Binocular vision without exaggeration; and it is the one which is adopted by Portrait-photographers, who have found by experience that a *smaller* angle makes the image formed by the combination of the pictures appear too *flat*, whilst a *larger* angle *exaggerates* its projection. Now, in applying this principle to the Microscope, we have to treat the two lateral halves (L, R, Fig. 24) of the Objective as the two separate lenses of a double Portrait Camera; and to consider at what angle each half should be entered by the rays passing through it to form its picture. To any one acquainted with the principles of Optics, it must be obvious that the picture formed by each half of the Objective must be (so to speak) an average or general resultant of the dissimilar pictures formed by its different parts.

FIG. 24.

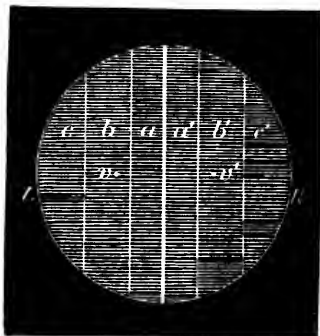

Thus, if we could divide the lateral halves or Semi-lenses L, R, of the Objective by vertical lines into the three bands $a\ b\ c$ and $a'\ b'\ c'$, and could stop-off the two corresponding bands on either side, so as only to allow the light to pass through the remaining pair, we should find that the two pictures we should receive of the object would vary sensibly, according as they are formed by the bands $a\ a'$, $b\ b'$, or $c\ c'$. For supposing the pictures taken through the bands $b\ b'$ to be suf-

ficiently dissimilar in their perspective projections, to give, when combined in the Microscope, a sufficient but unexaggerated Stereoscopic relief, those taken through the bands $a\ a'$ on either side of the centre would be no more dissimilar than two portraits taken at a very small angle between the Cameras, and their combination would very inadequately bring out the effect of relief; whilst, on the other hand, the two pictures taken through the extreme lateral bands $c\ c'$, would differ as widely as portraits taken at too great an angle of divergence between the Cameras, and their combination would exaggerate the actual relief of the object. Now, in each of the

bands bb' , a spot vv' may be found by mathematical computation, which may be designated the *visual centre* of the whole Semi-lens ; that is, the spot which, if all the rest of the semi-lens were stopped-off, would form a picture most nearly corresponding to that given by the whole of it. This having been determined, it is easy to ascertain what should be the Angle of Aperture (opq , Fig. 25) of the entire Lens, in order that the angles vpv' between the 'visual centres' of its two halves should be 15° . The investigation of this question having been kindly undertaken for the Author by his friend Prof. Hirst, the conclusion at which he has arrived is, that the angle of aperture of the entire Lens should be about 36.6° . This, which he gives as an *approximate* result only (the requisite data for a complete Mathematical solution of the question not having yet been obtained), harmonizes most remarkably with the results of experimental observations made upon objects of known shape, with Objectives of different angular apertures ; so that the Stereoscopic images produced by the several objectives may be compared, not only with each other, but with the actual forms which they ought to present. No better objects can be selected for this purpose, than those which are perfectly spherical ; such as various globular forms of the *Polycystina* (Plate XIX.), or the Pollen-grains of the *Mal-*

FIG. 25.

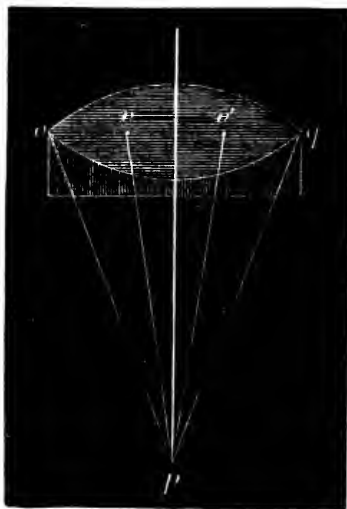

vaceæ and many other Flowering-plants (Fig. 230). Now when either of these is placed under a Stereoscopic Binocular, provided with an Objective of *one-half* or *four-tenths* of an inch focus having an angular aperture of 80° or 90° , the effect of projection is so greatly exaggerated, that the side next the eye, instead of resembling a hemisphere, looks like the small end of an egg. If, then, the aperture of such an Objective be reduced to 60° by a diaphragm placed behind its back lens, the exaggeration is diminished, though not removed ; the hemispherical surface now looking like the large end of an egg. But if the aperture be further reduced to 40° by the same means, it is at once seen that the hemispheres turned towards the eye are truly represented ; the effect of projection being quite adequate, without being in the least exaggerated. Hence it may be confidently affirmed—alike on theoretical and on

practical grounds—that when an Objective of wider angle than 40° is used with the Stereoscopic Binocular, the object viewed by it is represented in exaggerated relief, so that its apparent form must be more or less distorted.—There are other substantial reasons, moreover, why Objectives of limited Angle of aperture should be preferred (save in particular cases) for use with the Stereoscopic Binocular. As the special value of this instrument is to convey to the mind a notion of the *solid forms* of objects, and of the relations of their parts to each other, not merely on the same but on different planes, it is obvious that those Objectives are most suitable to produce this effect, which possess the greatest amount of *penetration* or *focal depth*, that is, which most distinctly show, not merely what is precisely in the focal plane, but what lies nearer to or more remote from the Objective. Now, as will be explained hereafter (§ 131, II.), increase of the Angle of Aperture is necessarily attended with diminution of Penetrating power; so that an Objective of 60° or 80° of aperture, though exhibiting minute surface-details which an Objective of 40° cannot show, is much inferior in suitability to convey a true conception of the general form of any object, the parts of which project considerably above the focal plane or recede below it.*

31. In concluding these general observations upon the use of the Stereoscopic Binocular, the Author would draw attention to two important advantages he has found it to possess; his own experience on these points being fully confirmed by that of others. In the *first* place, the *Penetrating power* or *Focal Depth* of the Binocular is greatly superior to that of the Monocular Microscope; so that an object whose surface presents considerable inequalities, is very much more distinctly seen with the former than with the latter. The difference may in part be attributed to the practical reduction in the Angle of Aperture of the Objective, which is produced by the division of the cone of rays transmitted through it into two halves; so that the picture received through each half of an Objective of 60° is formed by rays diverging at an angle of only 30° . But that this optical explanation does not go far to account for the fact, is easily proved by the simple experiment of looking at the object in the first instance through each eye separately (the prism being in place), and then with both eyes together; the distinctness of the parts which lie above and beneath the focal

* In accordance with these principles, the Author has caused Messrs. Powell and Lealand to construct for him an Objective of Half-inch focus with an Angular aperture of 40° ; and he has found it to answer most admirably the purpose for which it was intended,—the examination of Opaque objects with the Stereoscopic Binocular. For not only are these represented in their true forms, but the relations of their different parts are seen with a completeness not otherwise attainable. And an Objective so constructed has this great advantage over one whose originally large aperture has been reduced by a diaphragm,—that the distance between its front lens and the object is so much greater, as to admit far more conveniently of *side* Illumination.

plane being found to be much greater when the two pictures are combined, than it is in either of them separately. In the absence of any adequate Optical explanation of the greater range of focal depth thus shown to be possessed by the Stereoscopic Binocular, the Author is inclined to attribute it to an allowance for the relative distances of the parts which seems to be unconsciously made by the *Mind* of the observer, when the solid image is shaped out in it by the combination of the two pictures. This seems the more likely from the *second* fact to be now mentioned: namely, that when the Binocular is employed upon objects suited to its powers, the prolonged use of it is attended with *very much less fatigue* than is that of the Monocular Microscope. This, again, may be in some degree attributed to the division of the work between the two eyes; but the Author is satisfied that, unless there is a feeling of discomfort in the Eye itself, the sense of fatigue is rather *mental* than *visual*, and that it proceeds from the constructive effort which the observer has to make, who aims at realizing the solid form of the object he is examining, by an interpretation based on the *flat picture* of it presented by his vision, aided only by the use of the Focal Adjustment, which enables him to determine what are its near and what its remote parts, and to form an estimate of their difference of distance (§ 121.) Now, a great part of this constructive effort is saved by the use of the Binocular, which at once brings before the Mind's eye the *solid image* of the object, and thus gives to the observer a conception of its form usually more complete and accurate than he could derive from any amount of study of a Monocular picture.*

* It has happened to the Author to be frequently called on to explain the advantages of the Binocular to Continental (especially German) *Savans* who had not been previously acquainted with the instrument. And he has been struck with finding that when he exhibited to them objects with which they had already become familiar by careful study, and of whose solid forms they had attained an accurate conception, they perceived no advantage in the Stereoscopic combination, seeing such objects with it (visually) just as they had been previously accustomed to see them (mentally) without it. But when he has exhibited to them suitable objects with which they had *not* been previously familiarized, and has caused them to look at these in the first instance *Monocularly*, and then *Stereoscopically*, he has never failed to satisfy them of the value of the latter method, except when some visual imperfection has prevented them from properly appreciating it. He may mention that he has found the wing of the Moth known as *Zenzera Esculi*, which has an undulating surface, whereon the scales are set at various angles, instead of having the usual imbricated arrangement, a peculiarly appropriate object for this demonstration; the general inequality of its surface, and the individual obliquities of its scales, being at once shown by the Binocular, with a force and completeness which could not be attained by the most prolonged and careful Monocular study.

CHAPTER II.

CONSTRUCTION OF THE MICROSCOPE.

32. THE *Optical* principles whereon the operation of the Microscope depends having now been explained, we have next to consider the *Mechanical* provisions whereby they are brought to bear upon the different purposes which the instrument is destined to serve. And first, it will be desirable to state those general principles which have now received the sanction of universal experience, in regard to the best arrangement of its constituent parts.—Every *complete* Microscope, whether Simple or Compound, must possess, in addition to the Lens or combination of lenses which affords its magnifying power, a *Stage* whereon the Object may securely rest, a *Concave Mirror* for the illumination of Transparent objects from beneath, and a *Condensing-lens* for the illumination of Opaque objects from above.

I. Now, in whatever mode these may be connected with each other, it is essential that *the optical part and the stage should be so disposed as either to be altogether free from tendency to vibration, or to vibrate together*; since it is obvious that any movement of one, in which the other does not partake, will be augmented to the eye of the observer in proportion to the magnifying power employed. In a badly-constructed instrument, even though placed upon a steady table resting upon the firm floor of a well-built house, when high powers are used, the object is seen to oscillate so rapidly at the slightest tremor—such as that caused by a person walking across the room, or by a carriage rolling-by in the street—as to be frequently almost indistinguishable: whereas in a well-constructed microscope, scarcely any perceptible effect will be produced by even greater disturbances. Hence, in the choice of a Microscope, it should always be subjected to this test, and should be unhesitatingly rejected if the result be unfavourable. If the instrument should be found free from fault when thus tested with *high* powers, its steadiness with *low* powers may be assumed; but, on the other hand, though a Microscope may give an image free from perceptible tremor when the lower powers only are employed, it may be quite unfit for use with the higher.

II. The next requisite is *a capability of accurate adjustment to*

every variety of focal distance, without movement of the object. It is a principle now universally recognized in the construction of good Microscopes, that the *Stage* whereon the object is placed should be a *fixture*; the movement by which the Focus is to be adjusted being given to the Optical portion. This movement should be such as to allow free range from a minute fraction of an inch to three or four inches, with equal power of obtaining a delicate adjustment at any part. It should also be so accurate, that the optic axis of the instrument should not be in the least altered by any movement in a vertical direction; so that if an object be brought into the centre of the field with a low power, and a higher power be then substituted, it should be found in the centre of *its* field, notwithstanding the great alteration in the focus. In this way much time may often be saved by employing a low power as a *finder* for an object to be examined by a higher one; and when an object is being viewed by a succession of powers, little or no readjustment of its place on the stage should be required. For the Simple Microscope, in which it is seldom advantageous to use lenses of shorter focus than 1-4th inch (save where Doublets are employed, § 18), a *rack-and-pinion* adjustment, if it be made to work both tightly and smoothly, answers sufficiently well; and this is quite adequate also for the focal adjustment of the Compound body, when Objectives of low power only are employed. But for any lenses whose focus is less than half an inch, a 'fine adjustment,' or 'slow motion,' by means of a *screw-movement* operating either on the object-glass alone or on the entire body, is of great value; and for the highest powers it is quite indispensable. In some Microscopes, indeed, which are provided with a 'fine adjustment,' the rack-and-pinion movement is dispensed with, the 'coarse adjustment' being given by merely *sliding* the body up and down in the socket which grasps it; but this plan is only admissible where, for the sake of extreme cheapness or portability, the instrument has to be reduced to the form of utmost simplicity (Figs. 40, 41). Where only one means of focal adjustment is provided, this is best afforded by the substitution of the *chain-movement* for the rack-and-pinion, as in Mr. Ladd's Microscope (Fig. 36). This has the advantage of being smoother and more sensitive, of being less likely to become unequal by wear, and of being easily tightened if it should 'lose time;' whilst its delicacy and smoothness admit of an exact adjustment being made by its means alone, even when moderately high powers are employed, in the manner to be presently described. It will be shown hereafter that the use of the 'slow motion' is by no means restricted to the exact adjustment of the focus; and it cannot be advantageously dispensed with in a Microscope which is to be used for any but the most common purposes.

III. Scarcely less important than the preceding requisite, in the case of the Compound Microscope, though it does not add much to

the utility of the Simple, is *the capability of being placed in either a vertical or a horizontal position, or at any angle with the horizon*, without deranging the adjustment of its parts to each other, and without placing the eye-piece in such a position as to be inconvenient to the observer. It is certainly a matter of surprise, that Opticians, especially on the Continent, should have so long neglected the very simple means which are at present commonly employed in this country, of giving an inclined position to Microscopes; since it is now generally acknowledged that the vertical position is, of all that can be adopted, *the very worst*,—excepting, of course, in cases which *necessitate* its use. There are some objects which can only be seen in a vertical microscope, as they require to be viewed in a position nearly or entirely horizontal; such are dissections in water, urinary deposits, saline solutions undergoing crystallization, &c. In ordinary cases an inclination of about 55° to the horizon will usually be found most convenient for unconstrained observation; and the instrument should be so constructed as, when thus inclined, to give to the Stage such an elevation above the table, that when the hands are employed at it, the arms may rest conveniently upon the table. In this manner a degree of support is attained, which gives such free play to the muscles of the hands, that movements of the greatest nicety may be executed by them; and the fatigue of long-continued observation is greatly diminished. Such minutiae may appear too trivial to deserve mention; but no practised Microscopist will be slow to acknowledge their value. For other purposes, again, it is requisite that the Microscope should be placed horizontally, as when the Camera Lucida is used for drawing or measuring. It ought, therefore, to be made capable of every such variety of position; and the Stage must of course be provided with some means of holding the object, when it is itself placed in a position so inclined that the object would slip down unless sustained.

iv. The last principle on which we shall here dwell, is *simplicity in the construction and adjustment of every part*. Many ingenious mechanical devices have been invented and executed, for the purpose of overcoming difficulties which are in themselves really trivial. A moderate amount of dexterity in the use of the hands is sufficient to render most of these superfluous; and without such dexterity, no one, even with the most complete mechanical facilities, will ever become a good microscopist. Among the conveniences of simplicity, the practised Microscopist will not fail to recognize the saving of time effected by being able quickly to set up and put away his instrument. Where a number of parts are to be screwed together before it can be brought into use, interesting objects (as well as time) are not unfrequently lost; and the same cause will often occasion the instrument to be left exposed to the air and dust, to its great detriment, because *time* is required to put it away; so that a slight advantage on the side of simplicity of arrangement

often causes an inferior instrument to be preferred by the working Microscopist to a superior one. Yet there is, of course, a limit to this simplification ; and no arrangement can be objected to on this score, which gives advantages in the examination of difficult objects, or in the determination of doubtful questions, such as no simpler means can afford.—The meaning of this distinction will become apparent, if it be applied to the cases of the Mechanical Stage and the Achromatic Condenser. For although the Mechanical Stage may be considered a valuable aid in observation, as facilitating the finding of a minute object, or the examination of the entire surface of a large one, yet it adds nothing to the clearness of our view of either ; and its place may in great degree be supplied by the fingers of a good manipulator. On the other hand, the use of the Achromatic Condenser not only contributes very materially, but is absolutely indispensable, to the formation of a perfect image, in the case of many objects of a difficult class ; the want of it cannot be compensated by the most dexterous use of the ordinary appliances ; and consequently, although it may fairly be considered superfluous as regards a large proportion of the purposes to which the Microscope is directed, whether for investigation or for display, yet as regards the particular objects just alluded to, it must be considered as no less necessary a part of the instrument than the achromatic Objective itself. Where expense is not an object, the Microscope should doubtless be fitted with *both* these valuable accessories ; where, on the other hand, the cost is so limited that only *one* can be afforded, *that* one should be selected which will make the instrument most useful for the purposes to which it is likely to be applied.

In the account now to be given of the principal forms of Microscope readily procurable in this country, it will be the Author's object, not so much to enumerate and describe the various patterns which the several Makers of the instrument have produced ; as, by selecting from among them those examples which it seems to him most desirable to make known, and by specifying the peculiar advantages which each of these presents, to guide his readers in the choice of the *kind* of Microscope best suited, on the one hand, to the class of investigations they may be desirous of following out, and, on the other, to their pecuniary ability. He is anxious, however, that he should not be supposed to mark any preference for the particular instruments he has selected, over those constructed upon the same general plan by other Makers. To have enumerated them all, would obviously be quite incompatible with the plan of his Treatise ; but he has considered it fair (save in one or two special cases) to give the preference to those Makers who have worked out their own plans of construction, and have thus furnished (to say the least) the general designs which have been adopted with more or less of modification by others.

SIMPLE MICROSCOPES.

33. Under this head, the common *Hand-Magnifier* or pocket-lens first claims our attention; being in reality a Simple Microscope, although not commonly accounted as such. Although this little instrument is in every one's hands, and is indispensable to the Naturalist,—furnishing him with the means of at once making such *preliminary* examinations as often afford him most important guidance,—yet there are comparatively few who know how to handle it to the best advantage. The chief difficulty lies in the steady fixation of it at the requisite distance from the object; especially when the lens employed is of such short focus, that the slightest want of exactness in this adjustment produces evident indistinctness of the image. By carefully resting the hand which carries the glass, however, against that which carries the object, so that both, whenever they move, shall move together, the observer, after a little practice, will be able to employ even high powers with comparative facility. The lenses most generally serviceable for Hand-Magnifiers range in focal length from two inches to half an inch; and a combination of two or three such in the same handle, with an intervening perforated plate of tortoise-shell (which serves as a diaphragm when they are used together), will be found very useful. When such a magnifying power is desired as would require a lens of a quarter of an inch focus, it is best obtained by the substitution of a 'Coddington' (§ 19) for the ordinary double-convex lens. The handle of the magnifier may be pierced with a hole at the end most distant from the joint by which the lenses are attached to it; and through this may be passed a wire, which, being fitted vertically into a stand or foot, serves for the support of the magnifying lenses in a horizontal position, at any height at which it may be convenient to fix them. Such a little apparatus is a rudimentary form (so to speak) of what is commonly understood as a Simple Microscope; the term being usually applied to those instruments in which the magnifying powers are supported otherwise than in the hand, or in which, if the whole apparatus be supported by the hand, the lenses have a fixed bearing upon the object (§ 35).

34. *Ross's Simple Microscope*.—This instrument holds an intermediate place between the Hand-Magnifier and the complete Microscope; being, in fact, nothing else than a lens supported in such a manner as to be capable of being readily fixed in a variety of positions suitable for dissecting and for other manipulations. It consists of a circular brass foot, wherein is screwed a short tubular pillar (Fig. 26), which is 'sprung' at its upper end, so as to grasp a second tube, also 'sprung,' by the drawing-out of which the pillar may be elongated to about 3 inches. This carries at its upper end a jointed socket, through which a square bar about $3\frac{1}{2}$ inches long slides rather stiffly; and one end of this bar carries another

joint, to which is attached a ring for holding the lenses. By lengthening or shortening the pillar, by varying the angle which

FIG. 26.

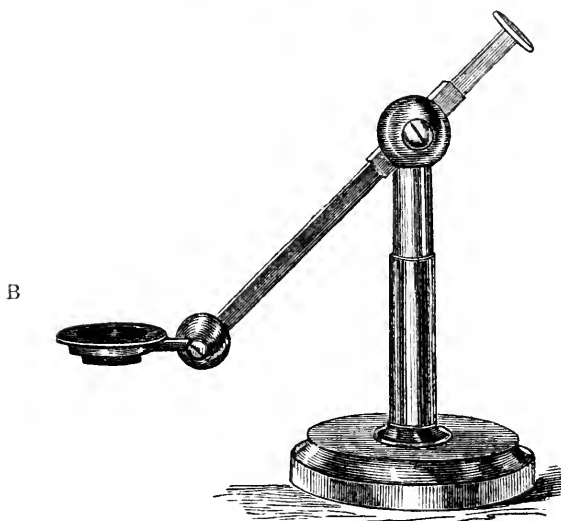
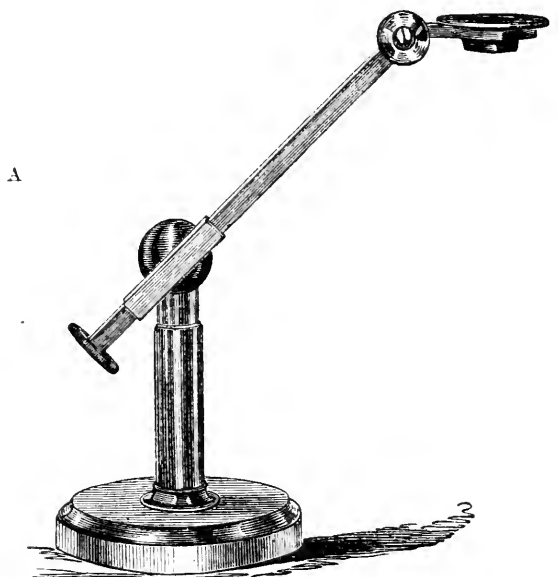

Ross's Simple Microscope.

the square bar makes with its summit, and by sliding that bar through the socket, almost any position and elevation may be given to the lens, that can be required for the purposes to which it may be most usefully applied; care being taken in all instances that the ring which carries the lens should (by means of its joint) be placed horizontally. At A is seen the position which adapts it best for picking out minute shells, or for other similar manipulations; the sand or dredgings to be examined being spread upon a piece of black paper, and raised upon a book, a box, or some other support, to such a height that when the lens is adjusted thereto, the eye may be applied to it continuously without unnecessary fatigue. It will be found advantageous that the foot of the microscope should not stand upon the paper over which the objects are spread, as it is desirable to shake this from time to time in order to bring a fresh portion of the matters to be examined into view; and generally speaking, it will be found convenient to place it on the opposite side of the object, rather than on the same side with the observer. At B is shown the position in which it may be most conveniently set for the dissection of objects contained in a plate or trough, the sides of which, being higher than the lens, would prevent the use of any magnifier mounted on a horizontal arm.—The powers usually supplied with this instrument are one Lens of an inch focus, and a second of either half or a quarter of an inch. By unscrewing the pillar, the whole is made to pack into a small flat case, the extreme portability of which is a great recommendation. Although the uses of this little instrument are greatly limited by its want of stage, mirror, &c., yet, for the class of purposes to which it is suited, it has advantages over perhaps every other form that has been devised.

35. *Gairdner's Doublet Microscope*.—This little instrument, distinguished like the preceding for its simplicity and portability, is adapted to quite a different class of purposes; namely, the examination of *minute* transparent objects, especially those contained in fluid, such as Animalcules, Desmidiaceæ and Diatomaceæ, Urinary deposits, &c. It consists (Fig. 27) of a Wollaston's Doublet (§ 18) supported upon a handle, with which is also connected an elastic slip of brass, carrying a ring that surrounds the projecting centre of the under side of the doublet; this ring is made to approach nearer to, or to recede farther from, the doublet, by means of a milled-headed screw which passes through the stem that supports the latter, and bears upon the slip of brass that carries the former: and to the side of it which is farthest from the doublet, a disk of very thin glass is cemented. In using this little instrument, a minute drop of the liquid to be examined is placed on the *under* side of the thin-glass disk,—that is, on the side *away* from the doublet,—and it is covered by another disk, which will be drawn to the fixed disk and supported in its place by the capillary attraction of the fluid for both. The instrument is then to be so held, that the eye, when applied to the Doublet, looks at the light

through the film of liquid ; and when the focal adjustment is made by means of the milled-head, any particles it may contain of

FIG. 27

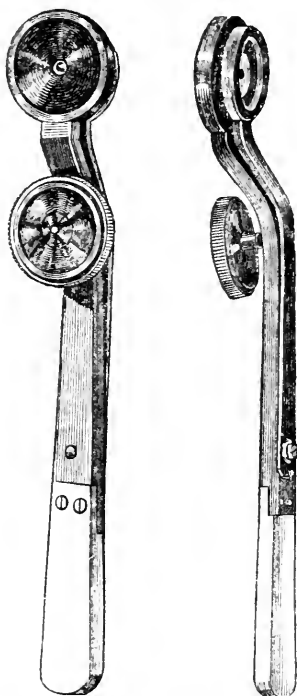

Gairdner's Doublet Microscope.

a size to be brought into view by the magnifying power employed, will be distinctly discerned. The instrument is usually constructed with but a single power, adapted to the class of objects for which it is to be employed ; thus for the purposes of the Botanical or Zoological collector, a power of from 70 to 100 diameters is sufficient ; whilst for the examination of Urinary deposits, a power of 200 or more is desirable. It would not be difficult so to modify it, however, by making the Doublet to screw into a socket, instead of fixing it on the stem, that one power might be substituted for another on the same instrument ; and the adjusting screw might then perhaps be dispensed with, since the focal adjustment might probably be made sufficiently well, by turning round the doublet itself in its screwed socket. The object-holder, too, might be so constructed as to receive a greater variety of objects, and even to hold preparations mounted on slips of glass, which would often be a matter of great convenience for Class-demonstration. All this, however, would add to the complexity and the cost of the instrument ; the simplicity and low price of which at present constitute its chief recommendation. Though not suited for the higher purposes of a Microscope (the view of any object afforded by a Doublet magnifying 100 or 200 diameters being far inferior to that presented by only a tolerable Achromatic), yet there is a certain class of observations for which it is particularly convenient—those, namely, which only require a *recognition* of known forms. Thus, the Collector of Diatoms, Animalcules, &c., may by its means at once test the general value of the sample he has taken up, and may decide whether to throw it away as worthless, or to reserve it for more minute examination. And the Medical Practitioner who is familiar

with the aspect of Urinary deposits, may, by this little instrument (which he can carry in his waistcoat-pocket), discriminate on the spot the nature of almost any sediment whose character he may wish to know, without being obliged to have recourse to a more elaborate apparatus.*

36. *Field's Simple Microscope*.—The *general purposes* of a Simple Microscope are satisfactorily answered by the instrument which gained the premium some years ago awarded by the Council of the Society of Arts, and which is capable of being very effectively used in the examination of most of the objects for which such an instrument is suited. It consists (Fig. 28) of a tubular Stem, about five inches high, the lower end of which screws firmly into the lid of the box wherein the instrument is packed when not in use. To the upper end of this stem the Stage is firmly fixed; while the lower end carries a concave Mirror. Within the tubular stem is a round pillar, having a rack cut into it, against which a pinion works that is turned by a milled-head; and the upper part of this pillar carries a horizontal arm which bears the lenses, so that by turning the milled-head, the arm may be raised or lowered, and the requisite focal adjustment obtained. Three magnifiers are supplied with this instrument; and by using them either separately or in combination (the lens of shortest focus being placed at the bottom, whenever two, or all three, are used together), a considerable range of powers, from about five to forty diameters, is obtained. The Stage is perforated with holes at its four corners, into either of which may be fitted a Condensing lens for opaque objects (§ 90), or a pair of Stage-Forceps (§ 94). An Aquatic Box for the examination of objects in water (§ 97) is also supplied.† This instrument is peculiarly adapted for *Educational* purposes; being fitted in every particular for the examination of Botanical specimens, small Insects or parts of insects, Water-fleas, the larger Animalcules, and other such objects as young people may readily collect and examine for themselves: and those who have trained themselves in the application of it to the study of Nature, are well prepared for the advantageous use of the Compound Microscope. But it also affords to the Scientific inquirer all that is essential to the pursuit of such investigations as are best followed out by the concurrent employ-

* This Microscope, the invention of Prof. Wm. Gairdner of Glasgow, is made by Mr. Bryson, Optician, of Edinburgh.—A modification of it, to be specially used as a "Diatom-Finder," has been described by Mr. Tomkins in the "Trans. of the Micr. Soc." N.S. (1859), Vol. vii. p. 57. The general arrangement of Dr. Gairdner's Microscope is adopted; but the Doublet is replaced by a 'Coddington' lens of 5-8ths-inch focus, which (according to Mr. Tomkins) suffices for the detection of all the ordinary forms of *Diatomaceæ*, and an Aquatic Box is substituted for the brass ring and the disks it carries.

† The price of the instrument, with all these appurtenances, packed in a neat mahogany box, is only *half-a-guinea*; and the maker, Mr. G. Field, of Birmingham, is bound by his agreement with the Society of Arts to keep it always in stock.

ment of a Simple and a Compound Microscope, the former being most fitted for the *preparation*, and the latter for the *examination*, of many kinds of objects ;—and it may be easily adapted to the purposes of dissection, by placing it between arm-rests (§ 134), or

FIG. 28.

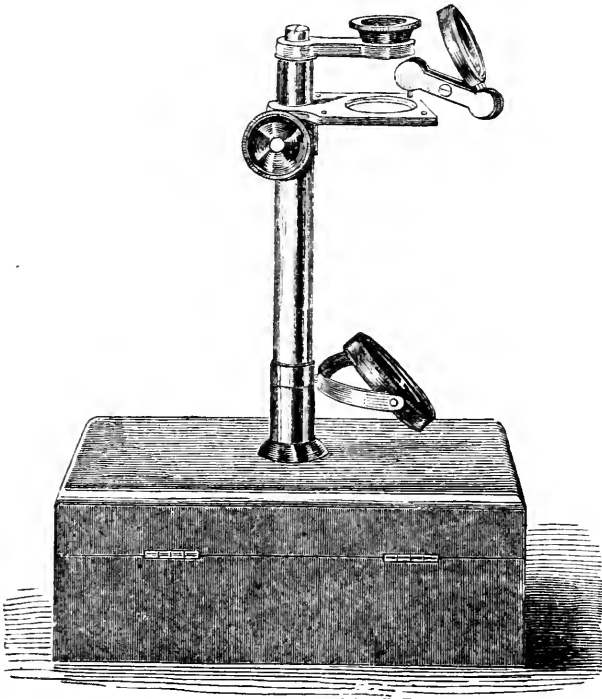

Field's "Society of Arts" Simple Microscope.

blocks of wood, or books piled one on another, so as to give a support for the hand on either side, at or near the level of the stage.

37. *Quekett's Dissecting Microscope*.—To the Scientific investigator, however, it is generally more convenient to have a larger *Stage* than the preceding instrument affords ; and in this respect an arrangement devised by the late Mr. Quekett (Fig. 29) will be found extremely convenient. The *Stage*, which constitutes the principal part of the apparatus, is a plate of brass (bronzed*) nearly six inches square, screwed to a piece of mahogany of the same size, and about 5-8ths of an inch thick ; underneath this a folding flap

* The *Stage-plate* is sometimes made of a piece of plate-glass ; and this is decidedly advantageous where Sea-water or Acids are used.

four inches broad is attached on each side by hinges ; and the two flaps are so shaped that, when folded together, one lies closely upon the other, as shown at B, Fig. 29, whilst, when opened, as shown at A, they give a firm support to the stage at a convenient height. At the back of the Stage-plate is a round hole, through which a tubular

FIG. 29.

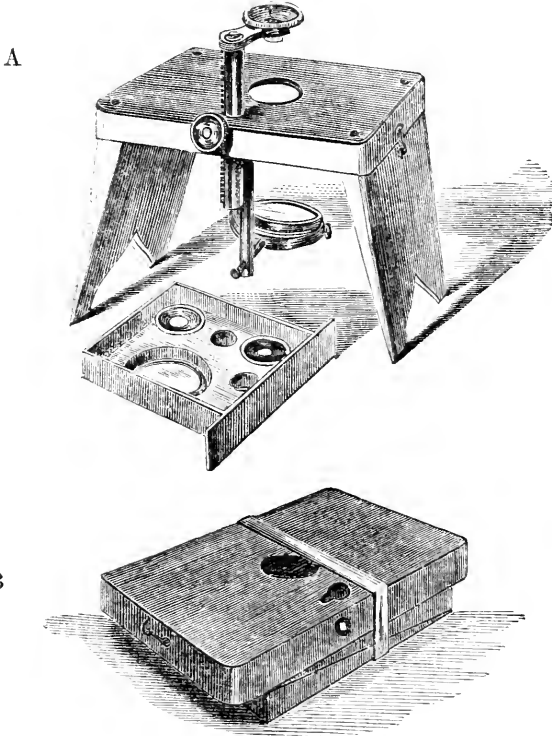

Quekett's Dissecting Microscope, set up for use at A, and packed together at B.

Stem works vertically with a rack-and-pinion movement, carrying at its summit the horizontal Arm for the magnifying powers ; and into the under-side of the stage-plate there screws a stem which carries the Mirror-frame. From this frame the Mirror may be removed, and its place supplied by a convex lens, which serves as a Condenser for opaque objects, its stem being then fitted into a hole in the stage, at one side or in front of its central perforation. The instrument is usually furnished with three Magnifiers, namely, an *inch* and a *half-inch* ordinary lenses, and a *quarter-inch* Coddington

(§ 19) ; and these will be found to be the powers most useful for the purposes to which it is specially adapted. As a black background is often required in dissecting objects which are not transparent, this may be most readily provided by attaching a disk of *dead-black* paper to the back of the Mirror. The lenses, mirror, condenser, vertical stems, and milled-head, all fit into a drawer that shuts into the under-side of the Stage, and is then covered and kept in place by the side-flaps ; so that, when packed together, and the flaps kept down by an elastic band, as shown at B, Fig. 29, the instrument is extremely portable, furnishing (so to speak) a case for itself. It may be easily made to serve as a Compound Microscope, by means of an additional stem and horizontal arm, carrying a light Body.—The principal *disadvantages* of this very ingenious and otherwise most convenient arrangement, are that it must be always used with the light *in front* of the observer, or nearly so, since the side-flaps interfere with the access of side-light to the mirror ; and that the obstruction of the side-flaps also prevents the hands from having that ready access to the mirror, which is convenient in making its adjustments.* These inconveniences, however, are trifling, when compared with the great facilities afforded for scientific investigation by the size and firmness of the Stage, combined with its extreme portability ; and the Author can confidently recommend the instrument for all such purposes, from much personal experience of its utility.

38. *Beck's and Nacet's Binocular Dissecting Microscopes.*—A more substantial and elaborate form of Dissecting Microscope, devised by the late Mr. R. Beck, is represented in Fig. 30. From the angles of a square mahogany base, there rise four strong brass pillars, which support, at a height of 4 inches, a brass plate $6\frac{1}{2}$ inches square, having a central aperture of 1 inch across ; upon this rests a circular brass plate, of which the diameter is equal to the side of the preceding, and which is attached to it by a revolving fitting that surrounds the central aperture, and can be tightened by a large milled-head beneath ; whilst above this is a third plate, which slides easily over the second, being held down upon it by springs which allow a movement of $1\frac{1}{2}$ inch in any direction. The top-plate has an aperture of $1\frac{1}{2}$ inch for the reception of various glasses and troughs suitable for containing objects for dissection ; and into it can also be fitted a spring holder, suitable to receive and secure a glass slide of the ordinary size. By turning the large circular plate, the object under observation may be easily made to rotate, without disturbing its relation to the optical portions of the instrument ; whilst a traversing movement may be given to it in any direction, by acting upon

* Another form of this instrument, supported by brass folding legs instead of by wooden flaps, so as to allow the light to fall on the mirror from either side as well as from the front, is made by Messrs. Parkes of Birmingham.

the smaller plate. The left-hand back pillar contains a triangular bar with rack-and-pinion movement, for focal adjustment, which carries the horizontal arm for the support of the magnifiers; this

FIG. 30.

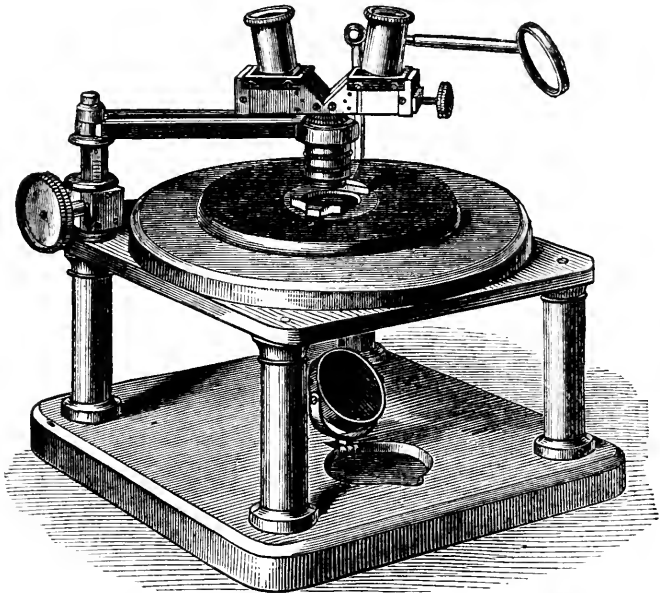

Beck's Dissecting Microscope, with Nacet's Binocular Magnifier.

arm can be turned away towards the left side, but it is provided with a stop which checks it in the opposite direction, when the Magnifier is exactly over the centre of the Stage-aperture. Beneath this aperture is a concave Mirror, which, when not in use, lies in a recess in the mahogany base, so as to leave the space beneath the stage entirely free to receive a box containing apparatus; whilst from the right-hand back corner there can be raised a stem carrying a side Condensing-lens, with a ball-and-socket movement. In addition to the single Lenses and Coddington ordinarily used for the purposes of dissection, a Binocular arrangement was devised by Mr. R. Beck,* on the principle applied by M.M. Nacet, about the same date, in their Stereo-pseudoscopic Microscope (§ 29). For, adopting Mr. Wenham's method of allowing half the cone of rays to proceed to one eye without interruption, he caused the other half to be intercepted by a pair of Prisms disposed as in Fig. 22, 2, and to be by them transmitted to the other eye. It will be readily

* "Transactions of the Microscopical Society," N. S. Vol. xii. p. 3.

understood that this arrangement, though *pseudoscopic* for the Compound Microscope, is *Stereoscopic* for the Simple Microscope, in which there is no reversal of the pictures; and the Author can testify to the fidelity of the effect of relief obtainable by Mr. R. Beck's apparatus, which, being carried on an arm superposed upon that which bears the magnifier, can be turned aside at pleasure. But he has found its utility to be practically limited by the narrowness of its field of view, by its deficiency of light and of magnifying power, and by the inconvenience of the manner in which the eyes have to be applied to it.—An arrangement greatly superior in all these particulars having been recently worked-out by MM. Nacet, the Author has combined the Optical part of their Dissecting Microscope with Mr. R. Beck's Stand, and finds every reason to be satisfied with the result; the solidity of the stand giving great firmness, whilst the size of the Stage-plate affords ample room for the hands to rest upon it. The Objective in Nacet's arrangement is an Achromatic combination of three pairs, having a clear aperture of nearly $\frac{3}{4}$ ths of an inch, and a power about equal to that of a single lens of one-inch focus; and immediately over this is a pair of Prisms, each resembling A, Fig. 22, having their inclined surfaces opposed to each other, so as to divide the pencil of rays passing upwards from the Objective into two halves. These are reflected horizontally, the one to the right and the other to the left; each to be received by a lateral Prism corresponding to B, and to be reflected upwards to its own Eye, at such a slight divergence from the perpendicular as to give a natural convergence to the axes when the eyes are applied to the Eye-tubes superposed on the lateral prisms,—the distance between these and the central prisms being made capable of variation, as in the Compound Binocular of the same makers (§ 29). The magnifying power of this instrument may be augmented to 35 or 40 diameters, by inserting a *concave* lens into each Eye-piece, which converts the combination into the likeness of a Galilean Telescope (or Opera-glass); and this arrangement (originally suggested by Prof. Brücke of Vienna) has the additional advantage of increasing the distance between the object and the object-glass, so as to give more room for the use of dissecting instruments.—To all who are engaged in investigations requiring very minute and delicate dissection, the Author can most strongly recommend MM. Nacet's instrument. No one who has not had experience of it can estimate the immense advantage given by the Stereoscopic view, not merely in appreciating the solid form of the object under dissection, but also in precisely estimating the relation of the instrument to it in the *vertical* direction. This is especially important when horizontal sections are being made with fine Scissors; since the course of the section can thus be so regulated as to pass through the plane desired, with an exactness totally unattainable by the use of any Monocular Magnifier.

COMPOUND MICROSCOPES.

39. The various forms of Compound Microscope may be grouped with tolerable definiteness into *three* principal Classes : the *First* consisting of those instruments in which the greatest possible perfection and completeness are aimed at, without regard to cost ; the *Second* including those which are adapted to all the ordinary requirements of the observer, and which can be fitted with the most important of those Accessories,* whose use enables him not only to work with more facility and certainty, but, in some instances, to gain information with regard to the objects of his examination which he could not obtain without them ; whilst to the *Third* belong those in which simplicity and cheapness are made the primary considerations. Besides these, there is a class of Microscopes devised for *Special* purposes, but not suited for ordinary use.—In all, save the last, the same basis of support is adopted, namely, a triangular ‘foot,’ from which arise two uprights ; and between these the Microscope itself is swung in such a manner that the weight of its different parts may be as nearly as possible balanced above and below the centres of suspension in all the ordinary positions of the instrument. This double support was first introduced by Mr. George Jackson, who substituted two pillars (a form which Messrs. Smith and Beck still retain in their Large Compound Microscope, Plate VII.) for the single pillar connected with the Microscope itself by a ‘cradle-joint’ (as in Fig. 37) which was previously in use ; but in place of pillars screwed into the tripod base, a pair of flattened uprights, cast in one piece with it, is now generally adopted, with a view both to greater solidity and to facility of construction. Messrs. Powell and Lealand, it will be observed, adopt a tripod support of a different kind (Plates v. VI.) ; still, however, carrying out the same fundamental principle of swinging the Microscope itself between two centres ; and the same general arrangement is adopted in the very ingenious form devised by Mr. Ladd (Fig. 36).—Two different modes of giving support and motion to the ‘Body’ will be found to prevail. One consists in its attachment at its base to a transverse ‘Arm,’ which is borne on the summit of the movable Stem, whose rack is acted on by the pinion of the milled-head, as in Figs. 31, 33, 34, 39 ; whilst in the other, the body is supported along a great part of its length by means of a solid ‘Limb,’ to which is attached the pinion that acts on a rack fixed to the body itself, as in Figs. 32, 35, and 38. The former, which may be described as the *Ross* model, has the advantage of enabling the Body to be turned aside by the rotation of the transverse Arm upon the summit

* It is true that some of the most important of these Accessories *may* be applied to the smaller and lighter kind of Microscopes ; but when it is desired to render the instrument complete by the addition of them, it is far preferable to adopt one of those larger and more substantial models, which have been devised with express reference to their most advantageous and most convenient employment.

of the Stem,—a movement which is often convenient, both as leaving the Stage clear for dissection, &c., and as enabling the Objectives to be more readily exchanged ; but it is subject to the disadvantage that unless the transverse arm and the body are constructed with great solidity, the absence of support along the length of the latter leaves it subject to vibration, which may become unpleasantly apparent when high powers are used, giving a dancing motion to the objects. With a view of preventing this vibration, the top of the 'body' is sometimes connected with the back of the transverse arm by a pair of oblique 'stays' (Plate v.). The second, which may be designated the *Lister* model, is decidedly superior in steadiness, a perfect freedom from tremor being obtained with less solidity, and therefore with less cumbrousness ; the mode in which the rack is applied, moreover, in the microscopes of Messrs. Smith and Beck (most of which are constructed upon this plan) gives to it a peculiar smoothness and easiness of working ; but the traversing movement of the body is sacrificed. Although some attach considerable importance to this movement, the Author's experience of instruments constructed upon both plans leads him on the whole to give a preference to the second.

In describing the instruments which he has selected as typical of the Classes above enumerated, the Author wishes not to be understood as giving any special preference to these, above what may be the equally good instruments of other makers. The number of Opticians who now construct really excellent Microscopes has of late years increased greatly ; but their models are for the most part copied more or less closely from those previously adopted for their First-Class Microscopes by the three principal firms which long had exclusive possession of the field. Where any individual Maker has introduced a real novelty, either in plan of construction, or in simplification leading to reduction of price, the Author has thought this worthy of special notice ; whilst the limits within which he is restricted oblige him to content himself with a bare mention of other Makers whose productions are favourably known to him. It will be found most advantageous to commence with the *Third Class* Microscopes, as the most simple in construction ; and to rise from these, through the *Second*, to the *First Class*,—reserving the *Special Class* for the conclusion.

Third-Class Microscopes.

40. Microscopes in which simplicity and cheapness are the primary considerations, are rather suited for Educational purposes than for Scientific observation. Yet it is unquestionable that very important contributions to our knowledge of nature have been made by the assistance of instruments not surpassing the least perfect of those now to be described. And there is this advantage in commencing Microscope-work with a Third-class instrument, that the risk of injury to a more costly Microscope, which necessarily arises from

want of experience in its use, is avoided ; whilst the inferior instrument will still be found serviceable for many purposes, after a better one has been acquired.

41. *Field's Educational Microscope.*—This instrument (Fig. 31) is known as the 'Society of Arts Microscope,' in consequence of its having gained the medal awarded by that society in 1855 (at the suggestion of the Author) for the best *three-guinea* Compound Microscope. This award must be understood, not as a guarantee

FIG. 31.



Field's "Society of Arts" Compound Microscope.

for the *perfection* of its construction, but as marking the highest degree of excellence among the instruments sent in competition, that seemed consistent with the *cheapness** which was the funda-

* This instrument is furnished with two Eye-pieces and two Achromatic objectives, giving a range of power from about 25 to 200 diameters, Condenser on a separate stand, Stage-forceps, and Live-box, packed in a mahogany case ; and the maker, Mr. R. Field, of Birmingham, is bound by his agreement with the Society of Arts to keep it always in stock, so as to supply any purchaser at once.—The Author learned with great satisfaction, that no fewer than 1800 of these Microscopes had been sold up to the end of the year 1861.

mental requirement. In its general plan it conforms to the Ross model; the Body being carried upon an arm which contains the lever for slow motion, acted on by a screw turned by a milled-head; and the Arm being carried by a bar which is raised by a rack-and-pinion movement from the interior of the stem. This stem, to which the Stage is attached above and the Mirror below, is swung on transverse centres between two uprights that are cast in one piece with the triangular foot. The Stage is furnished on its upper surface with a movable brass ledge, against which the object rests when the stage is inclined in any degree to the horizon; this ledge should slide smoothly and easily from the back to the front of the stage, but should have at the same time sufficient hold upon it to retain its position, and to support the object at whatever point it may be left. At a little distance beneath the stage there is attached to it a Diaphragm-plate, perforated with holes of various sizes for the regulation of the quantity of light admitted to Transparent objects (§ 78), and also affording in one of its positions a dark back-ground, which is useful when Opaque objects are being viewed. The stage is perforated at one of its front corners with a hole into which fits a pair of Stage-Forceps (§ 94). The Mirror, which is concave on one side and plane on the other, is attached, not directly to the stem, but to a tube which slides upon it, so that its distance from the under-side of the stage may be increased or diminished. The Condenser for opaque objects is mounted on a separate stand (§ 90).—The simplicity of the construction of this Microscope, and the facility with which all those adjustments may be made that are required for the purposes it is intended to fulfil, should constitute, with its low price, a great recommendation to those who value a Microscope rather as a means of interesting recreation for themselves, or of cultivating a taste for the Study of Nature and a habit of correct observation in the young, than as an instrument of Scientific research. It is not, of course, to be expected that it should bear comparison, in regard either to the mechanical finish of its workmanship, or to the perfection of its optical effects, with Microscopes of many times its cost; but it is infinitely superior to the best Microscope ever constructed in the old (non-achromatic) plan; and it is greatly to be preferred in its mechanical arrangements to any of the earlier achromatic microscopes, which it at least equals in optical performance.*

42. *Crouch's Educational Microscope.*—The instrument just described cannot be made suitable to any higher purposes than those for which it was originally devised. That now to be mentioned, on

* Microscopes suited to Educational purposes, and corresponding more or less closely in price and general arrangement with the above, are made by Messrs. Baker, Collins, Highley, Steward, Wheeler, and other Opticians in London, and by Messrs. Parkes, in Birmingham. In most of these the workmanship is superior, but the variety of Powers and the number of Accessories are less.

the other hand, may be recommended to those who think it well to provide themselves in the first instance with a Microscope that is capable of being improved by progressive additions. It is constructed (Fig 32) on the Lister model, and is not only very light

FIG. 32.

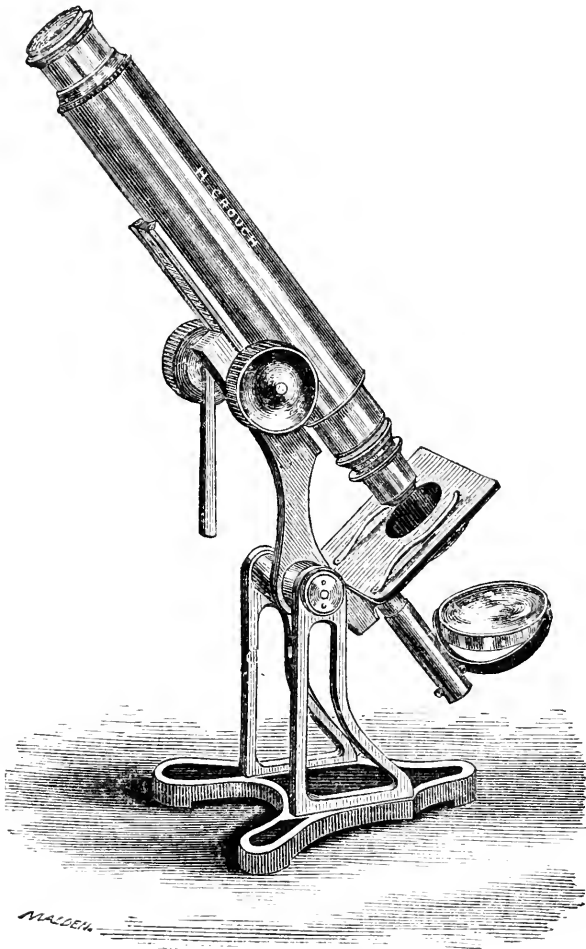

Crouch's Educational Microscope.

and portable, but very free from tremor. The rack-movement is so good that an Objective of 1-4th inch may be focussed by it with great exactness ; additional facility in this adjustment being given (as in Mr. Ladd's Microscope, Fig. 36) by the use of a Lever-

handle, which ordinarily hangs quite freely from the axis of the milled-head, so as not to turn with it, but which can be made to 'grip' it by a slight lateral pressure. A 'slow-motion' is therefore dispensed with. The Stage is furnished with a pair of springs for holding down the object; a simple method which is very suitable for ordinary purposes, but which requires special care in its use when a slide carrying a drop of fluid beneath a covering-glass is being moved about under the objective, since, if the slide be carried too far towards either side, the covering-glass is displaced by impinging against the spring. This instrument is provided with two Objectives, each consisting of a good triplet combination, of *two* inches and *one* inch focus respectively; and when to these is added a 1-4th Objective of moderate angular aperture, it is rendered a very serviceable *Student's* Microscope. The aperture of the Stage being carefully centered to the axis of the Body, a tube can be screwed into it which will carry a Diaphragm-plate, a Polariscope, or a Paraboloid; and thus by additions which may be made at any time, either simultaneously or successively, this instrument, of which the first cost is no greater than that of the preceding, may be rendered quite complete enough for the ordinary wants of the Scientific investigator.*

43. *Pillischer's Small Student's Microscope*.—The instrument represented in Fig. 33 deserves special mention, as having been the first really good Microscope brought out in this country at the price of £5; and as having gained for its constructor the award of a Medal at the International Exhibition of 1862 'for cheapness combined with excellence.' This Microscope is framed upon the Ross model, and is provided with a fine adjustment as well as with the rack-and-pinion movement. The Body is furnished with a sliding tube, by pushing-in which it may be shortened for packing; thus enabling the instrument to be put away in a very small compass. The Stage carries a simple but very convenient Object-holder, consisting of a back-and-front piece pivoted to the upper left-hand corner of the stage, and of a transverse bar, of which the left-hand extremity is pivoted to the lower end of the preceding, whilst its right-hand extremity, which projects beyond the stage, is kept down upon it by a spring applied to its under surface. From this transverse bar there project forward two tongues, on which the slide bearing the object is laid; and these tongues are furnished with springs for keeping the slide in place. By applying the right hand to a pin which projects upwards from the free end of the transverse bar, motion may be readily given to the object in any direction; whilst

* This Microscope being fitted with the 'universal screw,' now generally adopted by English Opticians, may be employed by any Microscopist with the Objectives and Accessories he may already possess, and will be found very convenient for Sea-side use. On the other hand, those who commence with the Objectives specially provided for this instrument, may at any time substitute for them Objectives of a higher class.

if it should be desired to clear the stage for the reception of large objects, the traversing apparatus may be at once detached by unscrewing the pivot, which is furnished with a milled-head. This instrument is furnished with a dividing set of achromatic Objectives,

FIG. 33.

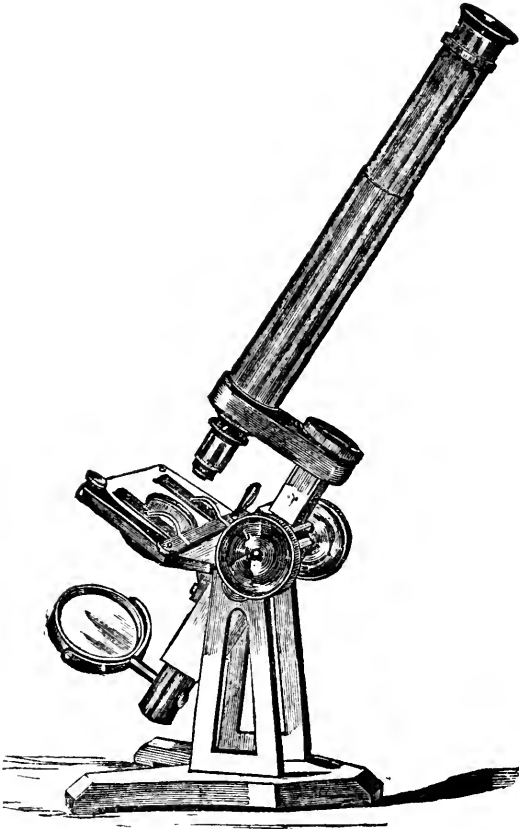

Pillischer's Small Student's Microscope.

giving a power of 1-4th inch when complete, of $\frac{1}{2}$ inch when the front lens is removed, and of 1 inch when the middle lens has also been taken off ; and these, as in the preceding instance, may be replaced by superior objectives if desired. An additional Eye-piece, 2-inch Objective, Polarizing apparatus, and other Accessories, are furnished at a very moderate price.

44. *Murray and Heath's Student's Microscope.*—Another instrument of the same general construction as the preceding (Fig. 34)

deserves notice on account of the simple and effective construction of the Object-holder with which its Stage is furnished. This consists of a brass plate perforated with a large aperture, having rounded ends that project considerably beyond the stage, to which

FIG. 34.

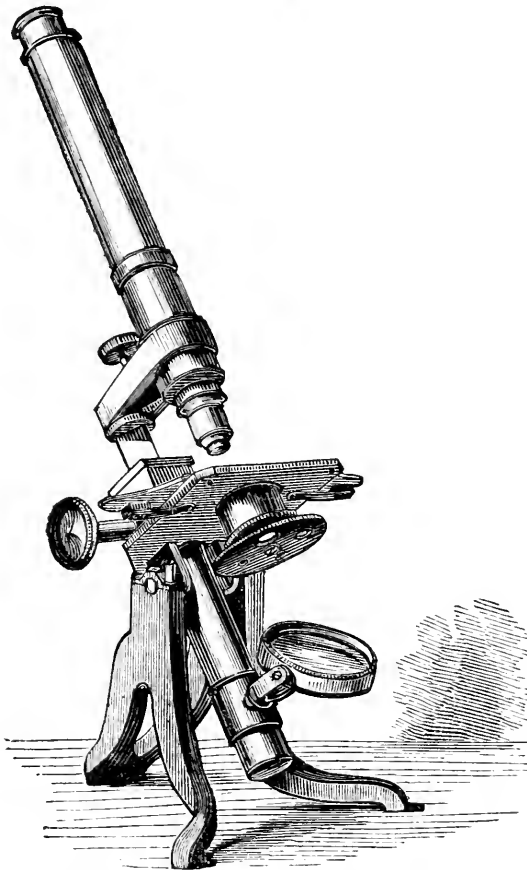

Murray and Heath's Student's Microscope.

it is held down by a pair of springs that bear against its underside ; and it is best moved by applying a hand to *each* of its projecting extremities, whereby living objects may be followed with great facility.* It may be safely said that no cheap construction

* This Object-holder, the original idea of which was suggested by that of Mr. Pillischer, has been copied by Mr. How, who has been erroneously credited with the invention of it.

has been or is likely to be devised, superior to this for the general requirements either of the ordinary observer or of the scientific student.*

SECOND-CLASS MICROSCOPES.

Under this head may be ranked those instruments which combine first-rate workmanship with simplicity in the plan of construction ; and which may be consequently designated as 'Superior Student's Microscopes.'

45. *Smith and Beck's Student's Microscope.*—Of the numerous patterns devised for a Monocular instrument of simple construction, which shall yet be capable of answering every essential purpose whether of display or of investigation, none appears to the Author to be superior to that long since introduced by Messrs. Smith and Beck (Fig. 35), which was employed by him for many years as his own *working* instrument, and which he has only of late put aside for the Binocular, in consequence of the advantage afforded by the latter in the inquiries to which he has been specially devoting himself. This Microscope is constructed upon the Lister model, which has the advantage of giving a firm support to the body along a great part of its length, and great smoothness with an entire freedom from twist to the rack motion ; whilst it also secures that exact *centering* which is essential to the optical perfection of the instrument. The upper end of the Body is furnished with a 'Draw-tube,' by which its length can be increased ; and one side of this is

* In addition to the makers above specified, the following are known to the Author as furnishing Student's Microscopes of this class, at prices ranging from five to seven guineas, which can be recommended as combining really good workmanship in their mechanical portion, with an optical performance adequate to all ordinary requirements :—Messrs. Baker, Collins, Highley, How, and Wheeler. The 1-4th inch Objective of 70° made by the last-named Optician, on the plan described in § 13 *note*, for his five-guinea Student's Microscope, may be specially mentioned as bringing out the markings of the Podura-scale with a force and clearness that show this objective to be eminently adapted for Physiological purposes, although it can scarcely resolve the easiest of the Diatom-tests (see § 137).—For a long time after the Microscope had been brought to high perfection in this country, those who desired cheap and simple instruments could only obtain them from Continental opticians ; and the Microscopes of Chevalier, Nacet, and Oberhauser were formerly introduced very largely into this country from Paris, a few also finding their way hither from Germany, amongst which those of Kellner (of Wetzlar) were specially distinguished for their excellence. The low-priced models of these makers, however, were all of them originally *vertical* ; and it has only been within a comparatively recent period that the power of inclination has been given to them, chiefly for the British market. The great increase in the demand for Student's Microscopes, which has been created in this country by improvements in Medical Education, has called forth (as has been shown) a corresponding supply ; and it may safely be said that the best instruments of the Third Class now constructed in London can compare so favourably both in price and convenience with those of Continental make, that little or nothing can be gained by having recourse to the latter.

graduated to inches and tenths : the advantages of this arrangement will be explained hereafter (§ 63). The 'fine' adjustment is effected by means of a milled-head, situated just behind the base of the stem that bears the 'limb;' this acts on a screw, the turning of which (by a contrivance that need not be described in detail) depresses the stem with the limb and body attached to it, so as to bring the objective nearer to the object; whilst if the pressure of the screw be withdrawn by turning the milled-head in the opposite direction, the tubular stem (with the limb and body) is carried upwards by a spiral spring in its interior, thus increasing the distance of the objective from the object. This adjustment is remarkable for its sensitiveness, and for its freedom from any displacing action upon the image. The only other peculiarity that need be noticed in this instrument, is the mode in which the object is borne upon the Stage; for instead of resting against a ledge, it lies upon a kind of fork, which slides in grooves ploughed out of the stage, and which moves with such facility, that the pressure of a single finger upon one of the upright pins at the back

FIG. 35.

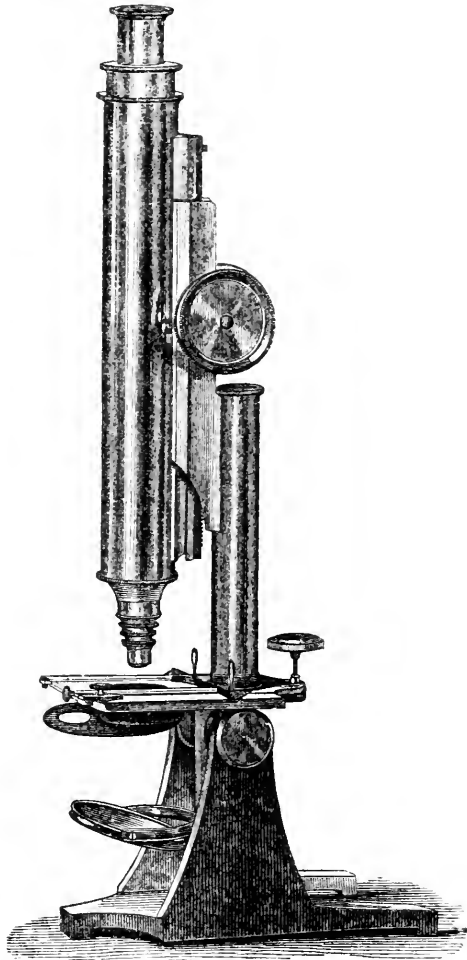

Smith and Beck's Student's Microscope.

of the fork is sufficient to push it in either direction. At the extremity of one of the prongs of this fork is a 'spring-clip' for securing the object by a gentle pressure, which is particularly useful when the Microscope is placed in a horizontal position for drawing with the Camera Lucida (§ 71), the stage being then vertical. And at the extremity of the other prong is a hole for the insertion of the pin of the Stage-Forceps, which thus gains the advantage of the sliding movement of the fork, in addition to its own actions.—This instrument can easily receive the addition of an Achromatic Condenser, Paraboloid, and Polarizing apparatus; it may also be fitted with a Mechanical Stage, but the range of its movement is limited.

46. *Ladd's Student's Microscope.*—The ingeniously-constructed Microscope of Mr. Ladd (Fig. 36) deserves special mention, on account of the peculiarities which distinguish it from all other forms previously devised. In the first place, it is remarkable for its lightness; the tripod Foot being constructed of a framework of *tubes* securely braced together, and the other parts of the instrument being made with less than their usual massiveness, yet without such weakness as would permit vibration. The Body is attached for a considerable part of its length to a frame which slides up and down on a dovetailed bar; and motion is given to this, not by a rack-and-pinion, but by a *chain* working round a spindle turned by the milled-head. This arrangement gives a movement of remarkable smoothness; and it has this great advantage over the ordinary plan, that its action cannot become loose by wear, as that of the best rack is liable to do in the lapse of years at the part in which it has been most used; the whole chain being tightened, if necessary, by a small screw at the top, so that there need never be the least amount of 'lost time.' Around the neck of the right-hand milled-head there is a collar to which is attached a short Lever: this collar is ordinarily so loose that the lever hangs vertically as in the figure, and is not altered in position by the rotation of the milled-head; but by turning the nut at the lower end of the lever, the collar is made to press tightly round the neck of the milled-head, and the lever may then be used to give a 'slow motion' to the body, by which its focal adjustment may be effected with a nicety quite sufficient for all but the very highest powers. In fact, for the ordinary purposes of Scientific investigation not requiring the use of those powers, the Author is disposed (from much experience of this instrument) to prefer the slow motion given by a lever to that given by a screw; as it enables the observer, when looking at an object whose different parts are at different distances, to pass more readily from one focus to another, and so more intimately to connect the different views together in his mind. In using this lever, it is advantageous to give the hand a bearing upon the tripod stand. The Stage is furnished with the Magnetic bearing first brought into practical use by Mr. G. Busk. This consists of a horse-shoe magnet screwed to the under-side of

the stage, from which there project upwards through slits in the stage a pair of steel bars, whose edges are just enough above the surface of the stage to prevent its being touched by the loose steel bar that lies across them as a 'keeper.' This bar may be slid in

FIG. 36.

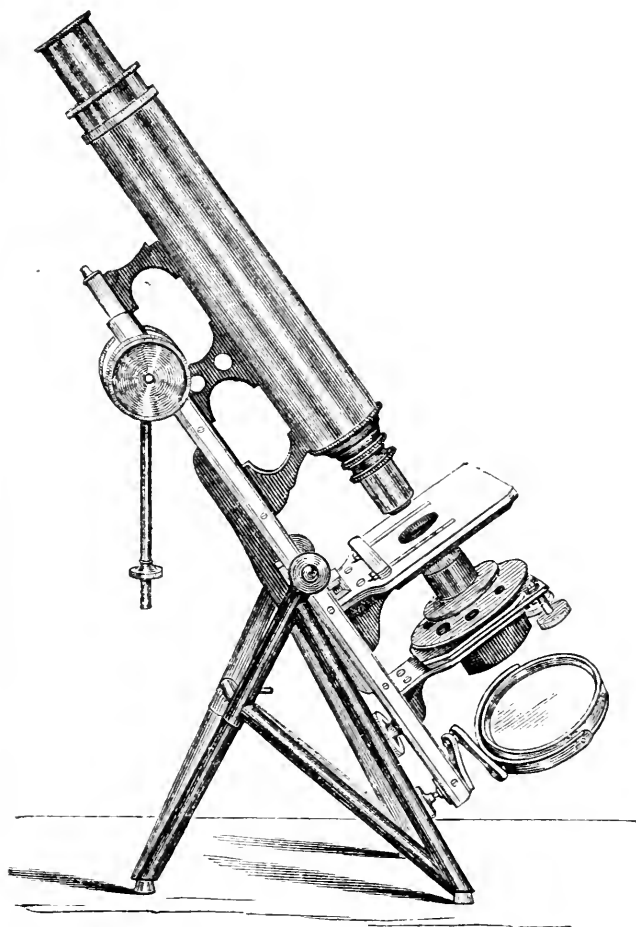

Ladd's Student's Microscope.

any direction with the greatest facility ; but it is held to the magnet bars with sufficient tenacity to remain in any position in which it may be placed, and to support in that position any moderate weight, so as to afford adequate support to the object-slide or

Animalcule-cage, when brought up to its lower edge. No action surpasses that of this *Magnetic Stage* in the facility with which it may be worked ; but the arrangement is liable to the serious objection that when it is used with Sea-water or with Acid solutions, the almost inevitable spilling of these occasions the formation of rust on the steel surfaces, which no gilding will prevent ; whilst if the power of the magnet should become weakened, it cannot be readily augmented.—Beneath the stage is a detached Sub-stage for carrying a Diaphragm-plate, Achromatic Condenser, Polarizing-prism, or other apparatus ; this sub-stage is capable of being moved nearer-to or farther-from the stage, by means of a milled-head working in a rack in the supporting bar ; and its fittings can be precisely ‘centered’ to the axis of the body by means of adjusting screws. The Mirror is furnished with a double arm, by the extension of which very oblique light may be obtained.—Altogether this instrument may be recommended as combining many of the advantages of the more complicated and more expensive instruments with those of the simpler and less costly.

47. *Nachet's Student's Microscope*.—Although for the reasons already mentioned (p. 64 *note*) the Author has abstained from noticing any Continental Microscope of the Third Class, yet he feels it due to MM. Nachet to make special mention of the new model of Student's Microscope which they have recently introduced, as possessing excellencies which distinguish it from all constructions previously devised. The general build of this instrument corresponds with that of the Student's Microscope of Messrs. Smith and Beck (Fig. 35), except that it is upon a smaller scale, and is supported on a single pillar with a cradle-joint, instead of being swung between two uprights. The Body is furnished with a draw-tube, by which it is shortened for packing ; and instead of being itself attached to the rack, its lower part is embraced by a tube which carries the rack, so that this Single body may be readily drawn out and replaced by the Binocular already described (§ 29, Fig. 23). The ‘slow motion’ is given by an arrangement corresponding to that already described in Smith and Beck's Microscope, which seems to have been adapted from Continental models ; the milled-head which acts upon it, however, is placed at the top of the sliding-stem, so as to be near that which gives the rack-and-pinion adjustment. The chief peculiarity of this instrument, however, lies in its Stage, which the Author has no hesitation in pronouncing to be the *most perfect of its kind* that has been yet devised. Its base is formed of a thick plate, $3\frac{1}{2}$ inches square, having a large circular aperture ; and on this is superposed a circular plate of 3 inches in diameter, to which a rotatory movement, concentric with the optic axis of the Microscope, can be given with great facility. In this circular plate a disk of thin plate-glass is cemented with black cement, the united thickness of the two around the central aperture being not more than 1-8th of an inch, so that light of the

greatest obliquity can be transmitted to the object from beneath. The rotating plate is furnished with a projection at the back, to which is attached a strong V-shaped pair of springs, having their extremities armed beneath with small ivory knobs, which press down on the Object-carrier. This last consists of a brass frame furnished with tongues and springs projecting forward for the reception of the slide, and also with a pair of knobs, to which the fingers may be applied in giving motion to it; whilst the frame encloses a piece of plate-glass a little thicker than itself. Thus the under surface of the glass plate of the Object-carrier slides over the upper surface of the circular glass Stage-plate; being held down upon it and retained in any position by the pressure of the ivory knobs. In the perfect facility with which the object-carrier may be moved, and the steadiness with which it keeps its place when not unduly weighted, this arrangement is at least equal to the Magnetic stage, whilst superior to it in the essential particular of not being liable to derangement from rust; having also the further advantage of being capable of ready readjustment in case the movement should become too easy, nothing more being necessary to tighten it in any required degree than bending down the V springs. The front portion of the rotating plate bears a small projecting piece on either side, into which may be screwed a pin that carries a sliding-spring; this arrangement is suited for securing a Zoophyte-trough or other piece of appa-

FIG. 37.

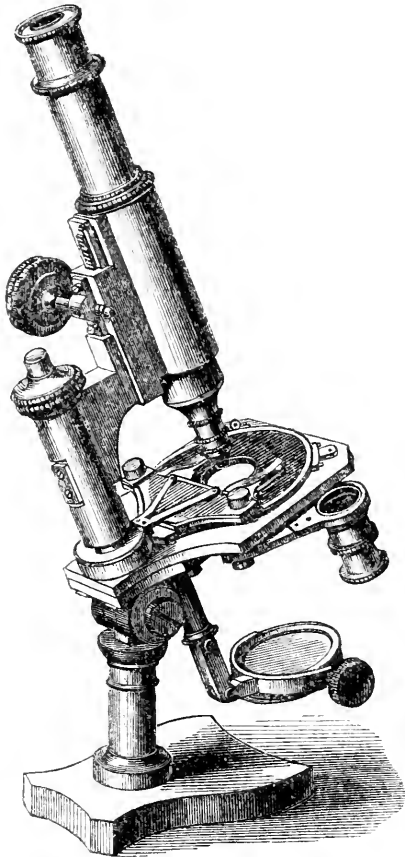

Nacet's Student's Microscope.

ratus not suitable to being received by the object-carrier, which can be easily slipped away from beneath the ivory knobs, thus leaving the stage free. To the under side of the stage is firmly pivoted a broad bar, into which is screwed a short sprung tube, that is exactly concentric with the optic axis of the instrument when the bar (which is shown turned-away in the figure) is pushed beneath the stage until checked by a firm stop ; and as this bar is composed of two pieces, held together by a pair of screws working through slots, the centering of the tube may be precisely readjusted if it should at any time become faulty. Into this tube may be inserted another that carries either (1) a Diaphragm, which can be slid up and down, so as to vary the proportion of the pencil of convergent rays thrown upwards by the mirror ; (2) a Polarizing prism ; (3) a Ground-glass for diffusing the light, which may be either plane or a plano-convex lens, ground on its flat side which is directed upwards ; and (4) a Glass Cone, having its apex pointing downwards, and a large black spot in the centre of its base which is directed towards the object ; this serves the same purpose as the Paraboloid now commonly applied to English Microscopes (§ 85). Lastly, the Mirror is attached to a stem which is so jointed as to enable it to reflect rays of very great obliquity.—To those who wish a compact instrument of great completeness and capability, which may be worked advantageously even with high powers (for which an Achromatic condenser might easily be added if desired), the Author can strongly recommend this Microscope, especially when furnished with MM. Nachet's Stereo-pseudoscopic arrangement (§ 29). The rotatory movement of the Stage has all the advantages which are only obtained at a great increase of cost in First-class instruments ; and it is so exact as to answer equally well for all the purposes which this rotation is specially fitted to serve (§§ 48, 52). The traversing movement of the Object-holder is in some respects (especially for following living objects) decidedly superior to that of any Mechanical Stage ; and those who have become accustomed to its use will seldom feel the need of the latter more costly appliance. The Sub-stage fitting is so arranged as to carry the most needful Accessories, without either interfering with extremely oblique illumination (as is done by the tube which is screwed into the aperture of the stage of most English Students' Microscopes), or requiring any complicated and therefore costly provisions for the exact centering of its fittings with the optic axis of the instrument. And the manner in which the Mirror is mounted gives it a remarkable range of position.—The Objectives ordinarily supplied with this instrument by MM. Nachet are of excellent quality, and are quite adequate for the ordinary purposes of scientific investigation ; but for the sake of purchasers who may prefer Objectives of English or American make, MM. Nachet now provide it with the universal screw.*

* The price of this instrument, with the Accessories above enumerated,

Second-class Binocular Microscopes.

48. For some time after the Stereoscopic Binocular Microscope was first successfully brought into action, it was commonly regarded as a sort of *article de luxe*, better fitted for the purposes of *display* than for those of *research*. Its value in Scientific investigation, however, is now admitted by all who have really worked with it upon suitable objects; and so strongly is the Author impressed with its advantages, that he would earnestly recommend every one about to provide himself with even a Second class Microscope, to incur the small expense of the Binocular addition. This addition, however, will lose an important element of its value, if the Stage of the instrument be not adapted to rotate in the optic axis of the Body; so that objects which are being viewed by incident light may be presented to the illuminating rays in every direction. This rotation not only gives most valuable aid in the appreciation of the solid form of the object, by the play of light and shade among the inequalities of its surface; but also frequently brings into view features that would otherwise have escaped notice, either from having been previously thrown into shadow by some neighbouring prominence, or from not receiving their light at the angle at which they could most advantageously reflect it. And as it may be readily introduced into the construction of any Microscope, either on the plan of MM. Nacet which has been just described, or on that of Smith and Beck's 'Popular' Microscope to be presently noticed, the Author anticipates that it will ere long be adopted in almost every form of Stereoscopic Binocular.

49. *Crouch's Student's Binocular.*—This instrument was devised at a time when the construction of the Binocular was still almost exclusively confined to the makers of First-class instruments; and it had the great merit of bringing within reach of the Student a convenient and well-constructed Binocular, at a cost not greater than that usually charged for the addition of the Wenham prism and Secondary body alone. With the improvements it has since received, it still remains one of the best instruments of its class; and the Author, after considerable use of it, can strongly recommend it to such as desire to possess a Binocular at once cheap, good, and portable. Its general arrangement, as shown in Fig. 38, corresponds closely with that of the small Microscope of the same maker already described; the double body being supported on a 'limb' on the Lister model. The adjustment of the Eye-pieces for the distance of the eyes is made by a transverse bar which is attached to one of them, and which works through a slot-piece fixed to the other; so that if by the application of the finger

two Eye-pieces, and three Objectives, giving a range of powers from 25 to 400 diameters, is only 225 francs, or about £9. The price of the Stereo-pseudoscopic apparatus is 175 francs, or £7 additional.

and thumb to the projecting pin, the bar with the attached eye-piece be raised or lowered, the other eye-piece also is moved accordingly. The Stage is provided with a brass Object-carrier, which is fitted to it in the same manner as the glass object-carrier

FIG. 38.

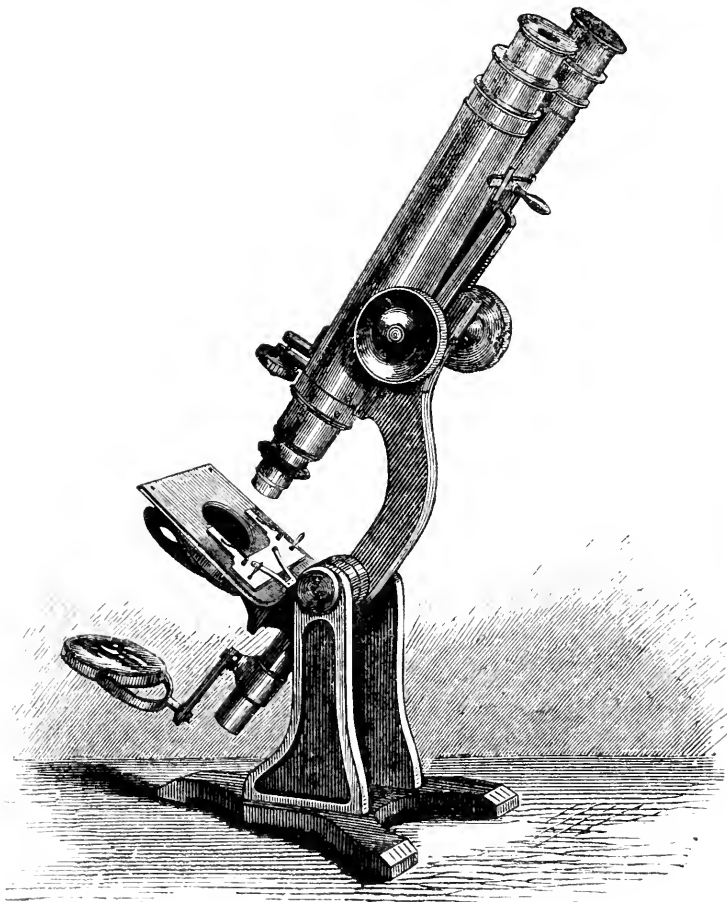

Crouch's Student's Binocular.

of MM. Nacet's Microscope (Fig. 37), and works with the like freedom and smoothness; but it does not possess that immunity to injury from acids or saline fluids which is so valuable a feature in MM. Nacet's construction. This, however, may be obtained, in combination with the rotatory movement which the Author



PLATE III.



SMITH AND BECK'S POPULAR MICROSCOPE.

To face p. 73.

regards as so important, by a modification of MM. Nacet's stage, which the maker of this instrument constructs for such as desire it. As the rotating disk, in Mr. Crouch's construction, works upon a short tube, instead of being imbedded in the fixed stage, this stage is not as thin as that of MM. Nacet, and therefore does not admit of the employment of light direct from the Mirror of as great obliquity. But the central tube may be made to carry any required fittings; and the 'Webster Condenser,' with the excentric diaphragms hereafter to be described (§ 80), may be easily made to give rays of almost any degree of obliquity that may be required; whilst a fine adjustment may be attached to the body for use with high powers.—This instrument, however, is not so much intended for the resolution of difficult objects, as it is for the Scientific investigations and general studies which can be carried on by means of moderate powers; to such it is quite as well adapted as instruments of far higher cost, whilst its portability and simplicity render it especially suitable for Seaside use, particularly when fitted with the Glass stage.

50. *Smith and Beck's Popular Microscope.*—For the general purposes of Microscopists, and especially for such as work with low and moderate powers upon objects for the study of which Binocular vision is peculiarly advantageous, there is probably no instrument more suitable than the one represented in Plate III., which was devised by the late Mr. R. Beck. Its chief peculiarity consists in the ingenious mode in which it is framed and supported; a mode which peculiarly adapts it to the requirements of Travellers, as enabling it to bear a good deal of rough usage without injury. The Stem to which the stage D and the mirror E are attached, and which contains the racked bar C that carries the arm B and the binocular body A, is itself attached by a pair of centres to the broad stay G, which again is attached by a pair of centres at its lower angles to the triangular base F. The lower end H of the stem carries a stout projecting pin, which fits into various holes along the medial line of the base; whereby the instrument may be steadied in positions more or less inclined, or may be fixed upright. It may be also fixed in the horizontal position required for drawing with the Camera Lucida (§ 71); for the pin at the bottom of the stem then enters the hole at the top of the stud K, and the stay G falls flat down, resting on the top of the stout pin L. The advantages of this construction are that it is strong, firm, and yet light; that the instrument rests securely at the particular inclination desired, which is often not the case on the ordinary construction when the joint has worked loose; and that in every position there is the needful preponderance of balance. The Stage D is circular, and upon it fits a circular plate T, which rotates in the optic axis of the Microscope; the special advantage of this rotation for Binocular study has been already pointed out (§ 48). On the plate T there slides the Object-holder U, which is so attached to it

by a wire spring that bears against its under surface, as to be easily moved by either or both hands; and as access can be readily gained to this spring by detaching the plate *r* from the stage, it may either be removed altogether so as to leave the stage free, or may be adjusted to any degree of stiffness desired by the observer. The Object-holder has a ledge *v* for the support of the slide; and it is also provided with a small spring *w*, attached to it by a milled-head, by turning which the spring may be brought to bear with any required pressure against the edge of the slide laid upon the object-holder, so as to prevent it from shifting its place when rotation is given to the stage, or when, the instrument being placed in the horizontal position, the stage becomes vertical. The central Tube of the Stage is adapted to receive fittings of various kinds, such as Diaphragm-plate, Dark-well, Paraboloid, and Polarizing prism; and it can also carry either a Webster Condenser or an ordinary Achromatic Condenser. This instrument may be furnished either with First-class or with Second-class Objectives; the latter are well adapted for Educational use; but the Scientific investigator will do well to provide himself with the former, bearing in mind, however, the caution already given (§ 30) as to Angle of Aperture.*

51. *Collins's Harley Binocular*.—This instrument, represented in Fig. 39, deserves mention, not merely for its general excellence, but also on account of certain special adaptations which render it peculiarly convenient to the Medical Student. It is substantially framed and well hung on the Ross model; and can be furnished with all the Accessories usually needed. The caps of the Eye-pieces are provided with shades, which cut off the outside lights from each eye; these can be adapted to any instrument, and the Author can speak strongly of their value from his own experience. The Wenham prism at the common base of the bodies is fitted into an oblong box, which slides through the arm that carries them; this contains, in addition, a Nicol analyzing prism, and is also pierced with a vacant Aperture; so that by merely sliding this box transversely until the Aperture comes into the axis, the instrument may be used as an ordinary Monocular; or, if the analyzing prism is made to take the place of the Wenham, whilst the polarizing prism beneath the stage is brought into position by rotating the Diaphragm-plate in which it is fixed, it is at once converted into a Polarizing Microscope. The Objectives screw into another movable fitting which holds two at once, and slides in the back and front direction, so that either of the two powers can be exchanged for the other with the greatest facility. The

* Thus the *small-angled* 4-10ths Objective of Messrs. Smith and Beck is much better adapted to Binocular use than the *large-angled* 4-10ths of the same makers. On the other hand, as the 1-4th inch Objective is unsuited to Binocular use, the choice between a wide and a narrow angle will have to be determined by other considerations (§ 131.)

chief drawback to the value of this instrument (in the Author's opinion) is its not being furnished with a Stage-plate rotating in the optic axis of the Microscope; it would not be difficult, however, to substitute the Nacet stage for the Mechanical stage

FIG. 39.

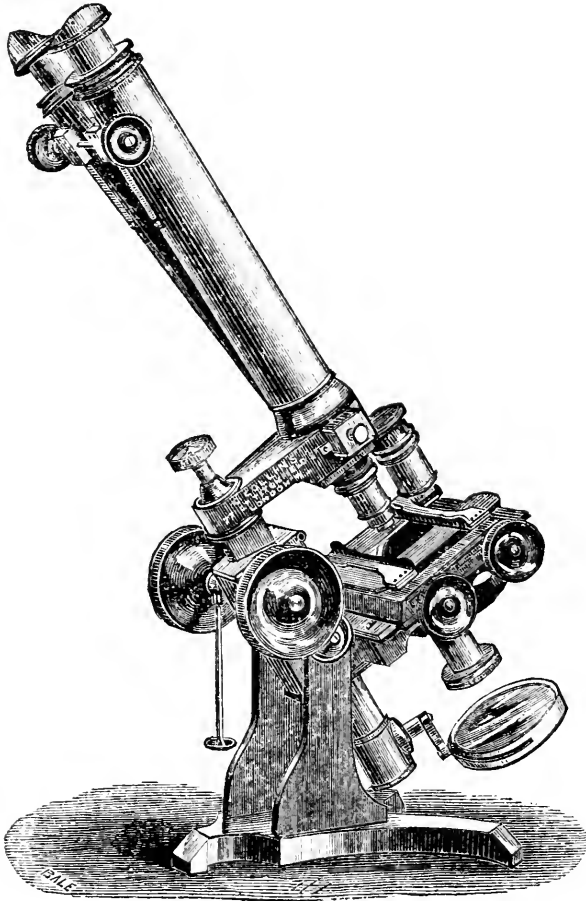

Collins's Harley Binocular.

represented in Fig. 39; and such substitution would not merely diminish the cost of the instrument, but would be (in the Author's opinion) a real improvement.*

* In addition to the Second-class instruments that have here been noticed, others, alike Monocular and Binocular, may be mentioned as

First-class Microscopes.

52. We now pass to an entirely different class of Instruments,—those of which the aim is, not simplicity, but perfection; not the production of the best effect compatible with limited means, but the attainment of everything that the Microscope *can* accomplish, without regard to cost or complexity. To such, of course, the Stereoscopic Binocular is an indispensable addition; and the Author regards it as not less essential that the Stage should have a *rotatory movement in the Optic axis of the instrument*, not only for the due examination of *opaque* objects, as already mentioned (§ 48), but also because this movement is requisite for the effective examination of very delicate *transparent* objects by Oblique light, allowing the effect of light and shadow to be seen in every direction (§ 119); and, in addition, because in the examination of objects under Polarized light, a class of appearances is produced by the rotation of the object between the prisms, which is not developed by the rotation of either of the prisms themselves. It is also important for the most advantageous use of the Illuminating Apparatus, that the Sub-stage also should be furnished with a rotatory movement.

53. *Ross's First-class Microscope.**—To this instrument (Plate IV.) the first place may fairly be assigned without any invidious preference; since it is the one which was earliest brought (in all essential features at least) to its present form. The general plan of Mr. Ross's Microscope is essentially the same as that which we have already seen to be adopted in a simpler form by many other makers; but it is carried out with the greatest attention to solidity of construction, in those parts especially which are most liable to tremor, and to the due balancing of the weight of the different parts upon the horizontal axis. The 'coarse' adjustment is made by the large milled-head situated just behind the summit of the uprights, which turns a pinion working into a rack cut on the back of a very strong flattened Stem that carries the transverse arm at its summit; a second milled-head (which is here concealed by the stage-fittings) is attached to the other end of the axis of the pinion (as in Fig. 32), so as to be worked with the left hand. The 'fine' adjustment is effected by the milled-head on the transverse Arm just behind the base of the 'body;' this acts upon the 'nose' or tube projecting below the arm, wherein the objectives are screwed. The other milled-head, seen at the summit of the stem,

favourably known to the Author, which are constructed, not only by the makers of the above, but by Messrs. Baker, Highley, How, Murray and Heath, Pillischer, Ross, Swift, and Wheeler, as also by Mr. Dancer, of Manchester.

*This instrument, devised by the late Mr. Andrew Ross, has undergone very important modifications at the hands of his son, Mr. Thomas Ross; having been altogether considerably lightened, and the construction of the Stage having been greatly improved.

PLATE IV.

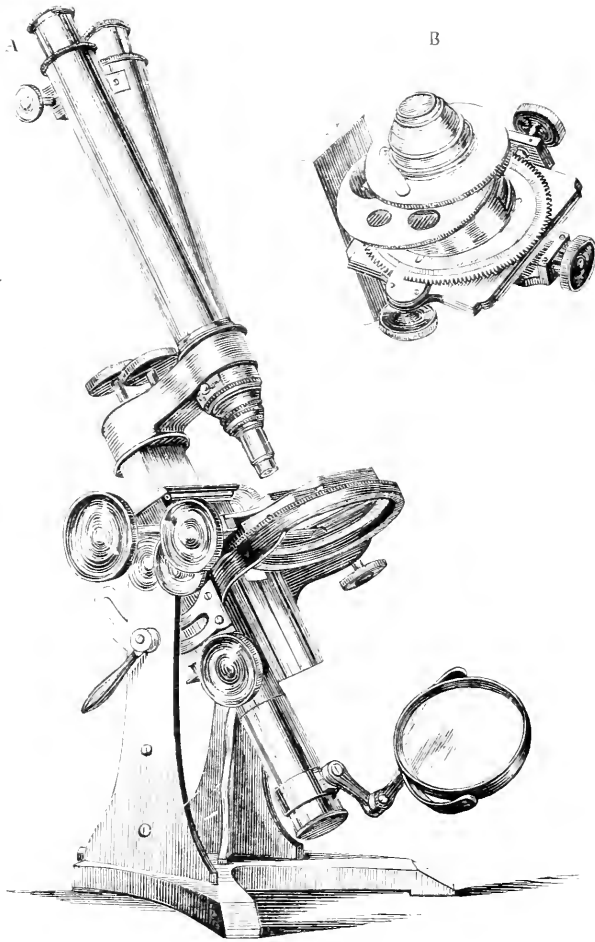

ROSS'S LARGE MICROSCOPE.

[To face p. 76.]



serves to secure the transverse arm to this, and may be tightened or slackened at pleasure, so as to regulate the traversing movement of the arm ; this movement is only allowed to take place in one direction, namely, towards the right side, being checked in the opposite by a 'stop,' which secures the coincidence of the axis of the Body with the centre of the Stage, and with the axis of the Illuminating apparatus beneath it.—It is in the movements of the Stage that the greatest contrivance is shown : these are three, namely, a traversing movement from side to side, a traversing movement from before backwards, and a rotatory movement. The traversing movements, which allow the platform carrying the object to be shifted about an inch in each direction. are effected by the two milled-heads situated at the right of the stage ; and these are placed side by side, in such a position that one may be conveniently acted-on by the fore-finger, and the other by the middle-finger, the thumb being readily passed from one to the other. The traversing portion of the stage carries the Platform whereon the object is laid, which has a ledge at the back for it to rest against : and this platform has a sliding movement of its own, from before backwards, by which the object is first brought near to the axis of the Microscope, its perfect adjustment being then obtained by the traversing movement. To this platform, and to the traversing slides which carry it, a rotatory movement is imparted by a milled-head placed underneath the stage on the left-hand side ; for this milled-head turns a pinion which works against the circular rack (seen in the figure), whereby the whole apparatus above is carried round about two-thirds of a revolution, without in the least disturbing the place of the object, or removing it from the field of the Microscope. The graduation of the circular rack, moreover, enables it to be used as a Goniometer (§ 69). In the improved form of this instrument here represented, the whole Stage-apparatus is made so thin, and the opening beneath so large, as to permit the employment of light of extreme obliquity ; and to enable the Mirror to afford this, it is mounted upon an extending arm, the socket of which slides upon a cylindrical stem. Below the stage, and in front of the stem that carries the mirror, is a dovetail sliding-bar, which is moved up and down by the milled-head shown at its side ; this sliding-bar carries what is termed by Mr. Ross the 'Secondary Stage' (shown separately at B), which consists of a cylindrical tube for the reception of the Achromatic Condenser, Polarizing prism, and other fittings ; it is here shown as fitted with a Condenser specially devised by Mr. T. Ross for the illumination of a large field under low magnifying powers. To this Secondary Stage, also, a rotatory motion is communicated by the turning of a milled-head ; and a traversing movement of limited extent is likewise given to it by means of two screws, one on the front and the other on the left-hand side of the frame which carries it, in order that its axis may be brought into perfect coincidence with

the axis of the body.—The special advantages of this instrument consist in its perfect steadiness, in the admirable finish of its workmanship, and in the variety of movements which may be given both to the Object and to the fittings of the Secondary Stage. Its disadvantages consist in the want of portability that necessarily arises from the substantial mode of its construction; and in the multiplicity of its movable parts, which presents to the beginner an aspect of great complexity. This complexity, however, is much more apparent than real; for each of these parts has an independent action of its own, the nature of which is very soon learned; and the various milled-heads are so disposed that the hand readily (and at last almost instinctively) finds its way from one to the other, so as to make any required adjustment whilst the eye is steadily directed to the object. To the practised observer, therefore, this multiplication of adjustments is a real saving of time and labour, enabling him to do perfectly and readily what might otherwise require much trouble, besides affording him certain capabilities which he would not otherwise possess at all.

54. *Powell and Lealand's First-class Microscope.*—The earlier form of this instrument, represented in Plate v., is far lighter than the preceding in its general 'build,' without being at all deficient in steadiness; it has not, however, some of those movements for which Mr. Ross's plan of construction is especially adapted. The tripod stand gives a firm support to the trunnions that carry the tube to which the stage is attached, and from which a triangular Stem is raised by the rack-and-pinion movement set in action by the double milled-head, whereby the 'coarse' adjustment of the focus is obtained.* The triangular stem carries at its summit the transverse Arm, which contains (as in Mr. Ross's Microscope) the lever-action of the 'fine' adjustment; and this is acted on by the milled-head at the back of the arm, whence also pass two oblique stays, which, being attached to the upper part of the Body, assist in preventing its vibration. The Stage is provided with a traversing movement in each direction, to the extent of about three-quarters of an inch; this is effected on the plan known as Turrell's, in which the two milled-heads are placed on the same axis, instead of side by side, one of them being also repeated on the left hand of the stage, so that the movements may be communicated either by the right hand alone or by both hands in combination. The Platform which carries the object is made to slide, as in the preceding case, on the summit of the traversing apparatus; and it has not only a ledge on which the object may rest, but also a 'spring-clip' for securing the object whenever the stage may be placed in a vertical position. This platform, moreover, is so connected with the traversing apparatus, that it may be turned round in the direction of its plane: but as this rotation takes place above

* A smaller and lighter form of this instrument is made, in which the legs fold together, so that it admits of being packed into a flat case.

PLATE V

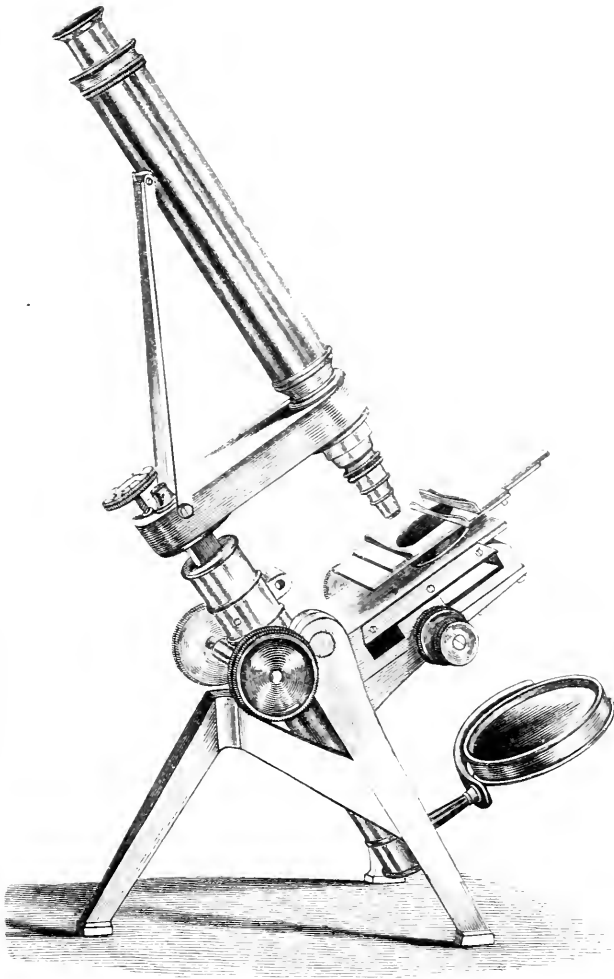

POWELL AND LEALAND'S SMALLER MICROSCOPE.

[To face p. 78.]

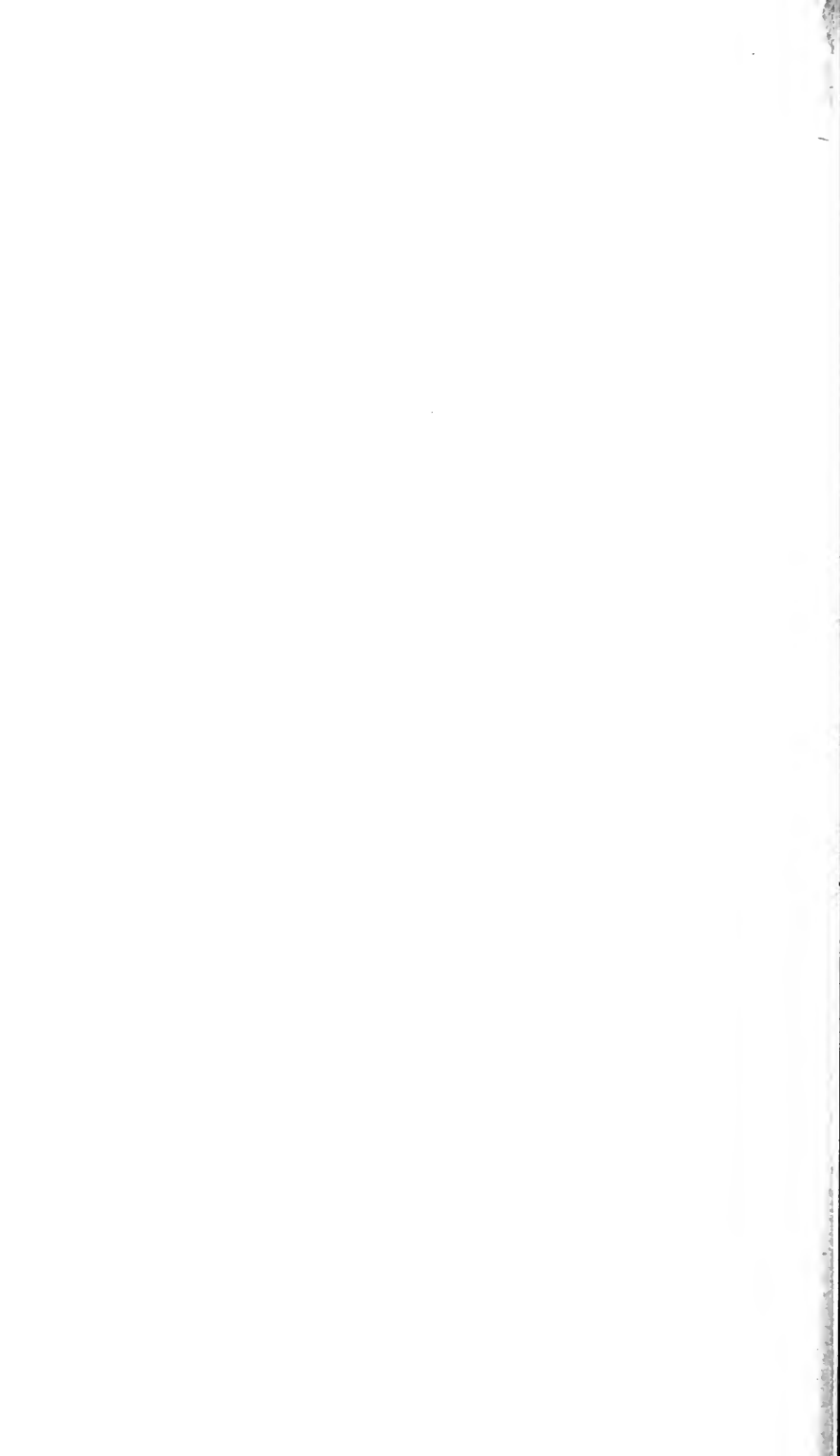
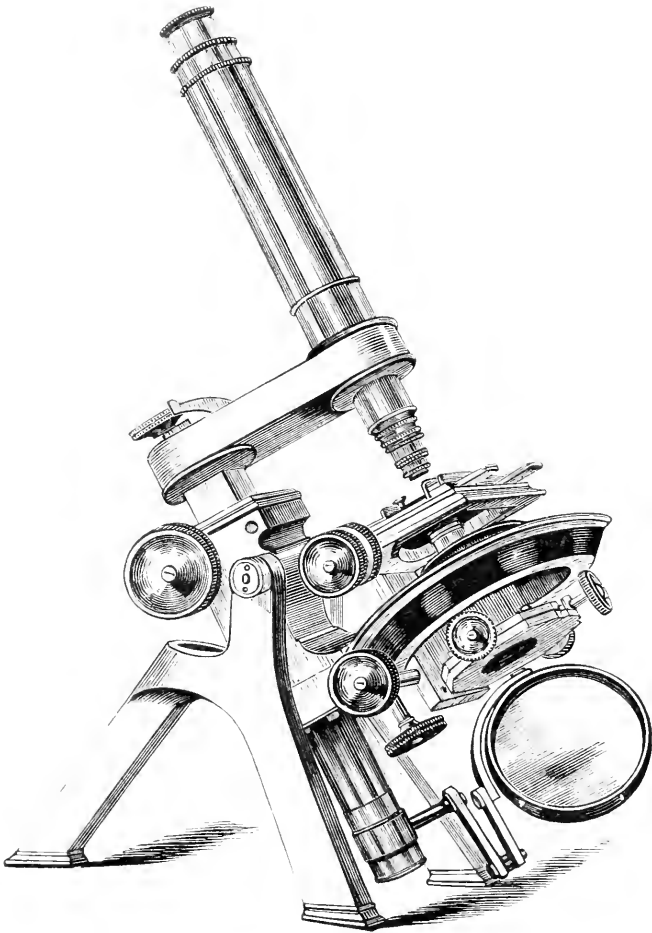



PLATE VI.



POWELL AND LEALAND'S LARGE MICROSCOPE.

[To face p. 79.]

instead of beneath the traversing apparatus, there is no security that the centre of rotation shall coincide with the optic axis of the instrument; so that, unless this adjustment have been previously made, the object will be thrown completely out of the field of view when the platform is made to revolve. The Condenser for transparent objects, the Polarizing apparatus, &c., are here fitted to the under side of the principal stage itself, instead of to an independent or secondary stage; an arrangement which, though convenient as regards compactness, admits of less variety of adjustment than is afforded by the latter plan. The Mirror, instead of being swung loosely upon two centres, is pivoted to one end of a quadrant of brass, of which the other end is pivoted to a strong pin that projects from the sliding tube; a spring being so attached to each of these pivots, as to give to the movements of the mirror that suitable degree of stiffness which shall prevent it from being disturbed by a passing touch. No instrument can be better adapted than this to all the *ordinary* wants of the Microscopist; there are very few purposes which it cannot be made to answer: and there are many who will consider that its deficiency as to these is counter-balanced (to say the least) by its comparative simplicity and portability, as well as by its lower cost.—For the sake, however, of such as may desire the power of obtaining a more Oblique Illumination than is permitted by the construction of the stage in the instrument just described, with rotatory movements of the Stage and Sub-stage, Messrs. P. and L. have brought out a new pattern (Plate VI.), which, while it resembles the preceding in its general plan of construction, though much more massive, differs from it entirely in the construction of the stage and sub-stage, both of which rest on the foundation of a large solid brass ring, firmly attached to the stem of the instrument. The upper side of this ring bears a sort of carriage that supports the Stage; and to this carriage a rotatory movement is given by a milled-head, the amount of the movement (which may be carried through an entire revolution) being exactly measured by the graduation of a circle of gun-metal, which is borne on the upper surface of the ring. The rotatory action of the Stage being thus effected beneath the traversing movement, the centering of an object brought into the axis of the Microscope is not disturbed by it; and the workmanship is so accurate, that the stage may be made to go through its whole revolution without throwing out of the field an object viewed even with the 1-16th inch objective. The Stage, which is furnished with the usual traversing movements, is made thin enough to admit of the most oblique light being thrown on the object; and it is furnished with graduated scales, so that the place of any particular object can be registered without the use of a 'finder' (§ 76). The Sub-stage also is furnished with rotatory and rectangular, as well as with vertical movements; and, like that of Messrs. Smith and Beck, it is made in such a manner as to admit of the simultaneous use of the Polarizing prism and of

the Achromatic Condenser. The Mirror has a doubly-extending arm ; and can be so placed as to reflect light upon the object from outside the large brass ring that supports the stage and sub-stage. Light of the greatest obliquity, however, may be more conveniently obtained by an Amici's prism (Fig. 62) placed above the supporting ring.—Notwithstanding the weight of all this apparatus, the instrument is so well balanced on its horizontal axis, that it remains perfectly steady without clamping, in whatever position it may be placed. And in regard to the apparent complexity of its arrangements, the remarks already made upon Mr. Ross's instrument are equally applicable to the one now described.

55. *Smith and Beck's First-class Microscope.*—For the *general plan* of this Instrument, the Author has already expressed his preference (§ 39) : the support of the Body, along a large proportion of its length, upon the substantial Limb to which the Stage is securely attached, giving it a decided advantage in steadiness over any form of instrument (not exceeding it in massiveness) in which the Body is attached at its lower extremity only to an Arm between which and the Stage there is no fixed connection ; whilst the Rack-and-pinion movement giving the 'coarse' adjustment can be made to work more easily on this construction, than where it is requisite that the stem moved by it should be fitted as tightly as possible. On the other hand, it must be admitted that the 'fine' adjustment can be more effectually made by the longer leverage provided in the 'Ross' model, than by the attachment of the screw to the lower end of the Body as in the instrument before us. The Stage, which is furnished with the usual traversing movements, is made (by an arrangement first devised by Messrs. Smith and Beck, and since adopted by other makers) so thin as to allow of extremely oblique illumination ; but although the platform which carries the object can be made to rotate upon the traversing apparatus, yet the object is liable to be thrown out of centre by this rotation, so as to require continual re-adjustment by the traversing motion ; and the stage *as a whole* is without the rotatory movement given to it in the Microscope of Mr. Ross, and in the Large Microscope of Messrs. Powell and Lealand. This want of the power of rotation in the optic axis of the instrument cannot but be regarded (for the reasons already stated, §§ 48. 52) as a decided deficiency in an instrument that is otherwise most complete and effective. Beneath the stage is a continuation of the gun-metal 'limb' which carries the body ; and this is ploughed out into a groove for the reception of a sliding-bar, which carries what may be termed the Secondary Body, namely, a short tube (seen beneath the stage) capable of being moved up and down by a milled-head, which answers the same purpose as the 'secondary stage' of Mr. Ross's Microscope. Being made to work in a groove which is in perfect correspondence with that wherein the principal 'body' works (this correspondence being secured by the action of

PLATE VII.

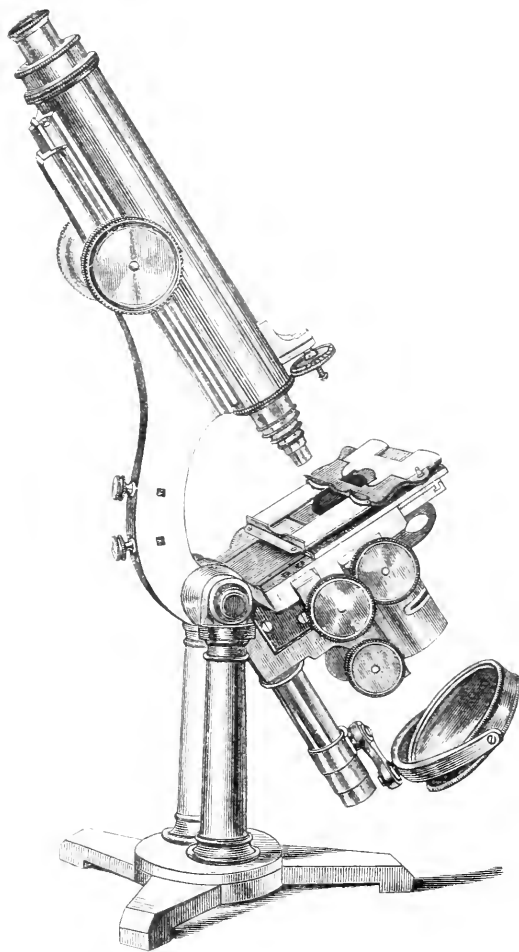

SMITH AND BECK'S LARGE MICROSCOPE.

[To face p. 80.]



the planing-machine that ploughs both grooves), the 'secondary' body always has its axis so perfectly continuous with that of its principal, that no special adjustment is needed to 'centre' the greater part of the illuminating apparatus. The 'secondary body' or 'cylindrical fitting' is so constructed as to carry the Achromatic Condenser at its upper end, the Polarizing prism at its lower, and the Selenite plates between the two (§ 89); it has not, however, any rotatory movement of its own; but its fittings may be turned in the tube which carries them. The Mirror is hung in the usual way between two centres; but the semicircle that carries these, instead of being at once pivoted to the tube which slides upon the cylindrical stem, is attached to an intermediate arm; and by means of this it may be placed in such a position as to reflect light very obliquely upon the object.—In regard to weight and complexity, this instrument holds a position intermediate between the Large Microscopes of Ross and of Powell and Lealand, and the Smaller Microscope of the latter makers. Though the mode in which the body is supported has the disadvantage of separating the focal adjustments from each other and from the stage-motions more widely than is the case in the three preceding instruments, yet the difference is scarcely perceptible in practice. The milled-heads acting on the former are both of them in positions in which they are easily reached by the left hand, when the elbow is resting on the table; whilst the right hand finds the milled-heads of the traversing stage and of the secondary body in close proximity to each other.—The imperfection of the means of giving rotation to the Object, and the want of rotatory movement in the Sub-stage, constitute points of inferiority to Ross's and to Powell and Lealand's Large Microscopes: but to those whose objects of pursuit are not of the kind for which these movements are specially required, the greater simplicity and less cost of Messrs. Smith and Beck's pattern may afford an adequate compensation for the deficiency.

Avoiding invidious comparisons, it may be safely said that whoever desires to possess a *First-class* Microscope, cannot do better than select one of the four instruments last described; the excellence of the Optical performance of the lenses supplied by their respective Makers being—except in the case of the very highest powers*—so nearly on a par, that the choice may be decided chiefly

* The 1-12th inch Objective of Mr. Ross bears the reputation of being the most perfect combination yet constructed of that power, at least in this country. Whether it is equalled or surpassed by M. Hartnach's most recent Immersion-lenses (§ 14) of the like power, has not yet the Author believes been determined by exact comparison *under the same circumstances*.—A 1-20th inch Objective has been recently constructed by Messrs. Smith and Beck, for the examination of objects that need a high magnifying power, but do not require that extreme of Angular Aperture which involves the employment of the very thinnest covering-glass and

by the preference which the taste of the purchaser, or the nature of the researches on which he may be engaged, may lead him to entertain for one or other of the plans of construction which has now been brought under review.*

Microscopes for Special Purposes.

Of the large number of Instruments which have been ingeniously devised, each for some particular use, it would be quite foreign to the purpose of this Treatise to attempt to give an account. A few forms, however, may be noticed, as distinguished either by their special adaptiveness to very common wants, or by the ingenious manner in which the requirements of particular classes of investigators have been met.

56. *Prof. Beale's Pocket Microscope.*—This instrument consists of an ordinary Microscope-body, the Eye-piece of which is fitted with a draw-tube, which slides smoothly and easily; whilst its lower end is fitted into an outer tube, of which the end projects beyond the objective. Against this projecting end the Object-slide is held by a spring, as shown in Fig. 40, being fixed (if necessary) by a screw-clip. The coarse adjustment is made by sliding the body through the outer tube which carries the object; and the fine adjustment by sliding the eye-tube in or out. The object, if transparent, is illuminated either by holding up the Microscope to a window or lamp, from which the rays may pass directly through it, or by directing it towards a mirror laid on the table at such an angle as to reflect light from either of these sources: if opaque, it is allowed to receive direct light through an aperture in the outer tube. The extreme simplicity and portability of this instrument (which when closed is only six inches long) constitute its special recommendation. Being fitted with the Universal Screw

the most careful preparation of the object: hence it may be employed with the same facility as an Objective of much longer focus; but as its Angle of Aperture is limited to 140° , it does not much surpass a good 1-8th inch Objective in its power of resolving Diatom-tests.—The 1-25th-inch of Messrs. Powell and Lealand is an Objective of marvellous perfection, and has proved itself admirably adapted to the highest class of Physiological investigations. The same Makers have even produced a 1-50th-inch Objective; but though its power is double that of the preceding, the Author is not aware that the increase has been found to be attended with any decided practical benefit.

* Several other Opticians may be named as makers of Microscopes which deserve to rank in the First Class, on account both of their Optical and of their Mechanical excellence; such are the instruments constructed by Messrs. Baker, Collins, Crouch, Dallmeyer, Ladd, Pillischer, Swift, and Wheeler. These are for the most part copied, with more or less of modification in detail, from the models either of Mr. Ross, or of Messrs. Smith and Beck; very little that is original having been introduced. The prices of these instruments, however, are usually from 10 to 20 per cent. less than those of the corresponding instruments of the original constructors; and excepting with the highest powers, little inferiority would be discovered in their performance, save by the most critical judges.

it may be worked with the Objectives of any British maker ; and with due care even high powers may be used, the eye-piece adjust-

FIG. 40.

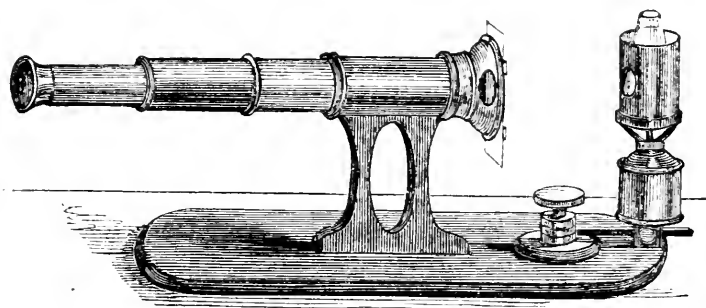

Prof. Beale's Demonstrating Microscope.

ment (first employed for this purpose by Mr. Highley) giving the power of very exact focussing. Hence this Pocket Microscope may be conveniently applied to the purposes of Clinical observation (the examination of Urinary Deposits, Blood, Sputa, &c.), either in hospital or in private practice ; whilst it may also be advantageously used by the Field Naturalist in examining specimens of Water for Animalcules, Protophytes, &c.

57. *Prof. Beale's Demonstrating Microscope.*—The same instrument has been successfully employed by Prof. L. Beale for the purposes of Class-demonstration, its outer tube being attached by a wooden support to a horizontal board, which also carries a small lamp attached to it in the required position (Fig. 40). The object having been fixed in its place, and the coarse adjustment made by sliding the body in the outer tube, these parts may then be immovably secured, and nothing need be left movable except the eye-tube, by sliding which in or out the fine adjustment may be effected. Thus the whole apparatus may be passed from hand to hand with the greatest facility, and without any probability of disarrangement ; and every observer may readily 'focus' for himself, without any risk of injuring the object.*

58. *Baker's Travelling Microscope.*—An instrument has been devised by Mr. Moginie, which is but little inferior in portability to the Pocket Microscope of Prof. Beale, and has many advantages

* The price of Prof. Beale's Clinical Microscope, as made by Mr. Highley, without Objectives, is only £1 5s. That of the same instrument fitted up as a Demonstrating Microscope, is £3.—An excellent Demonstrating Microscope is made also by Messrs. Murray and Heath ; and Mr. Collins has recently devised a new pattern for Hospital use, which may be used either as a Demonstrating or as an ordinary Student's Microscope.

over it. The Body (Fig. 41) slides in a tube which is attached to a stem that carries at its lower end a small Stage and Mirror. The Stem itself contains a fine adjustment that is worked by a milled-head at its summit; and near to this is attached by a pivot-joint a pair of legs, which, when opened out, form with the stem a firm tripod support. The coarse adjustment having been made by sliding the body through the tube which grasps it, the fine adjustment is made by the milled-head; and thus even high powers may be very conveniently worked. The legs being tubular, one of them is made to hold glass dipping-tubes, whilst the other contains needles set in handles, with three short legs of steel wire, by screwing which into the stem and stage, the instrument may be used (though not without risk of overturn) in the vertical position. Where the extreme of portability, however, is not required, a folding foot is supplied, which enables the Microscope to be used

FIG. 41.

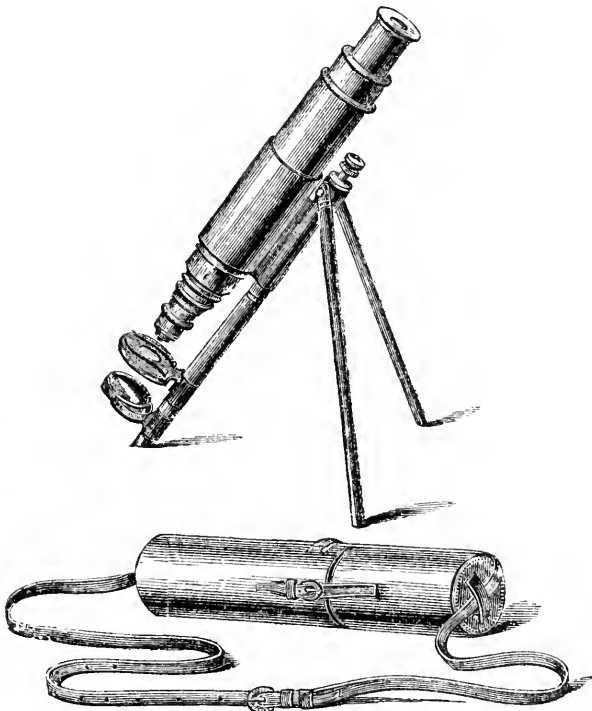

Baker's Travelling Microscope.

in the vertical position with satisfactory security and steadiness: and the instrument thus fitted can be packed into a small flat box

in such a limited compass that space is still left for the Objectives and Accessory apparatus most useful to the working Naturalist. This instrument may be specially recommended to those who already possessing a superior Microscope, desire neither to encumber themselves with it whilst travelling, nor to expose it to the risk of injury, but wish to utilize its Objectives by means of a simple and portable arrangement.*

59. *King's Pneumatic Aquarium Microscope.*—The purpose of this instrument is to enable such as possess an Aquarium to apply the Microscope to the examination of the structure and habits of the living animals it may contain, without disturbing or interfering with them in any way. It is simply a Microscope especially adapted for use with very low powers (a 2-inch and a 4-inch combination will be found most serviceable), which can be attached by a kind of sucker to the glass of the Aquarium, whether round or flat; the needful exhaustion being made by turning a screw.†

60. *Dr. Lawrence Smith's Inverted Microscope.*—A very ingenious arrangement has been devised by Dr. J. Lawrence Smith, of Louisiana, U.S., whereby objects may be viewed from their *under*

instead of from their upper surface; and thus Heat or Reagents may be applied to them, without any risk of dimming or more seriously injuring the object-glass by the vapours thus raised. The general plan of this instrument, as constructed by MM. Nachet, is shown in Fig. 42; whilst Fig. 43 explains the principle of its action. The Body is screwed obliquely into a kind of box

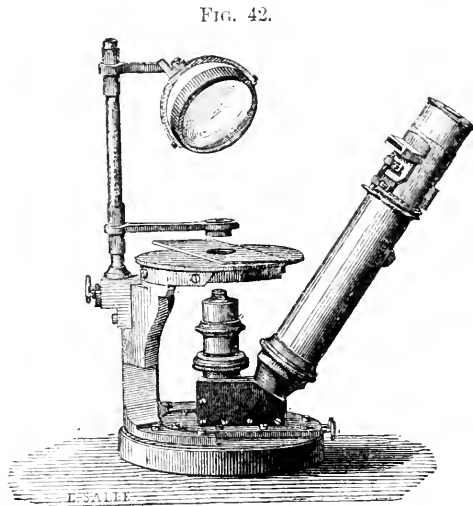

Dr. Lawrence Smith's Inverted Microscope.

to the base of the instrument, and which contains a Prism of the form shown in Fig. 43, its angles being respectively 55° , $107\frac{1}{2}^\circ$, $52\frac{1}{2}^\circ$, and 145° . The Objective is screwed erect into this

* An instrument nearly resembling the above is made by Messrs. Murray and Heath.

† The Aquarium Microscope is made by Mr. Collins, at the price of 3 guineas.

box, pointing upwards towards the lower side of the stage; and it

FIG. 43.

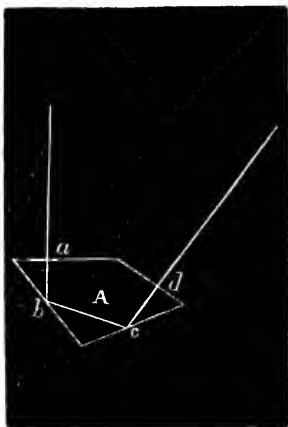

Inverting Prism.

is so attached that the coarse focal adjustment may be made by sliding it up and down, whilst the fine adjustment is made by means of a milled-head just above the prism-box. The Illuminating apparatus is of course placed above the stage, the light having to be sent downwards instead of upwards. Besides the Mirror, there is an arm which may carry Diaphragms, Polarizing prism, &c. When it is desired to apply Heat to an object, this is effected by placing the glass whereon it lies upon a plate of metal large enough to project beyond the stage, and by applying to the projecting part of this plate the flame of a spirit-lamp. The Optical part of the instrument is so fitted to the base, that it may be entirely drawn away from beneath the stage, for the sake of changing the powers. Its action will be readily understood from an inspection of the diagram (Fig. 43). The luminous rays which pass downwards from the object through the objective, impinge upon the prism at *a* perpendicularly to its surface; when they meet its first oblique surface at *b* they undergo total reflexion, by means of which they are sent on to *c*, where they meet its second oblique surface, and are again totally reflected, so as to pass forth at *d* perpendicularly to its surface, and consequently without refraction.—This instrument is extremely well adapted, not merely for Chemical investigations, but also for the examination of any objects (such as Diatomaceæ) that sink to the bottom of the liquid in which they are immersed; since, by coming into contact with the glass on which they lie, their surfaces are seen more exactly in one plane than when viewed from above. It is also well adapted for the purpose of Dissection; the hands and instruments being left much more free to work, when the object-glass does not stand in their way.*

61. *Nachet's Double-Foiled Microscope.*—The division of the

* The cost of this instrument, as made by MM. Nachet, and furnished with four Objectives, Micrometer eye-piece, Goniometer, and other accessories, is only 350 francs, or £14.—Dr. Leeson may fairly claim the credit of an independent inventor as regards this form of instrument; one essentially the same having been constructed for him by Messrs. Smith and Beck, at the same time that Dr. J. L. Smith's pattern was being worked out by MM. Nachet. See Mr. Highley's account of his Mineralogical Microscope, in "Quart. Journ. of Micros. Sci." Vol. iv. p. 281.

pencil of rays issuing from the object-glass by a separating Prism placed in its course, first introduced for the production of Stereo-

FIG. 44.

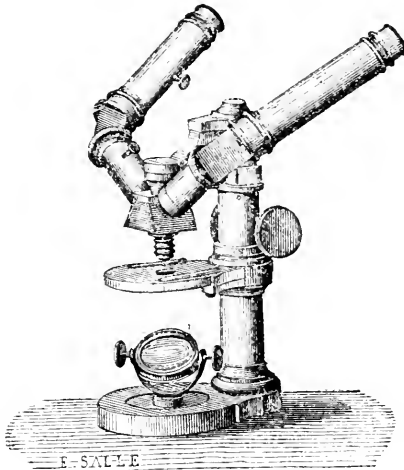

Nachet's Double-bodied Microscope.

scopic effects (§§ 26-29), has been applied by MM. Nachet to another purpose,—that of enabling two or more observers to look at the same object at once, which is often a matter not only of considerable convenience, but also of great importance, especially in the demonstration of dissections. The instrument, as arranged for this purpose, is shown in Fig. 44. MM. Nachet have also devised another arrangement, by which the form of the separating Prism is adapted to divide the pencil into *three* or even into *four* parts, each of which may be directed into a different body, so as to give to several observers at one time a nearly identical image of the same object. Of course, the larger the number of secondary pencils into which the primary pencil is thus divided, the smaller will be the share of *light* which each observer will receive; but this reduction does not interfere with the distinctness of the image, and may be in some degree compensated by a greater intensity of illumination.*

62. *Powell and Lealand's Non-Stereoscopic Binocular.*—The great comfort which is experienced by the Microscopist from the conjoint use of both Eyes, has led to the invention of more than one arrangement by which this comfort can be secured, when those high powers are required, which cannot be employed with the

* The price of the Double-bodied Microscope, with three Objectives, is 300 francs, or about £12.

Stereoscopic Binocular. This is accomplished by Messrs. Powell and Lealand by taking advantage of the fact already adverted to (§ 1), that when a pencil of rays falls obliquely upon the surface of a refracting medium, a part of it is reflected without entering that medium at all. In the place usually occupied by the Wenham prism, they interpose an inclined plate of glass with parallel sides, through which one portion of the rays proceeding upwards from the whole aperture of the Objective passes into the *principal* Body with very little change in its course, whilst another portion is reflected from its surface into a rectangular prism so placed to direct it obliquely upwards into the *secondary* Body (Fig. 45). Although there is a decided difference in brightness between the two images,* that formed by the reflected rays being the fainter, yet there is marvellously little loss of definition in either, even when the 25th-inch Objective is used. The disk and prism are fixed in a short tube, which can be readily substituted in any ordinary Binocular Microscope for the one containing the Wenham prism. — The Author can bear the most explicit testimony to the diminution of fatigue resulting from the use of this little apparatus: by which a prolonged employment of high powers is permitted, that would be prejudicial to the eye used singly; whilst it entirely prevents that bad effect which is liable to proceed from the too exclusive use of a single eye, the impairment of its power of focusing consentaneously with the other eye in ordinary vision.

FIG. 45.

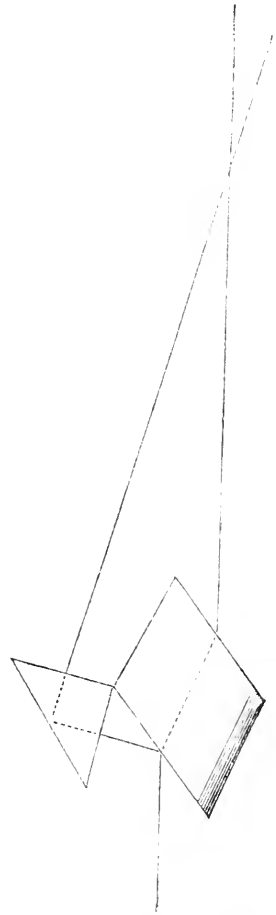

Powell and Lealand's Non-Stereoscopic Binocular Apparatus.

* An arrangement has been devised by Mr Wenham ("Transact. of Microsc. Soc." Vol. xiv. p. 103), by which the brightness of the images is more nearly equalized; but this involves difficulties of construction with which no one save its ingenious inventor has successfully grappled.

CHAPTER III.

ACCESSORY APPARATUS.

IN describing the various pieces of Accessory Apparatus with which the Microscope may be furnished, it will be convenient in the first place to treat of those which form (when in use) part of the instrument itself, being Appendages either to its Body or to its Stage, or serving for the Illumination of the objects which are under examination ; and secondly, to notice such as have for their function to facilitate that examination, by enabling the Microscopist to bring the Objects conveniently under his inspection.

Section 1. *Appendages to the Microscope.*

63. *Draw-Tube.*—It is advantageous for many purposes that the Eye-piece should be fitted, not at once into the 'body' of the Microscope, but into an intermediate Tube ; the drawing-out of which, by augmenting the distance between the Objective and the Image which it forms in the focus of the eye-glass, still further augments the size of the image in relation to that of the object (§ 20). For although the magnifying power cannot be thus increased with advantage to any considerable extent, yet, if the corrections of the Object-glass have been perfectly adjusted, its performance is not seriously impaired by a moderate lengthening of the body ; and recourse may be conveniently had to this on many occasions in which some amplification is desired, intermediate between the powers furnished by any two Objectives. Thus if one objective give a power of 80 diameters, and another a power of 120, by using the first and drawing out the Eye-piece, its power may be increased to 100. Again, it is often very useful to make the Object fill up the whole, or nearly the whole, of the field of view : thus if an object that is being viewed by transmitted rays is so far from transparent as to require a strong light to render its details visible, the distinctness of those details is very much interfered with, if, through its not occupying the peripheral part of the field, a glare of light enter the eye around its margin ; and the importance of this adjustment is even greater, if opaque objects mounted on black disks are being viewed by the Lieberkühn (§ 92), since, if any light be transmitted to the eye direct from the

mirror, in consequence of the disk failing to occupy the entire field, it greatly interferes with the vividness and distinctness of the image of the object. In the use of the Micrometric eye-pieces to be presently described (§§ 67, 68), very great advantage is to be derived from the assistance of the Draw-tube; as enabling us to make a precise adjustment between the divisions of the Stage-micrometer and those of the Eye-piece micrometer; and as admitting the establishment of a more convenient numerical relation between the two, than could be otherwise secured without far more elaborate contrivances. Moreover, if, for the sake of saving room in packing, it be desired to reduce the length of the body, the draw-tube affords a ready means of doing so; since the body may be made to 'shut up,' like a Telescope, to little more than half its length, without any impairment of the optical performance of the instrument when mounted for use (§ 43).

64. *Lister's Erector*.—It is only, however, in the use of the

FIG. 46.



Draw-tube fitted
with Erector.

Erector, that the value of the Draw-tube comes to be fully appreciated. This instrument, first applied to the Compound Microscope by Mr. Lister, consists of a tube about three inches long, having a meniscus at one end and a plano-convex lens at the other (the convex sides being upwards in each case), with a diaphragm nearly half way between them; and this is screwed into the lower end of the draw-tube, as shown in Fig. 46. Its effect is (like the corresponding erector of the Telescope), to antagonize the inversion of the image formed by the object-glass, by producing a second inversion, so as to make the Image presented to the eye correspond in position with the Object—an arrangement of great service in cases in which the object has to be subjected to any kind of manipulation. The passage of the rays through two additional lenses of course occasions a certain loss of light by reflexion from their surfaces, besides subjecting them to aberrations whereby the distinctness of the image is somewhat impaired; but this need not be an obstacle to its use for the class of purposes for which it is especially adapted in other respects, since these seldom require a very high degree of defining power. By the position given to the

Erector, it is made subservient to another purpose of great utility; namely, the procuring a very extensive *range* of Magnifying power, without any change in the Objective. For when the draw-tube, with the erector fitted to it, is completely pushed-in, the *acting length* of the body (so to speak) is so greatly reduced

by the formation of the first image much nearer the objective, that, if a lens of 2-3rds of an inch focus be employed, an object of the diameter of $1\frac{1}{2}$ inch can be taken in, and enlarged to no more than 4 diameters; whilst, on the other hand, when the tube is drawn-out $4\frac{1}{2}$ inches, the object is enlarged 100 diameters. Of course every intermediaterange can be obtained by drawing out the tube more

FIG. 47.

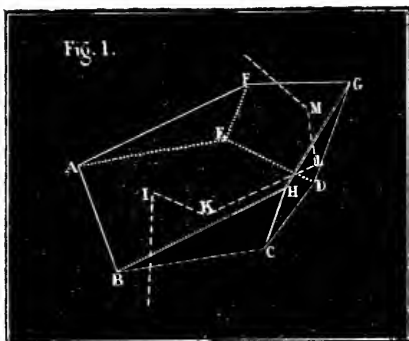

or less; and the facility with which this can be accomplished, especially when the Draw-tube is furnished with a rack-and-pinion movement (as in Messrs. Smith and Beck's Compound Dissecting Microscope), renders such an instrument very useful in various kinds of research.

65. *Nachet's Erecting Prism.*—An extremely ingenious arrangement has been made by MM. Nachet, on the basis of an idea first carried into practice by Prof. Amici, by which the inverted image given by the Compound Microscope is erected by a single rectangular Prism placed over the Eye-piece. The mode in which this prism is fitted up is shown in Fig. 48; the rationale of its action is explained by the diagram Fig. 47. The Prism is interposed between the two lenses of the eye-piece, and has somewhat the form of a double wedge, with two pentagonal sides, $A B C D E$, and $A B H G F$, which meet each other along the common edge $A B$, and two facets, $D E F G$, and $C D G H$, which meet along the common edge $D G$, the edges $A B$ and $D G$ being perpendicular to each other. The rays emerging from the Field-glass enter this prism by its lower surface, and are reflected at I upon the face $A B H G F$, from which they are again reflected upon the lower surface at the point K , and thence to the point L upon the vertical face $C D G H$, and lastly at the point M upon the other vertical face $D E F G$; from which the image, normally and completely erected, is again sent back, to issue by the superior

FIG. 48.

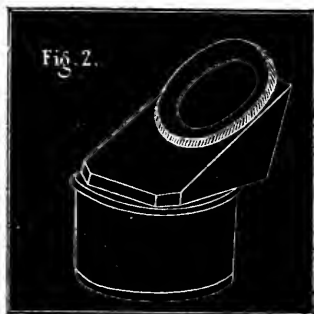

surface upon which the Eye-glass is placed. All the reflexions are total, except the first at 1; and the loss of light is far less than would be anticipated. The obliquity which this Prism gives to the visual rays, when the Microscope is placed vertically for dissecting or for the examination of objects in fluid, is such as to bring them to the eye at an angle very nearly corresponding with that at which the Microscope may be most conveniently used in the inclined position (§ 33, III.); so that, instead of being an objection, it is a real advantage.

66. *Spectroscope Eye-piece.*—The researches of Kirchoff and his

FIG. 49.

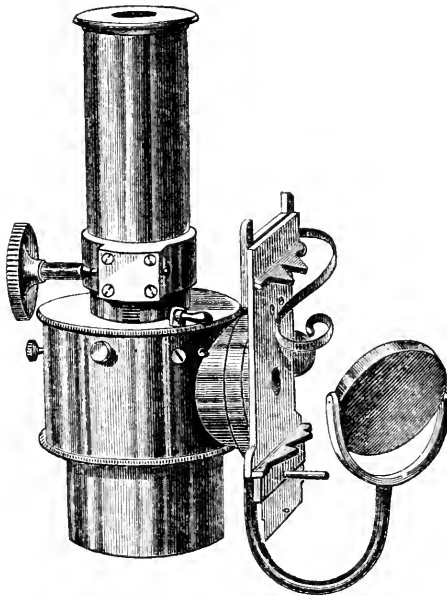

Sorby-Browning Spectroscope Eye-piece.

coadjutors having established the value of *Spectrum-Analysis** as the most efficient means of distinguishing an immense variety of substances—compound as well as simple—when present in very minute quantity, it became obvious that advantage would arise from the application of the same method of investigation to Microscopic inquiry; and, after making trial of different arrangements, Messrs. Sorby and Browning (by whom this investigation has been specially pursued) have adopted, as the most satisfac-

* By *Spectrum-Analysis* is meant the study of the Coloured lines or bands characteristic of different substances, when the luminous rays proceeding from them are made to undergo Chromatic Dispersion (§ 11) by passing through a prism or combination of prisms. Thus if a particle of Soda or any of its compounds be heated to incandescence in the slightly luminous flame of a spirit-lamp, the faint spectrum formed by the latter will be crossed by a bright yellow double line; and whenever this line is observable in the same part of the spectrum, the presence of Sodium may be certainly inferred. Again, when ordinary luminous rays are made to pass through solutions containing Organic or Inorganic compounds, many of these compounds are found to be recognizable by peculiarities in the spectra formed by the rays which they transmit to the prism; so that, as Prof. Stokes has shown, the colouring matter of Arterial Blood may be in this manner distinguished from that of Venous Blood. (See the Author's "Manual of Physiology," 4th Ed. § 535.)

tory, an Eye-piece which can be applied to any Microscope. This apparatus, represented in Fig. 49, fundamentally consists of an ordinary eye-piece, provided with certain special modifications. Above its Eye-glass, which is Achromatic, and capable of focal adjustment for rays of different refrangibilities, there is placed a tube containing a series of five prisms, two of Flint-glass (Fig. 50, FF) interposed between three of Crown

(c c c) in such a manner that the emergent rays $r r$, which have been separated by the dispersive action of the flint-glass prisms, are parallel to the rays which enter the combination.

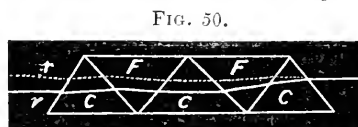

Arrangement of prisms in Spectroscope Eye-piece.

Below the eye-glass, in the place of the ordinary stop, is a Diaphragm with a narrow slit, which limits the admission of light. This would be all that is needed for the examination of the Spectra of objects placed on the stage of the Microscope, whether opaque or transparent, solid or liquid, provided that they transmit a sufficient amount of light. But as it is of great importance to make exact comparisons of such Artificial spectra, alike with the Ordinary or Natural spectrum, and with each other, provision is made for the formation of a second spectrum, by the insertion of a right-angled prism that covers one-half of this slit, and reflects upwards the light transmitted through an aperture seen on the right side of the eye-piece. For the production of the ordinary spectrum, it is only requisite to reflect light into this aperture from the small mirror carried at the side; whilst for the production of the spectrum of any substance through which the light reflected from the mirror can be transmitted, it is only necessary to place the slide carrying the section or crystalline film, or the tube containing the solution, in the frame adapted to receive it. In either case, this second Spectrum is seen by the eye of the observer alongside of that produced by the object viewed through the body of the Microscope, so that the two can be exactly compared.*

67. *Micrometric Apparatus.*—Although some have applied their micrometric apparatus to the Stage of the Microscope, yet it is to the Eye-piece that it may be most advantageously adapted.† The *Cobweb Micrometer*, invented by Ramsden for Telescopes, is probably, when well constructed, the most perfect instrument that the Microscopist can employ. It is made by stretching across the field of an Eye-piece two very delicate parallel Wires or Cobwebs, one of which can be separated from the other by the action of a

* See Mr. Sorby's description of this apparatus and of the mode of using it, in the "Popular Science Review" for Jan. 1866, p. 66.

† The Stage-micrometer constructed by Fraunhofer is employed by many Continental Microscopists; but it is subject to this disadvantage,—that any error in its performance is augmented by the *whole* magnifying power employed; whilst a like error in the Eye-piece Micrometer is increased by the magnifying power of the eye-piece alone.

fine-threaded screw, the head of which is divided at its edge into a convenient number of parts, which successively pass by an index as the milled-head is turned. A portion of the field of view on one side is cut off at right angles to the cobweb-threads, by a scale formed of a thin plate of brass having notches at its edge, whose distance corresponds to that of the threads of the screw, every fifth notch being made deeper than the rest for the sake of ready enumeration. The object being brought into such a position that one of its edges seems to touch the stationary thread, the other thread is moved by the micrometer-screw until it appears to lie in contact with the other edge of the object; the number of entire divisions on the scale shows how many complete turns of the screw must have been made in thus separating the threads, while the number to which the index points on the milled-head shows what fraction of a turn may have been made in addition. It is usual, by employing a screw of 100 threads to the inch, to give to each division of the scale the value of 1-100th of an inch, and to divide the milled-head into 100 parts; but the *absolute* value of the divisions is of little consequence, since their *micrometric* value depends upon the Objective with which the instrument may be employed. This must be determined by means of a ruled slip of glass laid upon the stage; and as the distance of the divisions even in the best-ruled slip is by no means uniform,* it is advisable to take an average of several measurements, both upon different slips, and upon different parts of the same slip. Here the Draw-tube will be of essential use, in enabling the Microscopist to bring the value of the divisions of his Micrometer to *even numbers*. Thus, suppose that with a 1-4th-inch Objective, the tube being pushed in, a separation of the lines by one entire turn and 37-100ths of another were needed to take in the space between two lines on the ruled slip whose actual distance is one 1-1000th of an inch, then it is obvious that 137 divisions on the milled-head are equivalent with that power to a dimension of 1-1000th of an inch, or the value of each division is 1-137,000th of an inch. But as this is an awkward number for calculation, the magnifying power may be readily increased by means of the Draw-tube, until the space of 1-1000th of an inch shall be represented by a separation of the cobweb-threads to the extent of 150 divisions; thus giving to each division the much more convenient value of 1-150,000th of an inch. The Microscopist who applies himself to researches requiring micrometric measurement, should determine the value of his Micrometer with each of the Objectives he is likely to use for the purpose; and should keep a table of these determinations, recording in each case the extent to which the

* Of the degree of this inequality, some idea may be formed from the statement of Hannover, that the value of the different divisions of a glass ruled by Chevalier to 1-100th of a millimetre, varied between the extreme ratios of 31 : 36, the mean of all being 34.

Tube has been drawn out, as marked by the graduated scale of inches which it should possess. And he should also make an accurate estimate of the thickness of the Cobweb-threads themselves; since, if this be not properly allowed for, a serious error will be introduced into the measurements made by this instrument, especially when the spaces measured are extremely minute. (See Mitchell in "Transact. Micros. Soc." Vol. xiv. p. 71.)

68. The costliness of the Cobweb Micrometer being an important obstacle to its general use, a simpler method is more commonly adopted, which consists in the insertion of a transparent scale into the focus of the Eye-piece, on which the image of the object is seen to be projected. By Mr. Andrew Ross, who first devised this method, the 'positive' Eye-piece (§ 22) was employed, and a glass plate ruled in squares was attached beneath its field-glass, at such a distance that it and the image of the object should be in focus together; and the value of these squares having been determined with each of the Objectives, in the manner already described, the size of the object was estimated by the proportion of the square that might be occupied by its image. While the use of the positive eye-piece, however, renders the definition of the ruled lines peculiarly distinct, it impairs the definition of the object; and the 'negative' or common Huyghenian Eye-piece is now generally preferred. The arrangement devised by Mr. G. Jackson, allows the divided glass to be introduced into the ordinary Eye-piece (thus dispensing with the necessity for one specially adapted for micrometry), and greatly increases the facility and accuracy with which the eye-piece scale may be used. This Scale is ruled like that of an ordinary measure (*i.e.*, with every tenth line *long*, and every fifth line half its length) on a slip of glass, which is so fitted into a brass frame (Fig. 51, B) as to have a slight motion towards either end; one of its extremities is pressed upon by a small fine milled-head screw which works through the frame, and the other by a spring (concealed in the figure) which antagonizes the screw. The scale thus mounted is introduced through a pair of slits in the Eye-piece tube, immediately above the diaphragm (Fig. 51, A), so as to occupy the centre of the field; and it is brought accurately into focus by unscrewing the glass nearest to the eye, until the lines of the scale are clearly seen. The value of the divisions of this scale must be determined by means of a ruled Stage-micrometer, as in the former instance, for each Objective employed in micrometry (the drawing out of the eye-piece tube enabling the proportions to be adjusted to even and convenient numbers); and this having been accomplished, the Scale is brought to bear upon the object to be measured, by moving the latter as nearly as possible into the centre of the field, and then rotating the Eye-piece in such a manner that the scale may lie across that diameter which it is desired to measure. The pushing-screw at the extremity of the scale being then turned until one edge of the

object appears to be in exact contact with one of the long lines, the number of divisions which its diameter occupies is at once read-off by directing the attention to the other edge, — the operation, as Mr. Quekett justly remarks, being nothing more than laying a rule across the body to be measured. This method of measurement

FIG. 51.

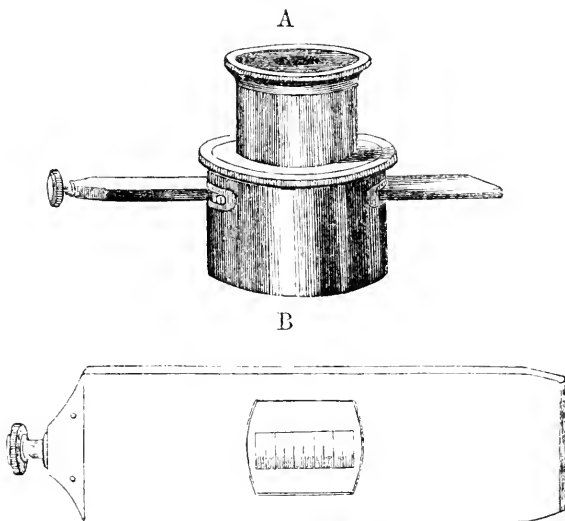

Jackson's Eye-piece Micrometer.

may be made quite exact enough for all ordinary purposes, provided, in the first place, that the Eye-piece Scale be divided with a fair degree of accuracy; and secondly, that the value of its divisions be ascertained (as in the case of the cobweb micrometer) by *several* comparisons with the scale laid upon the Stage. Thus, if by a *mean* of numerous observations, we establish the value of each division of the eye-piece scale to be 1-12,500th of an inch, then, if the image of an object be found to measure $3\frac{1}{2}$ of those divisions, its real diameter will be $3\frac{1}{2} \times \frac{1}{12500}$ or 1-3571st of an inch.* With an Objective of 1-12th-inch focus, the value of the divisions of the Eye-piece Scale may be reduced to 1-25,000th of an inch; and as the Eye can estimate a fourth part of one of the divisions with tolerable accuracy, it follows that a magnitude of as

* The calculation of the dimensions is much simplified by the adoption of a Decimal scale; the value of each division being made, by the use of the Draw-tube adjustment, to correspond to some aliquot part of a ten-thousandth or a hundred-thousandth of an inch, and the dimensions of the object being then found by simple multiplication:—Thus (to take the above example) the value of each division in the decimal scale is '00008, and the diameter of the object is '00028.

little as 1-100,000th of an inch can be measured with a near approach to exactness. Even this exactness may be increased by the application of the *diagonal scale* (Fig. 52) devised by M. Hartnack. The vertical lines are crossed by two parallel lines, at a distance from each other of five divisions of the vertical scale; and the parallelogram thus formed is crossed by a diagonal. It is obvious from this construction that the lengths of the lower segments of the 50 vertical lines, cut off by the diagonal, will pro-

FIG. 52.

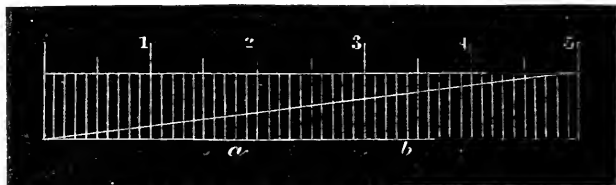

Hartnack's Eye-piece Micrometer.

gressively increase from $\cdot 1$ to $5\cdot 0$; so that when it is desired to obtain an exact measurement of an object between these limits, it is only requisite to find out that one whose length precisely coincides with the diameter to be taken, which it will then give in *tenths* of the value of the vertical divisions, whatever these may be. Thus, at *a*, the length of the segment will be $1\cdot 8$; at *b* it will be $3\cdot 4$.—Micrometric measurements may also be made with the Camera Lucida, in the manner to be presently described (§ 72).—Whatever method be adopted, if the measurement be made in the Eye-piece and not on the stage, it will be necessary to make allowance for the adjustment of the Object-glass to the thickness of the glass that covers the object, since its magnifying power is considerably affected by the separation of the front pair of lenses from those behind it (§ 113). It will be found convenient to compensate for this alteration, by altering the Draw-tube in such a manner as to neutralize the effect produced by the adjustment of the Objective; thus giving one uniform value to the divisions of the Eye-piece scale, whatever may be the thickness of the covering glass: the amount of the alteration required for each degree must of course be determined by a series of measurements with the Stage-micrometer.

69. *Goniometer*.—When the Microscope is employed in researches on minute Crystals, a means of measuring their angles is provided by the adaptation of a Goniometer to the eye-piece. The simplest form (contrived by Schmidt and made by Ross), which answers sufficiently well for all ordinary purposes, essentially consists merely of a 'positive' eye-piece, with a single cobweb-thread stretched diametrically across it in a circular frame capable of rotation; the edges of this frame are graduated in degrees, and a Vernier is also attached to the index, whereby fractional parts of

degrees may be read off. By rotating the frame carrying the thread, so that it shall lie successively in the directions of the two sides of the crystal, the angle which they form is at once measured by the difference of the degrees to which the index points on the two occasions. For the cobweb-thread, a glass plate, ruled with parallel lines at about the 1-50th of an inch asunder, may be advantageously substituted; since it is not then necessary to bring the crystal into such a position as to lie along the diametrical thread, but its angle may be measured by means of any one of the lines to which it happens to be nearest. In the Large Microscopes of Mr. Ross and of Messrs. Powell and Lealand (Plates IV., VI.) the same purpose is answered by the rotation of the Stage, the angles being read-off on the graduated circle.—If a higher degree of precision be required than either of these methods is fitted to afford, the *Double-refracting Goniometer*, invented by Dr. Leeson, may be substituted.*

70. *Diaphragm Eye-piece*.—It is often useful to cut off the light surrounding the object or part of the object to be examined; for the sake alike of avoiding glare that is injurious to the eye, and of rendering the features of the object more distinct. This may be accomplished on the plan of Mr. Slack, by the introduction, just above the ordinary 'stop,' of four small shutters, worked by as many milled-heads projecting slightly beyond the flange of the eye-piece. By combining the movements of these shutters in various ways, it is easy to form a series of symmetrical apertures, bounded by straight lines, and of any dimensions required. As remarked by its inventor, this Diaphragm Eye-piece may also be used to isolate one out of many objects that may be on the same slide, and thus to show that object alone to persons who might not otherwise distinguish it.—For this last purpose the *Indicator* of Mr. Quekett may also be used; which is a small steel hand placed just over the diaphragm, so as to point to nearly the centre of the field, whilst it may be turned back when not required, leaving the field of view quite free. The particular object or portion of the object to which it is desired to direct attention, being brought to the extremity of the hand, is thus at once 'indicated' to any other observer.

71. *Camera Lucida*.—Various contrivances may be adapted to the Eye-piece, in order to enable the observer to see the image projected upon a surface whereon he may trace its outlines. The one most generally employed is the *Camera Lucida prism*, contrived by Dr. Wollaston for the general purposes of delineation; this being fitted on the front of the Eye-piece, in place of the 'cap' by which it is usually surmounted. The Microscope being placed in a horizontal position, as shown in Fig. 53, the rays which pass

* For a description of this instrument see Dr. Leeson's description of it in Part xxxiii. of the "Proceedings of the Chemical Society," and Mr. Richard Beck's Treatise on the Microscope, p. 65.

through the Eye-piece into the Prism sustain such a total reflexion from its oblique surface, that they come to its upper horizontal surface at right angles to their previous direction ; and the eye being so placed over the edge of this surface that it receives these rays from the prism though part of the pupil, whilst it looks beyond the prism down to a white paper surface on the table with the other half, it sees the image so strongly and clearly projected

FIG. 33.

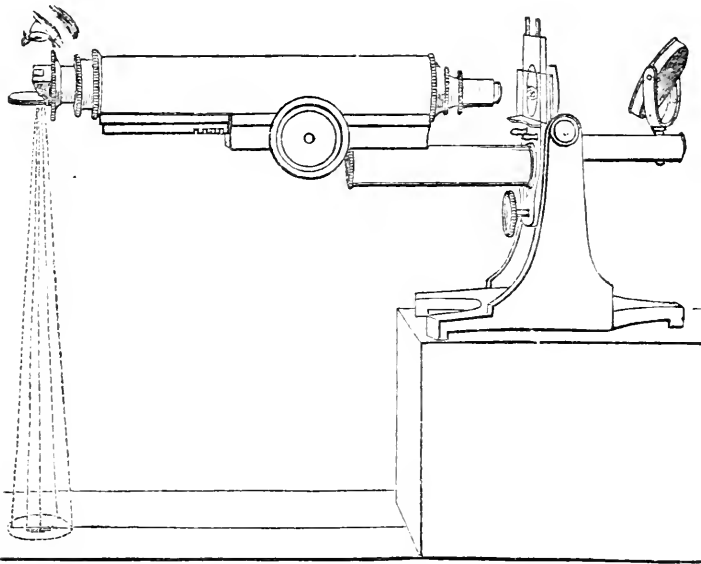

Microscope arranged with Camera Lucida for Drawing or Micrometry.

upon that surface, that the only difficulty in tracing it arises from a certain incapacity which seems to exist in some individuals for seeing the image and the tracing-point at the same time. This difficulty (which is common to all instruments devised for this purpose) is lessened by the interposition of a slightly convex lens in the position shown in the figure, between the eye and the paper, in order that the rays from the paper and tracing-point may diverge at the same angle as those which are received from the prism ; and it may be generally got over altogether by experimentally modifying the relative degrees of light received from the object and from the paper. If the image be too bright, the paper, the tracing-point, and the outline it has made, are scarcely seen ; and either less light may be allowed to come from the object, or more light (as by a taper held near) may be thrown on the paper and tracing-point. Sometimes, on the other hand, measures of the

contrary kind must be taken.—Another instrument for the same purpose is a flat *Speculum* of polished Steel, of smaller diameter than the ordinary pupil of the eye, fixed at an angle of 45° in front of the Eye-piece ; and this answers exactly the same end as the preceding, since the rays from the eye-piece are reflected vertically upwards to the central part of the pupil placed above the mirror, whilst, as the eye also receives rays from the paper and tracer, in the same direction, through the peripheral portion of the pupil, the image formed by the Microscope is visually projected downwards, as in the preceding case. This Disk, the invention of the celebrated anatomist Soemmering, is preferred by some microscopic delineators to the camera lucida. The fact is, however (as the Author can testify from his own experience), that there is a sort of ‘knack’ in the use of each instrument, which is commonly acquired by practice alone ; and that a person habituated to the use of either of them does not at first work well with another.—A different plan is preferred by some Microscopists, which consists in the substitution of a *plate* of neutral-tint or darkened Glass for the oblique mirror ; the eye receiving at the same time the rays of the microscopic image, which are obliquely reflected to it from the surface of the glass, and those of the paper, tracing-point, &c., which come to it through the glass.—In another very ingenious arrangement, devised by Prof. Amici, and adapted to the horizontal microscope by M. Chevalier, the eye looks through the Microscope at the object (as in the ordinary view of it), instead of looking at its projection upon the paper ; the image of the tracing-point being projected upon the field, which is in many respects much more advantageous. This is effected by combining a perforated steel mirror with a reflecting prism ; it is fitted to the Eye-piece of the Microscope as shown in Fig. 53 ; and its action will be understood by the accompanying diagram (Fig. 54). The ray $a b$ proceeding from the object, after emerging from the eye-piece of the Microscope, passes through the central perforation in the oblique mirror m which is placed in front of it, and so directly onwards to the eye. On the other hand, the ray $a' b'$ proceeding from the tracing-point, enters the prism p , is reflected from its inclined surface to the inclined surface of the mirror m , and is by it reflected to the eye in such parallelism to the ray proceeding from the object, that the two blend into one image.—The same effect is produced by a contrivance which has been devised by MM. Nacet for use with vertical Microscopes. It consists of a prism of a nearly rhomboidal form (Fig. 55), which is placed with one of its inclined sides $A C$ over the Eye-piece of the Microscope ; to this side is cemented an oblique segment, E , of a small glass cylinder, which presents to the ray $a b$ proceeding directly upwards from the object a surface at right angles to it ; so that this ray passes into the small cylinder E , and out from the side $A B$ of the larger prism, without sustaining any refraction, and with very little loss by reflexion

from the inclined surfaces at which they join. But the ray $a' b'$ which comes from the tracing-point on entering the rhomboidal prism, is reflected from its inclined side $B D$ to its inclined side $A C$, and thence it is again reflected to b in coincidence with the ray which has directly proceeded from the object.—A prism of a different shape, but constructed on the same principle, has been devised by MM. Nachet for use with a Microscope in the oblique position,

which is the one most comfortable to the delineator (see “*Quart. Journ. of Micros. Science*,” Vol. viii. p. 158).

72. It is so extremely useful to the Microscopist to be able to take outlines with one or other of these instruments, that every one would do well to practise the art. Although some persons at once acquire the power of seeing the image and the tracing-point with equal distinctness, the case is more frequently otherwise; and hence no one should allow himself to be baffled by the failure of his first attempt. It will sometimes happen, especially when the Prism is employed, that the want of power to see the pencil

is due to the faulty position of the Eye, too large a part of it being

FIG. 54.

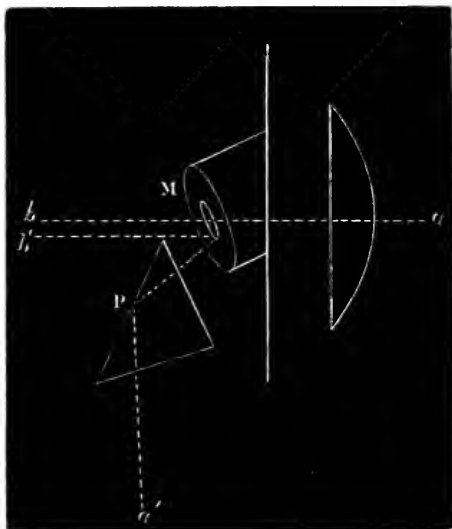
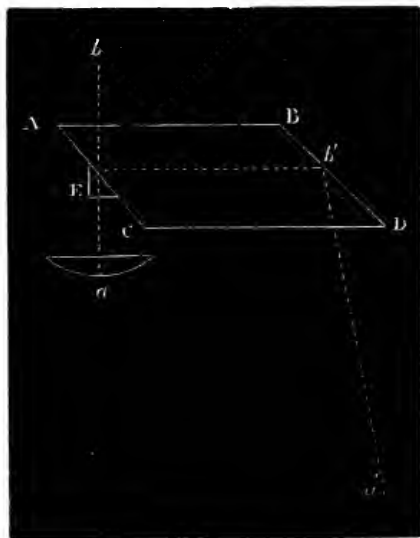

FIG. 55.



over the prism itself. When once a good position has been obtained, the Eye should be held there as steadily as possible, until the tracing shall have been completed. It is essential to keep in view that the proportion between the size of the tracing and that of the object is affected by the height of the eye above the paper; and hence that if the Microscope be placed upon a support of different thickness, or the Eye-piece be elevated or depressed by a slight inclination given to the body, the scale will be altered.— This it is, of course, peculiarly important to bear in mind, when a series of tracings is being made of any set of objects which it is intended to delineate on a uniform scale; or when the Camera Lucida (or any similar arrangement) is employed for the purpose of *Micrometry*. All that is requisite to turn it to this account is an accurately-divided Stage-micrometer, which, being placed in the position of the object, enables the observer to see its lines projected upon the surface upon which he has drawn his outline; for if the divisions be marked upon the paper, the average of several be taken, and the paper be then divided by parallel lines at the distance thus ascertained (the spaces being subdivided by intermediate lines, if desirable), a very accurate scale is furnished, by which the dimensions of any objects drawn in outline under the same power may be minutely determined. Thus if the divisions of a Stage-micrometer, the real value of each of which is 1-200th of an inch, should be projected with such a magnifying power as to be at the distance of an inch from one another on the paper, it is obvious that an ordinary inch-scale applied to the measurement of an outline, would give its dimensions in two-hundredths of an inch, whilst each fifth of that scale would be the equivalent of one-thousandth of an inch. When a sufficient magnifying power is used, and the dimensions of the image are measured by the 'diagonal' scale (which subdivides the inch into 1000 parts), great accuracy may be obtained. It has been by the use of this method, that Mr. Gulliver has made his admirable series of measurements of the diameters of the Blood-corpuscles of different animals.

73. *Nose-piece*.—It is continually desirable to be able to substitute one Objective for another with as little expenditure of time and trouble as possible; so as to be able to examine under a higher magnifying power the details of an object of which a general view has been obtained by means of a lower; or to use the lower for the purpose of *finding* a minute object (such as a particular Diatom in the midst of a slide-full) which we wish to submit to high amplification. An arrangement for this purpose has been already noticed in the description of Collins's "Harley Binocular" (Fig. 39); but the one more commonly in use is the Nose-piece of Mr. C. Brooke, which, being screwed into the object-end of the body of the Microscope, carries two Objectives, either of which may be brought into position by turning the arm on a pivot. In the original form of

this Nose-piece the arm is straight ; and its use is attended with the inconvenience of often bringing down upon the Stage the Objective *not* in use, unless the relative lengths of the two objectives are specially adjusted to prevent this. This inconvenience is still more felt in triple and quadruple nose-pieces. It is avoided, however, in the construction adopted by Messrs. Powell and Lealand (Fig. 56), and by MM. Nachet ; the bend given to the arm having the effect of carrying the Objective not in use completely off the Stage.—The working Microscopist will scarcely find any Accessory more practically useful to him than this simple piece of apparatus.

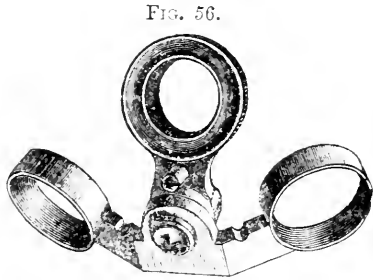

FIG. 56.

Powell and Lealand's Modification of Brooke's Nose-piece.

74. *Object-Marker*.—All Microscopists occasionally, and some continually, feel the need of a ready means of *finding*, upon a glass slide, the particular object, or portion of an object, which they desire to bring into view ; and various contrivances have been suggested for the purpose. Where different magnifying powers can be readily substituted one for another, as by the use of the Erector (§ 64) or of the Nose-piece (§ 73), no special means are required ; since when the object has been found by a low power, and brought into the centre of the field, it is rightly placed for examination by any other Objective. Even this slight trouble, however, may be saved by the adoption of more special methods : among the simplest of which is *marking* the position of the object on the surface of the thin glass which covers it. The readiest mode of doing this, when the object is large enough to be distinguished by the naked eye or under the Simple Microscope, is to make a small ring round it with a fine camel-hair pencil dipped in Indian ink ; but when the object is not thus visible, the slide must be laid in position on the stage, the object 'found' in the Microscope, the Condenser adjusted to give a bright and defined circle of light, and then, the Microscope-body being withdrawn, the black ring is to be marked around the illuminated spot.—The same end, however, may be more precisely as well as more neatly accomplished, by attaching an *object-marker* to the Objective itself. That of Mr. Tomes consists simply of an ivory cap, fitting over the 1-4th inch objective, having its extremity narrowed down (like that of the objective itself) but perforated in the centre, so as to form a minute ring ; the object having been 'found' and brought into the centre of the field, the cap is placed upon the objective, the ring it blackened with Indian-ink, and then, being carefully brought

by the focal adjustment into contact with the surface of the glass, it stamps on this a minute circle enclosing the object.

75. *Stage-Movement*.—The general arrangement of the Mechanical Stage now usually adapted to all high-class Microscopes has been already explained (§§ 53-55); and though the details are differently constructed by the several makers, yet the general principle is that a lateral or *horizontal* movement is given to the Object platform by one milled-head, and a front-to-back or *vertical* movement (the Microscope being supposed to be placed in an inclined position) by another.—The Stage may be so constructed, however, that motion shall be given to the object-platform by means of a *Lever* acting upon it in any required direction; this being accomplished by making the object-platform slide laterally on an intermediate plate, and by making the latter slide vertically upon the fixed stage-plate which forms the basis of the whole; each pair of plates being connected by dovetailed slides and grooves. Thus the Object-platform may be readily made to traverse, not merely horizontally or vertically, but, by the simultaneous sliding of both plates, in any intermediate direction. This is especially convenient in following the movements of Animalcules, &c., for which purpose this lever-stage is to be preferred to the ordinary form: its use being attended with this particular facility, that, as the motion of the hand is reversed by the lever, so that the object moves in the opposite direction, whilst the motion of the object is again reversed to the eye by the Microscope, the image moves in the same direction as the hand; and thus, with a little practice, even the most rapid swimmer may be kept within the field by the dexterous management of the lever. For general purposes, however, the ordinary Mechanical Stage will be found most convenient; whilst for following Animalcules, &c., several of the simpler arrangements described in the preceding Chapter answer extremely well.

76. *Object-Finder*.—The Mechanical Stage admits of a simple addition, which very much facilitates the 'finding' of objects mounted in slides, which are so minute as not to be distinguishable by the naked eye; such, for example, as the particular forms that present themselves in Diatomaceous deposits. This 'finder' consists of two graduated Scales, one of them *vertical*, attached to the fixed stage-plate, and the other *horizontal*, attached to an arm carried by the intermediate plate; the first of these scales enables the observer to 'set' the vertically-sliding plate to any determinate position in relation to the fixed plate, while the second gives him the like power of setting the horizontally-sliding plate by the intermediate. In order to make use of these Scales, it is of course necessary that the sliding and rotating platform on which the object immediately rests, should be always brought into one constant position upon the traversing plates beneath; this is accomplished by means of a pair of *stops*, against which it should

be brought to bear. So, again, this sliding-plate or object-platform should itself be furnished with a 'stop' for the glass slide to abut against, so as to secure this being always laid in the same position. These stops may be made removable, so as not to interfere with the ordinary working of the stage. Now supposing an observer to be examining a newly-mounted slide, containing any objects which he is likely to wish to find on some future occasion; he first lays the slide on the object-platform, with its lower edge resting on the ledge, and its end abutting against the lateral stop, and brings the object-platform itself into its fixed place against the stops; then, if, on giving motion to the slide by the traversing action, he meet with any particular form worthy of note, he reads-off its position upon the two scales, and records it in any convenient mode. The scale may be divided to 50ths of an inch, and each of these spaces may be again halved by the eye; the

record may perhaps be best made thus,—*Triceratium favus* $\frac{26}{18\frac{1}{2}}$; the upper number always referring to the upper scale, which is the horizontal, and the lower to the vertical. Now whenever the Microscopist may wish again to bring this object under examination, he has merely to lay the slide in the same position on the platform, to bring the platform itself into its fixed place on the traversing-plate below, and then to adjust the traversing-plates themselves by their respective scales.*

77. *Maltwood's Finder*.—The 'finder' now generally used, however, is that invented by Mr. Maltwood, and first described in the "Transactions of the Microscopical Society," Vol. vi. (1858), p. 59. This consists of a glass slide 3 inches by $1\frac{1}{4}$ inch, on which is *photographed* a scale that occupies a square inch, and is divided by horizontal and vertical lines into 2,500 squares, each of which contains two numbers, one marking its 'latitude' or place in the vertical series, and the other its 'longitude' or place in the horizontal series. The slide, when in use, should rest upon the ledge of the stage of the Microscope, and be made to abut against a stop about $1\frac{1}{2}$ inch from the centre of the stage.—In order to use this 'finder,' the Object-slide must be laid upon the Stage in such a manner as to rest upon its ledge and to abut

* This plan was suggested by Mr. Okeden in the "Quart. Micros. Journal," Vol. iii. p. 166; and it appears to the Author that it might be adopted with so little trouble or expense in every Microscope possessed of a mechanical stage, that it would be very desirable for every such Microscope to be furnished with these graduated scales. If the different Makers could agree upon some common system of Graduation, in the same way as they have adopted the "Universal Screw" for their Objectives, much trouble would be saved to Observers at a distance from one another, who might wish to examine each other's objects; for the numerical reference attached to each object would then enable it to be found by every observer whose stage should be graduated upon the same method.

against the stop ; and when some particular object, whose place it is desired to record, has been brought into the field of view, the object-slide being removed and the Finder laid down in its place, the numbers of the square then in the field are to be read off and recorded. To find that object again at any time, the Finder is to be laid in its place on the Stage, and the stage moved so as to bring the recorded number into view ; and the object-slide being then substituted for the Finder, the desired object will present itself in the field. As care is taken in the production of each instrument that the scale shall be at an exact distance from the bottom and left-hand end of the glass slide, the Microscopist may thus enable any other observer provided with a similar Finder to bring into view any desired object, by informing him of the numbers that mark its latitude and longitude. These numbers may either be marked upon the object-slide itself, or recorded in a separate list.*

78. *Diaphragm*.— The Stage of every Microscope should be provided with some means of regulating the amount of light sent upwards from the Mirror through transparent objects under examination. This is usually accomplished by means of a *Diaphragm-plate*, perforated by apertures of different sizes, which is pivoted to a removable fitting attached to the underside of the Stage (Fig. 35), in such a manner that by rotating the plate either of the apertures can be brought into the optic axis of the instrument. This plate should be always at least half an inch below the object, since it is otherwise comparatively inoperative. The largest of its apertures should be made to carry a ground-glass (so fitted as to be removable at pleasure), the use of which is to diffuse a soft and equable light over the field when large Transparent objects (such as Sections of Wood), are under examination ; between the smallest and the largest aperture there should be an unperforated space, to serve as a dark back-ground for Opaque objects. The *Diaphragm-plate* itself, the

* Other "finders" have been suggested in the pages of the "Quart. Micros. Journal," by Mr. J. Tyrrell, Mr. E. G. Wright, Mr. T. E. Amyot, and Mr. Bridgman, at pp. 234 and 302-304 of Vol. i. ; by Prof. Bailey, Mr. Amyot, and Mr. Hodgson, at pp. 55, 151, 209, and 243 of Vol. iv. ; by Mr. Farrants, in "Trans. of Micros. Soc." Vol. v. p. 88 ; and by the Committee appointed for the purpose, in the same volume, p. 95. Some of these have been superseded by Maltwood's Finder, but as this cannot be conveniently used except with a Mechanical Stage, those who do not possess that convenience must have recourse to such of the above-mentioned plans as they may find most suitable to their respective purposes.—Some of these methods only enable the Microscopist to "find" his own object, whilst others enable him to indicate it to any other observer. A very simple method of the former kind, applicable to Stages fitted with side-springs for holding the slides (Figs. 32, 41), has been pointed out to the Author by Mr. Moginie. If a small nick be filed in the inner edge of each spring at about the middle of its length, it is easy, when an object has been brought into position, to make two small ink dots upon the paper cover of the slide, by a fine pen inserted into each nick ; and whenever the two dots are brought again into their corresponding nicks, the object will be found in the field.

'well' of the Stage, in fact every part through which light passes to the object from beneath, must be blackened, in order to avoid the interference that would be occasioned by irregularly-reflected rays. The edge of the Diaphragm-plate should be notched at certain intervals, and a spring-catch fitted so as to drop into the notches, in order that each aperture may be brought into its proper central position.—Another very simple and effective arrangement for the same purpose, consists in the use of a single Diaphragm having an aperture of about $\frac{3}{16}$ ths of an inch, which is fixed in a tube that slides in the short tube screwed into the aperture of the stage (Fig. 34) for carrying the Polariscope, &c. When this diaphragm is pushed up so as to approach the Stage, it cuts off only a small portion of the cone of rays reflected upwards from the concave mirror; but when drawn downwards, it cuts off more and more of the peripheral portion of that cone, and thus gradually reduces the light. A small shutter for closing the aperture, so as to give a black back-ground for Opaque objects, is generally supplied with a diaphragm of this kind.—So great an advantage is often derivable from a *gradational* reduction or augmentation of the light, that the Microscopist who desires to avail himself of this will do well to provide himself with one of the forms of *Graduating Diaphragm* which have been recently introduced. That long ago invented by Dollond for Telescopic purposes is equally applicable to the Microscope; the circumstance that its aperture is square, instead of round, not constituting any practical objection to its use. In another form, introduced by Mr. Collins (Fig. 57), four shutters are made, by acting on a lever-handle, to move inwards simultaneously, so as to narrow the aperture, the shape of which always remains more nearly circular than square. And in the 'Iris Diaphragm' recently devised by Mr. Brown,* the multiplication of the number of shutters makes the aperture practically circular. Either of these may be advantageously attached to the Webster Condenser (§ 80).

FIG. 57.

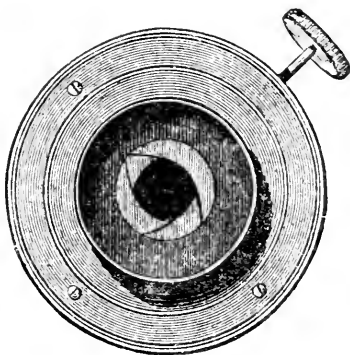

Collins's Graduating Diaphragm.

79. *Achromatic Condenser*.—In almost every case in which an Objective of $\frac{1}{4}$ th inch or any shorter focus is employed, its per-

* "Transactions of the Microscopical Society," Vol. xv. p. 74.—Another form of Graduating Diaphragm, in which the reduction of the aperture is effected by twisting a tube of Vulcanized Caoutchouc, is described by Mr. S. B. Kincaid in the "Trans. of Microsc. Soc." Vol. xiv. p. 75.

formance is greatly improved by the interposition of an Achromatic combination between the Mirror and the Object, in such a manner that the rays reflected from the former shall be brought to a focus in the spot to which the Objective is directed. A distinct picture of the source of light is thus thrown on the subject, from which its rays emanate again as if the object were self-luminous. The Achromatic combination, which (at least in all First-class Microscopes) is one specially adapted to the purpose, is furnished with a Diaphragm-plate (as first suggested by Mr. Gillett) immediately behind its lenses; and this is pierced with holes of such a form and size, as to be adapted to cut off in various degrees, not merely the peripheral, but also the central part, of the illuminating pencil. The former of these purposes is of course accomplished by merely narrowing the aperture which limits the passage of the rays through the central part of the lens; the latter, on the other hand, requires an aperture as large as that of the lens, having

FIG. 58.

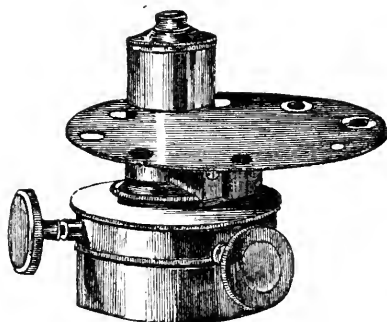

Smith and Beck's Achromatic Condenser.

its central part more or less completely occupied by a solid disk, which may so nearly fill the circle as to leave but a mere ring through which the light may pass. Such apertures are shown in the Diaphragm-plate in Fig. 58.—The Condenser thus completed is constructed on different plans by the three principal Makers, in accordance with the different arrangements of their respective stages. The thinness of the Stage in Messrs. Smith and Beck's Microscope allows the diaphragm-plate to be made upon the ordinary plan (Fig. 58), since it can be brought sufficiently near to the lenses of the Condenser, without coming into too close contiguity with the Stage; and this is obviously the simpler arrangement. In Messrs. Powell and Lealand's smaller Microscope, of which the stage is too thick to allow of the diaphragm-plate being placed beneath it, without removing that plate from its proper position behind the lenses of the condenser, the diaphragm-plate is made so small that it can be received into the interior of the stage (Fig. 59), and is rotated by a milled-head beneath; the edge of this is stamped with figures, each signifying a particular aperture, and thus marking by its position *which* aperture is in use. As, however, the smallness of the Diaphragm-plate so limits the number of apertures that the desirable variety could not be afforded by it alone, a second plate is

made to rotate immediately beneath it upon the same axis (like the hour and minute-hands of a watch) by means of a second milled-head numbered at its edge like the first; and the apertures

FIG. 59.

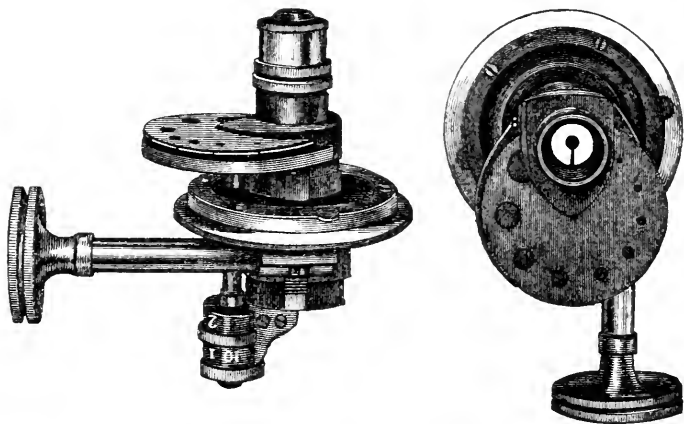

Powell and Lealand's Achromatic Condenser.

in the diaphragm-plate being simple circles, the centres of these are covered by stops of different sizes, supplied by the second or Stop-plate; by which very ingenious arrangement a great variety of combinations may be obtained, all of them indicated by the numbering on the two milled-heads. The Large Microscope of the same makers (Plate VI.) is furnished with a Condenser said to have an angular aperture of 170° ; and its stop-plate has its apertures so arranged with reference to those of the diaphragm-plate, as to give passage (when required) to only the extremely oblique rays proceeding from a small portion of the periphery—the mode of illumination most effective for the most difficult lined tests (§ 120). —A similar arrangement is now adopted by Mr. Ross; whose latest form of Achromatic Condenser is represented in Fig. 60. The combination of lenses has a focus of about 4-10ths of an inch, and an angular aperture of about 110° ; and whilst this aperture is found, when used with appropriate diaphragms, to give rays of an obliquity sufficient for the resolution of the most difficult tests, it is obvious that the focal length of this instrument gives it an advantage over Condensers of shorter focus, the illuminating pencils of which cannot reach objects mounted on ordinary slips of glass. The Diaphragm-plate, B, is furnished with a series of eight apertures, which progressively bring down the angle of the illuminating pencil from 110° to 20° ; whilst the Stop-plate, A, has three circular stops

for cutting-off the central rays in various degrees, three marginal slots for limiting the passage of the illuminating rays to particular parts of the periphery, and a supplementary aperture for the reception of any particular form of stop or slot that the observer may wish to employ. The edges of each plate are stamped with figures, which show what aperture is in use in the Diaphragm-plate, and what stop or slot in the Stop-plate. It may be added that the outer lenses of this combination are removable; so that two or even one may be used alone, forming a Condenser that is very suitable for use with Objectives of medium power.

FIG. 60.

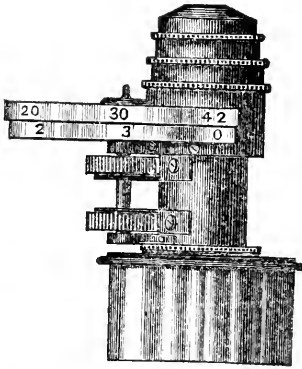

Ross's Achromatic Condenser.

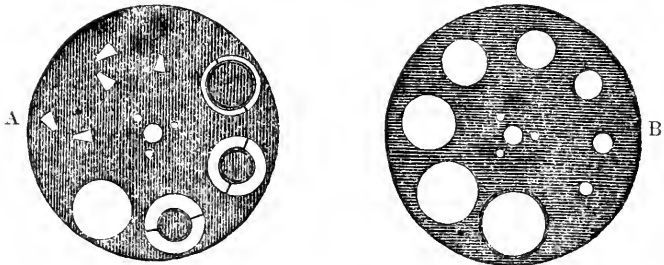

80. *Webster Condenser*.—Though the original idea of the arrangement which is now coming into general use under this designation, and which is at the same time comparatively inexpensive and applicable to a great variety of purposes, was given by Mr. J. Webster ("Science Gossip," April 1, 1865), it has received important modifications at the hands of the Opticians by whom the instrument is manufactured; and has, perhaps, not even yet undergone its full development. In its present form the arrangement of the lenses strongly resembles that used in the Kellner Eye-piece (§ 22); the field-glass of the latter serving as a Condenser to receive the cone of rays reflected upwards from the mirror, and to make it converge upon a smaller Achromatic combination, which consists of a double-convex lens of crown, with a plano-convex lens of flint, the plane side of the latter being next the object. These lenses are of large size and deep curvature; so that when their central part is stopped-out, the rays transmitted from their *peripheral* portion meet at a wide

angle of convergence, and have the effect of those transmitted through the peripheral portion of the ordinary Achromatic Condenser. When, on the other hand, this combination is used with a diaphragm that allows only the *central* rays to pass, these rays meet at a small angle; and the illumination thus given is very suitable for objects viewed with low powers. Again, by stopping out the central portion of the combination, and removing the Condenser to a short distance beneath the object, the effect of a Black ground illumination (§ 84) can be very satisfactorily obtained with Objectives of moderate angular aperture. Further, by stopping-out not only the central but also a great part of the peripheral rays, so as only to allow the light to enter from a small portion or portions of the margin, *oblique illumination* (§ 81) can be most effectively obtained. All this can be provided for by a Diaphragm-plate made to rotate at as short a distance as possible beneath the condensing-lens; but as the number of apertures in this plate is necessarily limited, a greater variety is obtained by the use of a Graduating Diaphragm (§ 78) for the regulation of the central aperture, and by making the apertures in the rotating plate subservient to the other purposes already named, as is done in the arrangement of Mr. Highley (who employs the Dollond Diaphragm) and Mr. Collins (Fig. 61).—Still greater variety can be obtained

by means of another very simple arrangement more recently introduced by Mr. Collins; the tube which carries the lenses being fitted with another tube which slides within it; and the summit of this last being furnished with a socket into which may be inserted a diaphragm of blackened card or of thin metal, with an aperture or apertures of any shape or size that may be desired.

In this manner the Diaphragm may be carried up quite close to the Condensing lens, which is a great advantage; and when Oblique illumination is desired, the light may be transmitted from any direction by simply giving rotation to the tube carrying a diaphragm with a marginal aperture.—The Webster Condenser thus improved (which may also be used in combination with the Polariscope) will be found one of the most universally-useful accessories with which a Student's Microscope can be provided.

FIG. 61.

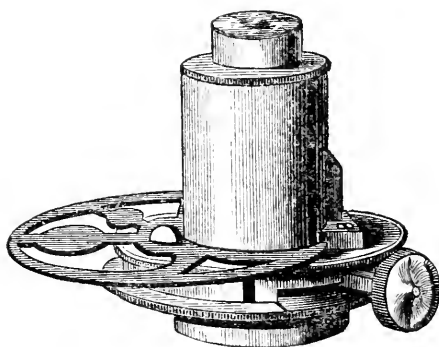

Webster's Condenser, fitted with Collins's Graduating Diaphragm.

81. *Oblique Illuminators*.—It is frequently desirable to obtain a means of illuminating Transparent objects with rays of more obliquity than can be reflected to them from the Mirror, even when this is thrown as much as its mounting will permit out of the axis of the Microscope; or than can be transmitted by the ordinary Achromatic Condenser, even when all but its marginal aperture is stopped-out. Such oblique light may be used in two entirely different modes.—The rays, although very far out of the axis of the Microscope, may still not make too great an angle with it to fall beyond the aperture of the Objective; and thus, entering its peripheral portion after their passage through the object, they will form the image in the ordinary way. The advantage of such oblique illumination arises from its power of bringing-out markings which cannot be seen when only direct rays are employed; and when the rays come only from one side, so as to throw a strong shadow, and either the Stage or the Illuminator is made to rotate so that the light shall fall upon the object *successively* in every azimuth, information may often be gained respecting the nature of these markings, such as can be acquired in no other mode (§ 119).—But the direction given to the rays may be so oblique that they shall not enter the Object-glass at all; in this case, they serve to illuminate the Object itself, which shines by the light whose passage it has interrupted; and as the observer then receives no other light than that which radiates from it, the object (provided it be of a nature to stop enough light) is seen *bright* upon a *dark field*.—Each of these methods has its advantages for particular classes of objects; and it is advisable, in all doubtful cases, to have recourse to every variety of oblique illumination that shall present the object under a different aspect. Almost every Microscopist who has especially devoted his attention to the more difficult *lined* or *dotted* objects, has devised his own particular arrangement for Oblique Illumination; but those methods only can here be noticed which have acquired *general* approval.* As they have little in common save their purpose, it seems scarcely possible to classify them according to any other character than that afforded by the *direction* which they give to the oblique rays; some of them bringing these to bear on the object from *one side* alone, and others from *all sides*.

82. The *Amici Prism*, which causes the rays to be at once reflected by a plane surface and concentrated by lenticular surfaces, so as to answer the purpose of Mirror and Condenser at the same time, is much approved by many who have used it. Such a Prism may be either mounted on a separate base, or attached to some part of the Microscope-stand. The mounting adopted by Messrs. Smith and Beck, and shown in Fig. 62, is a very simple

* Various other methods will be found described in the successive volumes of the "Transactions of the Microscopical Society" and of the "Quarterly Journal of Microscopical Science."

and convenient one; this consists in attaching the frame of the prism to a sliding bar, which works in dovetail grooves on the top of a cap that may be set on the 'secondary body' beneath the stage; the slide serves to regulate the distance of the prism from the axis of the microscope, and consequently the obliquity of the illumination; whilst its distance beneath the stage is adjusted by the rack-movement of the cylindrical fitting. In this manner, an illuminating pencil of almost any degree of obliquity that is permitted by the construction of the Stage may be readily obtained; but there is no provision for the correction of its aberrations. In

FIG. 62.

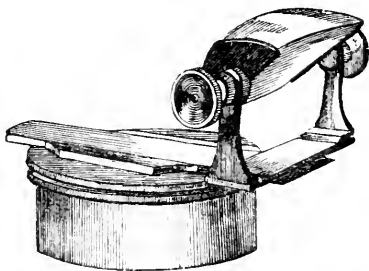

Amici's Prism for Oblique Illumination.

order to use this oblique illumination to the greatest advantage, either the Prism or the Object should be made to rotate, thus causing the oblique rays to fall upon the latter from every azimuth in succession, so as to bring out all its markings (§ 119).

83. For those who desire to obtain a very oblique illuminating pencil, for the resolution of the most difficult lined Tests by means of Objectives of large angular aperture, without having recourse to more expensive arrangements, the *Double Hemispherical Condenser* of Mr. Reade affords a very simple and convenient means. This consists of a hemispherical lens of $1\frac{1}{2}$ or $1\frac{3}{4}$ inch diameter, with its flat side next the object, surmounted by a smaller lens of the same form, the flat side of which is covered with a Diaphragm of thin brass or tin-foil, having an aperture or apertures close to its margin. The single hemisphere originally used by Mr. Reade gave an angle of convergence of about 90° for its most oblique rays; which is about the same with that of the Webster Condenser as at present constructed. By the addition of the second hemisphere, however, the angle of convergence is augmented to 150° ; and its power in 'bringing out' the lined tests is greatly augmented. Such an arrangement, of course, involves a large amount of Chromatic dispersion; but this is stated by Mr. Reade not to be a disadvantage in practice; since with high powers the red, the yellow, or the blue rays may be separately employed by altering the focus of the condenser, so that the illumination becomes virtually monochromatic. If the fineness of the lines under examination requires that the Condenser should be closely approximated to the object, the Diaphragms may be placed between the two hemispheres; a slit in the tube being provided for that purpose.

The Diaphragms for use with this or with the Webster Condenser, when very oblique illumination is required, may be cut out of thin brass or tin-foil, and blackened with oxide of copper. The apertures should be V-shaped, extending from the circumference to about a quarter of an inch from the centre; and it is often useful to have two such apertures in the same diaphragm at angles of from 60° to 90° from each other, so that two pencils of light may fall at the same time in different directions upon two sets of lines. By an ingenious arrangement devised by Mr. Reade, a second adjustable diaphragm may be made to shut off the inner portions of the V-shaped apertures, leaving only such parts of their marginal portions as may give the required obliquity to the illuminating rays.*

84. *Black-Ground Illuminators.* — Whenever the rays are directed with such obliquity as not to be received into the Object-glass at all, but are sufficiently retained by the Object to render it (so to speak) self-luminous, we have what is known as the *black-ground illumination*. For low powers whose angular aperture is small, and for such objects as do not require any more special provision, a sufficiently good 'black-ground' illumination may be obtained by turning the concave Mirror as far as possible out of the axis of the microscope, especially if it be so mounted as to be capable of a more than ordinary degree of obliquity. In this manner it is often possible, not merely to bring into view features of structure that might not otherwise be distinguishable, but to see bodies of extreme transparence (such, for instance, as very minute Animalcules) that are not visible when the field is flooded (so to speak) by direct light; these presenting the beautiful spectacle of phosphorescent points rapidly sailing through a dark ocean. Another very simple mode, which answers sufficiently well for low powers and for the larger objects which these are fitted to view, consists in substituting for the ordinary Condenser a plano-convex lens of great convexity, having on its plane side, which is the one turned towards the object, a central stop to cut off the direct rays; for the rays passing through the marginal portion of this *Spot-Lens*, being strongly refracted by its high curvature, are made to converge upon the object at an angle too wide for their entrance into an Objective of moderate aperture, and thus the field is left dark; whilst all the light stopped by the object serves (as it were) to give it a luminosity of its own. The same effect is gained by the use of the Webster Condenser (§ 80) with a central stop placed immediately behind the lower lens or upon the flat surface of the upper. Neither of the foregoing plans, however,

* See "Transactions of Microscopical Society," Vol. xv. p. 3.—Another Illuminator, giving a wide angular pencil, and specially devised by Mr. Wenham for use with the Binocular Microscope, is described by him in "Quart. Journ. of Microsc. Science," Vol. i. N.S. (1861), p. 111.

will answer well for Objectives of high power, having such large Angles of Aperture that the light must fall *very* obliquely to pass beyond them altogether. Thus if the pencil formed by the Spot-Lens have an angle of 60° , its rays will enter a 1-4th Objective of 70° , and the field will not be darkened.

85.—A greater degree of obliquity may be obtained by the *Parabolic Illuminator** (Fig. 63) now in general use; which consists of a Paraboloid of Glass that reflects to its focus the rays which fall upon its internal surface. A diagrammatic section of this instrument, showing the course of the rays through it, is given in Fig. 64, the shaded portion representing the Paraboloid. The parallel rays $r r' r''$, entering its lower surface perpendicularly, pass on until they meet its parabolic surface, on which they fall at such an angle as to be totally reflected by it (§ 2), and are all directed towards its focus F . The top of the Paraboloid being ground out into a spherical curve of which F is the centre, the rays in emerging from it undergo no refraction, since each falls perpendicularly upon the part of the surface through which it passes. A stop placed at s prevents any of the rays reflected upwards by the mirror from passing to the object, which, being placed at F , is illuminated by the rays reflected into it from all sides of the Paraboloid. Those rays which pass through it diverge again at various angles: and if the least of these, $G F H$, be greater than the Angle of Aperture of the Object-glass, none of them can enter it, so that the object is seen only by the light issuing from itself, and is shown brightly illuminated upon a black ground. The stop s is attached to a stem of wire, which passes vertically through the Paraboloid and terminates in a knob beneath, as shown in Fig. 63; and by means of this it may be pushed upwards so as to cut off the less divergent rays in their passage towards the object, by which means a black-ground illumination may still be obtained with Objectives of an Angle of Aperture much wider than $G F H$. In using the Paraboloid for delicate objects, the rays which are made to enter it should be parallel, consequently the *plane* Mirror should always

FIG. 63.

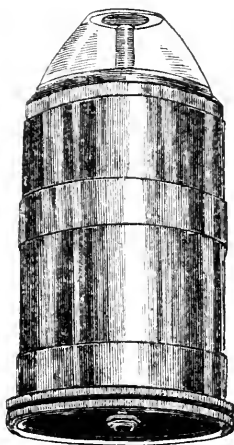

Parabolic Illuminator.

* A Parabolic Illuminator was first devised by Mr. Wenham, who, however, employed a Silver speculum for the purpose. About the same time Mr. Shadbolt devised an Annular Condenser of Glass for the same purpose (See "Transact. of Micros. Soc." Ser. 1, Vol. iii. pp. 85, 132). Both principles are combined in the Glass Paraboloid.

be employed ; and when, instead of the parallel rays of Daylight, we are obliged to use the diverging rays of a Lamp, these should be rendered as parallel as possible, previously to their reflexion

FIG. 64.

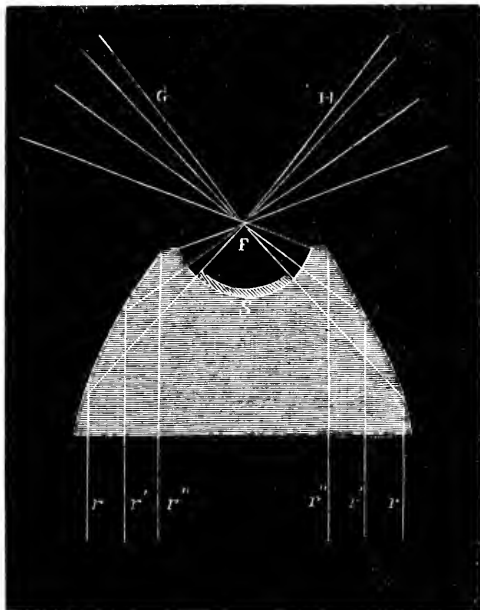

from the mirror, by the interposition of the 'bull's-eye' Condenser (§ 90) so adjusted as to produce this effect. There are many cases, however, in which the stronger light of the *concave* Mirror is preferable. When it is desired that the light should fall on the object from one side only, the circular opening at the bottom of the wide tube (Fig. 63) that carries the Paraboloid may be fitted with a diaphragm adapted to cover all but a certain portion of it : and by giving rotation to this diaphragm, rays of

great obliquity may be made to fall upon the object from every azimuth in succession.

86. For the exhibition of those classes of objects which are suitable for Black-Ground illumination, and which are better seen by light sent into them from every azimuth than they are by a pencil, however bright, incident in one direction only, no more simple, convenient, and efficient means could probably be found than that which is afforded by the Spot-Lens or the Webster Condenser for Objectives of low power, and by the Parabolic Illuminator for powers as high as 1-4th or 1-5th of an inch focus ; the use of the latter with powers still higher being rendered disadvantageous by the great reduction in the amount of light, occasioned by the necessity for cutting-off all the rays reflected from the Paraboloid which fall upon the object within the limits of their angle of aperture. With Objectives of extremely wide angles of aperture, a black-ground illumination may be obtained by Mr. Reade's Double Hemispherical Condenser (§ 83).—One of the great advantages of this kind of illumination consists in this ; that, as the light *radiates from* each part of the object as its

proper source, instead of merely *passing through* it from a more remote source, its different parts are seen much more in their normal relations to one another, and it acquires far more of the aspect of solidity. The rationale of this is easily made apparent, by holding up a glass vessel with a figured surface between one eye and a lamp or a window, so that it is seen by transmitted light alone; for the figures of its two surfaces are then so blended together to the eye, that unless their form and distribution be previously known, it can scarcely be said with certainty which markings belong to either. If, on the other hand, an opaque body be so placed behind the vessel that no rays are transmitted directly through it, whilst it receives adequate illumination from the circumambient light, its form is clearly discerned, and the two surfaces are distinguished without the least difficulty.

87. *White-Cloud Illuminators*.—It being universally admitted that the light of a bright white cloud is the best of all kinds of illumination for nearly every kind of Microscopic inquiry, various attempts have been made to obtain such light from the direct rays either of the Sun or of a Lamp, by what may be called an artificial cloud. Some have replaced the plane mirror by a surface of pounded glass or of carbonate of soda, or (more commonly) by a disk of plaster-of-Paris, the latter being decidedly the preferable method; but a sufficiently bright light is not thus obtained, unless a Condenser be employed to intensify the illumination of the mirror. Such a Condenser may be most conveniently attached by a jointed arm to the frame which carries the disk, according to the method of Messrs. Powell and Lealand, shown in Fig. 65; the frame itself being made to fit

upon the Mirror, and to turn with it in every direction. Another very simple, and for many purposes very efficient, mode of obtaining a white-cloud illumination (invented by Mr. Handford) consists in coating the back of a concave plate of glass, like that employed in the ordinary concave Mirror, with white zinc paint, instead of silvering it; and then mounting

this in a frame, which may be fitted (like the plaster-of-Paris disk just described) over the ordinary Mirror. A concave surface of plaster-of-Paris, moreover, may easily be obtained, by casting it when fluid upon the convex surface of such a plate. When a concavity is thus given to the white surface, its performance with low powers is much improved; but with high powers a special condensation of the light must be adopted, and the arrangement above described seems the simplest that could be

FIG. 65.

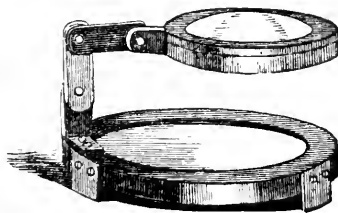

White-Cloud Illuminator.

devised. It is open, however, to certain objections, which become apparent when very high powers are used and difficult objects are under examination; and to obtain the most perfect white-cloud illumination possible, is the object of an apparatus devised by Mr. Gillett. This consists of a small camphine lamp, placed nearly in the focus of a Parabolic Speculum, which reflects the rays either at once upon a disk of roughened Enamel, or upon a second (hyperbolic) Speculum which reflects them upon such a disk. A very pure and concentrated light is thus obtained; and as the forms of the incident pencils are broken up by the roughened surface, that surface takes the place of a lamp as the source from which the rays primarily issue. The advantage of this illumination is specially felt in the examination of objects of the most difficult class under the highest powers.

88. *Polarizing Apparatus*.—In order to examine transparent objects by Polarized Light, it is necessary to employ some means of *polarizing* the rays before they pass through the object, and to apply to them, in some part of their course between the object and the eye, an *analyzing* medium. These two requirements may be provided for in different modes. The *Polarizer* may be either a bundle of plates of thin glass, used in place of the mirror, and polarizing the rays by reflexion; or it may be a 'single-image' or 'Nicol' prism of Iceland Spar, which is so constructed as to transmit only one of the two rays into which a beam of ordinary light is made to divaricate by passing through this substance; or it may be a plate of Tourmaline, or one of the artificial tourmalines composed of the disulphate of iodine and quinine, now known by the designation of 'Herapathite' after the name of their inventor. Of these methods, the 'Nicol' prism is the one generally preferred, the objection to the reflecting polarizer being that it cannot be made to rotate; the Tourmaline is undesirable, on account of the

FIG. 66.

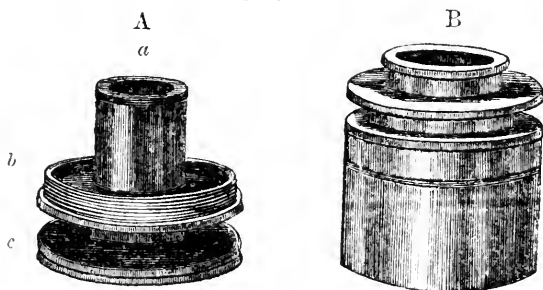

Fitting of Polarizing Prism in Smith and Beck's Microscope.

colour which it imparts when sufficiently thick to produce an effective polarization; whilst the crystals of Herapathite are

seldom obtained perfect of sufficient size to afford a good illumination, and when perfect are not always to be depended on for permanence. The Polarizing Prism is usually fitted into a tube (Fig. 66, A *a*) with a large milled head (*c*) at the bottom, by which it is made to rotate in a collar (*b*) that is attached to the microscope; this collar may be fitted to the under side of the Stage-plate, or, where a Secondary Stage is provided, it may be attached to this: in the microscope of Messrs. Smith and Beck, it screws into the lower part of a tube (Fig. 66, B) that slides into the 'secondary body' beneath the stage (Plate VII.). The *Analyzer*, which may be either a 'Nicol' prism, a Tourmaline, or a crystal of Herapathite, is usually placed either in the interior of the microscope, or between the eye-piece and the eye. If it be a prism it is mounted in a tube, which may either be screwed into the lower end of the body just above the Objective, or may be fitted over the Eye-piece in place of its ordinary cap (Fig. 67): in the former situation it has the advantage of not limiting the field, but it stops a considerable proportion of the light; in the latter, it detracts much less from the brightness of the image, but cuts off a good deal of the margin of the field. In using the Polarizing apparatus with the Binocular Microscope, the Analyzing prism must be placed between the Wenham prism and the Objective; and its holder should be so constructed as to allow of being rotated. By combining the Polarizing Apparatus with the Achromatic Condenser, it may be used with very high powers and with very oblique or even black-ground illumination. And when low powers are employed with the Webster Condenser or with a Spot-Lens, a very beautiful effect may be produced in the case of many large semi-transparent objects (such as the horny polyparies of Zoophytes, Fig. 277) by illuminating them on a black ground with Polarized rays reflected upwards from the bundle of thin-glass plates which may be substituted for the mirror, and then viewing them through the Analyzing prism in the usual manner.*

89. For bringing out certain effects of Colour by the use of Polarized Light (Chap. xx.), it is desirable to interpose a plate of *Selenite* beneath the polarizer and the object; and it is advantageous that this should be made to revolve. A very convenient mode of effecting this is to mount the *Selenite* plate in a revolving

* A Polarizer of Herapathite or Tourmaline may be used for this purpose instead of the glass-plate polarizer, by mounting it in a cap fitted above the Condenser or Spot-Lens, at such a distance as to receive its converging hollow pencil near its termination in the object.

FIG. 67.

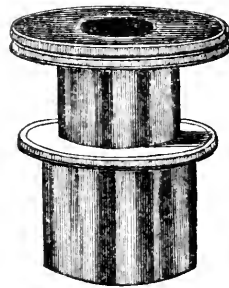

Fitting of Analyzing Prism upon the Eye-piece.

collar, which fits into the upper end of the tube (Fig. 66, B) that receives the Polarizing prism. In order to obtain the greatest variety of coloration with different objects, films of Selenite of different thicknesses should be employed ; and this may be accomplished by substituting one for another in the revolving collar. A still greater variety may be obtained by mounting three films, which separately give three different colours, in collars revolving in a frame resembling that in which hand-magnifiers are usually mounted, so that they may be used singly or in double or triple combinations ; as many as thirteen different tints may thus be obtained.—When the construction of the Microscope does not readily admit of the connexion of the Selenite plate with the Polarizing prism, it is convenient to make use of a plate of brass (Fig. 68) somewhat larger than the glass slides in which objects are ordinarily mounted, with

FIG. 68.

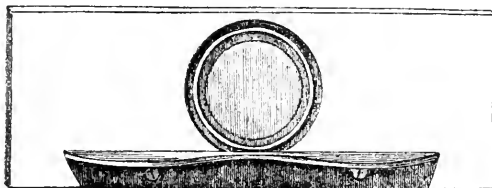

Selenite Object-carrier.

a ledge near one edge for the slide to rest against, and a large circular aperture into which a glass is fitted, having a film of selenite cemented to it ; this 'Selenite Stage,' or object-carrier, being laid upon the Stage of the microscope, the slide containing the object is placed upon it ; and, by an ingenious modification contrived by Dr. Leeson, the ring into which the Selenite plate is fitted being made movable, one plate may be substituted for another, whilst rotation may be given to the ring by means of a tangent-screw fitted into the brass-plate.*

90. *Illuminators for Opaque Objects.*—All objects through which sufficient light cannot be transmitted to enable them to be viewed in the modes already described, require to be illuminated by rays, which, being thrown upon the surface under examination, shall be

* An improvement on the ordinary Selenite Object-carrier, enabling the Selenite plates to be changed without disturbing the object, has been described by Mr. James Smith in "Quart. Journ. of Microsc. Science," Vol. viii. (1860), p. 203 ; and he has more recently added a very simple arrangement, by which rotation may be given to the object, whilst the polarizing prism and selenite remain stationary (See "Transact. of Microsc. Soc." Ser. 2, Vol. xiv. p. 101).—For an account of the nature and properties of Polarized Light, which would be out of place in the present treatise, see the chapters on that subject in Mr. Brooke's "Manual of Natural Philosophy."

reflected from it into the microscope ; and this mode of viewing them may often be advantageously adopted in regard to semi-transparent or even transparent objects, for the sake of the diverse aspects it affords. Among the various methods devised for this purpose, the one most generally adopted consists in the use of a *Condensing Lens* (Fig. 69), either attached to the microscope, or mounted upon a separate stand,

FIG. 69.

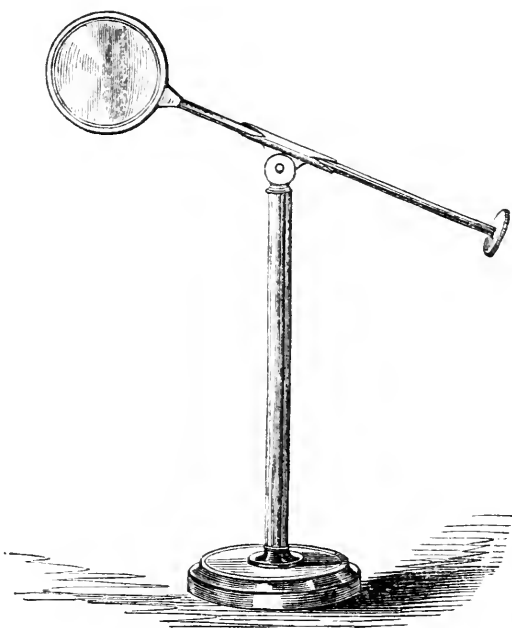

Ordinary Condensing Lens.

in a great variety of positions. The mounting shown in Fig. 70 is one of the best that can be adopted : the frame which carries the lens is borne at the bottom upon a swivel-joint, which allows it to be turned in any azimuth ; whilst it may be inclined at any angle to the horizon, by the revolution of the horizontal tube to which it is attached around the other horizontal tube which projects from the stem ; by the sliding of one of these tubes within the other, again, the horizontal arm may be lengthened or shortened ; the lens may be secured in any position (as its weight is apt to drag it down when it is inclined, unless the tubes be made to work, the one into the other, more stiffly than is convenient) by means of a tightening collar milled at its edges ; and finally the horizontal arm is attached to a sprung socket, which slides up and down upon a vertical stem. The optical effect of such a Lens differs according to the side of it turned towards the light and the condition of the rays which fall

upon it. The position of *least* Spherical Aberration is when its *convex* side is turned towards *parallel* or towards the *least diverging* rays ; consequently, when used by Daylight, its *plane* side should

FIG. 70.

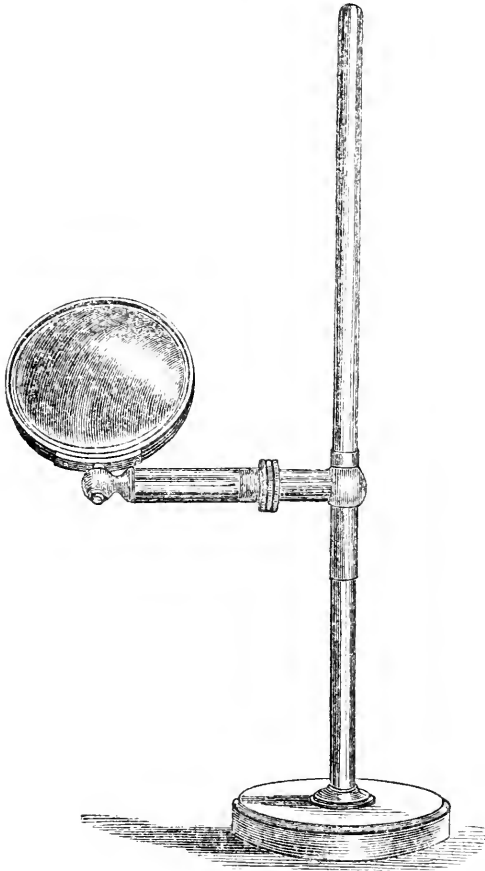

Bull's-Eye Condenser.

be turned towards the *object* ; and the same position should be given to it when it is used for procuring converging rays from a Lamp, the lamp being placed four or five times farther off on one side than the object is on the other. But it may also be employed for the purpose of reducing the diverging rays of the Lamp to parallelism, for use either with the Parabolic illuminator (§ 85), or with the Side Reflector to be presently described ; and the *plane* side is then to be turned towards the Lamp, which must be placed at such a distance from the Condenser that the rays which have passed through the latter shall form a luminous circle equal to it in size, at whatever distance from the lens the screen may be held. For viewing minute objects under high powers, the smaller Condensing Lens may be used to obtain a further concentration of the rays already brought into convergence by the 'Bull's Eye' (§ 123).

91. The Illumination of Opaque objects may be effected by *reflexion* as well as by refraction ; and the most convenient as well as most efficient instrument yet devised for this purpose is the *Parabolic Speculum* of Mr. R. Beck (Fig. 71), which is attached

to a spring-clip that fits upon the Objectives (2 inch, $1\frac{1}{2}$ inch, 1 inch, 2-3rds inch), to which it is especially suited, and is slid up or down or turned round its axis, when the object has been brought into focus, until the most suitable illumination has been obtained. The ordinary rays of diffused Day-light, which may be considered as falling in a parallel direction on the Speculum turned towards the window to receive them, are reflected upon a small object in the focus of the Speculum, so as to illuminate it sufficiently brightly for most purposes ; but a much stronger light may be concentrated on it where the Speculum receives its rays from a Lamp placed near the opposite side of the stage, a Bull's Eye being interposed to give parallelism to the rays.

FIG. 71.

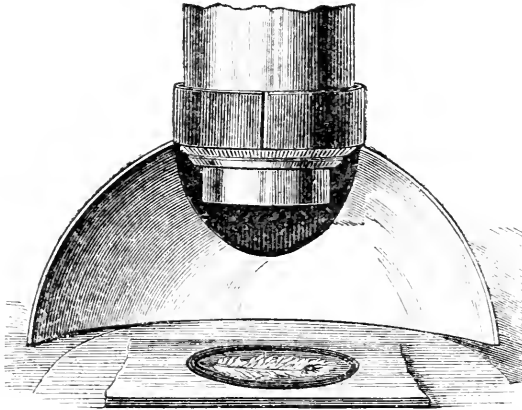

Beck's Parabolic Speculum.

For the sake of Microscopists who may desire to use this admirable instrument with Objectives to which it has not been specially fitted, Mr. Crouch has contrived an Adapter, by which it may be used with any objective of suitable focus. This consists of a collar (Fig. 72, A) which is interposed between the lower end of the body of the Microscope and the Objective ; on this collar is

FIG. 72.

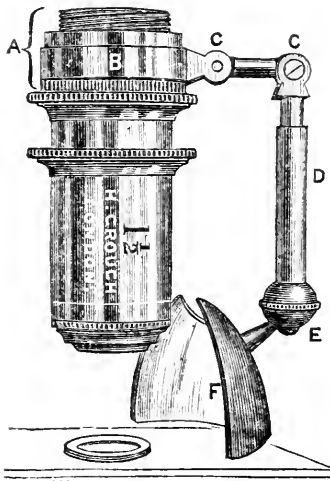

Crouch's Adapter for Parabolic Speculum.

parallelism to the rays. For the sake of Microscopists who may desire to use this admirable instrument with Objectives to which it has not been specially fitted, Mr. Crouch has contrived an Adapter, by which it may be used with any objective of suitable focus. This consists of a collar (Fig. 72, A) which is interposed between the lower end of the body of the Microscope and the Objective ; on this collar is

fitted the ring B, which turns easily round it, and carries the horizontal arm c c, jointed at each end; from this hangs vertically the stem D, which can be lengthened or shortened at pleasure; and to the lower end of this the Speculum F is attached by the ball-and-socket joint E. This arrangement may be used not only with the Objectives already named, but also with those of one-half or 4-10ths inch focus, if these do not approach the object so nearly as to interfere with the reflection of the illuminating rays from the Speculum.

92. *Lieberkühn*.—A mode of illuminating Opaque objects by a small concave Speculum reflecting directly down them upon the light reflected up to it from the Mirror, was formerly much in use, but is now comparatively seldom employed. This concave Speculum, termed a 'Lieberkühn,' from the celebrated Microscopist who invented it, is made to fit upon the end of the Objective, having a perforation in the centre for the passage of the rays from the object to the lens; and in order that it may receive its light from the Mirror beneath (Fig. 73, A), the object must be so mounted as only to stop out the central portion of the rays that are reflected upwards. The curvature of the Speculum is so adapted to the focus of the Object-glass, that, when the latter is duly adjusted, the rays reflected up to it from the mirror shall be made to converge strongly upon the part of the object that is in focus; a separate Speculum is consequently required for every Object-glass. The disadvantages of this mode of illumination are chiefly these:—first, that by sending the light down upon the object almost perpendicularly, there is scarcely any shadow, so that the inequalities of its surface and any minute markings which it may present are but faintly or not at all seen; second, that the size of the object must be limited by that of the Speculum, so as to allow the rays to pass to its marginal portion; and third, that a special mode of mounting is required, to allow the light to be reflected from the mirror around the margin of the object. The first objection may be in some degree removed by turning the Mirror considerably out of the axis, so as to reflect its light obliquely upon the Lieberkühn, which will then send it down obliquely upon the object (Fig. 73, B); or by covering one side of the Lieberkühn by a diaphragm, which should be made capable of rotation, so that light may be reflected from the uncovered portion in every azimuth: the illumination, however, will in neither case be so good as that which is afforded, with powers up to 2-3rds inch, by the Parabolic Speculum just described. The mounting of Opaque objects in wooden slides (Fig. 98), which affords in many cases the most convenient means of preserving them, completely prevents the employment of the Lieberkühn in the examination of them; and they must be set for this purpose either upon disks which afford them no protection, or in cells (Fig. 106) with a blackened back-ground. The cases wherein the Lieberkühn is most useful are those in which it is desired to examine small Opaque objects, such as can be held in the Stage-Forceps (§ 94), or mounted on small disks (§ 95), or laid upon a slip of glass, with Objectives of *half-inch*

focus or less ; since a stronger light can be thus concentrated upon them, than can be easily obtained by side-illumination. In every

FIG. 73.

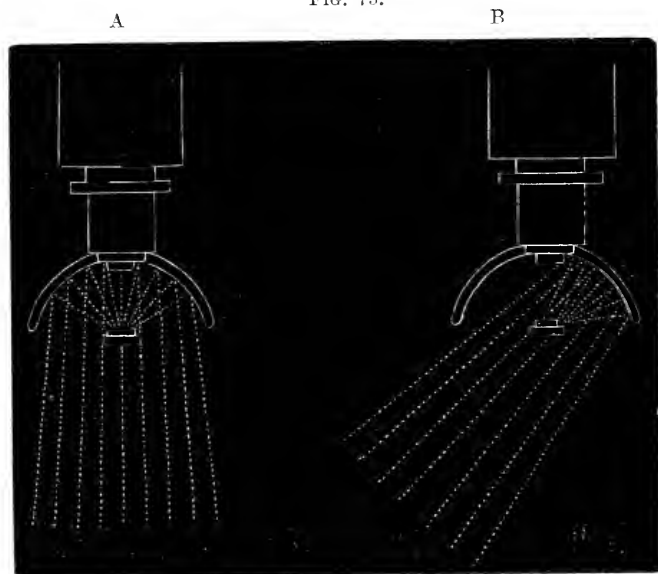

such case a black back-ground must be provided of such a size as to fill the field, so that no light shall come to the eye direct from the Mirror, and yet not large enough to create any unnecessary obstruction to the passage of the rays from the mirror to the speculum. With each Lieberkühn is commonly provided a blackened stop of appropriate size, having a well-like cavity, and mounted upon a pin which fits into a support connected with the under side of the stage ; but though this 'dark well' serves to throw out a few objects with peculiar force, yet, for all ordinary purposes, a spot of black paper or black varnish will answer the required purpose very effectually, this spot being either made on the under side of the cell which contains the object, or upon a separate slip of glass laid upon the stage beneath this.

93. *Beck's Vertical Illuminator.*—Various attempts have been made by Mr. Wenham and other Opticians to view Opaque objects under powers too high for the advantageous use of the Lieberkühn, by employing the Objective itself as the illuminator, light being transmitted into it downwards from above. By Professor Smith, of Kenyon College, U.S., a pencil of light admitted from a lateral aperture above the Objective, is reflected downwards upon the object through its lenses, by means of a small silvered speculum placed on one side of its axis and cutting off a portion of its aperture. By

Messrs. Powell and Lealand a piece of plane glass is placed at an angle of 45° across a tube placed like an Adapter between the Objective and the body of the Microscope ; and whilst a pencil of light, entering at the side aperture and striking against this inclined surface, is reflected by it downwards through the Objective on to the object, the rays proceeding upwards from the object pass upwards (with some loss by reflexion) through the plane glass into the body of the Microscope. For this fixed plate of glass, Mr. R. Beck substituted a disk of thin glass attached to a milled-head (Fig. 74, B), by the rotation of which its angle may be exactly adjusted ; and this is introduced by a slot (shown at *e*, Fig. 74, A) into the interior of an Adapter that is interposed between the Objective (*c, d*) and the nose (*c*) of the Microscope. The light which enters at the lateral aperture (*A, a*), falling upon the oblique surface of the disk (*c, b*), is reflected downwards, and is concentrated by the lenses of the Objective upon the object beneath. There is this advantage in the method of Mr. Beck over that of Messrs. Powell and Lealand, that not only does the former give a power of adjustment which it is very important the Reflector should possess, but also that the natural surface of the thin-glass disk reflects a much larger proportion of the luminous rays impinging upon it, than does any artificially polished plane. In using this Illuminator, the Lamp should be placed at a distance of about 8 inches from the aperture ; and when the proper adjustments have been made, the image of the

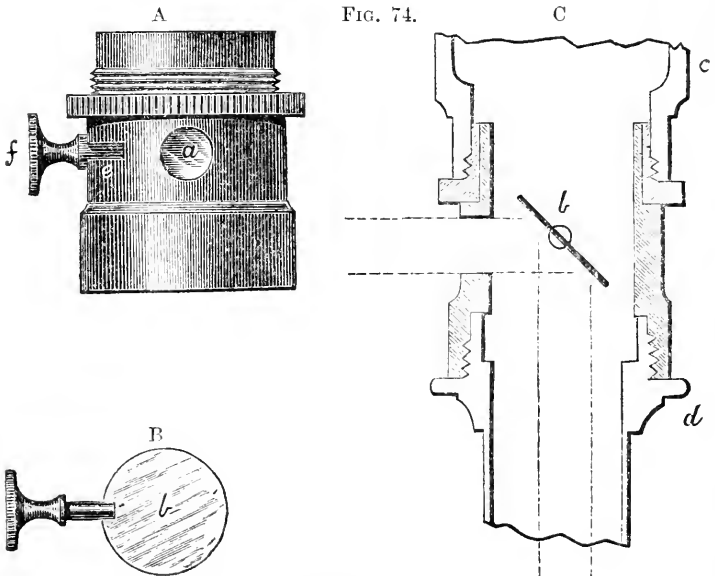

FIG. 74.

Beck's Vertical Illuminator.

flame should be seen upon the object. The Illumination of the entire field, or the direction of the light more or less to either side of it, can easily be managed by the interposition of a small Condensing Lens placed at about the distance of its own focus from the lamp; and slight alterations in its position will produce the effect of the insertion of Diaphragms into the side aperture. The Objects viewed by this mode of illumination must be uncovered; since if they are covered with thin glass, so large a portion of the light sent down upon them is reflected from the cover (especially when Objectives of large angle of aperture are employed) that very little is seen of the objects beneath. It is specially applicable to Diatoms, Polycystina, minute Foraminifera, and the Scales of Lepidopterous and other Insects, viewed under Objectives of from 4-10ths to 1-5th or 1-6th of an inch; and it often makes them present appearances that would not in the least be suspected from their ordinary aspect, when viewed as Transparent objects mounted in Canada Balsam.

Section 2. *Apparatus for the Presentation of Objects.*

94. *Stage-Forceps.*—For bringing under the Object-glass in different positions such small Opaque objects as can be conveniently

FIG. 75.

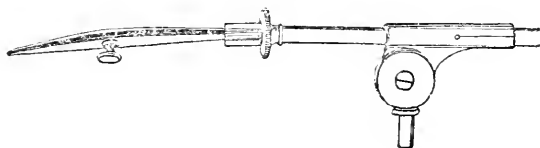

Stage-Forceps.

held in a pair of forceps, the *Stage-Forceps* (Fig. 75) supplied with most Microscopes afford a ready means. These are mounted by means of a joint upon a pin, which fits into a hole either in the corner of the Stage itself or in the Object-platform; the object is inserted by pressing the pin that projects from one of the blades, whereby it is separated from the other; and the blades close again by their own elasticity, so as to retain the object when the pressure is withdrawn. By sliding the wire stem which bears the Forceps through its socket, and by moving that socket vertically upon its joint, and the joint horizontally upon the pin, the object may be brought into the field precisely in the position required; and it may be turned round and round, so that all sides of it may be examined, by simply giving a twisting movement to the wire stem. The other extremity of the stem often bears a small brass box filled with cork, and perforated with holes in its side; this affords a secure hold to common pins, to the heads of which small objects can be attached

by gum, or to which disks of card, &c., may be attached, whereon objects are mounted for being viewed with the Lieberkühn (§ 92). This method of mounting was formerly much in vogue, but has been less employed of late, since the Lieberkühn has fallen into comparative disuse.

95. For the examination of Objects which cannot be con-

FIG. 76.

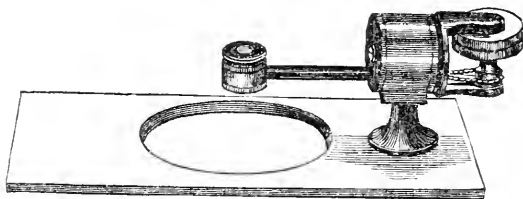

Beck's Disk-Holder.

veniently held in the Stage-forceps, but which can be temporarily or permanently attached to Disks, no means is comparable to the *Disk-Holder* of Mr. R. Beck (Fig. 76) in regard to the facility it affords for presenting them in every variety of position. The Object being attached by gum (having a small quantity of glycerine mixed with it), or by gold-size, to the surface of a small blackened metallic Disk, this is fitted by a short stem projecting from its under surface into a cylindrical holder; and the holder, carrying the disk, can be made to rotate around a vertical axis by turning the milled head on the right, which acts on it by means of a small chain that works through the horizontal tubular stem; whilst it can be made to incline to one side or to the other, until its plane becomes vertical, by turning the whole movement on the horizontal axis of its cylindrical socket.* The supporting plate being perforated by a large aperture, the object may be illuminated by the Lieberkühn if desired. The Disks are inserted into the Holder, or are removed from it, by a pair of Forceps constructed for the purpose; and they may be safely put away by inserting their stems into a plate perforated with holes. Several such plates, with intervening guards to prevent them from coming into too close apposition, may be packed into a small box. To the value of this little piece of apparatus the Author can bear the strongest testimony from his own experience, having found his study of the *Foraminifera* greatly facilitated by it.—A less costly substitute, however, which answers sufficiently well for general purposes, is found in the *Object-Holder* of Mr. Morris (Fig. 77), which consists of a supporting plate that carries a ball-and-socket

* A small pair of Forceps adapted to take up minute objects may be fitted into the cylindrical Holder, in place of a disk, as proposed by Capt. Hutton (See "Quart. Journ. of Microsc. Science," N.S. Vol. vi. p. 61).

joint in its centre, into the ball of which can be fitted by a tapering stem either a holder for small cardboard disks, or a larger holder suitable for carrying an ordinary slide. By the free play of the ball-and-socket joint in different directions, the object may either

FIG. 77.

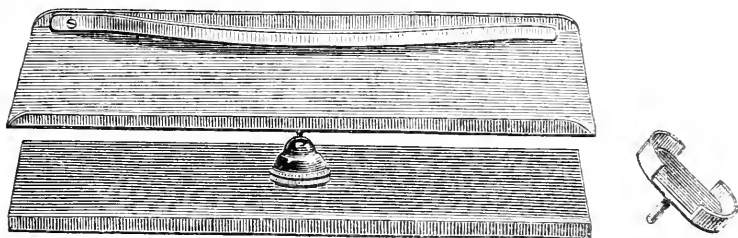

Morris's Object-Holder.

be made to rotate, or may be so tilted as to be viewed obliquely or almost laterally. This instrument can, of course, be used only by side-illumination, and in order to turn it to the best account, the objects to be viewed by it must be mounted on special disks; but it has an advantage over the preceding in being applicable also to objects mounted in ordinary slides.

96. *Glass Stage-Plate*.—Every Microscope should be furnished with a piece of Plate-Glass, about 4 in. by $1\frac{1}{2}$ in., to one margin of which a narrow strip of glass is cemented, so as to form a ledge. This is extremely useful, both for laying objects upon (the ledge preventing them from sliding down when the Microscope is inclined), and for preserving the Stage from injury by the spilling of sea-water or other saline or corrosive liquids, when such are in use. Such a plate not only serves for the examination of transparent, but also of opaque objects; the dark back-ground being furnished by the Diaphragm-plate, and the Condensing-lens being so placed as to throw a side-light upon them.—A small addition may be conveniently made to the glass stage-plate, which adapts it for use as a *Growing-Slide*. A circular aperture of about the diameter of a test-tube is made near one end of the plate (the length of which, for this purpose, had better be not less than 5 inches), and in this is to be fitted a little cup, formed of the end of a test-tube, about three-quarters of an inch deep, in such a manner that its rim shall project a little above the surface of the plate. The cup may be closed by an ordinary cork, or (to avoid danger of splitting it) by a disk of glass cemented to a ring of cork which shall embrace the exterior of the tube; but a small aperture must be left by grinding a notch in the rim of the cup, sufficient to admit the passage of two or three threads of lamp-cotton. The manner in which the 'growing-slide' is used is this:—Supposing we wish to follow the changes undergone by some minute Alga or Infu-

sorium, which we have just detected in a drop of liquid under examination upon an ordinary slip of glass (and covered with thin glass),—we transfer this slip to the 'growing-slide,' fill the cup with distilled water mixed with a small proportion of the water in which the organism was found, and then so arrange the threads (previously moistened with distilled water) that they shall pass from the cup to the edge of the liquid in which the object is contained. Thus, as the water evaporates from beneath the thin glass, the threads will afford a continuous supply; and the threads will not become dry until the whole of the liquid has been absorbed by them and has been dissipated by evaporation. Fresh supplies should of course be introduced into the cup from time to time, as may be needed, so as to prevent any loss of liquid from beneath the thin glass; and in this manner the most important requisite for the continued growth of aquatic organisms,—a constant supply of liquid, without an exclusion of air,—may be secured.*

97. *Aquatic Box or Animalcule Cage.*—This, also, is an appendage with which every Microscope should be provided, so varied and so constant is its utility. It consists of a short piece of wide brass tube, fixed perpendicularly at one end into a flat plate of brass (Fig. 78), which is itself perforated by an aperture equal in diameter to that of the tube, and having its opposite extremity closed by a disk of glass (B, *b*); over this fits a cover,

FIG. 78.

A

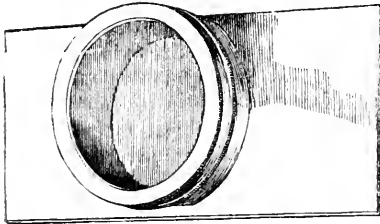

B

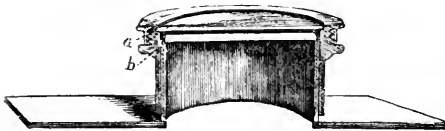

Aquatic Box or Animalcule Cage, as seen in perspective at A, and in section at B.

formed of a piece of tube just large enough to slide rather stiffly upon that which forms the box, closed at the top by another disk of glass (B, *a*). The cover being taken off, a drop of the liquid to be examined, or any thin object which can be most advantageously looked at in fluid, is placed upon the lower plate; the cover is then slipped over it, and is pressed down until the drop of liquid

* For descriptions of other forms of Growing Slide, see "Transact. of Micros. Soc." Vol. xiv. p. 34, and "Quart. Journ. of Micros. Science," N.S. Vol. vii. p. 11.

be spread out, or the object be flattened, to the degree most convenient for observation. If the glass disk which forms the lid be cemented or burnished into the brass ring which carries it, a small hole should be left for the escape of air or superfluous fluid: and this hole may be closed up with a morsel of wax, if it be desired to prevent the included fluid from evaporating. But as it is desirable that this glass should be thin enough to allow a 1-4th inch Objective to be employed for the examination of Animalcules, &c., and as such thin glass is extremely apt to be broken, it is a much better plan to furnish the brass cover with a screw-cap, which holds the glass disk with sufficient firmness, but permits it to be readily replaced when broken: and as the looseness of this fitting gives ample space for the escape of air or fluid around the margin of the disk, no special aperture is needed. It is always desirable, if possible, to prevent the liquid from spreading to the edge of the disk; since any objects it may contain are very apt in such a case to be lost under the opaque ring of the cover; this is to be avoided by limiting the quantity of liquid introduced, by laying it upon the centre of the lower plate, and by pressing down the cover with great caution, so as to flatten the drop equally on all sides, stopping short when it is spreading too close to the margin. With a little practice, this object may in general be successfully attained; but if so much superfluous liquid should have been introduced that it has flooded the circumference of the enclosed space and exuded around the edge of the disk, it is better to wipe the whole perfectly dry and then to introduce a fresh drop, taking more care to limit its quantity and to restrain it within convenient bounds. If the box be well constructed, and the glass disks be flat, they will come into such close contact that objects of extreme thinness may be compressed between them; hence not only may such small animals as Water-fleas (*Entomostraca*) be restrained from the active movements which preclude any careful observation of their structure,—and this without any permanent injury being inflicted upon them,—but much smaller creatures, such as Wheel-animalcules (*Rotifera*), or *Bryozoa*, may be flattened out, so as to display their internal organization more clearly, and even the larger *Infusoria* may be treated in like manner. The working Microscopist will find it of great advantage to possess several of these Aquatic Boxes of different sizes; and one or two of them may have the glass cover of stronger glass than the rest, and firmly fixed in its rim, so that, if the cover be made to slide equably on the box, the instrument (in hands accustomed to careful manipulation) may be made to answer the purpose of a *Compressorium* (§ 99).

98. *Zoophyte Trough*.—For the examination of living Aquatic objects too large to be conveniently received into the Animalcule cage, the Zoophyte trough, contrived by Mr. Lister, may be employed with great advantage. This consists of a trough of the shape

represented in Fig. 79, formed of plates and slips of plate-glass, cemented together by marine glue ; of a loose vertical plate of glass, just so much smaller than the front or back of the inside of the trough as to be able to move freely between its sides ; and of

FIG. 79.

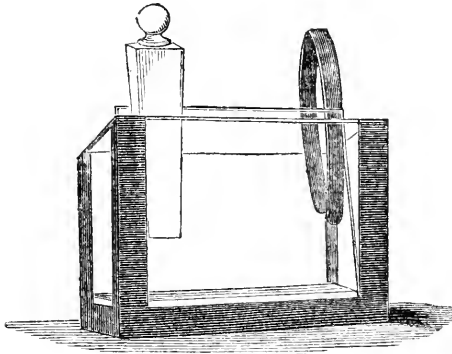

Zoophyte Trough.

a horizontal slip of glass, whose length equals that of the inside-bottom of the trough, but whose breadth is inferior by the thickness of the plate just mentioned. The trough being filled with water (fresh or salt, as the case may be), the horizontal slip is laid at the bottom, and the vertical plate is placed in contact with the front of the trough, its lower

margin, being received into the space left at the front edge of the horizontal slip which serves to hold it there, acting as a kind of hinge ; a small ivory wedge is then inserted between the *front-glass* of the trough and the upper part of the vertical plate, which it serves to press backwards ; but this pressure is kept in check by a little spring of bent whalebone, which is placed between the vertical plate and the *back-glass* of the trough. By moving the ivory wedge up or down, the amount of space left between the upper part of the vertical plate and the front-glass of the trough can be precisely regulated ; and as their lower margins are always in close apposition, it is evident that the one will incline to the other with a constant diminution of the distance between them from above downwards. Hence a Zoophyte, or any similar body, dropped into this space, will descend until it rests against the two surfaces of the glass, and will remain there in a situation extremely convenient for observation ; and the regulating-wedge, by increasing or diminishing the space, serves to determine the level to which the object shall fall.—It is convenient for the working Microscopist to be furnished with several simple *Water-troughs* of different sizes ; and he may easily construct for himself *thin* ones suitable for observing delicate Zoophytes or for growing *Chara* or *Nitella*, in the following manner. A piece of plate-glass of thickness equal to the water-space which it is desired to give, is cut to the size suitable for the trough, and strips are cut from three of its edges ; these strips are cemented with marine glue, in their original relative positions, on a glass plate, so as to form the

bottom and ends of the trough ; and a thin-glass cover being cemented on them, the trough is complete. Small troughs of this kind may be conveniently made from ordinary Glass Slides cut into halves; the three strips being cut from one-half, and the other half, if thin enough, serving as the cover.

99. *Compressorium*.—The purpose of this instrument is to apply a gradual pressure to objects whose structure can only be made out when they are thinned by extension. For such as will bear tolerably rough treatment, a well-constructed Aquatic Box may be made to answer the purpose of a compressor; but there is a very large class whose organization is so delicate as to be confused or altogether destroyed by the slightest excess of pressure; and for the examination of such, an instrument in which the degree of compression can be regulated with precision is almost indispensable. The *Compressorium* in most general use is that represented in Fig. 80, of which the general plan was originally devised by Schiek

Fig. 80.

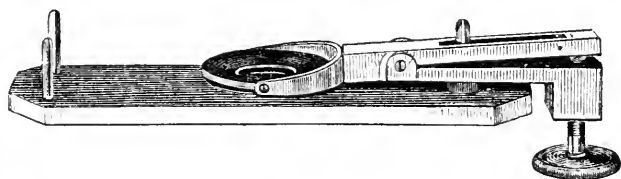

Compressorium.

of Berlin, whilst its details have been modified by M. de Quatrefages, who has constantly employed this instrument in his elaborate and most successful researches on the organization of the Marine Worms. It consists of a plate of brass between 3 and 4 inches long, and from $1\frac{1}{4}$ to $1\frac{1}{2}$ inches broad, having a central aperture of from $\frac{1}{2}$ to $\frac{3}{4}$ of an inch. This central aperture is covered on its upper side by a disk of thin glass, which may be cemented to the brass plate by Canada balsam; and the under side of it is bevelled away, so that the thickness of the edge shall not interfere with the approach of the objective to its margin, when that side is made the uppermost. Near one extremity of the plate is a strong vertical pin, that gives support to a horizontal bar which turns on it as on a swivel; through the end of this bar that projects beyond the plate, there passes a screw with a milled-head; and at the other end is jointed a second bar, against one end of which the screw bears, whilst the other carries a frame holding a second disk of thin glass. This frame is a small circular plate of brass, having an aperture equal in size to that of the large plate; to its under side, which is flat, a disk of thin glass is cemented by Canada

balsam, while its upper side is bevelled off as it approaches the opening, for the purpose just now specified; and by being swung between pivots in a semicircle of brass, which is itself pivoted to the movable arm, it is made capable of a limited movement in any direction. The upper disk, with the apparatus which supports it, having been completely turned aside around the swivel-joint, the object to be compressed is laid upon the lower disk; the upper disk is then turned back so as to lie precisely over it, and by the action of the milled-head screw is gradually approximated to the lower, to which the pivot-movements of its frame allow it to take up a parallel position, whatever may be the inclination of the bar.—As it is frequently of great importance to be able to look at either side of the object under compression, the principal plate is provided with two pins at the extremity farthest from the milled-head, which, being exactly equal in length to the swivel-pin, afford with it a support to the instrument, when it is so turned that the side represented as undermost in the figure shall be uppermost; and it is in order that high powers may be used in this case as in the other, that the disk which then covers the object is made of

FIG. 81.

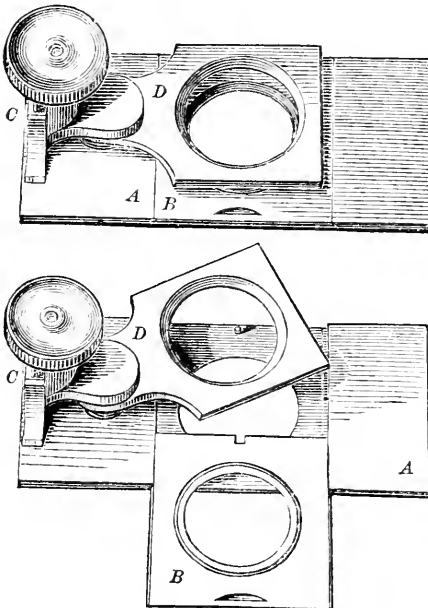

Ross's Improved Compressorium.

thin glass, instead of being (as in the original form of the instrument) a piece of thick glass plate. Either disk may be replaced with extreme facility, if broken, by simply warming the part of the instrument to which it is attached, so as to loosen the cement that holds it. Some observers prefer a modification of this instrument, in which the brass plate is made to carry an ordinary Glass Slide, on which the object may be prepared under the Dissecting Microscope before being subjected to compression. By transferring it to the Compressorium on the slide on which it has been dissected, we avoid

disturbing the object, but sacrifice the advantage of being able to look at it through thin glass from the under side.—The

chief defect in this apparatus consists in the absence of any provision for securing the parallelism of the approximated surfaces. Such a provision is made in the improved Compressorium of Mr. Ross, shown in Fig. 81, in which the upper plate D is attached to a slide that works between grooves in the vertical piece C, so that when raised or lowered by the milled-head it always maintains its parallelism to the lower plate A. The thin glass carried by the upper plate D (which can be turned aside on a swivel-joint, as shown

FIG. 82.



Dipping-tubes.

in the lower figure) is a square that slides into grooves on its under side, so as to be easily replaced if broken. The glass to which it is opposed is a circular disk lodged in a shallow socket in plate B, which is received into a part of the lower plate A that is sunk below the rest. The plate B carrying the lower glass can be drawn out (as shown in the lower figure) and laid upon the Dissecting Microscope, and can then be replaced in the Compressorium after the object has been prepared for compression.

100. *Dipping-tubes*.—In every operation in which small quantities of liquid, or small objects contained in liquid, have to be dealt with by the Microscopist, he will find it a very great convenience to be provided with a set of Tubes of the forms represented in Fig. 82, but of somewhat larger dimensions. These were formerly designated as ‘fishing-tubes;’ the purpose for which they were originally devised having been the fishing-out of Water-fleas, aquatic Insect Larvæ, the larger Animalcules, or other living objects distinguishable either by the unaided eye or by the assistance of a magnifying-glass, from the vessels that may contain them. But they are equally applicable, of course, to the selection of minute Plants; and they may be turned to many other no less useful purposes, some of which will be specified hereafter. When it is desired to secure an object which can be seen either with the eye alone or with a magnifying-glass, one of these tubes is passed down into the liquid, its upper orifice having been previously closed by the forefinger, until its lower orifice is immediately above the object; the finger being then removed, the liquid suddenly rises into the tube, probably carrying the object up with it; and if this is seen to be the case, by putting the finger again on the top of the tube,

its contents remain in it when the tube is lifted out, and may be deposited on a slip of glass or on the lower disk of the Aquatic Box, or, if too copious for either receptacle, may be discharged into a large glass cell (Fig. 106). In thus fishing for any but the minutest objects, it will be generally found convenient to employ the open-mouthed tube *c*; and when its contents have been discharged, if they include but a single object of the desired kind, this may be taken up by one of the finer tubes, *A*, *B*, or, if more convenient, the whole superfluous fluid may be sucked up by the mouth, and the object left with no more than is suitable; or, if there be many of the objects in the fluid first selected, these may be taken up from it, one by one, by either of the finer tubes.

101. *Glass Syringe*.—In dealing with minute Aquatic objects, great advantage will be found in the use of a small Glass Syringe of the pattern represented in Fig. 83, and of about double the dimensions. When this is firmly held between the fore and

FIG. 83.

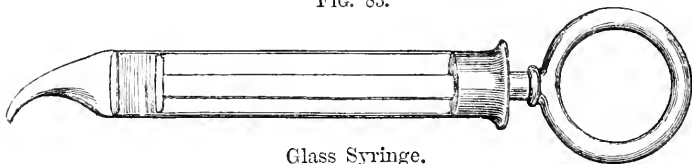

Glass Syringe.

middle fingers, and the thumb is inserted into the ring at the summit of the piston-rod, such complete command is gained over the piston that its motion may be regulated with the greatest nicety; and thus minute quantities of fluid may be removed or added, or any minute object may be selected (by the aid of the simple Microscope, if necessary) from amongst a number in the same drop, and transferred to a separate slip. A set of such Syringes, with points drawn to different degrees of fineness, and bent to different curvatures, will be found to be among the most useful 'tools' that the working Microscopist can have at his command, as they are capable of a great number of applications, several of which will be particularized hereafter.

102. *Forceps*.—Another instrument so indispensable to the Microscopist as to be commonly considered an appendage to the

FIG. 84.

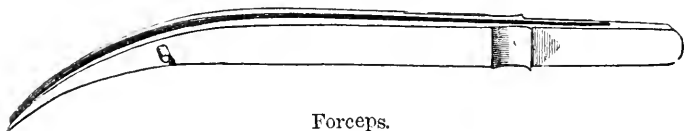

Forceps.

Microscope, is the Forceps for taking up minute objects; many forms of this have been devised, of which one of the most con-

venient is represented in Fig. 84 of something less than the actual size. As the forceps, in marine researches, have continually to be plunged into sea-water, it is better that they should be made of brass or of German silver, than of steel, since the latter rusts far more readily; and as they are not intended (like Dissecting-forceps) to take a firm grasp of the object, but merely to hold it, they may be made very light, and their spring-portion slender. As it is essential, however, to their utility, that their points should meet accurately, it is well that one of the blades should be furnished with a guide-pin passing through a hole in the other.

The foregoing constitute, it is believed, all the most important pieces of Apparatus which can be considered in the light of Accessories to the Microscope. Those which have been contrived to afford facilities for the preparation and mounting of Objects, will be described in a future chapter (Chap. v.). It may be thought that some notice ought to be taken of the *Frog-Plate* and *Fish-Pan*, with the former of which many Microscopes are supplied, whilst the latter has scarcely yet gone altogether out of use. But the Author, having been accustomed to gain all the advantages of these by methods far more simple, whilst at least equally efficacious, does not consider them as presenting any advantages which render it desirable to expend time or space in giving a detailed account of them; and he will explain the methods alluded to under the appropriate head (Chap. XVIII., *Circulation of the Blood*).

CHAPTER IV.

MANAGEMENT OF THE MICROSCOPE.

103. *Table.*—The Table on which the Microscope is placed when in use, should be one whose size enables it also to receive the various appurtenances which the observer finds it convenient to have within his reach, and whose steadiness is such as to allow of his arms being rested upon it without any yielding; it should, moreover, be so framed, as to be as free as possible from any tendency to transmit the vibrations of the building or floor whereon it stands. The working Microscopist will find it a matter of great convenience to have a Table specially set apart for his use, furnished with drawers, in which are contained the various Accessories he may require for the preparation and mounting of objects. If he should desire to carry about with him all the apparatus he may require for the prosecution of his investigations in different localities, and for the mounting of his preparations on the spot, he will find it very convenient to provide himself with a small Cabinet, fitted with drawers, in which every requisite can be securely packed, and of such a height that, when laid upon an ordinary table, it may bring up the Quekett Dissecting Microscope (Fig. 29) placed upon it to the position most convenient for use.*—If the Microscope be one which is not very readily taken out from and put back into its case, it is very convenient to cover it with a large bell-glass; which may be so suspended from the ceiling, by a cord carrying a counterpoise at its other end, as to be raised or lowered with the least possible trouble, and to be entirely out of

* The dimensions of the Cabinet which the Author has had constructed for himself (its size being so adapted to that of the box of his Crouch's Binoocular that the two are received into the same travelling-case) are 14 inches long, 7 inches broad, and $4\frac{1}{2}$ inches high. In the middle there are five shallow drawers, 5 inches broad, containing dissecting apparatus, large flat cells, glass-covers, syringes, &c.; on one side are two drawers, each $3\frac{1}{2}$ inches broad, the upper one, containing slides, cells, &c., rather more than one inch deep inside, the lower, for larger pieces of apparatus, 2 inches deep; on the other side is a single drawer of the same breadth and $3\frac{1}{4}$ inches deep, for bottles containing solutions, cements, &c.

the way when the Microscope is in use. Similar but smaller bell-glasses (wine-glasses whose stems have been broken answer very well) are also useful for the protection of objects which are in course of being examined or prepared, and which it is desirable to seclude from dust.—For the purpose of Demonstration in the Lecture Room, a small traversing Platform may be constructed to run easily upon rollers, and to carry the Microscope and Lamp securely clamped down upon it, so as to be passed from one observer to another. For Demonstration to a small party sitting round a circular table, it is convenient to employ a Λ -shaped platform, the vertical angle of which is pivoted to a weight placed in the centre of the table, whilst the angles at the base are supported upon castors, so that the platform may run round to each observer in succession. Or the table itself, if not too large, may be made to rotate (like a dumb-waiter) upon its central pillar.

104. *Light*.—Whatever may be the purposes to which the Microscope is applied, it is a matter of the first importance to secure a pure and adequate Illumination. For the examination of the greater proportion of objects, *good daylight* is to be preferred to any other kind of light; but *good lamplight* is preferable to bad daylight. When Daylight is employed, the Microscope should be placed near a window, whose aspect should be (as nearly as may be convenient) *opposite* to the side on which the sun is shining; for the light of the sun reflected from a bright cloud is that which the experienced Microscopist will almost always prefer, the rays proceeding from a cloudless blue sky being by no means so well fitted for his purpose, and the dull lurid reflection of a dark cloud being the worst of all. The *direct* rays of the sun are far too powerful to be used with advantage, unless its intensity be moderated, either by reflection from a plaster-of-Paris or some other 'white-cloud' mirror (§ 87), or by passage through some medium which stops a greater or less proportion of its rays. This may be done by placing coloured glasses over the eye-pieces, as recommended by Mr. Wenham; or by placing the 'moderator' specially contrived by Mr. Rainey for lamp or gaslight illumination (§ 105) between the window and the mirror. The young Microscopist is earnestly recommended to make as much use of *daylight* as possible; not only because, in a large number of cases the view of the object which it affords is more satisfactory than that which can be obtained by any kind of lamplight, but also because it is much less trying to the eyes. So great, indeed, is the difference between the two in this respect, that there are many who find themselves unable to carry on their observations for any length of time by Lamplight, although they experience neither fatigue nor strain from many hours continuous work by Daylight.

105. When recourse is had to Artificial light, it is of great importance, not only that it should be of good quality, but that the arrangement for furnishing it should be suitable to the special

wants of the Microscopist. Thus, although a wax or composition Candle affords a very pure light, yet its use is attended with two inconveniences, which render it very unsuitable when any better light can be obtained:—namely, the constant flickering of the flame, which is not sufficiently prevented by surrounding it with a chimney; and the continual alteration in its level, which is occasioned by the consumption of the candle. The most useful light for ordinary use is that furnished by the steady and constant flame of a Lamp, fed either with Oil, Camphine, Paraffine (of its best varieties) or Gas; it should be capable of adjustment to any height above the table; and a movable shade should be provided, by which the light may be prevented from coming direct to the observer's eyes, or from diffusing itself too widely through the room. These requisites are supplied by the Lamp commonly known as the 'University' or 'reading' lamp, which has a circular foot with a vertical stem, on which the oil-reservoir (carrying with it the burner) and the shade can be fixed at any convenient height. French and German lamps, on the same general construction, but having the reservoir contrived on the 'bird-fountain' principle, are also to be obtained, being largely imported for the use of watch-makers; these have the advantage of burning out all their oil, which is not the case with the ordinary 'reading' lamp, as it does not burn well except when full, or nearly so; and they are now made with shades, well suited to the wants of the Microscopist.* Lamps of either kind are sometimes constructed on the 'solar' principle, which increases the purity and intensity of the light, but at the same time not only diminishes the diameter of the flame, but also produces an inconvenient transverse 'break' near its lower part. Small Camphine lamps are now constructed for the special use of Microscopists, which are capable of being placed on an adjustable stand, so that their flame may be raised or lowered to any desired level. The light of this lamp is whiter and more intense than that of any other, and it may be used with advantage for certain very delicate observations (§ 87); but for the ordinary purposes of the Microscopist it is not so convenient, the surface of flame from which the light can be received by the mirror or condenser being limited by the peculiar construction which the combustion of camphine requires. The Paraffine or Belmontine lamps, which have latterly come into such general use, have many advantages for the Microscopist; and are probably, on the whole, when constructed with express reference to his requirements, the most convenient lamps he can employ. The Author can strongly recommend, from his own experience of its use, the form known as the Bockett Lamp (Fig. 85), manufactured by Mr. Collins. This is attached by a transverse arm to a tubular slide, which moves up and down upon the stem that rises from the foot, and can be fixed by a milled-head; and this slide also carries the Con-

* A very excellent Lamp of this kind is sold by Mr. Pillischer.

denser, which is thus raised or lowered with the lamp itself, far more conveniently than when mounted on a separate foot. The flat wick may be so turned as to present to the mirror or condenser either its whole breadth, or only its edge, or any intermediate aspect; the light in the second case being much increased in intensity, but restricted to a smaller surface.—To every one who has a supply of Gas at command, the use of it for his Microscope-lamp (by means of a flexible tube) strongly recommends itself, on account of its extreme convenience, and its freedom from any kind of trouble. The lamp should be constructed on the general plan already described, the burner being made to slide up and down on a stem rising perpendicularly from a foot, which also carries a shade; and the burner should be one which affords a bright and steady cylindrical flame, either 'Leslie's' or the 'cone' burner being probably the best. Even the best light supplied by a Gas-lamp, however, is inferior in quality to that of a good Oil-lamp; and is more injurious and unpleasant to the eye. Hence the

interposition of some kind of artificial medium adapted to keep back the yellow rays, whose predominance in the lamp-flame is the chief source of its injurious action, is especially required when Gaslight is used. This may be partly effected by the simple expedient of using a chimney of bluish glass, known as 'Leblond's'; but, in addition, it is advantageous to cause the light to pass through a screen of bluish-black or neutral-tint glass; and it will then be nearly purified as to quality, though much reduced in intensity.* Mr. Rainey, who has paid great attention to the best means of obtaining a good illumination by artificial light, recommends, as the best *moderator*, one piece of dark-blue glass free from any tint of red, another of very pale-blue with a slight shade of green, and two of thick white plate-glass, all cemented together with Canada balsam; this, as already stated, may be used with Sunlight, as well as with Lamplight.

106. *Position of the Light.*—When the Microscope is used by Daylight, it will usually be found most convenient to place it in

* A Gas-lamp provided with these and other appurtenances for regulating the illumination, and also with a water-bath and mounting-plate, has been devised by Mr. S. Highley.

FIG. 85.

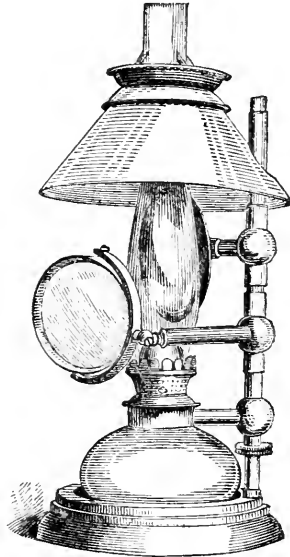

Bockett Lamp.

such a manner that the light shall be at the left hand of the observer. It is most important that no light should enter his eye, save that which comes to it through the Microscope; and the access of direct light can scarcely be avoided, when he sits with his face to the light. Of the two sides, it is more convenient to have the light on the *left*; first, because it is not interfered with by the right hand, when this is employed in giving the requisite direction to the mirror, or in adjusting the illuminating apparatus; and secondly, because, as most persons in using a Monocular Microscope employ the right eye rather than the left, the projection of the nose serves to cut off those lateral rays which, when the light comes from the right side, glance between the eye and the eye-piece. The *side-shades* fitted by Mr. Collins to the eye-pieces of his Harley Binocular (Fig. 39) may be advantageously employed with every instrument of that class.—When Artificial light is employed, the same general precautions should be taken. The Lamp should always be placed on the left side, unless the use of the mirror be dispensed with, or some special reason exist for placing it otherwise. If the object under examination be transparent, the lamp should be placed at a distance from the eye about midway between that of the stage and that of the mirror; if, on the other hand, the object be opaque, it should be at a distance about midway between the eye and the stage; so that its light may fall, in the one case upon the Mirror, in the other case upon the Stage, at an angle of about 45° with the axis of the Microscope. The passage of direct rays from the flame to the eye should be guarded against by the interposition of the lamp-shade; and no more light should be diffused through the apartment than is absolutely necessary for other purposes. If observations of a very delicate nature are being made, it is desirable, alike by Daylight and by Lamplight, to exclude all lateral rays from the eye as completely as possible; and this may be readily accomplished by means of a shade made like the upper part of a mask, and lined with black cloth or velvet, which should be fixed on the ocular end of the Microscope.

107. *Care of the Eyes.*—Although most Microscopists who habitually work with the Monocular Microscope acquire a habit of employing only *one* eye (generally the right), yet it will be decidedly advantageous to the beginner that he should learn to use either eye indifferently; since by employing and resting each alternately, he may work much longer, without incurring unpleasant or injurious fatigue, than when he always employs the same.—Whether or not he do this, he will find it of great importance to acquire the habit of *keeping open the unemployed eye*. This, to such as are unaccustomed to it, seems at first very embarrassing, on account of the interference with the microscopic image which is occasioned by the picture of surrounding objects formed upon the retina of the second eye; but the habit of restricting the attention to that impression only which is received through the microscopic eye may generally

be soon acquired; and when it has once been formed, all difficulty ceases. Those who find it unusually difficult to acquire this habit, may do well to learn it in the first instance with the assistance of the shade just described; the employment of which will permit the second eye to be kept open without any confusion.—So much advantage, however, is derived from the use of the Binocular Microscope, even with objects not requiring its stereoscopic effect, that the Author would strongly recommend its use to every observer who wishes to take advantage of the *best* means of avoiding injury to his sight.—There can be no doubt that the habitual use of the Microscope for many hours together, especially by lamplight, and with high magnifying powers, has a great tendency to injure the sight. Every Microscopist who thus occupies himself, therefore, will do well, as he values his Eyes, not merely to adopt the various precautionary measures already specified, but rigorously to keep to the simple rule of *not continuing to observe any longer than he can do so without fatigue.**

108. *Care of the Microscope.*—Before the Microscope is brought into use, the cleanliness and dryness of its glasses ought to be ascertained. If dust or moisture should have settled on the Mirror, this can be readily wiped off. If any spots should show themselves on the field of view when it is illuminated by the mirror, these are probably due to particles adherent to one of the lenses of the Eye-piece; and this may be determined by turning the eye-piece round, which will cause the spots also to rotate, if their source lies in it. It may very probably be sufficient to wipe the upper surface of the eye-glass (by removing its cap), and the lower surface of the field-glass; but if, after this has been done, the spots should still present themselves, it will be necessary to unscrew the lenses from their sockets, and to wipe their inner surfaces; taking care to screw them firmly into their places again, and not to confuse the lenses of different eye-pieces. Sometimes the eye-glass is obscured by dust of extreme fineness, which may be carried off by a smart puff of breath; the vapour which then remains upon the surface being readily dissipated by rapidly moving the glass backwards and forwards a few times through the air. And it is always desirable to try this plan in the first instance; since, however soft the substance with which the glasses are wiped, their polish is impaired in

* The Author attributes to his rigorous observance of the above rule his entire freedom from any injurious affection of his visual organs, notwithstanding that of the whole amount of Microscopic study which he has prosecuted for thirty years past, a large proportion has been necessarily carried on by Artificial light, most of his diurnal hours being occupied in other ways. He has found the length of time during which he can "microscopize" without the sense of fatigue, to vary greatly at different periods; half-an-hour's work being sometimes sufficient to induce it, whilst on other occasions none has been left by three or four hours' almost continuous use of the instrument,—his power of visual endurance being usually in relation to the vigour of his general system.

the end by the too frequent repetition of the process. The best material for wiping glass is a piece of soft wash-leather, from which the dust it generally contains has been well beaten out.—If the Object-glasses be carefully handled, and kept in their boxes when not in use, they will not be likely to require cleansing. One of the chief dangers, however, to which they are liable in the hands of an inexperienced Microscopist, arises from the neglect of precaution in using them with fluids: which, when allowed to come in contact with the surface of the outer glass, should be wiped off as soon as possible. In screwing and unscrewing them, great care should be taken to keep the glasses at a distance from the surface of the hands; since they are liable not only to be soiled by actual contact, but to be dimmed by the vaporous exhalation from skin which they do not touch. This dimness will be best dissipated by moving the glass quickly through the air. It will sometimes be found, on holding an Object-glass to the light, that particles either of ordinary dust, or more often of the black coating of the interior of the Microscope, have settled upon the surface of its back-lens; these are best removed by a clean and dry camel-hair pencil. If any cloudiness or dust should still present itself in an object-glass, after its front and back surfaces have been carefully cleansed, it should be sent to the maker (if it be of English manufacture) to be taken to pieces, as the amateur will seldom succeed in doing this without injury to the work; the foreign combinations, however, being usually put together in a simpler manner, may be readily unscrewed, cleansed, and screwed together again. Not unfrequently an objective is rendered dim by the cracking of the cement by which the lenses are united, or by the insinuation of moisture between them; this last defect occasionally arises from a fault in the quality of the glass, which is technically said to 'sweat.' In neither of these cases has the Microscopist any resource, save in an Optician experienced in this kind of work; since his own attempts to remedy the defect are pretty sure to be attended with more injury than benefit.

109. *General Arrangement of the Microscope for Use.*—The inclined position of the instrument, already so frequently referred to, is that in which observation by it may be so much more advantageously carried on than it can be in any other, that this should always be had recourse to unless particular circumstances render it unsuitable. The precise inclination that may prove to be most convenient, will depend upon the 'build' of the Microscope, upon the height of the Observer's seat as compared with that of the table on which the instrument rests, and lastly, upon the sitting height of the individual; and it must be determined in each case by his own experience of what suits him best,—that which he finds *most comfortable* being that in which he will be able not only to work the longest, but to see most distinctly.—The selection of the Object-glasses and Eye-pieces to be employed must be entirely

determined by the character of the object. Large objects presenting no minute structural features should always be examined in the first instance by the *lowest* powers, whereby a general view of their nature is obtained; and since, with lenses of comparatively long focus and small angle of aperture, the precision of the focal adjustment is not of so much consequence as it is with the higher powers, not only those parts can be seen which are exactly in focus, but those also can be tolerably well distinguished which are not precisely in that plane, but are a little nearer or more remote. When the general aspect of an object has been sufficiently examined through low powers, its details may be scrutinized under a higher amplification; and this will be required in the first instance, if the object be so minute that little or nothing can be made out respecting it save when a very enlarged image is formed. The power needed in each particular case can only be learned by experience; that which is most suitable for the several classes of objects hereafter to be described will be specified under each head. In the general examination of the larger class of objects, the range of power that is afforded by the Erector in combination with the Draw-tube (§§ 63, 64) will often be found useful; whilst for the ready exchange of a low power for a higher one, great convenience is afforded by the Nose-piece (§ 73).

110. When the Microscopist wishes to augment his magnifying power, he has a choice between the employment of an Objective of shorter focus and the use of a deeper Eye-piece. If he possess a complete series of Objectives, he will generally find it best to substitute one of these for another without changing the Eye-piece for a deeper one; but if his 'powers' be separated by wide intervals, he will be able to break the abruptness of the increase in amplification which they produce, by using each Objective first with the shallower and then with the deeper Eye-piece. Thus if a Microscope be only provided with two Objectives, of 1 inch and 1-4th inch focus respectively, and with two Eye-pieces, one nearly double the power of the other, such a range as the following may be obtained,—60, 90, 240, 360 diameters; or, with two Objectives of somewhat shorter focus, and with deeper Eye-pieces (as in some French and German instruments),—88, 176, 350, 700 diameters. In the examination of large Opaque objects having uneven surfaces, it is generally preferable to increase the power by the Eye-piece rather than by the Objective; thus a more satisfactory view of such objects may usually be obtained with a 3-inch or 2-inch Objective and the B Eye-piece, than with a 1½-inch or 1-inch Objective and the A Eye-piece. The reason of this is, that in virtue of their smaller Angle of Aperture, the Objectives first named have a much greater amount of 'penetrating power' or 'focal depth' than the latter (§ 131, 1.); and that in the case just specified this quality is of the first importance. The use of the Draw-tube (§ 63) enables the Microscopist still further to vary the mag-

nifying power of his instrument, and thus to obtain almost any exact number of diameters he may desire, within the limits to which he is restricted by the focal length of his Objectives. The advantage to be derived, however, either from 'deep Eye-piecing' or from the use of the Draw-tube, will mainly depend upon the quality of the Object-glass. For, if it be imperfectly corrected, its errors are so much exaggerated that more is lost in definition than is gained in amplification; whilst, if its aperture be small, the loss of light is an equally serious drawback. On the other hand, an Objective of perfect correction and adequate angle of aperture will sustain this treatment with so little impairment in the perfection of its image, that a magnifying power may be obtained by its use, such as, with an inferior instrument, can only be derived from an Objective of much shorter focus combined with a shallow Eye-piece. In making any such comparisons, it must be constantly borne in mind that the real question is, *what can be seen?* It is always desirable for the purposes of research to employ the *lowest* power with which the details of structure can be clearly made out; since, the lower the power, the less is the liability to error from false appearances, and the better can the mutual relations of the different parts of the object be appreciated. Hence, in testing the optical quality of a Microscope, the first question should be, not what is its *greatest* magnifying power, but, what is the *least* magnifying power under which it will show objects of a given degree of difficulty.

111. In making the *Focal Adjustment*, when low powers are used, it will scarcely be necessary to employ any but the *coarse adjustment*, or 'quick motion;' provided that the rack be well cut, the pinion work in it smoothly and easily, without either 'spring,' 'loss of time,' or 'twist,' and the milled-head be large enough to give the requisite leverage. All these are requisites which should be found in every well-constructed instrument; and its possession of them should be tested, like its freedom from vibration, by the use of high powers, since a really good coarse adjustment should enable the observer to 'focus' an Objective of 1-8th inch with precision. What is meant by 'spring' is the alteration which may often be observed to take place on the withdrawal of the hand; the object which has been brought precisely into focus, and which so remains as long as the milled-head is between the fingers, becoming indistinct when the milled-head is let go. The source of this fault may lie either in the rack-movement itself, or in the general framing of the instrument, which is so weak as to allow of displacement by the mere weight or pressure of the hand: should the latter be the case, the 'spring' may be in great degree prevented by carefully abstaining from *bearing on* the milled-head, which should be simply *rotated* between the fingers. By 'loss of time' is meant the want of sufficient readiness in the action of the pinion upon the rack, so that the milled-head may be

moved a little in either direction without affecting the body; thus occasioning a great diminution in the sensitiveness of the adjustment. This fault may sometimes be detected in Microscopes of the best original construction, which have gradually worked loose owing to the constancy with which they have been in employment; and it may often be corrected by tightening the screws that bring the pinion to bear against the rack. And by 'twist' it is intended to express that apparent movement of the object across the field, which results from a real displacement of the axis of the body to one side or the other, owing to a want of correct fitting in the working parts. As this last fault depends entirely on bad original workmanship, there is no remedy for it; but it is one which most seriously interferes with the convenient use of the instrument, however excellent may be its optical performance. In the use of the coarse adjustment with an Objective of short focus, extreme care is necessary to avoid bringing it down upon the object, to the injury of one or both; for although the spring with which the tube for the reception of the object-glass is furnished, whenever the Fine Adjustment is immediately applied to this, takes off the violence of the crushing action, yet such an action, even when thus moderated, can scarcely fail to damage or disturb the object, and *may* do great mischief to the lenses. Where no such spring-tube is furnished, the fine adjustment being otherwise provided for, or being not supplied at all, still greater care is of course required. It is here, perhaps, well to notice, for the guidance of the young Microscopist, that the *actual* distance between the Object-glass and the object, when a distinct image is formed, is always considerably less than the *nominal* focal length of the object-glass: thus, the distance of the 1 inch or 2-3rds inch object-glass may be little more than half an inch: that of the 4-10ths inch may be but little more than one-tenth of an inch; that of a 1-4th or a 1-5th inch may scarcely exceed one-twentieth; that of a 1-8th inch may not be one-fortieth; and that of a 1-12th or a 1-16th inch may be so close as not to admit the intervention of a piece of glass more than one-hundredth of an inch thick. One more precaution it may be well to specify; namely, that either in changing one object for another, or in substituting one Objective for another—save when powers of such focal length are employed as to remove all likelihood of injury—the Body should be turned to one side, where the construction of the Microscope admits of this displacement, or (where it does not) should have its distance from the Stage increased by the 'coarse adjustment.' This precaution is absolutely necessary when Objectives of short focus are in use, to avoid injury either to the lenses or to the object; and when it is habitually practised with regard to these, it becomes so much like an 'acquired instinct,' as to be almost invariably practised in other cases.

112. In obtaining an exact Focal Adjustment with Object-glasses

of less than half-an-inch focus, it will be generally found convenient to employ the *fine adjustment* or 'slow motion ;' and as recourse will frequently be had to its assistance for other purposes also, it is very important that it should be well constructed and in good working order. The points to be particularly looked to in testing it, are for the most part the same with those already noticed in relation to the coarse movement. It should work smoothly and equably, producing that *graduated* alteration of the distance of the Object-glass from the object which it is its special duty to effect, without any jerking or irregularity. It should be so sensitive, that any movement of the milled-head should at once make its action apparent by an alteration in the distinctness of the image, when high powers are employed, without any 'loss of time.'* And its action should not give rise to any twisting or displacing movement of the image, which ought not to be in the least degree disturbed by any number of rotations of the milled-head, still less by a rotation through only a few degrees. One great use of the Fine adjustment consists in bringing into view different *strata* of the object, and this in such a gradual manner that their connection with one another shall be made apparent. Whether an Opaque or a Transparent object be under examination, only that part which is exactly in focus can be perfectly discerned under any power; and when high powers of large angular aperture are employed, this is the only part that can be seen at all. A minute alteration of the focus often causes so different a set of appearances to be presented, that, if this alteration be made abruptly, their relation to the preceding can scarcely be even guessed at; and the gradual transition from the one to the other, which the Fine adjustment alone affords, is therefore necessary to the correct interpretation of either. To take a very simple case:—The transparent body of a certain animal being transversed by vessels lying in different planes, one set of these vessels is brought into view by one adjustment, another set by 'focussing' to a different plane; and the connection of the two sets of vessels, which may be the point of most importance in the whole anatomy of the animal, may be entirely overlooked for want of a Fine adjustment, the graduated action of which shall enable one to be traced continuously into the other. What is true even of low and medium powers is of course true to a still greater degree of high powers; for although the 'quick motion' *may* enable the observer to bring any stratum of the object into accurate focus, it is impossible for him by its means to secure that *transitional* 'focussing' which is often much more instructive than an exact adjustment

* It will sometimes happen that the 'slow motion' will seem not to act, merely because it has been so habitually worked in one direction rather than the other, that its screw has been turned too far. In that case, nothing more is required for its restoration to good working order than turning the screw in the other direction, until it shall have reached about the middle of its range of action.

at any one point. A clearer idea of the nature of a doubtful structure is, in fact, often derived from what is caught sight of *in the act* of changing the focus, than by the most attentive study and comparison of the different views obtained by any number of separate 'focussings.' The experienced Microscopist, therefore, whilst examining an object of almost any description, constantly keeps his finger upon the milled-head of the 'slow motion,' and watches the effect produced by its revolution upon every feature which he distinguishes; never leaving off until he be satisfied that he has scrutinized not only the entire *surface*, but the entire *thickness* of the object. It will often happen, that where different structural features present themselves on different planes, it will be difficult or even impossible to determine with the Monocular Microscope which of them is the nearer and which the more remote (§ 86), unless it be ascertained by the use of the 'slow motion,' when they are successively brought into focus, whether the Object-glass has been moved *towards* or *away from* the object.* Even this, however, will not always succeed in certain of the most difficult cases, in which the difference of level is so slight as to be almost inappreciable; as, for instance, in the case of the markings on the siliceous *loricæ* of the Diatomaceæ (§ 127).

113. When Objectives of short focus and of wide Angular Aperture are being employed, something more is necessary than exact focal adjustment; this being the *Adjustment of the Object-glass* itself, which is required to neutralize the disturbing effect of the glass cover upon the course of the rays proceeding from the object (§ 15). For this adjustment, it will be recollected, a power of altering the distance between the front pair and the remainder of the combination is required; and this power is obtained in the following manner:—The front pair of lenses is fixed into a tube (Fig. 86, A), which slides over an interior tube (B) by which the other two pairs are held; and it is drawn up or down by means of a collar (c), which works in a furrow cut in the inner tube, and upon a screw-thread cut in the outer, so that its revolution in the plane to which it is fixed by the one tube gives a vertical movement to the other. In one part of the outer tube an oblong slit is made, as seen at D, into which projects a small tongue screwed on the inner tube; at the side of the former two horizontal lines are engraved, one pointing to the word 'uncovered,' the other to the word 'covered;' whilst the latter is crossed by a horizontal mark, which is brought to coincide with either of the two lines by the rotation of the screw-collar, whereby the outer tube is moved up or down. When the mark has been made to point to the line 'uncovered,' it indicates that the distance of the lenses of the object-glass is such as to make it suitable for viewing an object without any interference from thin glass; when, on the other hand, the

* It is in objects of this kind that the great advantage of the Stereoscopic Binocular arrangement makes itself most felt (§ 81).

mark has been brought by the revolution of the screw-collar into coincidence with the line 'covered,' it indicates that the front lens has been brought into such proximity with the other two as to

FIG. 86.

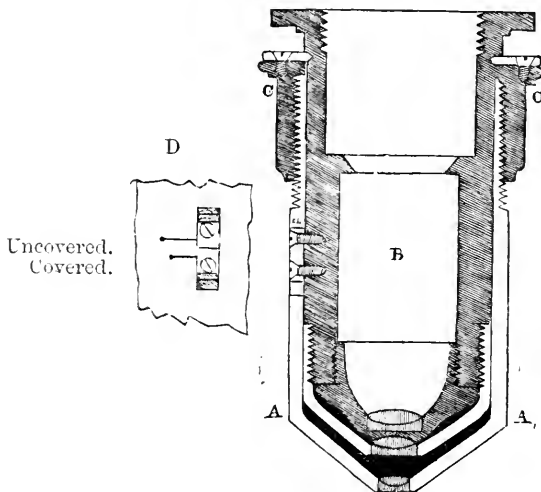

Section of an Adjusting Object-Glass.

produce a 'positive aberration' in the Objective, fitted to neutralize the 'negative aberration' produced by the interposition of a glass cover of a certain thickness. It is evident, however, that unless the particular thickness of glass for which this degree of alteration is suited be always employed for this purpose, the correction cannot be exact; and means must be taken for adapting it to every grade of thickness which may be likely to present itself in the glass covers. Unless this correction be made with the greatest precision, the enlargement of the Angle of Aperture, to which our Opticians have of late applied themselves with such remarkable success, becomes worse than useless; being a source of diminished instead of increased distinctness in the details of the object, which are far better seen with an Objective of greatly inferior aperture, possessing no special adjustment for the thickness of the glass. The following general rule is given by Mr. Wenham for securing the most efficient performance of an Object-glass with any ordinary object:—"Select any dark speck or opaque portion of the object, and bring the outline into perfect focus; then lay the finger on the milled-head of the fine motion, and move it briskly backwards and forwards in both directions from the first position. Observe the expansion of the dark outline of the object, both when within

and when without the focus. If the greater expansion, or coma, is when the object is *without* the focus, or farthest from the Objective, the lenses must be placed farther asunder, or towards the mark 'uncovered.' If the greater coma is when the object is *within* the focus, or nearest to the Objective, the lenses must be brought closer together, or towards the mark 'covered.' When the object-glass is in proper adjustment, the expansion of the outline is exactly the same both within and without the focus." A different indication, however, is afforded by such 'test-objects' as present (like the Podura-scale and the Diatomaceæ) a set of distinct dots or other markings. For "if the dots have a tendency to run into lines when the object is placed *without* the focus, the glasses must be brought closer together; on the contrary, if the lines appear when the object is *within* the focal point, the object must be farther separated."* When the Angle of Aperture is very wide, the difference in the aspect of any severe Test under different adjustments becomes at once evident; markings which are very distinct when the correction has been exactly made, disappearing almost instantaneously when the screw-collar is turned a little way round.†

114. Although the *most perfect* Correction required for each particular object (which depends, not merely upon the thickness of its glass cover, but upon that of the fluid or balsam in which it may be mounted) can only be found by experimental trial; yet for all ordinary purposes, the following simple method, first devised by Mr. Powell, will suffice. The object-glass, adjusted to 'uncovered,' is to be 'focussed' to the object; its screw-collar is next to be turned until the surface of the glass cover comes into focus, as may be perceived by the spots or striae by which it may be marked; the object is then to be again brought into focus by the 'slow motion.' The edge of the screw-collar being now usually graduated, the particular adjustment which any object may have been found to require, and of which a record has been kept, may be made again without any difficulty. By Messrs. Smith and Beck, however, who first introduced this Graduation, a further use is made of it. By experiments such as those described in the last paragraph, the correct adjustment is first found for any particular object, and the number of divisions observed through which the screw-collar must

* See "Quart. Journ. of Microsc. Science," Vol. ii. (1854), p. 138.

† Mr. Wenham remarks *loc. cit.*), not without justice, upon the difficulty of making this adjustment even in the Objectives of our best Opticians; and he states that he has himself succeeded much better by making the outer tube the fixture, and by making the tube that carries the other pairs slide within this; the motion being given by the action of an inclined slit in the revolving collar, upon a pin that passes through a longitudinal slit in the outer tube to be attached to the inner. The whole range of adjustment is thus performed within a third part of a revolution, with scarcely any friction, and with such an immediate transition from good to bad definition, that the best point is made readily apparent.

be moved in order to bring it back to 0° , the position suitable for an uncovered object. The thickness of the glass cover must then be measured by means of the 'slow motion;' this is done by bringing into exact focus, first the object itself, and then the surface of the glass cover, and by observing the number of divisions through which the milled head (which is itself graduated) has passed in making this change. A definite ratio between that thickness of glass and the correction required in that particular Objective is thus established; and this serves as the guide to the requisite correction for any other thickness, which has been determined in like manner by the 'slow motion.' Thus, supposing a particular thickness of glass to be measured by 12 divisions of the milled-head of the 'slow motion,' and the most perfect performance of the Object-glass to be obtained by moving the screw-collar through 8 divisions, then a thickness of glass measured by 9 divisions of the milled-head would require the screw-collar to be adjusted to 6 divisions in order to obtain the best effect. The ratio between the two sets of divisions is by no means the same for different combinations; and it ought to be determined for each Objective by its maker, who will generally be the best judge of the best 'points' of his lenses; but when this ratio has been once ascertained, the adjustment for any thickness of glass with which the object may happen to be covered is readily made by the Microscopist himself. Although this method appears somewhat more complex than that of Mr. Powell, yet it is more perfect; and when the ratio between the two sets of divisions has been once determined, the adjustment does not really involve more trouble.—Another use is made of this adjustment by Messrs. Smith and Beck, namely, to correct the performance of the Objectives, which is disturbed by the increase of distance between the Objective and the Eye-piece that is occasioned by the use of the Draw-tube (§ 63). Accordingly, they mark a scale of inches on the Draw-tube (which is useful for many other purposes), and direct that for every inch the body is lengthened, the screw-collar of the Objective shall be moved through a certain number of divisions.

115. *Arrangement for Transparent Objects.*—If the Object be already 'mounted' in a Slide, nothing more is necessary, in order to bring it into the right position for viewing it, than to lay the slide upon the Object-platform of the Stage, and to support it in such a position (by means of the sliding ledge or other contrivance) that the part to be viewed is, as nearly as can be guessed, in the centre of the aperture of the stage, and therefore in a line with the axis of the body. If the object be not 'mounted,' and be of such a kind that it is best seen dry, it may be simply laid upon the Glass Stage-plate (§ 96), the ledge of which will prevent it from slipping off when the Microscope is inclined, and a plate of thin glass may be laid over it for its protection, if its delicacy should seem to render this desirable. If, again, it be disposed to curl up,

so that a slight pressure is needed to flatten or extend it, recourse may be had to the use of the Aquatic Box (§ 97) or of the Compressorium (§ 99), without the introduction of any liquid between the surfaces of glass. In a very large proportion of cases, however, either the objects to be examined are already floating in fluid, or it is preferable to examine them in fluid on account of the greater distinctness with which they may be seen. If such objects be minute, and the quantity of liquid be small, the drop is simply to be laid on a slip of glass, and covered with a plate of thin glass; if the object or the quantity of liquid be larger, it will be better to place it in the Aquatic Box; whilst, if the object have dimensions which render even this inconvenient, the Zoophyte Trough (§ 98) will afford the best medium for its examination. In the case of living animals, whose movements it is desired to limit (so as to keep them within the field of view) without restraining them by compression, the Author has found the following plan extremely convenient. The drop of water taken up with the animal by the Dipping-tube being allowed to fall into a concave slide (Fig. 104), the whole of the superfluous water may be removed by the Syringe (§ 101), only just as much being left as will keep the animal alive. If the animal be very minute, it is convenient to effect this withdrawal by placing the slide on the stage of the Dissecting Microscope (§ 37), and by working the syringe under the magnifier; and it will be found, after a little practice, that the complete command which the operator has over the movements of the piston, as well as over the place of the point of the syringe, enables him to remove every drop of superfluous water without drawing the animal into the syringe. When, on the other hand, it is desired to isolate a particular animal from a number of others, the syringe may be conveniently used, after the same fashion, to draw it up and transfer it to another slide; care being, of course, taken that the syringe so employed has a sufficient aperture to receive it freely. If it be wished to have recourse to *compression*, for the expansion or flattening of the object, this may be made upon the ordinary slide, by pressing down the thin-glass cover with a pointed stick; and this method, which allows the pressure to be applied where it may chance to be most required, will generally be found preferable for delicate portions of tissue which are easily spread out, and which, in fact, require little other compression than is afforded by the weight of the glass cover, and by the capillary attraction which draws it into proximity with the slide beneath. A firmer and more enduring pressure may be exerted by the dexterous management of a well-constructed Aquatic Box; and this method is peculiarly valuable for confining the movements of minute animals, so as to keep them at rest under the field of the microscope, without killing them. It is where a firm but graduated pressure is required, for the flattening-out of the bodies of thin semi-transparent animals, without the necessity of removing them

from the field of the Microscope, that the Compressorium (§ 99) is most useful.

116. In whatever way the Object is submitted to examination, it must be first brought approximately into position, and supported there, just as if it were in a mounted Slide. The precise mode of effecting this will differ, according to the particular plan of the instrument employed; thus, in some it is only the ledge itself that slides along the stage; in others it is a carriage of some kind, whereon the object-slide rests; in others, again, it is the entire platform itself that moves upon a fixed plate beneath. Having guided his object, as nearly as he can do by the unassisted eye, into its proper place, the Microscopist then brings his light (whether natural or artificial) to bear upon it, by turning the Mirror in such a direction as to reflect upon its under surface the rays which are received by itself from the sky or the lamp. The *concave* Mirror is that which should always be first employed, the *plane* being reserved for special purposes; and it should bring the rays to convergence in or near the plane in which the object lies (Fig. 87). The distance at which it should be ordinarily set

FIG. 87.

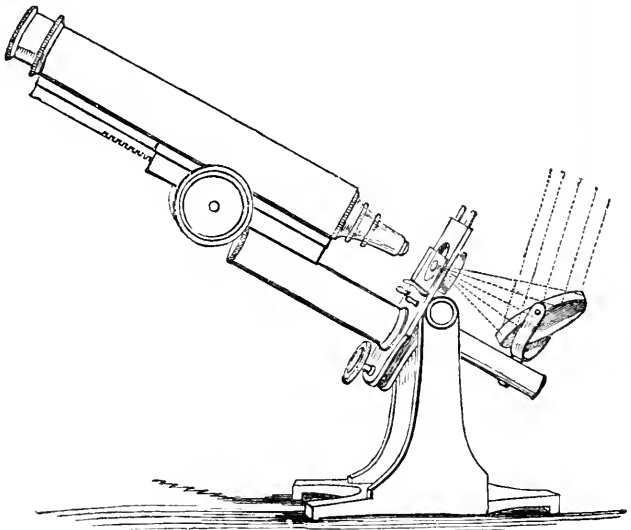

Arrangement of Microscope for Transparent Objects.

beneath the Stage, is that at which it brings parallel rays to a focus; but this distance should be capable of elongation, by the lengthening of the stem to which the Mirror is attached; since the rays diverging from a lamp at a short distance are not so soon brought to a focus. The correct focal adjustment of the Mirror may be

judged of by its formation of images of window-bars, chimneys, &c., upon any semi-transparent medium placed in the plane of the object. It is only, however, when small objects are being viewed under high magnifying powers, that such a concentration of the light reflected by the Mirror is either necessary or desirable; for, with large objects seen under low powers, the field would not in this mode be equally illuminated. The diffusion of the light over a larger area may be secured, either by shifting the Mirror so much above or so much below its previous position, that the pencil will fall upon the object whilst still converging or after it has met and diverged; or, on the other hand, by the interposition of a plate of Ground-glass in the course of the converging pencil: this last method, which is peculiarly appropriate to lamp-light, being very easily had recourse to, if the diaphragm-plate, as formerly recommended (§ 78), have had its larger aperture filled with such a diffusive medium. The eye being now applied to the Eye-piece, and the body being 'focussed,' the object is to be brought into the exact position required by the use of the traversing movement, if the stage be provided with it; if not, by the use of the two hands, one moving the object-slide from side to side, the other pushing the ledge, fork, or holder that carries it, either forwards or backwards as may be required. It is always to be remembered, in making such adjustments by the direct use of the hands, that, owing to the inverting action of the Microscope, the motion to be given to the object, whether lateral or vertical, must be precisely opposed to that which its image *seems* to require, save when Erectors (§§ 64, 65) are employed. When the object has been thus brought fully into view, the Mirror may require a more accurate adjustment. What should be aimed at is the diffusion of a clear and equable light over the entire field; and the observer should not be satisfied until he has attained this object. If the field should be darker on one side than on the other, the Mirror should be slightly turned in such a direction as to throw more light upon that side; perhaps in so doing, the light may be withdrawn from some part previously illuminated; and it may thus be found that the pencil is not large enough to light up the entire field. This may be owing to one of three causes: either the cone of rays may be received by the object too near to its focal apex, the remedy for which lies in an alteration in the distance of the Mirror from the stage; or, from the very oblique position of the Mirror, the cone is too much narrowed across one of its diameters, and the remedy must be sought in a change in the position either of the Microscope or of the Lamp, so that the face of the Mirror may not be turned so much away from the axis of vision; or, again, from the centre of the Mirror being out of the optical axis of the instrument, the illuminating cone is projected obliquely, an error which can be rectified without the least difficulty. If the cone of rays should come to a focus in the object, the field is not unlikely to be crossed (in the day-time) by

the images of window-bars or chimneys, or (at night) the form of the lamp-flame may be distinguished upon it : the former must be got rid of by a slight change in the inclination of the Mirror ; and if the latter cannot be dissipated in the same way, the lamp should be brought a little nearer.

117. The equable illumination of the entire field having been thus obtained, the *quantity* of light to be admitted should be regulated by the Diaphragm-plate (§ 78). This must depend very much upon the nature of the object, and upon the intensity of the light. Generally speaking, the more transparent the object, the less light does it need for its most perfect display ; and its most delicate markings are frequently only made visible, when the major part of the cone of rays has been cut off. Thus the movement of the *cilia*—those minute vibratile filaments with which almost every Animal is provided in some part of its organism, and which many of the humbler Plants also possess—can only be discerned in many instances when the light is admitted through the smallest aperture. On the other hand, the less transparent objects usually require the stronger illumination which is afforded by a wider cone of rays ; and there are some (such as semi-transparent sections of Fossil Teeth) which, even when viewed with low powers, are better seen with the intenser light afforded by the Achromatic Condenser. In every case in which the object presents any considerable obstruction to the passage of the rays through it, great care should be taken to protect it entirely from *incident* light ; since this extremely weakens the effect of that which is received into the Microscope by transmission. It is by daylight that this interference is most likely to occur ; since, if the precautions already given (§ 106) respecting the use of lamp-light be observed, no great amount of light *can* fall upon the upper surface of the object. The observer will be warned that such an effect is being produced, by perceiving that there is a want not only of brightness but of clearness in the image, the field being veiled, as it were, by a kind of thin vapour ; and he may at once satisfy himself of the cause by interposing his hand between the stage and the source of light, when the immediate increase of brilliancy and of distinctness will reveal to him the occasion of the previous deficiency in both. Nothing more is necessary for its permanent avoidance than the interposition of an opaque screen (blackened on the side towards the stage) between the window and the object ; care being of course taken that the screen does not interfere with the passage of light to the Mirror. Such a screen may be easily shaped and adapted either to be carried by the stage itself, or by the stand for the condenser ; but it is seldom employed by Microscopists, as it interferes with access to the left side of the stage ; and the interposition of the hand, so often as it may be needed, is more frequently had recourse to in preference, as the more convenient expedient. The young Microscopist who may be examining transparent objects

by daylight is recommended never to omit ascertaining whether the view which he may obtain of them is in any degree thus marred by incident light.

118. Although the illumination afforded by the Mirror alone is quite adequate for a very large proportion of the purposes for which the Microscope may be profitably employed (nothing else having been used by many of those who have made most valuable contributions to Science by means of this instrument), yet, when high magnifying powers are employed, and sometimes even when but a very moderate amplification is needed, great advantage is gained from the use of a Condenser. The form which has been described under the name of the *Webster Condenser* (§ 80) answers so well for most purposes, and may in addition be so easily converted into a Black-Ground Illuminator, that the working Microscopist will find it convenient to keep it always in place; substituting an *Achromatic Condenser* of greater power (§ 79) only when specially needed. Special care is needed in the use of this last, both as to the coincidence of its optic axis with that of the Microscope itself, and as to its focal distance from the object. The *centering* may be most readily accomplished by so adjusting the distance of the Condenser from the Stage (by the rack-and-pinion action, or the sliding movement, with which it is always provided), that a sharp circle of light shall be thrown on any semi-transparent medium laid upon it; then, on this being viewed through the Microscope with an Objective of sufficiently low power to take in the whole of it, if this circle be not found to be concentric with the field of view, the axis of the Condenser must be altered by means of the milled-head tangent-screws with which it is provided. The *focal adjustment*, on the other hand, must be made under the Objective which is to be employed in the examination of the object, by turning the Mirror in such a manner as to throw upon the visual image of the object (previously brought into the focus of the Microscope) an image of a chimney or a window-bar, if daylight be employed, or of the top, bottom, or edge of the lamp-flame, if lamp-light be in use; the focus of the condenser should then be so adjusted as to render the view of this as distinct as possible; and the direction of the Mirror should then be sufficiently changed to displace the image, and to substitute for it the clearest light that can be obtained. It will generally be found, however, that although such an exact focussing gives the most perfect results by Daylight, yet that by Lamp-light the best illumination is obtained when the Condenser is removed to a somewhat greater distance from the object than that at which it gives a distinct image of the lamp. In every case, indeed, in which it is desired to ascertain the effect of *variety* in the method of illumination, the effects of alterations in the distance of the condenser from the object should be tried; as it will often happen that delicate markings become visible when the condenser is a little *out of focus*, which cannot be distinguished

when it is precisely *in focus*. The regulation of the *amount of light* transmitted through the object is often of the very first importance; and no means of accomplishing this is so convenient as a Graduating Diaphragm (§ 78). For some objects of great transparency, the White-Cloud illumination (§ 87) may be had recourse to with advantage. For the most difficult class of objects, however, when viewed by lamp-light under the highest powers, it is better to dispense with the Mirror altogether, placing the lamp in the axis of the Microscope, so that its light shall fall directly on the Condenser.

119. There are many Transparent Objects, however, whose peculiar features can only be distinctly made out when they are viewed by light transmitted through them *obliquely* instead of axially; and this is especially the case with such as have their surfaces marked by very delicate and closely-approximated furrows, the *direction* of the oblique rays being then a matter of primary importance. Thus suppose that an object be marked by longitudinal striæ too delicate to be seen by ordinary direct light; the oblique light most fitted to bring them into view will be that proceeding in either of the directions C or D; that which falls upon it in the directions A and B tending

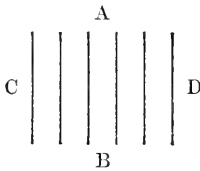

to obscure the striæ rather than to disclose them. But, moreover, if the striæ should be due to furrows or prominences which have one side inclined and the other side abrupt, they will not be brought into view indifferently by light from C or from D, but will be shown best by that which makes the strongest shadow: hence if there be a projecting ridge, with an abrupt side looking towards C, it will be best seen by light from D; whilst if there be a furrow with a steep bank on the side of C, it will be by light from that side that it will be best displayed. But it is not at all unfrequent for the longitudinal striæ to be crossed by others; and these transverse striæ will usually be best seen by the light that is least favourable for the longitudinal; so that, in order to bring them into distinct view, either the illuminating pencil or the object must be moved a quarter round. The simplest mode of attaining this end is to make the Mirror capable of being turned into such a position, as to reflect light into the object from one side and at a very oblique angle; and to give the Stage a rotatory movement, so that the object may be presented to that light under every aspect. This is more effectually accomplished in Nacet's Student's Microscope (Fig. 37), than in any English instrument of equally simple construction which the Author has seen. But where sufficient obliquity cannot be given to the Mirror, nearly the same effect may be produced by placing the Lamp in the desired direction, and interposing an ordinary Condensing lens between it and the object.

120. For objects of the greatest difficulty, however, it is better to

have recourse to the Accessories which are specially provided to furnish oblique illumination in the most effectual manner. Thus by using the Webster Condenser (§ 80) or an Achromatic Condenser of large angular aperture (§ 79) with a central stop, rays of great obliquity are admitted from every azimuth at once; and there are some objects which are best seen in this manner.

Either of these condensers, again, may be used, like Mr. Reade's Hemispherical Condenser (§ 83), with diaphragms that allow light to pass only from some particular portion or portions of their periphery; thus illuminating the object from the exact direction or directions best adapted to develop its markings. And if the Stage of the Microscope should not be capable of rotation in the optic axis of the instrument, the required variety of direction may be given by rotating the eccentric Diaphragm. In most first-class Microscopes this rotation can be given to the Illuminating apparatus by a rack-and-pinion movement. Very oblique illumination in one direction only may also be conveniently obtained by the use of the Amici Prism (§ 82), which combines the action of Mirror and Condenser, and which may be rendered still more effective by being made achromatic; and where it is desired to bring out simultaneously two sets of lines crossing each other transversely or

obliquely, two such prisms may be employed at once, so fixed as to throw the light of two separate lamps in the most advantageous

FIG. 88.

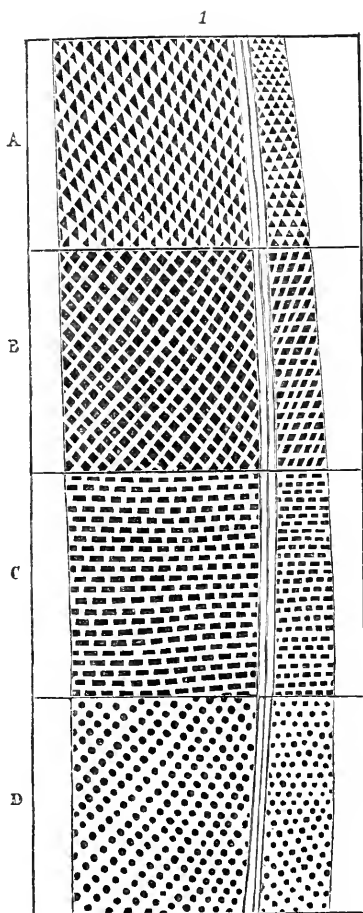

Valve of *Pleurosigma Formosum*, with portions A, B, C, D, showing diverse effects of Illumination.

directions. A good example of the variety of appearances which the same object may exhibit when illuminated in different modes is shown in Fig. 88, which represents portions of a valve of *Pleurosigma formosum* as seen under a power of 1300 diameters; the markings shown at A, B, and c are brought out by *oblique* light in different directions; whilst at d is shown the effect of *central* illumination with the Achromatic Condenser.

121. There are many kinds of Transparent Objects—especially such as either consist of thin plates, disks, or spicules of Siliceous or Calcareous matter, or contain such bodies—which are peculiarly well seen under the *Black-ground* illumination (§§ 84, 85); for not only does the brilliant luminosity which they then present, in contrast with the dark ground behind them, show their forms to extraordinary advantage; but this mode of illumination imparts to them an appearance of solidity which they do not exhibit by ordinary transmitted light (§ 86); and it also frequently brings out surface-markings which are not otherwise distinguishable. Hence, when any object is under examination that can be supposed to be a good subject for this method, the trial of it should never be omitted. For the low powers, the use of the Spot-Lens or the Webster Condenser with the central stop, will be found sufficiently satisfactory; for the higher, the Paraboloid should be employed.—Similar general remarks may be made respecting the examination of objects by *Polarized* light. Some of the most striking effects of this kind of illumination are produced upon bodies whose particles have a crystalline aggregation; and hence it may often be employed with great advantage to bring such bodies into view, when they would not otherwise be distinguished; thus, for example, the *Raphides* of Plants are much more clearly made out by its means, in the midst of the vegetable tissues, than they can be by any other. But the peculiar effects of Polarized light are also exerted upon a great number of other Organized substances, both animal and vegetable; and it often reveals differences in the arrangement or in the relative density of their component particles, the existence of which would not otherwise have been suspected: hence the Microscopist will do well to have recourse to it, whenever he may have the least suspicion that its use can give him an additional power of discrimination.

122. *Arrangement for Opaque Objects.*—There are many objects of the most interesting character, the opacity of which entirely forbids the transmission of light through them, and of which, therefore, the *surfaces* only can be viewed by means of the *incident* rays which they *reflect*. These are, for the most part, objects of comparatively large dimensions, for which a low magnifying power suffices; and it is specially important, in the examination of such objects, not to use a lens of shorter focus than is absolutely necessary for discerning the details of the structure; since, the longer the focus of the Objective employed, the less is the indistinctness pro-

duced by inequalities of the surface, and the larger, too, may be its aperture, so as to admit a greater quantity of light, to the great improvement of the brightness of the image. Objectives of long focus are especially required in Microscopes that are to be used for Educational purposes; since it is most important that the young should be trained in a knowledge of the wonders and beauties of the familiar objects around them, and of these an endless variety may be found by such as will take the trouble to search for them, which can thus be viewed with great facility.* The mode of bringing Opaque objects under view will differ according to their 'mounting,' and to the manner in which it is desired to illuminate them. If the object be mounted in a 'slide' of glass or wood, upon a large Opaque surface, the slide must be laid on the stage in the usual manner, and the object brought as nearly as possible into position by the eye alone (§ 115). If it be not so mounted, it may be simply laid upon the glass Stage-plate, resting against its ledge; and the Diaphragm-plate must then be so turned as to afford it a black

FIG. 89.

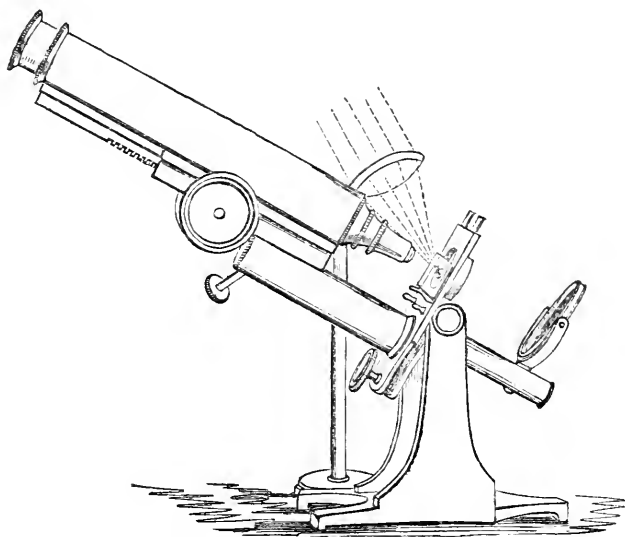

Arrangement of Microscope for Opaque Objects.

background, light being thrown upon it by a Condensing Lens or Bull's-eye placed as in Fig. 89, or (still better) by Beck's Parabolic Speculum, which gives a far better illumination by diffused daylight than can be obtained by any other means yet devised, and which is

* The makers of Educational Microscopes (p. 64, note) supply at a small cost single (triplet) combinations of 3 inches, 2 inches, $1\frac{1}{2}$ inches or 1-inch focus, which are quite adequate for ordinary requirements.

equally well adapted to lamp-light, when used in combination with the Bull's-eye (§ 91). Direct sunlight cannot be employed without the production of an injurious glare, and the risk of burning the object ; but the sunlight reflected from a bright cloud is the best light possible. When a Condensing Lens is used, it should always be placed at right angles to the direction of the illuminating rays, and at a distance from the object which will be determined by the size of the surface to be illuminated and by the kind of light required. If the magnifying power employed be high, and the field of view be consequently limited, it will be desirable so to adjust the lens as to bring the cone of rays to a point upon the part of the object under examination ; and this adjustment can only be rightly made whilst the object is kept in view under the Microscope, the Condenser being moved in various modes until that position has been found for it in which it gives the best light. If, on the other hand, the power be low, and it be desired to spread the light equably over a large field, the Condenser should be placed either within or beyond its focal distance ; and here, too, the best position will be ascertained by trial. It will often be desirable also to vary both the obliquity of the light and the direction in which it falls upon the object ; the aspect of which is greatly affected by the manner in which the shadows are projected upon its surface, and in which the lights are reflected from the various points of it. Many objects, indeed, which are distinguished by their striking appearance when the light falls upon them on one side, are entirely destitute both of brilliancy of colour and of sharpness of outline when illuminated from the opposite side. Hence it is always desirable to try the effect of changing the position of the object ; which, if it be 'mounted,' may be first shifted by merely reversing the place of the two ends of the slide, and then, if this be not satisfactory, may be more completely as well as more gradually altered, by making the object-platform itself to revolve. With regard to the obliquity of the illuminating rays, it is well to remark, that if the object be 'mounted' under a glass cover, and the incident rays fall at too great an angle with the perpendicular, a large proportion of them will be reflected, and the brilliancy of the object will be greatly impaired ; and hence when Opaque objects are being examined under high powers, which can only be done with a very oblique illuminating pencil, they should always be *uncovered*.

123. The same general arrangement must be made when Artificial light is used for the illumination of Opaque objects ; the Lamp being placed in such a position in regard to the Stage that its rays may fall in the direction indicated in Fig. 89, and these rays being collected and concentrated by the Condenser, as already directed. Since the rays proceeding from a lamp within a short distance are already diverging, they will not be brought by the Condenser to such speedy convergence as are the parallel rays of daylight ; and it must, therefore, be further removed from the

object to produce the same effect. By modifying the distance of the Condenser from the lamp and from the object respectively, the cone of rays may be brought nearly to a focus, or it may be spread almost equably over a large surface, as may be desired. And the same effect may be produced by shifting the position of the Condenser, when Beck's Parabolic Speculum is employed in combination with it. No more effective illumination can be desired for objects viewed under the low powers to which the Parabolic Speculum is adapted, than that which is afforded by this combination; the Bockett Lamp (Fig. 85) supplying a most convenient means of using it, as the Author can testify from a very large experience. In the illumination of Opaque objects, Artificial light has the advantage over ordinary daylight of being more easily concentrated to the precise degree, and of being more readily made to fall in the precise direction, that may be found most advantageous. Moreover, the contrast of light and shadow will be more strongly marked when no light falls upon the object except that proceeding from the lamp used for its illumination, than it can be when the shadows are partially lightened by the rays which fall upon the object from every quarter, as must be the case if it be viewed by daylight. If a more concentrated light be required, the small Condensing Lens may be used in combination with the Bull's-eye, being so placed as to receive the cone projected by it, and to bring its rays to a more exact convergence. In this manner very minute bodies may be viewed as Opaque objects under high magnifying powers, provided that the brasswork of the extremities of the Objectives be so bevelled-off as to allow the illuminating cone to have access to the object. As none but a very oblique illumination, however, can be thus obtained, the view of the object will be by no means complete unless it be supplemented by that which may be obtained by means of the Vertical Illuminator (§ 93), which supplies for high powers the kind of illumination that is given by the Lieberkühn for the lower.

124. There are many Opaque objects which it is desirable to view from all sides, in order that their features may be completely made out. For such as can be conveniently attached to small disks, Beck's Disk-holder (§ 95) affords by far the most convenient and effective mode of presenting them in every variety of aspect. Many small objects, such as the Capsules of Mosses, may be grasped in the Stage-Forceps; and by a little care in manipulation every part may be brought into view successively. In either of these cases the Lieberkühn can be employed with powers that are too high for the Parabolic Speculum; and light of considerable obliquity may be obtained by its means, either by turning the Mirror out of the axis, or by covering the greater part of the reflecting surface of the Lieberkühn by means of a cap, or by a combination of both methods. Whenever the Lieberkühn is employed, care must be taken that the direct light from the Mirror be entirely

stopped out by the interposition of a 'dark well' or of a black disk, of such a size as to *fill* the field given by the particular Objective employed, but not to pass much beyond it. Opaque objects that are permanently mounted either upon cardboard disks or in the slides specially provided for them, may be presented to the Microscope in a considerable variety of directions by means of Morris's Object-holder (Fig. 77), which, however, can only be employed with side-illumination. If it be desired to make the most advantageous use of this instrument, objects mounted in slides should be so placed that the parts to be brought into view by its tilting movement may look towards the long edges of the slide; since it is obvious that a much greater inclination may be given to it in either of these directions, than in the direction of either of its extremities.

125. *Errors of Interpretation.*—The correctness of the conclusions which the Microscopist will draw regarding the nature of any object, from the visual appearances which it presents to him when examined in the various modes now specified, will necessarily depend in a great degree upon his previous experience in Microscopic observation, and upon his knowledge of the class of bodies to which the particular specimen may belong. Not only are observations of *any* kind liable to certain fallacies, arising out of the previous notions which the observer may entertain in regard to the constitution of the objects or the nature of the actions to which his attention is directed, but even the most practised observer is apt to take no note of such phenomena as his mind is not prepared to appreciate. Thus, for example, it cannot be doubted that many Physiologists must have seen those appearances in thin slices of Cartilage which are now interpreted as denoting its *cellular* organization, without in the least degree suspecting their real import, which Schwann was the first to deduce from the study of the development of that tissue. It was not known before his time "what cells mean" in animal organization; and the visual appearances, which now suggest the idea of them to the mind of even the tyro in the study of Histology, passed almost entirely unnoticed by keen-sighted and intelligent Microscopists previously to 1839. Errors and imperfections of this kind can only be corrected, it is obvious, by general advance in scientific knowledge; but the history of them affords a useful warning against hasty conclusions drawn from a too cursory examination. If the history of almost *any* scientific investigation were fully made known, it would generally appear that the stability and completeness of the conclusions finally arrived-at had only been attained after many modifications, or even entire alterations, of doctrine. And it is, therefore, of such great importance to the correctness of our conclusions as to be almost essential, that they should not be finally formed and announced until they have been tested in every conceivable mode. It is due to Science that it should be burdened with as few false

facts and false doctrines as possible. It is due to other truth-seekers that they should not be misled, to the great waste of *their* time and pains, by *our* errors. And it is due to ourselves that we should not commit our reputation to the chance of impairment by the premature formation and publication of conclusions, which may be at once reversed by other observers better informed than ourselves, or may be proved to be fallacious at some future time, perhaps even by our own more extended and careful researches. The *suspension of the judgment, whenever there seems room for doubt*, is a lesson inculcated by all those philosophers who have gained the highest repute for practical wisdom ; and it is one which the Microscopist cannot too soon learn, or too constantly practise.

126. Besides these general warnings, however, certain special cautions should be given to the young Microscopist, with regard to errors into which he is liable to be led by the misinterpretation of appearances peculiar to objects thus viewed, even when the very best instruments are employed. Thus, the sharpness of the outline of any transparent object is impaired by a change in the course of the rays that merely *pass by* it, which is termed *Inflection* or *Diffraction*. If any Opaque object be held in the course of a cone of rays diverging from a focus, the shadow which it will form upon a screen held to receive it will not possess a well-defined *edge*, but will have as its boundary a shaded *band*, gradually increasing in brightness from the part of the screen on which the shadow is most intense to that on which the illumination is most complete. If the light be homogeneous in its quality, the shaded band will possess no colours of its own ; but if the light be decomposable, like the ordinary solar beam, the band will exhibit prismatic fringes.* It is obvious that such a diffraction must exist in the rays transmitted through the substance, as well as along the edges, of transparent objects ; and that it must interfere with the perfect distinctness, not merely of their outlines, but of their images, the various markings of which are *shadows* of portions that afford obstacles, more or less complete, to the perfectly free transmission of the rays. There are many objects of great delicacy, in which the 'diffraction-band' is liable to be mistaken for the indication of an actual substance ; on the other hand, the presence of an actual substance of extreme transparence may sometimes be doubted or denied, through its being erroneously attributed to the 'diffraction-band.' No rules can be given for the avoidance of such errors, since they can only be escaped by the discriminative power which education and habit confer. The practised Microscopist, indeed,

* This phenomenon is explained, on the Undulatory Theory of light, by the disturbance which takes place in the onward propagation of waves, when subsidiary centres of undulation are developed by the impact of the principal undulations on obstacles in their course ; the chromatic dispersion being due to the inequality in the lengths of the undulations proper to the severally-coloured rays.

almost instinctively makes the requisite allowance for diffraction ; and seldom finds himself embarrassed by it in the interpretation of the visual appearances which he obtains through a good instrument. Besides this unavoidable result of the inflection of the rays of light, there is a peculiar phenomenon attendant upon oblique illumination at certain angles in one direction, which consists in the production of a double image, or a kind of overlying shadow, sometimes presenting markings equally distinct with those of the object itself. This image, which is not unlike the secondary image formed by reflection from the outer surface of a silvered-glass Mirror, has been called the 'diffracting spectrum ;' but its origin does not really lie in the diffraction of the luminous rays, since on the one hand it cannot be explained according to the laws of diffraction, and on the other it may be traced to an entirely different cause. An object thus illuminated is seen by two different sets of rays ; those, namely, of *transmitted* light, which pass through it obliquely from the source of the illumination to the opposite side of the object-glass ; and those of the *radiated* light, which, being intercepted by the object, are given off from it again in all directions. (The latter alone are the rays whereby the images are formed in any kind of 'Black-Ground' illumination, §§ 84, 85.) Hence two different images will be formed when the illuminating pencil is very oblique and the angular aperture of the object-glass is wide, one of them by the light transmitted to one extreme of its aperture, the other by the light radiated to its general surface ; and one or the other of these images may be stopped-out, by covering that portion of the lens which receives, or that which does not receive, the transmitted pencil. This 'diffracting spectrum' may be produced at pleasure, in an object illuminated by direct light and seen with an Objective of large angular aperture, by holding a needle or a horsehair before its front lens.

127. Errors of interpretation arising from the imperfection of the Focal adjustment are not at all uncommon amongst young Microscopists. With lenses of high power, and especially with those of large angular aperture, it very seldom happens that all the parts of an object, however minute and flat it may be, can be in focus together ; and hence when the focal adjustment is exactly made for one part, everything that is not in exact focus is not only more or less indistinct, but is often wrongly represented. The indistinctness of outline will sometimes present the appearance of a pellucid border, which, like the diffraction-band, may be mistaken for actual substance. But the most common error is that which is produced by the reversal of the lights and shadows resulting from the refractive powers of the object itself : thus, the bi-concavity of the blood-disks of Human (and other Mammalian) Blood occasions their centres to appear *dark* when in the focus of the Microscope, through the dispersion of the light which it occasions ; but when they are brought a little within the focus by a slight approximation

of the object-glass, the centres appear brighter than the peripheral parts of the disks (Fig. 371). An opposite reversal presents itself in the case of the markings of the *Diatomaceæ*; for these, when the surface is exactly in focus, are seen as light hexagonal areolæ separated by dark partitions (Fig. 90, A); and yet, when the surface is slightly beyond the focus, the hexagonal areolæ are dark, and the intervening partitions light (Fig. 90, B).—The experienced Microscopist, on the other hand, will find in the Optical effects produced by variations of Focal adjustment the most certain indications in regard to

the nature of such inequalities of surface as are too minute to be made apparent by the use of the Stereoscopic Binocular. For, as Welcker has pointed out,* superficial elevations must necessarily appear brightest when the distance between the

Objective and the object is increased, whilst depressions must appear brightest when that distance is diminished. And it is the application of this test to the minute markings of Diatom-valves, which most certainly indicates that they are due to hexagonal elevations.

128. A very important and very frequent source of error, which sometimes operates even on experienced Microscopists, lies in the refractive influence exerted by certain peculiarities in the internal structure of objects upon the rays of light transmitted through them; this influence being of a nature to give rise to appearances in the image, which suggest to the observer an idea of their cause that may be altogether different from the reality. Of this fallacy we have 'pregnant instance' in the misinterpretation of the nature of the lacunæ and canaliculi of Bone (Fig. 356), which were long supposed to be solid corpuscles with radiating filaments of peculiar opacity, instead of being, as is now universally admitted, minute chambers with diverging passages, excavated in the solid osseous substance. For just as the convexity of its surfaces will cause a transparent cylinder to show a bright axial band,† so will the concavity of the internal surfaces of the cavities or tubes hollowed-out in the midst of highly-refracting substances occasion a divergence of the rays passing through them, and consequently render them so dark that

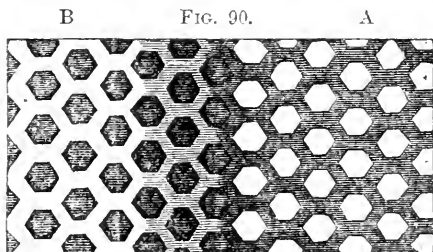

Hexagonal areolation of *Pleurosigma angulatum*, as seen in a Photograph magnified to 15,000 diameters.

* See "Quart. Journ. of Microsc. Science," Vol. vii. (1859), p. 240, and Vol. viii. (1860), p. 52.

† This was the appearance which gave rise to the erroneous notion that long prevailed amongst Microscopic observers, and still lingers in the Public mind, of the tubular structure of the Human Hair.

they are easily mistaken for opaque solids. That such is the case with the so-called 'bone-corpuscles,' is shown by the effects of the infiltration of Canada balsam through the osseous substance; for when this fills up the excavations, being nearly of the same refractive power with the bone itself, it obliterates them altogether. So, again, if a person who is unaccustomed to the use of the Microscope should chance to have his attention directed to a preparation mounted in liquid or in balsam that might chance to contain *Air-bubbles*, he will be almost certain to be so much more strongly impressed by the appearances of these than by that of the object, that his first remark will be upon the number of strange-looking black rings which he sees, and his first inquiry will be in regard to their meaning.

129. Although no experienced Microscopist could now be led astray by such obvious fallacies as those alluded to, it is necessary to notice them, as warnings to those who have still to go through the same education. The best method of learning to appreciate the class of appearances in question, is the comparison of the aspect of globules of Oil in water, with that of globules of Water in oil, or of bubbles of Air in water or Canada balsam. This comparison may be very readily made by shaking up some oil with water to which a little gum has been added, so as to form an emulsion; or by simply placing a drop of oil of turpentine and a drop of water together on a slip of glass, laying a thin-glass cover upon them, and then moving the cover several times backwards and forwards upon the slide.* Now when such a mixture is examined with a sufficiently high magnifying power, all the globules present nearly the same appearance, namely, dark margins with bright centres; but when the test of alteration of the focus is applied to them, the difference is at once revealed; for whilst the globules of Oil surrounded by water become *darker* as the object-glass is *depressed* and *lighter* as it is *raised*, those of Water surrounded by oil become *more luminous* as the object-glass is *depressed* and *darker* as it is *raised*. The reason of this lies in the fact that the high refracting power of the oil causes each of its globules to act like a double convex lens of very short focus; and as this will bring the rays which pass through it into convergence *above* the globule (*i.e.*, between the globule and the Objective), its brightest image is given when the object-glass is removed somewhat further from it than the exact focal distance of the object. On the other hand, the globule of water in oil, or the minute bubble of air in water or balsam, acts, in virtue of its inferior refractive power, like a double-concave lens; and as the rays of this diverge from a virtual focus *below* the globule (*i.e.*, between the globule and the Mirror), the

* If this latter mode be adopted, it is preferable, as suggested by the Authors of the "Micrographic Dictionary" (Introduction, p. xxxii.), to colour the oil of turpentine with alkanet, or some similar substance, for its more ready distinction.

spot of greatest luminosity will be found by causing the object glass to approach *within* the proper focus.—Now in the ‘protoplasm’ of the cells of the lower Plants, and in the ‘sarcode’ of the lower Animals, oil-particles and *vacuoles* (or void spaces) are often interspersed ; and these at first sight present so very striking a resemblance, that the inexperienced observer may well be pardoned for mistaking the ‘vacuoles’ for larger globules of a material more refractive than the gelatinous substance around them. But the difference in the effects of alterations of focus on the two sets of appearances at once serves to make evident the difference of their causes ; and this, moreover, is made obvious by the effect of oblique light, which will cause the strongest shadow to exhibit itself on opposite sides in the two cases respectively.

130. Among the sources of fallacy by which the young Microscopist is liable to be misled, one of the most curious is the *Molecular Movement* which is exhibited by the particles of nearly all bodies that are sufficiently finely divided, when suspended in water or other fluids. This movement was first observed in the fine granular particles which exist in great abundance in the contents of the Pollen-grains of plants (sometimes termed the *fovilla*), and which are set free by crushing them ; and it was imagined that they indicated the possession of some special vital endowment by these particles, analogous to that of the Spermatozoa of animals. In the year 1827, however, it was announced by Dr. Robert Brown that numerous other substances, Organic and Inorganic, when reduced to a state of equally minute division, exhibit a like movement, so that it cannot be regarded as indicative of any endowment peculiar to the fovilla-granules ; and subsequent researches have shown that there is no known exception to the rule, that such motion takes place in the particles of all substances, though some require to be more finely divided than others before they will exhibit it. Nothing is better adapted to show it than a minute portion of Gamboge, Indigo, or Carmine, rubbed up with water ; for the particles of these substances which are not dissolved, but only suspended, are of sufficiently large size to be easily distinguished with a magnifying power of 250 diameters, and are seen to be in perpetual locomotion. Their movement is chiefly of an oscillatory kind ; but they also rotate backwards and forwards upon their axes, and they gradually change their places in the field of view. It may be observed that the movement of the smallest particles is the most energetic, and that the largest are quite motionless, whilst those of intermediate size move but with comparative inertness. The movement is not due (as some have imagined) to evaporation of the liquid ; for it continues, without the least abatement of energy, in a drop of aqueous fluid that is completely surrounded by oil, and is therefore cut off from all possibility of evaporation : and it has been known to continue for many years in a small quantity of fluid enclosed between two glasses in an air-tight case. It is,

however, greatly accelerated, and rendered more energetic, by Heat; and this seems to show that it is due, either directly to some calorical changes continually taking place in the fluid, or to some obscure chemical action between the solid particles and the fluid which is indirectly promoted by heat. It is curious that the closer the conformity between the specific gravity of the solid particles and that of the liquid, the less minute need be that reduction in their size which is a necessary condition of their movement; and it is from this that the substances just named are so favourable for the exhibition of it. On the other hand, the particles of Metals, which are from seven to twelve times as heavy as water, require to be reduced to a minuteness many times greater than that of the particles of carmine or gamboge, before they become subject to this curious action. In any case in which the motions of very minute particles, of whatever kind, are in question, it is necessary to make allowance for this 'molecular movement;' and the young Microscopist will therefore do well to familiarize himself with its ordinary characters, by the careful observation of it in such cases as those just named, and in any others in which he may meet with it.

131. *Comparative Values of Object-Glasses; Test-Objects.*— In estimating the comparative values of different Object-glasses, regard must always be had to the *purpose* for which each is designed; since it is impossible to construct a combination which shall be equally serviceable for *every* requirement. It is commonly assumed that an Objective which will show certain *Test-objects* must be very superior for everything else to a glass which will not show these; but this is known to every practical Microscopist to be a great mistake,—the qualities which enable it to resolve the more difficult 'tests' not being by any means identical with those which make it most useful in all the ordinary purposes of Scientific investigation. Four distinct attributes have to be specially considered in judging of the character of an Object-glass, viz.—(1) its *defining power*, or power of giving a clear and distinct image of all well-marked features of an object, especially of its boundaries; (2) its *penetrating power*, or *focal depth*, by which the observer is enabled to *look into* the structure of objects; (3) its *resolving power*, by which it enables closely-approximated markings to be distinguished; and (4) the *flatness of the field* which it gives.

1. The 'Defining power' of an Objective mainly depends upon the *completeness of its corrections*, both for Spherical and for Chromatic aberration (§§ 9-15); and it is an attribute essential to the satisfactory performance of *any* Objective, whatever be its other qualities. Good definition may be more easily obtained with lenses of *small* or *moderate* than with lenses of *large* angular aperture; and in the aim to extend the aperture, the perfection of the definition is not unfrequently impaired. An experienced

Microscopist will judge of the defining power of a lens by the quality of the image which it gives of almost any object with which he may be familiar; but there are certain 'tests,' to be presently described, which are particularly appropriate for the determination of it. Any imperfection in Defining power is exaggerated, as already pointed out (§§ 22, 110), by the use of deep Eye-pieces; so that, in determining the value of an Objective, it is by no means sufficient to estimate its performance under a low Eye-piece, an image which appears tolerably clear when moderately magnified being often found exceedingly deficient in sharpness when more highly amplified. The use of the Draw-Tube (§ 63) affords an additional means of testing the Defining power; but this cannot be fairly had recourse to, unless an alteration be made in the adjustment for the thickness of the glass that covers the object (§ 113), in proportion to the nearer approximation of the object to the Objective which the lengthening of the body involves.

ii. The Penetrating power or Focal Depth of an Object-glass (good definition being of course presupposed) mainly depends upon the degree of distinctness with which parts of the object that are *a little out of focus* can be discerned; and this will be found to vary greatly in different Objectives, being, within certain limits, in an *inverse* proportion to the extent of the Angle of Aperture* (§ 10), as can be easily proved on Optical principles.† Hence an Objective of comparatively limited angular aperture may enable the observer to gain a view of *the whole* of an object, the several parts of whose structure lie at different distances from it, sufficiently good to afford an adequate idea of the relation of those parts to each other; whilst if the same object be looked at with

* As the young Microscopist may be perplexed by the fact that an Objective having a large *actual* aperture may have but a small *angular* aperture, and that the lenses of largest *angular* aperture may be those of the smallest *actual* aperture, it may be well to recall his attention to Fig. 10; from which he will see that the Angle of aperture abc depends on the *actual* aperture of the Objective, and the distance of the object (when in focus) from its front lens, conjointly. Hence two Objectives may have the same *actual* aperture, and yet one may have a much larger *angular* aperture than the other, because the focal distance of the object is less. On the other hand, two lenses may have the same *angular* aperture, yet the *actual* aperture of one shall be much greater than that of the other, the focal distance of the object being greater. And thus, as a general rule, Objectives of low power or long focal distance have the largest *actual* apertures; whilst those of high power or short focus have the largest *angular* apertures. If the *focal distance* be constant, the *angular* aperture will increase or diminish with the *actual* aperture; whilst, if the *actual* aperture be constant, the *angular* aperture will increase with the shortening of the *focal distance*, and will decrease with its elongation.

† Thus the Portrait-lens of a Photographic Camera having a large angle of aperture, is quite unsuitable for Landscape purposes; and the greater the range of distances it is desired to obtain in a photographic picture (as, for example, in taking the interior of a long Sculpture Gallery, or a Landscape with near fore-ground and remote back-ground), the more must the aperture of the lens be reduced by 'stops.'

an Objective of very wide angle of aperture, which only enables what is *precisely* in focus to be seen at all, each part can only be *separately* discerned, and the mutual relations of the whole cannot be brought into view. The want of this Focal Depth is a serious drawback in the performance of many Objectives which are distinguished by the possession of other admirable qualities. The possession of a high measure of it is so essential, in the Author's opinion, to the satisfactory performance of those Objectives which are to be employed for the *general purposes of Scientific investigation*, that he cannot consider its deficiency to be compensated by the possession of any degree of the Resolving power, whose use is comparatively limited. The value of Penetrating power is especially felt when the Binocular arrangement is employed; since the assistance which it is able to give in the estimation of the *solid forms* of objects is in great degree neutralized by the employment of Objectives of such wide angular aperture as not to show any part of the object distinctly save what is precisely in focus; whilst, in addition, those forms are untruly represented through the *exaggeration* of projection occasioned by the too great dissimilarity of the pictures received through the two halves of the Objective (§ 30). And the Author has found that all who have made much use of this instrument are now come to an agreement as to the superior value of Objectives of a moderate, or even a comparatively small, Angle of Aperture for ordinary working purposes; the special utility of the very wide apertures being limited to particular classes of objects.

III. The 'Resolving power,' by which very minute markings—whether lines, striæ, or dots—are discerned and clearly separated from each other, may be said to stand in direct relation (a perfect definition* being presupposed) to the extent of its Angle of

* Of the various modes which have been proposed for measuring the *Angle of Aperture* of Microscopic Object-glasses, the following is one of the simplest and most convenient:—The Microscope is to be placed perpendicularly on a table covered with dark cloth, and is to be used after the manner of a diminishing Telescope, the ordinary Eye-piece being removed, and a common pocket or watchmaker's hand-glass of two or three inches focal length being held at such a distance from the Objective as to give a distinct image of objects lying on the surface of the table. A strip of white cardboard or paper is then to be laid on either side of the centre of the field of view, and to be gradually moved outwards until its edge is just vanishing; then if lines be drawn from the centre of the front glass of the Objective to the inner edges of these strips, the angle included between them will be that of the aperture of the Object-glass; and it may be either measured by an ordinary graduated scale or protractor, so held that its straight edge shall be parallel to the table, whilst the central point of that edge shall coincide with the centre of the front lens of the Objective; or it may be calculated by dividing half the horizontal distance between the cardboard edges by the vertical distance of the Objective from the table, and finding in a table of Natural Tangents the angle corresponding to the product, which, when doubled, will be the Angle of Aperture. This is the true *available* angle for the formation of distinct images; and will be found in many cases considerably less than the *angle of admission of diffused light*.

Aperture, that is, to the obliquity of the rays which it can receive from the several points of the surface of the object. This is not so much the case where the markings depend upon the interposition of opaque and semi-opaque particles in the midst of a transparent substance, so that the lights and shadows of the image represent the absolute degrees of greater or less transparence in its several parts; as it is where, the whole substance being equally transparent, the markings are due to the refracting influence which inequalities of the surface exert upon the course of the rays that pass through it (§ 27). It may be readily perceived, on a little reflection, that the information given about such inequalities by rays of light transmitted axially through the object must be very inferior to that which can be gained from rays of light transmitted obliquely; and thus it happens that, as already explained (§§ 119, 120), many such markings are seen by Oblique illumination, which could not be seen under the same Object-glass by light transmitted more nearly in the axis of the Microscope. When an object, however, is seen by *transmitted* light, no degree of obliquity in the illuminating rays can be useful, which exceeds that at which the Object-glass can receive them; but the illumination of objects which are seen by *radiated* light (§ 86) depends upon these very rays; and thus it is that the 'black-ground' illumination by the Paraboloid or by any other effective contrivance (§ 85) will often bring surface-markings into view, which cannot be seen by transmitted light. An Object-glass of very wide aperture, however, will receive, even with axial illumination, so many rays of great obliquity, that the same kind of effect will be produced as by oblique illumination with an Objective of smaller aperture; but when oblique illumination is used with the former, a greater resolving power is obtained than the latter *can* afford. In comparing the Resolving power of different Object-glasses, it is obviously essential to a correct judgment that the illumination should be the same; for it will often happen that an observer who knows the 'points' of his own instrument will 'bring-out' tests which another does not resolve with Object-glasses of much greater capability, simply for want of proper management. Moreover, it must be borne in mind that great Resolving power may exist, even though the definition may be far from exact; since the former depends more upon Angle of Aperture than upon the perfection of the corrections: and yet there cannot be the slightest question that, of two Objectives of the same focal length, one perfectly corrected up to a moderate angle of aperture, the other with a wider aperture but less perfectly corrected, the former will be the one most suitable to the *general* purposes of the Microscopist.

iv. The 'Flatness of the field' afforded by the Object-glass is a condition of great importance to the advantageous use of the Microscope, since the real extent of the field of view practically

depends upon it. Many Objectives are so constructed that, even with a perfectly flat object, the foci of the central and of the peripheral parts of the field are so different, that when the adjustment is made for one, the other is entirely indistinct. Hence, when the central portion is being looked at, no more information is gained respecting the peripheral than if it had been altogether stopped out. With a really good Object-glass, not only should the image be distinct even to the margin of the field, but the marginal portion should be as free from Chromatic fringes as the central portion. In many Microscopes of inferior construction, the imperfection of the Objectives in this respect is masked by the contraction of the aperture of the diaphragm in the Eye-piece (§ 21), which limits the dimensions of the field; and the performance of one Objective within this limit may scarcely be distinguishable from that of another, although, if the two were compared under an Eye-piece of larger aperture, their difference of excellence would be at once made apparent by the perfect correctness of one to the margin of the field, and by the entire failure of the other in every part save its centre. In estimating the relative merits of two lenses, therefore, as regards this condition, the comparison should of course be made under the same Eye-piece.

v. It may be safely affirmed that the *most perfect* Object-glass is that which combines *all* the preceding attributes in the highest degree in which they are compatible one with another. But, as has just been shown, two of the most important—namely, Penetrating power and Resolving power—stand in such opposite relations to the Angular Aperture, that the highest degree of which each is in itself capable can only be attained by some sacrifice of the other; and, therefore, of two Objectives which are respectively characterized by the predominance of these opposite qualities, one or the other will be preferred by the Microscopist, according to the particular class of researches which he may be carrying on; just as a man who is about to purchase a horse will be guided in his choice by the kind of work for which he destines the animal. Hence it shows, in the Author's estimation, just as limited an appreciation of the practical applications of the instrument, to estimate the merits of an Object-glass by its capability of showing certain lined or dotted Tests, without any reference to its penetrating or defining power, as it would be to estimate the merits of a Horse *merely* by the number of seconds within which he could run a mile, or by the number of pounds he could draw; without any reference, in the first case, either to the weight he could carry or the length of time during which he could maintain his speed, and in the second case, either to the rate of his draught or his power of continuing the exertion. The greatest capacity for *speed* alone, the power of sustaining it not being required, and burthen being reduced almost to nothing, is that which is sought in the Racer; the greatest *power of steady draught*, the rate of move-

ment being of comparatively little importance, is that which is most valued in the Cart-horse ; but for the ordinary Carriage-horse or Roadster, the highest merit lies in such a *combination* of speed and power with endurance, as cannot co-exist with the greatest perfection in either of the two first.—The Author feels it the more important that he should express himself clearly and strongly on this subject, as there is a great tendency at present, both among amateur Microscopists and among Opticians, to look at the attainment of that Resolving power which is given by Angular aperture as the one thing needful, those other attributes which are of far more importance in almost every kind of Scientific investigation being comparatively little thought of. It is neither the *only* nor yet the *chief* work of the Microscope (as some appear to suppose) to resolve the markings of the siliceous valves of the *Diatomaceæ* ; in fact the interest which attaches to observations of this class *per se* is of an extremely limited range. If one-tenth of the attention which these objects have received, had been devoted to the careful study of the Life-history of the tribe of Plants which furnishes them, it cannot be doubted that great benefit would have accrued to Physiological Science.* And the more carefully we look into the history of those contributions to our knowledge which have done most to establish the value of the Microscope as an instrument of scientific research, the more clear does it become that for almost every purpose *except* the resolution of the Diatom-tests, Objectives of *moderate* Angular Aperture are to be decidedly preferred.

132. *Test-Objects*.—It is usual to judge of the optical perfection of a Microscope by its capacity for exhibiting certain objects, which are regarded as *Tests* of the merits of its Object-glasses ; these tests being of various degrees of difficulty, and that being accounted the best instrument which shows the most difficult of such tests. Now it must be borne in mind that only *two* out of the four qualities which have been just enumerated—namely, *Defining* power and *Resolving* power—can be estimated by any of these tests ; and the greater number of them, being objects whose surface is marked by lines, striæ, or dots, are tests of *Resolving* power, and thus of Angular Aperture only. Hence, as already shown, an Objective may show very difficult *test-objects*, and yet may be very unfit for ordinary use. Moreover, these Test-objects are only suitable to Object-glasses of very short focus and high magnifying power ; whereas the greater part of the real *work* of the Microscope is done with Objectives of low and medium power ; and the enlargement of the Angular Aperture, which enables even these to resolve (under deep Eye-pieces) many objects which were

* The discovery of the *conjugation* of the *Diatomaceæ* (Fig. 122) by Mr. Thwaites was made by means of an instrument certainly not superior to the "Society of Arts Educational Microscope" (Fig. 31).

formerly considered adequate tests for higher powers, is for ordinary purposes rather injurious than beneficial. In estimating the value of an Object-glass, it should always be considered *for what purpose it is intended*; and its merits should be judged of according to the degree in which it fulfils that purpose. We shall therefore consider what are the attributes proper to the several 'powers' of Object-glasses—*low, medium, and high*; and what are the objects by its mode of exhibiting which it may be fairly judged.

1. By Object-glasses of *low* power we may understand any whose focal length is *greater than half-an-inch*. The 'powers' usually made in this country are known as 3 inch, 2 inch, $1\frac{1}{2}$ inch, 1 inch, and 2-3rds inch focus; and they give a range of amplification of from 13 to 60 diameters with the A eye-piece, and of from 20 to 90 diameters with the B eye-piece. These are the Objectives which are most used in the examination of Opaque objects, and of Transparent objects of large size and of comparatively coarse texture; and the qualities most desirable in them are a sufficiently large Aperture to give a *bright* image, combined with such accurate Definition as to give a *clear* image, with Focal Depth sufficient to prevent any moderate inequalities of surface from seriously interfering with the distinctness of the entire picture, and with perfect flatness of the image when the object itself is flat. For the 3 inch, 2 inch, or $1\frac{1}{2}$ inch Objectives,* no ground of judgment is better than the manner in which it shows such an injected preparation as the interior of a Frog's Lung (Fig. 387) or a portion of the villous coat of the Monkey's Intestine (Fig. 384); for the aperture ought to be sufficient to give a bright image of such objects by ordinary daylight, without the use of any illuminator; the border of every vessel should be clearly defined, without any thickness or blackness of edge; every part of such an object that comes within the field should be capable of being made out when the focal adjustment is adapted for any other part; whilst, by making that adjustment a medium one, the whole should be seen without any marked indistinctness. If the aperture be too small, the image will be dark; if it be too large, details are brought into view (such as the separateness of the particles of the vermilion injection) which it is of no advantage to see, whilst, through the sacrifice of penetration, those parts of the object which are brought exactly into focus being seen with over-minuteness, the remainder are enveloped in a thick fog through which even their general contour can scarcely be seen to loom; and if the corrections be imperfectly made, no line or edge will be seen with perfect sharpness. For *Defining* power, the Author has found the Pollen-grains of the

* These are ordinarily composed of *two pairs* of lenses only, as the corrections can be adequately made by this combination for an Angular Aperture of 20° , which is the largest that is found practically useful for the $1\frac{1}{2}$ inch. (See p. 161, *note*.)

Hollyhock or any other flower of the *Mallow* kind (Fig. 230, A) viewed as an Opaque object, a very good test; the minute spines with which they are beset being but dimly seen with any save a good Object-glass of these long foci, and being really-well exhibited only by adding such power to the Eye-piece as will exaggerate any want of definition on the part of an inferior lens. For Flatness of field no test is better than a section of Wood (Plate XII.), or a large Echinus-spine (Fig. 289), under an Eye-piece that will give a field of the diameter of from 9 to 12 inches. The general performance of Object-glasses of 1 inch and 2-3rds inch focus may be partly judged-of by the manner in which they show such injections as those of the Gill of the Eel (Fig. 386), or of the Bird's Lung (Fig. 388), which require a higher magnifying power for their resolution than those previously named; still better, perhaps, by the mode in which they exhibit a portion of the wing of some Lepidopterous Insect having well-marked scales. The same qualities should here be looked-for, as in the case of the lowest powers; and a want of either of them is to be distinguished in a similar manner. The increase of Angular Aperture which these Objectives may advantageously receive up to 30° , should render them capable of resolving all the easier 'test' scales of Lepidoptera, such as those of the *Morpho menelaus* (Fig. 334), in which, with the B eye-piece, they should show the transverse as well as the longitudinal markings. The Tongue of the common Fly (Fig. 350) is one of the best transparent objects for enabling a practised eye to estimate the general performance of Object-glasses of these powers; since it is only under a really good lens that all the details of its structure can be well shown; so that an Objective which shows *this* well may be trusted to for any other object of its kind. For flatness of field sections of small Echinus-spines (Plate II., fig. 1) are very good tests. The exactness of the corrections in lenses of these foci may be judged of by the examination of objects which are almost sure to exhibit Colour if the correction be otherwise than perfect. This is the case, for example, with the Glandulæ of Coniferous wood (Fig. 210), the centres of which ought to be clearly defined under such Objectives, and ought to be quite free from colour; and also with the Tracheæ of Insects (Fig. 347), the spires of which ought to be distinctly separated from each other without any appearance of intervening Chromatic fringes.

II. We may consider as Object-glasses of *medium* power the Half-inch, 4-10ths-inch, 1-4th-inch, and 1-5th-inch; the magnifying power of which ranges from about 90 to 250 diameters under the A eye-piece, and from about 150 to 400 diameters with the B eye-piece. These can only be advantageously employed in the examination of Opaque objects, when they are of unusual minuteness; but their great value lies in the information they enable us to obtain regarding the details of Organized structures and of living actions, by the examination of properly-prepared *trans-*

parent objects by transmitted light. It is to these Objectives that the remarks already made respecting Angular Aperture (§ 107, v.) especially apply; since it is in them that the greatest difference exists between the ordinary requirements of the Scientific investigator, and the special needs of those who devote themselves to the particular classes of objects for which the greatest Resolving power is required. A moderate amount of such power is essential to the value of every Objective within the above-named range of foci: thus, even a good Half-inch should enable the markings of the larger scales of the *Polyommatus argus* (Azure-blue Butterfly) to be well distinguished, these being of the same kind with those of the Menelaus, but more delicate, and should clearly separate the dots of the small or 'battledoor' scales (Fig. 335) of the same insect, which, if unresolved, are seen as coarse longitudinal lines; a good 4-10ths inch should resolve the larger scales of the *Podura* (Plate II., fig. 2) without difficulty; and a good 1-4th or 1-5th-inch should bring out the markings on the smaller scales of the *Podura*, and should resolve the markings on the *Pleurosigma hippocampus* into longitudinal and oblique lines. Even the Half-inch or the 4-10ths inch may be made with angles of aperture sufficiently wide to resolve the objects named as fair tests for the powers above them; but for the reasons already stated, the Author thinks it most undesirable that they should thus be forced up to the work altogether unsuited to their powers, by a sacrifice of those very qualities which constitute their special value in the study of the objects whereon they can be most appropriately and effectively employed. And he is decidedly of opinion that an angular aperture of 50° is as great as should be given to a Half-inch, 60° to a 4-10ths inch, and 90° to a 1-4th inch, that are destined for the ordinary purposes of Scientific investigation; whilst his own experience would lead him to prefer an angle of 40° for the Half-inch (§ 30), and of 75° for the 1-4th inch, provided the corrections are perfect.* Objectives of these apertures should show the easier Tests first enumerated with perfect Definition, a fair amount of Penetrating power, and complete Flatness of field. No single object is so useful as the *Podura-scale* for the purpose of testing these qualities in a 1-4th inch or 1-5th inch Objective; and it may be safely said that a lens which brings out its markings satisfactorily will suit the requirements of the ordinary working Microscopist, although it may not resolve any but the easiest Diatoms. In every case the Objective should be tried with the B and C as well as with the A eye-piece; and the effect of this substitution will be a fair test of its merits. Where markings are undistinguishable under a certain Objective merely because of their

* The Author feels it due to Mr. Wheeler, who has specially applied himself to carry out his views on this point, to state that the Half and Quarter-inch constructed by him of the apertures above named are at the same time of excellent quality and very moderate price.

minuteness or their too close approximation, they may be enlarged or separated by a deeper Eye-piece, provided that the Objective be well corrected. But if, in such a case, the image be darkened or blurred, so as to be rather deteriorated than improved, it may be concluded that the Objective is of inferior quality, having either an insufficient Angular Aperture, or being imperfectly corrected, or both.

III. All Object-glasses of less than 1-5th inch focus may be classed as *high* powers ; the focal lengths to which they are ordinarily constructed are 1-6th, 1-8th, 1-12th, 1-16th, 1-20th, and 1-25th of an inch respectively ; the 1-16th and 1-25th being made by Messrs. Powell and Lealand only, and the 1-20th by Messrs. Smith and Beck ; and the magnifying powers they are fitted to afford range from about 320 to 1200 diameters with the shallower Eye-piece, and from 480 to 1800 diameters with the deeper. By the use of still deeper Eye-pieces, or by the Objective of 1-50th inch recently constructed by Messrs. Powell and Lealand, a power of 3500 or more may be obtained ; but it is questionable whether anything is really gained thereby. Moreover, as the 1-12th inch Objective may have its angular aperture extended to 170° , the utmost limit compatible with the reception of rays from any object (§ 14), nothing is gained in this respect by a reduction of the focal distance ; and the admirable 1-12th now constructed by Mr. Ross may be made to give an amplification equal to that of the 1-25th of Messrs. Powell and Lealand, with little if any inferiority in defining and resolving powers. The use of this class of Objectives is much more restricted than that of the preceding. They are not suitable for the *ordinary* purposes of Scientific investigation ; and their value chiefly lies in the power which they afford of tracing out certain points of minute structure which the Objectives of medium power may only doubtfully indicate, and of exhibiting certain classes of very difficult striated or dotted objects which these cannot resolve. Hence it is obvious that with regard to Object-glasses of *this* class, Resolving power (coupled with Defining power) is the highest requisite, Penetrating power and Flatness of field being of secondary account ; and that the value of an Objective may *here* be fairly estimated by its angular aperture, provided that its aberrations be exactly corrected. Of Angular Aperture and Definition very good tests are afforded by the lines artificially ruled by M. Nobert, and by the more 'difficult' species of Diatomaceæ. What is known as *Nobert's Test* is a plate of glass, on a small space of which, not exceeding one-fiftieth of an inch in breadth, are ruled ten or more series of lines, forming as many separate bands of equal breadth. In each of these bands the lines are ruled at a certain known distance ; and the distances are so adjusted in the successive bands, as to form a regularly diminishing series, and thus to present a succession of tests of progressively increasing difficulty. The distances of the lines differ on different

plates; all the bands in some series being resolvable under a good Objective of 1-4th inch focus, whilst the closest bands in others defy the resolving power of a 1-12th inch Objective of large aperture. The most recent of these Test-plates have nineteen bands; and their lines are ruled at the following distances, expressed in parts of a Paris Line, which is to an English Inch as 0·88 to 1·000, or as 11 to 125.

Band 1.	1-1000th.	Band 11.	1-6000th.
„ 2.	1-1500th.	„ 12.	1-6500th.
„ 3.	1-2000th.	„ 13.	1-7000th.
„ 4.	1-2500th.	„ 14.	1-7500th.
„ 5.	1-3000th.	„ 15.	1-8000th.
„ 6.	1-3500th.	„ 16.	1-8500th.
„ 7.	1-4000th.	„ 17.	1-9000th.
„ 8.	1-4500th.	„ 18.	1-9500th.
„ 9.	1-5000th.	„ 19.	1-10000th.
„ 10.	1-5500th.		

It is stated* that these lines have been resolved by Hartnack's immersion-system No. 10, and oblique light, as far as the *fifteenth* band, in which the distance of the lines is about 1-91,000th of an inch. The existence of separate lines at a still narrower interval than this, is a matter of *faith* rather than of *sight*; but there can be no reasonable doubt that the lines do exist; and the resolution of them would evince the extraordinary superiority of any Objective or system of Illumination which should enable them to be clearly distinguished. The mathematical certainty with which the degree of approximation of these lines may be ascertained, and the regular gradation of the series which they present, gives to M. Nobert's Test-plate a very high value for the determination of the relative merits of different Objectives, of that class, at least, in which Angular Aperture and Definition are of the first importance.—The value of the minuter *Diatomaceæ*, as furnishing in their surface-markings admirable Test-objects for the highest powers of the Microscope, was first made known by Messrs. Harrison and Sollitt, of Hull, in 1841; and it cannot be questioned that this discovery has largely contributed to the success of the endeavours which have since been so effectually made, to perfect this class of Objectives, and to find out new methods of using them to the best advantage. The nature of these markings will be discussed hereafter (§ 216); and it will be sufficient in this place to give a table of the average distances of the transverse or diagonal lineation of different species, which will serve to indicate their respective degrees of difficulty as 'tests.' The greater part of those which are now in use for this purpose, are comprehended in the genus *Pleurosigma* of Prof. W. Smith; which includes those

* See Schultze's "Archiv für Mikroskopische Anatomie," Band i., p. 305.—Prof. Schultze considers the most difficult specimens of *Pleurosigma angulatum* to correspond with the 8th or 9th bands of this Test-plate, and the larger specimens with the 7th.

Naviculæ whose 'frustules' are distinguished by their sigmoid (S-like) curvature (Fig. 120).

	Direction of Striæ.	Striæ in 1-1000th of an inch.	
		SMITH.	SOLLITT.
1. <i>Pleurosigma formosum</i> ...	diagonal	34	32 — 20
2. ————— strigile ...	transverse	36	30
3. ————— Balticum ...	transverse	38	40 — 20
4. ————— attenuatum ...	transverse	40	46 — 35
5. ————— hippocampus ...	transverse	40	45 — 40
6. ————— strigosum ...	diagonal	44	80 — 40
7. ————— quadratum ...	diagonal	45	60 — 35
8. ————— elongatum ...	diagonal	48	
9. ————— lacustre ...	transverse	48	
10. ————— angulatum ...	diagonal	52	51 — 46
11. ————— æstuarii ...	diagonal	54	
12. ————— fasciola ...	transverse	64	90 — 50
13. <i>Navicula rhomboides</i> ...	transverse	85	111 — 60
14. <i>Nitzschia sigmoidea</i> ...	transverse	85	
15. <i>Amphipleura pellucida</i> ...	transverse	130 — 120

(*Navicula acus*)

The first column of measurements in the above table gives the number stated by Prof. W. Smith as *averages*; the second column gives the numbers more recently assigned as the *extremes* by Mr. Sollitt,* who has pointed out that great differences exist in

* 'On the Measurement of the Striæ of Diatoms,' in "Quart. Journ. of Microsc. Science," Vol. viii. 1860, p. 48. Mr. Sollitt remarks of *P. fasciola*, *P. strigosum*, *Nitzschia sigmoidea*, and *Navicula rhomboides*, that individual specimens often have the striæ so fine as to defy all means of resolving them. On the other hand, it is asserted by Mr. Hendry ("Quart. Journ. of Microsc. Science," Vol. i. N.S. 1861, p. 231, that the striæ of *N. rhomboides* range between 30 and 50 in 1-1000th of an inch. It is in regard to *Amphipleura pellucida*, however, that the greatest difference of opinion exists. By Mr. Hendry it is affirmed ("Quart. Journ. of Microsc. Science," Vol. viii. 1860, p. 208; and Vol. i. N.S. 1861, p. 87), that the number of its striæ ranges as low as 34, and that many specimens present 60, 70, and 80 in 1-1000th of an inch; so that in some individuals the striation may be resolved with a 1-5th, a 1-4th, a 4-10ths, or even a Half-inch Objective, whilst in others it requires the 1-8th, or even higher powers. On the other hand, Messrs. Sullivant and Wormley ("Silliman's American Journal," Jan., 1861, and "Quart. Journ. of Microsc. Science," Vol. i. N.S. 1861, p. 112), question the reality of any real striation in this species, and altogether dispute the possibility of discerning striæ whose distance is no more than 1-130,000th of an inch; pointing out with reference both to the Diatom-tests and Nobert's Test-plate, that when the resolving power of an Objective is near its limit, 'spectral' or 'spurious' lines are to be seen, only to be distinguished from the true by a practised eye. "The testimony of our Objectives, as we understand it, seems to indicate that this Diatom has a minutely and irregularly broken-up surface, which even on the same valve can be made to show an apparent striation, varying from moderately coarse to extremely fine, according to the obliquity or intensity of the illumination, and to the grade, whether low or high, of the Objective used, thus proving beyond all question that the exhibition is illusory. In numerous trials, particularly on fine English specimens from Hull, we have entirely failed, with glasses, too, of unsurpassed excellence, to bring out regular, distinct, and unmistakable striæ, such as would be at once so recognized by an eye practised

the fineness of the markings of specimens of the same species obtained from different localities,—a statement now so abundantly confirmed as to be entitled to rank as an established fact. Of the first ten of the foregoing, good specimens may be resolved, with judicious management, by good 1-4th or 1-5th inch Objectives, and

FIG. 91.

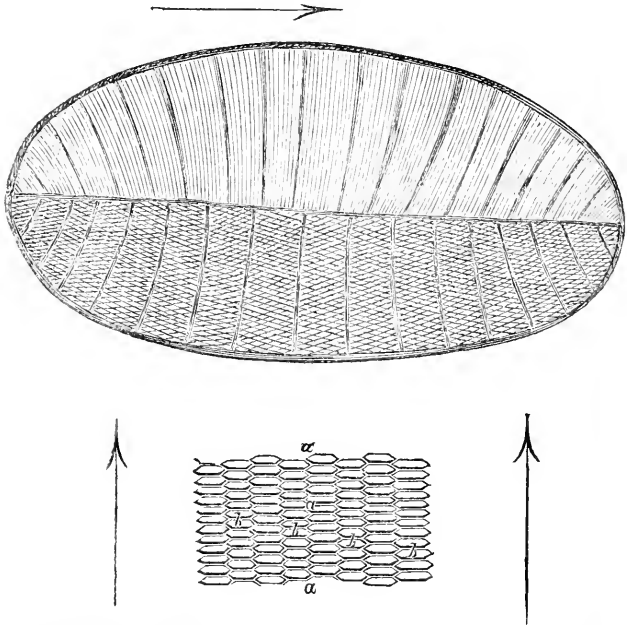

Valve of *Sarrella gemma*, with portion more highly magnified, showing two systems of markings *a* and *b*.

even, with very Oblique illumination, by Objectives of half and 4-10ths inch, having an angular aperture of 90° ; the remainder require the 1-8th or 1-12th inch for the satisfactory exhibition of their markings. Several very difficult tests of this description have been furnished by the late Prof. Bailey* of West Point (U.S.),

on the striæ of other Diatoms." Having himself (through the kindness of Mr. Lobb) seen "regular, distinct, and unmistakable striæ" in this Diatom, the Author cannot but believe in their existence, notwithstanding the failure of the American observers. He has not been able to satisfy himself, however, of the correctness of Mr. Sollitt's estimate of the distance of the striæ, and is still disposed to regard it as too high.

* See his interesting Memoirs in Vols. ii. and vii. of the "Smithsonian Contributions to Knowledge." On *Hyalodiscus subtilis*, see Hendry, in "Quart. Journ. of Microsc. Science," Vol. i. N.S. (1861), p. 179.

among them the very beautiful *Grammatophora subtilissima* and the *Hyalodiscus subtilis*; the latter being of discoid form, and having markings which radiate in all directions, very much like those of an engine-turned watch. To these may be added the *Surirella gemma*, of which the structure has been elucidated by M. Hartnack. When the valve of this species (Fig. 91) is examined under very oblique illumination in the direction of its length, and with an amplification sufficient for the resolution of the marginal lines of the *Grammatophora subtilissima*, a series of strongly marked transverse ribs is seen, the spaces between which are divided by parallel lines, as shown in the *upper* half of the figure. When, on the other hand, the valve is illuminated in a direction transverse to its axis, the spaces between the ribs seem to be divided by lines which cut each other very obliquely, so as to form elongated hexagons by their intersection, as shown in the *lower* half of the figure. A portion more highly magnified under the same illumination shows the hexagons separated by the zigzag lines *a a*, which are connected by the transverse lines *b b*.

133. *Determination of Magnifying Power.*—The last subject to be here adverted-to is the mode of estimating the magnifying power of Microscopes, or, in other words, the number of times that any object is magnified. This will of course depend upon a comparison of the *real* size of the Object with the *apparent* size of the Image; but our estimate of the latter will depend upon the distance at which we assume it to be seen; since, if it be projected at different distances from the Eye, it will present very different dimensions. Opticians generally, however, have agreed to consider *ten inches* as the standard of comparison; and when, therefore, an object is said to be magnified 100 diameters, it is meant that its visual image projected at 10 inches from the Eye (as when thrown down by the Camera Lucida, § 71, upon a surface at that distance beneath), has 100 times the actual dimensions of the object. The measurement of the magnifying power of Simple or Compound Microscopes by this standard is attended with no difficulty. All that is required is a Stage-Micrometer accurately divided to a small fraction of an inch (the 1-100th will answer very well for low powers, the 1-1000th for high), and a common foot-rule divided to tenths of an inch. The Micrometer being adjusted to the focus of the Objective, the rule is held parallel with it at the distance of ten inches from the eye. If the second eye be then opened whilst the other is looking through the Microscope, the circle of light included within the field of view crossed by the lines of the Micrometer will be seen faintly projected upon the rule; and it will be very easy to mark upon the latter the apparent distances of the divisions on the Micrometer, and thence to ascertain the magnifying power. Thus, supposing each of the divisions of 1-100th of an inch to correspond with $1\frac{1}{2}$ inch upon the rule, the linear magnifying power is 150 diameters; if it correspond with half an inch, the magnifying

power is 50 diameters. If, again, each of the divisions of the 1-1000th inch Micrometer correspond to 6-10ths of an inch upon the rule, the magnifying power is 600 diameters; and if it correspond to 1·2 inches, the magnifying power is 1200 diameters. In this mode of measurement the estimate of *parts* of tenths on the rule can only be made by guess; but greater accuracy may be obtained by the use of the Diagonal scale, or, still better, by projecting the Micrometer-scale with the Camera Lucida at the distance of ten inches from the eye, marking the intervals on paper, taking an average of these, and repeating this with the compasses ten times along the inch-scale. Thus, if the space given by one of the divisions of the 1-1000th-inch Micrometer, repeated ten times along the rule, amounts to 6 inches and $2\frac{1}{2}$ tenths, the value of each division will be $\cdot625$ of an inch, and the magnifying power 625.—It is very important, whenever a high degree of accuracy is aimed at in Micrometry, to bear in mind the caution already given (§ 68) in regard to the difference in magnifying power produced in the adjustment of the Objective to the thickness of the glass that covers the object.*—The *superficial* Magnifying power is of course estimated by *squaring* the linear; but this is a mode of statement never adopted by Scientific observers, although often employed to excite popular admiration, or to attract customers, by those whose interest is concerned in doing so. †

* See Hendry 'On *Amphipleura pellucida*,' in "Quart. Journ. o Microsc. Science," Vol. i. N.S. (1861), p. 87.

† It may be well here to remark, that the designations given by Opticians to their Objectives are often far from representing their real focal length, as estimated by that of single lenses of equivalent magnifying power (§ 111); a temptation to *underrate* them being afforded by the consideration that if an Objective of a certain focus will show a Test-object as well as another of higher focus, the former is to be preferred. Thus it happens that what are sold as half-inch Objectives are often more nearly 4-10ths; and that what are sold as 1-4ths are not unfrequently more really 1-5ths.

ADDENDUM.—Since this chapter has been put in type, Mr. Ross has brought out an Achromatic Objective of *four inches* focus; which will prove of great service to those who study large Opaque objects, whose inequality of surface demands great focal depth or penetrating power.

CHAPTER V.

PREPARATION, MOUNTING, AND COLLECTION OF OBJECTS.

UNDER this head it is intended to give such *general* directions respecting the preparation, mounting, and collection of Objects, as will supersede the necessity of frequent repetition when each particular class is described; and also to enumerate the materials and appliances which will be required or found advantageous.

Section 1. *Preparation of Objects.*

134. *Microscopic Dissection.*—The separation of the different parts of an Animal or Vegetable structure by dissection, so as to prepare any portion for being minutely examined under the Microscope, should be accomplished, so far as may be found practicable, with the naked eye; but the best mode of doing this will depend in great degree upon the size and character of the object. Generally speaking, it will be found advantageous to carry on the dissection under Water, with which Alcohol should be mingled where the substance has been long immersed in spirit. The size and depth of the vessel should be proportioned to the dimensions of the object to be dissected; since, for the ready access of the hands and dissecting-instruments, it is convenient that the object should neither be far from its walls, nor lie under any great depth of water. Where there is no occasion that the bottom of the vessel should be transparent, no kind of Dissecting Trough is more convenient than that which every one may readily make for himself, of any dimensions he may desire, by taking a piece of sheet Gutta-Percha of adequate size and stoutness, warming it sufficiently to render it flexible, and then turning-up its four sides, drawing-out each corner into a sort of spout, which serves to pour away its contents when it needs emptying. The dark colour of this substance enables it to furnish a back-ground, which assists the observer in distinguishing delicate membranes, fibres, &c., especially when magnifying lenses are employed; and it is hard enough, without being too hard, to allow of pins being fixed into it, both for securing the object and for keeping apart such portions as it is useful to put on the stretch. When glass or earthen-

ware troughs are employed, a piece of sheet-cork loaded with lead must be provided, to answer the same purposes. In carrying on dissections in such a trough, it is frequently desirable to concentrate additional light upon the part which is being operated on, by means of the smaller Condensing Lens (Fig. 69); and when a low magnifying power is wanted, it may be supplied either by a single lens mounted after the manner of Ross's Simple Microscope (Fig. 26, B), or by a pair of Spectacles mounted with the Semilenses ordinarily used for Stereoscopes.* Portions of the body under dissection, being floated off when detached, may be conveniently taken up from the trough by placing a slip of glass beneath them (which is often the only mode in which delicate membranes can be satisfactorily spread out); and may be then placed under the Microscope for minute examination, being first covered with thin glass, beneath the edges of which is to be introduced a little of the liquid wherein the dissection is being carried on. Where the body under dissection is so transparent that more advantage is gained by transmitting light through it than by looking at it as an opaque object, the trough should have a glass bottom; and for this purpose, unless the body be of unusual size, some of the Glass Cells to be hereafter described (Figs. 104-107) will usually answer very well. The finest dissections may often be best made upon ordinary slips of glass; care being taken to keep the object sufficiently surrounded by fluid. For work of this kind no simple instrument is more generally serviceable than Quekett's Dissecting Microscope (Fig. 29); but if higher magnifying powers be needed than this will conveniently afford, recourse may be had to Nacet's Binocular Magnifier (Fig. 30), or to an Erector (§§ 64, 65) fitted to a Compound Microscope. In this case support may be provided for the hands on either side, by books or blocks of wood piled up to the requisite height; but in place of *flat* 'rests,' it is much more convenient to provide a pair of *inclined planes*, sloping away from the stage at an angle of about 30° below the horizon, which may be either solid blocks of wood, or made of two boards hinged together.

135. The instruments used in Microscopic Dissection are for the most part of the same kind as those which are needed in ordinary minute Anatomical research, such as scalpels, scissors, forceps, &c.; the fine instruments used in Operations upon the Eye, however, will commonly be found most suitable. A pair of delicate

* The Author can strongly recommend these Spectacles as useful in a great variety of manipulations which are best performed under a low magnifying power, with the conjoint use of both Eyes.—To those whose researches would be specially aided by the conjoint use of both eyes, armed with a somewhat higher power, he would strongly recommend Smith and Beck's 3-inch Achromatic Binocular Magnifier, which is constructed on the same principle, allowing the object to be brought very near the eyes, without requiring any uncomfortable convergence of their axes.

Scissors, curved to one side, is extremely convenient for cutting open tubular parts; these should have their points blunted; but other scissors should have fine points. A pair of very fine-pointed Scissors (Fig. 92), one leg of which is fixed in a light handle, and the other kept apart from it by a spring, so as to close by the pressure of the finger and to open of itself, will be found (if the blades be well sharpened on a hone) much superior to any kind of knives, for cutting through delicate tissues with as little disturbance of

FIG. 92.



Spring-Scissors.

them as possible: Swammerdam is said to have made great use of this instrument in his elaborate Insect dissections. Another cutting instrument much used by some dissectors may be designated as a miniature of the shears used in shearing sheep, or as a cutting-forceps; the blades of such an instrument may be prevented from springing too far asunder by means of a regulating-screw (as in the Microtome of M. Strauss-Durekheim), or by some other kind of check; and the cutting action, being executed by the opposed pressure of the finger and thumb, may be performed with great precision. A pair of small straight Forceps with fine points, and another pair of curved forceps, will be found useful in addition to the ordinary dissecting forceps.—Of all the instruments contrived for delicate dissections, however, none are more serviceable than those which the Microscopist may make for himself out of ordinary Needles. These should be fixed in light wooden handles* (the cedar sticks used for camel-hair pencils, or the handles of steel-penholders, or small Porcupine-quills, will answer extremely well), in such a manner that their points should not project far,† since they will

* Special *Needle-Holders* (like miniature port-crayons) have been made for this purpose; and although they afford the facility of lengthening or shortening the acting point of the needle at will, and also of carrying a reserve store of needles at the other end, yet the Author would decidedly recommend the use of the wooden handles, of which a large stock may be obtained for the cost of a single pair of special Holders.

† The following is the mode in which the Author has found it convenient to mount his Needles for this and other purposes:—the needle being held firmly in a pair of pliers grasped by the right hand, its point may be forced into the end of a cedar or other stick held in the left, until it has entered to the depth of half an inch or more; the needle is then cut off to the desired length (the eye-end being thus got-rid-of); and being then drawn out, the truncated end is forced into the hole previously made by the point, until it cannot be made to penetrate farther, when it will be found to be very securely fixed. The end of the handle which embraces it may then be bevelled-away round its point of insertion.

otherwise have too much 'spring;' much may be done by their mere *tearing* action; but if it be desired to use them as *cutting* instruments, all that is necessary is to give them an edge upon a hone. It will sometimes be desirable to give a finer point to such needles than they originally possess; this also may be done upon a hone. A needle with its point bent to a right angle, or nearly so, is often useful; and this may be shaped by simply heating the point in a lamp or candle, giving to it the required turn with a pair of pliers, and then hardening the point again by re-heating it and plunging it into cold water or tallow.

136. *Cutting Sections of Soft Substances.*—Most important information respecting the structure of many substances, both Animal and Vegetable, may be obtained by cutting sections of

FIG. 93.



Curved Scissors
for cutting Thin
Sections.

them, thin enough to be viewed as transparent objects. Where the substances are soft, no other instrument is necessary for this purpose than a sharp knife, which may be best made with a thin two-edged blade like that of a lancet; considerable practice is needed, however, to make effectual use of it; and some individuals acquire a degree of dexterity which others never succeed in attaining. In cutting sections of Animal tissues, which, owing to the quantity of water they contain, do not present a sufficiently firm resistance, it is often desirable to half-dry these, by exposing small pieces freely to the air, with the aid of a gentle warmth if required; when this desiccating process has been carried sufficiently far, thinner sections can be cut than could possibly have been made in the original state of the tissue; and the texture, after a short maceration in water, almost entirely recovers its pristine characters. There are certain tissues, however, which will not bear to be thus treated, and of which it is sufficient to examine an extremely minute portion; and for making sections of these, such a pair of Scissors as is represented in Fig. 93 will often be found very useful; since, owing to the curvature of the blades,* the two extremities of a section taken from a flat surface will generally be found to thin away, although the middle of it may be too thick to exhibit any structure.

* It is difficult to convey by a drawing the idea of the real curvature of this instrument, the blades of which, when it is held in front view, curve—not to either side—but towards the observer; these scissors being, as the French instrument-makers say, *courbés sur le plat*.—As an example of the utility of such an instrument to the Microscopist, the Author may cite the curious demonstration given a few years since, by Dr. Aug. Waller, of the structure of the Gustative Papillæ, by snipping them off from the living Human tongue, which may be done with no more pain than the prick of a pin would occasion.

—Where only a moderate degree of thinness is required, either in consequence of the transparency of the tissue, or because it is not desired to exhibit its minutest details, the two-bladed Knife contrived by Prof. Valentin (Fig. 94) may be employed with advantage. The blades are attached to each other at their lower end by a screw, in such a manner that their 'spring' tends to keep them apart; and their distance is regulated by pushing the little rivet backwards or forwards in the slit through which it works. The knife should be dipped in water before using, or,

FIG. 94.



Valentin's Knife.

still better, the section should be made under water, as the instrument works much better when wet; after use, it should be carefully washed and dried, a piece of soft leather being passed between the blades. If any water have found its way into the part through which the rivet works, the movable blade should be detached by taking out its screw, and each blade should be cleaned separately.*

137. *Cutting Sections of Harder Substances.*—There is a large class of substances, both Animal and Vegetable, which are too hard to admit of sections being made in the manner just described, but of which extremely thin slices can be made by a sharp cutting instrument, if only they be properly held and supported,—more especially when the thickness of the section can be regulated by a mechanical contrivance; such are, in particular, the Stems and Roots of Plants, and the Horns, Hoofs, Cartilages, and similarly firm structures of Animals. Various costly machines have been devised for this purpose, some of them characterized by great ingenuity of contrivance and beauty of workmanship; but every purpose to which these are adapted will be found to be answered by a very simple and unexpensive little instrument, which may either be held in the hand, or (which is preferable) may be firmly attached by means of a T-shaped piece of wood (as in Fig. 95), to the end of a table or work-bench. This instrument essentially consists of an upright hollow cylinder of brass, with a kind of piston which is pushed from below upwards by a fine-threaded screw turned by a large milled-head; at the upper end the cylinder terminates in a brass table, which is made to present a perfectly

* An improved form of this instrument is constructed by Mr. Mathews of Portugal-street; the blades being made with a convex instead of a straight edge, their distance from each other being regulated by a milled-head screw, and their separation for cleaning being more easily accomplished.

flat surface. At one side is seen a small milled-head, which acts upon a 'binding-screw,' whose extremity projects into the cavity of the cylinder, and serves to compress and steady anything that it holds. A cylindrical stem of wood, a piece of horn, whalebone, cartilage, &c., is to be fitted to the interior of the cylinder, so as to project a little above its top, and is to be steadied by the 'binding-screw;' it is then to be cut to a level by means of a sharp knife or razor, laid flat upon the table. The large milled-head is next to be moved through such a portion of a turn as may very slightly elevate the substance to be cut, so as to make it project in an almost insensible degree above the table; and this projecting part is to be sliced-off with a knife previously dipped in water.

FIG. 95.

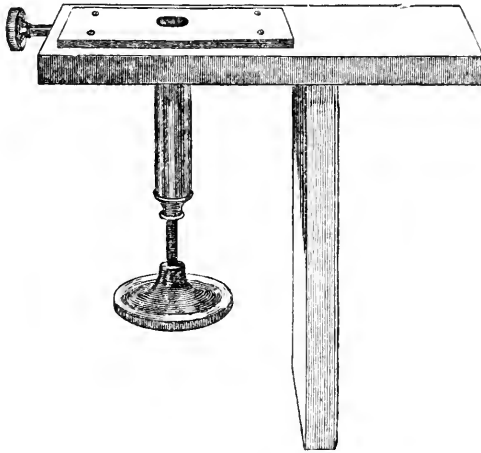

Section-Instrument.

The best knife for this purpose is a razor, ground flat (instead of concave) on one side, but having still a concave surface on the other; the flat side is to be laid downwards upon the table; and the motion given to the edge should be a combination of *drawing* and *pressing*. (It will be generally found that better sections are made by working the knife *from* the operator, than *towards* him.) When one slice has been thus taken off, it should be removed from the blade by dipping it into water, or by the use of a camel-hair brush; the milled-head should be again advanced, and another section taken; and so on. Different substances will be found both to *bear* and to *require* different degrees of thickness; and the amount that suits each can only be found by trial. It is advantageous to have the large milled-head graduated, and furnished

with a fixed index ; so that this amount having been once determined, the screw shall be so turned as to always produce the exact elevation required.—Where the substance of which it is desired to obtain sections by this instrument is of too small a size or of too soft a texture to be held firmly in the manner just described, it may be placed between the two vertical halves of a cork of suitable size to be pressed into the cylinder ; and the cork, with the object it grasps, is then to be sliced in the manner already described, the small section of the latter being carefully taken-off the knife, or floated-away from it, on each occasion, to prevent it from being lost among the lamellæ of cork which are removed at the same time.—The special methods of preparation which are required in the case of the various substances of which sections may be conveniently cut by this instrument, will be noticed under their several heads.

138. *Grinding and Polishing of Sections.*—Substances which are too hard to be sliced with a cutting instrument in the manner last described,—such as Bones, Teeth, Shells, Corals, Fossils of all kinds, and even some hard Vegetable Tissues,—can only be reduced to the requisite thinness for Microscopical examination, by grinding-down thick sections until they become so thin as to be transparent. General directions for making such preparations will be here given ;* but those special details of management which particular substances may require, will be given when these substances are respectively described.—The first thing to be done will usually be to procure a *section* of the substance, as thin as it can be safely cut. Most substances not siliceous may be divided by the fine saws used by artisans for cutting brass ; but there are some bodies (such as the enamel of teeth, and porcellaneous shells), which, though merely calcareous, are so hard as to make it very difficult and tedious to divide them in this mode ; and it is much the quicker operation to *slit* them with a disk of soft iron (resembling that used by the lapidary) charged at its edge with diamond-dust, which disk may be driven in an ordinary lathe. Where waste of material is of no account, a very expeditious method of obtaining pieces fit to grind-down is to detach them from the mass with a strong pair of ‘cutting-pincers,’ or, if it be of small dimensions, with ‘cutting-pliers ;’ and a flat surface must then be given to it either by holding it to the side of an ordinary grindstone, or by rubbing it on a plate of lead (cast or planed to a perfect level) charged with emery, or by a strong-toothed file, the former being the most suitable for the *hardest* substances, the latter for the *toughest*. There are certain substances, especially Calcareous Fossils of Wood, Bone, and Teeth, in which the greatest care is required in the performance of these preliminary operations, on

* The following directions do not apply to *Siliceous* substances ; as sections of these can only be prepared by those who possess a regular Lapidary’s apparatus, and who have been specially instructed in the use of it.

account of their extreme friability ; the vibration produced by the working of the saw or the file, or by grinding on a rough surface, being sufficient to disintegrate even a thick mass, so that it falls to pieces under the hand ; such specimens, therefore, it is requisite to treat with great caution, dividing them by the smooth action of the wheel, and then rubbing them down upon nothing rougher than a very fine 'grit.' Where (as often happens) such specimens are sufficiently porous to admit of the penetration of Canada Balsam, it will be desirable, after soaking them in turpentine for a while, to lay some liquid balsam upon the parts through which the section is to pass, and then to place the specimen before the fire or in an oven for some little time, so as first to cause the balsam to run-in, and then to harden it ; by this means the specimen will be rendered much more fit for the processes it has afterwards to undergo.—It not unfrequently happens that the small size, awkward shape, or extreme hardness of the body, occasions a difficulty in holding it either for cutting or grinding ; in such a case, it is much better to attach it to the glass in the first instance by any side that happens to be flattest, and then to rub it down by means of the 'hold' of the glass upon it, until the projecting portion has been brought to a plane, and has been prepared for permanent attachment to the glass. This is the method which it is generally most convenient to pursue with regard to small bodies ; and there are many which can scarcely be treated in any other way than by attaching a number of them to the glass at once, in such a manner as to make them mutually support one another.*

139. The mode in which the operation is then to be proceeded with, depends upon whether the section is to be ultimately set up in Canada balsam (§ 157), or is to be mounted dry (§ 154), or in fluid (§ 164). In the former case, the following is the plan to be pursued:—The flattened surface is to be polished by rubbing it

* Thus, in making horizontal and vertical sections of *Foraminifera*, as it would be impossible to slice them through, they must be laid close together in a bed of hardened Canada balsam on a slip of glass, in such positions, that, when rubbed down, the plane of section shall traverse them in the desired directions ; and one flat surface having been thus obtained for each, this must be turned downwards, and the other side ground away. The following ingenious plan has been suggested by Dr. Wallich ("Ann. of Nat. Hist." July, 1861, p. 58), for turning a number of minute objects together, and thus avoiding the tediousness and difficulty of turning each one separately:—The specimens are cemented with Canada Balsam, in the first instance, to a thin film of mica, which is then attached to a glass slide by the same means ; when they have been ground down as far as may be desired, the slide is gradually heated just sufficiently to allow of the detachment of the mica-film and the specimens it carries ; and a clean slide with a thin layer of hardened balsam having been prepared, the mica-film is transferred to it with the ground surface downwards. When its adhesion is complete, the grinding may be proceeded with ; and as the mica-film will be found to yield to the stone without the least difficulty, the specimens, now reversed in position, may be reduced to any degree of thinness that may be found desirable.

with water on a 'Water-of-Ayr'-stone, on a hone or 'Turkey'-stone, or on a new stone recently introduced under the name of the 'Arkansas'-stone; the first of the three is the best for all ordinary purposes, but the two latter being much harder may be employed for substances which resist it.* When this has been sufficiently accomplished, the section is to be attached with Canada balsam to a slip of thick well-annealed glass; and as the success of the final result will often depend upon the completeness of its adhesion to this, the means of most effectually securing that adhesion will now be described in detail. Some Canada balsam, previously rendered somewhat stiff by the evaporation of part of its turpentine, is to be melted on the glass slip, so as to form a thick drop, covering a space somewhat larger than the area of the section; and it should then be set aside to cool, during which process the bubbles that may have formed in it will usually burst. When cold, its hardness should be tested, which is best done by the edge of the thumb-nail; for it should be with difficulty indented by its pressure, and yet should not be so resinous as to be brittle. If it be too soft, as indicated by its too ready yielding to the thumb-nail, it should be boiled a little more; if too hard, which will be shown by its chipping, it should be re-melted and diluted with more fluid balsam, and then set aside to cool as before. When it is found to be of the right consistence, the section should be laid upon its surface with the polished side downwards; the slip of glass is next to be gradually warmed until the balsam is softened, special care being taken to avoid the formation of bubbles; and the section is then to be gently pressed down upon the liquefied balsam, the pressure being at first applied rather on one side than over its whole area, so as to drive the superfluous balsam in a sort of wave towards the other side, and an equable pressure being finally made over the whole. If this be carefully done, even a very large section may be attached to glass without the intervention of any air-bubbles; if, however, they should present themselves, and they cannot be expelled by increasing the pressure over the part beneath which they are, or by slightly shifting the section from side to side, it is better to take the section entirely off, to melt a little fresh balsam upon the glass, and then to lay the section upon it as before.

140. When the Section has been thus secured to the glass, and the attached parts thoroughly saturated (if it be porous) with hard Canada balsam, it may be readily reduced in thickness, either by grinding or filing as before, or, if the thickness be excessive, by taking off the chief part of it at once by the slitting-wheel. So

* As the *flatness* of the polished surface is a matter of the first importance, that of the Stones themselves should be tested from time to time; and whenever they are found to have been rubbed down on any one part more than on another, they should be flattened on a paving-stone with fine sand, or on the lead-plate with emery.

soon, however, as it approaches the thinness of a piece of ordinary card, it should be rubbed down with water on one of the smooth stones previously named, the glass slip being held beneath the fingers with its face downwards, and the pressure being applied with such equality that the thickness of the section shall be (as nearly as can be discerned) equal over its entire surface. As soon as it begins to be translucent, it should be placed under the Microscope (particular regard being had to the precaution specified in § 117), and note taken of any inequality; and then, when it is again laid upon the stone, such inequality may be brought down by making special pressure with the forefinger upon the part of the slide above it. When the thinness of the section is such as to cause the water to spread around it between the glass and the stone, an excess of thickness on either side may often be detected by noticing the smaller distance to which the liquid extends. In proportion as the substance attached to the glass is ground away, the superfluous Balsam which may have exuded around it will be brought into contact with the stone; and this should be removed with a knife, care being taken, however, that a margin be still left round the edge of the section. As the section approaches the degree of thinness which is most suitable for the display of its organization, great care must be taken that the grinding process be not carried too far; and frequent recourse should be had to the Microscope, which it is convenient to have always at hand when work of this kind is being carried on. There are many substances whose intimate structure can only be displayed in its highest perfection when a very little more reduction would destroy the section altogether; and every Microscopist who has occupied himself in making such preparations, can tell of the number which he has sacrificed in order to attain this perfection. Hence if the amount of material be limited, it is advisable to stop short as soon as a *good* section has been made, and to lay it aside—'letting well alone'—whilst the attempt is being made to procure a *better* one; if this should fail, another attempt may be made, and so on, until either success has been attained, or the whole of the material has been consumed—the *first* section, however, still remaining: whereas, if the first, like every successive section, be sacrificed in the attempt to obtain perfection, no trace will be left "to show what once has been." In judging of the appearance of a Section in this stage under the Microscope, it is to be remembered that its transparence will subsequently be considerably increased by mounting in Canada balsam (§ 157): this is particularly the case with Fossils to which a deep hue has been given by the infiltration of some colouring matter, and with any substances whose particles have a molecular aggregation that is rather amorphous than crystalline. When a sufficient thinness has been attained, the Section may generally be 'mounted' in Canada balsam; and the mode in which this must be managed will be detailed hereafter (§ 161).

141. As there are certain substances, however, the view of whose structure is impaired by mounting in Canada balsam, and which should therefore be mounted either dry or in fluid, a different method of procedure must be adopted with them. If tolerably thin sections of them can be cut in the first instance, or if they are of a size and shape to be held in the hand whilst they are being roughly ground down, there will be no occasion to attach them to glass at all : it is frequently convenient to do this at first, however, for the purpose of obtaining a 'hold' upon the specimen ; but the surface which has been thus attached must afterwards be completely rubbed away, in order to bring into view a stratum which the Canada balsam shall not have penetrated. As none but substances possessing considerable toughness, such as Bones and Teeth, can be treated in this manner, and as these are the substances which are most quickly reduced by a coarse file and are least liable to be injured by its action, it will be generally found possible to bring the sections to a considerable thinness, by laying them upon a piece of cork or soft wood held in a vice, and operating upon them first with a coarser and then with a finer file. When this cannot safely be carried further, the section must be rubbed down upon that one of the fine stones already mentioned (§ 139) which is found best to suit it : as long as the section is tolerably thick, the finger may be used to press and move it ; but as soon as the finger itself begins to come into contact with the stone, it must be guarded by a flat slice of cork or by a piece of gutta-percha a little larger than the object. Under either of these the section may be rubbed down until it has been reduced to the requisite degree of tenuity ; but even the most careful working on the finest-grained stone will leave its surface covered with scratches, which not only detract from its appearance, but prevent the details of its internal structure from being as readily made out as they can be in a polished section. This polish may be imparted by rubbing the section with putty-powder (peroxide of tin) and water upon a leather strap, made by covering the surface of a board with buff-leather, having three or four thicknesses of cloth, flannel, or soft leather beneath it : this operation must be performed on both sides of the section, until all the marks of the scratches left by the stone shall have been rubbed out ; when the specimen will be fit for mounting, after having been carefully cleansed from any adhering particles of putty-powder.

142. *Chemical Actions.*—One important part of the preparation of Microscopic objects is often effected by the use of Chemical Re-agents. These may be employed either for the sake of *removing* substances of which it is desired to get rid, in order to bring something else into view, or for the sake of *detecting* the presence of particular substances in the object under examination. Thus, the Author has found that he has frequently been better able to bring into view particular features in the organization of Foraminifera

by removing portions of their shells by the application of diluted Acid, than by grinding down thin sections. The acid (Nitric or Hydrochloric) may be applied with great nicety by means of a fine pointed camel-hair pencil, the object being attached to a slide, and placed under the simple Microscope ; and another camel-hair pencil charged with water should be at hand, to enable the observer to stop the solvent action whenever he may consider that it has been carried far enough. Again, in order to obtain the animal basis of Shell, Bone, Tooth, &c., it is necessary to dissolve away the Calcareous portion of these tissues by the use of acids ; a mixture of Nitric and Hydrochloric acids is preferable ; and this should be added, little by little, to a considerable bulk of water, until a disengagement of gas be perceived to commence from the surface of the specimen. Care should always be taken not to hurry the process by adding too much acid, since, when the animal membrane is of very delicate consistence, it is liable to be dissolved ; and in some cases it is better to allow the action to go on for many weeks, adding only a drop or two of acid at a time. When Siliceous particles are to be removed (such as those which form the *loriceæ* of the Diatomaceæ), for the sake of leaving the organic membrane in a state adapted to separate examination, Hydrofluoric acid must be employed as the menstruum. It is sometimes necessary to get rid of the Organic matter, for the sake of obtaining the Mineral particles in a separate state, as in the case of the spicules of Sponges, Gorgoniæ, &c. : this may be done either by incineration, or (which is generally preferable) by boiling or by macerating for a long time in a solution of caustic potash. In separating from Guano, again, the Siliceous skeletons of Diatomaceæ, &c., which it may contain, Hydrochloric and Nitric acids are largely used to dissolve away every part of the mass on which they will act ; the microscopic organisms for which search is made being contained in the few grains of sediment which are left when a pound of pure guano has been thus treated.—On the other hand, it is often desirable to *harden* Animal Tissues, in order that they may be more readily examined : this is best effected in some instances by maceration in strong Alcohol,* and in others by maceration in a solution of Chromic Acid, so dilute as to be of a pale straw colour, which is particularly efficacious in bringing into view the finer ramifications of Nerves.

143. In applying Chemical Re-agents to Microscopic objects for the purpose of *testing*, it is necessary to use great care not to add too much at once ; and the Test-Bottle itself may be made to afford the means of regulating the quantity, in either of the following modes :—The stopper of the test-bottle may be drawn to a capillary orifice, from which the fluid is caused to flow, drop by drop,

* The Author has found this menstruum especially useful in his researches into the structure of *Comatula*, the tissues of which, when fresh, are so extremely soft that their parts are almost undistinguishable.

by the warmth of the hand applied to the bottle, which causes an expansion of the air it may contain : the perforated stopper, when not in use, is covered by a cap which fits closely around the neck of the bottle.* Or the tubular stopper may be shaped like that of the bottle represented in Fig. 102, the lower end of the tube being drawn to a fine point, so that the desired quantity of the test-liquid, and no more, may be made to flow from it by pressing the elastic cap of the funnel. Another arrangement consists in the elongation of the stopper, which is drawn to a fusiform point, so as to serve as the test-rod for its own bottle,† thereby enabling either a mere trace or several ordinary drops of the re-agent to be applied at once; for the elongated stopper will take up a considerable quantity, a larger or smaller proportion of which (as desired) may be left behind, by bringing the lower part of the stopper into contact with the inside of the neck of the bottle as it is being withdrawn. The Author is disposed, however, from his own experience, to recommend the small Syringe formerly described (§ 101), with its nozzle drawn out to a point, as the most convenient instrument for applying minute quantities of Test-liquids to Microscopic objects. Whichever plan is made use of, great care should be taken to avoid carrying away from the slide to which the test-liquid is applied any loose particles which may be upon it, and which may be thus transferred to some other object, to the great perplexity of the Microscopist. It is better, indeed, not to deposit the drop of test-liquid on the slide in immediate contact with the substance to which it is to be applied; but to bring the two into contact after the test-bottle, stopper, or syringe has been withdrawn.

144. The following are the Test-Liquids most frequently needed :—

1. Solution of *Iodine* in water (1 gr. of iodine, 3 grs. of iodide of potassium, 1 oz. of distilled water) turns Starch blue and Cellulose brown; it also gives an intense brown to Albuminous substances.

2. Dilute *Sulphuric Acid* (one of acid to two or three parts of water), gives to Cellulose that has been previously dyed with iodine a blue or purple hue; also, when mixed with a solution of sugar, it gives a rose-red hue, more or less deep, with Nitrogenous substances and with bile (Pettenkofer's test).

3. Solution of Chloride of Zinc, Iodine, and Iodide of Potassium, made in the following way :—Zinc is dissolved in hydrochloric acid, and the solution is permitted to evaporate, in contact with metallic zinc, until it attains the thickness of a syrup; this syrup is then saturated with iodide of potassium, and iodine is last added. This solution (which is known as Schultz's test) serves, like the preceding, to detect the presence of Cellulose, and has the advantage over

* A set of 12 test-bottles on this plan is supplied by Mr. Highley.

† Bottles of this pattern, which was devised by Dr. Griffith, are sold by Mr. Ferguson, of Giltspur-street.

sulphuric acid of being less destructive to the tissues. Each will sometimes succeed where the other fails ; consequently, in doubtful cases, both should be employed.

4. Concentrated *Nitric Acid* gives to Albuminous substances an intense yellow : when diluted with about four or five parts of water, it is very useful in separating the elementary parts of many Animal and Vegetable tissues, when these are boiled or macerated in it.

5. *Acetic Acid* (which should be kept both concentrated and also diluted with from three to five parts of water) is a most useful test-liquid to the Animal Histologist, from its power of dissolving, or at least of reducing to a state of such transparency that they can no longer be distinguished, certain membranes, fibres, &c., whilst others are brought strongly into view.

6. *Acid Nitrate of Mercury* (Millon's test) colours Albuminous substances red.

7. Solution of *Caustic Potash* or *Soda* (the latter being generally preferable) has a remarkable solvent effect upon many Organic substances, both Animal and Vegetable, and is extremely useful in rendering some of their structures transparent, so that others are brought into view ; whilst it has a special action upon Horny tissues, which enables their component cells to be more readily distinguished.

8. *Alcohol* dissolves Resinous substances and many Vegetable Colouring matters, and renders most Vegetable preparations more transparent ; on the other hand, by its coagulating action on Albuminous substances, it renders many Animal tissues (as Nerve-fibres) more opaque, and thus brings them into greater distinctness.

9. *Ether* dissolves not only Resins, but Oils and Fats.

10. *Chromic Acid* hardens Animal tissues, especially Nerve-fibres.

145. *Staining Process*.—Much attention has been given of late years to the effects of another kind of testing, in which advantage is taken of the various degrees of attraction for certain Organic Colouring matters, which are possessed by different Tissues ; so that whilst some are stained very quickly when immersed in colouring solutions, others require a much longer contact with them ; and thus the former may be distinguished in the midst of the latter, with a certainty and clearness attainable by no other method. Although there are particular instances in which Magenta may be employed with advantage, the colouring substance most generally serviceable is *Carmine* ; and the following is given by Dr. Beale, who had large experience of this process, and has obtained important results by its use, as the best mode of applying it. Ten grains of Carmine in small fragments are to be placed in a test-tube, and half a drachm of strong Liquor Ammoniaë added ; by agitation and the heat of a spirit-lamp the carmine is soon dissolved, and the liquid, after boiling for a few seconds, is to be

allowed to cool. After the lapse of an hour, much of the excess of ammonia will have escaped; and the solution is then to be mixed with 2 oz. of Distilled Water, 2 oz. of pure Glycerine, and $\frac{1}{2}$ oz. of Alcohol. The whole may be passed through a filter; or, after being allowed to stand for some time, the perfectly clear supernatant fluid may be poured off and kept for use. If, after a long keeping, a little of the Carmine should be deposited through the escape of the ammonia, the addition of a drop or two of Liquor Ammoniacæ will re-dissolve it. The most valuable result of this process is the facility with which, when carefully and judiciously employed, it enables the Microscopist to distinguish what Dr. Beale terms 'germinal matter,'—which is identical with the 'protoplasm' or 'sarcode' of other Physiologists—from the 'formed materials' or tissue-elements, which are the products of its activity; the living formative substance being stained by Carmine so much sooner than any of those products, that it may be deeply dyed whilst they remain colourless. "The rapidity," says Dr. Beale, "with which the colouring of a tissue immersed in this fluid takes place, depends partly upon the character of the tissue, and partly upon the excess of ammonia present in the solution. If the solution be very alkaline, the colouring will be too intense, and much of the soft tissue or imperfectly developed formed material around the germinal matter is destroyed by the action of the alkali. If, on the other hand, the reaction of the solution be neutral, the uniform staining of tissue and germinal matter may result, and the appearances from which so much may be learned are not always produced. When the vessels are injected with the Prussian blue fluid, the Carmine fluid requires to be sufficiently alkaline to neutralize the free acid present. The permeating power of the solution is easily increased by the addition of a little more water and alcohol. In some cases the fluid must be diluted with water, alcohol, or glycerine; and the observer must not hastily condemn the process, or conclude (as some have) that a particular form of germinal matter is not to be coloured, until he has given the plan a fair trial, and tried a few experiments."* Of the special uses of this method, various illustrations will be given hereafter.

146. *Preparation of Specimens in Viscid Media.*—To Dr. Beale the Microscopist is also indebted for a method of preparing Animal and Vegetable tissues for examination under the 1-12th, 1-20th, or 1-25th-inch Objectives, which is much superior to those in ordinary use. This consists in the substitution of a *viscid medium*, such as pure Glycerine or strong Syrup, for the Aqueous fluids with which the object to be examined is usually treated; many advantages being thereby gained. Thus in thinning-out tissues by compression, an amount of pressure may be

* "How to Work with the Microscope," 4th edit. p. 109.

applied, which would be destructive to specimens mounted in water. Again, these media have a preservative action, so that if the tissues be permeated by them soon after death, further changes are prevented. They have, moreover, the effect of rendering the tissues more transparent, and enabling their components to be more readily distinguished. It has been objected that these viscid media are unsuitable, as causing the tissues to shrink, and soft cells to collapse, by the exosmose of their fluid contents; but in reply it is stated by Dr. Beale, that though such shrinkage is the immediate effect of the use of a viscid medium of considerable density, tissues left in it for a few days recover their original dimensions. "I have preparations," he says (Op. cit. p. 294), "from creatures of every class. The smallest Animalcules, tissues of Entozoa, Polypes, Starfishes, Mollusks, Insects, Crustacea, Infusoria, various Vegetable Tissues, microscopic Fungi and Algæ of the most minute and delicate structure, as well as the most delicate parts of the higher Vegetable tissues, may all be preserved in these viscid media; so also may be preserved the slowest and the most rapidly-growing, the hardest and the softest Morbid growths, as well as Embryonic structures at every period of development, even when in the softest state. All that is required is, that *the strength of the fluid should be increased very gradually, until the whole tissue is thoroughly penetrated by the strongest that can be obtained.*" "Minute dissections can be carried on in the seviscid media with greater facility and certainty than in more limpid fluids. I can readily detach the most minute parts of tissues, separate the different structures in one texture without tearing or destroying them, unravel convoluted tubes, and perform with ease a great variety of minute operations, which it would be impossible to effect with any of the ordinary methods of dissection. With care in regulating the temperature, I can soften textures thus preserved in syrup to the precise extent required for further minute dissection; and even very hard textures (such as Bone and Teeth) may thus be softened, so that by gradually increased pressure and careful manipulation exceedingly thin layers can be obtained, without the relation of the anatomical elements to each other being much altered, and without any of the tissues being destroyed." (Op. cit. p. 205). Dr. Beale recommends that any Re-agents used in making preparations of this kind, should themselves be dissolved in Glycerine.

Section 2. *Mounting of Objects.*

147. The Microscopist not merely desires to prepare Objects for examination, but, where possible, to preserve them in such a manner that they may be inspected at any future time. This may be so effectually accomplished in regard to many substances, that they undergo no kind of change, however long they may be retained; and even delicate structures whose composition renders

them peculiarly liable to decay, may often be kept, by complete seclusion from the air and by immersion in a preservative fluid, in a state so nearly resembling that in which they were at first prepared, that they will continue, during an indefinite length of time, to exhibit their original characters with scarcely any deterioration. The method of 'mounting' Objects to be thus preserved will differ, of course, both according to their respective natures and also according to the mode in which they are to be viewed, whether as *transparent* or as *opaque* objects. Thus they may be set up dry or in Canada balsam, or in some preservative liquid; they may need to be simply covered with thin glass, or they may require to be surrounded by a 'cell:' if they are to be viewed by transmitted light, they must always have glass below them; but if they are to be seen by the light reflected from their surfaces, they may often be preferably mounted on wood, card, or some other material which itself affords a black back ground. In almost all cases in which Transparent objects are to be mounted, use will have to be made of the slips of Glass technically called *slides* or *sliders*, and *covers* of thin glass; and it will therefore be desirable to treat of these in the first instance.

148. *Glass Slides*.—The kind of Glass usually employed for mounting objects is that which is known as 'flatted crown;' and it is now almost invariably cut, by the common consent of Microscopists in this country, into slips measuring 3 in. by 1 in. : for objects too large to be mounted on these, the size of 3 in. by 1½ in. may be adopted. Such slips may be purchased, accurately cut to size and ground at the edges, for so little more than the cost of the glass, that few persons to whom time is an object would trouble themselves to prepare them; it being only when glass slides of some unusual dimensions are required, or when it is desired to construct 'built-up cells' (§ 170), that a facility of cutting glass with a glazier's diamond becomes useful. The glass slides prepared for use should be free from veins, air-bubbles, or other flaws, at least in the central part on which the object is placed; and any whose defects render them unsuitable for ordinary purposes, should be selected and laid aside for uses to which the working Microscopist will find no difficulty in putting them. As the slips vary considerably in thickness, it will be advantageous to separate the *thick* from the *thin*, and both from those of *medium* substance: the last may be employed for mounting ordinary objects; the second for mounting delicate objects to be viewed by the high powers with which the Achromatic Condenser is to be used, so as to avoid any unnecessary deflection of the illuminating pencil by the thickness of the plate which it has to traverse beneath the object; whilst the first should be set aside for the attachment of objects which are to be ground-down, and for which, therefore, a stronger mounting than usual is desirable. Where very hard substances have to be thus operated on, it is advantageous to attach them in the first

instance to pieces of very thick plate-glass ; only transferring them to the ordinary slides when they have been reduced to nearly the requisite thinness (§ 161).

149. *Thin Glass.*—The older Microscopists were obliged to employ thin laminae of *talc* for covering objects to be viewed with lenses of short foci ; but this material, which was in many respects objectionable, is now entirely superseded by the thin-glass manufactured for this express purpose by Messrs. Chance of Birmingham, which may be obtained of various degrees of thickness, from 1-20th to 1-250th of an inch. This glass, being unannealed, is very hard and brittle ; and much care and some dexterity are required in cutting it. This should be done with the *writing* diamond ; and it is advantageous to lay the thin glass upon a piece of wetted plate-glass, as its tendency to crack and ‘star’ is thereby diminished. For cutting *square* or other *rectangular* covers, nothing but a flat rule is required. For cutting *rounds* or *ovals*, on the other hand, it is necessary to have ‘guides’ of some kind. The simplest, which are as effective as any, consist of pieces of flat brass-plate, perforated with holes of the various sizes desired, or curtain-rings, with a piece of wire soldered on either side : these being held firmly down on the thin glass with two fingers of the left hand, the writing-diamond is carried round the inner margin of the aperture with the right ; care being taken that, in so doing, the diamond be made to revolve on its own axis, which is needful both that it may mark the glass, and also that the beginning and the end of the cut may join.* Where a number of such ‘rounds’ are being cut at once, it saves much trouble, as well as risk of loss by breakage, in separating them, to cut the glass first into strips whose breadth shall equal the diameter of the rounds. But it is very convenient to use-up for this purpose any odd pieces of glass whose shape may render them unsuitable for being cut into ‘squares’ without much waste. The pieces of thin glass thus prepared for use should be sorted, not only according to size and shape, but also according to thickness. The thinnest glass is of course most difficult to handle safely, and is most liable to fracture from accidents of various kinds ; and hence it should only be employed for the purpose for which it is absolutely needed, namely, the mounting of objects

* A very elegant little instrument, for the purpose of cutting thin-glass rounds, contrived by Mr. Shadbolt, and another, of a more substantial character, invented by Mr. Darker, will be found described in Mr. Quekett’s “Practical Treatise.” These instruments, however, are rather adapted for the use of those who have occasion to prepare such rounds in large quantities, than for the ordinary working Microscopist, who will find the method above described answer his requirements sufficiently well. Indeed it is in some respects superior ; since a firm pressure made by the ring or plate on the glass around, tends to prevent the crack from spreading into it. But to every one to whom the saving of *time* is a greater object than the expenditure of a few shillings, it is strongly recommended that these ‘rounds’ should be purchased ready cut ; as they may be obtained of any required size and thinness, at a very moderate cost.

which are to be viewed by the highest powers. The thickest pieces, again, may be most advantageously employed as covers for large Cells in which objects are mounted in fluid (§§ 163-170), to be viewed by the low powers whose performance is not sensibly affected by the aberration thus produced. And the pieces of medium thinness will be found most serviceable for all ordinary purposes; neither being, on the one hand, difficult to handle, nor, on the other, interfering with the clearness of the image formed by medium powers of moderate aperture, even when no special adjustment is made for the aberration they occasion (§ 131, v.).

150. The exact thickness of any piece of glass may be determined without difficulty, by placing it edgewise on the stage of the Microscope (holding it in the stage-forceps), and measuring its edge by the Eye-piece Micrometer (§ 68). A much more ready means is afforded, however, by the *Lever of Contact* (Fig. 96) devised by Mr. Ross for this express purpose. This instrument consists of a small horizontal table of brass, mounted upon a stand, and having at one end an arc graduated into 20 divisions, each of which

FIG. 96.

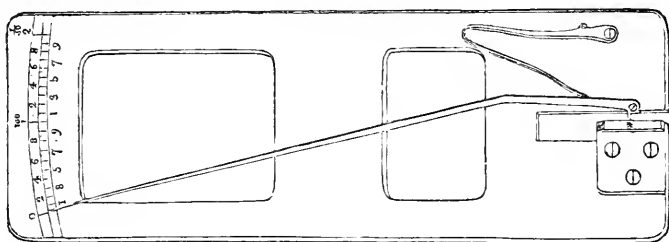

Lever of Contact.

represents 1-1000th of an inch, so that the entire arc measures 1-50th of an inch; at the other end is a pivot, on which moves a long and delicate lever of steel, whose extremity points to the graduated arc, whilst it has very near its pivot a sort of projecting tooth, which bears at * against a vertical plate of steel that is screwed to the horizontal table. The piece of Thin Glass to be measured, being inserted between the vertical plate and the projecting tooth of the lever, its thickness in thousandths of an inch is given by the number on the graduated arc to which the extremity of the lever points. Thus, if the number be 8, the thickness of the glass is .008 or 1-125th of an inch. When the glass covers have been sorted according to their thickness, it will be found convenient to employ those of one particular thickness for each particular class of objects; since, when one object is being examined after another, no re-adjustment of the Objective will then be required for each. This will be found a great saving of time and trouble,

when high powers are in use. It is undesirable to employ glass covers of greater thickness than 1-140th (.007) of an inch with any object-glass whose aperture exceeds 75° ; and for object-glasses of 120° and upwards the glass cover should not exceed 1-250th (.004) of an inch.

151. On account of the extreme brittleness of the Thin Glass, it is desirable to keep the pieces, when cut and sorted, in some fine and soft powder, such as Starch. Before using it, however, the Microscopist should be careful to clean it thoroughly; not merely for the sake of removing foulnesses which would interfere with the view of the object, but also for the sake of getting rid of adherent starch-grains, the presence of which might lead to wrong conclusions, and also of freeing the surface from that slight greasiness which, by preventing it from being readily wetted by water, frequently occasions great inconvenience in the mounting of objects in fluid. The thicker pieces may be washed and wiped without much danger of fracture, if due care be employed; but the thinner require much precaution; and in cleansing these, the simple method devised by Mr. Spencer will be found very useful. This consists in the use of a pair of round flat disks, about $1\frac{1}{2}$ in. in diameter, made of wood or metal covered with chamois leather, and furnished with handles; for when a piece even of the thinnest glass is laid upon one of these, it may be rubbed clean with the other, and any amount of pressure may be used without the least risk of breaking it. Previously to doing this, however, it will be advantageous to soak the pieces for a time in strong Sulphuric Acid, and then to wash them in two or three waters; but if greasiness be their chief fault, they should be soaked in a strong infusion of Nutgalls, with which it will be also advantageous to cleanse the surface of glass slides that are to be used for mounting objects in liquid.

152. *Varnishes and Cements.*—There are three very distinct purposes for which Cements that possess the power of holding firmly to Glass, and of resisting not merely water but other preservative liquids, are required by the Microscopist; these being (1) the attachment of the glass covers to the slides or cells containing the object, (2) the formation of thin cells of cement only, and (3) the attachment of the glass-plate or tube-cells to the slides. The two former of these purposes are answered by liquid cements or *varnishes*, which may be applied without heat; the last requires a *solid cement* of greater tenacity, which can only be used in the melted state. The varnishes used for mounting objects in liquid should always be such as contain *no mixture of solid particles*. This is a principle on which the Author, from an experience of many years, is disposed to lay great stress; having often made trial, at the recommendation of friends, of varnishes which were said to have been greatly improved by thickening with litharge or lamp-black; and having always found that, although they may

stand well for a few weeks or months, they became porous after a greater lapse of time, allowing the evaporation of the liquid and admission of air. He has himself found none more durable than that known as Japanners' *Gold-Size*, which may be obtained at almost every colour shop.* When this is new and liquid, it dries very quickly, provided a thin layer only be laid on at once; and its disposition to *run in* is thus kept in check. When the first coat has completely set, a second may be applied; and it may be advantageous to lay a third over this, or the slide may be finished off with Brunswick Black or Asphalte. There are few preservative liquids with which Gold-Size may not be employed; since it is not acted on by any Aqueous solution, and resists moderately diluted Spirit; Oil of Turpentine being its only true solvent. The solution of Shell-Lac in Naphtha, which is sold under the name of *Liquid Glue*, dries more quickly than gold-size, but is more brittle when completely hardened, and does not adhere so firmly and enduringly to glass; and it is, moreover, more easily acted on by diluted alcohol than the preceding. Its chief use is in mounting objects dry (§ 156). *Bell's Microscopic Cement*, which is made by dissolving Shell-Lac in strong Alcohol, is said by Dr. Beale to resist Glycerine better than ordinary cements. A solution of Asphalte in drying oil or turpentine, known under the name of *Brunswick Black*, has come much into use. It is extremely easy and pleasant to work with, and dries quickly, so that it may be conveniently used as a 'finish' over Gold-Size, to improve the appearance of the slide; but it is brittle when dry, and is disposed to crack, not merely when subject to any 'jar,' but also (after some time) spontaneously. This evil may be corrected by adding to it a little solution of Caoutchouc in Mineral Naphtha; or, still better, by dissolving half a drachm of Caoutchouc in 10 oz. of Mineral Naphtha, and then adding 4 oz. of Asphaltum, which must be dissolved by the aid of heat if necessary. It is requisite to the goodness of this *Asphalte* varnish, that the Asphaltum should be of the best quality. This cement answers well for making *Cement-cells* (§ 166); as does also the Varnish termed *Black Japan*, provided that the glasses to which it has been applied be exposed to the heat of an oven, not raised so high as to cause the varnish to 'blister.'—Brushes which have been used either with Gold-Size or Asphalte may be cleansed by Oil of Turpentine; those which have been used with Liquid Glue may be cleansed with Naphtha.

153. Although Canada Balsam has been sometimes used as a Cement, and has the advantage of being worked with extreme convenience, yet it is so apt to crack when hardened by time, that a slight 'jar' will cause the cell to spring away from the glass to

* The Author has preparations mounted with Gold-Size more than twenty years ago, which have remained perfectly free from leakage; the precaution having been taken to lay on a thin coat of varnish every two or three years.

which it has been attached. Hence, if employed at all for affixing Cells to Glass Slides, its use should be limited to those which afford a large surface of attachment (§§ 167, 168), or to those very thin Tube-cells (§ 169) which cannot be so conveniently attached with marine glue, and of which the cover may be secured to the slide by spreading the ring of gold-size round the margin of the cell itself (§ 171). Care should be taken in applying the Canada Balsam, that it be sufficiently hardened by heat, but that it be not so heated as to become brittle (§ 139). The general method of using it for this purpose, is the same as that which must be practised in the case of Marine Glue. The superfluous balsam left after pressing down the cell is to be removed, first by scraping with a heated knife, and then by a rag dipped in oil of turpentine, after which it is desirable to give the glass surface a final cleansing with alcohol.—For all kinds of Cells (§§ 167-170) except those just mentioned, the proper cement is *Marine Glue*, which is a mixture of shell-lac, caoutchouc, and naphtha, now extensively employed; being distinguished by its extraordinary tenacity, and by its power of resisting solvents of almost every kind. Different qualities of this substance are made for the several purposes to which it is applied; that which is the most suitable to the wants of the Microscopist is known in commerce as GK 4. As this cement can only be applied hot, and as it is a great saving of trouble to attach a considerable number of cells at the same time, a *Mounting-Plate* should be provided, which will furnish the requisite heat to several slides at once. Such a surface may be afforded by the top of a stove; but it is better to have one which can be used at all seasons, and the heat of which can be precisely regulated at pleasure. A very simple apparatus much used for this purpose, consists of a small table of brass or iron plate, about 6 inches long and 2 broad, with legs about 4 inches high, either screwed into its four corners, or so jointed to them as to fold down; this is set over a small Spirit Lamp, the flame of which is regulated to give the heat required.* The Author has found it much preferable, however, to lay the plate on one of the rings of a small 'retort-stand' (used in Chemical operations), which admits of being shifted to any height that may be desired, so that the heat applied may be precisely graduated; or, if a Gas-lamp be applied for the ordinary purposes of illumination, its stem may be fitted with a sliding-ring, which will carry either a hot plate or a water-bath.† It is convenient, moreover, to have two such plates laid on two rings; one being allowed to cool with the slides upon it, whilst the other is being heated. The Glass Slides and Cells which are to be attached to each other must

* An improvement on the ordinary form of Mounting-Plate has been described by Mr. Freestone in "Transact. of Microsc. Society," Vol. xii. p. 46.

† Both these fittings are adapted to the Gas-lamp supplied for the use of Microscopists by Mr. S. Highley (§ 105).

first be heated on the mounting-plate ; and some small cuttings of marine glue are then to be placed, either upon that surface of the cell which is to be attached, or upon that portion of the slide on which it is to lie, the former being perhaps preferable. When they begin to melt, they may be worked over the surface of attachment by means of a needle-point ; and in this manner the melted glue may be uniformly spread, care being taken to pick out any of the small gritty particles which this cement sometimes contains. When the surface of attachment is thus completely covered with liquefied glue, the cell is to be taken up with a pair of forceps, turned over, and deposited in its proper place on the slide ; and it is then to be firmly pressed down with a stick (such as the handle of the needle), or with a piece of flat wood, so as to squeeze out any superfluous glue from beneath. If any air-bubbles should be seen between the cell and the slide, these should if possible be got rid of by pressure, or by slightly moving the cell from side to side ; but if their presence results, as is sometimes the case, from deficiency of cement at that point, the cell must be lifted off again, and more glue applied at the required spot. Sometimes, in spite of care, the glue becomes hardened and blackened by overheating ; and as it will not then stick well to the glass, it is preferable not to attempt to proceed, but to lift off the cell from the slide, to let it cool, and then to repeat the process. When the cementing has been satisfactorily accomplished, the slides should be allowed to cool gradually, in order to secure the firm adhesion of the glue ; and this is readily accomplished, in the first instance, by pushing each, as it is finished, towards one of the extremities of the plate, which is of course cooler than the centre. If two plates are in use, the heated plate may then be readily moved away upon the ring which supports it, the other being brought down in its place ; and as the heated plate will be some little time in cooling, the firm attachment of the cells will be secured. If, on the other hand, there be only a single plate, and the operator desire to proceed at once in mounting more cells, the slides already completed should be carefully removed from it, and laid upon a *wooden* surface, the slow conduction of which will prevent them from cooling too fast. Before they are quite cold, the superfluous glue should be scraped from the glass with a small chisel or awl ; and the surface should then be carefully cleansed with a solution of Potash, which may be rubbed upon it with a piece of rag covering a stick shaped like a chisel. The cells should next be washed with a hard brush and soap and water, and may be finally cleansed by rubbing with a little weak spirit and a soft cloth. In cases in which *appearance* is not of much consequence, and especially in those in which the cell is to be used for mounting large opaque objects, it is decidedly preferable not to scrape off the glue too closely round the edges of attachment, as the 'hold' is much firmer, and the probability of

the penetration of air or fluid much less, if the immediate margin of glue be left both outside and inside the cell.

154. *Mounting Objects Dry.*—There are certain objects which, even when they are to be viewed by *transmitted* light, are more advantageously seen when simply laid on glass, than when they are immersed either in fluid or in balsam. This is the case especially with sections of bones and teeth, much of whose internal structure is obliterated by the penetration of fluid; and also with the scales of Lepidopterous and other Insects, whose minute surface-markings are far more distinct when thus examined, than when treated in any other way. For preserving such objects, it is of course desirable that they should be protected by a cover; and this must be so attached to the glass slide as to keep the object in place, besides being itself secured. For this purpose, Sealing-wax varnish is often used, but it is unsuitable on account of its brittleness when dry; Brunswick Black or Gold-Size mixed with Lamp-black is much to be preferred, and, if carefully laid on, will not tend to run in between the cover and the slide. If the object have any tendency to curl up, or to keep off the cover from the slide by its own 'spring,' it will be useful, while applying the varnish, to make use of pressure, such as that afforded by the *Spring-Clip** represented in Fig. 97, and this pressure should not be remitted

FIG. 97.

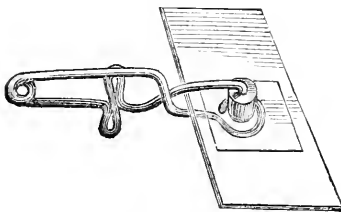

Spring-Clip.

until the varnish is dry enough to hold down the cover by itself. Where the object is thin, and not liable to be injured by a gentle heat, the best method is to use a Cement-cell (§ 166) thoroughly hardened, and after the object has been placed in it, and its cover laid on, the slide is warmed sufficiently to soften the ring of Cement, on which the cover is then carefully pressed

down, so as at the same time to attach itself and to fix the object. For mounting delicate objects, the *thinner* slides should be selected; and for very difficult Test-objects, it is advantageous to employ thin glass below as well as above the specimens, for the sake of diminishing the aberration which the illuminating pencil sustains in its passage to the object, and for allowing the Achromatic Condenser to approach the object as closely as possible. For this purpose the simplest method is to take a slip of Wood (preferably either mahogany or cedar) of the ordinary size of the glass slide (3 in. by 1 in.),

* This very useful little implement is an improvement by Mr. Jabez Hogg upon a form originally devised by Dr. Maddox. It is sold at a very cheap rate by Messrs. Baker, Mr. Collins, and other dealers in Microscopic Apparatus.

with a central aperture of from 3 to 5-8ths of an inch ; to cover this aperture with a 'square' or 'round' of thin glass of sufficient size to project considerably beyond it ; to lay the object upon this glass, and to protect it with a cover of rather smaller size, which should be fastened down all round by varnish to prevent the entrance of moisture ; and finally to secure both glasses to the wooden slide, by gumming down over them a piece of paper with a perforation of the same size as that of the slide itself.

155. For dry-mounting *Opaque* objects, the method adopted must vary with the mode in which the object is to be illuminated. If a Side-Condenser or Parabolic Reflector is to be employed, which is the most appropriate method for the great majority of objects, the whole slide may be opaque ; and the following simple plan devised by the Author (whose entire collection of *Foraminifera* is thus mounted) will be found to afford peculiar conveniences. Let there be provided a Wooden slide of the kind just described, a piece of card of the same dimensions, and a piece of *dead-black* paper, rather larger than the aperture of the slide, if a dark mounting be desired, which is preferable for most objects : this piece of paper is to be gummed to the middle of the card, and then, some stiff gum having been previously spread over one side of the slide (care being taken that there is no superfluity of it immediately around the aperture), this is to be laid down upon the card, and subjected to pressure.* An extremely neat 'cell' will thus be formed for the reception of the object (Fig. 98), the depth

FIG. 98.



Wooden Slide for Opaque Objects.

of which will be determined by the thickness of the slide, and the diameter by the size of the perforation ; and it will be found convenient to provide slides of various thicknesses, with apertures of different sizes. The Cell should always be deep enough for its wall to rise above the object : but, on the other hand, it should not be too deep for its walls to interfere with the oblique incidence of the light upon any object that may be near its periphery. The Object, if flat or small, may be attached by ordinary Gum-mucilage ; † if,

* It will be found a very convenient plan to prepare a large number of such slides at once : and this may be done in a marvellously short time, if the slips of card have been previously cut to the exact size in a book-binder's press. The slides, when put together, should be placed in pairs, back to back ; and every pair should have each of its ends embraced by a Spring-Press (Fig. 101) until dry.

† It will be found very advantageous for almost every purpose to add

however, it be large, and the part of it to be attached have an irregular surface, it is desirable to afford a 'bed' to this by Gum thickened with Starch. If, on the other hand, it should be desired to mount the object edgeways (as when the *mouth* of a *Foramifer* is to be brought into view), the *side* of the object may be attached with a little gum to the wall of the cell. The complete protection thus given to the Object is the great recommendation of this method. But this is by no means its only convenience. It allows the slides not only to range in the ordinary Cabinets, but also to be laid one against another and to be packed closely in cases or secured by elastic bands; which plan is extremely convenient not merely for the saving of space, but also for preserving the objects from dust. Should any more special protection be required, a Thin Glass cover may be laid over the top of the cell, and secured there either by a rim of gum or by a perforated paper cover attached to the slide; and if it should be desired to pack these covered slides together, it is only necessary to interpose *guards* of card somewhat thicker than the glass covers. In cases in which it is desired to retain the power of examining the object without the intervention of a glass cover, a thin disk of Bone or Vulcanite may be attached to the slide (as suggested by Mr. Piper, "Trans. of Microsc. Soc." Vol. xv. p. 18) by means of a split metal rivet passing through a hole near its edge, and attached to the slide near the edge of the cell by clenching it on the under side before the cardboard-bottom is attached. The rivet acts as a pivot on which the disk turns, so that it may either cover the cell or may be moved to one side; and the disk may be conveniently made to carry a label for the description of the object. For objects which it is desired to examine under different aspects, *Morris's Object-holder* (Fig. 76) will be found very convenient: full advantage can only be taken of this, however, when the objects are mounted on detached disks; and in such cases *Beck's Disk-holder* (Fig. 77) is decidedly preferable.

156. Objects to be viewed by *Lieberkühn* illumination, however, require a different mode of mounting, in order that the light may be allowed to pass up around them from the mirror to the speculum. If they are of moderate size, the Wooden slide may still be conveniently employed for them, its aperture being made as large as it will bear, and its cardboard-bottom being replaced by a thin ordinary glass slide; and the object may either be mounted on a small disk punched out of blackened card, or it may be attached directly to the glass, to the under side of which a spot of black varnish or a disk of black paper should be then affixed. Small and delicate

about 1-10th part of Glycerine to thick Gum-mucilage; for the gum is thereby prevented from hardening so completely as to become brittle, and the bodies attached by it are less likely to be separated by a jarring shock; whilst, on the other hand, if it should be desired to remove the object from the slide, the gum is more readily softened and dissolved by the addition of a drop of water.

objects, however—such as *Diatoms* and *Polycystina*—are best mounted on small disks of thin blackened card attached to Glass slides ; being protected either by Ring-cells (§ 169) of Glass, Metal, or Vulcanite,* or by perforated disks cut with punches of suitable size out of cardboard or kid-leather, which, having been repeatedly brushed over with Liquid Glue, are attached to the slide, and have their covers affixed to them with the same material.

157. *Mounting Objects in Canada Balsam.*—This method of mounting is suitable to a very large proportion of those Objects which are to be viewed by transmitted light, and whose texture is not affected by the loss of the aqueous fluid they may contain ; and it has many advantages over the mounting of the like objects dry. For, in the first place, as it fills-up the little inequalities of their surface, even where it does not actually penetrate their substance, it increases their transparency by doing-away with irregular refractions of the light in its way through them, and gives them the aspect of perfect smoothness ; this is well seen in the case of sections of *Shell*, &c., which, when thus mounted, do not require a high polish (§ 140). But, secondly, where the structure, although itself hard, is penetrated by internal vacuities, the Balsam, by filling these, prevents that obscuration resulting from the interposition of air-spaces, and from additional internal surfaces of reflection, by which the transmitted rays are distorted, and a large proportion of them lost : this is well seen in the case of the *Foraminifera*, and of sections of the ‘test’ and ‘spines’ of *Echinida*, whose intimate structure can be far better made-out when they are thus mounted, than when mounted dry, although their substance is (for the most part at least) itself so dense, that the balsam cannot be imagined to penetrate it ; and likewise with dry *Vegetable* preparations, which are perhaps also affected in the manner to be next described. Thirdly, there are very many structures of great interest to the Microscopist, whose appearance is extraordinarily improved by this method of mounting, in consequence of a specific effect which the Balsam has in combining (so to speak) with their component elements, so as to render them far more transparent than before : this effect is seen in the case of all dry preparations of *Insect*-structure, especially of such as consist of their hard external tegument or of parts derived from this ; also in the various *Horny* tissues (hairs, hoof, horn, &c.) of the higher animals ; and likewise in many organized substances, both recent and fossil, which are penetrated by Calcareous matter in an *amorphous* condition.—Besides these advantages, the mounting of objects in Canada balsam affords one of the easiest methods of fixing

* Ring-Cells cut in a lathe from Gutta-percha tubing have been proposed for this purpose ; but they do not adhere permanently to glass ; and Cells of Vulcanite made in the same manner are greatly to be preferred. Cells cut off from Pasteboard tubing may also be employed, if treated with Liquid Glue as mentioned above.

and preserving them ; and consequently it may be almost always had recourse-to in the case of such transparent objects as do not need to be preserved in fluid, save where, in virtue of the action just described, it impairs the distinctness of surface-markings, or obliterates internal cavities or canals, which constitute the most important features of the object.

158. Canada Balsam, being nothing else than a very pure *Turpentine*, is a natural combination of Resin with the Essential Oil of turpentine. In its fresh state it is a viscid liquid, easily poured out, but capable of being drawn into fine threads ; and this is the condition in which the Microscopist will find it most desirable to use it for the mounting of objects generally. The Balsam may be conveniently kept in a glass bottle or jar with a wide mouth, being taken up as required with a small glass rod drawn to a blunt point, such as is used by Chemists as a 'stirrer ;' and if, instead of a cork or stopper, this bottle should be provided with a tall hollow 'cap,' the glass rod may always stand in the balsam with its upper end projecting into the cap. In taking out the Balsam, care should be taken not to drop it prematurely from the rod, and not to let it come into contact with the interior of the neck or with the mouth of the jar : both these mischances may be avoided by not attempting to take-up on the rod more than it will properly carry, and by holding it in a horizontal position after drawing it out from the bottle, until the slip on which it is to deposit the balsam is just beneath its point. Some recommend that the Balsam should be kept in the Tin tubes used for Artists' colours ; but the screw-caps of these are liable to be fixed by the hardening of the contents : and the Author has himself been in the habit of employing in preference a Syringe, resembling that represented in Fig. 83, but with a freer opening. This is most readily filled with Balsam, in the first instance, by drawing out the piston and pouring-in balsam previously rendered more liquid by gentle warmth ; and nothing else is required to enable the operator at any time to expel precisely the amount of balsam he may require, than to warm the point of the syringe, if the balsam should have hardened in it, and to apply a very gentle heat to the syringe generally, if the piston should not then be readily pressed down. When a number of Balsam-Objects are being mounted at one time, the advantage of this plan in regard to facility and cleanliness (no superfluous balsam being deposited on the slide) will make itself sensibly felt. It has, moreover, the further recommendation of keeping the balsam almost perfectly excluded from the air ; the only contact between them being at its point, where the balsam soon hardens so as to protect what is within.—When Balsam has been kept too long, it becomes, through the loss of part of its volatile oil, too stiff for convenient use, and may be thinned by mixing it at a gentle heat with pure Oil of turpentine ; this mixture, however, does not produce that thorough incorporation of the consti-

tments which exists in the fresh Balsam; and it is consequently preferable to use in other ways the balsam which has become somewhat too stiff, and to have recourse to a fresh supply of liquid balsam for mounting-purposes.—In cases in which the Object might be injured by the heat required to soften the Balsam, it may be mounted in a solution of thickened Balsam in Chloroform, from which the volatile solvent will evaporate in a few hours. This solution should not be used until after it has stood for some weeks, in order that its components may be thoroughly incorporated.—When Canada balsam is to be employed as a *cement*, as for attaching sections, &c., to glass-slides (§ 139), it should be in a much stiffer condition; since, if it be dropped on the slide in too liquid a state, it will probably spread much wider and will lie in a thinner stratum than is desirable. This hardening process may be carried to any extent that may be desired, by exposing the Balsam in an uncorked jar (the mouth of which, however, should be covered with paper for the sake of keeping off dust) to a continual gentle heat, such as that of a water-bath.

159. In mounting Objects in Canada balsam, it is convenient to be provided with certain simple instruments, the use of which will save much time and trouble.—For the heat required, a Spirit Lamp is by far the best source, both as admitting of easy regulation, and as being perfectly free from smoke.—Where a number of Objects are being mounted on the same occasion, it will be found convenient to employ either a water-bath covered with a flat plate

FIG. 99.

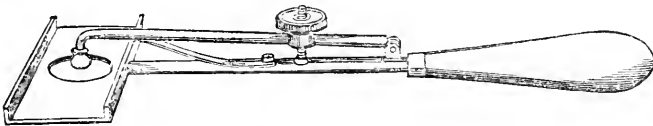

Smith's Mounting Instrument.

of metal, or a similar metal plate supported at such a distance above the lamp-flame (§ 153) as not to become more heated than it would be through a water-bath.*—For holding the slide whilst it is either being heated over the flame or is being subsequently

* Mr. Frederick Marshall has informed the Author that he has found the following very simple apparatus extremely convenient:—A Water-Bath made of tin, of such a size and shape as to afford a flat Stage for laying the slide upon, and also to receive into its interior a wide-mouthed bottle holding the balsam. If this Bath be filled with boiling water, the balsam is liquefied without the risk of the formation of air-bubbles; and the slide also is kept sufficiently warm during the mounting process. One supply of hot water will serve thus to mount from 12 to 20 objects. By marking on the Stage the outline of the slide and its central point, the right spot for laying the object upon the glass is indicated.

cooled, and at the same time applying a gentle pressure to the covering-glass, an ingenious and convenient *Mounting Instrument* has been devised by Mr. James Smith. This consists of a plate of brass turned up at its edges, of the proper size to allow the ordinary glass slide to lie loosely in the bed thus formed; this plate has a large perforation in its centre, in order to allow heat to be directly applied to the slide from beneath; and it is attached by a stout wire to a handle (Fig. 99). Close to this handle there is attached by a joint a second wire, which lies nearly parallel to the first, but makes a downward turn just above the centre of the slide-plate, and is terminated by an ivory knob; this wire is pressed upwards by a spring beneath it, whilst, on the other hand, it is made to approximate the other by a milled-head turning on a screw, so as to bring its ivory knob to bear with greater or less force on the covering glass. The use of this arrangement will be presently explained.—If such a mounting instrument be not employed, the wooden *Slider-Forceps* of Mr. Page (Fig. 100) will be found extremely convenient; this, by its

FIG. 100.

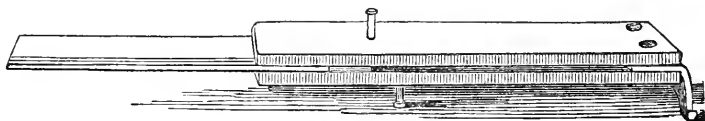

Slider Forceps.

elasticity, affords a secure grasp to a slide of any ordinary thickness, the wooden blades being separated by pressure upon the brass studs; and the lower stud, with the bent piece of brass at the junction of the blades, affords a level support to the forceps, which thus, while resting upon the table, keeps the heated glass from contact with its surface. This instrument will be found particularly useful when the balsam has to be hardened on the slide, for the purpose of cementing to it bodies of which thin sections are to be made.—Besides a pair of fine-pointed steel Forceps for holding the object to be mounted, there should be another of a commoner kind for taking-up the glass cover, the former being liable to be soiled with balsam.—A pair of stout Needles mounted in handles (§ 135) will be found indispensable, both for manipulating the object, and for breaking or removing air-bubbles; and if these handles be cut to a flat surface at the other extremity, they will serve also to press-down the glass covers, for which purpose a pointed stick also is useful.—For holding-down these covers whilst the balsam is cooling, if the elasticity of the objects should tend to make them spring-up, such as are not provided with the Mounting Instrument above described may advantageously employ the Spring Clip (Fig. 97); or, if its pressure is not firm

enough, recourse may be had to a simple Spring-Press made by a slight alteration of the 'American clothes-peg' which is now in general use in this country for a variety of purposes; all that is necessary being to rub-down the opposed surfaces of the 'clip' with a flat-file, so that they shall be parallel to each other when an ordinary slide with its cover is interposed between them (Fig. 101).

This contrivance, however, is defective in not allowing of the graduated pressure which may be made by the Mounting Instrument.—Great care should be taken to keep these implements free from

soils of Balsam; since the slides and glass-covers are certain to receive them. The readiest mode of cleansing the Needles (their 'temper' being a matter of no consequence for these purposes) is to heat them red-hot in the lamp, so as to burn-off the balsam; and then carefully to wipe them. The Forceps, both of wood and of metal, should be cleansed with Oil of Turpentine or with Methylated Spirit.

FIG. 101.

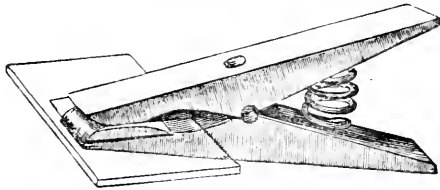

Spring Press.

160. Much of the success of mounting Objects in this mode will depend upon their previous preparation. Such hard objects as sections of *Shells* or *Echinus-spinics*, should be first well cleansed with water, and should then be thoroughly dried. Insect structures, on the other hand, are best macerated for some time in Oil of Turpentine, which will remove any greasiness they may contain, and will at the same time increase their transparence. When *Foraminifera* are to be mounted in Canada Balsam, long-continued maceration in Oil of Turpentine generally causes its entrance into their cavities; so that as the Turpentine is afterwards replaced by the Balsam, air-bubbles (of which it is otherwise very difficult to get rid) are avoided. Not only dry but moist objects (such as Fish-scales, Tongues of Mollusks, or Injected preparations) may be mounted in Canada Balsam, by soaking them successively for ten or fifteen minutes in Alcohol, Pyroxylic spirit, and Oil of Turpentine; the Water they at first contained being finally replaced by the last of these menstrua, which in its turn gives place to the Balsam.—In mounting an ordinary Object, a sufficient quantity of liquid balsam should be laid in the centre of the slide; this should be warmed but not boiled; and any air-bubbles which may make their appearance should either be caused to burst by touching them with the needle-point, or should be drawn to one side. The object, if it can be held in the fine-pointed forceps, should then be plunged into the drop of balsam; and, if it be not completely covered, a

little more balsam should be applied over it, care being taken, as before, to prevent over-heating, and to get rid of the bubbles as they rise.—In mounting minute Balsam-objects, such as Diatoms, Polycystina, or Sponge-spicules, and even objects of larger size, provided they be not of unusual thickness, great advantage will be obtained from following the plan suggested by Mr. James Smith, for which his Mounting Instrument (Fig. 99) is specially adapted. The slide being placed upon its slide-plate, and the object having been laid upon the glass in the desired position, the covering-glass is very gently laid upon this, and the ivory knob is to be brought down so as by a very slight pressure on the cover to keep it in its place. The slide is then to be very gently warmed, and the Balsam to be applied (which may be most conveniently done by means of the glass Syringe, § 158) at the edge of the cover, from which it will be drawn-in by capillary attraction, leaving no bubbles if too much heat be not applied. In this manner the objects are kept exactly in the places in which they were at first laid; and scarcely a particle of superfluous balsam, if due care has been employed, remains on the slide. The solution of Canada Balsam in Chloroform (§ 158) may be applied in the same manner without heat.—If the object contain numerous large air-spaces with ree openings, and be one whose texture is not injured by heat, the air may often be got-rid-of by boiling it in the Balsam; for the heat, causing the air to expand, drives-out a large proportion of it; this will be replaced, if it be allowed partly to cool, by the entrance of balsam; and then, by a second heating, the balsam being boiled within the cavities, its vapour expels the remaining air, and, on the condensation of the vapour, the liquid balsam runs-in and takes its place. For this method to succeed, however, it is essential that the balsam be prevented from becoming hard through boiling, by the addition of fresh liquid balsam from time to time; and it will often be found that, should vacuities remain which boiling does not remove, these contract or altogether disappear if the slide be kept for a few days at a gentle heat, the semi-fluid balsam being gradually forced into their place by the pressure of the surrounding air. There are many textures, however, which are extremely injured by a very slight excess of heat, having a tendency to curl-up and to become stiff and brittle; and the objects containing these are at once spoiled by boiling them in balsam. In such cases it is much better to have recourse to the assistance of the Air-pump;* for by placing the slide, with the object immersed in very liquid balsam, upon a tin or copper vessel filled with hot water, under the receiver, and then exhausting this, the air-bubbles will be drawn-forth, and, on the re-admission of the air, the balsam will be forced by its pressure into the place which they occupied. Some objects, however, retain the air with such tenacity as to require the repetition of the ex-

* Small Air-pumps, with a plate and receiver specially adapted for mounting purposes, are made by Mr. Baker and Mr. Collins.

hausting process two or three times; and in this case it is preferable to use Camphine or Oil of Turpentine instead of balsam, on account of its greater fluidity, and to warm even this to a temperature of about 100° .—There are certain cases, on the other hand, in which it is desirable to retain, instead of expelling, the Air contained within the cavities of the object. Thus, if minute Insects (such as Fleas) be displayed as transparent objects to show the ramifications of the Tracheæ, or if it be wished that a section of Tooth or Bone should be so mounted in balsam as to exhibit its canaliculi, the previous maceration in Oil of Turpentine should be never employed, and the Balsam employed should be some which has been previously hardened; this being melted without the use of more heat than is necessary, the object should be surrounded by it and the cover put on as quickly as possible; and the slide should then be laid upon a surface of stone or metal, the good conducting power of which, by causing the balsam to cool rapidly, diminishes its tendency to penetrate the substance of the object.—If a *deep* cell has to be filled with Canada Balsam, it is better to fill it in the first instance with Oil of Turpentine, and to immerse the specimen in this; liquid balsam being poured upon the object at one end, the Turpentine is to be allowed to flow out at the other by inclining the slide; then by laying the glass cover on one edge of the cell, and *gradually* lowering it until it lies flat, air may be entirely excluded.

161. When the Object is already attached to the Glass slide, the mounting in Canada Balsam is usually a matter of very little difficulty. If it be a soft tissue which has been spread-out and allowed to dry upon the glass for the purpose of securing it in its place, all that is necessary in the first instance is to dry it thoroughly, to shave or scrape it with a sharp knife if it should seem too thick, and to moisten its surface with Oil of Turpentine if it should not readily 'take' the balsam. The slide is then very gently warmed, a sufficient quantity of Balsam is spread over the surface of the specimen, with due care that it is 'taken' in every point, and the glass cover is put-on. If the preparation cover a large area, great care should be taken in letting-down the cover *gradually* from one side, so as to drive a wave of balsam before it which shall sweep away air-bubbles; raising it a little, and introducing a small quantity of fresh balsam, if any vacuity present itself as it descends.—The preferable mode of mounting thin sections of hard bodies, however, will depend in great degree upon the size of the section and the tenacity of its substance. Where its area is great and its texture brittle, its removal from the glass on which it has been ground-down to another slip cannot be accomplished, even by the most dexterous management, without considerable risk of breaking it; and although, by the friction of the glass upon the stone, the surface of the slide will probably have been scratched or roughened, yet this is a dis-sight about which the scientific Microscopist will care but little, as it only affects the saleable value of such objects. Nothing

more will in this case be necessary, than to lay some liquid Balsam on the surface of the section, to warm it gently, and then to place on it a thin-glass cover of suitable dimensions, gently pressing this down wherever the balsam happens to be thickest, and endeavouring to drive all air-bubbles before a wave of liquid, until they are entirely expelled, or at any rate are driven beyond the margin of the section. If this operation be not at once successful, —either a few large air-bubbles, or a great number of smaller ones, which cannot be got-rid-of by gentle pressure, being visible between the surface of the section and the covering-glass,—it is better at once to remove the cover by gentle warmth applied to its *upper* surface, and to repeat the operation with an additional supply of balsam, rather than to attempt to drive-out the bubbles by any manipulation. Whatever treatment be adopted, special care should always be taken not to apply so much heat as to *melt* the hard balsam *beneath* the section, or to *boil* the thin balsam *above*; and this may be best managed by turning the slide with its face downwards, so that the heat may be applied directly to the thin-glass cover and to the balsam in contact with it, instead of acting on this *through* the slide and the object attached to it. If the heat should unfortunately be carried so far as to *boil* the cement *beneath* the section, there will be little chance, if its area be large, of getting-rid of the bubbles thus produced, without removing it altogether from the glass to which it was attached, or, at any rate, without pushing it along the glass in such a way as to slide it away from the bubbles; in that case, the part towards which it is moved should always be well supplied with balsam, and the bubbles that remain should be drawn away or broken with the needle-point; after which, the section being slid-back to its original position, it is probable that no bubbles may be found beneath it.—In cases, however, in which the *appearance* of the preparation is an object of much consideration, and in which the tenacity of the substance and the small size of the section prevent much risk of its breaking in the transfer, it may be loosened from the glass to which it was first attached, either by heat, or by soaking in Ether or Chloroform. The former, being the simplest and readiest method, is the one most commonly practised; the only difficulty lies in lifting-off the specimen without breaking it; and this may best be done by means of a camel-hair brush dipped in Oil of Turpentine. The glass to which the section is to be transferred should have a large spot of liquid balsam laid in the proper place; the object is to be laid on this, and its upper surface covered with the like balsam; and then, the thin-glass cover being placed upon it, this is to be gently pressed down in the manner already described. If Ether or Chloroform be had recourse to, the slide should be placed in a wide-mouthed bottle of that liquid, which should then be corked or stopped; and after a time the section will be found to be lying detached in it, whence it may be taken-up either by the forceps or by a camel-hair brush.—Such

a transfer will often be found advantageous before the final completion of the reducing-process ; for it will occasionally happen that we find something in the structure of the specimen, which will be best displayed by rubbing it down afresh on the side first attached to the glass ; and, when a number of small sections are being made at once (which it is often very convenient to do, not only in the case already mentioned, § 138, but in many others), it not only saves time, but ensures the accurate flattening of the surface in grinding, to fix several upon the same slip, and to work them down together until the requisite thinness has been nearly attained, when they must be transferred to separate slips, and finished one by one. In either case, the re-attachment must of course be made, like the original attachment, with Balsam which has been first hardened (§ 139).

162. When the Balsam employed in mounting has remained in the liquid condition here recommended, the glass cover will not be secure from displacement until the balsam has become harder. This change it will require a long time to undergo, unless the aid of a gentle continuous warmth be afforded. Nothing is more suitable for this purpose than the warmth of a Chimney-piece immediately above the fire-place ; as it is quite sufficient to produce the effect in the course of a few days, whilst there is no danger of its becoming excessive ; but in default of this convenience, an oven carefully regulated, or (still better) a water-bath, may be employed. Whether either of these means be adopted, or the slides be put aside for the Balsam to be hardened by time, they should always be laid in the *horizontal* position, that their covers may not be caused by gravitation to slip down from their places.—It may be better, before submitting the slides to this hardening process, to scrape from their surface any superfluous Balsam that does not immediately surround the glass-cover ; but the knife should never be carried so near to the edge of this, as to run any risk of displacing it ; and it is much better to defer the final cleaning of the slide, until the attachment of the cover has become firm. The remaining Balsam may then be scraped away with a knife or small chisel, the implement being warmed if the balsam be very stiff ; the slide should be rubbed with a rag dipped in Oil of Turpentine until every perceptible soil of balsam is removed, especial care being taken to cleanse the surface and edges of the glass-cover : and as this will itself leave a certain resinous film, it is better to give the slide a final cleansing with Methylated Spirit. If its surface should have been considerably smeared with balsam, it is very convenient, after scraping away all that can be removed in that manner, to scrub it with a soft tooth-brush or an old nail-brush, first letting fall on it a few drops of Turpentine or Methylated Spirit ; and there is less risk of displacing the glass-cover in this mode, than in rubbing it any other way.—The menstrua which serve thus to cleanse the slides, of course answer equally well for cleansing the hands. The most ready solvents for Balsam are

Ether and Chloroform ; but the ordinary use of these being interdicted by their costliness, and by the quickness with which they are dissipated by evaporation, Alcohol, Methylated Spirit, Wood Naphtha, or Oil of Turpentine may be used in their stead.

163. *Preservative Media*.—Objects which would lose their characters in drying, and which cannot be suitably mounted in Canada Balsam, can of course only be preserved in anything like their original condition by mounting in fluid ; and the choice of the fluid to be employed in each case will depend upon the character of the object and the purpose aimed-at in its preservation. As specific directions will be given hereafter in regard to most of the principal classes of Microscopic preparations, little more will be required in this place than an enumeration of the preservative Media, with a notice of their respective qualities.—For very minute and delicate Vegetable objects, especially those belonging to the orders Desmidiaceæ and Diatomaceæ, nothing seems to produce less alteration in the disposition of the endochrome, or serves better to preserve their colour, than *Distilled Water* ; provided that, by the complete exclusion of air, the vital processes and decomposing changes can be alike suspended. This method of mounting, however, is liable to the objection that Confervoid growths sometimes make their appearance in the preparation, which may be best prevented by saturating the water with *camphor*, or shaking it up with a few drops of *creosote*, or (if the preservation of colour be not an object) by adding about a tenth part of *alcohol*, or (where the loss of colour would be objectionable) by dissolving a grain of alum and a grain of bay-salt in an ounce of water. For larger preparations of Algae, &c., what is called *Thwaites's Fluid* may be employed ; this is prepared by adding to one part of Rectified Spirit as many drops of Creosote as will saturate it, and then gradually mixing up with it in a pestle and mortar some prepared Chalk with 16 parts of Water ; an equal quantity of Water saturated with Camphor is then to be added, and the mixture, after standing for a few days, is to be carefully filtered. A liquid of this kind also serves well for the preservation of many Animal preparations, but becomes turbid when thus employed in large quantity ; and the following modification is recommended by Dr. Beale. Mix 3 drachms of Creosote with 6 ounces of Wood-Naphtha, and add in a mortar as much prepared Chalk as may be necessary to form a smooth thick paste ; water must be gradually added to the extent of 64 ounces, a few lumps of Camphor thrown in, and the mixture allowed to stand for two or three weeks in a lightly-covered vessel, with occasional stirring ; after which it should be filtered, and preserved in well-stoppered bottles.—Of late years, diluted *Glycerine* has been much used as a preservative fluid ; it allows the colours of Vegetable substances to be retained, but, as usually employed, it alters the disposition of the endochrome ; and confervoid growths are apt to make their

appearance in it. The best proportion seems to be one part of Glycerine to two parts of Camphor-water. The following method of using Glycerine, devised by Herr Hantzsch, of Dresden, is said to be peculiarly effective for minute Vegetable preparations:—A mixture is made of 3 parts of pure Alcohol, 2 parts of Distilled Water, and 1 part of Glycerine: and the object, laid in a cement-cell, is to be covered with a drop of this liquid, and then put aside under a bell-glass. The Alcohol and Water soon evaporate, so that the Glycerine alone is left; and another drop of the liquid is then to be added, and a second evaporation permitted; the process being repeated, if necessary, until enough Glycerine is left to fill the cell, which is then to be covered and closed in the usual mode.* The preparation known as *Deane's Gelatine* is one of the most convenient media for preserving the larger forms of Confervæ and other Microscopic Algæ, as well as sections of such as are still more bulky. This is prepared by soaking 1 oz. of Gelatine in 4 oz. of Water until the gelatine is quite soft, and then adding 5 oz. of Honey previously raised to boiling heat in another vessel: the whole is then to be made boiling hot, and when it has somewhat cooled, but is still perfectly fluid, 6 drops of Creosote and $\frac{1}{2}$ oz. of Spirit of Wine, previously mixed together, are to be added, and the whole is to be filtered through fine flannel. This composition, when cold, forms a very stiff jelly; but it becomes perfectly fluid on the application of a very slight warmth, and may then be used like any other preservative liquid, care being taken, however, that the slide and the glass cover are themselves gently warmed before it comes into contact with them. The purpose which the honey answers in this medium—that of preventing it from becoming too hard—may be as well, or in some cases better, answered by Glycerine; and the *Glycerine Jelly*, prepared by the following process (see Lawrance in "Quart. Journ. of Microsc. Science," Vol. vii. 1859, p. 257), may be very strongly recommended as good for a great variety of objects, Animal as well as Vegetable, subject to a caution to be presently given:—"Take any quantity of Nelson's Gelatine, and let it soak for two or three hours in cold water; pour off the superfluous water, and heat the soaked gelatine until melted. To each fluid ounce of the Gelatine add one drachm of Alcohol, and mix well; then add a fluid drachm of the white of an egg. Mix well while the gelatine is fluid, but cool. Now boil until the albumen coagulates, and the gelatine is quite clear. Filter through fine flannel, and to each fluid ounce of the clarified Gelatine add six fluid drachms of Price's pure Glycerine, and mix well. For the six fluid drachms of glycerine a mixture

* See the Rev. W. W. Spicer's "Handy-Book to the Collection and Preparation of Freshwater and Marine Algæ, &c.," pp. 57-59. "Nothing," says Mr. Spicer, "can exceed the beauty of the preparations of *Desmidiaceæ* prepared after Herr Hantzsch's method; the form of the plant and the colouring of the endochrome having undergone no change whatever."

of two parts of Glycerine to four of Camphor-water may be substituted. The objects intended to be mounted in this medium are best prepared by being immersed for some time in a mixture of one part of Glycerine with one part of diluted Alcohol (1 of alcohol to 6 of water).”* For many objects which would be injured by the small amount of heat required to melt either of the two last-mentioned media, the *Glycerine and Gum* medium of Mr. Farrants will be found very useful. This is made by dissolving 4 parts (by weight) of picked Gum Arabic in 4 parts of cold Distilled Water, and then adding 2 parts of Glycerine. The solution must be made without the aid of heat, the mixture being occasionally stirred, but not shaken, whilst it is proceeding: after it has been completed, the liquid should be strained (if not perfectly free from impurity) through fine cambric previously well washed out by a current of clean cold water; and it should be kept in a bottle closed with a glass stopper or cap (not with cork), containing a small piece of Camphor. The great advantage of this medium is that it can be used cold, and yet soon viscifies without cracking; it is well suited to preserve delicate Animal as well as Vegetable tissues, and in most cases increases their transparence. For the preservation of Microscopic preparations of *Animal* structures, a mixture of one part of Alcohol and five of Water will generally answer very well, save in regard to the removal of their colours; if it should have the effect of rendering them opaque, this will be neutralized by the addition of a minute quantity of Soda. A mixture of Glycerine and Camphor-water in about the same proportion answers very well for many objects, especially when it is desired to increase their transparence, and it is more favourable than Diluted Alcohol to the preservation of colour; but in using this menstruum it must be borne in mind that Glycerine has a solvent power for Carbonate of Lime, and should not be employed when the object contains any Calcareous structure.† For preserving very soft and delicate marine Animals, such as the smaller Medusæ and Annelida, the Author has found a mixture of about one-tenth of Alcohol and the same of Glycerine, with *Sea-water*, the most effectual in preserving their natural appearance; and the same mixture, with increased proportions of alcohol and glycerine, answers very well for larger objects. For Zoophytes, and many other marine objects,

* A very pure Glycerine jelly, of which the Author has made considerable use, is prepared by Mr. Rimmington, chemist, Bradford, Yorkshire.

† In ignorance of this fact, the Author employed Glycerine to preserve a number of remarkably fine specimens of the Pentacrinoid larva of the *Comatula* (Plate XXI.), whose colours he was anxious to retain; and was extremely vexed to find, when about to mount them, that their Calcareous skeletons had so entirely disappeared that the specimens were completely ruined. This result might perhaps be prevented, if the Glycerine were previously saturated with Carbonate of Lime, by keeping it for some time in a bottle with chips of Marble.

again, recourse may be advantageously had to *Goadby's Solution*, which is made by dissolving 4 oz. of Bay-salt, 2 oz. of Alum, and 4 grains of Corrosive Sublimate, in 4 pints of boiling water: this should be carefully filtered before it is used; and for all delicate preparations it should be diluted with an equal bulk, or even with twice its bulk, of water. This solution must not be used where any Calcareous texture, such as Shell or Bone, forms part of the preparation; and one of Mr. Goadby's other solutions (8 oz. of bay-salt and 2 grs. of corrosive sublimate, to a quart of water,—or, in cases where the coagulating action of Corrosive Sublimate on Albuminous matters would be an objection, the substitution of 20 grains of Arsenious acid,) may be used in its stead. Preparations of the Animal Tissues to be examined as transparent objects under high magnifying powers, may usually be advantageously mounted either in Farrants's medium or in Glycerine-jelly. Carbolic Acid has recently been employed as a preservative medium; but the Author has had no experience of its use.—It is often quite impossible to predicate beforehand what Preservative Medium will answer best for a particular kind of preparation; and it is consequently desirable, where there is no lack of material, always to mount the same object in two or three different ways, marking on each slide the method employed, and comparing the specimens from time to time, so as to judge how each is affected. It may be stated, however, as a general rule, that objects to be viewed by light *reflected* from their surfaces should *not* be mounted in either of the Gelatinous media, but in Diluted Alcohol, Goadby's Solution, or some other liquid which does not tend to render them transparent. Objects mounted in Gelatinous media, on the other hand, are often shown admirably by Black-ground Illumination (§ 84).

164. *Of Mounting Objects in Fluid.*—As a general rule, it is desirable that objects which are to be mounted in fluid should be soaked in the particular fluid to be employed, for some little time before mounting; since, if this precaution be not taken, air-bubbles are very apt to present themselves. It is sometimes necessary, in order to secure the displacement of air contained in the specimen, to employ the Air-pump in the mode already directed (§ 160); but it will generally be found sufficient to immerse the specimen for a few minutes in Alcohol (provided that this does not do any detriment to its tissues), which will often penetrate where water will not make its way; and when the spirit has driven out the air, the specimen may be removed back to water, which will gradually displace the spirit. When Deane's Gelatine or Glycerine-jelly is used, however, all that can be done will be to drain the object of superfluous water before applying the liquefied medium; but as air-bubbles are extremely apt to arise, they must be removed by means of the Air-pump, the Gelatine being kept in a liquid state by the use of a vessel of hot water, as in the case of Canada balsam. In dealing with the

small quantities of fluid required in mounting Microscopic objects, it is essential for the operator to be provided with the means of transferring very small quantities from the vessel containing it to the slide, as well as of taking up from the slide what may be lying superfluous upon it. Where some one fluid, such as Diluted Alcohol or Goadby's Solution, is in continual use, it will be found very convenient to keep it in a small Bottle of the kind represented in Fig. 102, which is now in general use as a Dropping-bottle. The stopper is perforated, and is elongated below into a fine tube, whilst it expands above into a bulbous funnel, the mouth

FIG. 102.



Dropping Bottle.

of which is covered with a piece of thin Vulcanized India-rubber tied firmly round its lip. If pressure be made on this cover with the point of the finger, and the end of the tube be immersed in the liquid in the bottle, this will rise into it on the removal of the finger; if, then, the funnel be inverted, and the pressure be re-applied, some of the residual air will be forced out, so that by again immersing the end of the tube, and removing the pressure, more fluid will enter. This operation may be repeated as often as may be necessary, until the bulb is entirely filled; and when it is thus charged

with fluid, as much or as little as may be needed is then readily expelled from it by the pressure of the finger on the cover, the bulb being always refilled if care be taken to immerse the lower end of the tube before the pressure is withdrawn. The Author can speak from large experience of the value of this little implement; as he can also of the utility of the small Glass Syringe (§ 101) for the same purpose.

165. There are many Objects of extreme thinness, which require no other provision for mounting them in fluid than an ordinary Glass slide, a Thin Glass cover, and some Gold-size or Asphalte (§ 152). The object having been laid in its place, and a drop of the fluid laid upon it (care being taken that no air-space remains beneath the under side of the object and the surface of the slide), the glass cover is then to be laid upon it, one side being first brought into contact with the slide, and the other held up by a needle-point, and gradually lowered in such a manner that the air shall be all displaced before the fluid. If any air-bubbles remain in the central part of the space between the cover and the slide, the former must be raised again, and more fluid should be introduced; but if the bubbles be near the edge, a slight pressure on that part of the cover will often suffice to expel them, or the cover may be a little shifted so as to bring them to its margin.

There are some objects, however, whose parts are liable to be displaced by the slightest shifting of this kind; and it is more easy to avoid making air-bubbles by watching the extension of the fluid as the cover is lowered, and by introducing an additional supply when and where it may be needed, than it is to get rid of them afterwards without injury to the object. When this end has been satisfactorily accomplished, all that is needed is, first to remove all superfluous fluid from the surface of the slide, and from *around* the edge of the cover, with a piece of blotting-paper, taking care not to draw away any of the fluid from *beneath* the cover, or (if any have been removed accidentally) to replace what may be deficient; and then to make a circle of asphalte or gold-size around the cover, taking care that it 'wets' its edges, and advances a little way upon its upper surface. When this first coat is dry, another should be applied, particular care being taken that the cement shall fill the angular furrow at the margin of the cover. In laying on the second coat, it will be convenient, if the cover be round, to make use of the Turn-table (Fig. 103); and if the slide be so carefully laid upon it that the glass-cover is exactly concentric with its axis, the turn-table may be used even for the first application of the varnish, though a slight error in this respect may occasion the displacement of the cover.—By far the greater number of preparations which are to be preserved in liquid, however, should be mounted in a Cell of some kind, which forms a *well* of suitable depth, wherein the preservative liquid may be retained. This is *absolutely necessary* in the case of all objects whose thickness is such as to prevent the glass-cover from coming into close approximation with the slide; and it is *desirable* whenever that approximation is not such as to cause the cover to be drawn to the glass-slide by capillary attraction, or whenever the cover is *sensibly* kept apart from the slide by the thickness of any portion of the object. Hence it is only in the case of objects of the most extreme tenuity, that the Cell can be advantageously dispensed with; the danger of *not* employing it, in many cases in which there is no difficulty in mounting the object without it, being that after a time the cement is apt to run-in beneath the cover, which process is pretty sure to continue when it may have once commenced.

166. *Cement-Cells*.—When the cells are required for mounting very thin objects, they may be advantageously made of varnish only, by the use of the Turn-table (Fig. 103) contrived by Mr. Shadbolt. This consists of a small slab of mahogany, into one end of which is fixed a pivot, whereon a circular plate of brass, about three inches in diameter, is made to rotate easily, a rapid motion being given to it by the application of the forefinger to the milled-head seen beneath. The Glass slide being laid upon the Turn-table, in such a manner that its two edges shall be equidistant from the centre (a guide to which is afforded by a circle

of an inch in diameter, traced upon the brass), and being held by the springs with which it is furnished, a camel-hair pencil dipped in the varnish to be used (Asphalte or Black Japan is the best) is held in the right hand, so that its point comes into contact with the glass, a little within the guiding circle just named. The Turn-table being then put into rotation with the left hand, a ring of varnish of a suitable breadth is made upon the glass; and if the slide be set-aside in a horizontal position, this

FIG. 103.

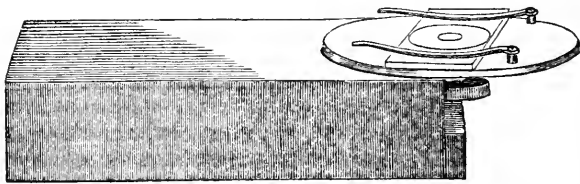

Shadbolt's Turn-table for making Cement-Cells.

ring will be found, when dry, to have lost the little inequalities it may have at first presented, and to possess a very level surface. If a greater thickness be desired than a single application will conveniently make, a second layer may be laid-on after the first is dry. It is convenient to prepare a number of these cells at one time, since, when 'the hand is in,' they will be made more dexterously than when the operation is performed only once; and it will be advantageous to subject them to the warmth of a slightly-heated oven, whereby the flattening of their surface will be more completely assured. The Microscopist will find it a matter of great convenience to have a stock of these cells always by him, ready prepared for use.

167. *Thin-Glass Cells*.—For the reception of objects too thick for Cement-cells, but not thicker than ordinary Thin-glass, Cells may be advantageously constructed by perforating pieces of Thin-Glass with apertures of the desired size, and cementing these to glass-slides with marine-glue. For making *round* cells, the perforated pieces that sometimes remain entire after the cutting of disks (§ 149) may be employed, the disks often falling-out of themselves when the glass is laid aside for a few days; and thus the same piece of thin-glass may afford a plate, which, when cemented to a glass-slide forms a cell, and a disk suitable as the cover to a cell of somewhat smaller size. There is great danger, however, of the cracking of the surrounding glass in the cutting out of the disk, especially when this is of large size; and it will generally be found a saving of trouble to employ the method recommended by Dr. L. Beale, which consists in attaching a piece

of thin-glass to one of the glass rings of which the deeper cells are made (§ 170), of any form that may be desired, by means of marine-glue first laid upon the latter and melted upon the hot plate; when the glue is quite cold, the point of a round or semi-circular file is sharply thrust through the centre of the thin-glass, which is then to be carefully filed to the size of the interior of the ring; and the ring being then heated a second time on the hot plate, the thin-glass plate may be readily detached from it, and at once cemented upon the glass-slide. The success of this simple process depends upon the very firm and intimate adhesion of the thin-glass to the ring, which prevents any crack from running into the part of the thin-glass that is attached to it, however roughly the file may be used. By having many of the rings on the hot-plate at once, and operating with them in turn, a great number of cells can be made in a short time; and such large thin cells may be made in this mode, as could scarcely be fabricated (on account of the extreme brittleness of this glass) by any other. After the thin-glass has been cemented to the slide, it is desirable to roughen its upper surface by rubbing it upon a leaden or pewter plate (§ 138) with fine emery; since the gold-size or other varnish adheres much more firmly to a 'ground' than to a polished surface. Instead of thin-glass, thin rings of Tin may be employed (§ 171), provided that the fluid used in mounting is not one that acts upon that metal.

168. *Sunk and Plate-Glass Cells.*—For mounting objects of somewhat greater thickness than can be included within thin-glass cells, *shallow Cells* may be made by grinding-out a concave (either circular or oval) in the thickness of a glass plate (Fig. 104.) An *à priori* objection naturally suggests itself to the use of such cells, —that the concavity of their bottom will so deflect the course of the illuminating rays as to distort or obscure the image; but to this it may be replied that when the cell is filled with water or with some liquid of higher refractive power, such deflection will in effect be found very small; and the Author can now say from a large experience that it is practically inoperative. Such cells until recently were costly; but being now made in large quantities, their price has been so much reduced that they may be obtained more cheaply than cells of any other kind.* For objects whose shape adapts them to the form and depth of the concavity, these cells will be found peculiarly advantageous; since they do not hold air-bubbles so tenaciously as do those with perpendicular walls, and there is no cemented plate or ring to be loosened from its attachment, either by a sudden 'jar,' or by the lapse of time. When transparent objects are mounted in them, it is important to take care that the

* They are sold by Messrs. Jackson, Oxford-street, either of round or oval form, Fig. 104, A, B; and not only ground-out of slides of the usual size (3 in. by 1 in.) and substance, but also hollowed in pieces of plate glass of larger dimensions (c) and much greater thickness.

concave bottom is free from scratches and roughness.—Where shallow cells are required with flat bottoms, they may be made by drilling apertures of the desired size in pieces of plate-glass of the requisite thickness, and by attaching these with marine-glass to glass-slides (Fig. 105). Such holes may be made not merely circular (A), but oval (C); and a very elongated perforation may be

FIG. 104.

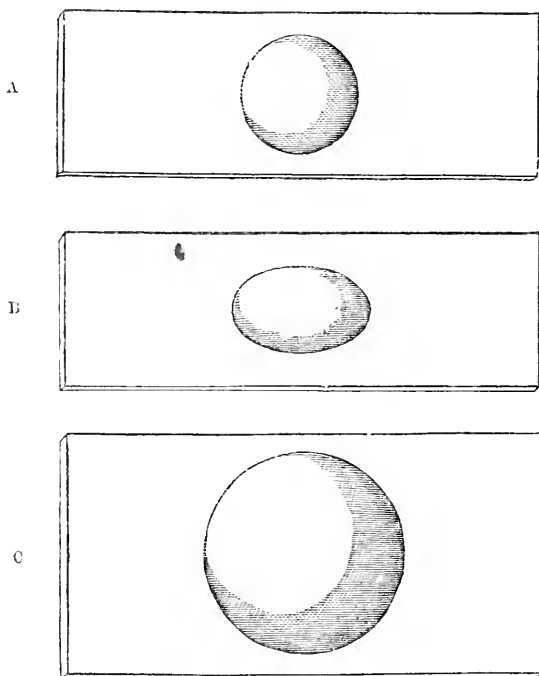

Sunk Cells.

made by drilling two holes at the required distance, and then connecting them by cutting out the intermediate space (B). *Deep Cells*, such as are required for mounting preparations of considerable thickness, may be made by drilling through a piece of *thick* Plate-Glass, and cementing it in the usual way (D). These operations, however, can scarcely be performed by any but regular glass-cutters, and, being troublesome, are expensive; hence the Plate-glass cells have been generally superseded, either by *Tube-Cells* or by *Built-up Cells*.

169. *Tube-Cells*.—These are made by cutting transverse sections of thick-walled Glass tubes of the required size, grinding the sur-

faces of these rings to the desired thinness, and then cementing them to the glass-slides with marine-glass. Not only may *round* cells (Fig. 106, A, B) of any diameter and any depth that the Microscopist can possibly require* be made by this simple method, but oval, square-shaped, or oblong cells (C, D) are now made of the forms and sizes that he is most likely to want, by flattening the round glass-tube whilst hot, or by blowing it within a mould.— Instead of sections of Glass Tubes, it is less costly, and not in other

FIG. 105.

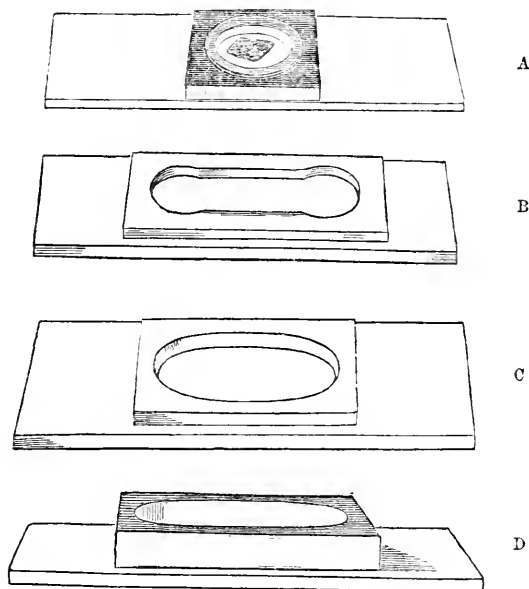

Plate-Glass Cells.

respects disadvantageous, to employ *Metallic Rings*, which being cemented to Glass-slides in the usual way, form Cells fitted to retain any liquids which do not act chemically upon them. After a trial of different metals, *Tin* has been found most suitable; and rings of several different sizes and thicknesses are now made of this metal for the use of the Microscopist. They are even preferable to rings of glass in this respect, that a perfectly flat surface may be given to them by slight friction with water on a Water-of-

* The Author has employed gigantic cells of this construction, 10 inches in diameter and $1\frac{1}{2}$ inch deep, for the preservation of Star-fish in Glycerine; but for such purposes he is disposed to think that rings of Porcelain, which might be made at a much less cost, would be equally effective.

Ayr stone, after they have been cemented to the glass-slides ; and this will be found the best preventive against the running-in of the Gold-size, which often takes place with Glass-tube cells in consequence of their inequality of surface.

FIG. 106.

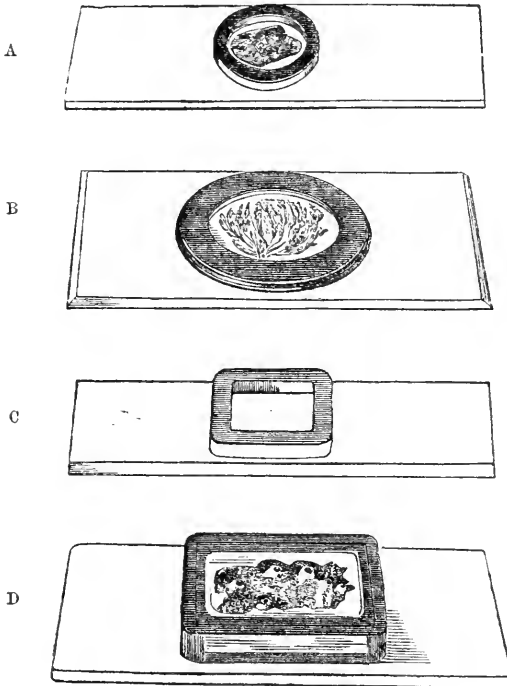

Tube-Cells, Round and Quadrangular.

170. *Built-up Cells*.—When Cells are required of forms or dimensions not otherwise procurable, they may be *built-up* of separate pieces of Glass cemented together. Large *shallow* Cells, suitable for mounting Zoophytes or similar flat objects, may be easily constructed after the following method :—A piece of Plate-Glass, of a thickness that shall give the desired depth to the cell, is to be cut to the dimensions of its outside wall ; and a strip is then to be cut off with the diamond from each of its edges, of such breadth as shall leave the interior piece equal in its dimensions to the cavity of the cell that is desired. This piece being rejected, the four strips are then to be cemented upon the glass-slide in their original position, so that the diamond-cuts shall fit together with the most exact precision ; and the upper surface is then to be

ground flat with emery upon the pewter plate, and left rough as before. The perfect construction of large *deep* Cells of this kind, (Fig. 107, A, B), however, requires a nicety of workmanship which few amateurs possess, and the expenditure of more time than Microscopists generally have to spare ; and as it is consequently preferable to obtain them ready-made, directions for making them need not be here given. A plan of making deep cells, however, has been introduced by Dr. L. Beale ; which, though it does not give them side walls possessing the same flatness with those of the built-up cells, adapts them to serve most of the purposes for which these are required, and makes them more secure against leakage ; whilst it has the advantage of being so easy and simple that any one may put it into practice. A long strip of Plate-Glass is to

FIG. 107.

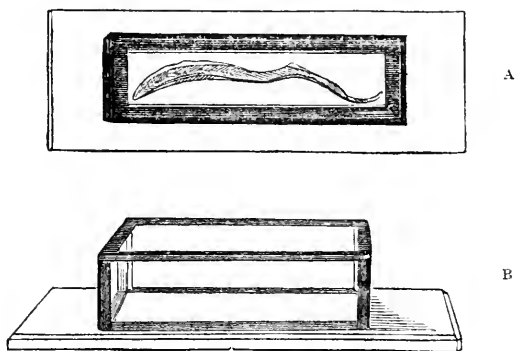

Built-up Cells.

be taken, whose breadth is equal to the desired depth of the cell, and whose length must be equal to the sum of the lengths of all its sides. This strip is to be carefully bent to a right angle in the blow-pipe flame, at three points previously indicated by marks so placed as to show where the angles should fall ; and the two ends, which will thus be brought into contact at right angles, are to be fused together. Thus a large square well, slightly rounded at the angles, will be formed ; and this being very brittle, should be allowed to cool very gradually, or, still better, should be annealed in an oven. It must then be ground quite true on its upper and lower edges, either on the lead-plate with emery, or on a flat stone with fine sand ; and it may then be cemented to a Glass-Slide in the usual way.

171. *Mounting Objects in Cells.*—In mounting an object in a Cell, the first attention will of course be given to the cleanness of the interior of the cell, and of the glass-cover which is to be placed on it : this having been secured, the cell is to be filled with fluid

by the Dropping-bottle or Syringe, and any minute air-bubbles which may be seen adhering to its bottom or sides must be removed by the needle; the object, previously soaked in fluid resembling that with which the cell is filled, is then to be placed in the cell, and should be carefully examined for Air-bubbles on all sides, and also by looking up from beneath. This examination should be made with a Hand-Magnifier or Simple Microscope; Quekett's Dissecting Microscope (Fig. 29) being so especially suited to the purpose, that the Author never mounts an object in fluid without making use of it. When every precaution has been taken to free the cell from these troublesome intruders, the cover may be placed on it, one side being first brought down upon its edge, and then the other; and if the cell have been previously brimming over with fluid (as it ought to be), it is not likely that any air-space will remain. If, however, any bubbles should present themselves beneath the cover, the slide should be inclined, so as to cause them to rise towards the highest part of its circumference, and the cover slipped away from that part, so as to admit of the introduction of a little additional fluid by the pipette or syringe; and when this has taken the place of the air-bubbles, the cover may be slipped back into its place.* All superfluous fluid is then to be taken up with blotting-paper; and particular care should be taken thoroughly to dry the surface of the cell and the edge of the cover, since the varnish will not hold to them if they be in the least damp with water. Care must also be taken, however, that the fluid be not drawn away from between the cover and the edge of the cell on which it rests; since any deficiency here is sure to be filled up by varnish, the running-in of which is particularly objectionable. These minutiae having been attended to, the closure of the cell may be at once effected by carrying a thin layer of Gold-size or Asphalte around and upon the edge of the glass-cover, taking care that it touches every point of it, and fills the angular channel which is left around its margin. If the wall of the cell be very thin, it will be very advantageous to include it in the ring of varnish, so as to make it hold down the cover, not only on the cell, but on the slide beneath; and this will help to secure it against the separation of the ring from the slide, which is apt to be produced by a 'jar' after the lapse of time. The Author has found it advantageous, however, to delay closing the cell for some little

* Mr. Quekett and some other practised Manipulators recommend that the edges of the cell and that of the disk of glass be smeared with the gold-size or other varnish employed, before the cell is filled with fluid; but the Author has found this practice objectionable, for two reasons,—first, because it prevents the cover from being slipped to one side (which is often desirable) without its being soiled by the varnish,—and second, because when the edge of the cell has been thus made to 'take' the varnish, that which is afterwards applied for the closure of the cell is more likely to run in, than if the whole of the surface covered by the glass is moistened with an aqueous fluid.

time after the superfluous fluid has been drawn off ; for as soon as evaporation beneath the edges of the cover begins to diminish the quantity of fluid in the cell, air-bubbles often begin to make their appearance, which were previously hidden in the recesses of the object ; and in the course of half an hour, a considerable number are often collected. The cover should then be slipped aside, fresh fluid be introduced, the air-bubbles removed, and the cover put on again ; and this operation should be repeated until it fails to draw forth any more air-bubbles. It will of course be observed that if the evaporation of fluid should proceed far, air-bubbles will *enter* beneath the cover ; but these will show themselves on the *surface* of the fluid ; whereas those which arise from the object itself are found in the deeper parts of the cell. Much time may be saved, however, and the freedom of the preparation from air-bubbles may be most effectually secured, by placing the cell, after it has been filled in the first instance, in the vacuum of an Air-Pump (§ 160) ; and if several objects are being mounted at once, they may all be subjected to the exhausting process at the same time. The application of the varnish should be repeated after the lapse of a few hours, and may be again renewed with advantage several times in the course of a week or two ; care being taken that each layer covers the edges, as well as the whole surface, of that which preceded it. Even when a considerable length of time has elapsed without the appearance of air-bubbles, the mounting should not be considered secure ; for a crack may form in the varnish, through which air may find its way : and thus any one who has a large collection of objects mounted in fluid is pretty sure to find, on examining them from time to time, that some of them have undergone deterioration from this cause. It is well, therefore, to adopt the precautionary measure of re-varnishing the entire collection periodically (say, once a year), the slight trouble which this occasions being amply compensated by the preservation of valuable specimens that might otherwise go to ruin.

172. The presence of Air-bubbles in any preparation mounted in fluid is to be particularly avoided, not merely on account of its interference with the view of the object, but also because, when air-spaces, however small, once exist, they are almost certain to increase, until at last they take the place of the entire fluid, and the object remains dry. Even in the hands of the most experienced manipulators this misfortune not unfrequently occurs ; being sometimes due to the obstinate entanglement of air-bubbles in the object when it was originally mounted, and sometimes to the perviousness of some part of the cement, which has allowed a portion of the contained fluid to escape, and air to find admission. In either case, so soon as an air-bubble is seen in such a preparation, the attempt should be made to prevent its increase by laying on an additional coat of varnish ; but if this should not be successful, the cover should be taken off and the specimen

remounted, so soon as the fluid has escaped to such a degree as to leave any considerable portion of it uncovered.

173. *Importance of Cleanliness.*—The success of the result of any of the foregoing operations is greatly detracted from, if, in consequence of the adhesion of foreign substances to the glasses whereon the objects are mounted, or to the implements used in the manipulations, any extraneous particles are brought into view with the object itself. Some such will occasionally present themselves, even under careful management; especially fibres of silk, wool, cotton, or linen, from the handkerchiefs, &c., with which the glass-slides may have been wiped; and grains of starch, which often remain obstinately adherent to the thin-glass covers kept in it. But a careless and uncleanly manipulator will allow his objects to contract many other impurities than these; and especially to be contaminated by particles of dust floating through the air, the access of which may be readily prevented by proper precautions. It is desirable to have at hand a well-closed cupboard furnished with shelves, or a cabinet of well-fitted drawers, or a number of bell-glasses upon a flat table, for the purpose of securing glasses, objects, &c., from this contamination in the intervals of the work of preparation; and the more readily accessible these receptacles are, the more use will the Microscopist be likely to make of them. Great care ought, of course, to be taken that the Liquids employed for mounting should be freed by effectual filtration from all floating particles; and both these and the Canada Balsam should be kept in well-closed bottles.

174. *Labelling and Preserving of Objects.*—Whenever the mounting of an object has been completed, its name ought to be at once marked on it, and the slide should be put away in its appropriate place. Some inscribe the name on the glass itself with a writing diamond; whilst others prefer to gum a label* on the slide; and others, again, cover one or both surfaces of the slide with coloured paper, and attach the label to it. In the case of objects mounted dry or in balsam, the latter method has the advantage of rendering the glass-cover more secure from displacement by a slight blow or 'jar,' when the varnish or balsam may have become brittle by the lapse of years. Instead, however, of attaching the white label on which the name of the object is written, to the outside of the coloured paper with which the slide is covered, it is better to attach the label to the glass, and to punch a hole out of the coloured paper, sufficiently large enough to show the name, in the part corresponding to it: in this manner the label is prevented from falling off, which it frequently does when attached to the glass without protection, or to the outside of the paper cover. When objects are mounted in fluid, either with or

* Very neat gummed labels, of various sizes and patterns suitable to the wants of the Microscopist, are sold by the 'Drapers' Stationers' in the City.

without cells, paper coverings to the slides had better be dispensed with; and besides the name of the object, it is desirable to inscribe on the glass that of the fluid in which it is mounted. For the preservation of objects, the pasteboard boxes now made at a very reasonable cost, with wooden racks, to contain 6, 12, or 24 slides, will be found extremely useful. In these, however, the slides must always stand upon their edges; a position which, besides interfering with that ready view of them which is required for the immediate selection of any particular specimen, is unfavourable to the continued soundness of preparations mounted in fluid. Although such boxes are most useful, indeed almost indispensable, to the Microscopist, for holding slides which he desires (for whatever purpose) to keep for awhile constantly at hand, yet his regularly-classified series is much more conveniently stored in a Cabinet containing numerous very shallow drawers, in which they lie flat and exposed to view. Such cabinets are now prepared for sale under the direction of our principal Opticians, with all the improvements that experience has suggested. In order to antagonize the disposition of the slides to slip one over another in the opening or shutting of the drawers, it has been found preferable to arrange them in such a manner that they lie with their ends (instead of their long sides) towards the front of the drawer, and to interpose a cross-strip of wood, lying parallel to the front of the drawer, between each row. It is very convenient, moreover, for the front of the drawer to be furnished with a little tablet of porcelain, on which the name of the group of objects it may contain can be written in pencil, so as to be readily rubbed out; or a small frame may be attached to it, into which a slip of card may be inserted for the same purpose.*

Section 3. *Collection of Objects.*

175. A large proportion of the objects with which the Microscopist is concerned, are derived from the minute parts of those larger organisms, whether Vegetable or Animal, the collection of which does not require any other methods than those pursued by the ordinary Naturalist. With regard to such, therefore, no special directions are required. But there are several most interesting and important groups both of Plants and Animals, which are themselves, on account of their minuteness, essentially *microscopic*; and the collection of these requires peculiar methods and implements, which are, however, very simple—the chief element of success lying in the knowledge *where* to look and *what* to

* A very convenient and portable Object-Cabinet, in the form of a book, has been devised by Mr. James Smith ("Quart. Microsc. Journ.," Vol. viii., 1860, p. 202), and is manufactured by Messrs. Smith and Beck; and another still more convenient form, devised by Mr. Piper ("Trans. of Microsc. Society," Vol. xv., p. 16), is now sold by most Opticians under the name of the "Portable Horizontal Slide Cabinet."

look for. In the present place, *general* directions only will be given ; the particular details relating to the several groups being reserved for the account to be hereafter given of each.

176. Of the Microscopic organisms in question, those which inhabit fresh water must be sought for in pools, ditches, or streams, through which some of them freely move ; whilst others attach themselves to the stems and leaves of aquatic Plants, or even to pieces of stick or decaying leaves, &c., that may be floating on the surface or submerged beneath it ; while others, again, are to be sought for in the muddy sediments at the bottom. Of those which have the power of free motion, some keep near the surface, whilst others swim in the deeper waters ; but the situation of many depends entirely upon the light, since they rise to the surface in sunshine, and subside again afterwards. The Collector will therefore require a means of obtaining samples of water at different depths, and of drawing to himself portions of the larger bodies to which the microscopic organisms may be attached. For these purposes nothing is so convenient as the *Pond-Stick* (sold by Mr. Baker) which is made in two lengths, one of them sliding within the other, so as when closed to serve as a walking-stick. Into the extremity of this may be fitted, by means of a screw socket, (1) a cutting-hook or curved knife, for bringing up portions of larger Plants in order to obtain the minute forms of Vegetable or Animal life that may be parasitic upon them ; (2) a broad collar, with a screw in its interior, into which is fitted one of the screw-topped Bottles made by the York Glass Company ; (3) a ring or hoop for a muslin Ring-Net. When the Bottle is used for collecting at the surface, it should be moved sideways with its mouth partly below the water ; but if it be desired to bring up a sample of the liquid from below, or to draw into the bottle any bodies that may be loosely attached to the submerged plants, the bottle is to be plunged into the water with its mouth downwards, carried into the situation in which it is desired that it should be filled, and then suddenly turned with its mouth upwards. By unscrewing the bottle from the collar and screwing on its cover, the contents may be securely preserved. The Net should be a bag of fine muslin, which may be simply sewn to a ring of stout wire. But it is desirable for many purposes that the muslin should be made removable ; and this may be provided for (as suggested in the "Micrographic Dictionary," Introduction, p. xxiv.) by the substitution of a wooden hoop grooved on its outside, for the wire ring ; the muslin being strained upon it by a ring of vulcanized India-rubber, which lies in the groove, and which may be readily slipped off and on, so as to allow a fresh piece of muslin to be put in the place of that which has been last used. The collector should also be furnished with a number of Bottles, into which he may transfer the samples thus obtained ; and none are so convenient as the screw-topped bottles made in all sizes by the York Glass Company. It

is well that the bottles should be fitted into cases, to avoid the risk of breakage. When Animalcules are being collected, the bottles should not be above two-thirds filled, so that adequate air-space may be left.—Whilst engaged in the search for Microscopic objects, it is desirable for the Collector to possess a means of at once recognizing the forms which he may gather, where this is possible, in order that he may decide whether the ‘gathering’ is, or is not, worth preserving; for this purpose either a powerful ‘Coddington’ or ‘Stanhope’ lens (§ 19), a Gairdner’s Doublet Microscope (§ 35), a Tomkins’s Diatom-finder (§ 35, *note*), a Beale’s Pocket Microscope (§ 56), or the Travelling Microscope of Messrs. Baker or of Messrs. Murray and Heath (§ 58), will be found most useful, according to the class of objects of which the Collector is in search. The former will answer very well for Zoophytes and the larger Diatomaceæ; but the latter will be needed for Desmidiaceæ, the smaller Diatomaceæ, and Animalcules.

177. The same general method is to be followed in the collection of such *marine* forms of Vegetable and Animal life, as inhabit the neighbourhood of the shore, and can be reached by the Pond-stick. But there are many which need to be brought up from the bottom by means of the *Dredge*; and many others which swim freely through the waters of the ocean, and are only to be captured by the *Tow-Net*. As the former is part of the ordinary equipment of every Marine Naturalist, whether he concern himself with the Microscope or not, the mode of using it need not be here described; but the use of the latter for the purposes of the Microscopist requires special management. The net should be of fine muslin, firmly sewn to a ring of strong wire about 10 or 12 inches in diameter. This may be either fastened by a pair of strings to the stern of a boat, so as to tow *behind* it, or it may be fixed to a Stick so held in the hand as to project from the *side* of the boat. In either case the net should be taken-in from time to time, and held up to allow the water it contains to drain through it; and should then be turned inside-out and moved about in a bucket of water carried in the boat, so that any minute organisms adhering to it may be washed off before it is again immersed. It is by this simple method that Marine *Animalcules*, the living forms of *Polycystina*, the smaller *Medusoids* (with their allies, *Beroe* and *Cydippe*), *Noctiluca*, the free-swimming larvæ of *Echinodermata*, some of the most curious of the *Tunicata*, the larvæ of *Mollusca*, *Turbellaria*, and *Annelida*, some curious adult forms of these classes, *Entomostraca*, and the larvæ of higher *Crustacea*, are obtained by the Naturalist; and the great increase in our knowledge of these forms which has been gained within recent years, is mainly due to the assiduous use which has been made of it by qualified observers.—It is important to bear in mind that for the collection of all the more delicate of the organisms just named (such, for instance, as *Echinoderm larvæ*), it is essential that the boat should be rowed so slowly that

the net may move *gently* through the water, so as to avoid crushing its soft contents against its sides. Those of firmer structure (such as the *Entomostraca*), on the other hand, may be obtained by the use of a Tow-Net attached to the stern of a sailing-vessel or even of a steamer in much more rapid motion. When this method is employed, it will be found advantageous to make the net of conical form, and to attach to its deepest part a wide-mouthed bottle, which may be prevented from sinking too deeply by suspending it from a cork float; into this bottle many of the minute Animals caught by the net will be carried by the current produced by the motion of the vessel through the water, and they will be thus removed from liability to injury. It will also be useful to attach to the ring an inner net, the cone of which, more obtuse than that of the outer, is cut off at some little distance from the apex; this serves as a kind of valve, to prevent objects once caught from being washed out again.* The net is to be drawn-in from time to time, and the bottle to be thrust-up through the hole in the inner cone; and its contents being transferred to a screw-capped bottle for examination, the net may be again immersed. This form of net, however, is less suitable for the most delicate objects than the simple *Stick-Net* used in the manner just described.—The Microscopist on a visit to the sea side, who prefers a quiet row in tranquil waters to the trouble (and occasional *malaise*) of dredging, will find in the collection of floating Animals by the careful use of the *Stick-Net* or *Tow-Net* a never-ending source of interesting occupation.

* This form of *Tow-Net* may be obtained from Mr. Highley.

CHAPTER VI.

MICROSCOPIC FORMS OF VEGETABLE LIFE.—PROTOPHYTES.

178. In commencing our survey of those wonders and beauties of Life and Organization which are revealed to us by the assistance of the Microscope, it seems on every account the most appropriate to turn our attention in the first instance to the Vegetable Kingdom; and to begin with those of its humblest members whose form and structure, and whose very existence in many cases, are only known to us through its use. For such as desire to make themselves familiar with Microscopic appearances, and to acquire dexterity in Microscopic manipulation, cannot do better than educate themselves by the study of those comparatively simple forms of Organization which the Vegetable fabric presents. Again, the scientific Histologist looks to the careful study of the structure of the simplest forms of Vegetation, as furnishing the key (so to speak) that opens the right entrance to the study of the elementary Organization, not merely of the higher Plants, but of the highest Animals. And in like manner, the scientific Physiologist looks to the complete knowledge of their Life-history as furnishing the surest basis for those general notions of the nature of Vital Action, which the advance of science has shown to be really well founded only when they prove equally applicable to both Kingdoms.

179. But, further, a peculiar interest attaches itself at the present time to everything which throws light upon the debated question of the boundary between the two Kingdoms; a question which is not less keenly debated among Naturalists, than that of many a disputed frontier has been between adjacent Nations. For many parts of this border-country have been taken and retaken several times; their inhabitants (so to speak) having first been considered, on account of their general appearance, to belong to the Vegetable Kingdom,—then, in consequence of some movements being observed in them, being claimed by the Zoologists,—then, on the ground of their evidently Plant-like mode of growth, being transferred back to the Botanical side,—then, owing to the supposed detection of some new feature in their structure or physiology,

being again claimed as members of the Animal Kingdom,—and lastly, on the discovery of a fallacy in these arguments, being once more turned over to the Botanist, with whom, for the most part, they now remain. For the attention which has been given of late years to the study of the humblest forms of Vegetation, has led to the knowledge, among what must be *undoubtedly* regarded as Plants, of so many phenomena which would formerly have been considered unquestionable marks of Animality, that the discovery of the like phenomena among the doubtful beings in question, so far from being any evidence of *their* Animality, really affords a probability of the opposite kind.

180. In the present state of Science it would be very difficult, and is perhaps impossible, to lay down any definite line of demarcation between the two Kingdoms: since there is no single character by which the Animal or Vegetable nature of any Organism can be tested. Probably the one which is most generally applicable among those lowest Organisms that most closely approximate to one another, is—not, as formerly supposed, the presence or absence of Spontaneous Motion,—but the dependence of the being for nutriment upon *Organic Compounds already formed*, which it takes (in some way or other) into the interior of its body; or, on the other hand, its possession of the power of *producing the Organic Compounds* which it applies to the increase of its fabric, at the expense of certain *Inorganic Elements* (Oxygen, Hydrogen, Carbon, and Nitrogen) which it obtains by decomposing the Water, Carbonic Acid, and Ammonia with which it is in external relation. The former is the characteristic of the *Animal Kingdom* as a whole; the latter is the attribute of the *Vegetable*; and although certain apparently exceptional cases *may* exist, yet these do not seem to occur among the group in which such a means of distinction is most useful to us. For we shall find that those *Protozoa*, or simplest Animals, which seem to be composed of nothing else than a mass of living jelly (Chaps. IX. X.), are supported as exclusively either upon other *Protozoa* or upon *Protophytes* (which are humble Plants of equal simplicity), as are the highest Animals upon the flesh of other Animals or upon the products of the Vegetable Kingdom: whilst these *Protophytes*, in common with the highest Plants, draw *their* nourishment from the Atmosphere or the Water in which they live, and are distinguished by their power of liberating Oxygen through the decomposition of Carbonic Acid under the influence of Sun-light. And we shall moreover find that even such *Protozoa* as have neither stomach nor mouth, receive their alimentary matter direct into the very substance of their bodies, in which it undergoes a kind of digestion; whilst the *Protophyta* absorb through their external surface only, and take in no solid particles of any description. With regard to Motion, which was formerly considered the distinctive attribute of Animality, we now know not merely that many *Protophytes* (perhaps all at some period or other

of their lives) possess a power of spontaneous movement, but also that the instruments of motion (when these can be discovered) are of the very same character in the Plant as in the Animal; being little hair-like filaments termed *Cilia* (from the Latin *cilium*, an eye-lash), by whose rhythmical vibration the body of which they form part is propelled in definite directions. The peculiar contractility of these *Cilia* cannot be accounted for in either case, any better than in the other; all we can say is, that it seems to depend upon the continued vital activity of the living substance of which these filaments are prolongations, and that this contractile substance has a composition essentially the same in the Plant as in the Animal.

181. The plan of organization throughout the Vegetable kingdom presents this remarkable feature of uniformity,—that the fabric of the highest and most complicated Plants consists of nothing else than an aggregation of the bodies termed *Cells*, every one of which, among the lowest and simplest forms of Vegetation, may maintain an independent existence, and may multiply itself almost indefinitely, so as to form vast assemblages of similar bodies. And the essential difference between the plans of structure in the two cases lies in this:—that the *Cells* produced by the self-multiplication of the primordial cell of the Protophyte are all mere repetitions of it and of one another, each living *by* and *for* itself,—whilst those produced by the like self-multiplication of the primordial cell in the Oak or Palm not only remain in mutual connection, but undergo a progressive ‘differentiation;’ a composite fabric being thereby developed, which is made up of a number of distinct organs (Stem, Leaves, Roots, Flowers, &c.), each of them characterized by specialities not merely of external form but of intimate structure (the ordinary type of the Cell undergoing various modifications, to be described in their proper place, Chap. VIII.), and each performing actions peculiar to itself which contribute to the life of the Plant *as a whole*. Hence, as was first definitely stated by Schleiden, it is in the *life-history of the individual cell* that we find the true basis of the study of Vegetable Life in general. And we shall now inquire, therefore, what information on this point we derive from Microscopic research.

182. In its most completely-developed form, the Vegetable Cell may be considered as a closed membranous bag or vesicle, containing a fluid cell-sap; and thus we have to consider separately the *Cell-wall* and the *Cell-contents*. The *Cell-wall* is composed of two layers, of very different composition and properties. The *inner* of these, which has received the name of *Primordial Utricle*, appears to be the one first formed and most essential to the existence of the cell; it is extremely thin and delicate, so that it escapes attention so long as it remains in contact with the external layer; and it is only brought into view when separated from this, either by developmental changes (Fig. 153), or by the influence of re-

agents which cause it to contract by drawing-forth part of its contents (Fig. 197). Its composition is indicated, by the effects of re-agents, to be *albuminous*; that is, it agrees with the formative substance of the Animal tissues, not only in the proportions of oxygen, hydrogen, carbon, and nitrogen which it contains, but also in the nature of the compound formed by the union of these elements. The external layer, on the other hand, though commonly regarded as the proper Cell-wall, is generated on the surface of the primordial utricle after the latter has completely enclosed the cavity and its contents, so that it takes no essential part in the formation of the cell. It is usually thick and strong in comparison with the other, and may often be shown to consist of several layers. In its chemical nature it is altogether dissimilar to the primordial utricle; for it is essentially composed of *Cellulose*, a substance containing no nitrogen, and nearly identical with starch. The two constituents are readily distinguished by the action of Carmine (§ 145), which stains the Protoplasmic substance, without affecting the Cellulose-wall. The relative offices of these two membranes are very different; for whilst there are many indications that the Primordial Utricle continues to participate actively in the vital operations of the cell, it seems certain that the Cellulose-wall takes no concern in them, but is only their product, its function being simply protective. The contents of the Vegetable cell, being usually more or less deeply coloured, have received the collective designation of *Endochrome* (or internal colouring-substance); and they essentially consist of a layer of colourless *Protoplasm* (or organizable fluid, containing albuminous matter in combination with dextrine or starch-gum) in immediate contact with the primordial utricle, within which is the more watery Cell-sap, particles of *Chlorophyll* or colouring-substance and of *Oil* being diffused through both, or through the former only.

183. But although these component parts may be made-out without any difficulty in a large proportion of Vegetable-Cells, yet they cannot be distinguished in some of those humble organisms which are nearest to the border-ground between the two kingdoms. For in them we find the Cell-wall very imperfectly differentiated from the Cell-contents; the former not having by any means the firmness of a perfect membrane, and the latter not possessing the liquidity which elsewhere characterizes them. And in some instances the Cell appears to be represented only by a mass of Endochrome, so viscid as to retain its external form without any limiting membrane, though the superficial layer seems to have a firmer consistence than the interior substance; and this may or may not be surrounded by a gelatinous-looking envelope, which is equally far from possessing a membranous firmness, and yet is the only representative of the Cellulose-wall. This viscid Endochrome consists, as elsewhere, of a colourless Protoplasm, through which colouring particles are diffused, sometimes uniformly, sometimes

in local aggregations, leaving parts of the protoplasm uncoloured. The superficial layer, in particular, is frequently destitute of colour; and the Primordial Utricle appears to be formed by its solidification. In the interior of the viscid mass, are commonly found *Vacuoles*, which are distinguished from the surrounding substance by their difference in refracting power; these, however, are not usually void spaces, but are cavities in the Protoplasm occupied by fluid of a more watery consistence; and this 'vacuolation' of the interior, which increases until the cell-contents have almost entirely lost their original viscosity and are of a more watery character, seems to take-place *pari passu* with the consolidation of the exterior into distinct membranous walls; so that the development of a perfect Cell out of a rudimentary mass of Endochrome may be stated to consist essentially in the *gradual differentiation* of its substance, which was at first a nearly homogeneous viscid mass, into the solid Cell-wall and the liquid Cell-contents.—(See also § 286.)

184. Now among the *Protophytes* or simplest Plants, on the examination of which we are about to enter, there are many of which every single Cell is not only capable of living in a state of isolation from the rest, but even normally does so; and thus, in the ordinary phraseology, every Cell is to be accounted a 'distinct individual.' There are others, again, of which shapeless masses are made up by the aggregation of contiguous Cells, which, though quite capable of living independently, remain attached to each other by the mutual fusion (so to speak) of their gelatinous investments. And there are others, moreover, in which a definite adhesion exists between the Cells, and in which regular plant-like structures are thus formed, notwithstanding that every cell is still but a repetition of every other, and is capable of living independently if detached, so as to answer to the designation of a Unicellular or single-celled Plant. These different conditions we shall find to arise out of the mode in which each particular species multiplies by binary subdivision (§ 185): for where the cells of the new pair that is produced by the segmentation of the previous cell undergo a *complete* separation from one another, they will henceforth live quite separately; but if, instead of undergoing this complete fusion, they should be held-together by the intervening gelatinous envelope, a shapeless mass results from repeated subdivisions not taking place on any determinate plan; and if, moreover, the binary subdivision should always take-place in a determinate direction, a long narrow filament (Fig. 147 D), or a broad flat leaf-like expansion (G), may be generated. To such extended fabrics the term Unicellular Plants can scarcely be applied with propriety; since they may be built-up of many thousands or millions of distinct Cells, which have no disposition to separate from each other spontaneously. Still they correspond with those which are strictly Unicellular, as to the *absence of differentiation* either in struc-

ture or in actions between their component cells; each one of these being a repetition of the rest, and no relation of mutual dependence existing among them.—All such organisms may well be included under the general term of PROTOPHYTES, by which it is convenient to designate these primitive or elementary forms of Vegetation; and we shall now enter, in such detail as the nature of the present Treatise allows, into the history of those forms of the group which present most of interest to the Microscopist, or which best serve to illustrate the general doctrines of Physiology.

185. The life-history of one of these Unicellular Plants, in its most simple form, can scarcely be better exemplified than in the *Palmoglaia macrococca* (Kützing); one of those humble kinds of vegetation which spreads itself as a green slime over damp stones, walls, &c. When this slime is examined with the microscope, it is found to consist of a multitude of green Cells (Plate VIII. Fig. 1, A), each surrounded by a gelatinous envelope; the Cell, which does not seem to have any distinct membranous wall, is filled with granular particles of a green colour; and a *nucleus*, or more solid aggregation which appears to be the centre of the vital activity of the cell, may sometimes be distinguished through the midst of these. When treated with tincture of iodine, however, the green contents of the cell are turned to a brownish hue, and a dark-brown nucleus (a) is distinctly shown. Other cells are seen (B), which are considerably elongated, some of them beginning to present a sort of hour-glass contraction across the middle; in these is commencing that curious *multiplication by binary subdivision*, which is the ordinary mode of increase throughout the Vegetable kingdom; and when cells in this condition are treated with tincture of iodine, the nucleus is seen to be undergoing the like elongation and constriction (H). A more advanced state of the process of subdivision is seen at c, in which the constriction has proceeded to the extent of completely cutting-off the two halves of the cell, as well as of the nucleus (I), from each other, though they still remain in mutual contact; but in a yet later stage they are found detached from each other (D), though still included within the same gelatinous envelope. Each new cell then begins to secrete its own gelatinous envelope, so that, by its intervention, the two are usually soon separated from one another (E). Sometimes, however, this is not the case; the process of subdivision being quickly repeated before there is time for the production of the gelatinous envelope, so that a series of cells (F) hanging-on one to another is produced.—There appears to be no definite limit to this kind of multiplication; and extensive areas may be quickly covered, in circumstances favourable to the growth of the plant, by the products of the duplicative subdivision of one Primordial Cell. This, however, is simply an act of *Growth*, precisely analogous to that by which any one of the higher forms of Vegetation extends itself, and differing only in this, that the cells produced by each act of subdivision in these simplest

PLATE VIII

FIG. 1.

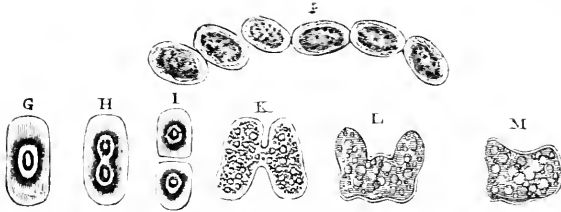
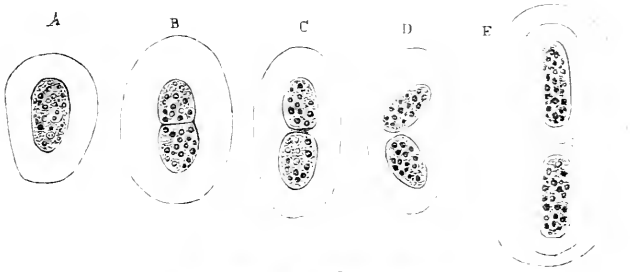
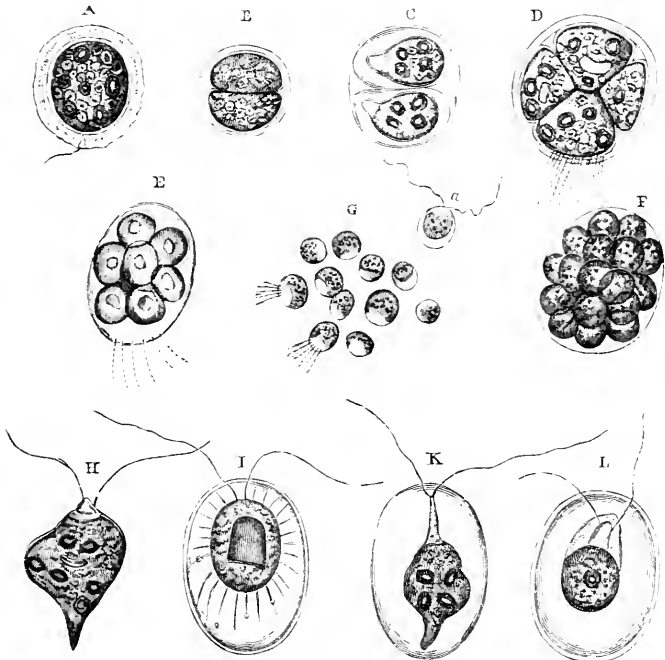
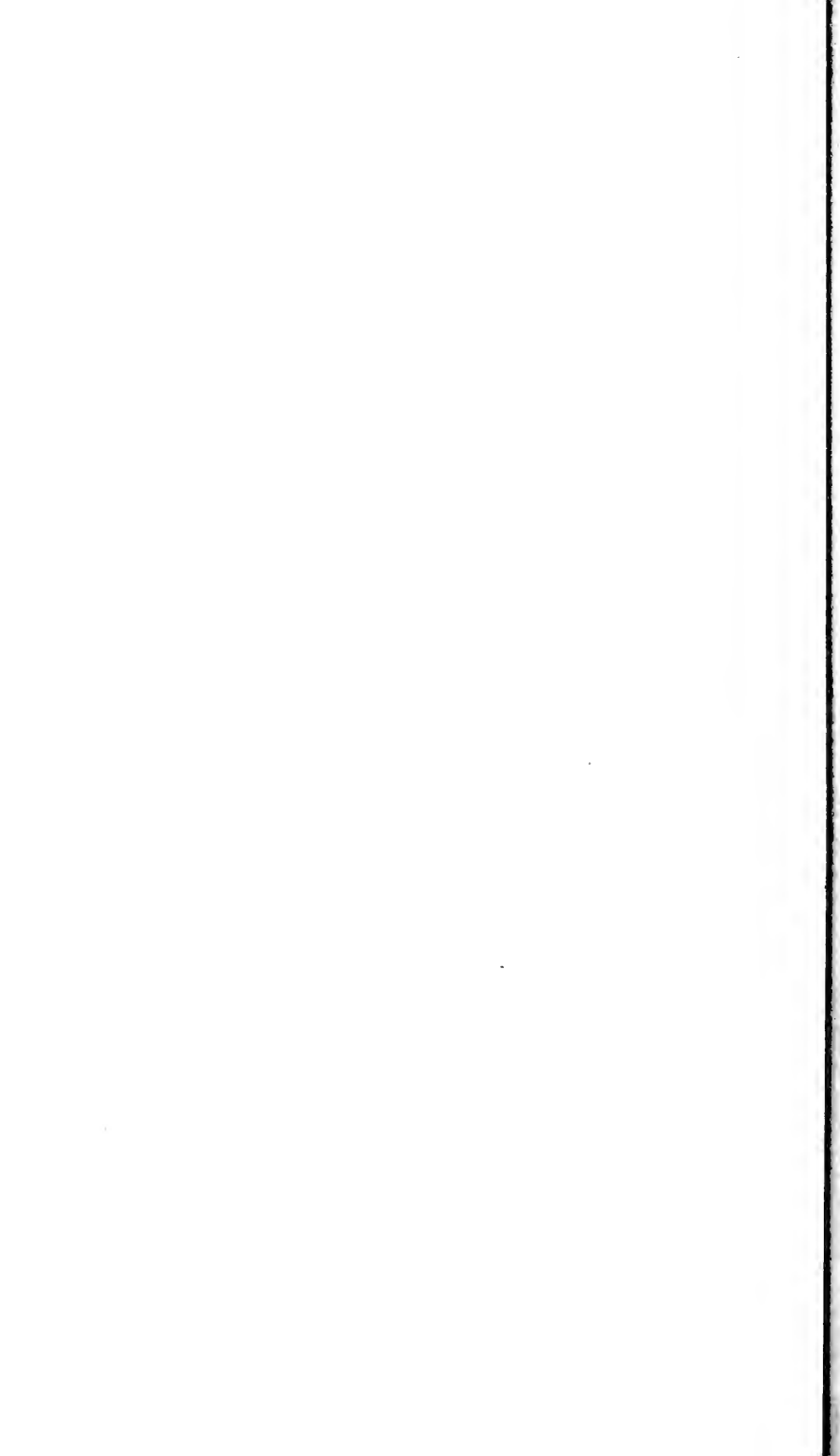

FIG. 2.



DEVELOPMENT OF PALMOGLEA AND PROTOCOCCUS.

[To face p. 244.]



Plants exactly resemble that from which they sprang ; whilst in the case of more highly organized Plants, they gradually become differentiated to a greater or less degree, so that special 'organs' are evolved, which take upon themselves dissimilar yet mutually dependent actions in the economy of the entire Organism (§ 181).

186. The process which represents the *Generation* of the higher Plants is here performed in a manner so simple that it would not be recognized as such, if we were not able to trace it up through a succession of modes of gradually increasing complexity, until we arrive at the elaborate operations which are concerned in the production and fertilization of the Seeds of Flowering Plants. For it consists in nothing else than the re-union or fusion-together of any pair of Cells (Plate VIII. Fig. 1, κ),—a process which is termed *Conjugation* ; and it is characteristic of this humble Plant, and shows how imperfect must be the consistence of its Cell-membrane, that this seems to enter into the fusion no less completely than do the Cell-contents. The communication is at first usually made by a narrow neck or bridge (κ) ; but before long it extends through a large part of the contiguous boundaries (L) ; and at last the two cells are seen to be completely fused into one mass (μ), which is termed the *Spore*. Each Spore thus formed is the Primordial Cell of a *new generation*, into which it evolves itself by successive repetitions of the process of binary subdivision.—It is curious to observe that during this Conjugating process a production of Oil particles takes place in the cells ; these at first are small and distant, but gradually become larger and approximate more closely to each other, and at last coalesce so as to form oil-drops of various sizes, the green granular matter disappearing ; and the colour of the conjugated body changes, with the advance of this process, from green to a light yellowish-brown. When the Spore begins to vegetate, on the other hand, producing a pair of new cells by binary subdivision, a converse change occurs ; the oil-globules disappear, and green granular matter takes their place. Now this is precisely what happens in the formation of seed among the higher Plants ; for Starchy substances are transformed into Oil, which is stored up in the Seed for the nutrition of the embryo, and is applied during Germination to the purposes which are at other times answered by starch or chlorophyll.—The *growth* of this little plant appears to be favoured by cold and damp ; its *generation*, on the other hand, is promoted by heat and dryness ; and it is obvious that the Spore-cell must be endowed with a greater power of resisting this than the vegetating plant has, since the species would otherwise be destroyed by every drought.

187. If the preceding sketch really comprehends the whole Life history of the humble plant to which it relates, this history is much more simple than that of other forms of Vegetation, which, without appearing to possess an essentially-higher structure, present themselves under a much greater variety of forms and condi-

tions. One of the most remarkable of these varieties is the *motile* condition, which seems to be common, in some stage or other of their existence, to a very large proportion of the lower forms of Aquatic Vegetation ; and which usually depends upon the extension of the Primordial Utricle into one or two thread-like filaments, endowed with the power of executing rhythmical contractions, whereby the cell is impelled through the water.

188. As an illustration of this peculiar mode of activity, which was formerly supposed to betoken Animal life, a sketch will be given of the history of a plant, the *Protococcus pluvialis* (Plate VIII. Fig. 2), which is not uncommon in collections of Rain-water,* and which, in its motile condition, has been very commonly regarded as an Animalcule, its different states having been described under several different names. In the first place, the *colour* of these cells varies considerably ; since, although they are usually *green* at the period of their most active life, they are sometimes

* The Author had under his own observation, more than twenty years ago, an extraordinary abundance of what he now feels satisfied must have been this Protophyte, in a rain-water cistern which had been newly cleaned-out. His notice was attracted to it, by seeing the surface of the water covered with a green froth, whenever the sun shone upon it. On examining a portion of this froth under the Microscope, he found that the water was crowded with green cells in active motion ; and although the only bodies at all resembling them of which he could find any description, were the so-called *Animalcules* constituting the genus *Chlamydomonas* of Prof. Ehrenberg, and very little was known at that time of the 'motile' conditions of *Plants* of this description, yet of the Vegetable nature of these bodies he could not entertain the smallest doubt. They appeared in freshly collected rain-water, and could not, therefore, be deriving their support from Organic matter ; under the influence of light they were obviously decomposing Carbonic Acid and liberating Oxygen, and this influence he found to be essential to the continuance of their growth and development, which took place entirely upon the Vegetative plan. Not many days after the Protophyte first appeared in the water, a few Wheel-Animalcules presented themselves ; these fed greedily upon it, and increased so rapidly (the weather being very warm) that they speedily became almost as crowded as the cells of the *Protococcus* had been ; and it was probably due in part to their voracity that the plant soon became less abundant, and before long disappeared altogether. Had the Author been then aware of its assumption of the 'still' condition, he might have found it at the bottom of the cistern, after it had ceased to present itself at the surface.—The account of this Plant given above, is derived from that of Dr. Cohn, in the "Nova Acta Acad. Nat. Curios." (Bonn, 1850, Tom. xxii. ; of which an abstract by Mr. George Busk is contained in the "Botanical and Physiological Memoirs," published by the Ray Society for 1853. This excellent observer states that he kept his plants for observation in little glass vessels, having the form of a truncated cone, about two inches deep, and one inch and a quarter in diameter, with a flat bottom polished on both sides, and filled with water to the depth of from two to three lines. "It was only in vessels of this kind," he says, "that he was able to follow the development of a number of various cells throughout its whole course." Probably he would have found the Tube-Cells represented in Fig. 106, if he had been acquainted with them, to answer his purpose just as well as these specially constructed vessels.

red; and their red form has received the distinguishing appellation of *Hæmatococcus*. Very commonly the red colouring-matter forms only a central mass of greater or less size, having the appearance of a nucleus (as shown at E); and sometimes it is reduced to a single granular point, which has been erroneously represented by Prof. Ehrenberg as the *eye* of these so-called Animalcules. It is quite certain that the red colouring-substance is very nearly related in its chemical character to the green, and that the one may be converted into the other: though the conditions under which this conversion takes place are not precisely known. In the *still* form of the cell, with which we may commence the history of its life, we find a mass of Endochrome, consisting of a colourless Protoplasm, through which red or green-coloured granules are more or less uniformly diffused: on the surface of this endochrome the colourless protoplasm is condensed into a more consistent layer, forming an imperfect Primordial Utricle; and this is surrounded by a tolerably firm layer, which seems to consist of Cellulose or of some modification of it. Outside this (as shown at A), when the 'still' cell is formed by a change in the condition of a cell that has been previously 'motile,' we find another envelope, which seems to be of the same nature, but which is separated by the interposition of aqueous fluid; this, however, may be altogether wanting. The multiplication of the 'still' cells by self-division takes place as in *Palmoglova*: the endochrome, enclosed in its primordial utricle, first undergoing separation into two halves (as seen at B), and each of these halves subsequently developing a cellulose envelope around itself, and undergoing the same division in its turn. Thus 2, 4, 8, 16 new cells are successively produced; and these are sometimes set-free by the complete dissolution of the envelope of the original cell; but they are more commonly held-together by its transformation into a gelatinous investment, in which they remain imbedded. Sometimes the contents of the primordial utricle subdivide at once into four segments (as at D), of which every one forthwith acquires the characters of an independent cell; but this, although an ordinary method of multiplication among the 'motile' cells, is comparatively rare in the 'still' condition. Sometimes, again, the cell-contents of the 'still' form subdivide at once into eight portions, which, being of small size, and endowed with motile power, may be considered as *Zoospores*; it is not quite clear what becomes of these; but there is reason to believe that some of them retain their motile powers, and, after increasing in size, develop an investing cyst, like the free primordial utricles to be presently described; that others produce a firm cellulose envelope, and become 'still' cells; and that others (perhaps the majority) perish without any further change.

189. When the ordinary self-division of the 'still' cells into two segments has been repeated four times, so as to produce 16 cells—and sometimes at an earlier period,—the new cells thus

produced assume the 'motile' condition; being liberated before the development of the cellulose envelope, and becoming furnished with two long vibratile filaments, or *cilia*, which appear to be extensions of the primordial utricle (H). In this condition it seems obvious that the colourless protoplasm is more developed relatively to the colouring-matter, than it is in the 'still' cells; it generally accumulates in the part from which the vibratile filaments or cilia proceed, so as to form a sort of transparent beak (H, K, L); and it usually contains 'vacuoles,' occupied only by clear aqueous fluid, which are sometimes so numerous as to take in a large part of the cavity of the cell, so that the coloured contents seem only like a deposit on its walls. Before long, this 'motile' primordial utricle acquires a peculiar saccular investment, which seems to correspond with the cellulose envelope of the 'still' cells, but is not so firm in its consistence (I, K, L). Thread-like extensions of the protoplasm, sometimes containing coloured globules, are not unfrequently seen to radiate from the primordial utricle towards the exterior of this enveloping bag (I); these are rendered more distinct by iodine, and can be made to retract by means of re-agents; and their existence seems to show, on the one hand, that the transparent space through which they extend themselves is only occupied by a watery liquid, and on the other, that the layer of protoplasm which constitutes the primordial utricle is far from possessing the tenacity of a completely formed membrane.—The vibratile cilia pass through the cellulose envelope, which invests their base with a sort of sheath; and in the portion that is within this sheath no movement is seen. During the active life of the 'motile' cells, the vibration of these cilia is so rapid, that it can be recognized only by the currents it produces in the water through which the cells are quickly propelled; but when the motion becomes slacker, the filaments themselves are readily distinguishable; and they may be made more obvious by the addition of iodine.

190. The Multiplication of these 'motile' cells may take place in various modes, giving rise to a great variety of appearances. Sometimes they undergo a regular binary subdivision, whereby a pair of motile cells is produced (c), each resembling its single predecessor in possessing the cellulose investment, the transparent beak, and the vibratile filaments, before the solution of the original investment. Sometimes, again, the contents of the primordial cell undergo a segmentation in the first instance into four divisions (D); which may either become isolated by the dissolution of their envelope, and may separate from each other in the condition of free primordial utricles (H), developing their cellulose investments at a future time; or may acquire their cellulose investments (as in the preceding case) before the solution of that of the original cell; and sometimes, even after the disappearance of this, and the formation of their own independent investments,

they remain attached to each other at their beaked extremities, the primordial utricles being connected with each other by peduncular prolongations, and the whole compound body having the form of a \dagger . This quaternary segmentation appears to be a more frequent mode of multiplication among the 'motile' cells, than the subdivision into two; although, as we have seen, it is less common in the 'still' condition. So, also, a primary segmentation of the entire endochrome of the 'motile' cells, into 8, 16, or even 32 parts, may take place (E, F), thus giving rise to as many minute primordial cells. These *Micro-gonidia*, when set free, and possessing active powers of movement, rank as Zoospores (G): they may either develop a loose cellulose investment or cyst, so as to attain the full dimensions of the ordinary motile cells (I, K), or they may become clothed with a dense envelope and lose their vibratile cilia, thus passing into the 'still' condition (A); and this last transformation may even take place before they are set free from the envelope within which they were produced, so that they constitute a mulberry-like mass, which fills the whole cavity of the original cell, and is kept in motion by its cilia.

191. All these *varieties*, whose relation to each other has been clearly proved by watching the successional changes that make up the history of this one Plant, have been regarded as constituting, not merely distinct *species*, but distinct *genera* of Animalcules; such as *Chlamydomonas*, *Euglena*, *Trachelomonas*, *Gyges*, *Gonium*, *Pandorina*, *Botryocystis*, *Urella*, *Syncrypta*, *Monas*, *Astasia*, *Bodo*, and probably many others.* Certain forms, such as the 'motile' cells I, K, L, appear in a given infusion, at first exclusively and then principally; they gradually diminish, become more and more rare, and finally disappear altogether, being replaced by the 'still' form. After some time, the number of the 'motile' cells again increases, and reaches, as before, an extraordinary amount; and this alternation may be repeated several times in the course of a few weeks. The process of segmentation is often accomplished with great rapidity. If a number of motile cells be transferred from a larger glass into a small capsule, it will be found, after the lapse of a few hours, that most of them have subsided to the bottom; in the course of the day, they will all be observed to be upon the point of subdivision; on the following morning, the divisional brood will have become quite free; and on the next, the bottom of the vessel will be found covered with a new brood of self-dividing cells, which again proceed to the forma-

* In the above sketch, the Author has presented the facts described by Dr. Cohn, under the relation which they seemed to him naturally to bear, but which differs from that in which they will be found in the original Memoir; and he is glad to be able to state, from personal communication with its able Author, that Dr. Cohn's later observations have led him to adopt a view of the relationship of the 'still' and 'motile' forms, which is in essential accordance with his own.

tion of a new brood, and so on.—The activity of Motion and the activity of Multiplication seem to stand, in some degree, in a relation of reciprocity to each other; for the self-dividing process takes-place with greater rapidity in the 'still' cells, than it does in the 'motile.'

192. What are the precise conditions which determine the transition between the 'still' and 'motile' states, cannot yet be precisely stated; but the influence of certain agencies can be predicted with tolerable certainty. Thus it is only necessary to pour the water containing these organisms from a smaller and deeper into a larger and shallower vessel, at once to determine segmentation in numerous cells,—a phenomenon which is observable also in many other *Protophytes*. The 'motile' cells seem to be favourably affected by Light, for they collect themselves at the surface of the water and at the edges of the vessel; but when they are about to undergo segmentation, or to pass into the 'still' condition, they sink to the bottom of the vessel, or retreat to that part of it in which they are least subjected to light. When kept in the dark, the 'motile' cells undergo a great diminution of their chlorophyll, which becomes very pale, and is diffused, instead of forming definite granules; they continue their movement, however, uninterruptedly, without either sinking to the bottom, or passing into the still form, or undergoing segmentation. A moderate warmth, particularly that of the vernal sun, is favourable to the development of the 'motile' cells; but a temperature of excessive elevation prevents it. Rapid evaporation of the water in which the 'motile' forms may be contained, kills them at once; but a more gradual loss, such as takes-place in deep glasses, causes them merely to pass into the 'still' form; and in this condition,—especially when they have assumed a red hue,—they may be completely dried-up, and may remain in a state of dormant vitality for many years. It is in this state that they are wafted-about in atmospheric currents, and that, being brought-down by the rain into pools, cisterns, &c., they may present themselves where none had been previously known to exist; and there, under favourable circumstances, they may undergo a very rapid multiplication, and may maintain themselves until the water is dried-up, or some other change occurs which is incompatible with the continuance of their vital activity. They then very commonly become red throughout, the red colouring-substance extending itself from the centre towards the circumference, and assuming an appearance like that of oil-drops; and these red cells, acquiring thick cell-walls and a mucous envelope, float in flocculent aggregations on the surface of the water. This state seems to correspond with the 'winter spores' of other *Protophytes*; and it may continue until warmth, air, and moisture cause the development of the red cells into the ordinary 'still' cells, green matter being gradually produced, until the red substance forms only the central part of the endochrome. After this

the cycle of changes occurs which has been already described; and the Plant may pass through a long series of these, before it returns to the state of the red thick-walled cell, in which it may again remain dormant for an unlimited period.—Even this cycle, however, cannot be regarded as completing the History of the species before us; since it does not include the performance of any true Generative act. There can be little doubt that, in some stage of its existence, a Conjugation of two cells occurs, as in the preceding case; and the attention of observers should be directed to its discovery, as well as to the detection of other varieties in the condition of this interesting little Plant, which will be probably found to present themselves before and after the performance of that act.

193. From the Composite 'motile' forms of the preceding type, the transition is easy to the group of *Volvocineæ*,—an assemblage of minute Plants of the greatest interest to the Microscopist, on account both of the Animalcule-like activity of their movements, and of the great beauty and regularity of their forms. The most remarkable example of this group is the well-known *Volvox globator* (Fig. 108), which is not uncommon in fresh-water pools, and which, attaining a diameter of 1-30th of an inch, may be seen with the naked eye when the drop containing it is held-up to the light, swimming through the water which it inhabits. Its onward motion is usually of a rolling kind; but it sometimes glides smoothly along, without turning on its axis; whilst sometimes, again, it rotates like a top, without changing its position. When examined with a sufficient magnifying power, the *Volvox* is seen to consist of a hollow sphere, composed of a very pellucid material, which is studded at regular intervals with minute green spots, and which is often (but not constantly) traversed by green threads connecting these spots together. From each of the spots proceed two long *cilia*; so that the entire surface is beset with these vibratile filaments, to whose combined action its movements are due.

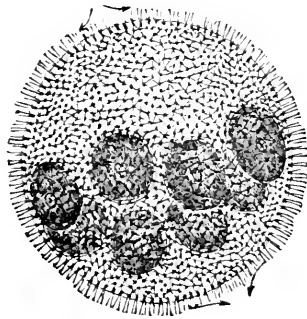

FIG. 108.

Volvox Globator.

Within the external sphere may generally be seen from two to twenty other globes, of a darker colour, and of varying sizes; the smaller of these are attached to the inner surface of the investing sphere, and project into its cavity; but the larger lie freely within the cavity, and may often be observed to revolve by the agency of their own ciliary filaments. After a time, the original sphere bursts, and the contained spherules swim forth and speedily develop themselves into the likeness of that within which they have

been evolved; their component particles, which are at first closely aggregated together, being separated from each other by the interposition of the transparent pellicle.—It was long supposed that the *Volvox* was a *single* Animal; and it was first shown to be a *composite* fabric, made up of a repetition of organisms in all respects similar to each other, by Prof. Ehrenberg; who, however, considered these organisms as *Monads*, and described them as each possessing a mouth, several stomachs, and an eye! Our present knowledge of their nature, however, leaves no doubt of their Vegetable character; and the peculiarity of their History renders it desirable to describe it in some detail.

194. Each of the so-called 'Monads' (Plate ix. Figs. 9, 11) is in reality a somewhat flask-shaped mass of Endochrome, about 1-3000th of an inch in diameter; consisting, as in the previous instances, of Chlorophyll-granules diffused through a colourless Protoplasm; and bounded by a layer of condensed protoplasm, which represents a Primordial Utricle, but is obviously far from having attained a membranous consistence. It is prolonged outwardly (or towards the circumference of the sphere) into a sort of colourless beak or proboscis, from which proceed two long vibratile cilia (Fig. 11); and it is invested by a pellucid or Hyaline envelope (Fig. 9, *d*) of considerable thickness, the borders of which are flattened against those of other similar envelopes (Fig. 5, *c, c*), but which does not appear to have the tenacity of a true membrane. It is impossible not to recognize the precise similarity between the structure of this body, and that of the motile 'encysted' cell of *Protococcus pluvialis* (Plate VIII. Fig. 2, κ); there is not, in fact, any perceptible difference between them, save that which arises from the regular aggregation, in *Volvox*, of the cells which normally detach themselves from one another in *Protococcus*. The presence of Cellulose in the hyaline substance is not indicated, in the ordinary condition of *Volvox*, by the iodine and sulphuric acid test, though the use of 'Schultz's solution' gives to it a faint blue tinge; there can be no doubt of its existence, however, in the hyaline envelope of what has been termed *Volvox aureus*, which seems to be the sporangial form of *Volvox globator* (§ 199). The cilia and endochrome, as in the motile forms of *Protococcus*, are tinged of a deep brown by iodine, with the exception of one or two particles in each cell, which, being turned blue, may be inferred to be Starch; and when the contents of the cell are liberated, bluish flocculi, apparently indicative of the presence of Cellulose, are brought into view by the action of sulphuric acid and iodine. All these reactions are characteristically *Vegetable* in their nature.—When the cell is approaching maturity, its Endochrome always exhibits one or more 'vacuoles' (Fig. 9, *a a*), of a spherical form, and usually about one-third of its own diameter; and these 'vacuoles' (which are the so-called 'stomachs' of Prof. Ehrenberg) have been observed by Mr. G. Busk to undergo a very

PLATE IX.

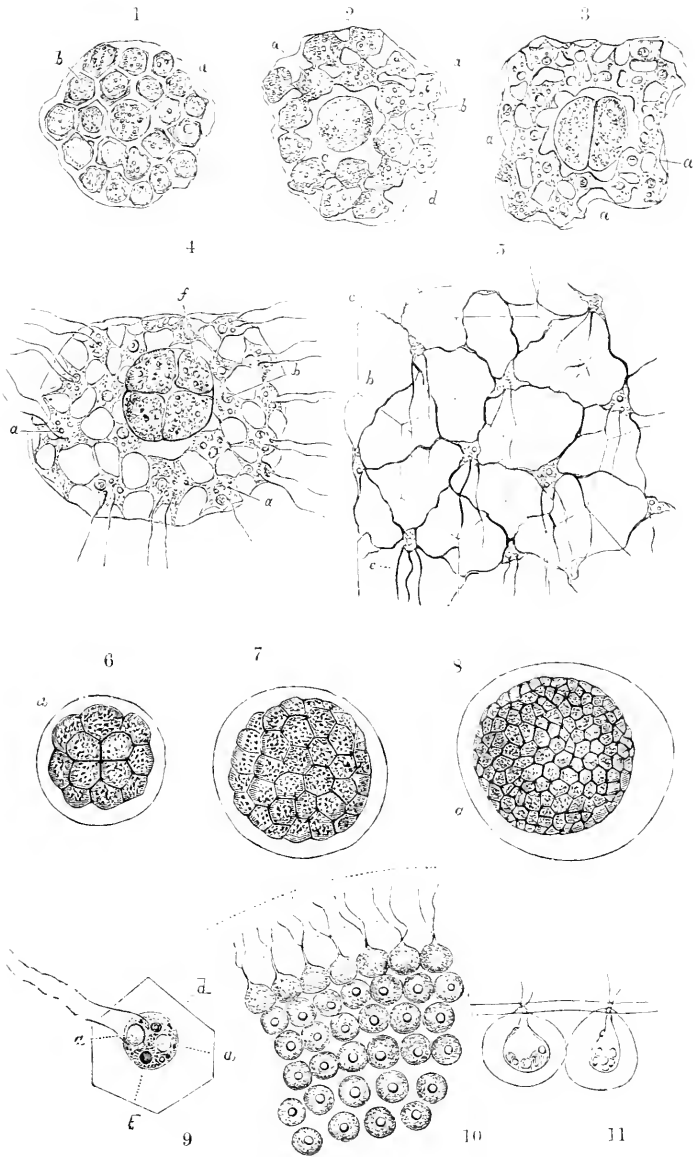

DEVELOPMENT OF VOLVOX GLOBATOR.

[To face p. 252.]

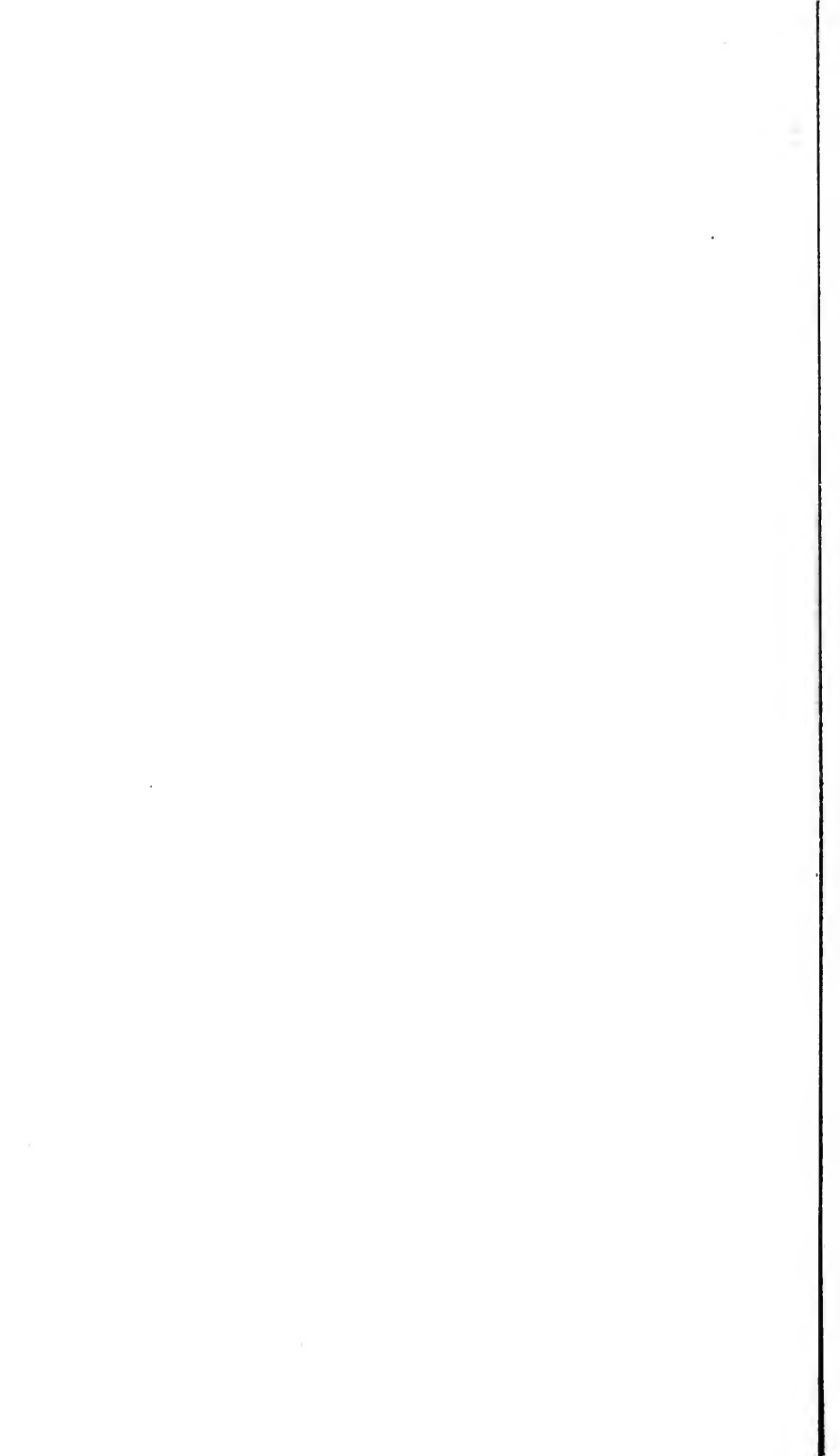

curious rhythmical contraction and dilatation at intervals of about 40 seconds ; the contraction (which seems to amount to complete obliteration of the cavity of the vacuole) taking-place rapidly or suddenly, whilst the dilatation is slow and gradual. This curious action ceases, however, as the Cell arrives at its full maturity ; a condition which seems to be marked by the greater consolidation of the primordial utricle, by the removal or transformation of some of the chlorophyll, and by the formation of the red spot (*b*), which obviously consists, as in *Protococcus*, of a peculiar modification of chlorophyll.

195. Each mass of Endochrome normally communicates with those in nearest proximity with it, by extensions of its own substance, which are sometimes single and sometimes double (Fig. 5, *b, b*) ; and these connecting processes necessarily cross the lines of division between their respective Hyaline investments. The thickness of these processes varies very considerably ; for sometimes they are broad bands, and in other cases mere threads ; whilst they are occasionally wanting altogether. This difference seems partly to depend upon the age of the specimen, and partly upon the abundance of nutriment which it obtains ; for, as we shall presently see, the connection is most intimate at an early period, before the Hyaline investments of the cells have increased so much as to separate the masses of endochrome to a distance from one another (Figs. 2, 3, 4) ; whilst in a mature individual, in which the separation has taken-place to its full extent, and the nutritive processes have become less active, the masses of endochrome very commonly assume an angular form, and the connecting processes are drawn-out into threads (as seen in Fig. 5), or they retain their globular form, and the connecting processes altogether disappear. The influence of re-agents, or the infiltration of water into the interior of the Hyaline investment, will sometimes cause the connecting processes (as in *Protococcus*, § 189) to be drawn back into the central mass of endochrome ; and they will also retreat on the mere rupture of the Hyaline investment : from these circumstances it may be inferred that they are not enclosed in any definite membrane. On the other hand, the connecting threads are sometimes seen as double lines, which seem like tubular prolongations of a consistent membrane, without any protoplasmic granules in their interior. It is obvious, then, that an examination of a considerable number of specimens, exhibiting various phases of conformation, is necessary to demonstrate the nature of these communications ; but this may be best made-out by attending to the history of their Development, which we shall now describe.

196. The spherical body of the young *Volvox* (Plate III., Fig. 1) is composed of an aggregation of somewhat angular masses of Endochrome (*b*), separated by the interposition of Hyaline substance ; and the whole seems to be enclosed in a distinctly membranous envelope, which is probably the distended Hyaline investment of the Primordial Cell, within which, as will presently appear, the entire

aggregation originated. In the midst of the polygonal masses of endochrome, one mass (*a*), rather larger than the rest, is seen to present a circular form : and this, as will presently appear, is the originating cell of what is hereafter to become a new sphere. The growing *Volvox* at first increases in size, not only by the interposition of new hyaline substance between its component masses of endochrome, but also by an increase in these masses themselves (Fig. 2, *a*), which come into continuous connexion with each other by the coalescence of processes (*b*) which they severally put-forth ; at the same time an increase is observed in the size of the globular cell (*c*), which is preliminary to its binary subdivision. A more advanced stage of the same developmental process is seen in Fig. 3 ; in which the connecting processes (*a*, *a*) are so much increased in size as to establish a most intimate union between the masses of endochrome, although the increase of the intervening hyaline substance carries these masses apart from one another ; whilst the endochrome of the central globular cell has undergone segmentation into two halves. In the stage represented in Fig. 4, the masses of endochrome have been still more widely separated by the interposition of hyaline substance ; each has become furnished with its pair of ciliary filaments ; and the globular cell has undergone a second segmentation. Finally, in Fig. 5, which represents a portion of the spherical wall of a mature *Volvox*, the endochrome-masses are observed to present a more scattered aspect, partly on account of their own reduction in size, and partly through the interposition of a greatly-increased amount of hyaline substance which is secreted from the surface of each mass ; and that portion which belongs to each cell, standing to the endochrome-mass in the relation of the cellulose coat of ordinary cells to their primordial utricle, is frequently seen to be marked-out from the rest by delicate lines of hexagonal areolation (*c*, *c*), which indicate the boundaries of each. Of these it is often difficult to obtain a sight, a nice management of the light being usually requisite with fresh specimens ; but the prolonged action of water (especially when it contains a trace of iodine), or of glycerine, will often bring them into clear view. The prolonged action of glycerine, moreover, will often show that the boundary lines are double, being formed by the coalescence of two contiguous cell-walls ; and they sometimes retreat from each other so far that the hexagonal areolæ become rounded. As the primary sphere approaches maturity, the large secondary germ-mass, or *Macro-gonidium*, whose origin has been traced from the beginning, also advances in development ; its contents undergoing multiplication by successive segmentations, so that we find it to consist of 8, 16, 32, 64, and still more numerous divisions, as shown in Figs. 6, 7, 8. Up to this stage, at which first the sphere appears to become hollow, it is retained within the hyaline envelope of the cell within which it has been produced ; a similar envelope can be easily distinguished, as shown in Fig. 10, just when the segmentation has been completed, and at that stage the cilia pass into it, but do not extend beyond

it; and even in the mature *Volvox* it continues to form an investment around the hyaline envelopes of the separate cells, as shown in Fig. 11. It seems to be by the adhesion of the hyaline investment of the new sphere to that of the old, that the secondary sphere remains for a time attached to the interior wall of the primary; at what exact period, or in what precise manner, the separation between the two takes place, has not yet been determined. At the time of the separation, the developmental process has generally advanced as far as the stage represented in Fig. 1; the foundation of one or more tertiary spheres being usually distinguishable in the enlargement of certain of its cells.

197. This development and setting-free of composite Macrogonidia seems to be the ordinary and characteristic mode of multiplication in *Volvox*; but there are other phenomena which must not be left without mention, although their precise import is as yet uncertain. Thus, according to Mr. G. Busk, the body designated by Prof. Ehrenberg *Spherosira volvox* is an ordinary *Volvox* in a different phase of development; its only marked feature of dissimilarity being that a large proportion of the green cells, instead of being single (as in the ordinary form of *Volvox*) save where they are developing themselves into young spheres, are very commonly double, quadruple, or multiple; and the groups of ciliated cells thus produced, instead of constituting a hollow sphere, form by their aggregation discoid bodies, of which the separate fusiform cells are connected at one end, whilst at the other they are free, each being furnished with a single cilium. These clusters separate themselves from the primary sphere, and swim forth freely, under the forms which have been designated by Prof. Ehrenberg as *Urella* and *Syncrypta*. (According to Mr. Carter, however, *Spherosira* is the male or spermatic form of *Volvox globator*. See § 199, note.) Again, it has been noticed by Dr. Hicks* that towards the end of the autumn, the bodies formed by the binary subdivision of the single cells of *Volvox*, instead of forming spherical ciliated Macrogonidia which tend to escape outwards, form clusters of irregular shape, each composed of an indefinite mass of gelatinous substance in which the green cells lie separately imbedded. These clusters, being without motion, may be termed *Stato-spores*; and it is probable that they constitute one of the forms in which the existence of this organism is prolonged through the winter, the others being the product of the true Generative process to be presently described.

198. Another phenomenon of a very remarkable nature, namely, the conversion of the contents of an ordinary Vegetable cell into a free moving mass of Protoplasm that bears a strong resemblance to the animal *Amæba* (Fig. 234), is affirmed by Dr. Hicks† to take

* "Quart. Journ. of Microsc. Science," n.s., Vol. i. (1861), p. 281.

† "Trans. of Microsc. Society," n.s., Vol. viii. (1860), p. 99, and "Quart. Journ. of Microsc. Science," n.s., Vol. ii. (1862), p. 96.

place in *Volvox*, under circumstances that leave no reasonable ground for that doubt of its reality which has been raised in regard to the accounts of similar phenomena occurring elsewhere. The Endochrome-mass of one of the ordinary cells increases to nearly double its usual size; but instead of undergoing duplicative subdivision so as to produce a Macro-gonidium as in Fig. 109, *b*, it loses its colour and its regularity of form, and becomes an irregular mass of colourless protoplasm containing a number of brown or reddish-brown granules (*a, a*), and capable of altering its form by protruding or retracting any portion of its membranous wall, exactly like a true *Amœba*. By this self-moving power, each of these bodies, *c, c* (of which twenty may sometimes be counted within a single *Volvox*)

FIG. 109.

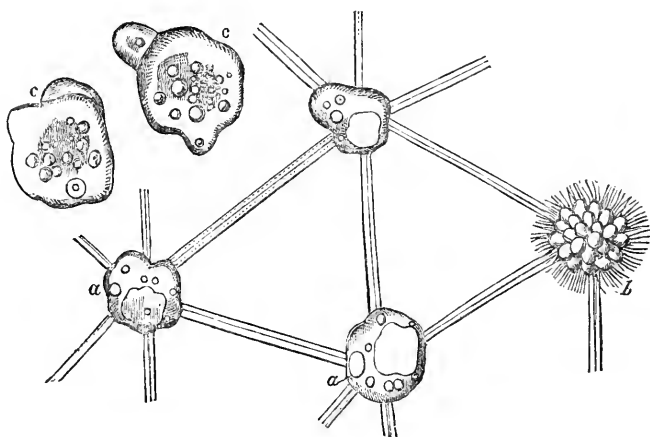

Formation of Amœboid Bodies in *Volvox* :—*a, a*, ordinary cells passing into the amœboid condition; *b*, ordinary macro-gonidium; *c, c*, free amœboids.

glides independently over the inner surface of the sphere among its unchanged green cells; and bends itself round any one of these with which it may come into contact, precisely after the manner of an *Amœba*. After the Amœboid has begun to travel, it is always noticed that for every such moving body in the *Volvox* there is the empty space of a missing cell; and this confirms the belief founded on observation of the gradational transition from the one condition to the other, and on the difficulty of supposing that any such bodies could have entered the sphere parasitically from without, that the Amœboid is really the product of the metamorphosis of a mass of vegetable protoplasm. This metamorphosis may take place, according to Dr. Hicks, even after the process of binary subdivision

has commenced. What is the subsequent destination of these Amœboid bodies, has not yet been certainly ascertained; but from his observations upon similar bodies developed from the protoplasmic contents of the roots of Mosses, Dr. Hicks thinks it probable that they become converted into minute ciliated bodies, which he has found to occur in larger or smaller groups, enclosed in cavities formed in the mucous layer just underneath the transparent sphere: of the subsequent history of these, however, we are at present left entirely in the dark.*

199. But the reproduction of *Volvox* is not effected only by processes which consist, under one form or another, in the multiplication of cells by subdivision. As already pointed out, the Life History of no organism can be considered as complete unless it includes an act of Conjugation, or some other form of the true Generative process; and the observations of Dr. Cohn † fully bear out this proposition in regard to *Volvox*. A sexual distinction between Sperm-cells and Germ-cells, such as is seen in *Faucheria* (§ 245), shows itself in certain spheres of *Volvox*; these being distinguishable by their greater size, and by the larger number of their component utricles. They are generally *monœcious*, that is, each sphere contains both kinds of sexual cells; the greater number of cells, however, remain neutral or asexual. The female or Germ-cells exceed their neighbours in size, acquire a deeper green tint, and become elongated towards the centre of the sphere; their endochrome undergoes no division. In the male or Sperm cells, on the other hand, though resembling the germ-cells in size and form, the endochrome breaks-up symmetrically into a multitude of linear corpuscles, aggregated into discoidal bundles. These bundles are beset with vibratile cilia, and move-about within their cells, slowly at first, afterwards more rapidly, and soon become separated into their constituent corpuscles. Each of these has a

* The known care and accuracy of Dr. Hicks give a weight to his statements as to the Amœboid condition sometimes assumed by the contents of Vegetable cells, which justifies their provisional reception, notwithstanding their apparent improbability. It will be seen as we proceed (§ 269) that the phenomenon is not so exceptional as it at first sight appears; and it does not involve any real confusion between the boundaries of Animal and Vegetable life. For the mere fact of spontaneous motion by the extension and retraction of processes of an indefinite Protoplasmic mass, no more makes that mass an *Animal*, than the vibration of the Cilia formerly supposed to be exclusively possessed by Animalcules alters the truly *Vegetable* character of the zoospores of a *Conferva* or of the *Volvox*-sphere itself. No proof has yet been given that these Vegetable Amœboids take into their interior, and appropriate by an act of digestion, nutrient materials supplied either by the Vegetable or by the Animal kingdom; so that, if the doctrine already stated (§ 180) as to essential distinction between the two Kingdoms in this particular be correct, such bodies remain as much on the Vegetable side of the line of division as if they had been entirely motionless.

† "Annales des Sciences Naturelles," 4ième Sér., Botan., Tom. v. p. 323.

linear body, thickened at its posterior extremity, and is furnished with two long cilia, bearing a strong general resemblance to the *antherozoids* of *Chara* (Fig. 159, H). These Antherozoids, escaping from the sperm-cells within which they were produced, diffuse themselves through the cavity of the sphere, and collect about the Germ-cells, which probably have not yet acquired any distinct cell-wall; so that the antherozoids can come into direct contact with their endochrome-mass, to which they attach themselves by their prolonged *rostrum* or beak. In this situation they seem to dissolve-away, so as to become incorporated with the endochrome; and the product of this fusion (which is obviously only 'conjugation' under another form) is a reproductive globule or Spore. This body speedily becomes enveloped by an internal smooth membrane, and with a thicker external coat which is usually beset with conical-pointed processes; and the contained Chlorophyll gives-place, as in *Palmoglaea* (§ 186), to Starch and a red or orange-coloured Oil. As many as forty of such *Oo-spores** have been seen by Dr. Cohn in a single sphere of *Volvox*, which thus acquires the peculiar appearance that has been distinguished by Ehrenberg by a different specific name, *Volvox stellatus*. Sometimes the Oo-spores are smooth; and the sphere charged with such is the *V. aureus* of Ehrenberg. That these two reputed species are only different phases of the ordinary *Volvox globator*, had been previously pointed-out by Mr. G. Busk; but they were regarded by him, not as generative products, but as 'still' or 'winter-spores.'—No observer has yet traced-out the developmental history, either of the Stato-spores, or of the Oo-spores of *Volvox stellatus* and *aureus*, or of the detached clusters of *Sphaerosira*; and these points offer themselves as problems of great interest for any Microscopist whose locality offers ready means for their solution. †

* The term *Oo-spore* (egg-spore) may be conveniently used to designate the reproductive cell which is the immediate product of the Sexual act or of the Conjugation which represents it.

† The doctrine of the *Vegetable* nature of *Volvox*, which had been suggested by Siebold, Braum, and other German Naturalists, was first distinctly enunciated by Prof. Williamson, on the basis of the history of its development, in the "Transactions of the Philosophical Society of Manchester," Vol. ix. Subsequently Mr. G. Busk, whilst adducing additional evidence of the Vegetable nature of *Volvox*, in his extremely valuable Memoir in the "Transactions of the Microscopical Society," N.S., Vol. i. (1853), p. 31, called in question some of the views of Prof. Williamson, which were justified by that gentleman in his "Further Elucidations" in the same Transactions. The Author has endeavoured to state the *facts* in which both these excellent observers agree (and which he has himself had the opportunity of verifying), with the *interpretation* that seems to him most accordant with the phenomena presented by other Protophytes; and he believes that this interpretation harmonizes with what is most essential in the doctrines of both, their differences having been to a certain degree reconciled by their mutual admissions.—The observations of Dr. Cohn on the sexuality of *Volvox* have been confirmed by Mr. Carter ("Ann. of Nat. Hist.," 3rd Ser., Vol. iii. 1859, p. 1), who,

200. *Desmidiaceæ*.—Among the simplest tribes of Protophytes, there are two which are of such peculiar interest to the Microscopist, as to need a special notice ; these are the *Desmidiaceæ* and the *Diatomaceæ*. Both of them were ranked by Ehrenberg and many other Naturalists as Animalcules ; but the fuller knowledge of their Life-history, and the more extended acquaintance with the parallel histories of other simple forms of Vegetation, which have been gained during the last twenty years,

FIG. 110.

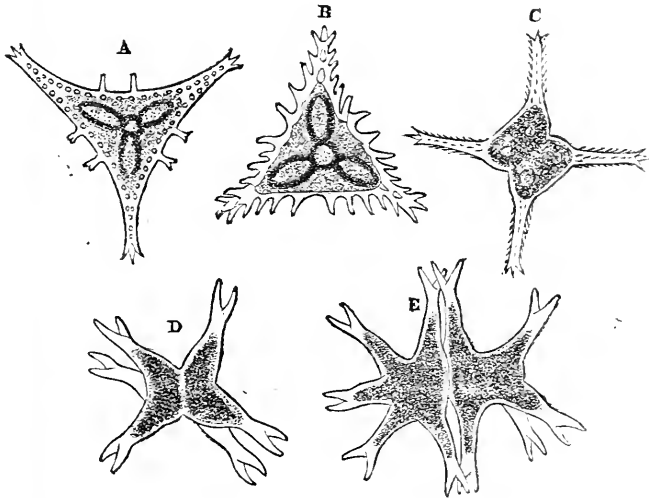

Various species of *Staurastrum* :—A, *S. vestitum* ; B, *S. aculeatum* ; C, *S. paradoxum* ; D, E, *S. brachiatum*.

are now generally accepted as decisive in regard to their Vegetable nature.—The *Desmidiaceæ** are minute plants of air

however, does not accord with the account given above of the relations of its different forms. According to him, *V. globator* and *V. stellatus* are essentially distinct ; the former is not monœcious but diœcious, and *Sphaerosira volvox* is its male or spermatic form ; whilst the latter is monœcious.—An extremely-interesting Volvocine form described by Cohn under the name *Stephanosphaera pluvialis* exhibits all the phenomena of reproduction by *Macro-gonidia* or composite masses of adherent cells, by *Micro-gonidia* or active zoospores, by 'still' or *Stato-spores*, and by *Oospores* produced by true sexual action, in a very characteristic manner ; and his account of its life-history should be consulted by every one who desires to study that of any of the Protophyta. See "Ann. of Nat. Hist." 2nd Ser., Vol. x. (1852), p. 321, and "Quart. Journ. of Microsc. Sci.," Vol. vi. (1858), p. 131.

* Our first accurate knowledge of this group dates from the publication

green colour, growing in fresh water; generally speaking, the cells are independent of each other (Figs. 110, 113, 114); but sometimes those which have been produced by binary subdivision from a single primordial cell, remain adherent one to another in linear series, so as to form a filament (Fig. 115). This tribe is distinguished by two peculiar features; one of these being the semblance of a subdivision into two symmetrical halves, divided by a 'sutural line,' which is sometimes so decided as to have led to the belief that the cell is really double (Fig. 113, A), though in other cases it is merely indicated by a slight notch; whilst the other is the frequency of projections from their surface, which are sometimes short and inconspicuous (Fig. 113), but are often elongated into spines, presenting a very symmetrical arrangement (Fig. 110). These projections are generally formed by the Cellulose envelope alone, which possesses an almost horny consistence, so as to retain its form after the discharge of its contents (Figs. 113, B, D, 117, E), but does not include any Mineral ingredient, either calcareous or siliceous, in its composition; in other instances, however, they are formed by a notching of the margin of the cell (Fig. 112), which may affect only the outer casing, or may extend into the cell-cavity. The outer coat is surrounded by a very transparent sheath of gelatinous substance, which is sometimes very distinct (as shown in Fig. 115), whilst in other cases its existence is only indicated by its preventing the contact of the cells. The outer coat encloses an inner membrane or Primordial Utricle, which is not always, however, closely adherent to it; and this immediately surrounds the Endochrome or coloured substance which occupies the whole interior of the cell, and which in certain stages of its growth is found to contain Starch-granules.—Many of these Plants have a power of slowly changing their place, so that they approach the light side of the vessel in which they are kept, and will even traverse the field of the Microscope under the eye of the observer; by what agency this movement is effected has not yet been certainly made out.

201. A *Circulation of fluid* has been observed in *Closterium*, not only (as in the cells of higher Plants, § 289) within the Primordial Utricle, but also (it is asserted) between this and the Cellulose envelope. It is not difficult to distinguish this movement along the convex and concave edges of the cell of any vigorous specimen of *Closterium*, if it be examined under a magnifying power of 250 or 300 diameters; and a peculiar whirling movement may also be distinguished in the large rounded space which is left at each end of the cell by the retreat of the Endochrome from the Primordial Utricle (Fig. 111, A, B). By careful focussing, the circulation may be seen in broad streams over the whole surface of the endochrome;

of Mr. Ralfs's admirable Monograph of it in 1848. For later information see the sections relating to it in Pritchard's "History of Infusoria," 4th Ed., 1861.

and these streams detach and carry with them, from time to time, little oval or globular bodies (*a*, *b*) which are put-forth from it, and are carried by the course of the flow to the chambers at the extremities, where they join a crowd of similar bodies. In each of these chambers (*B*), a current may be seen from the somewhat abrupt termination of the Endochrome, towards the obtuse end of the cell (as indicated by the interior arrows); and the globules it

FIG. 111.

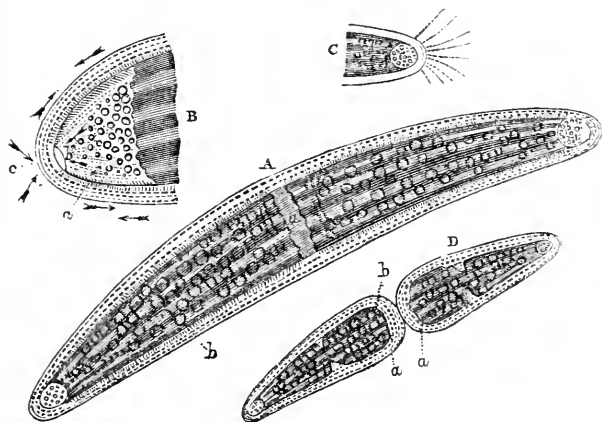

Circulation in *Closterium lunula*:—A, frond showing central separation at *a*, in which large globules, *b*, are not seen:—B, one extremity enlarged, showing at *a* the appearance of a double row of cilia, at *b* the internal current, and at *c* the external current;—C, external jet produced by pressure on the frond (?);—D, frond in a state of self-division.

contains are kept in a sort of twisting movement on the *inner* side (*a*) of the primordial utricle. Other currents are seen externally to it, which form three or four distinct courses of globules, passing towards and away from *c* (as indicated by the outer arrows), where they seem to encounter a fluid jetted towards them as if through an aperture in the primordial utricle at the apex of the chamber; and here some communication between the inner and the outer currents appears to take place.* This circulation is by no means peculiar

* See Mr. S. G. Osborne's communications to the "Quart. Journ. of Microsc. Sci.," Vol. ii. (1854), p. 234, and Vol. iii. (1855), p. 54.—Although the *Circulation* is an unquestionable fact, yet I have no hesitation in regarding the appearance of *ciliary action* as an optical illusion due to the play of the peculiar light employed among the moving particles of the fluid; the appearance which has been thus interpreted being producible at will (as Mr. Wenham has shown in the same journal, Vol. iv. 1856, p. 158) by a particular adjustment of the illumination, but being

to *Closterium*, having been seen in many other *Desmidiaceæ*.—Another curious movement is often to be witnessed in the interior of the cells of members of this family, especially the various species of *Cosmarium*, which has been described as ‘the swarming of the granules,’ from the extraordinary resemblance which the mass of particles of Endochrome in active vibratory motion bears to a swarm of bees. This motion continues for some time after the particles have been expelled by pressure from the interior of the cell, and it does not seem to depend (like that of true ‘Zoospores’) upon the action of Cilia, but rather to be a more active form of the molecular movement common to other minute particles freely suspended in fluid (§ 130). It has been supposed that the ‘swarming’ is related to the production of Zoospores (§ 190); but for this idea there does not seem any adequate foundation.*

202. When the single Cell has come to its full maturity, it commonly multiplies itself by *binary subdivision*; but the plan on which this takes-place is often peculiarly modified, in order to maintain the symmetry characteristic of the tribe. In a cell of the simple cylindrical form of those of *Didymoprium* (Fig. 115), little more is necessary than the separation of the two halves, which takes place at the sutural line, and the formation of a partition between them by the infolding of the primordial utricle, according to the plan already described (§ 185); and in this manner, out of the lowest cell of the filament A, a double cell B is produced. But it will be observed that each of the simple cells has a bifid wart-like projection of the cellulose wall on either side, and that the half of this projection, which has been appropriated by each of the two new cells, is itself becoming bifid, though not symmetrically; in process of time, however, the increased development of the sides of the cells which remain in contiguity with each other, brings up the smaller projections to the dimensions of the larger, and the symmetry of the cells is restored.—In *Closterium* (Fig. 111, D), the two halves of the Endochrome first retreat from one another at the sutural line, and a constriction takes place round the cellulose wall; this constriction deepens until it becomes an hour-glass contraction, which proceeds until the cellulose wall entirely closes round the primordial utricle of the two segments; in this state, one half commonly remains passive, whilst the other has a motion from side to side, which gradually becomes more active; and at last one segment quits the other with a sort of jerk. At this time a

undiscoverable when the greatest care is taken to avoid sources of fallacy. I must confess to a similar scepticism respecting the external apertures said by Mr. Osborne to exist at the extremities of *Closterium*; for whilst their existence is highly improbable on *à priori* grounds, Mr. Wenham (than whom no observer is entitled to more credit) states that “not the slightest break can be discovered in the laminated structure that the thickened ends display.”

* See Archer in “Quart. Journ. of Microsc. Sci.,” Vol. viii. (1860), p. 215.

constriction is seen across the middle of the primordial utricle of each segment ; but there is still only a single chamber, which is that belonging to one of the extremities of the original entire frond. The globular circulation, for some hours previously to subdivision, and for a few hours afterwards, runs quite round the obtuse end *a* of the endochrome ; but gradually a chamber is formed, like that at the opposite extremity, by a separation between the cellulose coat and the primordial utricle ; whilst, at the same time, the obtuse form becomes changed to a more elongated and contracted shape. Thus, in five or six hours after the separation, the aspect of each extremity becomes the same, and each half resembles the perfect frond in whose self-division it originated ; and the globular circulation within the newly-formed chamber comes into connection with the general circulation, some of the free particles which are moving over the surface of the primordial utricle being drawn into its vortex and tossed-about in its eddies.

203. The process is seen to be performed after nearly the same method in *Staurastrum* (Fig. 111, D, E) : the division taking-place across the central constriction, and each half gradually acquiring the symmetry of the original. — In such forms as *Cosmarium*, however, in which the cell consists of two lobes united together by a narrow isthmus (Fig. 113), the division takes place after a different method ; for when the two halves of the outer wall separate at the sutural line, a semiglobular protrusion of the Endochrome is put forth from each half ; these protrusions are separated from one another and from the two halves of the original cell (which their interposition carries apart) by a narrow neck ; and they progressively increase until they assume the appearance of the half-segments of the original cell. In this state, therefore, the plant consists of a row of four segments, lying end to end, the two old ones forming the extremes, and the two new ones (which do not usually acquire the full size or the characteristic markings of the original before the division occurs) occupying the intermediate place. At last the central fission becomes complete, and two bipartite fronds are formed, each having one old and one young segment ; the young segment, however, soon acquires the full size and characteristic aspect of the old one ; and the same process, the whole of which may take-place within twenty-four hours, is repeated ere long.* The same general plan is followed in *Micrasterias denticulata* (Fig. 112) ; but as the small hyaline hemisphere, put-forth in the first instance from each frustule (A), enlarges with the flowing-in of the endochrome, it undergoes progressive subdivision at its edges, first into three lobes (B), then into five (C), then into seven (D), then into thirteen (E), and finally at the time

* See the observations of Mrs. Herbert Thomas on *Cosmarium margaritiferrum*, in "Transact. of Microsc. Society," N.S., Vol. iii., 1855, pp. 33-36. — Several varieties in the mode of subdivision are described in this short record of long-continued observations, as of occasional occurrence.

of its separation (F) acquires the characteristic notched outline of its type, being only distinguishable from the older half by its smaller size. The whole of this process may take place within three hours and a half.*—In *Spherozosma*, the cells thus produced remain connected in rows within a gelatinous sheath, like those of *Didymoprium* (Fig. 115); and different stages of the process

FIG. 112.

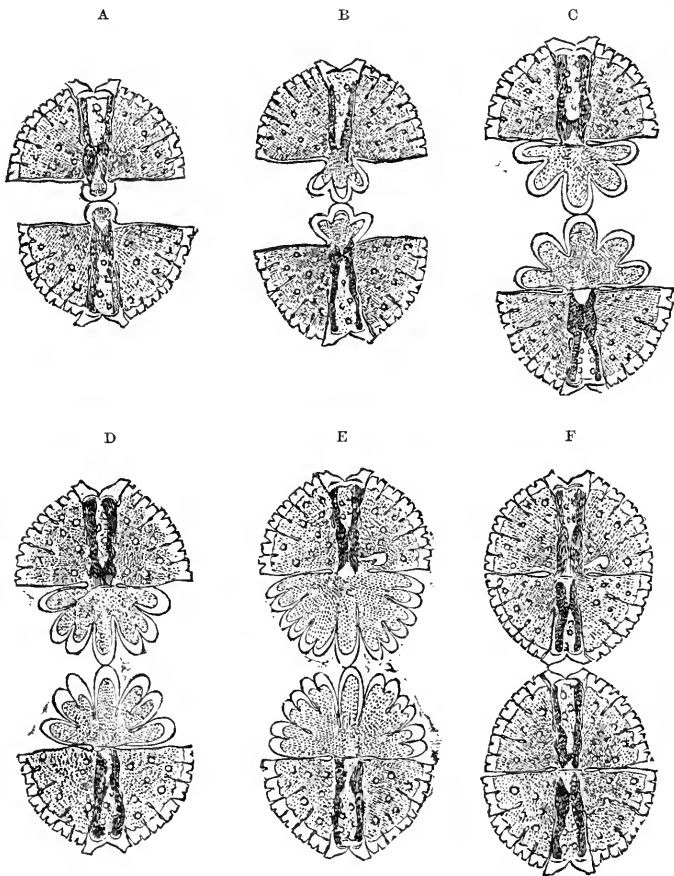

Binary Subdivision of *Micrasterias denticulata*.

may commonly be observed in the different parts of any one of the filaments thus formed. In any such filament, it is obvious that the two oldest segments are found at its opposite extremities, and that each subdivision of the intermediate cells must carry them

* See Lobb in "Transact. of Microsc. Society," n.s., Vol. ix. (1861), p. 1.

further and further from each other. This is a very different mode of increase from that of the *Conferraceæ*, in which the terminal cell alone undergoes subdivision (§ 249), and is consequently the last formed.

204. Although it is probable that the *Desmidiaceæ* generally multiply themselves also by the subdivision of their endochrome into a number of Zoospores, only one undoubted case of the kind has yet been recorded (the *Pediasireæ*, § 218, being no longer ranked within this group); that, namely, of *Docidium Ehrenbergii*, whose elongated cell puts forth from the vicinity of the sutural line one, two, or three tubular extensions resembling the finger of a glove, through which there pass out from 20 to 50 motile *Micro-gonidia* formed by the breaking-up of the endochrome of the neighbouring portion of each segment.*

205. Whether there is in this group anything that corresponds to the Encysting process (§ 188) or the formation of Stato-spores, (§ 197) in other Protophytes, has not yet been certainly ascertained; but the following observations may have reference to such a condition. It is stated by Focke that the entire endochrome of *Closterium* sometimes retracts itself from the cell-wall, and breaks itself up into a number of globules, every one of which acquires a very firm envelope. And it is affirmed by Mr. Jenner that "in all the *Desmidiaceæ*, but especially in *Closterium* and *Micrasterias*, small, compact, seed-like bodies of a blackish colour are at times to be met with. Their situation is uncertain, and their number varies from one to four. In their immediate neighbourhood the endochrome is wanting, as if it had been required to form them; but in the rest of the frond it retains its usual colour and appearance." It seems likely that, when thus enclosed in a firm cyst, the *Gonidia* are more capable of preserving their vitality, than they are when destitute of such a protection; and that in this condition they may be taken-up and wafted through the air, so as to convey the species into new localities.

206. The proper Generative process in the *Desmidiaceæ* is always accomplished by the act of Conjugation; and this takes place after a manner very different from that in which we have seen it to occur in *Palmoglaea* (§ 186). For each cell here possesses, it will be recollected, a firm external envelope, which cannot enter into coalescence with that of any other; and this membrane dehisces more or less completely, so as to separate each of the conjugating cells into two valves (Fig. 113, c, d; Fig. 114, c). The contents of each cell, being thus set-free without (as it appears) any distinct investment, blend with those of the other; and a mass is formed by their union, which soon acquires a truly membranous envelope.† This envelope is at first very delicate, and is filled with

* See Archer in "Quart. Journ. of Microsc. Sci.," Vol. viii. (1860), p. 227.

† In certain species of *Closterium*, as in many of the *Diatomaceæ* (§ 219), the act of conjugation gives origin to two Sporangia.

green and granular contents; by degrees the envelope acquires increased thickness, and the contents of the spore-cell become brown or red. The surface of the

FIG. 113.

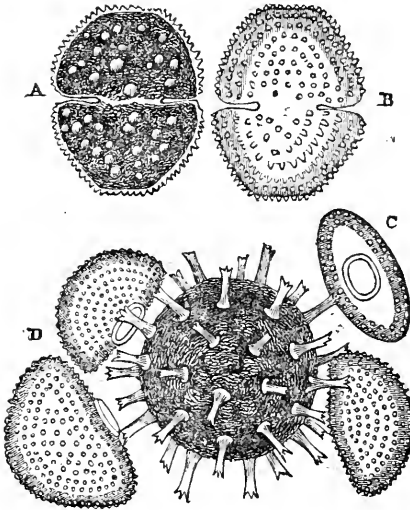

Conjugation of *Cosmarium botrytis*.—A, mature frond; B, empty frond; C, transverse view; D, sporangium with empty fronds.

forms a sort of connecting tube that unites the cavities of the two cells (Fig. 115, D, E). Through this tube the entire endochrome of one cell passes over into the cavity of the other (D), and the two are commingled so as to form a single mass (E), as is the case in many of the *Conjugateæ* (§ 251). The joint which contains the Sporangium can scarcely be distinguished at first (after the separation of the empty cell), save by the greater density of its contents; but the proper coats of the sporangium gradually become more distinct, and the enveloping cell-wall disappears.—The subsequent history of the Sporangia has hitherto been made out in only a few cases. From the observations of Mrs. H. Thomas (loc. cit.) on *Cosmarium*, it appeared that each sporangium gives origin, not to a single cell but to a brood of cells; and this view is fully confirmed by Hoffmeister ("Ann. of Nat. Hist.," 3rd Ser., Vol. i. 1858, p. 2), who speaks of it as beyond doubt that the contents of

Sporangium, as this body is now termed, is sometimes smooth, as in *Closterium* and its allies (Fig. 114); but in the *Cosmariceæ*, it acquires a granular, tuberculated, or even spinous surface (Fig. 113), the spines being sometimes simple and sometimes forked at their extremities.*—The mode in which conjugation takes place in the filamentous species constituting the *Desmidiaceæ* proper, is, however, in many respects different. The filaments first separate into their component joints; and when two cells approach in conjugation, the outer cell-wall of each splits or gapes at that part which adjoins the other cell, and a new growth takes place, which

* Bodies precisely resembling these, and almost certainly to be regarded as of like kind, are often found fossilized in Flints, and have been described by Ehrenberg as the remains of *Animalcules*, under the name of *Xanthidia*.

the sporangia of *Cosmarium* are transformed by repeated binary subdivisions into 8 or 16 cells, which assume the original form of the parent before they are set free by the rupture or diffidence of the wall of the sporangium. The observations of Jenner and Focke render it probable that the same is the case in *Closterium*; but much has still to be learned in regard to the development of the products of the Generative process, as it is by no means certain

FIG. 114.

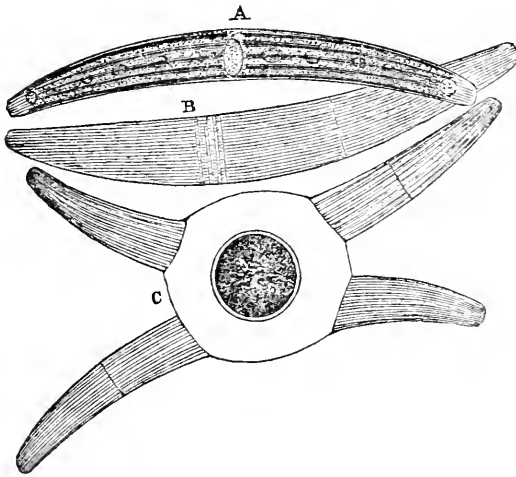

Conjugation of *Closterium striatolum*:—A, ordinary frond; B, empty frond; C, two fronds in conjugation.

that they always resemble the parent forms. For it is affirmed by Mr. Ralfs that there are several Desmidiaceæ which never make their appearance in the same pools for two years successively, although their Sporangia are abundantly produced,—a circumstance which would seem to indicate that their sporangia give origin to some different forms. It is a subject, therefore, to which the attention of Microscopists cannot be too sedulously directed.

207. The subdivision of this Family into Genera, according to the method of Mr. Ralfs ("British Desmidiæ"), as modified by Mr. Archer (Pritchard's "Infusoria"), is based in the first instance upon the connection or disconnection of the individual cells; two groups being thus formed, of which one includes all the genera whose cells, when multiplied by binary subdivision, remain united into an elongated filament; whilst the other comprehends all those in which the cells become separated by the completion of the fission. The further division of the filamentous group, in which the Sporangia are always orbicular and smooth, is based on the fact that in one set of genera the joints are many times longer

than they are broad, and that they are neither constricted nor furnished with lateral teeth or projections; whilst in the other set (of which *Didymoprium*, Fig. 115, is an example) the length and

FIG. 115.

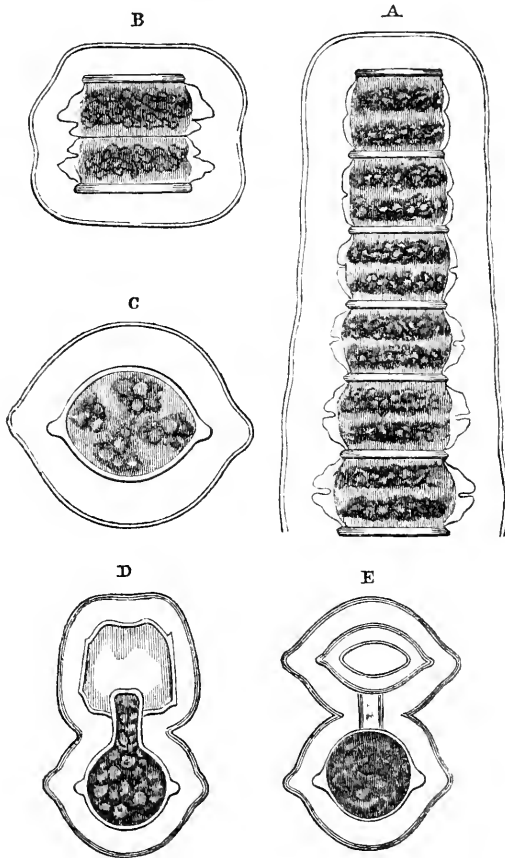

Binary subdivision and Conjugation of *Didymoprium Grevillii*:—A, portion of filament, surrounded by gelatinous envelope; B, dividing joint; C, single joint viewed transversely; D, two cells in conjugation; E, formation of sporangium.

breadth of each joint are nearly equal, and the joints are more or less constricted, or have lateral teeth or projecting angles, or are otherwise figured; and it is for the most part upon the variations in these last particulars, that the generic characters are based. The solitary group presents a similar basis for primary division

in the marked difference in the proportions of its cells; such elongated forms as *Closterium* (Figs. 111, 114), in which the length of the frond is many times its breadth, being thus separated from those in which, as in *Micrasterius* (Fig. 112), *Cosmarium* (Fig. 113), and *Staurastrum* (Fig. 110), the breadth of the frond more nearly equals the length. In the former the Sporangia are smooth, whilst in the latter they are very commonly spinous and are sometimes quadrate. In this group the chief secondary characters are derived from the degree of constriction between the two halves of the frond, the division of its margin into segments by incisions more or less deep, and its extension into teeth or spines.

208. The *Desmidiaceæ* are not found in running streams, unless the motion of the water be very slow; but are to be looked for in standing though not stagnant waters. Small shallow pools that do not dry-up in summer, especially in open exposed situations, such as boggy moors, are most productive. The larger and heavier species commonly lie at the bottom of the pools, either spread-out as a thin gelatinous stratum, or collected into finger-like tufts. By gently passing the fingers beneath these, they may be caused to rise towards the surface of the water, and may then be lifted out by a tin-box or scoop. Other species form a greenish or dirty cloud upon the stems and leaves of other aquatic plants; and these also are best detached by passing the hand beneath them, and 'stripping' the plant between the fingers, so as to carry off upon them what adhered to it. If, on the other hand, the bodies of which we are in search should be much diffused through the water, there is no other course than to take it up in large quantities by the box or scoop, and to separate them by straining through a piece of linen. At first nothing appears on the linen but a mere stain or a little dirt; but by the straining of repeated quantities, a considerable accumulation may be gradually made. This should be then scraped off with a knife, and transferred into bottles with fresh water. If what has been brought up by hand be richly charged with these forms, it should be at once deposited in a bottle; this at first seems only to contain foul water; but by allowing it to remain undisturbed for a little time, the *Desmidiaceæ* will sink to the bottom, and most of the water may then be poured-off, to be replaced by a fresh supply. If the bottles be freely exposed to solar light, these little plants will flourish, apparently as well as in their native pools; and their various phases of multiplication and reproduction may be observed during successive months or even years.—If the pools be too deep for the use of the hand and the scoop, a Collecting-Bottle attached to a stick (§ 176) may be employed in its stead. The Ring-Net (§ 176) may also be advantageously employed, especially if it be so constructed as to allow of the ready substitution of one piece of muslin for another. For by using several pieces of previously wetted muslin in succession, a large number of these minute

organisms may be separated from the water ; the pieces of muslin may be brought home folded-up in wide-mouthed bottles, either separately, or several in one, according as the organisms are obtained from one or from several waters ; and they are then to be opened-out in jars of filtered river-water, and exposed to the light, when the Desmidiaceæ will detach themselves.

209. *Pediasireæ*.—The members of this family were formerly included in the preceding group ; but, though doubtless related to the true *Desmidiaceæ* in certain particulars, they present too many points of difference to be properly associated with them. Their chief point of resemblance consists in the firmness of the outer casing, and in the frequent interruption of its margin either by the protrusion of 'horns' (Fig. 116, A), or by a notching more or less deep (Fig. 117, B) ; but they differ in these two important particulars, that the cells are not made up of two symmetrical halves, and that they are always found in aggregation, which is not—except in such genera as *Scenodesmus* (*Arthrodesmus*, Ehr.) which connect this group with the preceding—in linear series, but in the form of discoidal fronds. In this tribe we meet with a form of multiplication by Zoospores aggregated into *Macrogonidia*,* which reminds us of the formation of the motile spheres of *Volvox* (§ 196), and which takes place in such a manner that the resultant product may vary greatly in number of its cells, and consequently both in size and in form. Thus in *Pediastrum granulosum* (Fig. 116), the zoospores formed by the subdivision of the endochrome of one cell into gonidia, which may be 4, 8, 16, 32, or 64 in number, escape from the parent-frond still enclosed in the inner tunic of the cell ; and it is within this that they develop themselves into a cluster resembling that in which they originated, so that whilst the frond normally consists of 16 cells, it may be composed of either of the just-mentioned multiples or sub-multiples of that number. At A is seen an old disk, of irregular shape, nearly emptied by the emission of its macro-gonidia, which had been seen to take-place within a few hours previously from the cells *a, b, c, d, e* ; most of the empty cells exhibit the cross slit through which their contents had been discharged ; and where this does not present itself on the side next the observer, it occurs on the other. Three of the cells still possess their coloured contents, but in different conditions. One of them exhibits an early stage of the subdivision of the endochrome, namely into two halves, one of which already appears halved again. Two others are filled by sixteen very closely-crowded gonidia, only half of which are visible, as they form a double layer. Besides these, one cell is in the very act of discharging its gonidia ; nine of which have passed forth from its cavity, though still enveloped in a vesicle formed by the

* Solitary zoospores or *micro-gonidia* have been observed by Braun to make their way out and swim away ; but their subsequent history is unknown.

extension of its innermost membrane ; whilst seven yet remain in its interior. The new-born family, as it appears immediately on

FIG. 116.

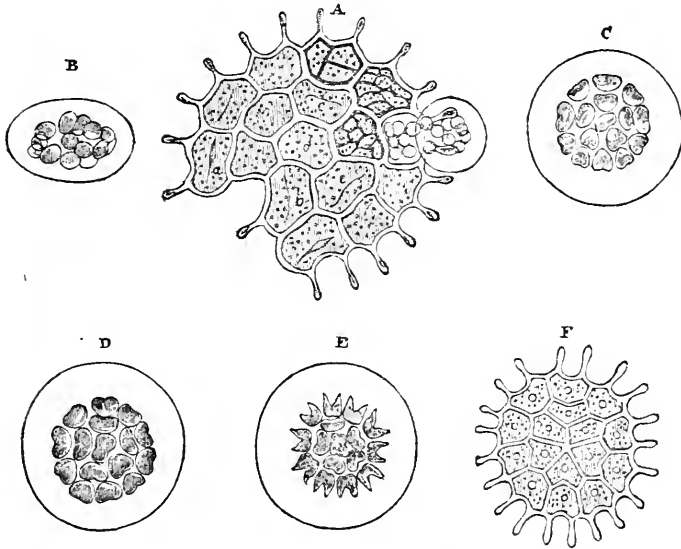

Various phases of development of *Pediatrum granulatum*.

its complete emersion, is shown at B ; the gonidia are actively moving within the vesicle ; and they do not as yet show any indication either of symmetrical arrangement, or of the peculiar form which they are subsequently to assume. Within a quarter of an hour, however, the gonidia are observed to settle-down into one plane, and to assume some kind of regular arrangement, most commonly that seen at c, in which there is a single central body surrounded by a circle of five, and this again by a circle of ten ; they do not, however, as yet adhere firmly together. The gonidia now begin to develope themselves into new cells, increase in size, and come into closer approximation (D) ; and the edge of each, especially in the marginal row, presents a notch, which foreshadows the production of its characteristic 'horns.' Within about four or five hours after the escape of the gonidia, the cluster has come to assume much more of the distinctive aspect of the species, the marginal cells having grown-out into horns (E) ; still, however, they are not very closely connected with each other ; and between the cells of the inner row considerable spaces yet intervene. It is in the course of the second day that the cells become closely applied to each other, and that the growth of the horns is completed, so

as to constitute a perfect disk like that seen at F, in which, however, the arrangement of the interior cells does not follow the typical plan.*

210. The varieties which present themselves, indeed, both as to the number of cells in each cluster, and the plan on which they are disposed, are such as to baffle all attempts to base specific distinctions on such grounds; and the more attentively the Life-history of any one of these Plants is studied, the more evident does it appear that many reputed Species have no real existence. Some of these, indeed, are nothing else than mere transitory forms; thus it can scarcely be doubted that the specimen represented in Fig. 117, D, under the name of *Pediastrum pertusum*, is in reality nothing else than a young frond of *P. granulatum*, in the stage represented in Fig. 116, E, but consisting of 32 cells. On the other hand, in Fig. 117, E, we see an emptied frond of *P. granulatum*, exhibiting the peculiar surface-marking from which the name of the species is derived, but composed of no more than 8 cells. And instances every now and then occur in which the frond consists of

FIG. 117.

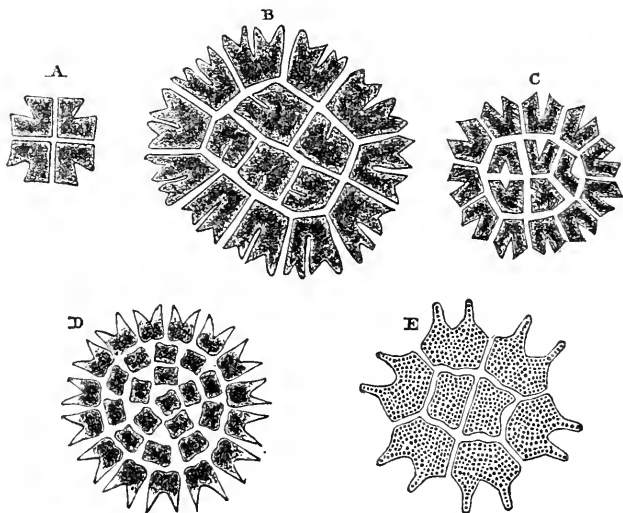

Various species(?) of *Pediastrum*:—A, *P. tetras*; B, C, *P. bivadiatum*; D, *P. pertusum*; E, empty frond of *P. granulatum*.

only 4 cells, each of them presenting the two-horned shape. So, again, in Fig. 117, B and C, are shown two varieties of *Pediastrum*

* See Prof. Braun on "The Phenomenon of Rejuvenescence in Nature," published by the Ray Society in 1853; and his subsequent Memoir, "Algarum Unicellularum Genera nova aut minus cognita," 1855.

biradiatum, whose frond is normally composed of sixteen cells; whilst at a is figured a form which is designated as *P. tetras*, but which may be strongly suspected to be merely a 4-celled variety of b and c. Many similar cases might be cited; and the Author would strongly urge those Microscopists who have the requisite time and opportunities, to apply themselves to the determination of the *real species* of these groups, by studying the entire life history of whatever forms may happen to lie within their reach, and noting all the varieties which present themselves among the offsets from any one stock. It must not be forgotten that this process of *multiplication* is analogous to the propagation of the higher Plants by Gemmation or 'budding,' and to the subsequent separation of the buds, either spontaneously, or by the artificial operations of grafting, layering, &c.; and just as in all these cases the particular *variety* is propagated, whilst only the characters of the *species* are transmitted by the true Generative operation to the descendants raised from Seed, so does it come to pass that the characters of any particular variety which may arise among these Unicellular Plants, are diffused by the process of binary subdivision amongst vast multitudes of so-called individuals. Thus it happens that, as Mr. Ralfs has remarked, "one pool may abound with individuals of *Staurastrum dejectum* or *Arthrodesmus incus*, having the mucro curved outwards; in a neighbouring pool, every specimen may have it curved inwards; and in another it may be straight. The cause of the similarity in each pool no doubt is, that all its plants are offsets from a few primary fronds." Hence the universality of any particular character, in all the specimens of one gathering, is by no means sufficient to entitle these to take rank as a distinct species; since they are, properly speaking, but repetitions of the same form by a process of simple multiplication, really representing in their entire aggregate the one Plant or Tree that grows from a single seed.

211. *Diatomaceæ*.—Notwithstanding the very close affinity which, as will be presently shown, exists between this group and the *Desmidiaceæ*, some Naturalists who do not hesitate in regarding the members of the last-named family as Plants, persist in referring the *Diatomaceæ* to the Animal kingdom. For this separation, however, no adequate reason can be assigned; the curious movements which the *Diatomaceæ* exhibit being certainly not of a nature to indicate the possession of any truly Animal endowment, and all their other characters being unmistakably Vegetable. Like the *Desmidiaceæ* they are *simple Cells*, having a firm external coating, within which is included a mass of endochrome whose superficial layer seems to be consolidated into a sort of primordial utricle. The external coat is consolidated by *silex*, the presence of which in this situation is one of the most distinctive characters of the group; but it is a mistake to suppose that the casing is composed of silex alone. For a Membrane bearing all the markings

of the siliceous envelope has been found by Prof. Bailey to remain after the removal of the silex by hydrofluoric acid ; and although this membrane seems to have been presumed by him, as also by Prof. W. Smith, to lie beneath the siliceous envelope, and to *secrete* this on its surface as a sort of epidermis, yet the Author agrees with the authors of the "Micrographic Dictionary" (p. 200), in considering it much more likely that it is the proper Cellulose wall *interpenetrated* by silex ; especially since it has been found by Schmidt, that after removing the protoplasm of *Frustulia salina* by potash, and the oil by ether, a substance remains identical in composition with the Cellulose of Lichens. Moreover, there are several Diatoms in which, as in *Arachnoidiscus* (§ 229), a pellicle of vegetable membrane of horny consistence, having markings of its own quite independent of those of the silicified layer, overlies the latter ; and it is probably never entirely absent, although it is sometimes thin enough to be removed by a few seconds' immersion in boiling nitric acid. Hence, as Prof. Walker Arnott has justly observed,* the appearances presented by individuals of the same species vary greatly, according to the treatment to which they have been respectively subjected ; and no certainty can be obtained in the discrimination of Species, except by the comparison of recent specimens, 1st, after being immersed for a short time in cold nitric acid, or simply washed in boiling water ; 2nd, after being boiled in acid for about half a minute, or a whole minute at most ; 3rd, after being boiled for a considerable time. Thus it is obvious that specimens obtained from Guano or from Fossilized deposits can only be rightly compared with Recent specimens, when the latter have been subjected to a treatment whereby their organic matter shall be removed as completely as possible.

212. The Endochrome of Diatomaceæ, instead of being bright green, is of a yellowish brown ; and its peculiar colour seems to be in some degree dependent upon the presence of *iron*, which is assimilated by the plants of this group, and may be detected even in their colourless silicified envelopes. The Colouring substance appears to be a modification of ordinary chlorophyll ; it takes a green or greenish-blue tint with sulphuric acid ; and often assumes this hue in drying. The endochrome consists, as in other plants, of a viscid Protoplasm, in which float the granules of colouring matter. In the ordinary condition of the cell these granules are diffused through it with tolerable uniformity, except in the central spot, which is occupied by a *Nucleus* ; round this nucleus they commonly form a ring, from which radiating lines of granules may be seen to diverge into the cell-cavity. At certain times, Oil-globules are observable in the protoplasm ; these seem to represent the starch-granules of the Desmidiaceæ (§ 200) and the oil-globules of other Protophytes (§ 182). A distinct movement of the granular particles of the endochrome, closely resembling the

* "Quarterly Journal of Microscopical Science," Vol. vi. (1858), p. 163.

circulation of the cell-contents of the Desmidiaceæ (§ 201), has been noticed by Prof. W. Smith* in some of the larger species of Diatomaceæ, such as *Surirella biseriata*, *Nitzschia scalaris*, and *Campylodiscus spiralis*, and by Prof. Max Schultze† in *Coscinodiscus*, *Denticella*, and *Rhizosolenia*; and although this movement has not the regularity so remarkable in the preceding group, yet its existence is important as confirming the conclusion that each Diatom is a single Cell (the endochrome moving freely from one part of its cavity to another), and that it does not contain in its interior the aggregation of separate organs which have been imagined to exist in it.

213. The *Diatomaceæ* seem to have received their name from the readiness with which those forms that grow in coherent masses (which were those with which Naturalists first became acquainted) may be cut or broken-through; hence they have been also designated by the vernacular term 'brittle-worts.' Of this we have an example in the common *Diatoma* (Fig. 127), whose component Cells (which in this tribe are usually designated as *frustules*) are sometimes found adherent side by side (as at *b*) so as to form filaments, but are more commonly met-with in a state of partial separation, remaining connected at their angles only (usually the alternate angles of the contiguous frustules) so as to form a zig-zag chain. A similar cohesion at the angles is seen in the allied genus *Grammatophora* (Fig. 128), in *Isthmia* (Fig. 134), and in many other Diatoms; in *Biddulphia* (Fig. 121) there even seems to be a special organ of attachment at these points. In some Diatoms, however, the frustules produced by successive acts of binary subdivision habitually remain coherent one to another; and thus are produced filaments or clusters of various shapes. Thus it is obvious that when each frustule is a short cylinder, an aggregation of such cylinders, end to end, must form a rounded filament, as in *Melosira* (Figs. 131 and 132); and whatever may be the form of the sides of the frustules, if they be parallel one to the other, a straight filament will still be produced, as in *Achnanthes* (Fig. 138). But if, instead of being parallel, the sides be somewhat inclined towards each other, a curved band will be the result; this may not continue entire, but may so divide itself as to form fan-shaped expansions, as those of *Lichmophora flabellata* (Fig. 126); or the cohesion may be sufficient to occasion the band to wind itself (as it were) round a central axis, and thus, not merely

* The account of the *Diatomaceæ* given in this manual is chiefly based on the valuable "Synopsis of the British Diatomaceæ," by the late Prof. W. Smith; of which, and of its beautiful illustrations by Mr. Tuffen West, the Author has been enabled to make free use by the liberality of Messrs. Smith and Beck. He has, however, entirely redrawn the sketch which he has given of the Systematic Arrangement of the group, in accordance with the more recent classification of Mr. Ralfs (Pritchard's "Infusoria," 4th Edition).

† "Quart. Journ. of Microsc. Science," Vol. vii. (1859), p. 13.

to form a complete circle, but a spiral of several turns, as in *Meridion circulare* (Fig. 124). Many Diatoms, again, possess a *Stipes*, or stalk-like appendage, by which aggregations of frustules are attached to other plants, or to stones, pieces of wood, &c.; and this may be a simple foot-like appendage, as in *Achnanthes longipes* (Fig. 138), or it may be a composite Plant-like structure, as in *Lichmophora* (Fig. 126), *Gomphonema* (Fig. 139), and *Mastogloia* (Fig. 142). Little is known respecting the nature of this stipes; it is, however, quite flexible, and may be conceived to be an extension of the cellulose coat unconsolidated by siliceous matter, analogous to the prolongations which have been seen in the *Desmidiaceæ* (§ 200), and to the filaments which sometimes connect the cells of the *Palmellaceæ* (§ 239). Some Diatoms, again, have a mucous or gelatinous investment, which may even be so substantial that their frustules lie as it were in a bed of it, as in *Mastogloia* (Figs. 142, 143), or which may form a sort of tubular sheath to them, as in *Schizonema* (Fig. 139). In a large proportion of the group, however, the frustules are always met with entirely *free*; neither remaining in the least degree coherent one to another after the process of binary subdivision has once been completed, nor being in any way connected either by a stipes or by a gelatinous investment. This is the case, for example, with *Triceratium* (Fig. 119), *Pleurosigma* (Fig. 120), *Actinocyclus* (Fig. 144, *b, b*), *Actinoptychus* (Fig. 120, *b, b*), *Arachnoidiscus* (Plate X.), *Campylodiscus* (Fig. 130), *Surirella* (Fig. 129), *Coscinodiscus* (Fig. 144, *a, a, a*), and many others. The solitary discoid forms, however, when obtained in their living state, are commonly found cohering to the surface of Seaweeds.

214. We have now to examine more minutely into the curious structure of the Siliceous envelope which constitutes the characteristic feature of the Diatomaceæ, and the presence of which imparts a peculiar interest to the group, not merely on account of the elaborately-marked pattern which it often exhibits, but also through the perpetuation of the minutest details of that pattern in the specimens obtained from Fossilized deposits (Figs. 144, 145). The siliceous envelope of every Diatomaceous cell or 'frustule' consists of two *valves* or plates, usually of the most perfect symmetry, closely applied to each other, like the two valves of a Mussel or other bivalve shell, along a line of junction or *suture*; and each valve being more or less concavo-convex, a cavity is left between the two, which is occupied by the cell-contents. The form of this cavity, however, varies widely in different Diatoms; for sometimes each valve is hemispherical, so that the cavity is globular; sometimes it is a smaller segment of a sphere resembling a watch-glass, so that the cavity is lenticular; sometimes the central portion is completely flattened and the sides abruptly turned-up, so that the valve resembles the cover of a pill-box, in which case the cavity will be cylindrical; and these and other varieties may co-exist

with any modifications of the contour of the valves, which may be square, triangular (Fig. 119), heart-shaped (Fig. 130), boat-shaped (Fig. 129, A), or very much elongated (Fig. 120), and may be furnished (though this is rare among the Diatomaceæ), with projecting out-growths (Figs. 135, 136). Hence the shape presented by the frustule differs completely with the aspect under which it is seen. In all instances, the frustule is considered to present its 'front' view when its suture is turned towards the eye, as in Fig. 129, B, c; whilst its 'side' view is seen when the centre of either valve is directly beneath the eye (A). Although the two valves meet along the suture in those newly-formed frustules which have been just produced by binary subdivision (as shown in Fig. 121, A, e), yet as soon as they begin to undergo any increase the valves separate from one another, and the cell-membrane which is thus left exposed immediately becomes consolidated by siliceous matter, and thus forms a sort of *hoop* that intervenes between the valves (as seen at c); this hoop becomes broader and broader with the increase of the cell in length; and it sometimes attains a very considerable width (A, b). As growth and self-division are continually going on when the frustules are in a healthy vigorous condition, it is rare to find a specimen in which the valves are not in some degree separated by the interposition of the hoop.

215. The impermeability of the Siliceous envelope renders necessary some special aperture, through which the surrounding water may come into relation with the contents of the cell. Such apertures are found along the whole line of suture in disk-like frustules; but when the Diatom is of an elongated form, they are found at the extremities of the frustules only. They do not appear to be absolute perforations in the envelope, but are merely points at which its siliceous impregnation is wanting; and these are usually indicated by slight depressions of its surface. In some Diatoms, as *Surirella* (Fig. 129) and *Campylodiscus* (Fig. 130), these interruptions are connected with what have been thought to be minute canals hollowed out between the siliceous envelope and the membrane investing the endochrome; but it seems more probable that the apparent canals are really internal ribs or projections of the shell.—In many genera the surface of each valve is distinguished by the presence of a longitudinal band on which the usual markings are deficient; and this is widened into small expansions at the extremities, and sometimes at the centre also, as we see in *Pleurosigma* (Fig. 120) and *Gomphonema* (Fig. 140). This band seems to be merely a portion in which the siliceous envelope is thicker than it is elsewhere, forming a sort of rib that seems designed to give firmness to the valve; and its expansions are solid *nodules* of the same substance. These nodules were mistaken by Prof. Ehrenberg for *apertures*; and in this error he has been followed by Kützing. There cannot any longer, however, be a doubt as to their real nature. As Prof. W. Smith has justly remarked:—

“The internal contents of the frustule never escape at these points when the frustule is subjected to pressure, but invariably at the suture or at the extremities, where the foramina already described exist. Nor does the valve, when fractured, show any disposition to break at the expansions of the central line, as would necessarily be the case were such points perforations and not nodules.” And Prof. Bailey has arrived at the same conclusion from watching the results of the action of hydrofluoric acid on the silicified valves, the thinnest parts of which are of course the first to be dissolved, whilst the parts which have been described as apertures are found to be the last to disappear.

216. The nature of the delicate and regular markings with which probably every Diatomaceous valve is beset, has been of late years a subject of much discussion among Microscopists; but on certain points there is now a general convergence of opinion. There can be

FIG. 118.

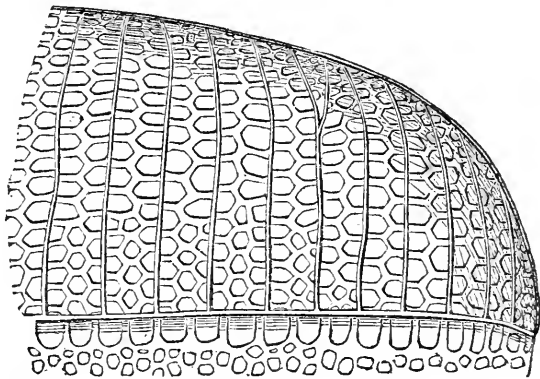
Portion of Cell of *Isthmia nervosa*, highly magnified.

no question as to the nature of the comparatively coarse areolation seen in the larger forms, such as *Isthmia* (Fig. 118), *Triceratium* (Fig. 119), and *Biddulphia* (Fig. 121); in all of which the structure of the valve can be distinctly seen under a low magnifying power and with ordinary light. In each of these instances we see a number of symmetrically disposed *areolæ*, rounded, oval, or hexagonal, with intervening boundaries; and the idea at once suggests itself, that these areolæ are portions of the surface either elevated above or depressed below the rest. That the areolæ are really *depressions*, is suggested by the appearances presented by the surface when the light is obliquely directed; and it may also be inferred from their aspect when viewed by the Black-ground illumination (§ 84), since the areolæ are then less bright than their boundaries, less light being stopped by their thinner substance. The view of these objects

under the Binocular Microscope fully confirms the inferences drawn from the phenomena they present to the single eye ; presenting the network in unmistakable relief, and showing the areolæ to be really depressions. Moreover, when a valve is broken, the line of fracture corresponds to what, on this view of its structure, is its weakest portion ; since it passes through the areolæ instead of through the intervening network, which last, instead of forming the thick framework of the valve, would be its weaker portion if the areolæ were prominences. But the most satisfactory proof that the areolæ are depressions is perhaps that which is afforded by a *side-view* of them, such as may be obtained by examining the curved edges of the valves in *Isthmia* ; this, it may be safely affirmed, can leave no doubt in the mind of any competent and unprejudiced observer as to the nature of the markings in that genus ; and analogy would seem to justify the extension of the same view to the other cases in which the microscopic appearances correspond.*

—But it is with regard

FIG. 119.

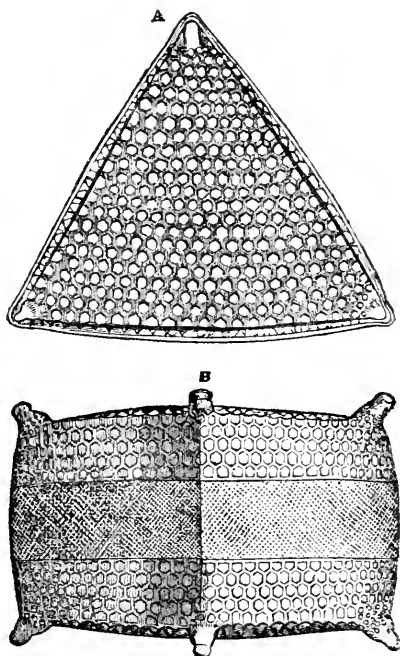

Triceratium farus.—A, side view ;
B, front view.

to the more delicate markings on the minuter Diatoms, and especially as to the nature of those on the valves of the various species of *Pleurosigma* and other forms used as Test-objects (§ 132),

* When specimens of Diatoms which exhibit this Areolation are examined by Welcker's test of Focal Adjustment (§ 127), it is found that if they are mounted in Canada Balsam, the Optical effects are reversed; the areolæ being made to look *bright* like elevations when the distance of the objective is increased, and *dark* when it is diminished. This, however, is readily explicable by the fact that the refractive power of the Balsam is greater than that of the Siliceous valve ; so that the predominant effect will be produced by the convexities formed in the medium by the concavities of the object. (See Schultze in "Quart. Journ. of Microsc. Science, Vol. iii. N.S., 1863, p. 131). It is maintained by Mr. Rylands "Quart. Journ. of Microsc. Science," Vol. viii. 1860, p. 27) that the

that an uncertainty still remains. These valves are commonly spoken of as marked by *striae*, longitudinal, transverse, or oblique, as the case may be ; but this term does not express the real nature of the markings (the apparent *lines* being resolvable by Objectives of sufficient magnifying power and angular aperture into *rows of dots*), and should only be used for the sake of concisely indicating the degree of their approximation. If we examine *Pleurosigma angulatum*, one of the easier tests, with an objective of 1-4th inch focus (having an angular aperture of 90° and a magnifying power of 500 diameters), we shall see very much what is represented in Fig. 120, E ; namely, a double series of somewhat interrupted lines, crossing each other at an angle of 60 degrees, so as to have between them imperfectly-defined lozenge-shaped spaces. When, however, the valve is examined with an objective of 1-12th inch focus, having an angular aperture of 170° and a magnifying power of 1200 diameters, the appearance of its surface is that represented in Fig. 90, namely, a hexagonal areolation somewhat resembling that of *Triceratium* (Fig. 119), in which the areolæ can be made to appear light, and the dividing network dark, or *vice versa*, according to the adjustment of the focus. Now the question is, whether the Areolæ are here *depressions* or *elevations* ; and on this point a great deal more has been said and written than its essential triviality would seem to justify. The fact is, however, that although to the Physiologist who studies the vital actions of the Diatoms it is a matter of comparatively little importance whether the surfaces of their valves are beset with rows of tubercles or are marked with rows of punctations, it is of essential importance to the Microscopist that he should certainly know how to interpret *any* such appearances ; and the difficulty here resulting from the extreme minuteness of the objects, and the peculiar optical effect produced by them (in virtue of their high refracting power) upon the light which passes through them, is such as very rightly stimulates him to devise every attainable means for its solution. Analogy would obviously favour the idea that the hexagonal areolation of *Pleurosigma* is of the same kind as that of *Triceratium*, and that the Areolæ are depressions in the former, as they certainly are in the latter ; and it has been affirmed that such a continuous gradation may be traced from the coarser to the finer kinds of areolation, as establishes the unity of their nature throughout.* There is now, however, a general agreement among those British Microscopists

honeycomb structure is completed in many instances, as in *Triceratium* and *Coscinodiscus*, by the closing-in of its cells or depressed areolæ with siliceous facets on their outer as well as on their inner side. The Author has not been able to satisfy himself, however, that such is the case ; and he prefers to leave the question to be resolved by such observers as specially occupy themselves with this group.

* See Dr. J. W. Griffith in the Introduction to the "Micrographic Dictionary," 2nd Ed., p. xxxiii, and in Articles 'Angular Aperture' and 'Diatomaceæ.'

who have most carefully studied this question with the most perfect instruments, in the belief that the areolæ are minute tubercular elevations, the intervening network being formed by the thinner portions of the valve.* This view, which is based on the optical in-

FIG. 120.

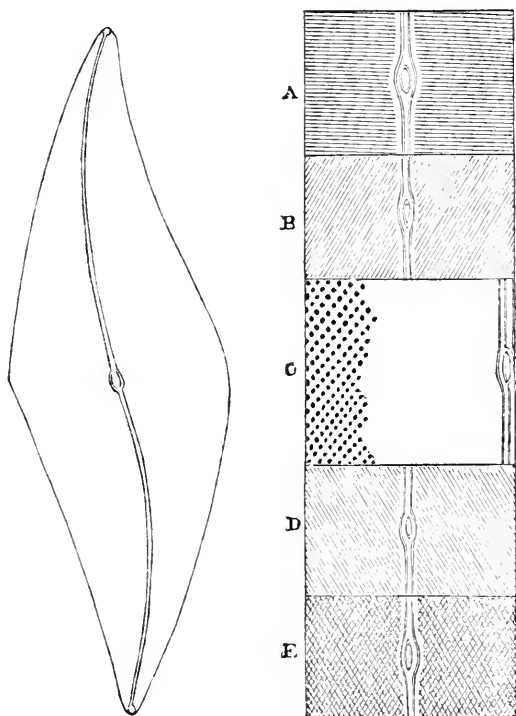

Outline of *Pleurosigma quadratum*, as seen under a power of 400 diameters :—at A, B, D, are shown the directions of the lines seen under a power of 1,300, the illuminating rays falling obliquely (in each case) in a direction at right angles to the lines; at E are shown two sets of lines as seen when the oblique rays fall in the direction of the midrib; and at C is shown the appearance of the markings when illuminated with an Achromatic Condenser of large angular aperture, the portion left blank showing the obliteration of the markings by moisture.

* See Dr. Wallich's Papers on this subject in "Quart. Journ. of Microsc. Science," Vol. vi. (1858), p. 247; "Annals of Nat. Hist.," Vol. v. Ser. 4 (Feb. 1860), p. 122; and "Trans. of Micr. Soc.," Vol. viii., N. S. (1860), p. 129. See also Norman in "Quart. Journ. of Microsc. Sci.," Vol. ii., N. S. (1862), p. 212.—Mr. Wenham, who at one time inclined to the belief that the areolæ are depressions, stated (when Dr. Wallich's

terpretation of the reversal of the lights and shades produced by alteration of focus, harmonizes also with the varieties of aspect produced by different modes of illumination (Fig. 120, A, B, C, D). And it derives additional confirmation from several incidental circumstances; such as from the fact that the lines of fracture, instead of traversing the areolæ, here follow the course of the intervening network; and that when specimens mounted beneath glass have had their markings obscured by moisture, the obscurity is dissipated by the application of a gentle heat, in a way that is readily explicable on the supposition that the markings are elevations, but is wholly unintelligible on the idea of their being depressions.* Moreover, that these minute markings are not to be interpreted by the analogy of the coarser network, is made obvious by the fact that they frequently co-exist in the same shells; thus, in certain species of *Triceratium*, *Coscinodiscus*, and *Actinocyclus*, the floors of the hexagonal depressions are studded with markings resembling those of a *Pleurosigma*; and these are particularly conspicuous in the beautiful *Heliopelta* (Plate I., fig. 3). There is reason to believe, indeed, that in these and other instances the two sets of markings belong to two distinct layers; the coarser areolation belonging to the *external*, whilst the fine granulation, which gives rise to the appearance that has caused Ehrenberg to describe several Diatoms as 'veiled,' belongs to the inner.†

217. The process of Multiplication by binary subdivision takes place among the *Diatomaceæ* on the same general plan as in the *Desmidiaceæ*, but with some modifications incident to the peculiarities of the structure of the former group.—The first stage con-

Paper was read before the Microscopical Society) as the result of observations made with an Objective of 1-50th inch focus and large aperture, that the valves are composed wholly of spherical particles of silex, possessing high refractive power; and he showed how all the various optical appearances presented by the different species could be reconciled with the supposition that their structure is universally the same. Mr. W. has succeeded in obtaining distinct impressions of the surface-markings by the Galvano-plastic process (See "Quart. Journ. of Microsc. Science," Vol. iii., 1855, p. 244).—The opinion of Prof. Max Schultze, however, by whom this subject has been very elaborately investigated, does not harmonize with the foregoing. He affirms that "neither spherical, conical, nor pyramidal elevations are the cause of the punctated appearance, although the decussating sets of ridges may at the points of intersection afford an appearance resembling that of tubercular elevations." And he considers that the sculpturing, both in the coarsely and in the finely marked Diatom-valves, though at first sight allied to what is seen on the surface of artificial siliceous pellicles, is in reality due to wholly different conditions. (See his Memoir "Die Structur der Diatomeenschale," and the Abstract of it in "Quart. Journ. of Microsc. Science," Vol. iii., N. S., 1863, p. 120.)

* See Mr. G. Hunt in "Quart. Journ. of Microsc. Sci." Vol. iii. (1855), p. 174.

† See Mr. C. Stodder (of Boston, U. S.), "On the Structure of the Valve of the *Diatomaceæ*," in "Quart. Journ. of Microsc. Science," Vol. iii., N. S. (1863), p. 214; also Ralfs, *Op. cit.*, Vol. vi. (1858), p. 214; and Rylands, *Op. cit.*, Vol. viii. (1860), p. 27.

sists in the elongation of the cell, and the increase in the breadth of the 'hoop,' which is well seen in Fig. 121, A; for in the newly formed cell *e*, the two valves are in immediate apposition, in *d* a hoop intervenes, in *a* this hoop has become much wider, and in *b* the increase has gone on until the original form of the cell is completely changed. At the same time, the endochrome separates into two halves, so that its granules form two layers applied to the opposite sides of the frustule; the nucleus also subdivides, in the

FIG. 121.

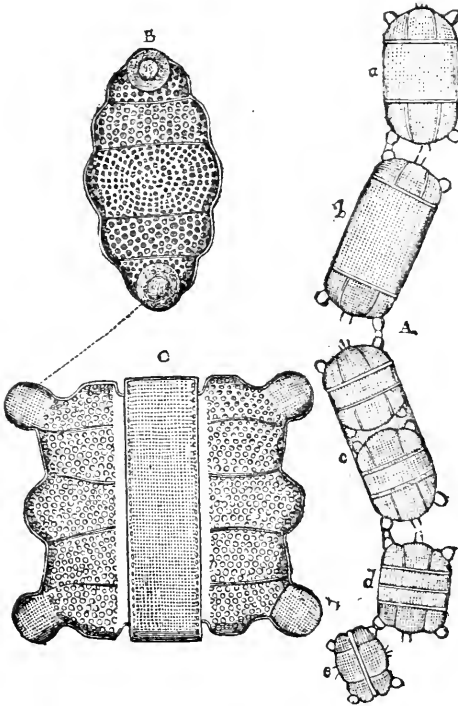

Biddulphia pulchella.:—A, chain of cells in different states: *a*, full size; *b*, elongating preparatory to subdivision; *c*, formation of two new cells; *d*, *e*, young cells;—B, end-view;—C, side-view of a cell more highly magnified.

manner formerly shown (Plate VIII., fig. 1, G, H, I); and (although the process has not been clearly made-out in this group) it may be pretty certainly concluded that the primordial utricle folds-in, first forming a mere constriction, then an hour-glass contraction, and finally a complete double partition, as in other instances (§ 249). From each of these two surfaces a new siliceous valve is formed, as

shown at Fig. 121, A, c, just as a new cellulose-wall is generated in the subdivision of other cells; and this valve is usually the exact counterpart of the one to which it is opposed, and forms with it a complete cell, so that the original frustule is replaced by two frustules. Sometimes, however, the new valves seem to be a little larger than their predecessors; so that, in the filamentous species, there may be an increase sufficient to occasion a gradual widening of the filament, although not perceptible when two contiguous frustules are compared; whilst, in the free forms, frustules of different sizes may be met-with, of which the larger are more numerous than the smaller, the increase in number having taken place in geometrical progression, whilst that of size was uniform. It is not always clear what becomes of the 'hoop.' In *Melosira* (Figs. 131, 132), and perhaps in the filamentous species generally, the 'hoops' appear to keep the new frustules united together for some time. This is at first the case also in *Biddulphia* and *Isthmia* (Fig. 134), in which the continued connection of the two frustules by its means gives rise to an appearance of two complete frustules having been developed within the original (Fig. 121, A, c); subsequently, however, the two new frustules slip out of the hoop, which then becomes completely detached; and the same thing happens with many other Diatoms, so that the 'hoops' are to be found in large numbers in the settlings of water in which these plants have long been growing. But in some other cases all trace of the hoop is lost; so that it may be questioned whether it has ever been properly silicified, and whether it does not become fused (as it were) into the gelatinous envelope.—During the healthy life of the Diatom, the process of self-division is continually being repeated; and a very rapid multiplication of frustules thus takes place, all of which (as in the cases already cited §§ 202, 210) must be considered to be repetitions of one and the same individual form. Hence it may happen that myriads of frustules may be found in one locality, uniformly distinguished by some peculiarity of form, size, or marking; which may yet have had the same remote origin as another collection of frustules found in some different locality, and alike distinguished by some peculiarity of its own. For there is strong reason to believe that such differences spring-up among the progeny of any true *generative* act (§ 219); and that when that progeny is dispersed by currents into different localities, each will continue to multiply its own special type so long as the process of self-division goes on.

218. It is uncertain whether the Diatomaceæ also multiply by the breaking-up of their endochrome into Gonidia, and by the liberation of these, either in the active condition of 'zoospores,' or in the state of 'still' or 'resting' spores. Certain observations by Focke,* however, taken in connection with the analogy of other

* "Physiologisch. Studien," Heft ii. 1853.

Protophytes, and with the fact that the Sporangial frustules undoubtedly thus multiply by gonidia (§ 219), seem to justify the conclusion that such a method of multiplication does obtain in this group. And it is not at all improbable that very considerable differences in the size, form, and markings of the frustules, such as many consider sufficient to establish a diversity of species, have their origin in this mode of propagation. It is probable that, so long as the vegetating processes are in full activity, multiplication takes-place in preference by self-division; and that it is when

FIG. 122.

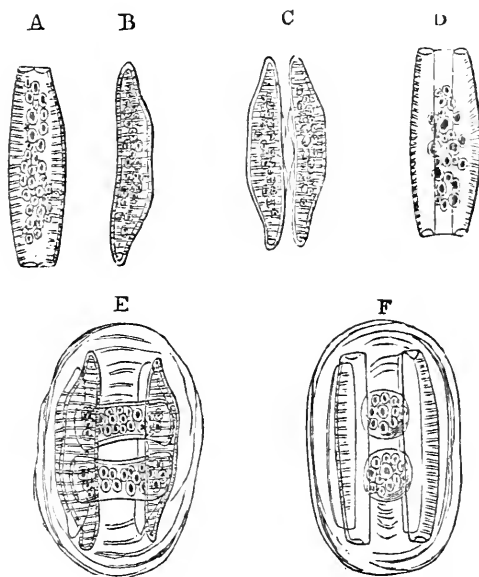

Conjugation of *Epithemia turgida*.—A, front view of single frustule; B, side view of the same; C, two frustules with their concave surfaces in close apposition; D, front view of one of the frustules, showing the separation of its valves along the suture; E, F, side and front views after the formation of the sporangia.

deficiency of warmth, of moisture, or of some other condition, gives a check to these, that the formation of encysted Gonidia, having a greater power of resisting unfavourable influences, will take-place; whereby the species is maintained in a dormant state until the external conditions favour a renewal of active vegetation (§ 192).

219. The process of *Conjugation* or true Generation has been observed to take-place among the ordinary Diatomaceæ, almost

exactly as among the Desmidiaceæ. Thus in *Surirella* (Fig. 129) the valves of two free and adjacent frustules separate from each other at the sutures, and the two endochromes (probably included in their primordial utricle) are discharged; these coalesce to form a single Sporangial mass, which becomes enclosed in a gelatinous envelope; and in due time this mass shapes itself into a frustule resembling that of its parent, but of larger size. In *Epithemia* (Fig. 122, A, B), however,—the first Diatom in which the conjugating process was observed by Mr. Thwaites,*—the endochrome of each of the conjugating frustules (c, d) appears to divide at the time of its discharge into two halves; each half coalesces with half of the other endochrome; and thus two Sporangial frustules (E, F) are formed (as in certain *Closteria*, § 206, note), which, as in the preceding case, become invested with a gelatinous envelope, and gradually assume the form and markings

FIG. 123.

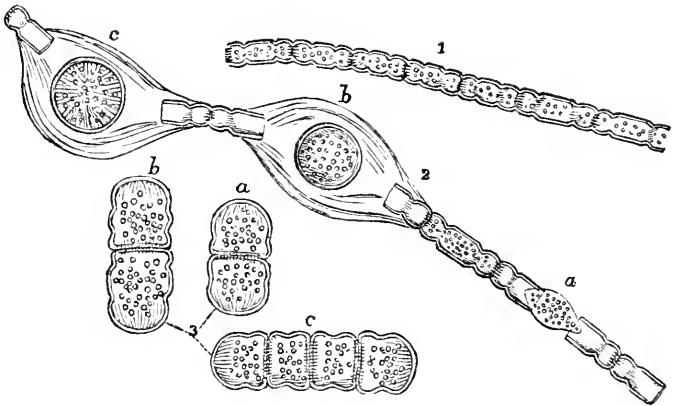

Self-Conjugation of *Melosira Italica* (*Aulacoseira crenulata*, Thwaites):—1, simple filament; 2, filament developing sporangia; a, b, c, successive stages in the formation of sporangia; 3, embryonic frustules, in successive stages, a, b, c, of multiplication.

of the parent-frustules, but grow to a very much larger size, the sporangial masses having obviously a power of self-increase up to the time when their envelopes are consolidated. This doubling of the Sporangial product of conjugation seems to be the ordinary type of the process among the Diatoms. A curious departure from the usual plan is observed in some of the filamentous species; for their component cells, instead of conjugating with those of

* See "Annals of Natural History," Ser. 1, Vol. xx. (1847), pp. 9, 343, and Ser. 2, Vol. i. (1848), p. 161.

another filament (as is the case with the filamentous *Desmidiaceæ*, § 206, and usually but not invariably with the *Zygnemaceæ*, § 251), conjugate with each other; and this may take-place even before they have been completely separated by self-division. Thus in *Melosira* (§ 227) and its allies, the endochrome of particular frustules, after separating as if for the formation of a pair of new cells, moves-back from the extremities towards the centre, rapidly increasing in quantity and aggregating into a Sporangial mass (Fig. 123, 2, *a, b, c*); and around this a new envelope is developed, which may or may not resemble that of the ordinary frustules, but which remains in continuity with them, giving rise to a strange inequality in the size of the different parts of the filaments (Figs. 131, 132).

220. Of the subsequent history of the Sporangial frustule, much remains to be learned; and it is probably not the same in all cases. It has been already shown that the sporangial frustule, even where it precisely resembles its parent in form and marking, greatly exceeds it in size; and this excess seems to render it improbable that it should reproduce the race by ordinary self-division. Appearances have been seen which make it probable that the contents of each sporangial frustule break-up into a brood of Gonidia, and that it is from these that the new generation originates. These gonidia, if each be surrounded (as in many other cases) by a distinct cyst, may remain undeveloped for a considerable period; and they must augment considerably in size, before they attain the dimensions of the parent frustule.—It is in this stage of the process that the modifying influence of external agencies is most likely to exert its effects; and it may be easily conceived that (as in higher Plants and Animals) this influence may give rise to various diversities among the respective individuals of the same brood; which diversities (as we have seen) will be transmitted to all the repetitions of each, that are produced by the self-dividing process. Hence a very considerable latitude is to be allowed to the limits of Species, when the different forms of Diatomaceæ are compared; and here, as in many other cases, a most important question arises as to what *are* those limits, —a question which can only be answered by such a careful study of the entire life-history of every single type, as may advantageously occupy the attention of many a Microscopist who is at present devoting himself to the mere detection of differences and to the multiplication of reputed species.*

221. Most of the Diatoms which are not fixed by a stipes possess some power of Spontaneous Movement; and this is especially seen in those whose frustules are of a long narrow form, such as that of

* See on this subject a valuable paper by Prof. W. Smith 'On the Determination of Species in the *Diatomaceæ*,' in the "Quart. Journ. of Microsc. Science," Vol. iii. (1855), p. 130; a Memoir by Prof. W. Gregory 'On shape of Outline as a specific character of *Diatomaceæ*,' in "Trans. of Microsc. Soc.," 2nd Series, Vol. iii. (1855), p. 10; and the Author's Presidential Address in the same volume, pp. 44-50.

the *Naviculae* generally. The motion is of a peculiar kind, being usually a series of jerks, which carry forward the frustule in the direction of its length, and then carry it back through nearly the same path. Sometimes, however, the motion is smooth and equable; and this is especially the case with the curious *Bacillaria paradoxa* (Fig. 125), whose frustules slide over each other in one direction until they are all-but detached, and then slide as far in the opposite direction, repeating this alternate movement at very regular intervals.* In either case, the motion is obviously quite of a different nature from that of beings possessed of a power of self-direction. "An obstacle in the path," says Prof. W. Smith, "is not avoided, but pushed-aside; or, if it be sufficient to avert the onward course of the frustule, the latter is detained for a time equal to that which it would have occupied in its forward progression, and then retires from the impediment as if it had accomplished its full course." The character of the movement is obviously similar to that of those motile forms of Protophyta which have been already described; but it has not yet been definitely traced to any organ of impulsion; and the cause of it is still obscure.† By Prof. W. Smith it is referred to forces operating within the frustule, and originating in the vital operations of growth, &c., which may cause the surrounding fluid to be drawn-in through one set of apertures, and expelled through the other.‡ "If," as he remarks, "the motion be produced by the exosmose taking-place alternately at one and the other extremity, while endosmose is proceeding at the other, an alternating movement would be the result in frustules of a linear form; whilst in others of an elliptical or orbicular outline, in which foramina exist along the entire line of suture, the movements, if any, must be irregular or slowly lateral. Such is precisely the case. The backward and forward movements of the *Naviculae* have been already described; in *Surirella* (Fig. 129) and *Campylodiscus* (Fig. 130), the motion never proceeds further than a languid roll

* This curious phenomenon the Author has himself repeatedly had the opportunity of witnessing.

† Prof. Smith says:—"Among the hundreds of species which I have examined in every stage of growth and phase of movement, aided by glasses which have never been surpassed for clearness and definition, I have never been able to detect any semblance of a motile organ; nor have I, by colouring the fluid with carmine or indigo, been able to detect in the coloured particles surrounding the Diatom, those rotatory movements, which indicate, in the various species of true Infusorial animalcules, the presence of cilia." ("Synopsis of British Diatomaceæ," Introduction, p. xxiv.)

‡ It has been objected to this view, by the authors of the "Micrographic Dictionary," that, if such were the case, the like movements would be frequently met with in other minute unicellular organisms. They seem to have forgotten, however, that there are no other such organisms in which the cell is almost entirely enclosed in an impermeable envelope, the imbibition and expulsion of fluid being thus limited to a small number of definite points, instead of being allowed to take place equally (as in other unicellular organisms) over the entire surface.

from one side to the other; and in *Gomphonema* (Fig. 139), in which a foramen fulfilling the nutritive office is found at the larger extremity only, the movement (which is only seen when the frustule is separated from its stipes) is a hardly perceptible advance in intermitted jerks in the direction of the narrow end."

222. The principles upon which this interesting group should be classified, cannot be properly determined, until the history of the Generative process—of which nothing whatever is yet known in a large proportion of Diatoms, and very little in any of them,—shall have been thoroughly followed-out. The observations of Focke* render it highly probable that many of the forms at present considered as distinct from each other, would prove to be but different states of the same, if their *whole* history were ascertained. On the other hand, it is by no means impossible that some which appear to be nearly related in the structure of their frustules and in their mode of growth, may prove to have quite different modes of reproduction. At present, therefore, *any* classification must be merely provisional; and in the notice now to be taken of some of the most interesting forms of the *Diatomaceæ*, the method of Prof. Kützing, which is based upon the characters of the individual frustules, is followed in preference to that of Prof. W. Smith, which was founded on the degree of connection remaining between the several frustules after self-division. †—In each Family the frustules may exist under four conditions; (a) free, the self-division being entire, so that the frustules separate as soon as the process has been completed; (b) stipitate, the frustules being implanted upon a common stem (Fig. 126), which keeps them in mutual connection after they have themselves undergone a complete self-division; (c) united in a filament, which will be continuous (Fig. 131) if the cohesion extend to the entire surfaces of the sides of the frustules, but may be a mere zig-zag chain (Fig. 127) if the cohesion be limited to their angles; (d) aggregated into a frond (Fig. 141), which consists of numerous frustules more or less regularly enclosed in a gelatinous investment. It is not in every Family, however, that these four conditions are at present known to exist; but they have been noticed in so many, that they may be fairly presumed to be capable

* According to this observer ("Ann. of Nat. Hist.," 2nd Ser., Vol. xv., 1855, p. 237) *Navicula bifrons* forms, by the spontaneous fission of its internal substance, spherical bodies which, like gemmules, give rise to *Surirella microcora*. These by conjugation produce *N. splendida*, which gives rise to *N. bifrons* by the same process. He is only able to speak positively, however, as to the production of *N. bifrons* from *N. splendida*; that of *Surirella microcora* from *N. bifrons*, and that of *N. splendida* from *Surirella microcora*, being matters of inference from the phenomena witnessed by him.

† The method of Kützing is the one followed, with some modification, by Mr. Ralfs in his revision of the group for "Pritchard's History of Infusoria," 4th Edition; and to his systematic arrangement the Author would refer such as desire more detailed information than the necessary limits of the present treatise permit him to give.

of occurring in all.—Excluding the family *Actiniscæ* (of whose siliceous skeletons we have an example in Fig. 144, c), which seem to have no adequate title to rank among Diatoms (their true alliance being apparently with the *Polycystina*), the entire group may be divided into two principal Sections; one (B) containing those forms in which the valves possess a true central nodule and median longitudinal line (as *Pleurosigma*, Fig. 120, and *Gomphonema*, Fig. 140, A), and the other (A) including all those in which the valves are destitute of a central nodule (as *Surirella*, Fig. 129, A). Among the latter, however, we find some (*b*) in which there is an umbilicus or pseudo-nodule with radiating lines or cellules, whilst there are others (*a*) which have no central marking whatever.

223. Commencing with the last-named division (A), the first

FIG. 124.

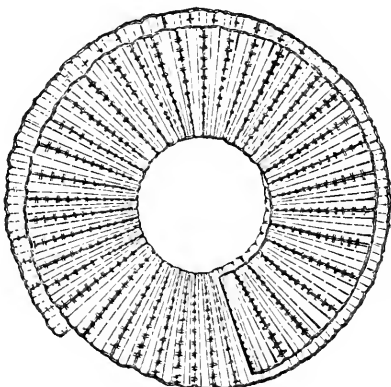
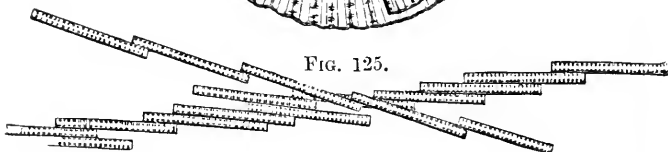

FIG. 125.

Fig. 124.—*Meridion circulare*.Fig. 125.—*Bacillaria paradoxa*.

Family is that of *Eunotiæ*, of which we have already seen a characteristic example in *Epithemia turgida* (Fig. 122). The essential characters of this family consist in the more or less lunate form of the frustules in the lateral view (Fig. 122, B), and in the striæ being continuous across the valves without any interruption by a longitudinal line.* In the Genus *Eunotia* the frustules are free;

* The genus *Epithemia* is specially distinguished by the presence of strongly-marked transverse lines, which were supposed by Prof. W. Smith to indicate canaliculi, but which are regarded by Mr. Ralfs (with greater probability) as internal ribs.

in *Epithemia* they are very commonly adherent by the flat or concave surface of the connecting zone; and in *Himantidium* they are usually united into ribbon-like filaments.—In the Family *Meridiæ* we find a similar union of the transversely-striated individual frustules; but these are narrower at one end than at the other, so as to have a cuneate or wedge-like form; and are regularly disposed with their corresponding extremities always pointing in the same direction, so that the filament is curved instead of straight, as in the beautiful *Meridion circulare* (Fig. 124). Although this plant, when gathered and placed under the micro-

FIG. 126.

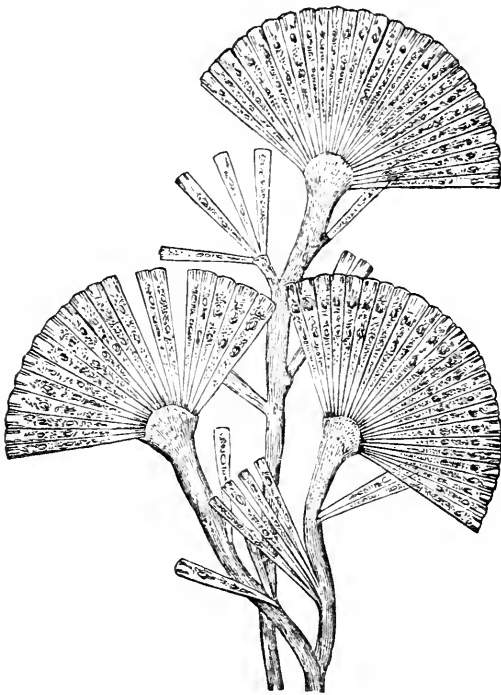
*Licmophora flabellata.*

scope, presents the appearance of circles overlying one another, it really grows in a helical (screw-like) form, making several continuous turns. This Diatom abounds in many localities in this country; but there is none in which it presents itself in such rich luxuriance as in the mountain-brooks about West Point in the United States, the bottoms of which, according to Prof. Bailey,

“are literally covered in the first warm days of spring with a ferruginous-coloured mucous matter, about a quarter of an inch thick, which, on examination by the microscope, proves to be filled with millions and millions of these exquisitely-beautiful siliceous bodies. Every submerged stone, twig, and spear of grass is enveloped by them; and the waving plume-like appearance of a filamentous body covered in this way is often very elegant.” The frustules of *Meridion* are attached when young to a gelatinous cushion; but this disappears with the advance of age.—In the family *Licmophoræ* also the frustules are wedge-shaped; in some genera

FIG. 127.

FIG. 128.

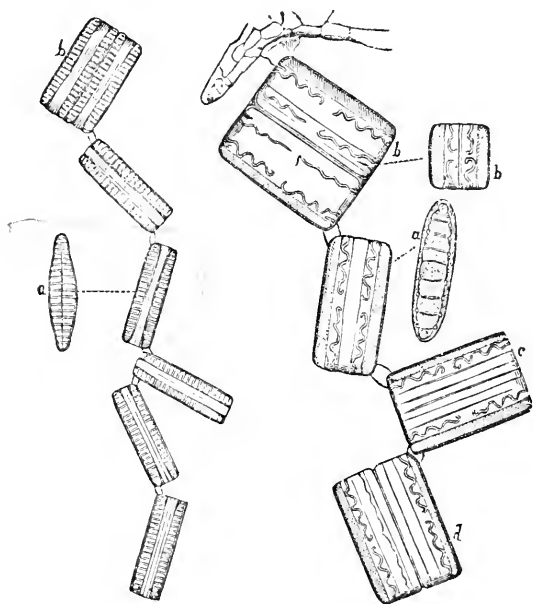

Fig. 127.—*Diatoma vulgare*:—*a*, side view of frustule; *b*, frustule undergoing self-division.

Fig. 128.—*Grammatophora serpentina*:—*a*, front and side views of single frustule; *b, b*, front and end views of divided frustule; *c*, a frustule about to undergo self-division; *d*, a frustule completely divided.

they have transverse markings, whilst in others these are deficient; but in most instances there are to be observed two longitudinal suture-like lines on each valve (which have received the special designation of *vittæ*) connecting the puncta at their two extremities.

The newly-formed part of the stipes in the Genus *Licmophora*, instead of itself becoming double with each act of self-division of the frustule, increases in breadth, while the frustules themselves remain coherent ; so that a beautiful fan-like arrangement is produced (Fig 126). A splitting away of a few frustules seems occasionally to take place, from one side or the other, before the elongation of the stipes ; so that the entire plant presents us with a more or less complete *flabella* or fan upon the summit of the branches, with imperfect flabellæ or single frustules irregularly scattered throughout the entire length of the footstalk. This beautiful plant is marine, and is parasitic upon Sea-weeds and Zoophytes.

224. In the next Family, that of *Fragillariæ*, the Frustules are of the same breadth at each end, so that if they unite into a filament they form a straight band. In some genera they are smooth, in others transversely striated, with a central nodule ; when striæ are present, they run across the valves without interruption. To this family belongs the Genus *Diatoma*, which gives its name to the entire group ; that name (which means cutting through) being suggested by the curious habit of the genus, in which the frustules after self-division separate from each other along their lines of junction, but remain connected at their angles, so as to form zig-zag chains (Fig. 127). The valves of *Diatoma*, when turned sideways (*a*), are seen to be strongly marked by transverse striæ, which extend into the front view. The proportion between the length and the breadth of each valve is found to vary so considerably, that, if the extreme forms only were compared, there would seem adequate ground for regarding them as belonging to different species. This genus inhabits fresh water, preferring gently-running streams, in which it is sometimes very abundant. The Genus *Fragillaria* is nearly allied to *Diatoma*, the difference between them consisting chiefly in the mode of adhesion of the frustules, which in *Fragillaria* form long straight filaments with parallel sides ; the filaments, however, as the name of the genus implies, very readily break-up into their component frustules, often separating at the slightest touch. Its various species are very common in pools and ditches. This family is connected with the next by the Genus *Nitzschia*, which is a somewhat aberrant form distinguished by the presence of a prominent keel on each valve, dividing it into two portions which are usually unequal, while the entire valve is sometimes curved, as in *N. sigmoidea*, which is sometimes used as a Test-object, but which is not suitable for that purpose on account of the extreme variability of its striation. Nearly allied to this is the genus *Bacillaria*, so named from the elongated staff-like form of its frustules ; its valves have a longitudinal punctated keel, and their transverse striæ are interrupted in the median line. The principal species of this genus is the *B. paradoxa*, whose remarkable movement has been

already described (§ 221). Owing to this displacement of the frustules, its filaments seldom present themselves with straight parallel sides, but nearly always in forms more or less oblique, such as those represented in Fig. 125. This curious object is an inhabitant of salt or of brackish water. Many of the species formerly ranked under this genus are now referred to the genus *Diatoma*. The Genera *Nitzschia* and *Bacillaria* are now associated by Mr. Ralfs,* with some other genera which agree with them in the bacillar or staff-like form of the frustules and in the presence of a longitudinal keel, in the Sub-family *Nitzschieæ*, which ranks as a section of the *Surirellææ*.—Another Sub-family, *Synedreææ*, consists of the genus *Synedra* and its allies, in which the bacillar form is retained (Fig. 145, *b*), but the keel is wanting, and the valves are but little broader than the front of the frustule.

FIG. 129.

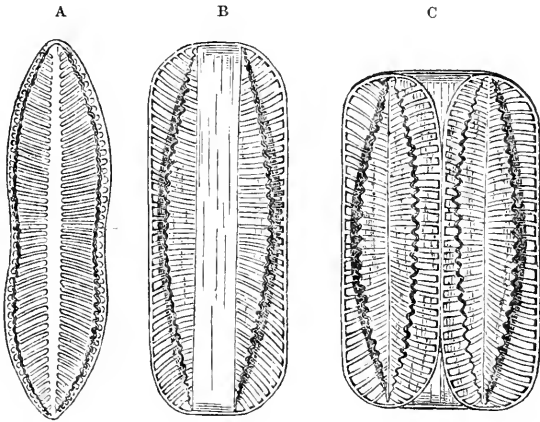

Surirella constricta:—A, side view; B, front view; C, binary subdivision.

225. In the *Surirellææ* proper, the frustules are no longer bacillar, and the breadth of the valves is usually (though not always) greater than the front view. The Genus *Surirella* (Fig. 129) is one of those in which the supposed 'canalicular system' of Prof. W. Smith is most strongly marked; it is not, however, by any means equally conspicuous in all the species. The distinctive character of this genus, in addition to the presence of the 'canaliculi,' is derived from the longitudinal line down the centre of each valve (A), and the prolongation of the margins into 'alæ.'

* See Pritchard's "Infusoria," 4th Ed. p. 940. The genus *Nitzschia* was in the first instance placed by Mr. Ralfs in the family *Fragillariææ*, and the genus *Bacillaria* in the family *Surirellæææ*.

Numerous species are known, which are mostly of a somewhat ovate form, some being broader and others narrower than *S. constricta*; the greater part of them are inhabitants of fresh or brackish water, though some few are marine; and several occur in those Infusorial earths which seem to have been deposited at the bottoms of lakes, such as that of the Mourne mountains in Ireland (Fig. 145, *b, c, k*).—In the Genus *Campylodiscus* (Fig. 130) the valves are so greatly increased in breadth as to present almost the form of disks (A), and at the same time have more or less of a peculiar twist or saddle-shaped curvature (B). It is in this genus

FIG. 130.

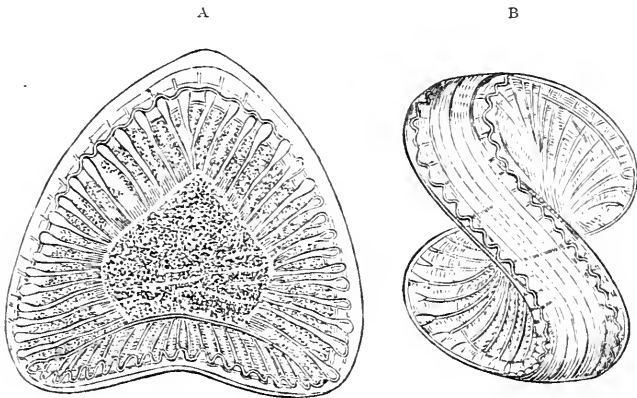

Campylodiscus costatus:—A, front view; B, side view.

that the supposed 'canaliculi' are most developed, and it is consequently here that they may be best studied; and of their being here really *costæ* or internally projecting ribs, no reasonable doubt can remain after examination of them under the Binocular microscope, especially with the Black-ground illumination. The form of the valves in most of the species is circular or nearly so; some are nearly flat, whilst in others the twist is greater than in the species here represented. Some of the species are marine, whilst others occur in fresh water; a very beautiful form, the *C. clypeus*, exists in such abundance in the Infusorial stratum discovered by Prof. Ehrenberg at Soos near Ezer in Bohemia, that the earth seems almost entirely composed of it.

226. The next Family, *Striatellæ*, forms a very distinct group, differentiated from every other by having longitudinal *costæ* on the connecting portions of the frustules; these *costæ* being formed by the inward projection of annular siliceous plates (which do not, however, reach to the centre), so as to form septa dividing the

cavity of the cell into imperfectly-separated chambers. In some instances these annular septa are only formed during the production of the valves in the act of self-division, and on each repetition of such production, and thus are always *definite* in number; whilst in other cases the formation of the septa is continued after the production of the valves, and is repeated an uncertain number of times before the recurrence of a new valve-production, so that the annuli are *indefinite* in number. In the curious *Grammatophora serpentina* (Fig. 128) the septa have several undulations and incurved ends so as to form serpentine curves, the number of which seems to vary with the length of the frustule. The lateral surfaces of the valves in *Grammatophora* are very finely striated; and some species, as *G. subtilissima* and *G. marina* are used as Test objects (§ 132). The frustules in most of the genera of this family separate into zig-zag chains, as in *Diatoma*; but in a few instances they cohere into a filament, and still more rarely they are furnished with a stipes.—The small Family *Terpsinöæ* is separated by Mr. Ralfs from the *Striatellæ* with which it is nearly allied in general characters, because its septa (which in the latter are longitudinal and divide the central portions into chambers) are transverse and are confined to the lateral portions of the frustules, which appear in the front view as in *Biddulphiæ* (§ 230). The typical form of this family is the *Terpsinö musica*, so named from the resemblance which the markings of its costæ bear to musical notes.

227. We next come to two Families in which the lateral surfaces of the Frustules are *circular*, so that according to the flatness or convexity of the valves and the breadth of the intervening hoop, the frustules may have the form either of thin disks, short cylinders, bi-convex lenses, oblate spheroids, or even of spheres. Looking at the structure of the individual frustules, the line of demarcation between these two families, *Melosireæ* and *Coscinodisceæ*, is by no means distinct; the principal difference between them being that the valves of the latter are commonly cellulated, whilst those of the former are smooth. Another important difference, however, lies in this, that the frustules of the *Coscinodisceæ* are always free, whilst those of the *Melosireæ* remain coherent into filaments, which often so strongly resemble those of the simple *Confervææ* as to be readily distinguishable only by the effect of heat. Of these last the most important Genus is *Melosira* (Figs. 131, 132), long since characterized as a Plant by the Swedish algologist Agardh, but ranked in the Animal kingdom with other Diatoms by Prof. Ehrenberg, who included it in his genus *Gallionella*. Some of its species are marine, others fresh-water; one of the latter, the *M. ochracea*, seems to grow best in boggy pools containing a ferruginous impregnation; and it is stated by Prof. Ehrenberg to take up from the water, and to incorporate with its own substance, a considerable quantity of iron. The filaments of *Melosira* very commonly fall-apart at the

slightest touch; and in the Infusorial earths, in which some species abound, the frustules are always found detached (Fig. 145, *a a*, *d d*). The meaning of the remarkable difference in the sizes and forms of the frustules of the same filaments (Figs. 131, 132) has not yet been fully ascertained; but it seems to be related to the curious process of self-conjugation already described (§ 219). The

FIG. 131.

*Melosira subtexilis.*

FIG. 132.

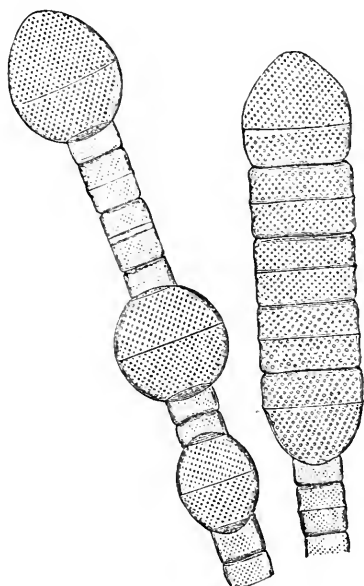
*Melosira varians.*

sides of the valves are often marked with radiating striæ (Fig. 145, *d d*); and in some species they have toothed or serrated margins, by which the frustules lock-together. To this family belongs the Genus *Hyalodiscus*, of which the *H. subtilis* was first brought into notice by the late Prof. Bailey as a Test-object, its disk being marked, like the engine-turned back of a watch, with lines of exceeding delicacy, only visible by the highest magnifying powers and the most careful illumination.

228. The Family *Coscinodisceæ* includes a large proportion of the most beautiful of those discoidal Diatoms, of which the valves do not present any considerable convexity, and are connected by a narrow zone. The Genus *Coscinodiscus*, which is easily distinguished from most of the genera of this family by not having its disk divided into compartments, is of great interest from the vast abundance of its valves in certain fossil deposits (Fig. 144, *a a*, *a*),

especially the Infusorial earth of Richmond in Virginia, of Bermuda, and of Oran, as also in Guano. Each frustule is of discoidal shape, being composed of two nearly flattened valves, united by a hoop; so that, if the frustules remained in adhesion, they would form a filament resembling that of *Melosira* (Fig. 131). The regularity of the hexagonal divisions on the valves renders them beautiful microscopic objects; in some species the areolæ are smallest near the centre, and gradually increase in size towards the margin; in others a few of the central areolæ are the largest, and the rest are of nearly uniform size; while in others, again, there are radiating lines formed by areolæ of a size different from the rest. Most of the species are either marine, or are inhabitants of brackish water; when living they are most commonly found adherent to Sea-weeds or Zoophytes; but when dead, the valves fall as a sediment to the bottom of the water. In both these conditions, they were found by Prof. J. Quekett in connection with Zoophytes which had been brought home from Melville Island by Sir E. Parry; and the species seemed to be identical with those of the Richmond earth. The Genus *Actinocyclus** closely resembles the preceding in form, but differs in the markings of its valvular disks, which are minutely and densely punctated or cellulated, and are divided radially by single or double dotted lines, which, however, are not continuous but interrupted (Plate I., fig. 1). The disks are generally iridescent; and, when mounted in balsam, they present various shades of brown, green, blue, purple, and red; blue or purple, however, being the most frequent. An immense number of Species have been erected by Prof. Ehrenberg on minute differences presented by the rays as to number and distribution; but since scarcely two specimens can be found in which there is a perfect identity as to these particulars, it is evident that such minute differences between organisms otherwise similar are not of sufficient account to serve for the separation of species. This form is very common in Guano from Ichaboe. Allied to the preceding are the two Genera *Asterolampra* and *Asteromphalus*, both of which have circular disks of which the marginal portion is minutely areolated, whilst the central area is smooth and perfectly hyaline in appearance, but is divided by lines into radial compartments which extend from the central umbilicus towards the periphery. The difference between them simply consists in this; that in *Asterolampra* all the compartments are similar and equidistant, and the rays equal (Plate I., fig. 2); whilst in *Asteromphalus* two of the compartments are closer together than the rest, and the enclosed hyaline ray (which is distinguished as the median or basal ray)

* The Author concurs with Mr. Ralfs in thinking it preferable to limit the genus *Actinocyclus* to the forms originally included in it by Ehrenberg, and to restore the genus *Actinoptychus* of Ehrenberg, which had been improperly united with *Actinocyclus* by Profs. Kützing and W. Smith.

differs in form from the others, and is sometimes specially continuous with the umbilicus (Plate I., fig. 4). The excentricity of the other rays which is thus produced has been made the basis of another Generic designation, *Spatangidium*; but it may be doubted whether this is founded on a valid distinction.* These beautiful disks are for the most part obtainable from Guano, and from Soundings in tropical and antarctic seas. From these we pass on to the Genus *Actinoptychus* (Fig. 133), of which also the frustules are discoidal in form, but of which each valve, instead of being flat, has an undulating surface, as is seen in front view (B); giving to the side view (A) the appearance of being marked by radiating bands. Owing to this peculiarity of shape, the whole surface cannot be brought into focus at once except with a low power; and the difference of aspect which the different radial divisions present in Fig. 133, is simply due to the fact that one set is out of focus whilst the other is in it, since the appearances are reversed by merely altering the focal adjustment. The number of radial divisions has been

FIG. 133.

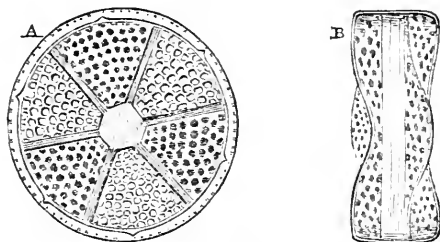

Actinoptychus undulatus;—A, side view; B, front view.

considered a character of sufficient importance to serve for the distinction of species; but this is probably subject to variation; since we not unfrequently meet with disks, of which one has (say) 8 and another 10 such divisions, but which are so precisely alike in every other particular that they can scarcely be accounted as specifically different. The valves of this genus also are very abundant in the Infusorial earth of Richmond, Bermuda, and Oran (Fig. 144, b, b, b); and many of the same species have been found recently in Guano, and in the seas of various parts of the world. The frustules in their living state appear to be generally attached to Sea-weeds or Zoophytes.

229. The Bermuda earth also contains the very beautiful form (Plate I., fig. 3), which, though scarcely separable from *Actinoptychus* except by its marginal spines, has received from Prof. Ehrenberg the distinctive appellation of *Heliopelta* (sun-shield). The object is represented as seen on its *internal* aspect by the

* See Greville in "Quart. Journ. of Microsc. Science," Vol. vii. (1859), p. 158, and in "Transact. of Microsc. Soc.," Vol. viii. N. S. (1860), p. 102, and Vol. x. (1862), p. 41; also Wallich in the same Transactions, Vol. viii. (1860), p. 44.

Parabolic Illuminator (§ 85), which brings into view certain features that can scarcely be seen by ordinary transmitted light. Five of the radial divisions are seen to be marked-out into circular areolæ ; but in the five which alternate with them, a minute granular structure is observable. This may be shown by careful adjustment of the focus to exist over the whole interior of the valve, even on the divisions in which the circular areolation is here displayed ; and it hence appears that this marking belongs to the internal layer* (§ 216), and that the circular areolation exists in the outer layer of the siliceous lorica. In the alternating divisions whose surface is here displayed, the areolation of the outer layer, when brought into view by focussing down to it, is seen to be formed by equilateral triangles ; it is not, however, nearly so well marked as the circular areolation of the first-mentioned divisions. The dark spots seen at the ends of the rays, like the dark centre, appear to be solid tubercles of silex not traversed by markings, as in many other Diatoms ; most assuredly they are *not* orifices, as supposed by Prof. Ehrenberg. Of this type, again, specimens are found presenting 6, 8, 10, or 12 radial divisions, but in other respects exactly similar ; on the other hand, two specimens agreeing in their number of divisions may exhibit minute differences of other kinds ; in fact, it is rare to find two that are *precisely* alike. It seems probable, then, that we must allow a considerable latitude of variation in these forms, before attempting to separate any of them as distinct species.—Another very beautiful discoidal Diatom, which occurs in Guano, and is also found attached to Sea-weeds from different parts of the world (especially to a species employed by the Japanese in making soup), is the *Arachnoidiscus* (Plate x.), so named from the resemblance which the beautiful markings on its disk cause it to bear to a spider's web. According to Mr. Shadbolt,† who has carefully examined its structure, each valve consists of two layers ; the outer one, a thin flexible horny membrane, indestructible by boiling nitric acid ; the inner one, siliceous. It is the former which has upon it the peculiar spider's web-like markings : whilst it is the latter that forms the supporting frame-work, which bears a very strong resemblance to that of a circular Gothic window. The two can occasionally be separated entire, by first boiling the disks for a considerable time in nitric acid, and then carefully washing them in distilled water. Even without such separation, however, the distinctness of the two layers can be made-out by focussing for each separately under a 1-4th or 1-5th inch objective ; or by looking at a valve as an opaque object (either by the Parabolic Illuminator, or by the

* It is stated by Mr. Stodder ("Quart. Journ. of Microsc. Science," Vol. iii., N.S., p. 215), that not only has he seen, in broken specimens, the inner granulated plate projecting beyond the outer, but that he has found the inner plate altogether separated from the outer. The Author is indebted to this gentleman for pointing out that his figure represents the *inner* surface of the valve.

† "Transact. of Microsc. Society," First Series, Vol. iii. p. 49.

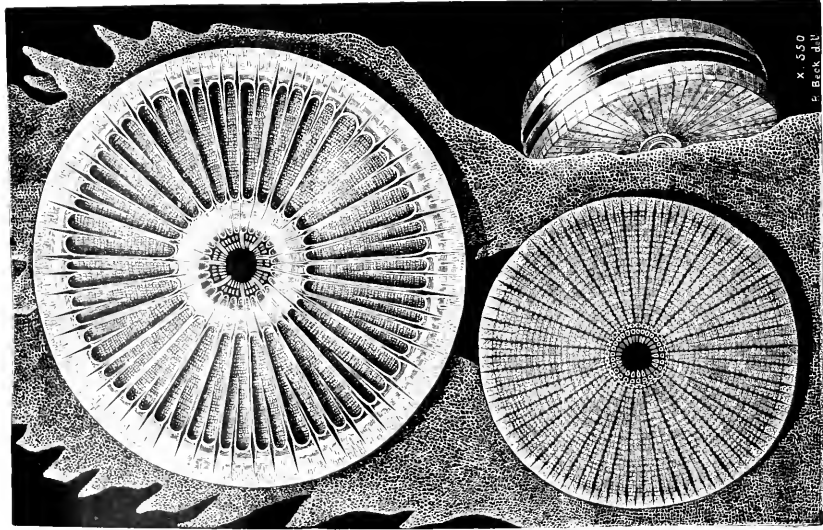

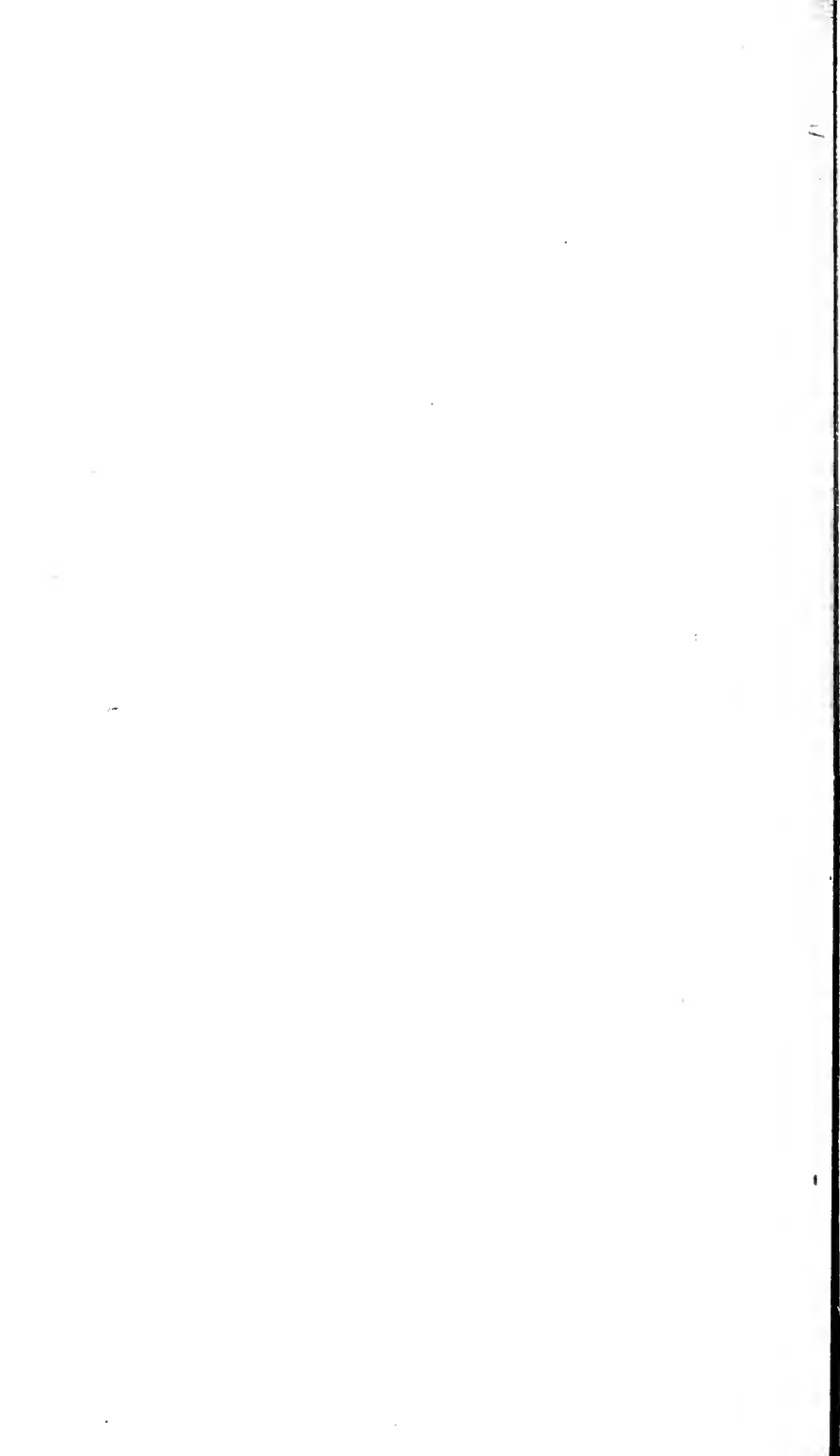

Lieberkühn, or by a side-light) with a 4-10ths inch objective, first from one side, and then from the other.*—This family is connected with the succeeding by the small group of *Eupodisceæ*, the members of which agree with the *Coscinodisceæ* in the general character of their discoid frustules, and with the *Biddulphiæ* in having tubercular processes on their lateral surfaces. In the beautiful Genus *Aulacodiscus* (Plate I., fig. 5) these tubercles are situated near the margin, and are connected with bands radiating from the centre; the surface also is frequently inflated in a manner that reminds us of *Actinoptychus*. These forms are for the most part obtained from Guano.

230. The members of the next Family *Biddulphiæ* differ greatly in their general form from the preceding; being remarkable for the great development of the lateral valves, which, instead of being nearly flat or discoidal, so as only to present a thin edge in front view, are so convex or inflated as always to enter largely into the front view, causing the central zone to appear like a band between them. This band is very narrow when the new frustules are first produced by self-division (§ 217); but it increases greatly in breadth until the new frustule is fully formed and is itself undergoing the same duplicative change. In *Biddulphia* (Fig. 121) the frustules have a quadrilateral form, and remain coherent by their alternate angles (which are elongated into tooth-like projections), so as to form a zig-zag chain. They are marked externally by ribbings which seem to be indicative of internal *costæ* partially subdividing the cavity. Nearly allied to this is the beautiful Genus *Isthmia* (Fig. 134), in which the frustules have a trapezoidal form owing to the oblique prolongation of the valves; the lower angle of each frustule is coherent to the middle of the one next beneath, and from the basal frustule proceeds a stipes by which the filament is attached. Like the preceding, this Genus is marine, and is found attached to

FIG. 134.

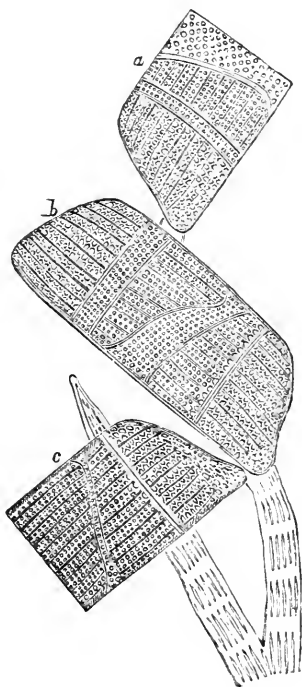
*Isthmia nervosa.*

* These valves afford admirable objects for showing the 'conversion of relief' in Nacet's Stereo-Pseudoscopic Microscope (§ 23).

the *Alge* of our own shores. The areolated structure of its surface is very conspicuous (Fig. 118) both in the valves and in the connecting 'hoop;' and this hoop, being silicified, not only connects the two new frustules (as at *b*, Fig. 134), until they have separated from each other, but, after such separation, remains for a time round one of the frustules, so as to give it a truncate appearance (*a*, *c*).

231. The Family *Angulifereæ*, distinguished by the angular form of its valves in their lateral aspect, is in many respects closely allied to the preceding; but in the comparative flattening of their valves its members more resemble the *Coscinodisceæ* and *Eupodisceæ*. Of this family we have a characteristic example in the Genus *Triceratium**; of which striking form a considerable number of species are met with in the Bermuda and other Infusorial earths, while others are inhabitants of the existing ocean and of tidal rivers. The *T. farus* (Fig. 119), which is one of the largest and most regularly-marked of any of these, occurs in the mud of the Thames and in various other estuaries on our own coast; it has been found, also, on the surface of large Sea-Shells from various parts of the world, such as those of *Hippopus* and *Haliotis*, before they have been cleaned; and it presents itself likewise in the Infusorial earth of Petersburg (U.S.). The projections at the angles which are shown in that species are prolonged in some other species into 'horns,' whilst in others, again, they are mere tubercular elevations. Although the *triangular* form of the frustule when looked at sideways is that which is characteristic of the genus, yet in some of the species there seems a tendency to produce *quadrangular* and even *pentagonal* forms; these being marked as *varieties* by their exact correspondence in sculpture, colour, &c., with the normal triangular forms.* This departure is extremely remarkable, since it breaks down what seems at first to be the most distinctive character of the genus; and its occurrence is an indication of the degree of latitude which we ought to allow in other cases. It is difficult, in fact, to distinguish the square forms of *Triceratium* from those included in the Genus *Amphitetras*, which is chiefly characterized by the cubiform shape of its frustules. In the latter the frustules cohere at their angles so as to form zig-zag filaments, whilst in the former the frustules are usually free, though they have occasionally been found catenated.—Another group that seems allied to the *Biddulphiæ* is the curious assemblage of forms brought together in the Family *Chatocereæ*, some of the filamentous types of which seem also allied to the *Melosireæ*. The peculiar distinction of this group consists in the presence of tubular 'awns,' frequently proceeding from the connecting hoop, sometimes spinous and serrated,

* See Mr. Brightwell's excellent memoirs 'On the genus *Triceratium*,' in "Quart. Journ. of Microsc. Science," Vol. i. (1853), p. 245, Vol. iv. (1856), p. 272, Vol. vi. (1858), p. 153; also Wallich in the same journal, Vol. vi. (1858), p. 242; and Greville in "Transact. of Microsc. Soc.," N.S., Vol. ix. (1861), pp. 43, 69.

and often of great length (Fig. 135), by the interlacing of which the frustules are united into filaments, whose continuity, however, is easily broken. In the Genus *Bacteriastrum* (Fig. 136) there are sometimes as many as twelve of these awns, radiating from each frustule like the spokes of a wheel, and in some instances regularly bifurcating. With this group is associated the Genus *Rhizolenia*, of which several species are distinguished by the extraordinary length of the frustule (which may be from 6 to 20 times its breadth), giving it the aspect of a filament (Fig. 137), by a transverse annulation that imparts to this filament a jointed appearance, and by the termination of the frustule at each end in a cone from the apex of which a straight awn proceeds. It is not a little remarkable that the greater number of the examples

FIG. 135.

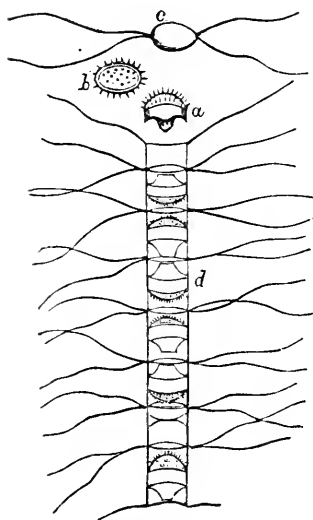
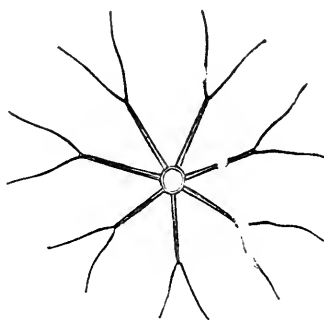

FIG. 136.

*Bacteriastrum furcatum.*

Chatoceros Wighamii.—*a*, front view, and *b*, side view of frustule; *c*, side view of connecting hoop and awns; *d*, entire filament.

of this curious family are obtained from the stomachs of Ascidians, Salpæ, Holothuriæ, and other Marine animals.*

232. The second principal division (B) of the Diatomaceæ consists, it will be remembered, of those in which the frustules have a median longitudinal line and a central nodule. In the first of the Families which it includes, that of *Cocconeidæ*, the central nodule is obscure or altogether wanting on one of the valves, which is dis-

* See Brightwell in "Quart. Journ. of Microsc. Science," Vol. iv. (1856), p. 105, Vol. vi. (1858), p. 93; Wallich in "Trans. of Microsc. Soc.," N.S., Vol. viii. (1860), p. 48; and West in the same, p. 151.

tinguished as the inferior. This family consists but of a single Genus *Cocconeis*, which includes, however, a great number of species, some or other of them occurring in every part of the globe.

FIG. 137.

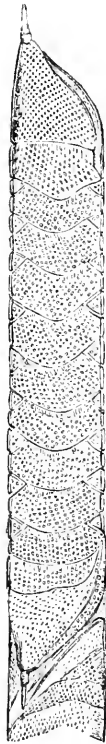

Rhizosolenia
imbricata.

FIG. 138.

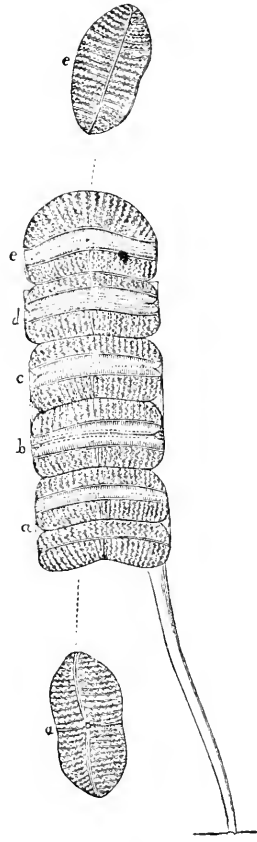

Achnanthes longipes: *a, b, c,*
d, e, successive frustules in dif-
ferent stages of self-division.

Their form is usually that of ellipsoidal disks, with surfaces more or less exactly parallel, plane, or slightly curved, and they are very commonly found adherent to each other. The frustules in this genus are frequently found invested by a membranous envelope which forms a border to them; but this seems to belong to the immature state, subsequently disappearing more or less com-

pletely. Another Family in which there is a dissimilarity in the two lateral surfaces, is that of *Achnantheæ*; the frustules of which are remarkable for the bend they show in the direction of their length, often more conspicuously than in the example here represented. This family contains free, adherent, and stipitate forms; one of the most common of the latter being the *Achnanthes*

FIG. 139.

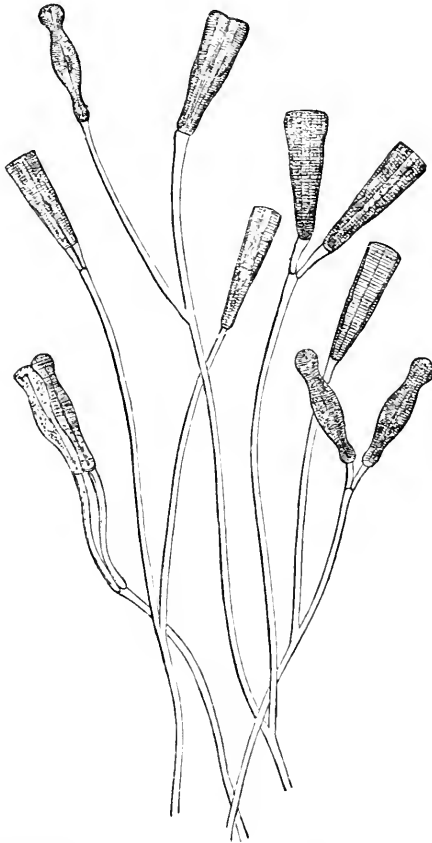

Gomphenema gemmatum : its frustules connected by a dichotomous stipes.

longipes (Fig. 138), which is often found growing on Marine Algæ. The difference between the markings of the upper and lower valves is here distinctly seen ; for while both are traversed by striæ, which are resolvable under a sufficient power into rows of dots, as well as by a longitudinal line, which sometimes has a nodule at each end

(as in *Navicula*), the lower valve (*a*) has also a transverse line, forming a *stauros* or cross, which is wanting in the upper valve (*e*). A persistence of the connecting membrane, so as to form an additional connection between the cells, may sometimes be observed in this genus; thus, in Fig. 138, it not only holds together the two new frustules resulting from the subdivision of the lowest cell, *a*, which are not yet completely separated the one from the other, but it may be observed to invest the two frustules *b* and *c*, which have not merely separated, but are themselves beginning to undergo binary subdivision; and it may also be perceived to invest the frustule *d*, from which the frustule *e*, being the terminal one, has more completely freed itself.—In the Family *Cymbelleæ*, on the other hand, both valves possess the longitudinal line with a nodule in the middle of its length; but the valves have the general form of those of the *Eunotiæ*, and the line is so much nearer one margin than the other, that the nodule is sometimes rather marginal than central, as we see in *Cocconema* (Fig. 145, *f*).—The *Gomphonemææ*, like the *Meridiææ* and *Licmophorææ*, have frustules which are cuneate or wedge-shaped in their front view (Figs. 139, 140), but are distinguished from those forms by the presence of

FIG. 140.

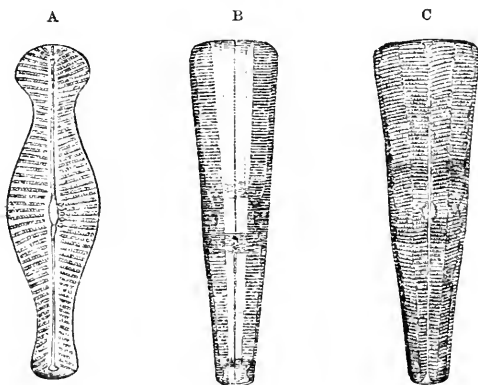

Gomphonema geminatum, more highly magnified:—A, side view of frustule; B, front view; C, frustule in the act of self-division.

the longitudinal line and central nodule. Although there are some free forms in this family, the greater part of them, included in the genus *Gomphonema*, have their frustules either affixed at their bases or attached to a stipes. This Stipes seems to be formed by an exudation from the frustule, which is secreted only during the process of self-division: hence when this process has been completed, the extension of the single filament below the frustule ceases; but when it recommences, a sort of joint or articulation is

formed, from which a new filament begins to sprout for each of the half-frustules; and when these separate, they carry apart the peduncles which support them, as far as their divergence can take place. It is in this manner that the dichotomous character is given to the entire stipes (Fig. 139). The species of *Gomphonema* are, with scarcely an exception, inhabitants of fresh water, and are among the commonest forms of Diatomaceæ.

233. Lastly, we come to the large family *Naviculeæ*, the members of which are distinguished by the symmetry of their frustules as well in the lateral as in the front view, and by the presence of a median longitudinal line and central nodule in both valves. In

FIG. 141.

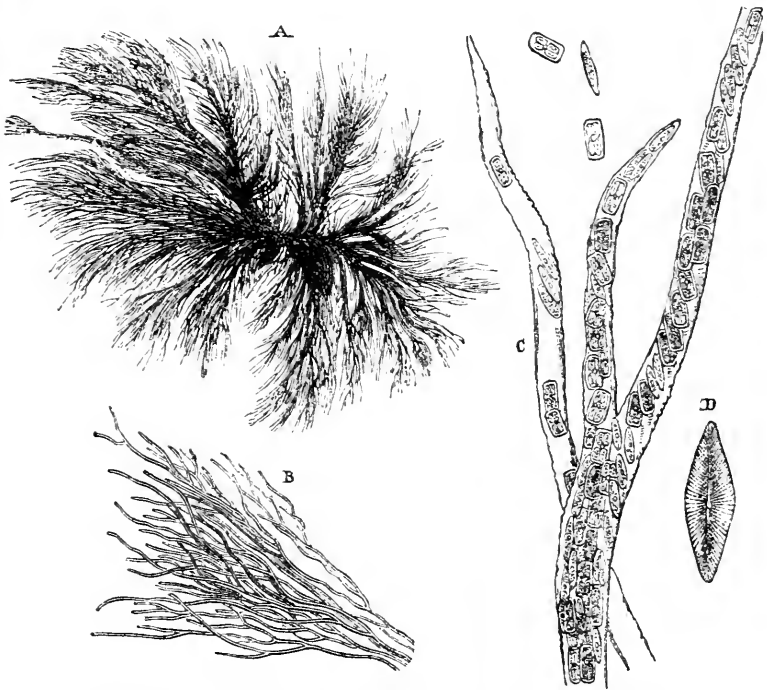

Schizonema Grevillii :—A, natural size ; B, portion magnified five diameters ; c, filament magnified 100 diameters ; D, single frustule.

the Genus *Navicula* and its allies, the frustules are free or simply adherent to each other; whilst in another large section they are included within a gelatinous envelope, or are enclosed in a definite tubular or gelatinous frond. Of the genus *Navicula* an immense number of species have been described, the grounds of separation

being often extremely trivial; those which have a lateral sigmoid curvature (Fig. 120) have been separated by Prof. W. Smith under the designation *Pleurosigma*, which is now generally adopted; but his separation of another set of species under the name *Pinnularia* (which had been previously applied by Ehrenberg to designate the striated species, those which seem to be smooth having been referred to *Navicula*), on the ground that its striæ are not resolvable into dots, and are so strongly marked (Fig. 145, *h*) as probably to indicate internal costæ like those of *Surirella* (Fig. 129), is not considered valid by Mr. Ralfs, on the ground that in many of the more minute species it is impossible to distinguish with certainty between striæ and costæ. The multitudinous species of the genus *Navicula* are for the most part inhabitants of Fresh water; and they constitute a large part of most of the so-called 'Infusorial Earths' which were deposited at the bottoms of lakes. Among the most remarkable of such deposits are the substances largely used in the arts for the polishing of metals, under the names of Tripoli and rotten-stone: these consist in great part of the frustules of *Naviculæ* and *Pinnulariæ*. The Polierschiefer, or polishing slate, of Bilin in Bohemia, the powder of which is largely used in Germany for the same purpose, and which also furnishes the fine sand used for the most delicate castings in iron, occurs in a series of beds averaging fourteen feet in thickness; and these present appearances which indicate that they have been at some time exposed to a high temperature. The well-known Turkey stone, so generally employed for the sharpening of edge-tools, seems to be essentially composed of a similar aggregation of frustules of *Naviculæ*, &c., which has been consolidated by heat. The species of *Pleurosigma*, on the other hand, are for the most part either Marine or are inhabitants of brackish water; and they comparatively seldom present themselves in a fossilized state. The genus *Stauroneis*, which belongs to the same group, differs from all the preceding forms in having the central nodule of each valve dilated laterally into a band free from striæ, which forms a cross with the longitudinal band: of this very beautiful form, some species are fresh-water, others marine; and the former present themselves frequently in certain Infusorial earths.*

234. Of the members of the sub-family *Schizonemæ*, consisting of those *Naviculæ* in which the frustules are united by a gelatinous envelope, some are remarkable for the great external resemblance they bear to acknowledged Algae. This is especially the case with the Genus *Schizonema*, of which the gelatinous envelope forms a regular tubular frond, more or less branched, and

* For some very curious examples of the extent to which variation in form, size, and distance in striæ, may take-place in this group, among individuals which must be accounted as of the same species, see the Memoirs of Profs. W. Smith and W. Gregory already referred to (p. 287, *note*).

of nearly equal diameter throughout, within which the frustules lie either in single file or without any definite arrangement (Fig. 141); all these frustules having arisen from the self-division of one individual. In the genus *Mastogloia*, which is specially distinguished by having the annulus furnished with internal costæ projecting into the cavity of the frustule, each frustule

FIG. 142.

FIG. 143.

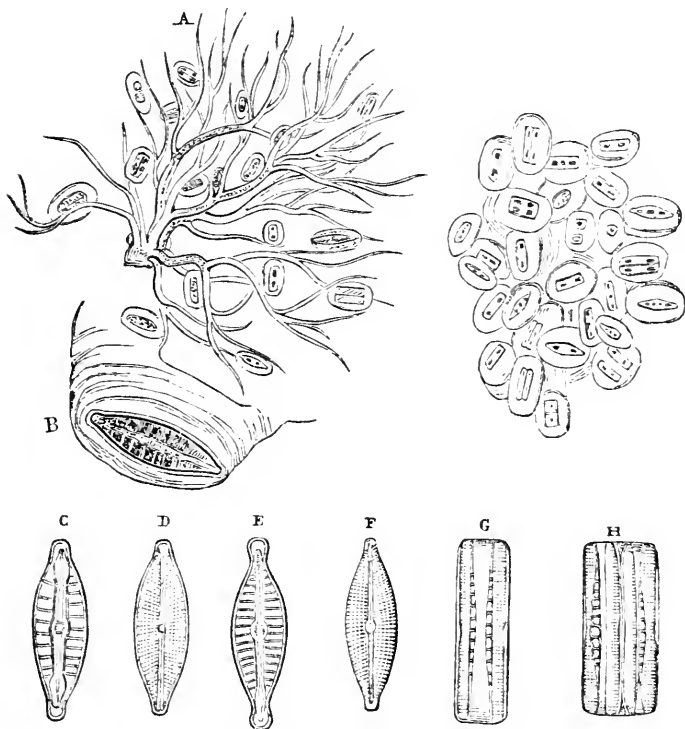

Fig. 142. *Mastogloia Smithii*:—A, entire stipes; B, frustule in its gelatinous envelope; C—F, different forms of frustule as seen in side view; G, front view; H, frustule undergoing subdivision.

Fig. 143. *Mastogloia lanceolata*.

separately supported on a gelatinous cushion (Fig. 142, B), which may itself be either borne on a branching stipes (A), or may be aggregated with others into an indefinite mass (Fig. 143). The careful study of these composite forms is a matter of great importance; since it enables us to bring into comparison with each other great numbers of frustules which have unquestionably a

common descent, and which must therefore be accounted as of the same Species; and thus to obtain an idea of the *range of variation* prevailing in this group, without a knowledge of which specific definition is altogether unsafe. Of the very strongly marked varieties which may occur within the limits of a single species, we have an example in the valves c, D, E, F (Fig. 142), which would scarcely have been supposed to belong to the same specific type, did they not occur upon the same stipes. 'The careful study of these varieties in every instance in which any disposition to variation shows itself, so as to *reduce* the enormous number of species with which our systematic treatises are loaded, is a pursuit of far greater real value than the *multiplication* of species by the detection of such minute differences as may be presented by forms discovered in newly-explored localities; such differences, as already pointed out, being, probably, in a large proportion of cases, the result of the multiplication of some one form, which, under modifying influences that we do not yet understand, has departed from the ordinary type. The more faithfully and comprehensively this study is carried out in *any* department of Natural History, the more does it prove that the range of variation is far more extensive than had been previously imagined; and this is especially likely to be the case with such humble organisms as those we have been considering, since they are obviously more influenced than are those of higher types by the conditions under which they are developed, whilst, from the very wide Geographical range through which the same forms are diffused, they are subject to very great diversities of such conditions.

235. The general habits of this most interesting group cannot be better stated than in the words of Prof. W. Smith. "The Diatomaceæ inhabit the Sea, or Fresh water; but the species peculiar to the one are never found in a living state in any other locality; though there are some which prefer a medium of a mixed nature, and are only to be met with in water more or less brackish. The latter are often found in great abundance and variety in districts occasionally subject to marine influences, such as marshes in the neighbourhood of the sea, or the deltas of rivers, where, on the occurrence of high tides, the freshness of the water is affected by percolation from the adjoining stream, or more directly by the occasional overflow of its banks. Other favourite habitats of the Diatomaceæ are stones of mountain streams or waterfalls, and the shallow pools left by the retiring tide at the mouths of our larger rivers. They are not, however, confined to the localities I have mentioned,—they are, in fact, most ubiquitous, and there is hardly a roadside ditch, water-trough, or cistern, which will not reward a search, and furnish specimens of the tribe." Such is their abundance in some Rivers and Estuaries, that their multiplication is affirmed by Prof. Ehrenberg to have exercised an important influence in blocking-up harbours and diminishing the depth of channels!

Of their extraordinary abundance in certain parts of the Ocean, the best evidence is afforded by the observations of Dr. J. D. Hooker upon the Diatomaceæ of the southern seas ; for within the Antarctic Circle they are rendered peculiarly conspicuous by becoming enclosed in the newly-formed ice, and by being washed-up in myriads by the sea on to the 'pack' and 'bergs,' everywhere staining the white ice and snow of a pale ochreous brown. A deposit of mud, chiefly consisting of the siliceous loriceæ of Diatomaceæ, not less than 400 miles long and 120 miles broad, was found at a depth of between 200 and 400 feet, on the flanks of Victoria Land in 70° South latitude. Of the thickness of this deposit no conjecture could be formed ; but that it must be continually increasing is evident, the silex of which it is in a great measure composed being indestructible. A fact of peculiar interest in connection with this deposit is its extension over the submarine flanks of Mount Erebus, an active Volcano of 12,400 feet elevation ; since a communication between the ocean-waters and the bowels of a volcano, such as there are other reasons for believing to be occasionally formed, would account for the presence of Diatomaceæ in volcanic ashes and pumice, which was discovered by Prof. Ehrenberg. It is remarked by Dr. Hooker, that the universal presence of this invisible vegetation throughout the South Polar Ocean is a most important feature, since there is a marked deficiency in this region of higher forms of vegetation ; and were it not for them, there would neither be food for aquatic Animals, nor (if it were possible for these to maintain themselves by preying on one another) could the ocean-waters be purified of the carbonic acid which animal respiration and decomposition would be continually imparting to it. It is interesting to observe that some species of Marine Diatomaceæ are found through every degree of latitude between Spitzbergen and Victoria Land, whilst others seem limited to particular regions. One of the most singular instances of the preservation of Diatomaceous forms is their existence in Guano ; into which they must have passed from the intestinal canals of the Birds of whose accumulated excrement that substance is composed, those birds having received them, it is probable, from Shell-fish, to which these minute organisms serve as ordinary food (§ 237.)

236. The indestructible nature of the Loriceæ of *Diatomaceæ* has also served to perpetuate their presence in numerous localities from which their living forms have long since disappeared ; for the accumulation of sediment formed by their successive production and death, either on the bed of the Ocean, or on the bottoms of Fresh-water Lakes, gives-rise to deposits which may attain considerable thickness, and which, by subsequent changes of level, may come to form part of the dry land. Thus very extensive Siliceous strata, consisting almost entirely of marine *Diatomaceæ*, are found to alternate, in the neighbourhood of the Mediterranean, with Calcareous strata chiefly formed of *Foraminifera* (Chap. x.) ; the

whole series being the representative of the Chalk formation of Northern Europe, in which the siliceous that was probably deposited at first in this form has undergone conversion into *flint*, by agencies hereafter to be considered (Chaps. x., xix.). Of the Diatomaceous composition of these strata we have a characteristic example in Fig. 144, which represents the Fossil Diatomaceæ of Oran in

Fig. 144.

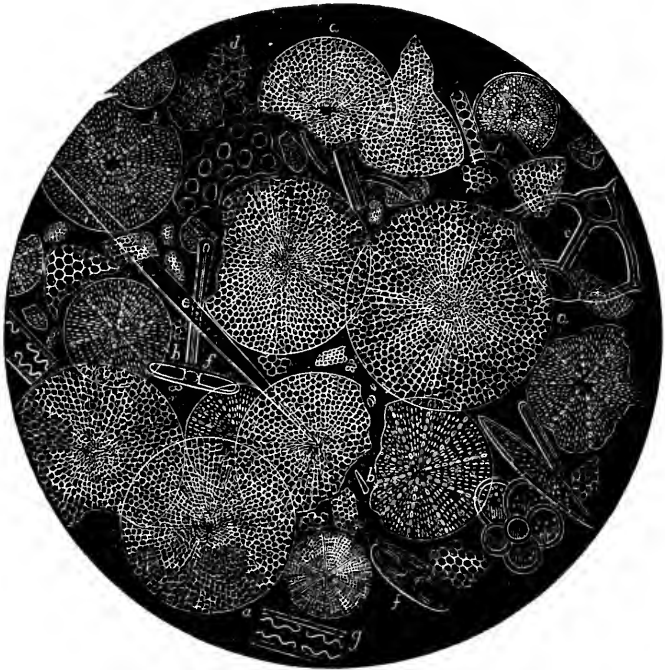

Fossil Diatomaceæ, &c., from Oran:—*a, a, a*, *Coscinodiscus*; *b, b, b*, *Actinocyclus*; *c*, *Dietyochya fibula*; *d*, *Lithasteriscus radiatus*; *e*, *Spongolithis acicularis*; *f, f*, *Grammatophora parallela* (side view); *g, g*, *Grammatophora angulosa* (front view).

Algeria. The so-called 'Infusorial Earth' of Richmond in Virginia, and that of Bermuda, also Marine deposits, are very celebrated among Microscopists for the number and beauty of the forms they have yielded; the former constitutes a stratum of 18 feet in thickness, underlying the whole city, and extending over an area whose limits are not known. Several deposits of more limited extent, and apparently of Fresh-water origin, have been found in our own silands; as for instance at Dolgelly in North Wales, at South

Mourne in Ireland (Fig. 145), and in the island of Mull in Scotland. Similar deposits in Sweden and Norway are known under the name of *berg-mehl* or mountain-flour; and in times of scarcity the inhabitants of those countries are accustomed to mix these substances with their dough in making bread. This has been

FIG. 145.

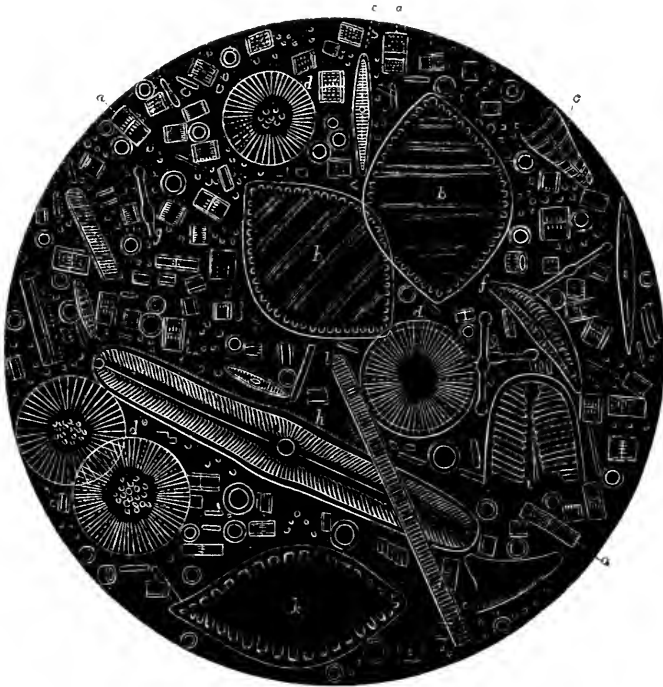

Fossil Diatomaceæ, &c., from Mourne mountain, Ireland:—a, a, a, Gaillonella (Melosira) procera, and G. granulata; d, d, d, G. biseriata (side view); b, b, Surirella plicata; c, S. craticula; k, S. caledonica; e, Gomphonema gracile; f, Cocconema fusidium; g, Tabellaria vulgaris; h, Pinnularia dactylus; i, P. nobilsi; l, Synedra ulna.

supposed merely to have the effect of giving increased bulk to their loaves, so as to render the really nutritive portion more satisfying; but as the *berg-mehl* has been found to lose from a quarter to a third of its weight by exposure to a red-heat, there seems a strong probability that it contains Organic matter enough to render it nutritious in itself. When thus occurring in strata of a fossil or sub-fossil character, the Diatomaceous deposits are generally

distinguishable as white or cream-coloured powders of extreme fineness.

237. For collecting fresh *Diatomaceæ*, those general methods are to be had recourse to which have been already described (§§ 176, 208). "Their living masses," says Prof. W. Smith, "present themselves as coloured fringes attached to larger plants, or forming a covering to stones or rocks in cushion-like tufts—or spread over their surface as delicate velvet—or depositing themselves as a filmy stratum on the mud, or intermixed with the scum of living or decayed vegetation floating on the surface of the water. Their colour is usually a yellowish-brown of a greater or less intensity, varying from a light chestnut, in individual specimens, to a shade almost approaching black in the aggregated masses. Their presence may often be detected without the aid of a microscope by the absence, in many species, of the fibrous tenacity which distinguishes other plants : when removed from their natural position they become distributed through the water, and are held in suspension by it, only subsiding after some little time has elapsed." Notwithstanding every care, the collected specimens are liable to be mixed with much foreign matter : this may be partly got rid of by repeated washings in pure water, and by taking advantage, at the same time, of the different specific gravities of the Diatoms and of the intermixed substances to secure their separation. Sand, being the heaviest, will subside first ; fine particles of mud, on the other hand, will float after the Diatoms have subsided. The tendency of the Diatomaceæ to make their way towards the light will afford much assistance in procuring the free forms in a tolerably clean state ; for if the gathering which contains them be left undisturbed for a sufficient length of time in a shallow vessel exposed to the sunlight, they may be skimmed from the surface. The Marine forms must be looked for upon Sea-weeds, and in the fine mud or sand of soundings or dredgings ; they are frequently found also, in considerable numbers, in the stomachs of *Holothuriæ*, *Ascidians*, and *Salpæ*, in those of the oyster, scallop, whelk, and other testaceous Mollusks, in those of the crab and lobster, and other Crustacea, and even in those of the sole, turbot, and other 'flat-fish.' In fact, the Diatom-collector will do well to examine the digestive cavity of *any* small aquatic animals that may fall in his way : rare and beautiful forms have been obtained from the interior of *Noctiluca* (Fig. 282). The separation of the Diatoms from the other contents of these stomachs must be accomplished by the same process as that by which they are obtained from Guano or the calcareous Infusorial Earths ; of this, the following are the most essential particulars. The guano or earth is first to be washed several times in pure water, which should be well stirred, and the sediment then allowed to subside for some hours before the water is poured off, since, if it be decanted too soon, it may carry the lighter forms away with it.

Some kinds of earth have so little impurity that one washing suffices ; but in any case it is to be continued so long as the water remains coloured. The deposit is then to be treated, in a flask or test-tube, with Hydrochloric (muriatic) acid ; and after the first effervescence is over, a gentle heat may be applied. As soon as the action has ceased, and time has been given for the sediment to subside, the acid should be poured off, and another portion added ; and this should be repeated as often as any effect is produced. When hydrochloric acid ceases to act, strong Nitric acid should be substituted ; and after the first effervescence is over, a continued heat of about 200° should be applied for some hours. When sufficient time has been given for subsidence, the acid may be poured off and the sediment treated with another portion ; and this is to be repeated until no further action takes place. The sediment is then to be washed until all trace of the acid is removed ; and, if there have been no admixture of siliceous sand in the earth or guano, this sediment will consist almost entirely of Diatomaceæ, with the addition, perhaps, of Sponge-spicules. The separation of siliceous sand, and the subdivision of the entire aggregate of Diatoms into the larger and the finer kinds, may be accomplished by stirring the sediment in a tall jar of water, and then, while it is still in motion, pouring off the supernatant fluid as soon as the coarser particles have subsided ; this fluid should be set aside, and, as soon as a finer sediment has subsided, it should again be poured off ; and this process may be repeated three or four times at increasing intervals, until no further sediment subsides after the lapse of half an hour. The first sediment will probably contain all the sandy particles, with, perhaps, some of the largest Diatoms, which may be picked out from among them ; and the subsequent sediments will consist almost exclusively of Diatoms, the sizes of which will be so graduated, that the earliest sediments may be examined with the lower powers, the next with the medium powers, while the latest will require the higher powers—a separation which is attended with great convenience.* It sometimes happens that fossilized Diatoms are so strongly united to each other by Siliceous cement, as not to be separable by ordinary methods ; in this case, small lumps of the deposit should be boiled for a short time in a weak Alkaline solution, which will act upon this cement more readily than on the siliceous frustules ; and as soon as they are softened so as to crumble to mud, this must be immediately washed in a large quantity of water, and then treated in the usual way. If a very weak alkaline solution does not answer the purpose, a stronger one may

* A somewhat more complicated method of applying the same principle is described by Mr. Okeden in the "Quart. Journ. of Microsc. Science," Vol. iii. (1855), p. 158. The Author believes, however, that the method above described will answer every purpose.

then be tried. This method, devised by Prof. Bailey, has been practised by him with much success in various cases.*

238. The mode of mounting specimens of Diatomaceæ will depend upon the purpose which they are intended to serve. If they can be obtained quite fresh, and it be desired that they should exhibit, as closely as possible, the appearance presented by the living plants, they should be put up in Distilled Water within Cement-cells (§ 166); but if they are not thus mounted within a short time after they have been gathered, about a sixth part of Alcohol should be added to the water. If it be desired to exhibit the stipitate forms in their natural parasitism upon other aquatic plants, the entire mass may be mounted in Deane's Medium (§ 163) or in Glycerine Jelly in a deeper cell; and such a preparation is a very beautiful object for the black-ground illumination. If, on the other hand, the minute structure of the siliceous envelopes is the feature to be brought into view, the fresh Diatoms must be boiled in nitric or hydrochloric acid, which must then be poured off (sufficient time being allowed for the deposit of the residue); and the sediment, after repeated washings, is to be either mounted in Balsam in the ordinary manner (§ 160), or, if the species have markings that are peculiarly difficult of resolution, is to be set up dry between two pieces of Thin-glass (§ 154). In order to obtain a satisfactory view of these markings, Objectives of very wide Angular aperture are required, and all the refinements which have recently been introduced into the Methods of Illumination need to be put in practice. (Chaps. III., IV.)—It will often be convenient to mount certain particular forms of Diatomaceæ separately from the general aggregate; but, on account of their minuteness, they cannot be selected and removed by the usual means. The larger forms, which may be readily distinguished under a simple Microscope, may be taken up by a camel-hair pencil which has been so trimmed as to leave two or three hairs projecting beyond the rest. But the smaller can only be dealt with by a single fine Bristle or stout Sable-hair, which may be inserted into the cleft-end of a slender wooden handle; and if the bristle or hair should be split at its extremity in a brush-like manner, it will be particularly useful. (Such split hairs may always be found in a Shaving-brush which has been for some time in use; those should be selected which have their split portions so closely in contact, that they appear single until touched at their ends.) When the split extremity of such a hair touches the glass slide, its parts separate from each other to an amount proportionate to the pressure; and, on being brought up to the object, first pushed to the edge of the fluid on the slide, may generally be made to seize it.—Supposing that we

* For other methods of cleaning and preparing Diatoms, see "Quart. Journ. of Microsc. Science," Vol. vii. (1859), p. 167, and Vol. i. N.S. (1861), p. 143; and "Trans. of Microsc. Soc.," Vol. xi. N.S. (1863), p. 4.

wish to select certain particular forms from a Diatomaceous sediment which has been obtained by the preceding processes, either of the two following modes may be put in practice. A small portion of the sediment being taken up in the Syringe or Dipping tube, and allowed to escape upon the slide, so as to form a long narrow line upon it, this is to be examined with the lowest power with which the object we are in search of can be distinguished (the Erector and Draw-Tube, §§ 63, 64, will here be very useful) ; and when one of the specimens has been found, it may be taken-up, if possible, on the point of the hair, and transferred to a new slide, to which it may be made to adhere by first breathing on the surface. But if it be found impracticable thus to remove the specimens, on account of their minuteness, they may be pushed on one side of the slide on which they are lying ; all the remainder of the sediment which it is not desired to preserve may be washed off ; and the objects may then be pushed back into the middle of the slide, and mounted in any way that may be desired.

239. *Palmellaceæ*.—To the family thus designated belong those two Genera which have been already cited as illustrations of the humblest types of Vegetation (§§ 185, 188) ; and the other forms which are associated with those are scarcely less simple in their essential characters, though sometimes attaining considerable dimensions. They all grow either on damp surfaces, or in fresh or salt water ; and they may either form (1) a mere powdery layer, of which the component particles have little or no adhesion to each other, or they may present themselves (2) in the condition of an indefinite slimy film, or (3) in that of a tolerably firm and definitely bounded membranous 'frond.' The *first* of these states we have seen to be characteristic of *Palmoglaea* and *Protococcus* ; the new cells, which are originated by the process of binary subdivision, usually separating from each other after a short time ; and even where they remain in cohesion, nothing like a frond or membranous expansion being formed. The 'Red Snow,' which sometimes colours extensive tracts in Arctic or Alpine regions, penetrating even to the depth of several feet, and vegetating actively at a temperature which reduces most plants to a state of torpor, is generally considered to be a species of *Protococcus* ; but as its cells are connected by a tolerably firm gelatinous investment, it would rather seem to be a *Palmella*. The *second* is the condition of the Genus *Palmella* ; of which one species, the *P. cruenta*, usually known under the name of 'Gory Dew,' is common on damp walls and in shady places, sometimes extending itself over a considerable area as a tough gelatinous mass, of the colour and general appearance of coagulated blood. A characteristic illustration of it is also afforded by the *Hæmatococcus sanguineus* (Fig. 146), which chiefly differs from *Palmella* in the partial persistence of the walls of the parent-cells, so that the whole mass is subdivided by partitions, which enclose a larger or smaller number of cells originating in the

subdivision of their contents. Besides increasing in the ordinary mode of binary multiplication, the *Palmella*-cells seem occasionally to rupture and diffuse their granular contents through the gelatinous stratum, and thus to give origin to a whole cluster at once, as seen at *e*, after the manner of other simple Plants to be presently described (§ 241), save that these minute segments of the endochrome, having no power of spontaneous motion, cannot be ranked as 'zoospores.' The gelatinous masses of the *Palmelleæ* are frequently found to contain parasitic growths formed by the extension of other plants through their substance ; but numerous

FIG. 146.

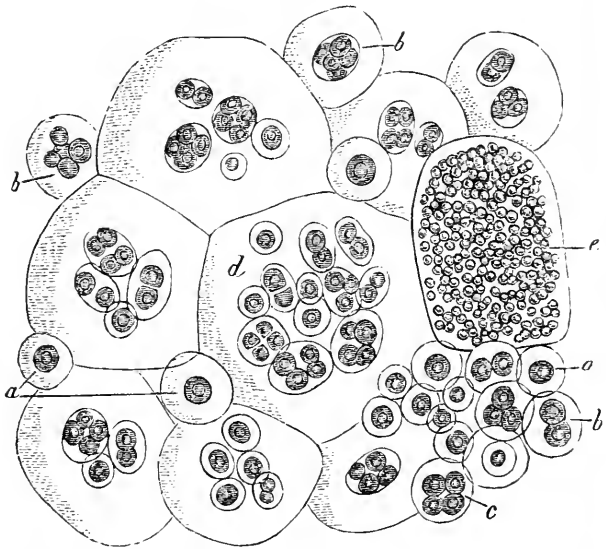

Hematococcus sanguineus, in various stages of development :—*a*, single cells, enclosed in their mucous envelope ; *b*, *c*, clusters formed by subdivision of parent-cell ; *d*, more numerous cluster, its component cells in various stages of division ; *e*, large mass of young cells, formed by the subdivision of the parent-endochrome, and enclosed within a common mucous envelope.

branched filaments sometimes present themselves, which, being traceable into absolute continuity with the cells, must be considered as properly appertaining to them. Sometimes these filaments radiate in various directions from a single central cell, and must at first be considered as mere extensions of this ; their extremities dilate, however, into new cells ; and when these are fully formed, the tubular connections close-up, and the cells become

detached from each other.* Of the *third* condition, we have an example in the curious *Palmodictyon* described by Kützing; the

frond of which appears to the naked eye like a delicate network consisting of anastomosing branches, each composed of a single or double row of large vesicles, within every one of which is produced a pair of elliptical cellules that ultimately escape as 'Zoospores.' The alternation between the 'motile' form and the 'still' or resting form, which has been described as occurring in *Protooccus* (§ 189), has been observed in several other forms of this group; and it seems obviously intended, like the production of 'Zoospores,' to secure the dispersion of the plant, and to prevent

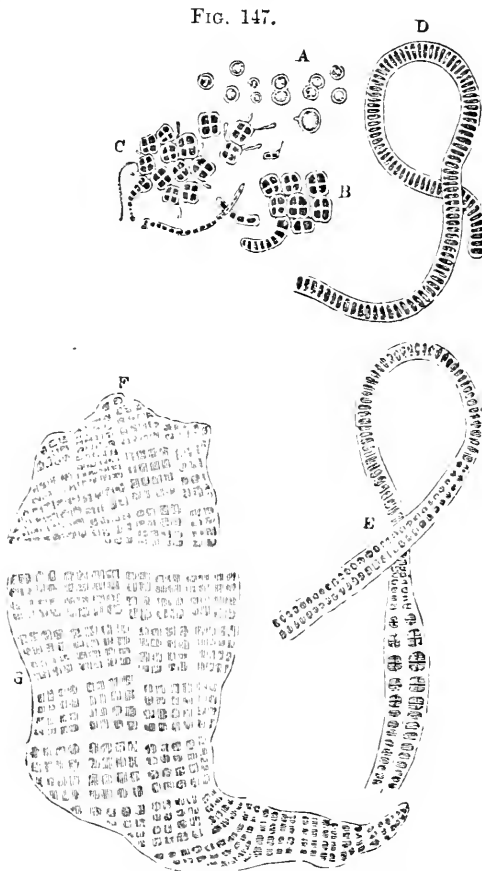

Successive stages of development of *Ulea*.

it from choking itself by overgrowth in any one locality. From the close resemblance which many reputed *Palmellaceæ* bear to the early stages of higher Plants (Fig. 147, A, B, c), considerable doubt has been felt by many Naturalists whether they ought to be regarded in the light of distinct and complete organisms, or whether they are anything else than embryonic forms of more elevated

* This fact, first made public by Mr. Thwaites ("Ann. of Nat. Hist.," 2nd Series, Vol. ii., 1848, p. 313), is one of fundamental importance in the determination of the real characters of this group.

types. On this question great light has been thrown by the recent observations of Dr. Hicks, who has shown it to be almost certain that a large proportion (to say the least) of these so-called Unicellular Algae are really the *gonidia* of Lichens.*

240. Notwithstanding the very definite form and large size attained by the fronds or leafy expansions of the *Ulvaceæ*, to which group belong the grass-green Sea-weeds (or 'Lavers') found on every coast, yet their essential structure differs but very little from that of the preceding group; and the principal advance is shown in this, that the cells, when multiplied by binary subdivision, not only remain in firm connection with each other, but possess a very regular arrangement (in virtue of the determinate plan on which the subdivision takes place), and form a definite membranous expansion. The mode in which this frond is produced may be best understood by studying the history of its development, some of the principal phases of which are seen in Fig. 147; for the isolated cells (A), in which it originates, resembling in all points those of a *Protococcus*, give rise, by their successive subdivisions in determinate directions, to such regular clusters as those seen at B and C, or to such Confervoid filaments as that shown at D. A continuation of the same regular mode of subdivision, taking place alternately in two directions, may at once extend the clusters B and C into leaf-like expansions; or, if the filamentous stage be passed through (different species presenting variations in the history of their development), the filament increases in breadth as well as in length (as seen at E), and finally becomes such a frond as is shown at F, G. In the simple membranous expansions thus formed, there is no approach to a 'differentiation' of parts by even the semblance of a formation of Root, Stem, and Leaf, such as the higher Algae present; every portion is the exact counterpart of every other; and every portion seems to take an equal share in the operations of growth and reproduction. Each cell is very commonly found to exhibit an imperfect partitioning into four parts, preparatory to multiplication by double subdivision; and the entire frond usually shows the groups of cells arranged in clusters containing some multiple of four.

241. Besides this continuous increase of the individual frond, however, we find in most species of *Ulva* a provision for extending the plant by the dispersion of 'Zoospores;' for the Endochrome (Fig. 148, a) subdivides into numerous segments (as at b and c), which at first are seen to lie in close contact within the cell that contains them, then begin to exhibit a kind of restless motion, and at last pass-forth through an aperture in the cell-wall, acquire four or more cilia (d), and swim freely through the water for some time. At last, however, they come to rest, attach themselves to some fixed

* See his admirable Memoirs in "Quart. Journ. of Microsc. Science," Vol. viii. (1860), p. 239, and Vol. i. N.S. (1861), pp. 15, 90, 157.

point, and begin to grow into clusters or filaments (*e*), in the manner already described. The walls of the cells which have thus discharged their Endochrome remain as colourless spots on the frond; sometimes these are intermingled with the portions still vegetating in the usual mode; but sometimes the whole Endochrome of one por-

FIG. 148.

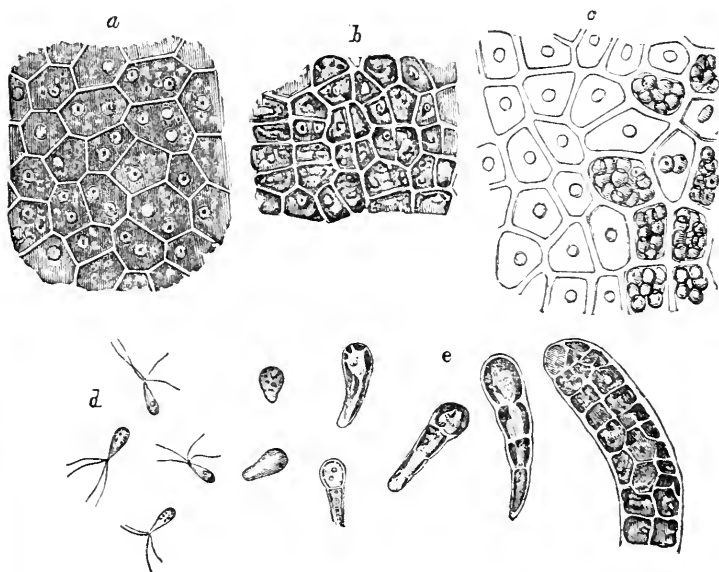

Formation of Zoospores in *Phycoseris gigantea* (*Ulva latissima*): —*a*, portion of the ordinary frond; *b*, cells in which the Endochrome is beginning to break up into segments; *c*, cells from the boundary between the coloured and colourless portion, some of them containing Zoospores, others being empty; *d*, ciliated zoospores, as in active motion; *e*, subsequent development of the zoospores.

tion of the frond may thus escape in the form of Zoospores, thus leaving behind it nothing but a white flaccid membrane. If the Microscopist who meets with a frond of an *Ulva* in this condition should examine the line of separation between its green and its coloured portion, he may not improbably meet with cells in the very act of discharging their Zoospores, which 'swarm' around their points of exit very much in the manner that Animalcules are often seen to do around particular spots of the field of view, and which might easily be taken for true Infusoria; but on carrying his observations further, he would see that similar bodies are moving *within* cells a little more remote from the dividing line, and

that, a little further still, they are obviously but masses of Endochrome in the act of subdivision.*

242. Of the true Generative process in the Ulvaceæ nothing whatever is known; and it is consequently altogether uncertain whether it takes-place by simple Conjugation, or according to that more truly Sexual method which will be presently described. Here, again, therefore, is an unsolved problem of the greatest Physiological interest, which probably requires nothing more for its solution than patient and intelligent study. And the Author would point out, that it is by no means unlikely that the Generative process may not be performed in the complete plant, but, as in the Ferns (§ 280), in the early product of the development of the Zoospore.—Although the typical *Ulvaceæ* are Marine, yet there are several Fresh-water species; and there are some which can even vegetate on damp surfaces, such as those of rocks or garden-walks kept moist by the percolation of water.

243. The *Oscillatoriaceæ* constitute another tribe of simple Plants of great interest to the Microscopist, on account both of the extreme simplicity of their structure, and of the peculiar Animal-like movements which they exhibit. They are continuous tubular filaments, formed by the elongation of their primordial cells, usually lying together in bundles or in strata, sometimes quite free, and sometimes invested by gelatinous sheaths. The Cellulose coat (Fig. 149, A, a, a) usually exhibits some degree of transverse striation, as if the tube were undergoing division into cells; but this division is never perfected by the formation of complete partitions, though the Endochrome shows a disposition to separate into regular segments (B, c), especially when treated with re-agents; and the filaments ultimately break up into distinct joints, the fragments of Endochrome, which are to be regarded as *gonidia*, usually escaping from their sheaths, and giving origin to new filaments.† These Plants are commonly of some shade of green, often mingled, however, with blue; but not unfrequently they are of a purplish hue, and are sometimes so dark as when in mass to seem nearly black. They occur not only in fresh, stagnant, brackish, and salt waters (certain species being peculiar to each), but also in mud, on wet stones, or on damp ground. Their very curious movements con-

* Such an observation the Author had the good fortune to make in the year 1842, when the emission of Zoospores from the Ulvaceæ, although it had been described by the Swedish Algologist Agardh, had not been seen (he believes) by any British naturalist.

† According to Dr. F. d'Alquen ('Quart. Journ. of Microsc. Science,' Vol. iv. p. 245), each filament—at least in certain species—has an axis of different composition from the surrounding endochrome; being solid, highly refractive, but slightly affected by iodine, and nearly colourless when moist, though slightly greenish when dry. And reasons are given by this observer for the belief that the peculiar motive power of the filament resides specially, if not exclusively, in this axis.

stitute the most remarkable feature in their history. These are described by Dr. Harvey* as of three kinds; first, a pendulum-like movement from side to side, performed by one end, whilst the other remains fixed so as to form a sort of pivot; second, a movement of flexure of the filament itself, the oscillating extremity bending over first from one side and then to the other, like the head of a worm or caterpillar seeking something on its line of march; and third, a simple onward movement of progression.

“The whole phenomenon,” continues Dr. H., “may perhaps be resolved into a spiral onward movement of the filament. If a piece of the stratum of an *Oscillatoria* be placed in a vessel of water, and allowed to remain there for some hours, its edge will first become fringed with filaments, radiating as from a central point, with their tips outwards. These filaments, by their constant oscillatory movements, are continually loosened from their hold on the stratum, cast into the water, and at the same time propelled forward; and as the oscillation continues after the filament has left its nest, the little swimmer gradually moves along, till it not only reaches the edge of the vessel, but often—as if in the attempt to escape confinement—continues its voyage up the sides, till it is stopped by dryness. Thus in a very short time a small piece of *Oscillatoria* will spread itself over a large vessel of water.” This rhythmical movement, impelling the filaments

in an undeviating onward course, is evidently of a nature altogether different from the truly spontaneous motions of Animals; and must be considered simply as the expression of certain vital changes taking place in the interior of the cells. It is greatly influenced by temperature and light, being much more active in warmth and sunshine than in cold and shade; and it is checked by any strong chemical agents.—The true Generation of *Oscillatoriaceæ* is as yet completely unknown; and it does not seem at all unlikely that these plants may (like the *Nostochaceæ*, § 244) be the ‘motile’ forms of some others, probably Lichens, which in their ‘stiiil’ condition present an aspect altogether different.

FIG. 149.

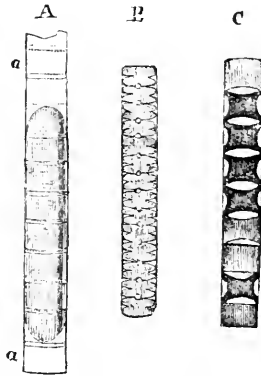

Structure of *Oscillatoria contexta*.—A, portion of a filament, showing the striations on the cellulose coat, a, a, where the endochrome is wanting; B, portion of filament treated with weak syrup, showing a disposition to a regular breaking-up of the endochrome into masses; C, portion of filament treated with strong solution of chloride of calcium, showing a more advanced stage of the same separation.

* “Manual of British Marine Algae,” p. 220.

244. Nearly allied to the preceding is the little tribe of *Nostochaceæ*; which consists of distinctly-beaded filaments, lying in firmly-gelatinous fronds of definite outline (Fig. 150). The filaments are usually simple, though sometimes branched; and are almost always curved or twisted, often taking a spiral direction. The masses of jelly in which they are imbedded are sometimes globular or nearly so, and sometimes extend in more or less regular branches:

FIG. 150.

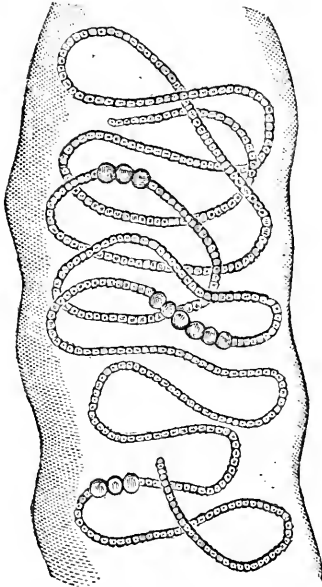

Portion of gelatinous frond of
Nostoc.

they frequently attain a very considerable size; and as they occasionally present themselves quite suddenly (especially in the latter part of autumn, on damp garden-walks), they have received the name of 'fallen stars.' They are not always so suddenly produced, however, as they appear to be; for they shrink up into mere films in dry weather, and expand again with the first shower. There is strong evidence that Nostocs are really the 'gonidia' of *Collema* and other Lichens, which, when set free from the plants which produced them, enter upon an entirely new phase of existence.* They then multiply themselves, like the *Oscillatoriaceæ*, by the subdivision of their filaments, the portions of which escape from the gelatinous mass wherein they were imbedded, and move slowly through the water in the direction of their length: after a time they cease to move, and a new gelatinous envelope is formed around each piece, which then begins

not only to increase in length by the transverse subdivision of its segments, but also to double itself by longitudinal fission, so that each filament splits lengthways (as it were) into two new ones. By the repetition of this process a mass of new filaments is produced, the parts of which are at first confused, but afterwards become more distinctly separated by the interposition of the gelatinous substance developed between them. Besides the ordinary cells of the beaded filaments, two other kinds are occasionally observable; namely, 'vesicular cells' of larger size than the rest (sometimes occurring at one end of the filaments, sometimes in the

* See Hicks in "Quart. Journ. of Microsc. Science," Vol. i., N.S. (1861), p. 90.

centre, and sometimes at intervals along their whole length), which are destitute of Endochrome, and are sometimes furnished with cilia; and 'sporangial cells,' which seem like enlarged forms of the ordinary cells, and which are usually found in the neighbourhood of the preceding. It has been supposed that the 'vesicular cells' are 'antheridia' or sperm-cells, producing 'antherozoids,' and that the 'sporangial cells' contain germs, which, when fertilized by the antherozoids, and set free, become 'resting-spores,' as in certain members of the family to be next noticed.

245. Although many of the plants belonging to the Family *Siphonaceæ* attain a considerable size, and resemble the higher Sea-weeds in their general mode of growth, yet they retain a simplicity of structure so extreme that it apparently requires them to be ranked among the Protophytes. They are inhabitants both of Fresh-water and of the Sea; and consist of very large tubular Cells, which commonly extend themselves into branches, so as to form an arborescent frond. These branches, however, are seldom separated from the stem by any intervening partition; but the whole frond is composed of a simple continuous tube, the entire contents of which may be readily pressed-out through an orifice made by wounding any part of the wall. The *Vaucheria*, named after the Genevese botanist by whom the Fresh-water Confervæ were first carefully studied, may be selected as a particularly good illustration of this family; its history having been pretty completely made out. Most of its species are inhabitants of Fresh water; but some are Marine; and they commonly present themselves in the form of cushion-like masses, composed of irregularly branching filaments, which, although they remain distinct, are densely tufted together and variously interwoven.—The formation of motile gonidia or 'Zoospores' may be readily observed in these plants, the whole process usually occupying but a very short time. The extremity of one of the filaments usually swells up in the form of a club, and the Endochrome accumulates in it so as to give it a darker hue than the rest; a separation of this part from the remainder of the filament, by the interposition of a transparent space, is next seen; a new envelope is then formed around the mass thus cut off; and at last the membranous wall of the investing tube gives way, and the Zoospore escapes, not, however, until it has undergone marked changes of form, and exhibited curious movements. Its motions continue for some time after its escape, and are then plainly seen to be due to the action of the cilia with which its whole surface is clothed. If it be placed in water in which some carmine or indigo has been rubbed, the coloured granules are seen to be driven in such a manner as to show that a powerful current is produced by their propulsive action, and a long track is left behind it. When it meets with an obstacle, the ciliary action not being arrested, the zoospore is flattened against the object; and it may thus be compressed, even

to the extent of causing its endochrome to be discharged. The cilia are best seen when their movements have been retarded or entirely arrested by means of opium, iodine, or other chemical re-agents. The motion of the spore continues for about two hours; but after the lapse of that time it soon comes to an end, and the spore begins to develop itself into a new plant. It has been observed by Unger, that the escape of the Zoospores generally takes place towards 8 A.M.; to watch this phenomenon, therefore, the plant should be gathered the day before, and its tufts examined early in the morning. It is stated by Dr. Hassall, that he has seen the same filament give off two or three zoospores successively: their emission is obviously to be regarded as a method of increase by gemmation, rather than as a generative act.

246. Recent discoveries have shown that there exists in this humble plant a true process of Sexual Generation, as was, indeed, long ago suspected by Vaucher, though upon no sufficient grounds. The branching filaments are often seen to bear at their sides peculiar globular or oval capsular protuberances, sometimes separated by the interposition of a stalk, which are filled with dark endochrome; and these have been observed to give exit to large bodies covered with a firm envelope, from which, after a time, new plants arise. In the immediate neighbourhood of these 'capsules' are always found certain other projections, which, from being usually pointed and somewhat curved, have been named 'horns' (Fig. 151, A, *a*); and these have been shown by Pringsheim to be 'Antheridia,' which, like those of the *Characeæ* (§ 255), produce Antherozoids in their interior; whilst the capsules (*A*, *b*) are 'Germ-cells,' whose aggregate mass of endochrome is destined to become, when fertilized, the primordial cell of a new generation. The antherozoids (*B*, *c*, *d*) when set free from the antheridium *a*, swarm over the exterior of the capsule *b*, and have actually been seen to penetrate its cavity through an aperture which opportunely forms in its wall, and to come into contact with the surface of its endochrome-mass, over which they diffuse themselves: there they seem to undergo dissolution, their contents mingling themselves with those of the germ-cell; and the endochrome-mass, which had previously no proper investment of its own, soon begins to form an envelope (*c*, *b*), which increases in thickness and strength, until it has acquired such a density as enables it to afford a firm protection to its contents. This body, possessing no power of spontaneous movement, is known as a 'resting-spore,' in contradistinction to the zoospores already described; or it may be termed an 'Oo-spore,' since it answers the purpose of a *seed* in laying the foundation for a new generation, whilst the Zoospores merely multiply the individual by a process analogous to *budding*.

247. The Microscopist who wishes to study the development of Zoospores, as well as several other phenomena of this low type of vegetation, may advantageously have recourse to the little plant

termed *Achlya proliferata*, which grows parasitically upon the bodies of dead Flies lying in the water, but also not unfrequently attaches itself to the gills of Fish, and is occasionally found on the bodies of Frogs. Its tufts are distinguishable by the naked eye as clusters of minute colourless filaments; and these are found, when examined by the microscope, to be long tubes devoid of all partitions, extending themselves in various directions. The tubes contain a colourless slightly-granular protoplasm, the particles of which are seen to move slowly in streams along the walls, as in *Chara*, the currents occasionally anastomosing with each other (Fig. 152, c). Within about thirty-six hours after the first appearance of the parasite on any body, the protoplasm begins to accumulate in the dilated ends of the filaments, each of which is cut off from the remainder by the formation of a partition; and within this dilated cell the movement of the protoplasm continues

FIG. 151.

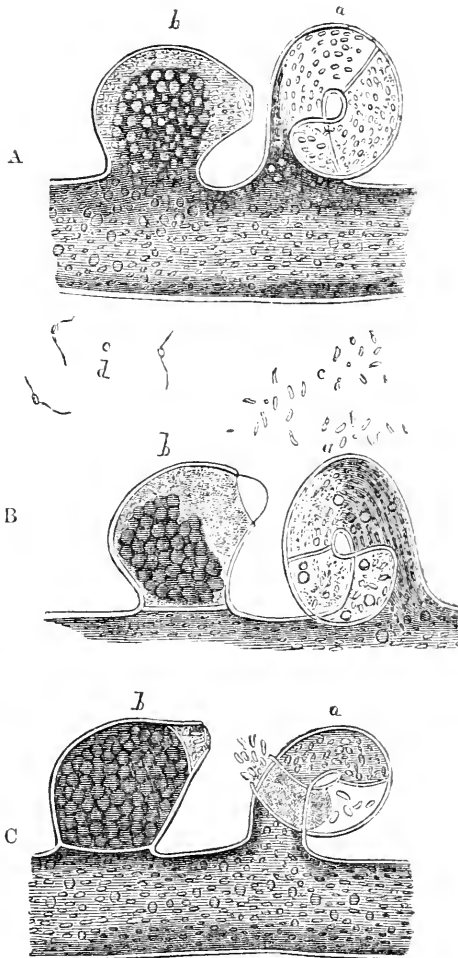

Successive phases of Generative process in *Faucheria sessilis*:—at A are seen one of the 'horns' or Antheridia (*a*) and one of the Capsules (*b*), as yet unopened; at B the antheridium is seen in the act of emitting the antherozoids (*c*), of which many enter the opening at the apex of the capsule, whilst others (*d*) which do not enter it, display their cilia when they become motionless; at C the orifice of the capsule is closed again by the formation of a proper coat around the endochrome-mass.

for a time to be distinguishable. Very speedily, however, its endochrome shows the appearance of being broken up into a large number of distinct masses, which are at first in close contact with each other and with the walls of the cell (Fig. 152, A), but which gradually become more isolated, each seeming to acquire a proper

FIG. 152.

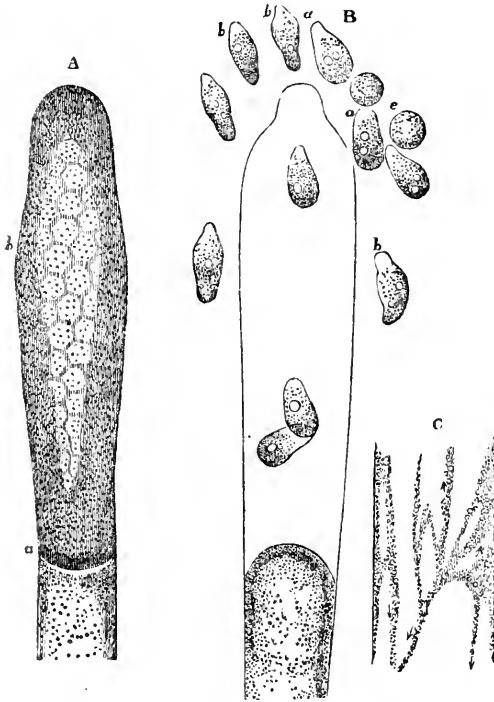

Development of *Achlya proliferata*:—A, dilated extremity of a filament *b*, separated from the rest by a partition *a*, and containing gonidia in progress of formation;—B, conceptacle discharging itself, and setting free gonidia, *a*, *b*, *c*;—C, portion of filament, showing the course of the circulation of granular protoplasm.

cell-wall; they then begin to move about within the parent-cell; and, when quite mature, they are set free by the rupture of its wall (B), to go forth and form new attachments, and to develop themselves into tubiform cells resembling those from which they sprang. Each of these 'motile gonidia' is possessed of only two cilia; their movements are not so powerful as those of the zoospores of *Vaucheria*; and they come to an end sooner. This

plant forms 'resting-spores' also, like those of *Vaucheria*; and there is every probability that they are generated by a like Sexual process. They may remain unchanged for a long time in water when no appropriate *nidus* exists for them; but will quickly germinate if a dead Insect or other suitable object be thrown in.

248. One of the most curious forms of this group is the *Hydrodictyon utriculatum*, which is found in fresh-water pools in the midland and southern counties of England. Its frond consists of a green open network of filaments, acquiring, when full-grown, a length of from four to six inches, and composed of a vast number of cylindrical tubular cells, which attain the length of four lines or more, and adhere to each other by their rounded extremities, the points of junction corresponding to the knots or intersections of the network. Each of these cells may form within itself an enormous multitude (from 7,000 to 20,000) of Gonidia; which, at a certain stage of their development, are observed in active motion in its interior; but of which groups are afterwards formed by their mutual adhesion, that are set-free by the dissolution of their envelopes, each group, or 'Macro-gonidium,' giving origin to a new plant-net. Besides these bodies, however, certain cells produce from 30,000 to 100,000 more minute bodies of longer shape, each furnished with four long cilia and a red spot, which are termed 'Micro-gonidia:' these escape from the cell in a swarm, move freely in the water for some time, and then come to rest and sink to the bottom, where they remain heaped in green masses. It appears from the more recent observations of Pringsheim ("Quart. Journ. of Microsc. Science," N. S., Vol. ii. 1862, p. 54), that they become surrounded with a firm cellulose envelope, and may remain in a dormant condition for a considerable length of time, like the 'statospores' of *Volvox* (§ 197); and that in this condition they are able to endure being completely dried-up without the loss of their vitality, provided that they are secluded from the action of Light, which causes them to wither and die. In this state they bear a strong resemblance to the cells of *Protococcus*. The first change that manifests itself in them is a simple enlargement; next the endochrome divides itself successively into distinct masses, usually from two to five in number; and these, when set free by the giving-way of the enveloping membrane, present the characters of ordinary Zoospores, each of them possessing one or two vibratile filaments at its anterior semi-transparent extremity. Their motile condition, however, does not last long, often giving place to the motionless stage before they have quite freed themselves from the parent-cell; they then project long angular processes, so as to assume the form of irregular polyhedra, at the same time augmenting in size; and the endochrome contained within each of these breaks-up into a multitude of Gonidia, which are at first quite independent and move actively within the cell-cavity, but soon unite into a network that becomes invested with a

gelatinous envelope, and speedily increases so much in size as to rupture the containing cell-wall, on escaping from which it presents all the essential characters of a young *Hydrodictyon*. Thus, whilst this plant multiplies itself by Macro-gonidia during the period of its most active vegetation, this method of multiplication by Micro-gonidia appears destined to secure its perpetuation under conditions that would be fatal to it in its perfect form. The rapidity of the growth of this curious organism is not one of the least remarkable parts of its history. The individual cells of which the net is composed, at the time of their emersion as Gonidia, measure no more than 1-2500th of an inch in length; but in the course of a few weeks, they grow to a length of from 1-12th to 1-3rd of an inch.—Nothing has been as yet ascertained respecting the Sexual Generation of this type; and the search for this is an object worthy of the pursuit of any Microscopist who may possess the requisite opportunities.

249. Almost every pond and ditch contains some members of the Family *Confervaceæ*; but they are especially abundant in moving water; and they constitute the greater part of those green threads which are to be seen attached to stones, with their free ends floating in the direction of the current, in every running stream, and upon almost every part of the Sea-shore, and which are commonly known under the name of 'silk-weeds' or 'crow-silk.' Their form is usually very regular, each thread being a long cylinder made-up by the union of a single file of short cylindrical cells united to each other by their flattened extremities: sometimes these threads give-off lateral branches, which have the same structure. The Endochrome, though usually green, is occasionally of a brown or purple hue; it is sometimes distributed uniformly throughout the cell (as in Fig. 153), whilst in other instances it is arranged in a pattern of some kind, as a network or a spiral; but this may be only a transitional stage in its development. The Plants of this order are extremely favourable subjects for the study of the method of Cell-multiplication by *binary subdivision*. This process usually takes-place only in the *terminal* cell; and it may be almost always observed there in some one of its stages. The first step is seen to be the subdivision of the Endochrome, and the inflexion of the Primordial Utricle around it (Fig. 153, A, a); and thus there is gradually formed a sort of hour-glass contraction across the cavity of the parent-cell, by which it is divided into two equal halves (B). The two surfaces of the infolded utricle produce a double layer of Cellulose-membrane between them; this is not confined, however, to the contiguous surfaces of the young cell, but extends over the whole exterior of the primordial utricle, so that the new septum becomes continuous with a new layer that is formed throughout the interior of the cellulose wall of the original cell (c). Sometimes, however, as in *Conferva glomerata* (a common species), new cells may originate as branches from any part of the

surface, by a process of budding; which, notwithstanding its difference of mode, agrees with that just described in its essential character, being the result of the subdivision of the original cell. A certain portion of the primordial utricle seems to undergo increased nutrition, for it is seen to project, carrying the cellulose envelope before it, so as to form a little protuberance; and this sometimes attains a considerable length, before any separation of its cavity from that of the cell which gave origin to it begins to take place. This separation is gradually effected, however, by the infolding of the primordial utricle, just as in the preceding case: and thus the endochrome of the branch-cell becomes completely severed from that of the stock. The branch then begins to elongate itself by the subdivision of its first-formed cell; and this process may be repeated for a time in all the cells of the filament, though it usually comes to be restricted at last to the terminal cell. The *Conferraceæ* multiply themselves by Zoospores, which are produced within their cells, and are then set-free, just as in the *Ulvaceæ* (§ 241); in most of the genera the Endochrome of

each cell divides into numerous zoospores, which are of course very minute; but in *Edogonium*—a fresh-water genus distinguished by the circular markings which form rings round the extremities of many of the cells, and by many interesting peculiarities of growth and reproduction*—only a single large zoospore is set free from each cell; and its liberation is accomplished by the almost complete fission of the wall of the cell through one of these rings, a small part only remaining unleft, which serves as a kind of hinge

FIG. 153.

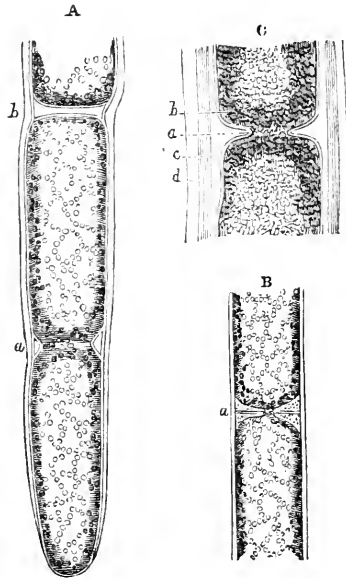

Process of cell-multiplication in *Conferva glomerata*:—A, portion of filament with incomplete separation at *a*, and complete partition at *b*; B, the separation completed, a new cellulose partition being formed at *a*; C, formation of additional layers of cellulose wall *c*, beneath the mucous investment *d*, and around the primordial utricle *a*, which encloses the endochrome *b*.

* See the account of these processes in the "Micrographic Dictionary," 2nd Edit. p. 501.

whereby the two parts of the filament are prevented from being altogether separated. Sometimes the zoospore does not completely extricate itself from the parent-cell; and it may begin to grow in this situation, the root-like processes which it puts-forth being extended into the cavity.

250. A true Sexual Generation has been observed in several Confervaceæ, and is probably universal throughout the group. It is presented under a very interesting form in a plant termed *Spheroplea annulina*, the development and generation of which have been specially studied by Dr. F. Cohn.* The 'Oo-spore,' which is the produce of the sexual process to be presently described, is filled when mature with a red oil, and is enveloped by two membranes, of which the outer one is furnished with stellate prolongations (Plate XI. fig. 1). When it begins to vegetate, its Endochrome breaks up—first into two halves (fig. 2), and then by successive subdivisions into numerous segments (figs. 3, 4), at the same time becoming green towards its margin. These segments, set-free by the rupture of their containing envelope, escape as Micro-gonidia, which are at first rounded or oval, each having a semi-transparent beak from which proceed two vibratile filaments, but which gradually elongate so as to become fusiform (fig. 5), at the same time changing their colour from red to green. These move actively for a time like the Zoospores of other Protophytes, and then, losing their motile power, begin to develop themselves into filaments. The first stage in this development consists in the elongation of the cell, and the separation of the endochrome of its two halves by the interposition of a vacuole (fig. 6); and in more advanced stages (figs. 7, 8) a repetition of the like interposition gives to the endochrome that annular arrangement from which the plant derives its specific name. This is seen at *a*, fig. 9, as it presents itself in the filaments of the adult plant; whilst at *b*, in the same figure, we see a sort of frothy appearance which the endochrome comes to possess through the multiplication of the vacuoles. The next stage in the development of the filaments that are to produce the Spores, consists in the aggregation of the Endochrome into definite masses (as seen at fig. 10, *a*), which soon become star-shaped (as seen at *b*), each one being contained within a distinct compartment of the cell. In a somewhat more advanced stage (fig. 11, *a*) the masses of endochrome begin to draw themselves together again; and they soon assume a globular or ovoidal shape (*b*), whilst at the same time definite openings (*c*) are formed in their containing cell-wall. Through these openings the Anterozoids developed within other filaments gain admission, as shown at *d*, fig. 12; and they seem to dissolve away (as it were) upon the surface of the before-mentioned masses, which soon afterwards become invested with a firm membranous envelope, as shown in

* "Ann. des Sci. Nat." 4ième Sér., Botan., Tom. v. p. 187.

PLATE XI.

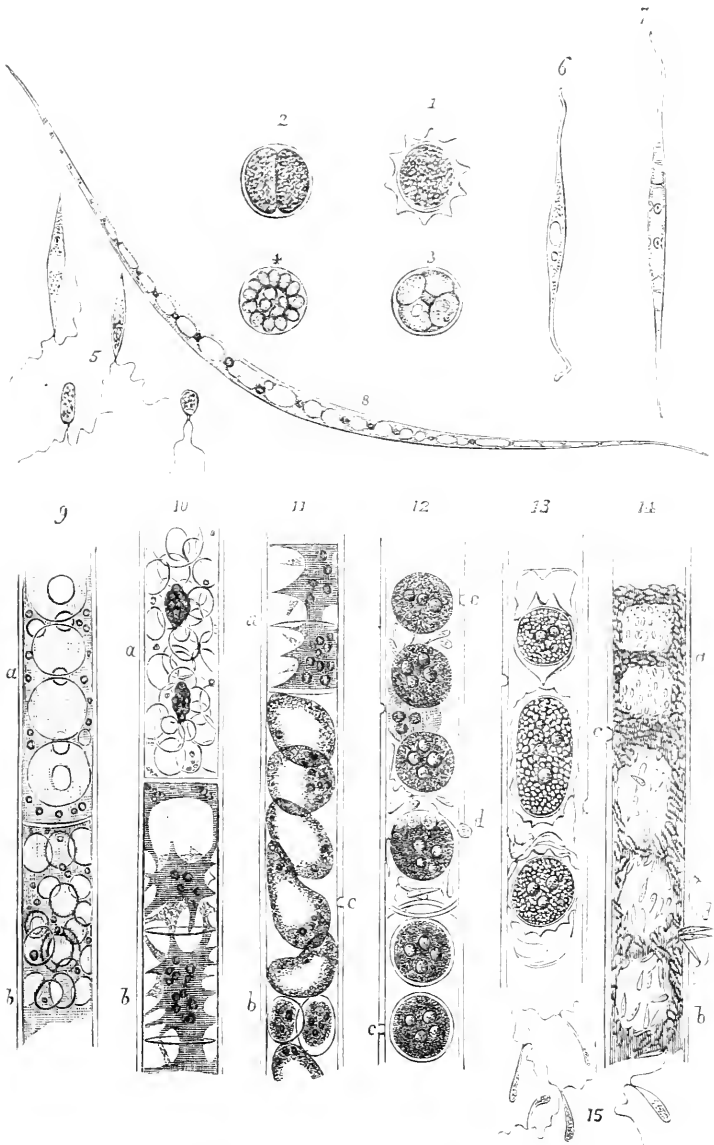

DEVELOPMENT AND REPRODUCTION OF SPHEROPLEA.

[To face p. 332.]

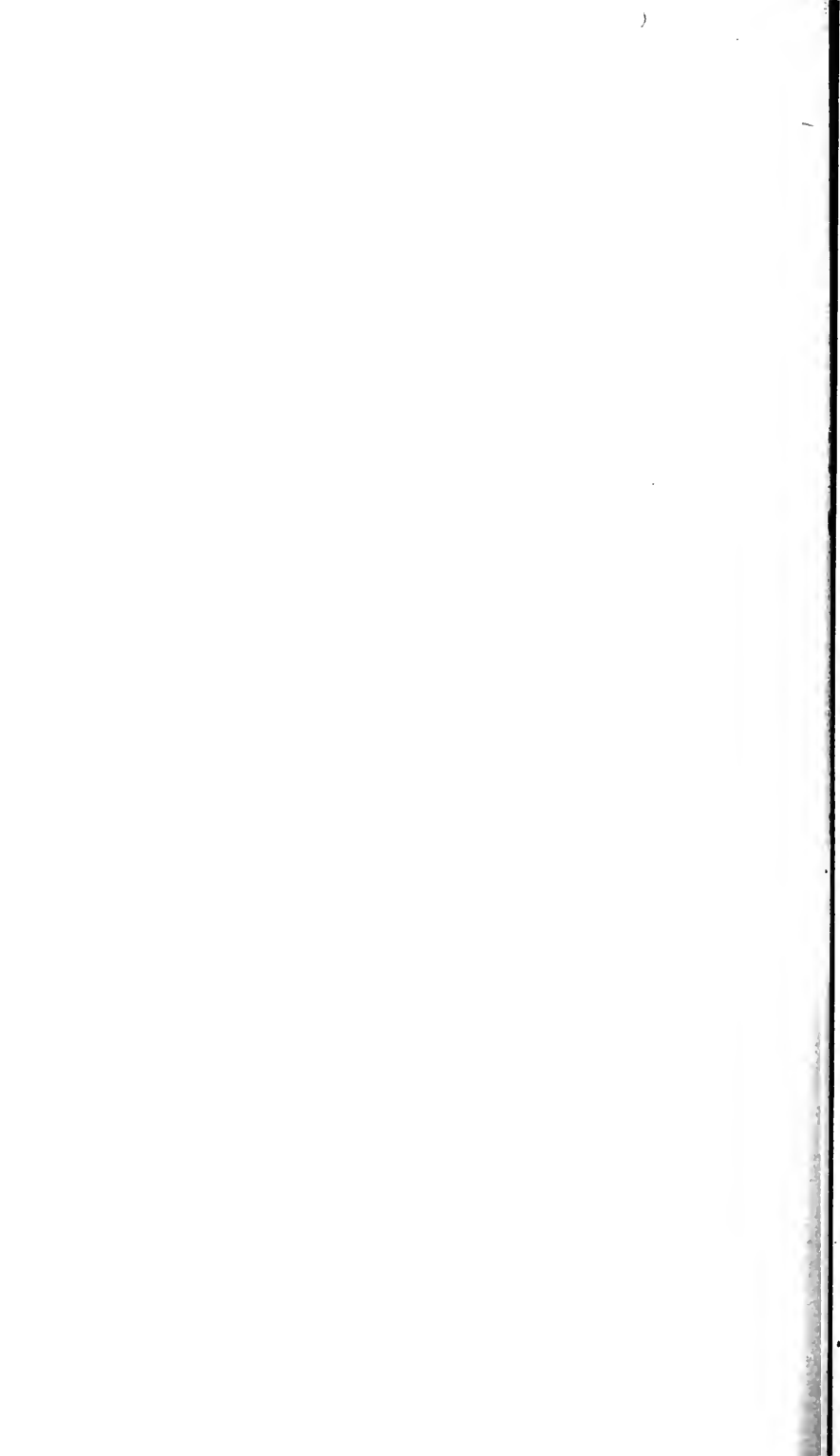

the lower part of fig. 12, thenceforward constituting true Spores. These undergo further changes whilst still contained within their tubular parent-cells; their colour changing from green to red, and a second investment being formed within the first, which extends itself into stellate prolongations, as seen in fig. 13; so that, when set free, they precisely resemble the mature Oo-spores which we have taken as the starting-point in this curious history. Certain of the filaments (fig. 14), instead of giving origin to spores, have their annular collections of endochrome converted into Antherozoids, which, as soon as they have disengaged themselves from the mucilaginous sheath that envelopes them, move about rapidly in the cavity of their containing cell (*a*, *b*) around the large vacuoles which occupy its interior; and then make their escape through apertures (*c*, *d*) which form themselves in its wall, to find their way through similar apertures into the interior of the spore-bearing cells, as already described. These Antherozoids are shown in fig. 15, as they appear when swimming actively through the water by means of the two motile filaments which each possesses. The peculiar interest of this history consists in the entire absence of any special organs for the Generative process, the ordinary filamentous cells developing Spores on the one hand, and Antherozoids on the other; and in the simplicity of the means by which the fecundating process is accomplished.—A curious variation of this process is seen in *Edogonium*; for whilst the Oo-spores are formed within certain dilated cells of the ordinary filament (Fig. 154, 1), and are fertilized by the penetration of antherozoids (2), these antherozoids are not the immediate product of the sperm-cells of the same or of another filament, but are developed within a body termed an 'Andro-spore' (5), which is set free from within a germ-cell (4), and which, being furnished with a circular fringe of cilia, and having motile powers, very strongly resembles an ordinary Zoospore. This *Andro-spore*, after its period of activity has come to an end, attaches itself to the outer surface of a germ-cell, as shown at 1, *b*; it then undergoes a change of shape, and a sort of lid drops off from its free extremity, as seen in the upper part of 1, by which its contained Antherozoids (2) are set free; and at the same time an aperture is formed in the wall of the cell containing the Oo-spore, by which the antherozoid enters its cavity, and fertilizes its contained mass by dissolving upon it and blending with it. This mass then becomes invested with a thick wall of its own; but even when mature (3) it retains more or less of the envelope derived from the cell within which it was developed.* It is probable that the same thing happens in many other Confervaceæ, and that some of the bodies which have been termed Micro-gonidia are really Andro-spores. The offices of these different classes of reproductive bodies are only now beginning to be understood; and the inquiry is one so fraught with

* See Pringsheim in "Ann. des Sci. Nat.," 4ième Sér., Botan., Tom. v. p. 187.

Physiological interest, and, from the facility of growing these plants in artificial Aquaria, may be so easily pursued, that it may be hoped that Microscopists will apply themselves to it so zealously as not long to leave any part of it in obscurity.

FIG. 154.

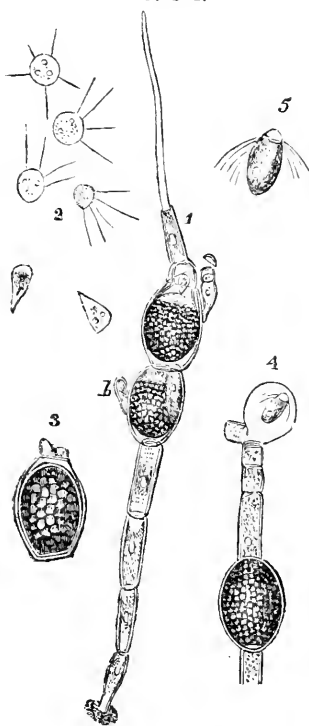

Sexual reproduction of *Edogonium ciliatum* :—1, filament with two Oo-spores in process of formation, the lower one having two Andro-spores attached to its exterior, the contents of the upper one in the act of being fertilized by the entrance of an antherozoid set free from the interior of its Andro-spore ; 2, free Antherozoids ; 3, mature Oo-spore, still invested with the cell-membrane of the parent filament ; 4, portions of a filament bearing sperm-cells, from one of which an Andro-spore is being set free ; 5, liberated Andro-spore.

251. The Family *Conjugateæ* agrees with that of *Confervaceæ* in its mode of growth, but differs from it in the plan on which its Generative process is performed ; this being accomplished by an act of Conjugation resembling that which has been described in the simplest Protophytes. These plants are not found so much in running streams, as in waters that are perfectly still, such as those of ponds, reservoirs, ditches, or marshy grounds ; and they are for the most part unattached, floating freely at or near the surface, especially when buoyed-up by the bubbles of gas which are liberated from the midst of them under the influence of solar light and heat. In an early stage of their growth, whilst as yet the cells are undergoing multiplication by subdivision, the Endochrome is commonly diffused pretty uniformly through their cavities (Fig. 155, A) ; but as they advance towards the stage of conjugation, the endochrome ordinarily arranges itself into regular spirals (B), but occasionally in some other forms. The act of Conjugation usually occurs between the cells of two distinct filaments that happen to lie in proximity to

each other ; and all the cells of each filament generally take part in it at once. The adjacent cells put forth little protuberances, which come into contact with each other, and then coalesce by the break-

ing down of the intervening partitions, so as to establish a free passage between the cavities of the conjugating cells. In some genera of this family (such as *Mesocarpus*), the conjugating cells pour their endochromes into a dilatation of the passage that has been established between them; and it is there that they commingle so as to form the Oo-spore. But in the *Zygnema* (Fig. 155), which

FIG. 155.

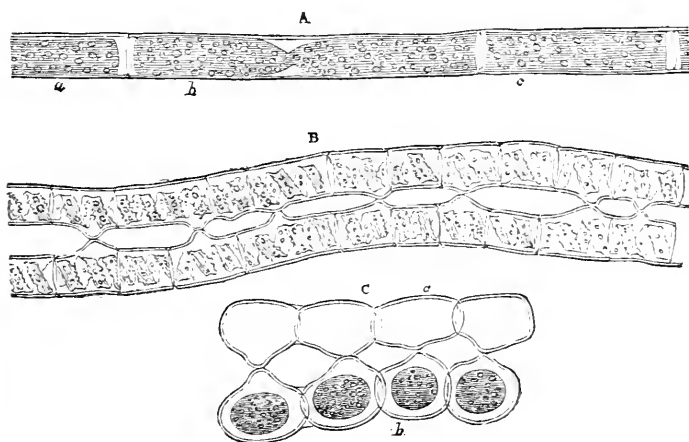

Various stages of the history of *Zygnema quininum*:—A, three cells, *a*, *b*, *c*, of a young filament, of which *b* is undergoing subdivision; B, two filaments in the first stage of conjugation, showing the spiral disposition of their endochromes, and the protuberances from the conjugating cells; C, completion of the act of conjugation, the endochromes of the cells of the filament *a* having entirely passed-over to those of filament *b*, in which the Oo-spores are formed.

is among the commonest and best-known forms of Conjugateæ, the endochrome of one cell passes over entirely into the cavity of the other; and it is within the latter that the Spore is formed (*c*), the two endochromes coalescing into a simple mass, around which a firm envelope gradually makes its appearance. Further, it may be generally observed that *all* the cells of one filament thus empty themselves, whilst *all* the cells of the other filament become the recipients; here, therefore, we seem to have a foreshadowing of the Sexual distinction of the Generative cells into 'Sperm-cells' and 'Germ-cells,' which we have just seen to exist in the Confervaceæ. And this transition will be still more complete if (as Itzigsohn has affirmed) the endochrome of certain filaments of *Spirogyra* breaks up before conjugation into little spherical aggregations, which are gradually converted into nearly colourless spiral filaments, having

an active spontaneous motion, and therefore corresponding precisely to the Antherozoids of the truly sexual Protophytes.

252. The *Chætophoraceæ* constitute another beautiful and interesting little group of Confervoid plants, of which some species inhabit the Sea, whilst others are found in Fresh and pure water—rather in that of gently-moving streams, however, than in strongly-flowing currents. Generally speaking, their filaments put forth lateral branches, and extend themselves into arborescent fronds; and one of the distinctive characters of the group is afforded by the fact, that the extremities of these branches are usually prolonged into bristle-shaped processes (Fig. 156). As in many preceding cases, these plants multiply themselves by the conversion

FIG. 156.

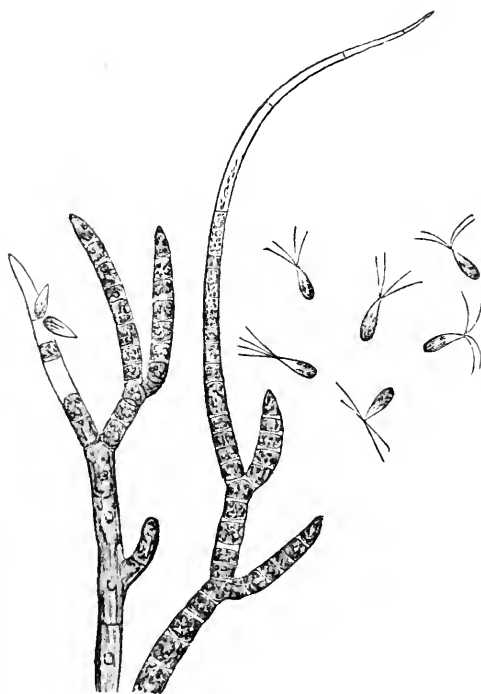

Branches of *Chætophora elegans*, in the act of discharging ciliated Zoospores, which are seen, as in motion, on the right.

plexity of structure, and afford objects of extreme beauty to the Microscopist (Fig. 157). The plants of this family are all

of the Endochrome of certain of their cells into Zoospores; and these, when set free, are seen to be furnished with four large cilia. 'Resting-spores' have also been seen in many species; and it is probable that these, as in Confervaceæ, are really Oo-spores, that is, are generative products of the fertilization of the contents of Germ-cells by Antherozoids developed within Sperm-cells (§ 250).

253. Nearly allied to the preceding are the *Batrachospermeæ*, whose name is indicative of the strong resemblance which their beaded filaments bear to frog-spawn; these exhibit a somewhat greater com-

inhabitants of Fresh water, and they are chiefly found in that which is pure and gently-flowing. "They are so extremely flexible," says Dr. Hassall, "that they obey the slightest motion of the fluid which surrounds them ; and nothing can surpass the ease and grace of their movements. When removed from the water they lose all form, and appear like pieces of jelly, without trace of organization ; on immersion, however, the branches quickly resume their former disposition." Their colour is for the most part of a brownish-green ; but sometimes they are of a reddish or bluish

FIG. 157.

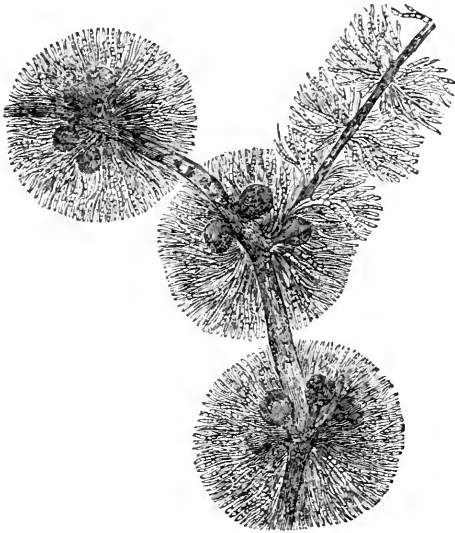
*Batrachospermum moniliforme.*

purple. The central axis of each plant is originally composed of a single file of large cylindrical cells laid end to end ; but this is subsequently invested by other cells, in the manner to be presently described. It bears, at pretty regular intervals, whorls of short radiating branches, each of them composed of rounded cells, arranged in a bead-like row, and sometimes subdividing again into two, or themselves giving off lateral branches. Each of the primary branches originates in a little protube-

rance from the primitive cell of the central axis, precisely after the manner of the lateral cells of *Conferva glomerata* (§ 249) : as this protuberance increases in size, its cavity is cut off by a septum, so as to render it an independent cell ; and by the continual repetition of the process of binary subdivision, this single cell becomes converted into a beaded filament. Certain of these branches, however, instead of radiating from the main axis, grow downwards upon it, so as to form a closely-fitting investment that seems properly to belong to it. Some of the radiating branches grow out into long transparent points, like those of *Chætophoracæ* ; and it does not seem by any means improbable that these, like the 'horns' of *Vaucheria* (§ 246), are really Antheridia. For within certain cells of other branches 'resting-

spores' are formed, by the agglomeration of which are produced the large dark bodies that are seen in the midst of the whorls of branches (Fig. 157).

254. This seems the most appropriate place to consider a group of humble Plants having a peculiar interest for Microscopists—that, namely, of *Characeæ*,—in which we have a Vegetative apparatus as simple as that of the Protophytes already described, whilst their Generative apparatus is even more highly developed than that of the proper *Algæ*. They are for the most part inhabitants of Fresh waters, and are found rather in such as are still than in those which are in motion; one species, however, may be met with in ditches whose waters are rendered salt by communication with the sea. They may be easily grown for the purposes of observation in large glass jars exposed to the light; all that is necessary being to pour off the water occasionally from the upper part of the vessel (thus carrying away a film that is apt to form on its surface), and to replace this by fresh water. Each plant is composed of an assemblage of long tubiform cells, placed end to end; with a distinct central axis, around which the branches are disposed at intervals with great regularity (Fig. 158, A). In one of the Genera, *Nitella*, the stem and branches are simple cells, which sometimes attain the length of several inches; whilst in the true *Chara* each central tube is surrounded by an envelope of smaller ones, which is formed as in *Batrachospermeæ*, save that the investing cells grow upwards as well as downwards from each joint, and meet each other on the stem half-way between the joints. Some species have the power of secreting carbonate of lime from the water in which they grow, if this be at all impregnated with Calcareous matter; and by the deposition of it beneath their teguments they have gained their popular name of 'Stone-worts.' These humble Plants have attracted much attention, in consequence of the facility with which the *Cyclosis*, or movement of fluid in the interior of the individual Cells, may be seen in them. Each cell, in the healthy state, is lined by a layer of green oval granules, which cover every part, except two longitudinal lines that remain nearly colourless (Fig. 158, B); and a constant stream of semi-fluid matter containing numerous jelly-like globules is seen to flow over this green layer, the current passing up one side, changing its direction at the extremity, and flowing down the other side, the ascending and descending spaces being bounded by the transparent lines just mentioned. That the currents are in some way directed by the layer of granules, appear sfrom the fact noticed by Mr. Varley,* that if accident damages or removes them near the boundary between the ascending and descending currents, a portion of the fluid of the two currents will intermingle by passing the boundary; whilst, if the injury be repaired by the development of new granules on the part from which they had been

* "Transactions of the Microscopical Society" (First Series), Vol. ii. p. 99.

detached, the circulation resumes its regularity, no part of either current passing the boundary. In the young cells, however, the rotation may be seen before the granular lining is formed. The rate of the movement is affected by anything that influences the vital activity of the Plant; thus, it is accelerated by moderate warmth, whilst it is retarded by cold; and it may be at once

FIG. 158.

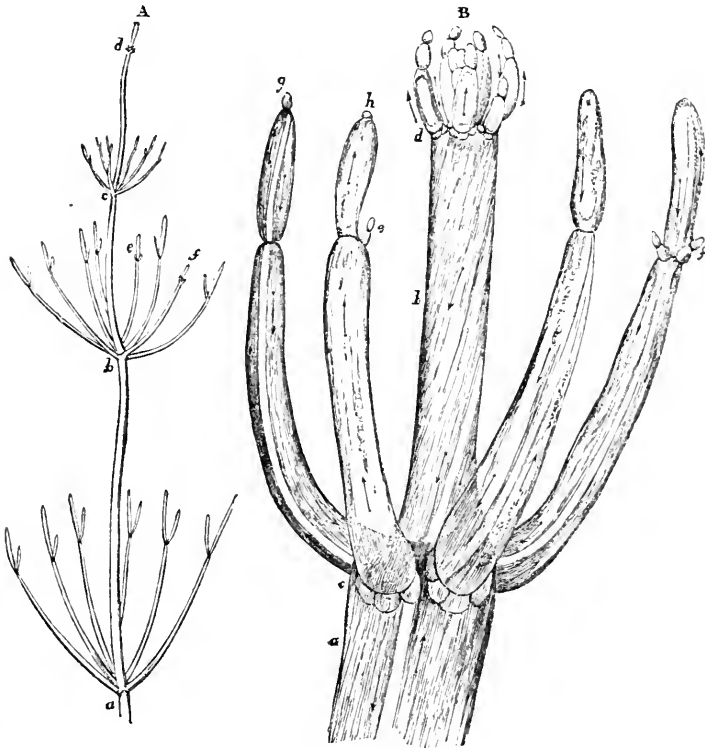

Nitella flexilis.—A, stem and branches of the natural size; a, b, c, d, four verticils of branches issuing from the stem; e, f, subdivision of the branches;—B, portion of the stem and branches enlarged; a, b, joints of stem; c, d, verticils; e, f, new cells sprouting from the sides of the branches; g, h, new cells sprouting at the extremities of the branches.

checked by a slight electric discharge through the plant. The moving globules, which consist of starchy matter, are of various sizes; being sometimes very small and of definite figure, whilst in other instances they are seen as large irregular masses, which appear

to be formed by the aggregation of the smaller particles.* The production of new Cells for the extension of the stem or branches, or for the origination of new whorls, is not here accomplished by the subdivision of the parent-cell, but takes place by the method of out-growth (Fig. 158, B, c, f, g, h), which, as already shown (§ 249), is nothing but a modification of the usual process of cell-multiplication; in this manner, the extension of the individual plant is effected with considerable rapidity. When these plants are well supplied with nutriment, and are actively vegetating under the influence of light, warmth, &c., they not unfrequently develop 'bulbels,' or Gonidia of a peculiar kind, which serve the same purpose in multiplying the individual, as is answered by the Zoospores of the simpler Protophytes: these are little clusters of cells, filled with starch, which sprout from the sides of the central axis, and then, falling off, evolve the long tubiform cells characteristic of the plant from which they were produced.† The *Characeæ* may also be multiplied by artificial subdivision; the separated parts continuing to grow under favourable circumstances, and developing themselves into the typical form.

255. The Generative apparatus of *Characeæ* consists of two sets of bodies, both of which grow at the bases of the branches (Fig. 159, A, B); one set is known by the designation of 'Globules,' the other by that of 'Nucules.' The former are really Antheridia, whilst the latter contain the Germ-cells. The 'Globules,' which are nearly spherical, have an envelope made up of eight triangular valves (B, c), often curiously marked, which encloses a nucleus of a light reddish colour: this nucleus is principally composed of a mass of filaments rolled up compactly together; and each of these filaments (c) consists, like a *Conferva*, of a linear succession of cells. In every one of these cells there is formed, by a gradual change in its contents (the successive stages of which are seen at D, E, F), a spiral thread of two or three coils, which, at first motionless, after a time begins to move and revolve within the cell; and at last the cell-wall gives way, and the spiral thread makes its way out (G), partially straightens itself, and moves actively through the water for some time (H) in a tolerably determinate direction, by the lashing action of two long and very delicate filaments with which they are furnished. The exterior of the 'Nucule' (A, B) is formed by five spirally-twisted tubes, that give it a very peculiar

* This interesting phenomenon may be readily observed, by taking a small portion of the Plant out of the water in which it is growing, and either placing it in a large Aquatic Box (§ 97) or in the Zoophyte-Trough (§ 98), or laying it on the glass Stage-plate (§ 96) and covering it with thin glass. The modification of the stage-plate termed the 'Growing Slide' (§ 96) will enable the Microscopist to keep a portion of *Chara* under observation for many days together.

† This multiplication by bulbels was described by Amici in 1827; but his observations seem to have been forgotten by Botanists, until the re-discovery of the fact by M. Montagne.

aspect ; and these enclose a central sac containing protoplasm, oil, and starch-globules. At a certain period the spirally-twisted tubes, which form a kind of crown around the summit, separate

FIG. 159.

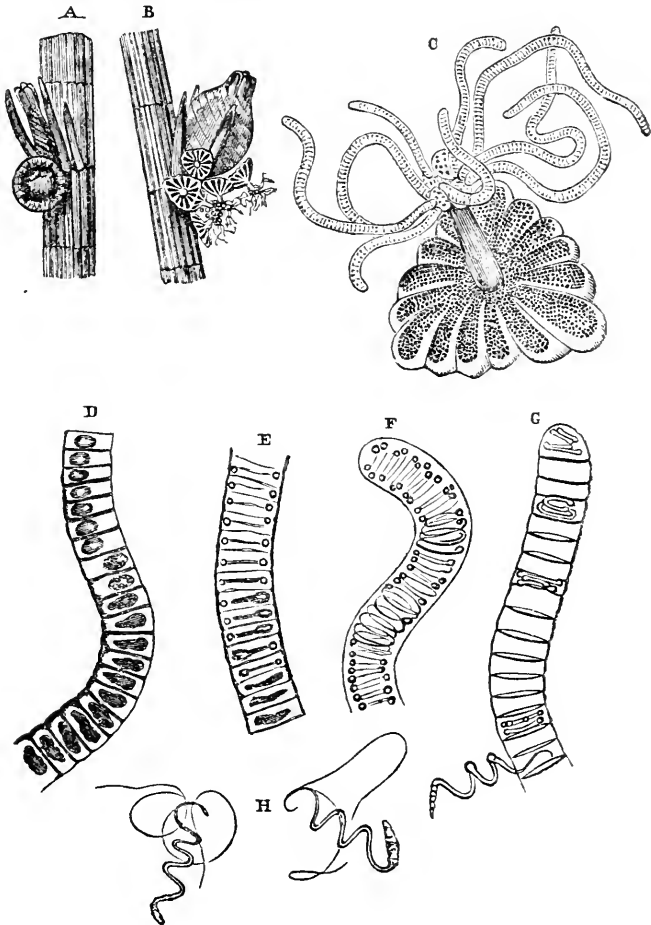

Antheridia of *Chara fragilis*:—A, antheridium or 'globule' developed at the base of pistillidium or 'nucule';—B, nucule enlarged, and globule laid open by the separation of its valves ;—C, one of the valves, with its group of antheridial filaments, each composed of a linear series of cells, within every one of which an antherozoid is formed;—in D, E, and F, the successive stages of this formation are seen;—and at G is shown the escape of the mature antherozoids, H.

from each other, leaving a canal that leads down to the central cell ; and it is probable that through this canal the Antherozoids make their way down, to perform the act of fertilization. Ultimately the nucule falls off like a seed, and gives origin to a single new plant by a kind of germination.—The complete *specialization* of the Generative apparatus which we here observe (the organs of which it is composed being distinctly separated from the ordinary Vegetative portion of the fabric), as well as the complex structure of the organs themselves, mark out this group, in spite of the simplicity of the rest of its structure, as belonging to a grade very much above that of the other Families that have been treated of in this chapter ; but as scarcely any two Botanists agree upon the exact place which ought to be assigned to it, the convenience of associating it with other forms of vegetation of which the Microscopist especially takes cognizance, is a sufficient reason for so arranging it in a work like the present.*

* It was affirmed by Dr. Hartig (see "Quart. Journ. of Microsc. Science," Vol. iv., 1856, p. 51) that the Antherozoids of *Chara* and *Nitella*, as of *Marchantia* and *Mosses*, may undergo a kind of metamorphosis into *Spirilla*, *Vibriones*, and *Monads*; and that, by the coalescence of these last, *Amæbae* are produced. And further, it was asserted by Mr. H. Carter, of Bombay, that the protoplasm of the ordinary cells of the *Characeæ* and other aquatic plants might become transformed into an *Actinophrys* (see "Ann. of Nat. Hist.," 2nd Ser., Vol. xix., p. 287). More recently, however, this doctrine has been retracted by Mr. Carter ("A.N.H.," 3rd Ser., Vol. viii., p. 289), who accounts for the phenomena which he observed on the hypothesis of parasitism. Yet the original statements of Dr. Hartig and Mr. Carter have received independent support from the observations of Dr. Hicks on *Volvox* (§ 198) and on the root-fibres of *Mosses* (§ 275), and from those of De Bary on the so-called *Mycetozoa* (§ 269).

CHAPTER VII.

MICROSCOPIC STRUCTURE OF HIGHER CRYPTOGAMIA.

256. FROM those simple Protophytes, whose minuteness causes their entire fabrics to be fitting objects for Microscopic examination, we pass to those higher forms of Vegetable life whose larger dimensions require that they should be analyzed (so to speak) by the examination of their separate parts. And in the present Chapter we shall bring under notice some of the principal points of interest to the Microscopist which are presented by the *Cryptogamic* series; commencing with those simpler Algæ which scarcely rank higher than some of the Protophytes already described, and ending with the Ferns and their allies, which closely abut upon the *Phanerogamia* or Flowering Plants. In ascending this series, we shall have to notice a *gradual differentiation* of organs; those set apart for Reproduction being in the first place separated from those appropriated to Nutrition (as we have already seen them to be in the *Characeæ*); while the principal parts of the Nutritive apparatus, which are at first so blended into a uniform expansion or *Thallus* that no real distinction exists between Root, Stem, and Leaf, are progressively evolved on types more and more peculiar to each respectively, and have their functions more and more limited to themselves alone. Hence we find a differentiation, not merely in the external form, but also in the intimate structure of organs; its degree bearing a close correspondence to the degree in which their functions are respectively *specialized* or limited to particular actions. Thus in the simple *Ulvæ* (Fig. 147), whatever may be the extent of the Thallus, every part has exactly the same

FIG. 160.

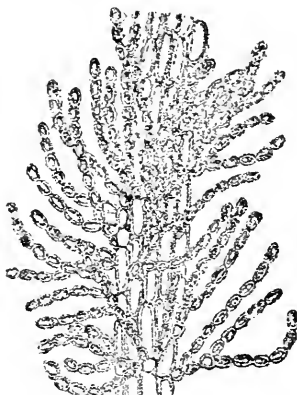

Mesogloia vermicularis.

part has exactly the same

structure, and performs the same actions as every other part, living *for* and *by* itself alone. In *Batrachospermum* (Fig. 157) we have seen a definite arrangement of branches upon an axis of growth; and while the branches are formed of simple necklace-like rows of rounded cells, the cells of the stem are elongated and adhere to one another by flattened ends. This kind of differentiation is seen to be carried to a still greater extent in *Mesogloia* (Fig. 160), a plant that may be considered as one of the connecting links between such Protophytes as *Batrachospermæ*, which it resembles in general plan of structure, and the Fucoïd Algæ, which it resembles in fructification.

257. When we pass to the higher Sea-weeds, such as the common *Fucus* and *Laminaria*, we observe a certain foreshadowing

FIG. 161.

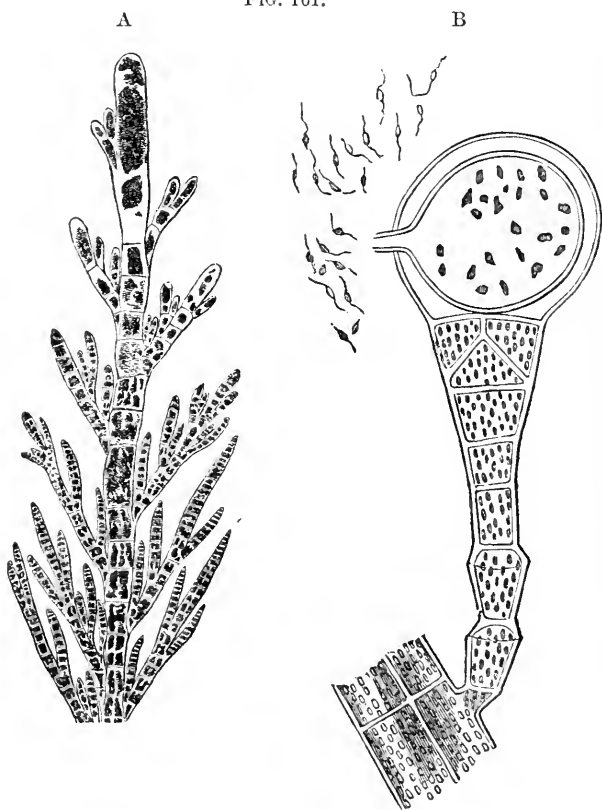

A, Terminal portion of branch of *Sphacelaria cirrhosa*; B, lateral branchlet of *S. tribuloides*, the terminal cell of which is emitting antherozoids.

of the distinction between Root, Stem, and Leaf ; but this distinction is very imperfectly carried out, the root-like and stem-like portions serving for little else than the mechanical attachment of the leaf-like part of the plant, and each still absorbing and assimilating its own nutriment, so that no transmission of fluid takes place from one portion of the fabric to another. Hence we find that there is not yet any departure from the simple *Cellular* type of structure; the only modification being that the several layers of Cells, where many exist, are of different sizes and shapes, the texture being usually closer on the exterior and looser within ; and that the texture of the Stem and Roots is denser than that of the leaf-like expansions or *Fronds*. The group of *Melanospermous* or Olive-green Sea-weeds, which in the family *Fucaceæ* exhibits the highest type of Algal structure, presents us with the lowest in the family *Ectocarpaceæ*; which, notwithstanding, contains some of the most elegant and delicate structures that are anywhere to be found in the group, the full beauty of which can only be discerned by the Microscope. Such is the case, for example, with the *Sphacelaria*, a small and delicate Sea-weed, which is very commonly found parasitic upon larger Algæ, either near low-water-mark or altogether submerged ; its general form being remarkably characterized by a symmetry that extends also to the individual branches (Fig. 161, A), the ends of which, however, have a decayed look that seems to have suggested the name of the genus (from the Greek *σφακιλος* gangrene). From the recent observations of Pringsheim, it appears that this apparent decay really consists in the resolution of the endochrome of the terminal cells into Antherozoids, which, when mature, escape by an opening with a long tubular neck, which forms itself in the wall of the *sphacela*. The same happens with the terminal cells of the peculiar lateral branchlets, which are known as propagative buds ; as is shown at B. The Germ-cells have not been certainly recognized ; but they are believed to be produced in what have been considered as propagative buds in other individuals.

258. The study of the higher and larger members of this group has recently come to present a new and very attractive source of interest to the Microscopist, in consequence of the discovery of the truly Sexual nature of their fructification ; and we shall take that of a common species of *Fucus* as the type of that of the order generally. The 'Receptacles,' which are borne at the extremities of the fronds, here contain both 'Sperm-cells' and 'Germ-cells ;' in some other species, however, these are disposed in different Receptacles on the same plant ; whilst in the commonest of all *F. vesiculosus* (bladder-wrack), they are limited to different individuals.* When a section is made through one of the flattened

* It was at first stated by MM. Thuret and Decaisne that this species was sometimes dioecious, sometimes hermaphrodite ; but they now consider the hermaphrodite form to be a distinct species, the *F. platycarpus* described above.

receptacles of *F. platycarpus*, its interior is seen to be a nearly globular cavity (Fig. 162), lined with filamentous cells, some of which are greatly elongated, so as to project through the pore by

FIG. 162.

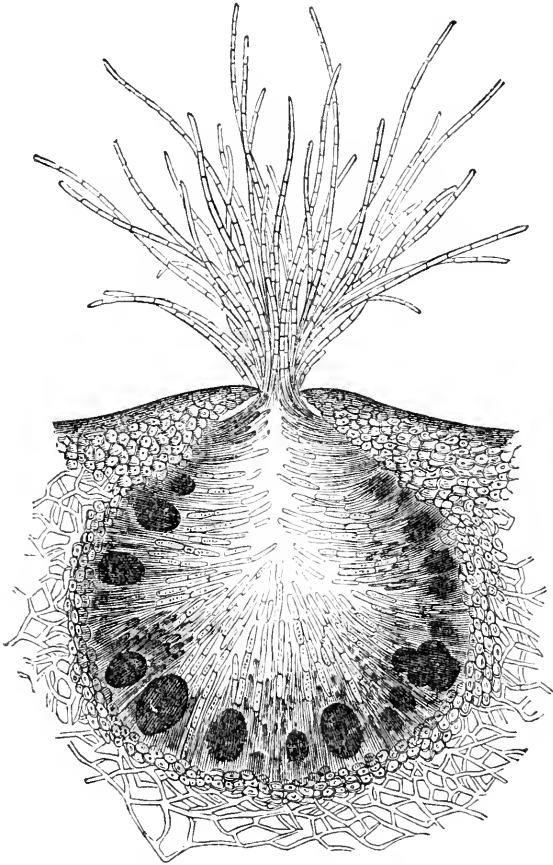

Vertical section of receptacle of *Fucus platycarpus*, lined with filaments, among which lie the Antheridial cells, and the Sporangia containing octospores.

which the cavity opens on the surface. Among these are to be distinguished, towards the period of their maturity, certain filaments (Fig. 163, A) whose granular contents acquire an orange hue, and gradually shape themselves into oval bodies (B), each with an orange-coloured spot, and two long thread-like appendages,

which, when discharged by the rupture of the containing cell, have for a time a rapid undulatory motion, whereby those Antherozoids are diffused through the surrounding liquid. Lying amidst the filamentous mass, near the walls of the cavity, are seen (Fig. 162)

FIG. 163.

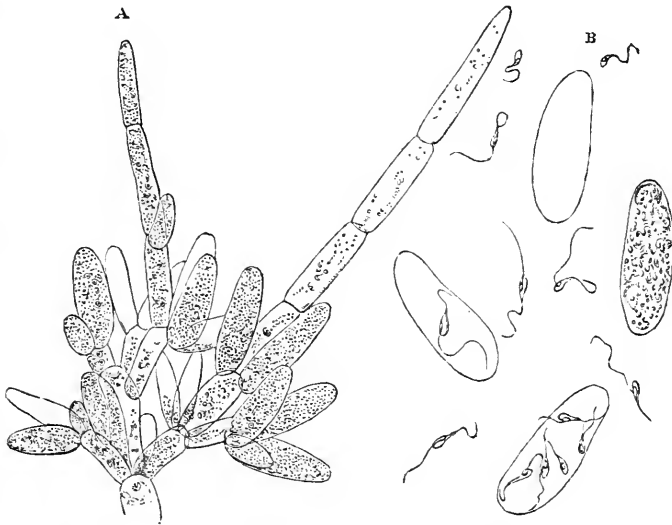

Antheridia and antherozoids of *Fucus platycarpus*:—A, branching articulated hairs, detached from the walls of the receptacle, bearing antheridia in different stages of development; B, antherozoids, some of them free, others still included in their antheridial cells.

numerous dark pear-shaped bodies, which are the *Sporangia*, or parent-cells of the 'germ-cells.' Each of these sporangia gives origin, by binary subdivision, to a cluster of eight cells, which is thence known as an 'Octospore;' and these are liberated from their envelopes before the act of fertilization takes place. This act consists in the swarming of the Antherozoids over the surface of the Germ-cells, to which they communicate a rotatory motion by the vibration of their own filaments: it takes place within the Receptacles in the hermaphrodite Fuci, so that the spores do not make their exit from the cavity until after they have been fecundated; but in the monœcious and diœcious species, each kind of Receptacle separately discharges its contents, which come into mutual contact on their exterior. The Antheridial cells are usually ejected entire, but soon rupture so as to give exit to their filaments; the Sporangia of the female receptacles discharge their globular octospores within the receptacle; and these, soon after

passing-forth, liberate their separate Spores, which speedily meet with antherozoids, and are fecundated by them. The Spores, when fertilized, soon acquire a new and firmer envelope; and under favourable circumstances they speedily begin to develop themselves into new plants. The first change seen in them is the projection and narrowing of one end into a kind of footstalk by which the spore attaches itself, its form passing from the globular to the pear-shaped: a partition is speedily observable in its interior, its single cell being subdivided into two; and by a continuation of a like process of duplication, first a filament and then a frondose expansion is produced, which gradually evolves itself into the likeness of the parent Plant.

259. The whole of this process may be watched without difficulty, by obtaining specimens of *F. vesiculosus* at the period at which the fructification is shown to be mature by the recent discharge of the contents of the conceptacles in little gelatinous masses on their orifices; for if some of the Spores which have been set free from the olive-green (female) receptacles be placed in a drop of sea-water in a very shallow cell, and a small quantity of the mass of Antherozoids, set free from the orange-yellow (male) receptacles, be mingled with the fluid, they will speedily be observed, with the aid of a magnifying power of 200 or 250 diameters, to go through the actions just described; and the subsequent processes of germination may be watched by means of the Growing-Slide.* The winter months, from December to March, are the most favourable for the observation of these phenomena; but where Fuci abound, some individuals will usually be found in fructification at almost any period of the year. Even in the *Fucaceæ*, according to recent observations, a multiplication by Zoospores, like that of the *Ulvaceæ* (§ 241), still takes place; these bodies being produced within certain of the cells that form the superficial layer of the frond, and swimming about freely for a time after their emission, until they fix themselves and begin to grow. That they are to be considered as *gemmæ* (or buds), and not as Generative products, appears certain from the fact that they will vegetate without the assistance of any other bodies: whereas the Antherozoids of themselves never come to anything; while the Octospores undergo no further changes, but decay away (as M. Thuret has experimentally ascertained) if not fecundated by the antherozoids.

260. Among the *Rhodospermeæ*, or Red Sea-weeds, also, we find various simple but most beautiful forms, which connect this group with the more elevated Protophytes, especially with the family *Chatophoraceæ*; such delicate feathery or leaf-like fronds belong for the most part to the Family *Ceramiaceæ*, some members

* If the drop be covered, a shallow Cell should be used, so as to keep the pressure of the thin glass from the minute bodies beneath, whose movements it will otherwise impede.

of which are found upon every part of our coasts, attached either to rocks or stones or to larger Algæ, and often themselves affording an attachment to Zoophytes and Bryozoa. They chiefly live in deeper water than the other sea-weeds; and their richest tints are only exhibited when they grow under the shade of projecting rocks or of larger dark-coloured Algæ. Hence in growing them artificially in Aquaria, it is requisite to protect them from an excess of light; since otherwise they become unhealthy.—The nature of the fructification of the *Rhodospirææ* (or *Florideæ*) is less perfectly understood than that of the Furoid Algæ. It is certain, however, that Antheridia exist among them; these being developed in individuals that do not produce spores, and in pretty much the same situations. The products of these Antheridia, however, do not exhibit the spontaneous motion of ordinary antherozoids. Of the Spores there are two kinds, of which one

FIG. 164.

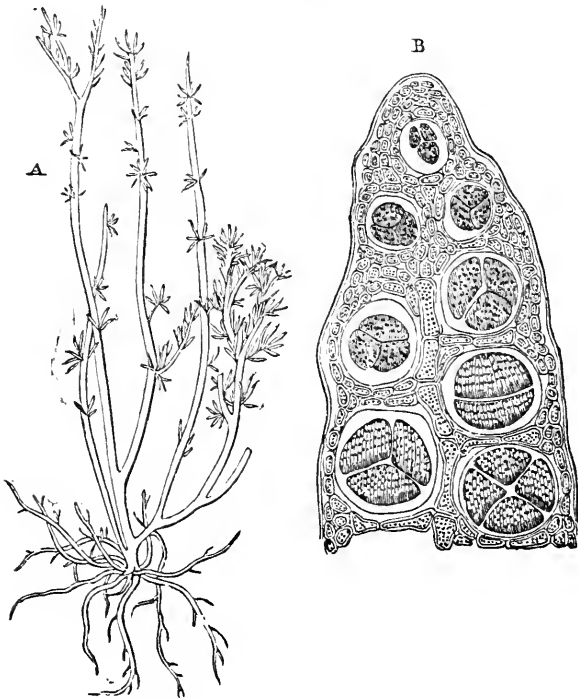

Arrangement of Tetraspores in *Carpocaulon mediterraneum*:
 —A, entire plant; B, longitudinal section of branch. (N.B. Where only three tetraspores are seen, it is merely because the fourth did not happen to be so placed as to be seen at the same view.)

set are probably *gemmae*, whilst the other are germ-cells; but it is not yet determined to which of the two these characters respectively belong. The 'Tetraspores'—which are peculiarly characteristic of this group, being found in every one of its subdivisions—are usually imbedded in the general substance of the frond, though they sometimes congregate in particular parts, or are restricted to a special branch. Each group (Fig. 164, B) seems to be evolved within one of the ordinary cells of the frond, which undergoes binary subdivision; the four secondary cells, however, remain enclosed within their primary cell until the period of maturity, a new envelope, the 'perispore,' being formed around them.—In the true *Corallines*, which are Sea-weeds whose tissue is consolidated by calcareous deposit, the Tetraspores are included within hollow conceptacles; but, generally speaking, it is the simple Spores only which are thus specially protected. These are never scattered through the frond, like the tetraspores; and are commonly developed within a *Ceramidium*, which is an urn-shaped case, furnished with a pore at its summit, and containing a tuft of pear-shaped spores arising from the base of its cavity. The resemblance of these bodies in position to the Octospores of Fuci would seem to justify the conclusion that *they* are the true Generative spores, whilst the Tetraspores are *Gemmae*, as Harvey and Thwaites consider them; but a different view is taken by Decaisne, Agardh, and other eminent Algologists, who regard the tetraspores as the true generative spores, and consider the simple spores to be *gemmae*. It is, therefore, a point of much interest to determine by careful observation and experiment which is the right view; and Microscopists who have the opportunity of studying these plants, either in their native haunts or in artificial Aquaria, can scarcely apply themselves to a better subject of investigation.

261. The Class of *Lichens*, which consists of Plants that closely correspond with *Algæ* in simplicity of organization, but differ from them widely in habit, does not present so many objects of attractive interest to the Microscopist; and the peculiar density which usually characterizes their structure, renders a minute examination of it more than ordinarily difficult. Lichens are commonly found growing upon the trunks or branches of trees, upon rocks or stones, upon hard earth, or in other situations in which they are sparingly supplied with moisture, but are freely exposed to light and air. In the simpler forms of this group, the Primordial Cell gives origin, by the ordinary process of subdivision, to a single layer of cells, which may spread itself over the surface to which it is attached, in a more or less circular form; and one or more additional layers being afterwards developed upon its free surface, a *Thallus* is formed, which has no very defined limit, and which, in consequence of the very slight adhesion of its component cells, is said to be 'pulverulent.' Sometimes, however, the cells of the

Thallus are rather arranged in the form of filaments, which penetrate the superficial layers of the bark whereon such Lichens grow, and which are sometimes also so interwoven at the outer surface as to form a sort of cuticle. Interposed among the ordinary cells of the Thallus we very commonly find certain green globular cells, arranged in single bead-like filaments; these, which are termed *Gonidia*, being found to be capable of reproducing the plant when detached, must be considered as *gemmæ*. From the recent observations of various Botanists, and especially from those of Dr. Hicks (p. 320), it appears that many of the forms which have been ranked among Unicellular Algæ, are in reality transitory conditions of these *Gonidia*, which may multiply themselves by binary subdivision to a vast extent, without any essential change in their condition. It was long since observed by Mr. Thwaites (p. 319, *note*), that interlacing filaments are sometimes found in the midst of the intercellular substance which holds together the cells of masses of *Palmella*; and this seems to constitute a very definite approach to the Lichenoid condition. For in the higher tribes of Lichens we find the interlacing filaments forming a tough cortical envelope to both surfaces; whilst in the interior of the firm 'crustaceous' Thallus the gonidial cells are found in regular layers. Sometimes these increase in particular spots, and make their way through the upper cortical layer, so as to appear on the surface as little masses of dust, which are called *Soredia*.

262. Besides these, Lichens are believed to contain proper Generative organs, by which a true Sexual reproduction is effected. In addition to the 'fructification,' which is commonly recognized by its projection from the surface of the Thallus, the researches of M. Tulasne have detected a set of peculiar organs of much smaller size, not unlike the male Receptacles of *Fuci* (§ 258), to which he has given the appellation of *Spermogonia*. From the exterior of the cellular filaments which line these cavities, a vast number of minute oval bodies termed *Spermatia* are budded off, which, when mature, escape in great numbers from the orifices of the spermogonia. They differ from ordinary Antherozoids in being destitute of any power of spontaneous movement, and we cannot yet indubitably assign to them the male character, although various considerations concur to render their performance of this function highly probable. The Female portion of the Generative apparatus, though sometimes dispersed through the Thallus, is usually collected into special aggregations, which form projections of various shapes; these, although they have received a variety of designations according to their particular conformation, may all be included under the general term *Apothecia*. When divided by a vertical section, these bodies at their maturity are found to contain a number of *Asci* or spore-cases, arranged vertically in the midst of straight elongated cells or filaments, which are termed *Paraphyses*. Each of the asci contains a definite number of Spores (usually eight, but

always a multiple of two), which are projected from the apothecia with some force, the emission being kept up continuously for some time : this discharge seems to be due to the different effect of moisture upon the different layers of the apothecium. When and how the act of Fecundation is accomplished, is a matter still hidden in obscurity ; and the problem is one which will only be resolved by a combination of sagacity, manipulative skill, and perseverance, on the part of Microscopic observers who may devote themselves to the study.*

263. In the simplest forms of *Fungi* we again return to the lowest type of Vegetable existence, namely, the single cell ; and such, if perfect Plants, would properly take rank among the lowest Protophytes. But there is good reason for regarding many—perhaps all—of those which *seem* most simple, as the imperfectly developed states of other Plants, which, if they attained their full evolution, would present a much more complex structure. This is the case, for example, with the *Torula cerevisia* or ‘yeast-plant,’ which so abounds in Yeast that this substance may be said to be almost entirely made up of it. When a small quantity of Yeast is placed under the Microscope, and is magnified 300 or 400 diameters, it is found to be full of globules, which are clearly Cells ; and these cells vegetate, when placed in a fermentible fluid containing some form of Albuminous matter in addition to Sugar, in the matter represented in Fig. 165. Each Cell puts forth one or two projections, which seem to be young cells developed as buds or offsets from their predecessors ; these, in the course of a short time, become complete cells, and again perform the same process ; and in this manner the single cells of yeast develop themselves, in the course of a few hours, into rows of four, five, or six, which remain in continuity with each other whilst the plant is still growing, but which separate if the fermenting process be checked,

FIG. 165.

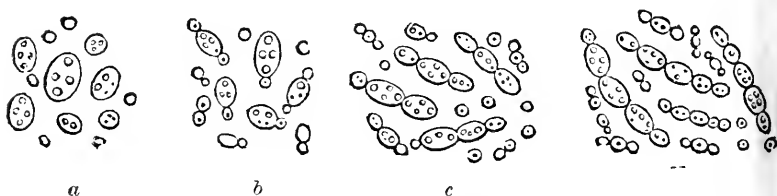

Torula cerevisia, or Yeast-Plant, as developed during the process of fermentation:—*a*, *b*, *c*, *d*, successive stages of Cell-multiplication.

* For the latest information on this subject, see Dr. Lauder Lindsay's Memoir on Polymorphisme in the Fructification of Lichens ("Quart. Journ. of Microsc. Science," Vol. viii., N.S., 1868, p. 1), and the authors therein referred to.

and return to the isolated condition of those which originally constituted the yeast. Thus it is that the quantity of Yeast first introduced into the fermentible fluid is multiplied six times or more during the changes in which it takes part. The full development of the Plant, and the evolution of its apparatus of Fructification, however, only occur when the fermenting process is allowed to go on without check; and it seems capable of producing a considerable variety of forms, whose precise relationship to each other has not yet been made clear.—The recent researches of M. Pasteur have fully confirmed the belief previously entertained by many Physiologists (though generally discountenanced by Chemists), that all Fermentative processes essentially depend upon the development of Fungous Vegetation in the substance undergoing change. Thus he found that if Milk be boiled in a flask the mouth of which is plugged with cotton-wool before the boiling has ceased, the milk remains sweet for any length of time; whilst milk boiled in a similar flask left unstopped, first turns sour and then becomes putrescent in the course of a few days. Air can enter with the same freedom in the first case as in the second; but in the first it is filtered of the organic germs it carries.

264. Many of the simpler forms of Fungi are inhabitants of the interior of the bodies of other animals, and are only known as living in these situations. Among these may first be mentioned the *Sarcina ventriculi* (Fig. 166), which is most frequently found in the matters vomited by persons suffering under disorder of the Stomach, but has also been met with in other diseased parts of the body. The Plant has been detected in the contents of the Stomach, however, under circumstances which seem to indicate that it is not an uncommon tenant of that organ even in health, and that it may accumulate there to a considerable amount without producing any inconvenience; it seems probable,

FIG. 166.

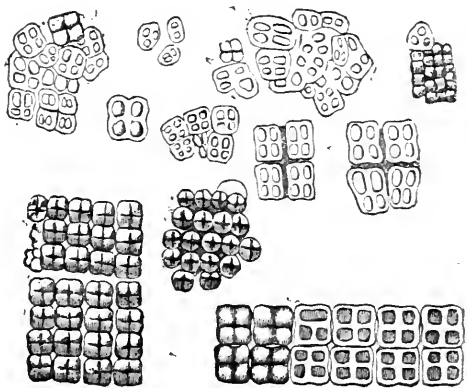
*Sarcina ventriculi.*

therefore, that its presence in disease is rather to be considered as favoured by the changed state of the fluids which the disease induces (either an acid or a fermentible state of the contents of the stomach

having been generally found to exist in the cases in which the plant has been most abundant), than to be itself the occasion of the disease, as some have supposed. The *Sarcina* presents itself in the form of clusters of adherent cells arranged in squares, each square containing from 4 to 64, and the number of cells being obviously multiplied by duplicative subdivision in directions transverse to each other. In fact, its general mode of growth would indicate a near relation to *Gonium*, one of the Volvocineæ, which presents itself in similar quadripartite aggregations; and many Botanists, looking to this circumstance, and to the residence of the plant in liquid, regard it as belonging to the group of Algæ. It agrees with the Fungi, however, in not living elsewhere than in liquids containing organic matter; and there can be little doubt that as no fructification has yet been seen in it, only its earlier and simpler condition is yet known to us. Its true place cannot be determined until its whole life-history shall have been followed out.

265. There is a form of Fungous vegetation that is prone to develop itself within the living body, which is of great economic importance as well as of scientific interest; this is the *Botrytis bassiana* (Fig. 167), a kind of 'mould,' the growth of which is the real source of the disease termed *Muscardinæ*, that sometimes carries off Silk-worms in large numbers, just when they are about to enter the chrysalis state, to the great injury of their breeders. The plant presents itself under a considerable variety of forms (A-F), all of which, however, are of extremely simple structure, consisting of elongated or rounded cells, connected in necklace-like filaments, very nearly as in the ordinary 'bead-moulds.' The sporules of this fungus, floating in the air, enter the breathing pores which open into the Tracheal system of the Silkworm (§ 524): they first develop themselves within the air-tubes, which are soon blocked up by their growth; and they then extend themselves through the fatty mass beneath the skin, occasioning the destruction of this tissue, which is very important as a reservoir of nutriment to the animal when it is about to pass into a state of complete inactivity. The disease invariably occasions the death of the silkworm which it attacks; but it seldom shows itself externally until afterwards, when it rapidly shoots forth from beneath the skin, especially at the junction of the rings of the body. Although it spontaneously attacks only the larva, yet it may be communicated by inoculation to the Chrysalis and the Moth, as well as to the worm; and it has been also observed to attack other Lepidopterous Insects. A careful investigation of the circumstances which favour the development of this disease was made by Audouin, who first discovered its real nature; and he showed that its spread is favoured by the overcrowding of the worms in the breeding establishments, and particularly by the practice of throwing the bodies of such as die into a heap in the immediate neighbourhood of the living worms: this heap speedily becomes covered with this kind

of 'mould,' which finds upon it a most congenial soil ; and it keeps up a continual supply of sporules, which, being diffused through the atmosphere of the neighbourhood, are drawn into the breathing

FIG. 167.

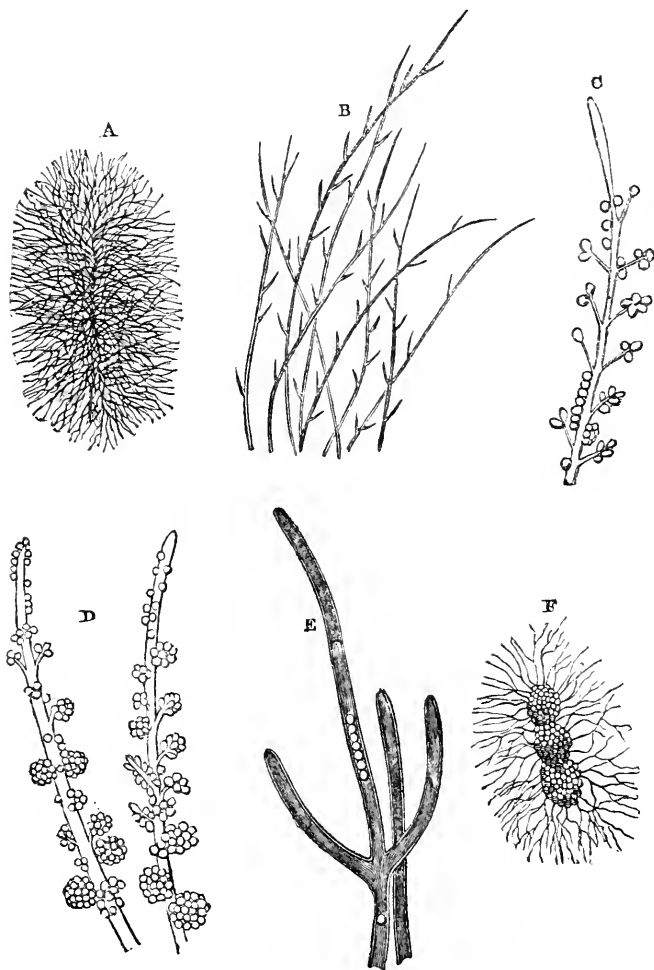

Botrytis bassiana.—A, the fungus as it first appears at the orifices of the stigmata ; B, tubular filaments bearing short branches, as seen two days afterwards ; E, magnified view of the same ; C, D, appearance of filaments on the fourth and sixth days ; F, masses of mature spores falling off the branches, with filaments proceeding from them.

pores of individuals previously healthy. Wherever the precautions obviously suggested by the knowledge of the nature of the disease, thus afforded by the Microscope, have been duly put in force, its extension has been kept within comparatively limited bounds. Again, it is not at all uncommon in the West Indies to see individuals of a species of *Polistes* (the representative of the Wasp of our own country) flying about with plants of their own length projecting from some part of their surface, the germs of which have been probably introduced (as in the preceding case) through the breathing-pores at their sides, and have taken root in their substance, so as to produce a luxuriant vegetation. In time, however, this fungous growth spreads through the body, and destroys the life of the insect; it then seems to grow more rapidly, the decomposing tissue of the dead body being still more adapted than the living structure to afford it nutriment. A similar growth of different species of the genus *Sphaeria* takes place in the bodies of certain Caterpillars in New Zealand, Australia, and China; and being thus completely pervaded by a dense substance, which, when dried, has almost the solidity of wood, these Caterpillars come to present the appearance of twigs, with long slender stalks that are

FIG. 168.

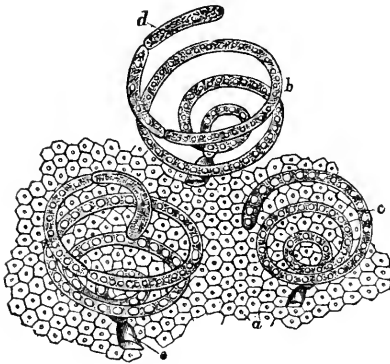

Growth of *Enterobryus spiralis* from mucous membrane of stomach of *Iulus*:—*a*, epithelial cells of mucous membrane; *b*, spiral thallus of *Enterobryus*; *c*, primary cell; *d*, secondary cell.

formed by the projection of the fungus itself. The Chinese species is valued as a medicinal drug.

266. The Stomachs and Intestines of many Worms and Insects are invested with Entophytic Fungi, which grow there with great luxuriance. In the accompanying illustrations (Figs. 168, 169) are shown some of the forms of the *Enterobryus*,* which has been found by Dr. Leidy† to be so constantly present in the stomach of certain species of *Iulus* (gally-worm), that it is extremely rare to meet

* This plant, also, has much affinity to Algæ in its general type of structure, and is referred to that group by many Botanists; but the conditions of its growth, as in the case of *Sarcina*, seem rather to indicate its affinity to the Fungi; and until its proper fructification shall have been made out, its true place in the scale must be considered as undetermined.

† "Smithsonian Contributions to Knowledge," Vol. v.

with individuals whose stomachs do *not* contain it. The Enterobryus originally consists of a single long tubular cell, which sometimes grows in a spiral mode (Fig. 168), sometimes straight and tapering (Fig. 169, A). In its young state the cell contains a transparent protoplasm, with granules and globules of various sizes; but in its more advanced condition the tube of the filament is occupied by cells in various stages of development; these distend the terminal part of the cell (Fig. 169, B), and press so much against each other that their walls become flattened; whilst nearer the middle of the same filament (c) we find them retaining their rounded form, and merely lying in contact with each other; and at the base (D), they lie detached in the midst of the granular protoplasm. In *E. spiralis* the primary cells (Fig. 168, *b, c*) very commonly have secondary and even ternary cells (*d*) developed at their extremities; but this is rarely seen in *E. attenuatus* (Fig. 169). It may be considered as next to certain that the tubular filaments rupture, when the contained cells have arrived at maturity, and give them exit; and that these cells are developed, under favourable circumstances, into tubular filaments like those from which they sprang; but the process has not yet been thoroughly made-out. This is obviously not the true Generation of the plant, but is analogous to the development of Zoospores

FIG. 169.

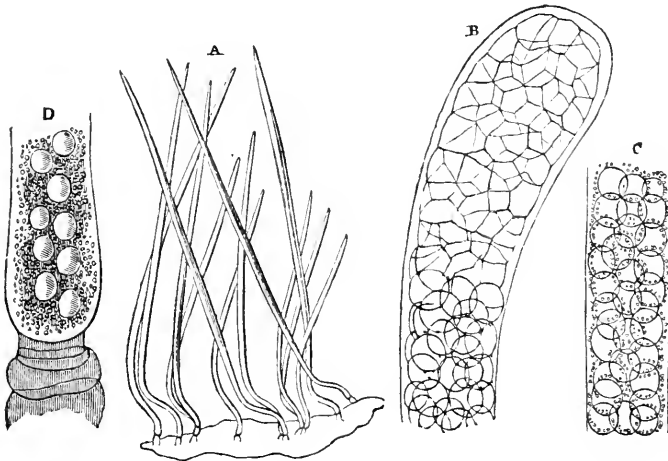

Structure of *Enterobryus*:—A, growth of *E. attenuatus*, from mucous membrane of stomach of *Passulus*; B, dilated extremity of primary cell of *E. elegans*, filled with secondary cells, which, near its termination, become mutually flattened by pressure; C, lower portion of the same filament, containing cells mingled with granules; D, base of the same filament, containing globules interspersed among granules.

in *Achlya* (§ 247). It is not a little curious, moreover, that the Entozoa or Parasitic Worms infesting the alimentary canal of these animals should be frequently clothed *externally* with an abundant growth of such Plants : in one instance Dr. Leidy found an *Ascaris* bearing twenty-three filaments of *Enterobryus*, "which appeared to cause no inconvenience to the animal, as it moved and wriggled about with all the ordinary activity of the species." The presence of this kind of Vegetation seems to be related to the peculiar food of the Animals in whose stomachs it is found ; for Dr. Leidy could not discover a trace of these or of any other parasitic Plants in the alimentary canal of the *carnivorous* Myriapods which he examined ; whilst he met with a constant and most extraordinary profusion of Vegetation (Fig. 170) in the stomach of a *herbivorous* Beetle, the *Passulus cornutus*, which lives, like the Iuli, in stumps of old trees, and feeds as they do on decaying wood. Of this vegetation some parts present themselves in tolerably definite forms, which have been described under various names ; whilst other portions have the indefiniteness of imperfectly-developed organisms, and can scarcely be characterized in the present state of our knowledge of them. With regard to several forms, indeed, Dr. Leidy expresses a doubt whether they are Parasitic Plants, or whether they are out-growths of the membrane itself.

267. There are various diseased conditions of the Human Skin and Mucous membranes, in which there is a combination of Fungoid Vegetation and morbid growth of the Animal tissues : this is the case, for example, with the *Tinea favosa*, a disease of the scalp, in which yellow crusts are formed that consist almost entirely of the mycelium, receptacles, and sporules of a fungus ; and the like is true also of those white patches (*Aphthæ*) on the lining membrane of the mouth of infants, which are known as *Thrush*, and of the exudations of 'false membrane' in the disease termed *Diphtheria*.* In these and similar cases, two opinions are entertained as to the relation of the Fungi to the Diseases in which they present themselves ; some maintaining that their presence is the essential condition of these diseases, which originate in the introduction of the Vegetable germs ; and others considering their presence to be secondary to some morbid alteration of the parts wherein the fungi appear, which alteration favours their development. The first of these doctrines derives a strong support from the fact, that the diseases in question may be communicated to healthy individuals, through the introduction of the germs of the Fungi by inoculation ; whilst the second is rather consistent with general analogy, and especially with what is known of the conditions under which the various kinds of fungoid 'Blights' develop themselves in or upon growing Plants (§ 270).—It is not a little remarkable

* Nearly allied to these is the form of Vegetation recently observed on many specimens of imported Hair, and wrongly described as a Gregariniform parasite. See Dr. Tilbury Fox in "Science Gossip," May, 1867.

that even Shells, Fish-scales, and other hard tissues of Animals, are not unfrequently penetrated by Fungous Vegetation, which usually presents itself in the form of simple tubes more or less

FIG. 170.

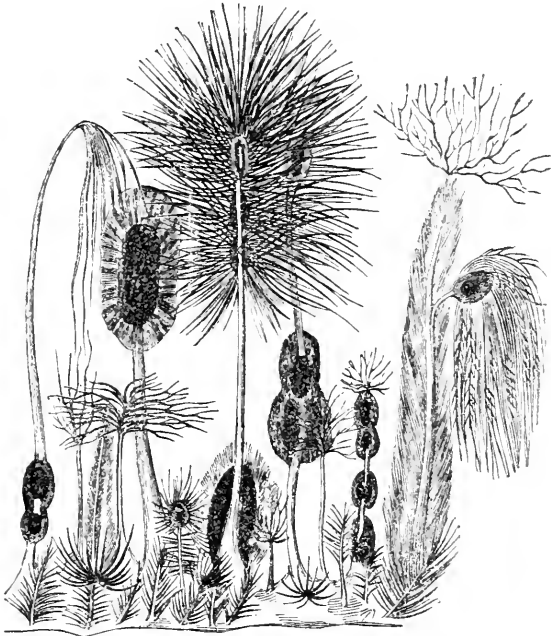

Fungoid Vegetation, clothing membrane of stomach of *Passulus*, intermingled with brush-like hairs.

FIG. 171.

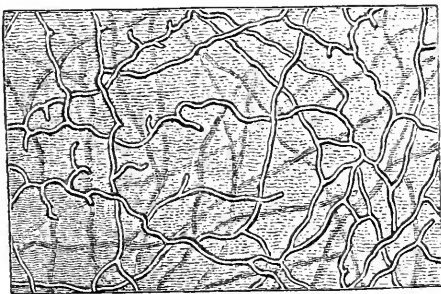

Shell of *Anomia* penetrated by Parasitic Fungus.

regularly disposed (Fig. 171), and closely resembling those of an ordinary *mycelium* (compare Fig. 175, a), but occasionally exhibits a distinct Fructification that enables its true character to be recognized.*

268. There are scarcely any Microscopic objects more beautiful than some of those forms of 'Mould' or 'Mildew,' which are so commonly found growing upon the surface of jams and other preserves; especially when they are viewed with a low magnifying power, by reflected light. For they present themselves as a forest of stems and branches, of extremely varied and elegant forms, (Fig. 172), loaded with fruit of a singular delicacy of conformation, all glistening brightly on a dark ground. In removing a portion of the 'Mould' from the surface whereon it grows, for the purpose of microscopic examination, it is desirable to disturb it no more than can be helped, in order that it may be seen as nearly as possible in its natural condition; and it is therefore preferable to take up a portion of the Membrane-like substance whereon it usually rests, which is, in fact, a *Mycelium* composed of interlacing filaments of the *Vegetative* part of the plant, the Stems and branches being its *Reproductive* portion (§ 271). The universality of the appearance of these simple forms of Fungi upon all spots

favourable to their development has given rise to the belief that they are spontaneously produced by decaying substances: but there is no occasion for this mode of accounting for it; since the extraordinary means adopted by Nature for the production and diffusion of the germs of these plants adequately suffices to explain the facts of the case. The number of sporules which any one Fungus may develop, is almost incalculable; a single individual of the puff-ball tribe has been computed to send forth no fewer than ten millions. And their minuteness is such that they are scattered through the air in the condition of the finest possible dust; so that it is difficult to conceive of a place from which they should be excluded.

FIG. 172.

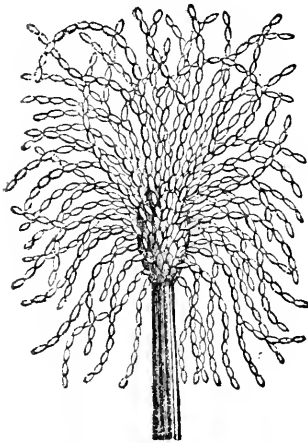

Stysanus caput-medusae.

* See Prof. Kölliker 'On the frequent Occurrence of Vegetable Parasites in the Hard Tissues of Animals,' in "Quart. Journ. of Microsc. Science," Vol. viii., 1860, p. 171.—The Author feels it due to himself to state that previously to the publication of his friend Prof. K.'s paper, he had himself arrived at a similar conclusion in regard to the parasitic nature of many of the Tubular structures which had been originally regarded not merely by himself, but by Prof. Kölliker, as proper to the Shells in which they occur.

This mode of explanation has received further confirmation from the facts recently ascertained, in regard to the great number of forms under which a single germ may develop itself. For it has been ascertained, with regard to the Fungi generally, that different individuals of the very same species may not only develop themselves according to a great number of very dissimilar modes of growth, but that they may even bear very dissimilar types of Fructification; and further, that even the same individual may put forth, at different periods of its life, those two kinds of fructification—the *Basidio-sporous*, in which the spores are developed by outgrowth from free points (*Basidia*), and the *Theca-sporous*, in which they are developed in the interior of cases (*Theca* or *Asci*, Fig. 173)—which had been previously considered as separately characterizing the two principal groups into which the Class is primarily divided.

269. Attention has lately been called by Dr. de Bary to the very curious phenomena presented by certain members of the group of *Myxogastric* Fungi, which are parasitic upon decaying wood, bark, heaps of decaying leaves, tan-beds, &c.; the *Ethalium septicum*, to which his observations specially relate, being very common in the last-named situation. When the Spores of this Plant are placed in water, and are protected from evaporation, their external envelopes rupture, and their contents escape in the condition of cells invested only by a very thin primordial utricle; each of which comes to possess, after several changes of form, one or two cilia, by which it executes movements of progression and rotation, and two or three vacuoles, of which one at least always pulsates. After a few days these lose their cilia, acquire a larger size with more numerous and less regular vacuoles, and move in a creeping manner by the protrusion of parts of the body, which continually changes its form; thus resembling an *Amœba* (Fig. 234) in all essential particulars. The next stage consists in the enormous extension of contractile protoplasmic threads, which form a sort of *Mycelium* that eventually gives origin to the fructification: whether each of these groups of threads—which bears a strong resemblance, except in its far larger size, to the sarcode network put forth by Rhizopods (Fig. 232)—originates in a single Amœbiform body, or is formed by the coalescence of several, is not yet certainly ascertained. Now this protoplasmic substance is found to contain foreign particles, such as cells of Algæ, sporules of Fungi, &c., in its interior; and it was originally urged by De Bary that the particles thus taken-in serve, as in the case of the Rhizopods, for food, and that the Myxogastres, in this stage of their existence, are to be accounted Animals, and may claim the designation *Mycetozoa*. There is no sufficient evidence, however, that such is their true character; and taking for granted the general truthfulness of the account just given, all that it can be fairly considered to prove is, that the actively-moving Animalcule-like 'Zoospore' which is the first pro-

duction of the spore, undergoes a change in its condition similar to that already described, in the cells of *Volvox* (§ 198), and that the Protoplasmic substance of the Amœboid body thus formed extends itself into diverging threads in a manner that strongly reminds us of the sarcode network of the Rhizopods. That such a resemblance should exist can scarcely be considered surprising, when it is borne in mind that the Vegetable *protoplasm* and the Animal *sarcode* are essentially identical substances; and that not merely the network of inosculating threads of *Gromia* (Fig. 232), but the circulation of particles constantly kept up in it, has its parallel in the network of viscid Protoplasm which may be traced on the internal wall of many Vegetable Cells (§§ 287-289), and which exhibits the like continual movement of its constituent particles. Thus, then, it may be considered that the observations of De Bary tend to confirm those of Drs. Hartig and Hicks (§ 255, *note*) in regard to the Amœboid form which may be assumed by certain undoubtedly Vegetable products; whilst if themselves interpreted by the light of those phenomena, and by the undoubtedly Fungous nature of the fructification of the *Myxogastres*, they indicate nothing more than that the tribe in question affords a most remarkable example of the same metamorphosis.*

270. The parasitic Fungi which infest some of the Vegetables

FIG. 173.



Puccinia graminis.

most important to Man as furnishing his staple articles of food, constitute a group of special interest to the Microscopist; of which a few of the chief examples may here be noticed. The *Mildew* which is often found attacking the straw of Wheat, shows itself externally in the form of circular clusters of pear-shaped Spore-cases (Fig. 173), each containing two compartments filled with sporules; these (known as the *Puccinia graminis*) arise from a filamentous tissue constituting its *mycelium*, the threads of which interweave themselves with the tissue of the straw; and they generally make their way to the surface through

* Dr. De Bary's latest views on this subject, which are in accordance with what is stated above, will be found in his contribution to Prof. Hofmeister's "Handbuch der Physiologischen Botanik," Band ii. p. 295.

the 'stomata' or breathing-pores of its epidermis. The *Rust*, which makes its appearance on the leaves and chaff-scales of Wheat, has a fructification that seems essentially distinct from that just described, consisting of oval spore-cases, which grow without any regularity of arrangement from the threads of the mycelium ; and hence it has been considered to belong to a different genus and species, *Uredo rubigo*. But from the observations of Prof. Henslow, it seems certain that the Rust is only an earlier form of the Mildew ; the one form being capable of development into the other, and the fructification characteristic of the two supposed genera having been evolved on one and the same individual. Another reputed species of *Uredo* (the *U. segetum*) it is which, when it attacks the flower of the Wheat, reducing the ears to black masses of sooty powder, is known as *Smut* or *Dust-brand*. The Corn-grains are entirely replaced by aggregations of spores ; and these, being of extreme minuteness, are very easily and very extensively diffused. The *Bunt* or *Stinking Rust* is another species of *Uredo* (the *U. fatida*), which is chiefly distinguished by its disgusting odour. The prevalence of these Blights to any considerable extent seems generally traceable to some seasonal influences unfavourable to the healthy development of the Wheat-plant ; but they often make their appearance in particular localities through careless cultivation, or want of due precaution in the selection of seed. It may be considered as certain that an admixture of the spores of any of these Fungi with the grains will endanger the plants raised from them ; but it is equally certain that the fungi have little tendency to develop themselves in plants that are vegetating with perfect healthfulness. The wide prevalence of such blights in bad seasons is not difficult to account for, if it be true (as the observations of Mr. John Marshall a few years since rendered probable) that there are really *very few* Wheat-grains, near the points of which one or two sporules of Fungi may not be found, entangled among their minute hairs ; and it may be fairly surmised that these germs remain dormant, unless an unfavourable season should favour their development by inducing an unhealthy condition of the wheat-plant.—The same general doctrine probably applies to the *Botrytis*, which, from 1847 to the present time, has had a large share in the production of the 'Potato-disease ;' and to the *Oidium*, which has a like relation to the 'Vine-disease' that was prevalent for some years through the south of Europe. There seems no doubt that, in the fully-developed disease, the Fungus is always present ; and that its growth and multiplication have a large share in the increase and extension of the disorder, just as the growth of the Yeast-plant excites and accelerates fermentation, while its reproduction enables this action to be indefinitely extended through its instrumentality. But just as the Yeast-plant will not vegetate save in a fermentible fluid—that is, in a solution which, in addition to Sugar, contains some decom-

posable Albuminous matter,—so does it seem probable, on a consideration of all the phenomena of the Potato and Vine-diseases, that neither the *Botrytis* of the one nor the *Oidium* of the other will vegetate in perfectly healthy plants; but that a disordered condition, induced either by forcing and therefore unnatural systems of cultivation, or by unfavourable seasons, or by a combination of both, is necessary as a 'predisposing' condition.

271. In those lower forms of this Class to which our notice of it has hitherto been chiefly restricted, there is not any very complete

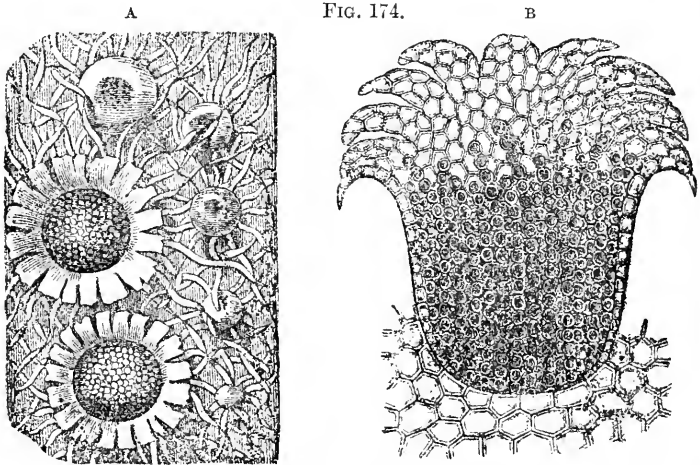

Æcidium tussilaginis:—A, portion of the plant magnified; B, section of one of the conceptacles with its spores.

separation between the Nutritive or vegetative and the Reproductive portions; every cell, as in the simplest Protophytes, being equally concerned in both. But such a separation makes itself apparent

FIG. 175.

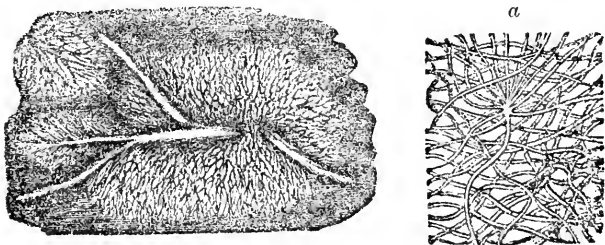

Clavaria crispula:—a, portion of the mycelium magnified.

in the higher; and this in a very curious mode. For the ostensible Fungi of almost every description (Fig. 174) consist, in fact, of

nothing else than the organs of *Fructification*; the *nutritive* apparatus of these plants being composed of an indefinite *Mycelium*, which is a filamentous expansion (Fig. 175) composed of elongated branching cells (*a*), interlacing amongst each other, but having no intimate connection; and this has such an indefiniteness of form, and varies so little in the different tribes of Fungi, that no determination of species, genus, or even family, could be certainly made from it alone. From the recent researches of Prof. Oersted upon *Agaricus variabilis*, it appears that the true Generative process in the Agarics and their allies is carried-on in this *mycelium*; and that what has hitherto been considered as their Fructification is really a mass of *gemmæ*, like the Urns of *Mosses* and the Thecæ of *Ferns*, which, as will be shown hereafter, are products of the Sexual union which takes place in the earlier stages of the existence of those plants. This, if confirmed, will prove a most important discovery.*—The whole history of the development of the Fungi, and the question of the relationship of its different forms to each other, is one that most urgently calls for re-examination at the present time, under the guidance of our recently-acquired knowledge, and with the assistance of improved instruments of Microscopic investigation; and whilst there is a wide field for the labours of those who possess instruments of but moderate capacity, there are several questions which can only be worked out by means of the highest powers and the most careful appliances which the practised Microscopist can bring to bear upon them.†

272. The little group of *Hepaticæ* or 'Liverworts,' which is intermediate between Lichens and Mosses—rather agreeing with the former in its general mode of growth, whilst approaching the latter in its Fructification—presents numerous objects of great interest to the Microscopist; and no species is richer in these than the very common *Marchantia polymorpha*, which may often be found growing between the paving-stones of damp court-yards, but which particularly luxu-

FIG. 176.



Frond of *Marchantia polymorpha*, with gemmiparous Conceptacles, and lobed receptacles bearing Pistillidia.

* See "Quart. Journ. of Microsc. Science," Vol. viii., N.S. (1868), p. 18.

† For an example of what has to be done in this direction, see the magnificent work of MM. Tulasne, entitled "Selecta Fungorum Carpo-logia," Paris, 1861.

riates in the neighbourhood of springs or waterfalls, where its lobed fronds are found covering extensive surfaces of moist rock or soil, adhering by the radical (root) filaments which arise from their lower surface. At the period of fructification these fronds send up stalks, which carry at their summits either round shield-like disks, or radiating bodies that bear some resemblance to a wheel without its tire (Fig. 176) : the former carry the male organs, or *Antheridia* ; while the latter in the first instance bear the female organs, or *Archegonia*, which afterwards

FIG. 177.

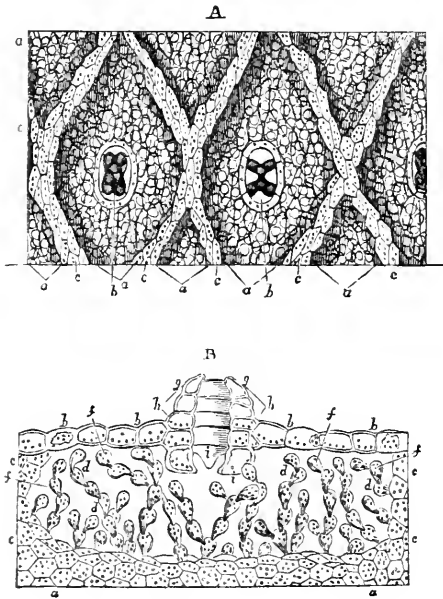

Marchantia polymorpha.—A, portion of frond seen from above; *a, a*, lozenge-shaped divisions; *b, b*, stomata seen in the centre of the lozenges; *c, c*, greenish bands separating the lozenges :—B, vertical section of the frond, showing *a, a*, the dense layer of cellular tissue forming the floor of the cavity *d, d*; the cuticular layer, *b, b*, forming its roof; *c, c*, its walls; *f, f*, loose cells in its interior; *g*, stoma divided perpendicularly; *h*, rings of cells forming its wall; *i*, cells forming the obturator ring.

* In some species, the same shields bear both sets of organs; and in *Marchantia androgyna* we find the upper surface of one half of the pelta developing *Antheridia*, whilst the under surface of the other half bears *Archegonia*.

give place to the *Sporangia* or Spore-cases.* But besides these, the frond usually bears upon its surface (as shown in Fig. 176) a number of little open basket-shaped 'conceptacles,' whose nature and purpose will be presently explained. The green surface of the frond of this Liverwort is seen under a low magnifying power to be divided into minute diamond shaped spaces (Fig. 177, A, *a, a*) bounded by raised bands (*c, c*); every one of these spaces has in its centre a curious brownish - coloured body (*b, b*), with an opening in its middle, which allows a few small green cells to be seen through it. When a thin vertical section is made of the frond (B), it is seen that each of the lozenge-shaped divisions of its surface

corresponds with an air-chamber in its interior, which is bounded below by a floor (*a, a*) of closely-set cells (from whose under surface the radical filaments arise); at the sides by walls (*c, c*) of similar solid parenchyma, the projection of whose summits forms the raised bands on the surface; and above by a cuticle (*b, b*) formed of a single layer of cells; whilst its interior is occupied by a very loosely arranged parenchyma, composed of branching rows of cells (*f, f*) that seem to spring from the floor,—these cells being what are seen from above, when the observer looks down through the central aperture just mentioned. If the vertical section should happen to traverse one of the peculiar bodies which occupies the centres of the divisions, it will bring into view a structure of remarkable complexity. Each of these *Stomata* (as they are termed, from the Greek *στομα*, mouth) forms a sort of shaft (*g*), composed of four or five rings (like the ‘courses’ of bricks in a chimney) placed one upon the other (*h*), every ring being made up of four or five cells; and the lowest of these rings (*i*) appears to regulate the aperture, by the contraction or expansion of the cells which compose it, and it is hence termed the ‘obturator ring.’ In this manner each of the air-chambers of the frond is brought into communication with the external atmosphere, the degree of that communication being regulated by the limitation of the aperture. We shall hereafter find (§ 314) that the leaves of the higher Plants contain intercellular spaces, which also communicate with the exterior by *Stomata*; but that the structure of these organs is far less complex in them than it is in this humble Liverwort.

273. The basket-shaped *Conceptacles* which are borne upon the surface of the frond (Fig. 178, A), and which may often be found in all stages of development, are structures of singular beauty. They contain, when mature, a number of little green round or oblong disks, each composed of two or more layers of cells; and their wall is surmounted by a glistening fringe of ‘teeth,’ whose edges are themselves regularly fringed with minute out-growths. This fringe is at first formed by the splitting-up of the epidermis, as seen at B, at the time when the conceptacle and its contents are first making their way above the surface. The little disks (sometimes termed ‘Bulbels,’ from their analogy to the bulbels or detached buds of Flowering Plants) are at first evolved as single globular cells, supported upon other cells which form their footstalks; these single cells gradually undergo multiplication by duplicative subdivision, until they evolve themselves into the disks; and these disks, when mature, spontaneously detach themselves from their footstalks, and lie free within the cavity of the conceptacle. Most commonly they are at last washed out by rain, and are thus carried to different parts of the neighbouring soil, on which they grow very rapidly when well supplied with moisture; sometimes, however, they may be found growing whilst still con-

tained within the conceptacles, forming natural grafts (so to speak) upon the stock from which they have been developed and detached ; and many of the irregular lobes which the frond of the *Marchantia*

FIG. 178.

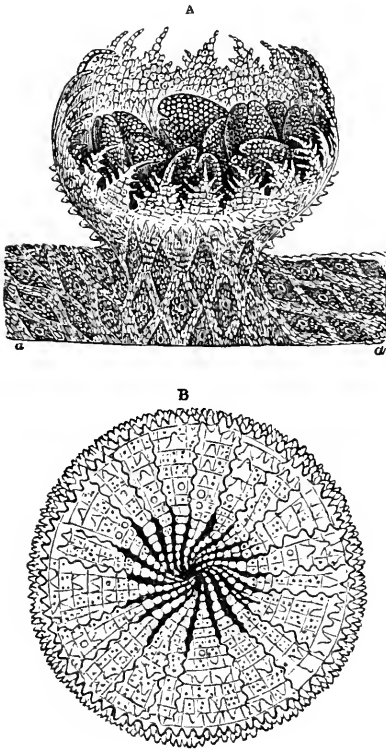

Gemmiparous Conceptacles of *Marchantia polymorpha*:—A, conceptacle fully expanded, rising from the surface of the frond *a, a*, and containing disks already detached:—B, first appearance of conceptacle on the surface of the frond, showing the formation of its fringe by the splitting of the cuticle.

puts forth, seem to have this origin. The very curious observation was long ago made by Mirbel, who carefully watched the development of these *gemmae*, that stomata are formed on the side which happens to be exposed to the light, and that root-fibres are put forth from the lower side ; it being apparently a matter of indifference *which* side of the little disk is at first turned upwards, since each has the power of developing either stomata or root-fibres according to the influence it receives. After the tendency to the formation of these organs has once been given, however, by the sufficiently prolonged influence of light upon one side and of darkness and moisture on the other, any attempt to alter it is found to be vain ; for if the surfaces of the young fronds be then inverted, a twisting growth soon restores them to their original aspect.

274. When this Plant vegetates in damp shady situations which are favourable to the nutritive processes, it does not readily produce the true Fructification, which is to be looked for rather in plants growing in more exposed places. Each of the stalked peltate (shield-like) disks contains a number of flask-shaped cavities opening upon its upper surface, which are brought into view by a vertical section ; and in each of these cavities is lodged an

Antheridium, composed of a mass of Sperm-cells, within which are developed Antherozoids like those of *Chara* (§ 255), and surmounted by a long neck that projects through the mouth of the flask shaped cavity. The wheel-like receptacles (Fig. 176), on the other hand, bear on their under surface, at an early stage, concealed between membranes that connect the origins of the lobes with one another, a set of *Archegonia*, shaped like flasks with elongated necks (Fig. 179); each of these has in its interior a Germ-cell, to which a canal leads down from the extremity of the neck; and there is every reason to believe that, as in Ferns, the germ-cell is fertilized by the penetration of the Antherozoids through this canal until they reach it.

FIG. 179.

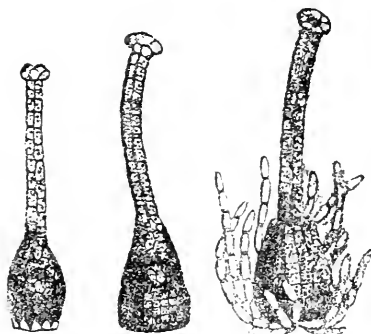

Archegonia of *Marchantia polymorpha*, in successive stages of development.

Instead, however, of at once evolving itself into a new plant resembling its parent, the fertilized germ-cell or Embryo-Cell develops itself into a mass of cells enclosed within a capsule, which is termed a Sporangium; and thus the mature receptacle, in place of Archegonia, bears capsules or Sporangia, which finally burst open and discharge their contents. These contents consist of *Spores*, which are isolated cells enclosed in firm yellow envelopes; and of *Elaters*, which are ovoidal cells, each containing a double spiral fibre coiled up in its interior. This fibre is so elastic that, when the surrounding pressure is withdrawn by the bursting of the Sporangium, the spires extend themselves (Fig. 180), tearing apart the cell-membrane; and they do this so suddenly as to jerk forth the spores which may be adherent to their coils, and thus to assist in their dispersion. The Spores, when subjected to moisture, with a moderate amount of light and warmth, develop themselves into little collections of cells, which gradually assume the form of a flattened Frond; and thus the species is very extensively multiplied, every one of the mass of Spores, which is the product of a single Germ-cell, being capable of giving origin to an independent individual.

275. The tribe of *Mosses* is as remarkable for the delicacy and minuteness of all the plants composing it, as other orders of the Vegetable Kingdom are for the majesty of their forms, the richness of their foliage, or the splendour of their blossoms. There is not one of this little tribe whose external organs do not serve as beautiful objects when viewed with low powers of the Microscope; while their more concealed wonders are admirably fitted for the

detailed scrutiny of the practised observer. The Mosses always possess a distinct axis of growth, commonly more or less erect, on

FIG. 180.



Elaters and Spores
of *Marchantia*.

which the minute and delicately-formed leaves are arranged with great regularity. The Stem shows some indication of the separation of a *cortical* or bark-like portion from the *medullary* or pith-like, by the intervention of a circle of bundles of elongated cells, which seem to prefigure the woody portion of the stem of higher plants, and from which prolongations pass into the leaves, so as to afford them a sort of midrib. The Leaf usually consists of either a single or a double layer of cells, having flattened sides by which they adhere one to another: they rarely present any distinct Epidermic layer; but such a layer, perforated by Stomata of simple structure, is commonly found on the *Setæ* or bristle-like footstalks bearing the fructification, and sometimes on the midribs of the leaves. The Leaf-cells of the *Sphagnum* (Bog-moss) exhibit a very curious departure from the ordinary type; for instead of being small and polygonal, they are large and elongated (Fig. 181); they contain spiral fibres loosely coiled in their interior; and their membranous walls have large rounded apertures, by which their cavities freely communicate with one another, as is sometimes curiously evidenced by the passage of Wheel-Animalcules that make their habitation in these chambers. Between these coarsely-spiral cells are some thick-walled narrow elongated cells, which give to the leaf its firmness; these, in the very young leaf (as Mr. Huxley has pointed out) do not differ much in appearance from the others; the peculiarities of both being evolved by a gradual process of 'differentiation.*' The Root-fibres of Mosses, like those of *Marchantia*, consist of long tubular cells of extreme transparence, within which the protoplasm may frequently be seen to circulate, as in the elongated cells of *Chara*;

and according to Dr. Hicks ("Quart. Journ. Microsc. Science.," N.S., Vol. ii., 1862, p. 96), it is not uncommon for portions of the

* See Mr. H.'s very important Article on 'The Cell-Theory' in the "British and Foreign Medico-Chirurgical Review," Vol. xii. (Oct. 1853), pp. 306, 307.

protoplasmic substance to pass into an Amœboid condition resembling that of the gonidia of *Volvox* (§ 198). The protoplasm first detaches itself from contact with the cell-wall, and collects itself into ovoid masses of various sizes; these gradually change their colour to red or reddish-brown, subsequently, however, becoming almost colourless; and they protrude and retract processes, exactly after the manner of *Amœbæ*, occasionally elongating themselves into an almost linear form, and travelling up and down in the interior of the tubular cells. This kind of movement was observed by Dr. Hicks to subside gradually, the masses of protoplasm then returning to their ovoid form; but their exterior subsequently became invested with minute cilia, by which they were kept in constant agitation within their containing cells. As to their subsequent history, we are at present entirely in the dark; and the verification and extension of Dr. Hicks's observations constitute an object well worthy of the attention of Microscopists.

276. The chief interest of the Mosses to the Microscopist, however, lies in their Fructification, which recent discoveries have invested with a new character. What has been commonly regarded in that light—namely, the Capsule or Urn, borne at the top of a long footstalk, which springs from the centre of a cluster of leaves (Fig. 182, A)—is not the real fructification, but its product; for Mosses, like Liverworts, possess both *Antheridia* and *Pistillidia*, although these are by no means conspicuous. These organs are sometimes found in the same envelope (or Perigone), sometimes on different parts of the same plant, sometimes only on different individuals; but in either case they are usually situated close to the axis, among the bases of the leaves. The *Antheridia* are globular, oval, or elongated bodies (Fig. 183, A), composed of aggregations of cells, of which the exterior form a sort of capsule, whilst the interior are Sperm-cells, each of which, as it comes to

FIG. 181.

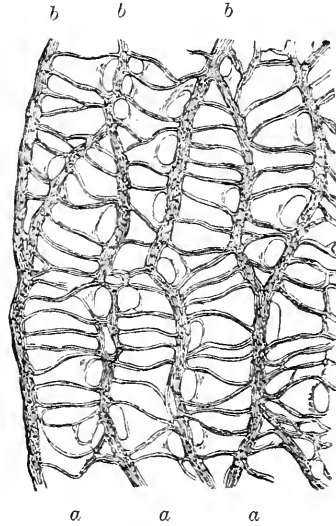

Portion of the leaf of *Sphagnum*: showing the large cells, *a, a, a*, with spiral fibres and communicating apertures; and the intervening bands, *b, b, b*, composed of small elongated cells.

maturity, develops within itself an Antherozoid (B, c, D); and the Antherozoids, set free by the rupture of the cells within which

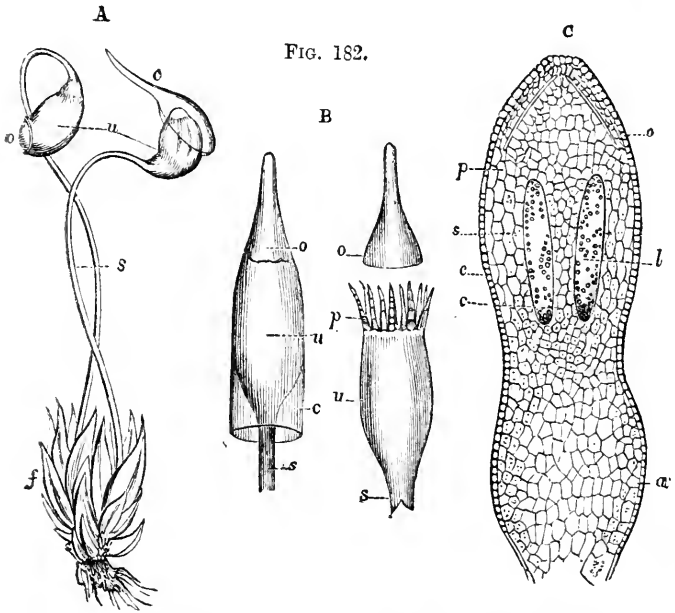

Structure of Mosses :—A, Plant of *Funaria hygrometrica*, showing *f* the Leaves, *u* the Urns supported upon the *Setæ* or footstalks *s*, closed by the Operculum *o*, and covered by the Calyptra *c* :—B, Urns of *Encalypta vulgaris*, one of them closed and covered with the Calyptra, the other open; *u, u*, the Urns; *o, o*, the Opercula; *c*, Calyptra; *p*, Peristome; *s, s*, *Setæ* :—C, longitudinal section of very young Urn of *Splachnum*; *a*, solid tissue forming the lower part of the capsule; *c*, Columella; *l*, loculus or space around it for the development of the spores; *e*, Epidermic layer of cells, thickened at the top to form the Operculum *o*; *p*, two intermediate layers, from which the Peristome will be formed; *s*, inner layer of cells forming the wall of the loculus.

they are formed, make their escape by a passage that opens for them at the summit of the antheridium. The Antheridia are generally surrounded by a cluster of hair-like filaments, composed of cells joined together (Fig. 183, A), and called *Paraphyses*; these seem to be 'sterile' or undeveloped Antheridia. The Archegonia bear a general resemblance to those of *Marchantia* (Fig. 179); and there is every reason to believe that the fertilization of their contained Germ-cells is accomplished in the manner already described. The fertilized Embryo-cell becomes gradually developed by cell-division into a conical body elevated upon a stalk; and this

FIG. 183.

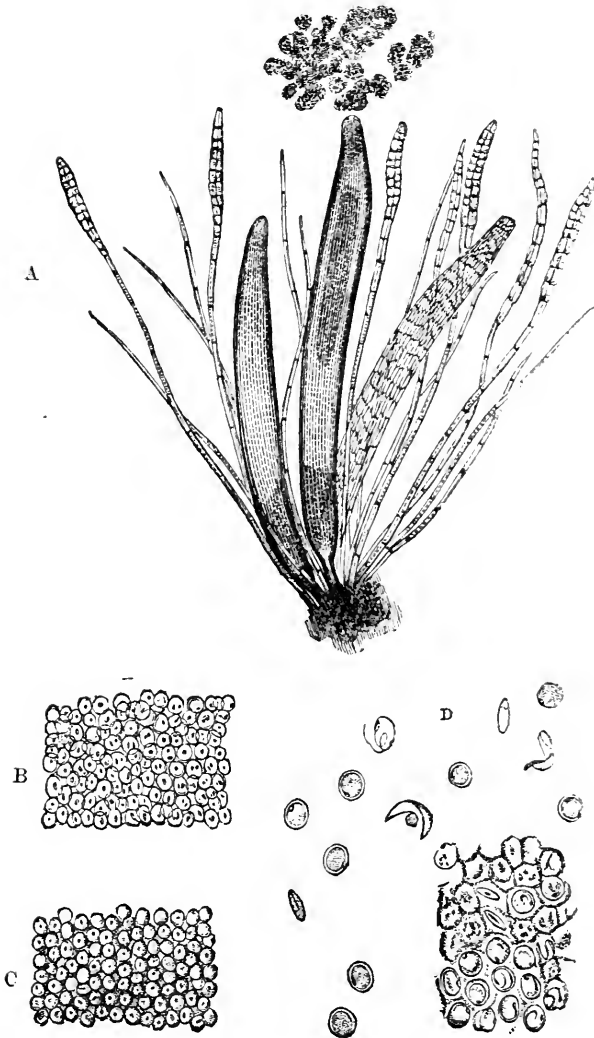

Antheridia and Antherozoids of *Polytrichum commune*.:—A, group of Antheridia, mingled with hairs and sterile filaments (paraphyses): of the three Antheridia, the central one is in the act of discharging its contents; that on the left is not yet mature; while that on the right has already emptied itself, so that the cellular structure of its walls becomes apparent;—B, cellular contents of an Antheridium, previously to the development of the Antherozoids;—C, the same, showing the first appearance of the Antherozoids;—D, the same, mature and discharging the Antherozoids.

at length tears across the walls of the flask-shaped archegonium by a circular fissure, carrying the higher part upwards as a *Calyptra*

FIG. 184.

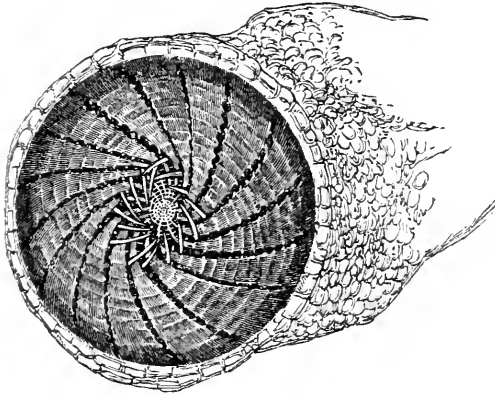

Mouth of Capsule of *Funaria*, showing the Peristome *in situ*.

or Hood (Fig. 182, B, c) upon its summit, while the lower part remains to form a kind of collar round the base of the stalk.

277. The Urns or Spore-Capsules of Mosses, which are thus the immediate product of the Generative act, and which must really be considered as the offspring of the plants that bear them (although

grafted on to these, and drawing their nourishment from them), are closed at their summit by *Opercula* or lids (Fig. 182, B, o, o), which fall off when the contents of the capsules are mature, so as to give them free exit ; and the mouth thus laid open is surrounded by a beautiful toothed fringe, which is termed the *Peristome*.

FIG. 185.

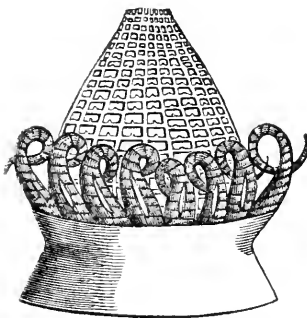

Double Peristome of *Fontinalis antipyretica*.

This fringe, as seen in its original undisturbed position, is shown in Fig. 184, and is a beautiful object for the Binoocular Microscope; it is very *hygrometric*, executing when breathed on a curious movement, which is probably concerned in the dispersion of the spores. In Figs. 185-187 are shown three different forms of Peristome, spread out and detached, illustrating the varieties which it exhibits in different genera of Mosses,—varieties whose existence and readiness of recognition render them

characters of extreme value to the systematic Botanist, whilst they furnish objects of great interest and beauty for the Microscopist. The Peristome seems always to be originally double, one layer

springing from the outer, and the other from the inner, of two layers of cells which may be distinguished in the immature capsule (Fig. 182, c, *p*); but one or other of these is frequently wanting at the time of maturity, and sometimes both are obliterated, so that there is no peristome at all.—The number of the ‘teeth’ is always a multiple of 4, varying from 4 to 64: sometimes they are prolonged into straight or twisted hairs.—The Spores are contained in the upper part of the Capsule, where they are clustered round a central pillar, which is termed the *Columella*. In the young Capsule the whole mass is nearly solid (Fig. 182, c), the space (*l*) in which the spores are developed being very small; but this gradually augments, the walls becoming more condensed; and at the time of maturity the interior of the capsule is almost entirely

FIG. 186.

Double Peristome of *Bryum intermedium*.

FIG. 187.

Double Peristome of *Cinclidium arcticum*.

occupied by the Spores, in the dispersion of which the Peristome seems in some degree to answer the same purpose as the Elaters of Hepaticæ.—The development of the Spores into new plants commences with the rupture of their outer walls and protrusion of their inner coats; and from the projecting extremity new cells are put forth by a process of out-growth, which form a sort of Confervoid filament (as in Fig. 193, c). At certain points of this filament its component cells multiply by subdivision, so as to form rounded clusters, from every one of which an independent plant may arise; so that several individuals may be evolved from a single spore. A numerous aggregation of Spores may be developed, as we have

seen, from a single Germ-cell ; so that the immediate product of each act of fertilization does not consist (as in the higher Plants) of a single Seed, that afterwards develops itself into a composite fabric, whence are put forth a multitude of leaf-buds, every one of which is capable (under favourable circumstances) of evolving itself into a complete Plant ; but divides itself at once into a mass of isolated cells (Spores), of which every one may be considered in the light of a Bud or *gemma* of the simplest possible kind, and one of the first acts of which is to put forth other buds, whereby the

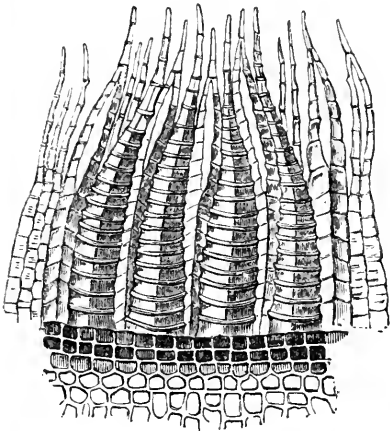
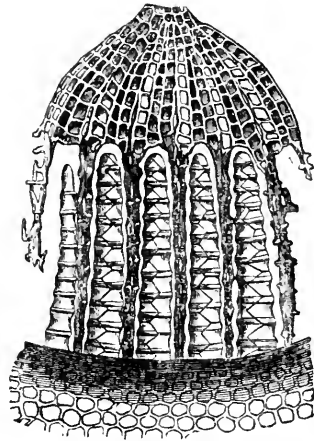
rapid extension of the Mosses is secured, although no separate individual ever attains more than a very limited size.

FIG. 188.

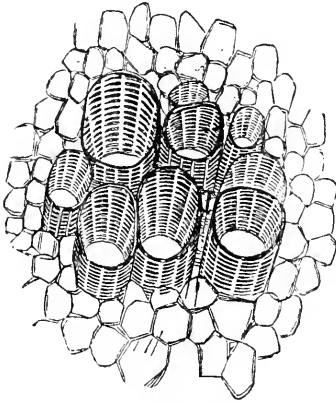

Oblique section of Footstalk of *Fern-leaf*, showing bundle of Scalariform Ducts.

278. In the *Ferns* we have in many respects a near approximation to Flowering plants ; but this approximation does not extend to their Reproductive apparatus, which is formed upon a type essentially the same as that of Mosses, though evolved at a very different period of life. As the Tissues of which their fabrics are composed are essentially the same as those to be described in the next Chapter, it will not be requisite here to dwell upon them. The

Stem (where it exists) is for the most part made up of Cellular parenchyma, which is separated into a cortical and a medullary portion by the interposition of a circular series of fibro-vascular bundles containing true Woody tissue and Ducts. These bundles form a kind of irregular network, from which prolongations are given off that pass into the Leaf-stalks, and thence into the midrib and its lateral branches ; and it is their peculiar arrangement in the leaf-stalks, which gives to the transverse section of these the figured marking commonly known as 'King Charles in the oak.' A thin section, especially if somewhat oblique (Fig. 188), displays extremely well the peculiar character of the Ducts of the Fern ; which are termed 'scalariform,' from the resemblance of the regular markings on their walls to the rungs of a ladder.

279. What is usually considered the *Fructification* of the Ferns affords a most beautiful and readily-prepared class of Opaque objects for the lowest powers of the Microscope ; nothing more being necessary than to lay a fragment of the frond that bears

it upon the Glass Stage-plate, or to hold it in the Stage-Forceps, and to throw an adequate light upon it by the Side-condenser. It usually presents itself in the form of isolated spots on the under surface of the frond, termed *Sori*, as in the common *Polypodium* (Fig. 189) and in the *Aspidium* (Fig. 190); but sometimes these 'sori' are elongated into bands, as in the common *Scolopendrum* (Hart's-tongue): and these bands may coalesce with each other, so as almost to cover the surface of the frond with a network, as in *Hæmionitis* (Fig. 190); or they may form merely a single band along its borders, as in the common *Pteris* (brake-fern). The *Sori* are sometimes 'naked' on the under surface of the fronds; but they are frequently covered with a delicate membrane termed the *Indusium*, which may either form a sort of cap upon the summit of each sorus, as in *Aspidium* (Fig. 191), or a long fold, as in *Scolopendrum* and *Pteris*; or a sort of cup, as in *Deparia* (Fig. 192). Each of these sori, when sufficiently magnified, is found to be made up of a multitude of Capsules or *Thecæ* (Figs. 191, 192), which are sometimes closely attached to the surface of the frond, but more commonly spring from it by a pedicle or footstalk. The wall of the *Theca* is composed of flattened cells, applied to each other by their edges; but there is generally one row of these thicker and larger than the rest, which springs from the pedicle, and is continued over the summit of the capsule, so as to form a projecting Ring, which is known as the *Annulus*. This Ring has an elasticity superior to that of all the rest of the capsular wall, causing it to split across when mature, so that the contained spores may escape; and in many instances carrying the two halves of the Capsule widely apart from each other (Fig. 192), the fissure extending to such a depth as to separate them completely. It will frequently happen that specimens of Fern-fructification gathered for the Microscope will be found to have all the Capsules burst and the Spores dispersed, whilst in others less advanced the Capsules may all be closed; others, however, may often be met with in which some of the Capsules are closed and others are open; and

FIG. 189.

Leaflet of *Polypodium*,
with Sori.

FIG. 190.

Portion of Frond of *Hemionitis*, with Sori.

FIG. 191.

Sorus and Indusium of *Aspidium*.

FIG. 192.

Sorus and cup-shaped Indusium of
Deparia prolifera.

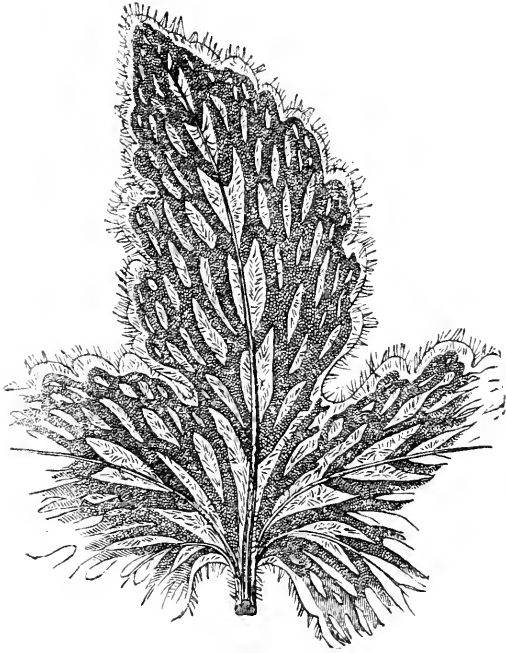
if these be watched with sufficient attention, the rupture of some of the Thecae and the dispersion of the Spores may be observed to take place whilst the specimen is under observation in the field of the Microscope. In Sori whose capsules have all burst, the Annuli connecting their two halves are the most conspicuous objects, looking, when a strong light is thrown upon them, like strongly-banded worms of a bright brown hue. This is particularly the case in *Scolopendrum*, whose elongated Sori are remarkably beautiful objects for the Microscope in all their stages; until quite mature, however, they need to be brought into view by turning back the two Indusial folds that cover them. The commonest Ferns, indeed, which are found in almost every hedge, furnish objects of no less beauty than those yielded by the rarest exotics; and it is in every respect a most valuable training to the young, to teach them how much there may be found to interest, when looked for with intelligent eyes, even in the most familiar, and therefore disregarded, specimens of Nature's handiwork.

280. The Spores (Fig. 193, A) set free by the bursting of the

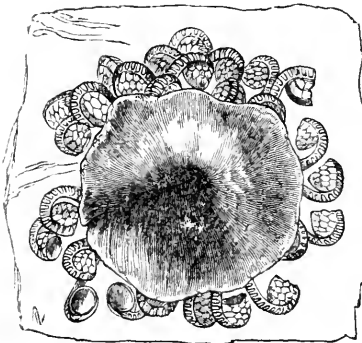
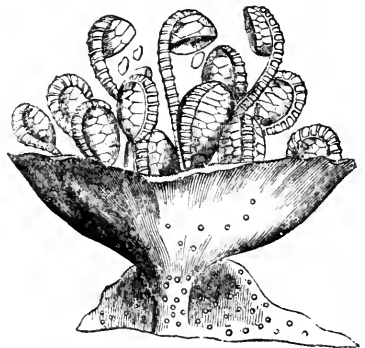
FIG. 193.

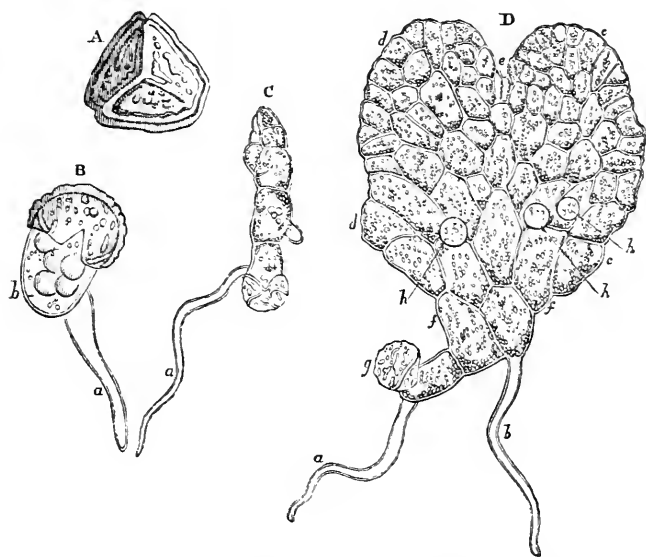

Development of Prothallium of *Pteris serrulata*:—A, Spore set free from the theca;—B, Spore beginning to germinate, putting forth the tubular prolongation *a* from the principal cell *b*;—C, first-formed linear series of cells;—D, Prothallium taking the form of a leaf-like expansion; *a* first, and *b* second radical fibre; *c*, *d*, the two lobes, and *e* the indentation between them; *f*, *f*, first-formed part of the Prothallium; *g*, external coat of the original Spore; *h*, *h*, Antheridia.

Thecæ, usually have a somewhat angular form, and are invested by a yellowish or brownish outer coat, which is marked very much in the manner of Pollen-grains (Fig. 230) with points, streaks, ridges, or reticulations. When placed upon a damp surface, and exposed to a sufficiency of light and warmth, the Spore begins to 'germinate,' the first indication of its vegetative activity being a slight enlargement, which is manifested in the rounding-off of its angles; this is followed by the putting-forth of a tubular prolongation (*B, a*) of the internal cell-wall through an aperture in the outer spore-coat; and by the absorption of moisture through this root-fibre, the inner cell is so distended, that it bursts the external unyielding integument, and soon begins to elongate itself in a direction opposite to that of the root-fibre. A production of new Cells by subdivision then takes place from its growing extremity: this at first proceeds in a single series, so as to form a kind of Confervoid filament (*c*); but the multiplication of cells by subdivision soon takes place transversely as well as longitudinally, so that a flattened leaf-like expansion (*D*) is produced, so closely resembling that of a young *Marchantia* as to be readily mistaken for it. This expansion, which is termed the *Prothallium*, varies in its configuration in different species; but its essential structure always remains the same. From its under surface are developed not merely the root-fibres (*a, b*) which serve to fix it in the soil and at the same time to supply it with moisture, but also the Antheridia and Archegonia which constitute the true representatives of the essential parts of the flower of higher Plants.—Some of the *Antheridia* may be distinguished at an early period of the development of the *Prothallium* (*h, l*); and at the time of its complete evolution these bodies are seen in considerable numbers, especially about the origins of the root-fibres. Each has its origin in a peculiar protrusion that takes place from one of the cells of the *Prothallium* (Fig. 194, *A, a*): this is at first entirely filled with chlorophyll granules; but soon a peculiar free cell (*b*) is seen in its interior, filled with mucilage and colourless granules. This cell gradually becomes filled with another brood of young cells (*e*), and increases considerably in its dimensions, so as to fill the projection which encloses it: this part of the original cavity is now cut off from that of the cell of which it was an offshoot, and the Antheridium henceforth ranks as a distinct and independent organ. Each of the Sperm-cells (*B, e*) included within the antheridial cell, is seen, as it approaches maturity, to contain a spirally-coiled filament; and when they have been set free by the bursting of the antheridium, the sperm-cells themselves burst and give exit to their Antherozoids (*c*), which execute rapid movements of rotation on their axes, partly dependent on the six long cilia with which they are furnished.—The *Archegonia* are fewer in number, and are found upon a different part of the *Prothallium*. Each of them at its origin presents itself only as a slight elevation of the cellular layer

of the prothallium, within which is a large intercellular space containing a peculiar cell (the Germ-cell), and opening exter-

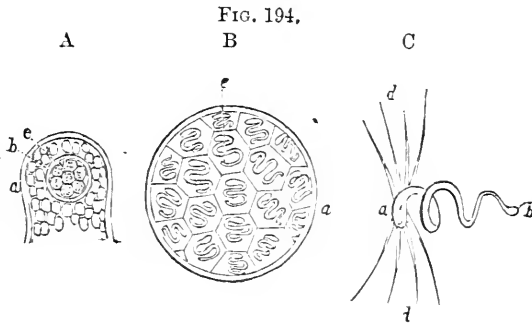

Development of the Antheridia and Antherozoids of *Pteris serrulata* :—A, projection of one of the cells of the Prothallium, showing the Antheridial cell, *b*, with its Sperm-cells, *e*, within the cavity of the original cell, *a* ;—B, Antheridium completely developed ; *a*, wall of Antheridial cell ; *e*, Sperm-cells, each enclosing an Antherozoid ;—C, one of the Antherozoids more highly magnified, showing *a*, its large extremity, *b*, its small extremity, *d*, *d*, its cilia.

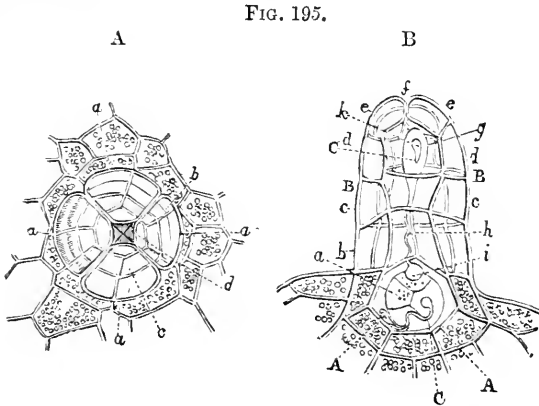

Archegonium of *Pteris serrulata* :—A, as seen from above ; *a*, *a*, *a*, cells surrounding the base of the cavity ; *b*, *c*, *d*, successive layers of cells, the highest enclosing a quadrangular orifice :—B, side view, showing A, A, cavity containing the Germ-cell, *a* ; B, B, walls of the Archegonium, made up of the four layers of cells, *b*, *c*, *d*, *e*, and having an opening, *f*, on the summit ; *c*, *c*, Antherozoids within the cavity ; *g*, large extremity ; *h*, thread-like portion ; *i*, small extremity in contact with the germ-cell, and dilated.

nally by an orifice at the summit of the projection ; but when fully developed (Fig. 195), it is composed of from ten to twelve

cells built-up in layers of four cells each, one upon another, so as to form a kind of chimney or shaft, having a central passage that leads down to the cavity at its base, wherein the Germ-cell (B, *a*) is contained. Into this cavity the Antherozoids penetrate, so as to come into contact with the Germ-cell; and, by the softening of the membrane at its apex they are even enabled to enter its cavity, within which a minute Embryonal Corpuscle was previously distinguishable. This corpuscle, when fertilized by the antherozoids which move actively round it, becomes the Primordial Cell of a new plant, the development of which speedily commences.* By the usual process of binary subdivision a globular homogeneous mass of cells is at first formed; but rudiments of special organs soon begin to make their appearance; the Germ grows at the expense of the nutriment prepared for it by the Prothallium; and it soon bursts forth from the cavity of the archegonium, which organ in the meantime is becoming atrophied. In the very beginning of its development the tendency is seen in the cells of one extremity to grow upwards, so as to evolve the Stem and Leaves, and in those of the other extremity to grow downwards to form the Root; and when these organs have been sufficiently developed to absorb and prepare the nutriment which the young

* See Hofmeister, in "Ann. of Nat. Hist.," 2nd Ser., Vol. xiv., p. 272, and his Treatise on the Higher Cryptogamia, published by the Ray Society. The study of the development of the Spores of Ferns, and of the act of Fertilization and of its products, may be conveniently prosecuted as follows:—Let a Frond of a Fern whose fructification is mature be laid upon a piece of fine paper, with its spore-bearing surface downwards; in the course of a day or two this paper will be found to be covered with a very fine brownish dust, which consists of the discharged Spores. This must be carefully collected, and should be spread upon the surface of a smoothed fragment of porous sandstone, the stone being placed in a saucer, the bottom of which is covered with water; and a glass tumbler being inverted over it, the requisite supply of moisture is ensured, and the spores will germinate luxuriantly. Some of the Prothallia soon advance beyond the rest; and at the time when the advanced ones have long ceased to produce Antheridia, and bear abundance of Archegonia, those which have remained behind in their growth are beginning to be covered with Antheridia. If the crop be now kept with little moisture for several weeks, and then suddenly watered, a large number of Antheridia and Archegonia simultaneously open; and in a few hours afterwards, the surface of the larger Prothallia will be found almost covered with moving antherozoids. Such Prothallia as exhibit freshly-opened Archegonia are now to be held by one lobe between the forefinger and thumb of the left hand, so that the upper surface of the Prothallium lies upon the thumb; and the thinnest possible sections are then to be made with a thin narrow-bladed knife, perpendicularly to its surface. Of these sections, which, after much practice, may be made no more than 1-15th of a line in thickness, some will probably lay open the canals of the Archegonia; and within these, when examined with a power of 200 or 300 diameters, Antherozoids may be occasionally distinguished. The Prothallium of the common *Osmunda regalis* will be found to afford peculiar facilities for observation of the development of the Antheridia, which are produced at its margin. (See Rev. F. Howlett in "Intellectual Observer," Vol. vii. p. 32).

Fern requires, the Prothallium, whose function as a 'nurse' is now discharged, decays away.

281. The little group of *Equisetaceæ* (Horsetails), which seem nearly allied to the Ferns in the type of their Generative apparatus, though that of their vegetative portion is very different, affords certain objects of considerable interest to the Microscopist. The whole of their structure is penetrated to such an extraordinary degree by *Silex*, that, even when its Organic portion has been destroyed by prolonged maceration in dilute nitric acid, a consistent Skeleton still remains. This mineral, in fact, constitutes in some species not less than 13 per cent. of the whole solid matter, and 50 per cent. of the inorganic ash; and it especially abounds in the Cuticle, which is used by Cabinet-makers for smoothing the surface of wood. Some of the Siliceous particles are distributed in two lines, parallel to the axis; others, however, are grouped into oval forms, connected with each other, like the jewels of a necklace, by a chain of particles forming a sort of curvilinear quadrangle; and these (which are, in fact, the particles occupying the cells of the Stomata) are arranged in pairs. Their form and arrangement are peculiarly well seen under Polarized light, for which the prepared cuticle is an extremely beautiful object; and it is asserted by Sir D. Brewster (whose authority upon this point has been generally followed), that each siliceous particle has a regular axis of double refraction. According to Prof. Bailey, however, the effect of this and similar objects (such as the Cuticles of Grasses) upon Polarized light is not produced by the siliceous particles, but by the organized tissues; since when the latter have been entirely got rid of, the residual silex shows no doubly-refracting power.* What is usually designated as the Fructification of the *Equisetaceæ* forms a cone or spike at the extremity of certain of the stem-like branches (the real stem being a horizontal rhizoma); and consists of a cluster of shield-like disks, each of which carries a circle of *Thecæ* or Spore-cases, that open by longitudinal slits to set free the spores. Each of the Spores has, attached to it, two pairs of Elastic Filaments (Fig. 196), that are originally formed as spiral fibres on the interior of the wall of the primary cell within which it is generated, and are set free by its rupture; these are at first coiled up closely around the Spore, in the manner represented at A, though more closely applied to the surface; but, on the liberation of the Spore, they extend themselves in the manner shown at B,—the slightest application of moisture, however, serving to make them close together (the assistance which they afford in the dispersion of the spores being no longer required) when the spores have alighted on a damp surface. If a number of the Spores be spread out on a slip of glass under the field of view, and, whilst the observer watches them, a by-stander breathes gently upon the glass, all the filaments will be

* See "Silliman's American Journal of Science," May, 1856.

instantaneously put in motion, thus presenting an extremely curious spectacle; and will almost as suddenly return to their previous condition when the effect of the moisture has passed off.

FIG. 196.

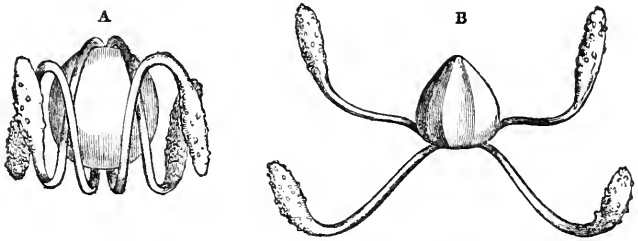
Spores of *Equisetum*, with their Elastic Filaments.

If one of the *Thecæ* which has opened, but not discharged its Spores, be mounted in a slide with a movable cover (§ 155), this curious action may be exhibited over and over again. These spores are to be regarded in the same light as those of Ferns, namely, as *Gemmæ* or rudimentary Buds, not as seeds. They evolve themselves after the like method into a Prothallium; and this develops Antheridia and Archegonia, by the conjoint action of which an Embryo is produced.

282. In ascending, as we have now done, from the Lower to the Higher Cryptogamia, we have seen a gradual change in the general plan of structure; so that the superior types present a close approximation to the Flowering Plant, which is undoubtedly the highest form of Vegetation. But we have everywhere encountered a mode of Generation, which, whilst essentially the same throughout the series, is essentially distinct from that of the Phanerogamia; the fertilizing material of the Sperm-cell being embodied, as it were, in self-moving filaments, which find their way to the Germ-cells by their own independent movements; and the Embryo-cell being destitute of that store of prepared nutriment, which surrounds it in the true Seed, and serves as the pabulum for its early development. In the Lower Cryptogamia, we have seen that the Embryo-cell, after fertilization, is thrown at once upon the world (so to speak) to get its own living; but in the Liverworts, Mosses, and Ferns, the Embryo-cell is nurtured by the parent-plant, for a period that varies in each case according to the nature of the fabric into which it evolves itself. While the true *reproduction of the species* is effected by the proper Generative act, the *multiplication of the individual* is accomplished by the production and dispersion of Spores; and this production, as we have seen, takes place at very different periods of existence in the several groups,

dividing the life of each into two separate epochs, in which it presents itself under two very distinct phases that contrast remarkably with each other. Thus, the frond of the *Marchantia*, bearing its antheridia and archegonia, is that which seems naturally to constitute *the Plant*; but that which represents this phase in the Ferns is the minute *Marchantia*-like prothallium. On the other hand, the product into which the fertilized Embryo-cell evolves itself in the Ferns, is that which is commonly regarded as *the Plant*; and this is represented in the Liverworts and Mosses by the Spore-capsule alone.*—We shall hereafter encounter a similar diversity (which has received the inappropriate designation of 'Alternation of Generations') between the two phases in the lives of *Hydrozoa*, as well as in other Invertebrate Animals. In some of the *Hydrozoa* it is the *Zoophytic* structure which constitutes what is commonly regarded as *the Animal*, the free-swimming medusoid buds by which that structure is reproduced being inconspicuous: whilst in others it is the *Medusa* or generative segment which attracts notice by its large dimensions, the earlier Polypoid stage being only recognized when carefully sought for. (See Chap. XI.)

* For more detailed information on the Structure and Classification of the Cryptogamia generally, the reader is referred to the Rev. M. J. Berkeley's "Introduction to Cryptogamic Botany;" while the most recent information on the Reproduction of the Higher Cryptogamia will be found in Prof. Hofmeister's Treatise on that subject, published by the Ray Society.

CHAPTER VIII.

OF THE MICROSCOPIC STRUCTURE OF PHANEROGAMIC PLANTS.

283. *Elementary Tissues*.—In passing from the Cryptogamic division of the Vegetable Kingdom to that larger and more ostensibly important province which includes the Flowering Plants, we do not meet with so wide a departure from those simple types of structure we have already considered, as the great differences in general aspect and external conformation might naturally lead us to expect. For a very large proportion of the fabric of even the most elaborately formed Tree is made up of components of the very same kind with those which constitute the entire organisms of the simplest Cryptogamia; and that proportion always includes the parts most actively concerned in the performance of the Vegetative functions. For although the Stems, Branches, and Roots of trees and shrubs are principally composed of *Woody* tissue, such as we do not meet with in any but the highest Cryptogamia, yet the special office of this is to afford mechanical support: when it is once formed, it takes no further share in the vital economy than to serve for the conveyance of fluid from the Roots, upwards through the Stem and Branches, to the Leaves; and even in these organs, not only the Pith and the Bark, with the ‘Medullary Rays,’ which serve to connect them, but that ‘Cambium-layer’ intervening between the bark and the wood (§ 303) in which the periodical formation of the new layers both of bark and wood takes place, are composed of *Cellular* substance. This tissue is found, in fact, wherever *growth* is taking-place; as, for example, in the Spongioles or growing-points of the Root-fibres, in the Leaf-buds and Leaves, and in the Flower-buds and sexual parts of the flower: it is only when these organs attain an advanced stage of development, that woody structure is found in them,—its purpose (as in the stem) being merely to give support to their softer textures; and the small proportion of their substance which it forms being at once seen in those beautiful Skeletons, which, by a little skill and perseverance, may be made of Leaves, Flowers, and certain Fruits. All the softer and more pulpy tissue of these organs is composed of *Cells*, more or less compactly aggregated together, and having forms that approximate more or less closely to the globular or ovoidal, which may be considered as their original type.

284. As a general rule, the rounded shape is preserved only when the Cells are but loosely aggregated, as in the Parenchymatous (or pulpy) substance of Leaves (Fig. 197), and it is then only that the distinctness of their walls becomes evident. When the tissue becomes more solid, the sides of the vesicles are pressed against each other so as to flatten them and to bring them into close apposition; and they then adhere to one another in such a manner that the partitions appear, except when carefully examined, to be single instead of double, as they really are. Frequently it

FIG. 197.

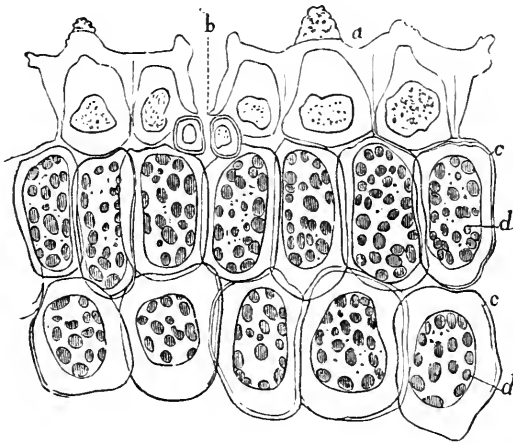

Section of Leaf of *Agave*, treated with dilute nitric acid, showing the Primordial Utricle contracted in the interior of the cells: —a, Epidermic cells; b, boundary-cells of the Stoma; c, cells of Parenchyma; d, their Primordial Utricles.

happens that the pressure is exerted more in one direction than in another, so that the form presented by the outline of the cell varies according to the direction in which the section is made. This is well shown in the Pith of the young shoots of Elder, Lilac, or other rapidly-growing trees; the cells of which, when cut transversely, generally exhibit circular outlines, whilst, when the section is made vertically, their borders are straight, so as to make them appear like cubes or elongated prisms, as in Fig. 198. A very good example of such a Cellular Parenchyma is to be found in the substance known as *Rice-paper*; which is made by cutting the herbaceous stem of a Chinese plant termed *Aralia papyrifera** vertically round and round with a long sharp knife, so that its

* The *Æschynomene*, which is sometimes named as the source of this article, is an Indian plant employed for a similar purpose.

tissue may be (as it were) unrolled in a sheet. The shape of the Cells, as seen in the 'rice-paper' thus prepared, is irregularly prismatic, as shown in Fig. 198, B; but if the stem be cut transversely, their outlines are seen to be circular or nearly so (A). When, as often happens, the Cells have a very elongated form, this

FIG. 198.

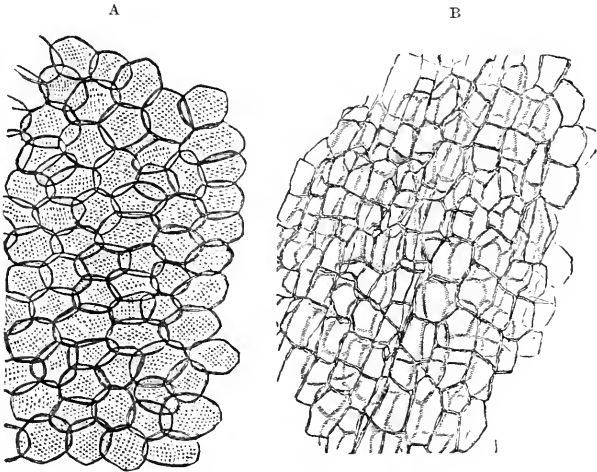

Sections of Cellular Parenchyma of *Aralia*, or Rice-paper plant:—A, transversely to the axis of the stem; B, in the direction of the axis.

elongation is in the direction of their growth, which is that, of course, wherein there is least resistance. Hence their greatest length is nearly always in the direction of the Axis; but there is one remarkable exception,—that, namely, which is afforded by the 'Medullary Rays' of Exogenous Stems (§ 302), whose cells are greatly elongated in the horizontal direction (Fig. 210, a), their growth being from the centre of the stem towards its circumference. It is obvious that fluids will be more readily transmitted in the direction of greatest elongation, being that in which they will have to pass through the least number of partitions; and whilst their ordinary course is in the direction of the length of the Roots, Stems, or Branches, they will be enabled by means of the Medullary Rays to find their way in the transverse direction.—One of the most curious varieties of form which Vegetable cells present, is that represented in Fig. 199, which constitutes the *stellate* cell. This modification, to which we have already seen an approximation in *Volvox* (§ 195), is found in the spongy parenchymatous substance where lightness is an object; as in the Stems of many Aquatic plants, the *Rush* for example, which are furnished with

air-spaces. In other instances these air-spaces are large cavities which are altogether left void of tissue : such is the case in the *Nuphar lutea* (Yellow water-lily), the Footstalks of whose leaves contain large air-chambers, the walls of which are built up of very

FIG. 199.

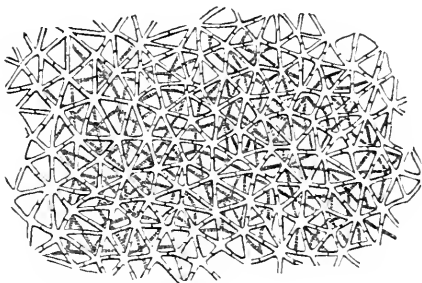

Section of Cellular parenchyma of *Rush*.

FIG. 200.

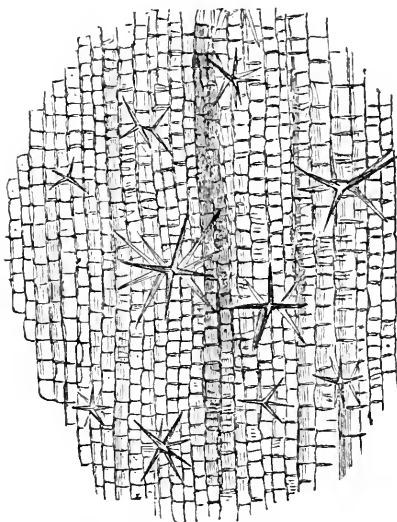

Cubical parenchyma, with stellate cells, from petiole of *Nuphar lutea*.

regular cubical cells, whilst some curiously formed large stellate cells project into the cavity which they bound (Fig. 200). The dimensions of the component vesicles of Cellular tissue are extremely variable ; for although their diameter is very commonly between 1-300th and 1-500th of an inch, they occasionally measure as much as 1-30th of an inch across, whilst in other instances they are not more than 1-3000th.

285. The component cells of Cellular tissue are usually held together by an intercellular substance, which may be considered analogous to the 'gelatinous' layer that intervenes between the cells of the *Algae*. There are many cellular substances, however, in which, in consequence of the loose aggregation of their component cells, these may be readily isolated, so as to be prepared for separate examination without the use of Reagents which alter their condition : this is the case with the pulp of ripe Fruits,

such as the Strawberry or Currant (the Snowberry is a particularly favourable subject for this kind of examination), and with the parenchyma of many fleshy Leaves, such as those of the Carnation (*Dianthus caryophyllus*) or the London Pride (*Saxifraga crassi-*

folia). Such cells usually contain evident *Nuclei*, which are turned brownish-yellow by iodine, whilst their membrane is only turned pale-yellow ; and in this way the Nucleus may be brought into view, when, as often happens, it is not previously distinguishable. If a drop of the iodized solution of chloride of zinc be subsequently added, the cell-membrane becomes of a beautiful blue colour, whilst the nucleus and the granular protoplasm that surrounds it retain their brownish-yellow tint. The use of dilute nitric or sulphuric acid, of alcohol, of syrup, or of several other reagents, serves to bring into view the *Primordial Utricle* (§ 182) ; its contents being made to coagulate and shrink, so that it detaches itself from the Cellulose wall with which it is ordinarily in contact, and shrivels-up within its cavity, as shown in Fig. 197. It would be a mistake, however, to regard this as a distinct membrane ; for it is nothing else than the peripheral layer of Protoplasm, naturally somewhat more dense than that which it includes (like the *Ectosarc* of Rhizopods (§ 325), but deriving its special consistence from the operations of Reagents.

286. Although the usual mode of increase in the higher Plants is by the multiplication of Cells by binary subdivision, after the plan which we have seen to prevail among the lower, yet there is evidence that, in the formation of new parts, cells may spring up as it were *de novo*, by a process of gradual differentiation in a Pro-

FIG. 201.

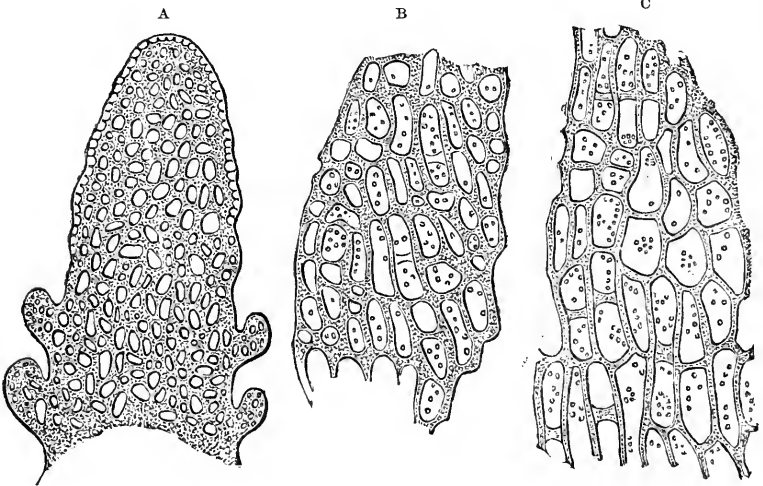

Successive stages of Cell-formation in the development of the Leaves of *Anacharis alsinistrum* :—A, growing point of the branch, consisting of a protoplasmic mass with vacuoles, the projections at its base being the rudiments of Leaves ; B, portion of one of these incipient Leaves in a more advanced condition ; C, the same in a still later stage of development.

toplasmic mass, analogous to that of which we have seen persistent representations among the simplest Protophytes (§§ 183-187). Thus it has been usually held that every Leaf has its origin in a certain cell of the Axis, which rapidly multiplies itself so as to form a minute protuberance that gradually takes the foliaceous form: and that the subsequent extension of this is due to a continuance of the same process. The observations of Mr. Wenham,* however, afford strong reason for the belief that in some cases, at any rate, the leaf originates in a layer of Protoplasm (Fig. 201), which is in the first instance homogeneous, but in which large vacuoles, disposed with a certain degree of regularity, soon make their appearance; those vacuoles become the cavities of the first cells, whilst the plasma between them, acquiring increased consistence, is converted into the walls of these cells. Sometimes, when one of the first-formed vacuoles is unusually large, it is divided into two by the extension of a bridge of protoplasm across it; on the other hand, if the plasmatic division between the vacuoles should be unusually broad, a new vacuole forms in its substance; and thus is formed a congeries of cells having a certain average size and shape, which, when matured, begin to multiply by self-division, and gradually evolve themselves into the perfect leaf.

287. It is probable that all Cells, at some stage or other of their growth, exhibit, in a greater or less degree of intensity, that curious movement of *Cyclosis*, which has been already described as occurring in the *Characeæ* (§ 254), and which consists in the steady flow of one or of several currents of Protoplasm over the inner wall of the cell; this being rendered apparent by the movement of the particles which the current carries along with it. The best examples of it are found among submerged Plants, in the cells of which it continues for a much longer period than it usually does elsewhere; and among these are two, the *Vallisneria spiralis* and the *Anacharis alsinastrium*, which are peculiarly fitted for the exhibition of this interesting phenomenon.—The *Vallisneria* is an Aquatic plant that grows abundantly in the rivers of the south of Europe, but is not a native of this country; it may, however, be readily grown in a tall glass jar having at the bottom a couple of inches of mould, which, after the roots have been inserted into it, should be closely pressed down, the jar being then filled with water, of which a portion should be occasionally changed.† The jar should be freely exposed to light, and should be kept in as warm but equable a temperature as possible. The

* "Transactions of the Microscopical Society," N.S., Vol. iv. (1856), pp. 1 and 60. See also the observations of Mr. Davey, at p. 100, and those of the Rev. S. G. Osborne, at p. 104, of the same Volume.

† Mr. Quekett found it the most convenient method of changing the water in the jars in which *Chara*, *Vallisneria*, &c., are growing, to place them occasionally under a water-tap, and allow a very gentle stream to fall into them for some hours; for by the prolonged overflow thus occasioned, all the impure water, with the *Conferva* that is apt to grow on the sides of the vessel, may be readily got rid of.

long grass-like Leaves of this plant are too thick to allow the transmission of sufficient light through them for the purpose of this observation ; and it is requisite to make a thin slice or shaving with a sharp knife. If this be taken from the surface, so that the section chiefly consists of the superficial layer of Cells, these will be found to be small, and the particles of Chlorophyll, though in great abundance, will rarely be seen in motion. This layer should therefore be sliced off (or, perhaps still better, scraped away), so as to bring into view the deeper layer, which consists of larger Cells, some of them greatly elongated, with particles of Chlorophyll in smaller number, but carried along in active rotation by the current of Protoplasm ; and it will often be noticed that the rotation takes place, in contiguous cells, in opposite directions. If the movement (as is generally the case) be checked by the shock of the operation, it will be revived again by a gentle warmth ; and it may continue under favourable circumstances, in the separated fragment, for a period of weeks, or even of months. Hence, when it is desired to exhibit the phenomenon, the preferable method is to prepare the sections a little time before they are likely to be wanted, and to carry them in a small vial of water in the waistcoat pocket, so that they may receive the gentle and continuous warmth of the body. In summer, when the plant is in its most vigorous state of growth, the section may be taken from any one of the leaves ; but in winter, it is preferable to select those which are a little yellow. An Object-glass of 1-4th inch focus will serve for the observation of this interesting phenomenon, and very little more can be seen with a 1-8th inch Objective ; but the 1-25th inch lately constructed by Messrs. Powell and Lealand enables the borders of the Protoplasmic current that carries along the particles of Chlorophyll to be distinctly defined ; and this beautiful phenomenon may be most luxuriously watched under their Patent Binocular (§ 62).

288. The *Anacharis alinastrum* is a Water-weed, which, having been accidentally introduced into this country several years ago, has since spread itself with such rapidity through our canals and rivers, as in many instances seriously to impede their navigation. It does not require to root itself in the bottom, but floats in any part of the water it inhabits ; and it is so tenacious of life, that even small fragments are sufficient for the origination of new plants. The Leaves have no distinct Cuticle, but are for the most part composed of two layers of Cells, and these are elongated and colourless in the centre, forming a kind of midrib ; towards the margins of the leaves, however, there is but a single layer. Hence no preparation whatever is required for the exhibition of this interesting phenomenon ; all that is necessary being to take a leaf from the stem (one of the older yellowish leaves being preferable), and to place it with a drop of water either in the Aquatic-box or on a slip of glass beneath a thin-glass cover. A higher magnifying power is required, however, than that which suffices for the examination of the Cyclosis in *Chara* or in *Vallisneria* ; the 1-8th inch

Object-glass being here preferable to the 1-4th, and the assistance of the Achromatic Condenser being desirable. With this amplification, the phenomenon may be best studied in the single layer of marginal cells; although, when a lower power is used, it is most evident in the elongated cells forming the central portion of the leaf. The number of Chlorophyll-granules in each cell varies from three or four to upwards of fifty; they are somewhat irregular in shape, some being nearly circular flattened disks, whilst others are oval; and they are usually from 1-3000th to 1-5000th of an inch in diameter. When the rotation is active, the greater number of these granules travel round the margin of the cells, a few, however, remaining fixed in the centre; their rate of movement, though only 1-40th of an inch per minute, being sufficient to carry them several times round the cell within that period. As in the case of the *Vallisneria*, the motion may frequently be observed to take place in opposite directions in contiguous cells. The thickness of the layer of Protoplasm in which the granules are carried round is estimated by Mr. Wenham at no more than 1-20,000th of an inch. A peculiar undulating appearance is seen in this, under certain modes of illumination, which suggests the idea of Ciliary action; but this appearance is decidedly affirmed by Mr. Wenham to be an optical illusion.*—It is affirmed by Dr. Branson † that the elongated cells along the margin of the leaf and forming the midrib contain a large quantity of silex; the evidence of this being furnished by the effect of Polarized light, especially after the leaf has been boiled for a few minutes in equal parts of nitric acid and water, which removes part of the Organic substance, and thus renders the Siliceous portion more distinct, without destroying the form of the leaf. But the observations of Prof. Bailey upon the parallel case of the *Equisetum* (§ 281) throw a doubt on the validity of this conclusion.

289. The phenomenon of *Cyclosis*, however, is by no means restricted to submerged Plants; for it has been witnessed by numerous observers in so great a variety of other species, that it may fairly be presumed to be universal. It is especially observable in the *Hairs* of the Epidermic surface; and according to Mr. Wenham, ‡ who has given much attention to this subject, “the difficulty is to find the exceptions, for hairs taken alike from the loftiest Elm of the forest to the humblest weed that we trample beneath our feet, plainly exhibit this circulation.” Such Hairs are furnished by various parts of Plants; and what is chiefly

* Op. cit., Vol. ii., 1854, p. 131.

† See Dr. Branson, in “Quart. Journ. of Microsc. Science,” Vol. iii. (1855), p. 274; and Mr. Wenham, in the same, Vol. iii. p. 277.

‡ ‘On the Sap-Circulation in Plants,’ in “Quart. Journ. of Microsc. Science,” Vol. iv. (1856), p. 44.—It is unfortunate that Mr. Wenham should have used the term ‘Circulation’ to designate this phenomenon, which has nothing in common with that movement of nutritive fluid through tubes or channels to which the term is properly applicable; whilst the term ‘Sap’ cannot be appropriately applied to the contents of the individual Cell.

necessary is, that the part from which the hair is gathered should be in a state of vigorous growth. The Hairs should be detached by tearing off, with a pair of fine-pointed forceps, the portion of

FIG. 202.

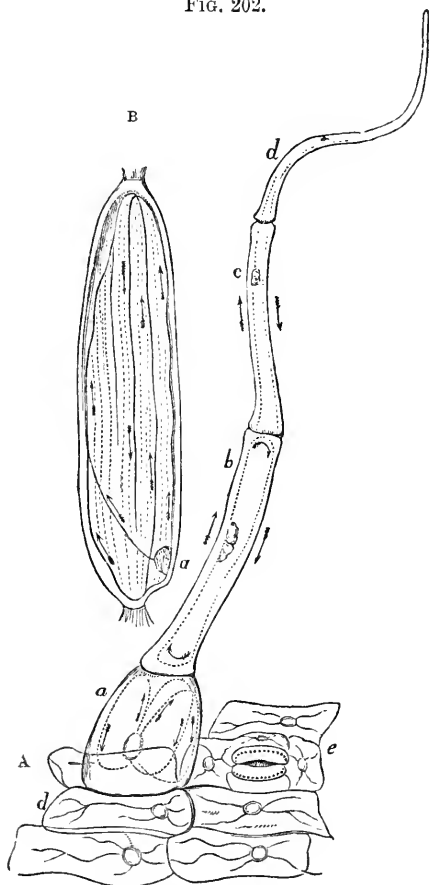

Rotation of fluid in Hairs of *Tradescantia Virginica*:—A, portion of Cuticle with Hair attached; a, b, c, successive Cells of the Hair; d, Cells of the Cuticle; e, Stoma:—B, joint of a beaded Hair, showing several currents; a, Nucleus.

the hairs of *Glaucium luteum*; whilst there are cases in which the current flows in a sluggish uniformly-moving sheet or layer. Where several distinct currents exist in one Cell, they are

the Cuticle from which they spring; care being taken not to grasp the Hair itself, whereby such an injury would be done to it as to check the movement within it. The Hair should then be placed with a drop of water under thin glass; and it will generally be found advantageous to use a 1-8th inch Objective, with an Achromatic Condenser having a series of diaphragms. The nature of the movement in the Hairs of different species is far from being uniform. In some instances, the currents pass in single lines along the entire length of the Cells, as in the Hairs from the filaments of the *Tradescantia virginica*, or Virginian spiderwort (Fig. 202, A); in others there are several such currents which retain their distinctness, as in the jointed Hairs of the Calyx of the same plant (B); in others, again, the streams coalesce into a network, the reticulations of which change their position at short intervals, as in the

all found to have one common point of departure and return, namely, the *Nucleus* (B, a) ; from which it seems fairly to be inferred that this body is the centre of the Vital Activity of the cell.* Mr. Wenham states that in all cases in which the Cyclosis is seen in the Hairs of a Plant, the Cells of the Cuticle also display it, provided that their walls are not so opaque or so strongly marked as to prevent the movement from being distinguished. The Cuticle may be most readily torn off from the stalk or the midrib of the Leaf ; and must then be examined as speedily as possible, since it loses its vitality when thus detached much sooner than do the Hairs. Even where no obvious movement of particles is to be seen, the existence of a Cyclosis may be concluded from the peculiar arrangement of the molecules of the Protoplasm, which are remarkable for their high refractive power, and which, when arranged in a 'moving train,' appear as bright lines across the Cell ; and these lines, on being carefully watched, are seen to alter their relative positions. The leaf of the common *Plantago* (Plantain or Dock) furnishes an excellent example of Cyclosis ; the movement being distinguishable at the same time both in the Cells and in the Hairs of the Cuticle torn from its stalk or midrib. It is a curious circumstance that when a plant which exhibits the Cyclosis is kept in a cold dark place for one or two days, not only is the movement suspended, but the moving particles collect together in little heaps, which are broken up again by the separate motion of their particles, when the stimulus of Light and Warmth occasions a renewal of the activity. It is well to collect the specimens about midday, that being the time when the rotation is most active ; and the movement is usually quickened by artificial Warmth, which, indeed, is a necessary condition in some instances to its being seen at all. The most convenient method of applying this warmth, while the object is on the Stage of the Microscope, is to blow a stream of air upon the thin-glass cover, through a glass or metal Tube previously heated in a Spirit-lamp.

290. The walls of the Cells of Plants are frequently thickened by internal deposits, which may present very different appearances according to the manner in which they are arranged. In its simplest condition, such a deposit forms a thin uniform layer over the whole internal surface of the Cellulose-wall (probably on the outside of the Primordial Utricle), scarcely detracting at all from its transparency, and chiefly distinguishable by the 'dotted' appearance which the membrane then presents (Fig. 198, A). These dots, however, are not pores, as their aspect might naturally

* The above statement is called in question by Mr. Wenham, who affirms that "whenever he has observed such a 'nucleus' it has either been formed by an accidental conglomeration of some of the cell-contents, or by morbid conditions." The Author is satisfied, however, from the constancy with which the 'nucleus' is the centre of the diverging lines of protoplasm, in those cells which have several streams radiating from one point, that it can neither be an accidental nor a morbid conglomeration.

suggest, but are merely points at which the deposit is wanting, so that the original Cell-wall there remains unthickened. When

the Cellular tissue is required to possess unusual firmness, a deposit of *Sclerogen* (a substance which, when separated from the resinous and other matters that are commonly associated with it, is found to be allied in chemical composition to Cellulose) is formed in successive layers, one within another (Fig. 203, A), which present themselves as concentric rings when the Cells containing them are

Tissue of the Testa of the Seed-coat of *Star-Anise*:—A, as seen in section; B, as seen on the surface.

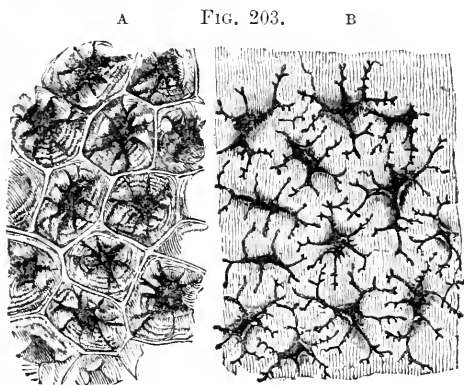

cut through; and these layers are sometimes so thick and numerous as almost to obliterate the original cavity of the cell. By a continuance of the same arrangement as that which shows

FIG. 204.

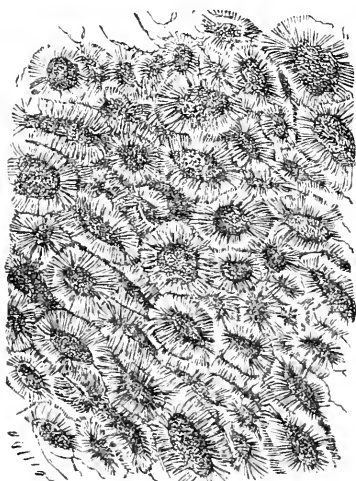

Section of *Cherry-stone*, cutting the Cells transversely.

FIG. 205.

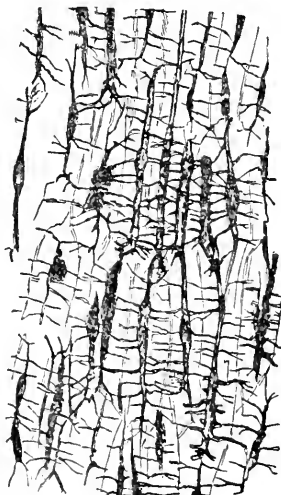

Section of *Coquilla-nut*, in the direction of the long diameters of the Cells.

itself in the single layer of the dotted cell—each deposit being deficient at certain points, and these points corresponding with each other in the successive layers—a series of passages is left, by which the cavity of the Cell is extended at some points to its membranous wall; and it commonly happens that the points at which the deposit is wanting on the walls of two contiguous Cells, are coincident, so that the membranous partition is the only obstacle to the communication between their cavities (Figs. 203–205). It is of such tissue that the ‘Stones’ of stone-fruit, the gritty substance which surrounds the Seeds and forms little hard points in the fleshy substance of the Pear, the Shell of the Cocoa-nut, and the Albumen of the Seed of *Phytelephas* (known as ‘vegetable ivory’), are made up; and we see the use of this very curious arrangement, in permitting the Cells, even after they have attained a considerable degree of consolidation, still to remain permeable to the fluid required for the nutrition of the parts which such tissue encloses and protects.

291. The deposit sometimes assumes, however, the form of definite *Fibres*, which lie coiled up in the interior of cells, so as to form a single, a double, or even a triple or quadruple spire (Fig. 206). Such *Spiral Cells* are found most abundantly in the Leaves of certain Orchideous plants, immediately beneath the Cuticle, where they are brought into view by vertical sections; and they may be obtained in an isolated state by macerating the leaf and peeling off the Cuticle so as to expose the layer beneath, which is then easily separated into its components. In an Orchideous plant,

FIG. 206.

Spiral cells of leaf of *Oncidium*.

FIG. 207.

Spiral fibres of Seed-coat of *Collomia*.

named *Saccolabium guttatum*, the Spiral Cells are unusually long, and have spires winding in opposite directions; so that, by their mutual intersection, a series of diamond-shaped markings is produced. Spiral cells are often found upon the surface of the *testa* or outer coat of Seeds; and in the *Collomia grandiflora*, the *Salvia verbenaca* (Wild Clary), and some other plants, the membrane of these cells is so weak, and the elasticity of their fibres so great, that when the membrane is softened by the action of Water, the fibres suddenly uncoil and elongate themselves (Fig. 207), springing out, as it were, from the surface of the Seed, to which they give a peculiar flocculent appearance. This very curious phenomenon, which is not unfrequently spoken of by persons ignorant of its true nature as the Germination of the Seed, may be best observed in the following manner:—A very thin transverse slice of the Seed should first be cut, and laid upon the lower glass of the Aquatic-box; the cover should then be pressed down, and the box placed upon the Stage, so that the body of the microscope may be exactly focussed to the object, the power employed being the 1-inch, 2-3rds inch, or the $\frac{1}{2}$ inch objective. The cover of the Aquatic-box being then removed, a small drop of water should be placed on that part of its internal surface with which the slice of the seed had been in contact; and the cover being replaced, the object should be immediately looked at. It is important that the slice of the Seed should be very thin, for two reasons; first, that the view of the spires may not be confused by their aggregation in too great numbers; and second, that the drop of water should be held in its place by capillary attraction, instead of running down and leaving the object, as it will do if the glasses be too widely separated.

292. In some part or other of most Plants we meet with Cells containing granules of *Starch*. These granules are sometimes minute and very numerous, and are so closely packed together as to fill the cavity (Fig. 208); in other instances they are of much

FIG. 208.

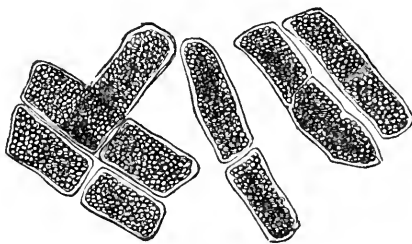
Cells of *Paony*, filled with Starch.

larger dimensions, so that only a small number of them can be included in any one Cell; while in other cases, again, they are both few and minute, so that they form but a small proportion of the cell-contents. Their nature is at once detected by the addition of a solution of Iodine, which gives them a beautiful blue colour. Each granule exhibits a peculiar spot, termed the *Hilum*, which marks the point at which, in its early state, it is attached to

the cell-wall ; and it also presents, when highly magnified, a set of circular lines, which are for the most part concentric (or nearly so) with the Hilum. When viewed by Polarized light, each grain exhibits a dark cross, the point of intersection being at the Hilum (Fig. 209) ; and when a Selenite-plate is interposed, the cross becomes beautifully coloured. Opinions are very much divided regarding the internal structure of the Starch-grain ; for whilst some affirm the concentric lines to indicate the existence of a number of concentric lamellæ, one enclosing another, others consider that they are due to the peculiar plaiting or involution of a single vesicular wall ;* and among those who consider it to be concentrically lamellated, some hold that each lamella is formed *outside*

or *upon* that which preceded it, while others consider that each is formed *inside* or *within* its predecessor. The centre of the granule is often occupied by starchy matter in an unconsolidated state ; and the appearance arising from the different refractive power of this has caused some observers to describe the Starch grain as possessing a Nucleus.—Although the dimensions of the Starch-grains produced by any one species of Plant are by no means constant, yet there is a certain average for each, from which none of them depart very widely ; and by reference to this average the Starch-grains of different plants that yield this product in abundance may be microscopically distinguished from one another, a circumstance of considerable importance in commerce. The largest Starch-grains in common use are those of the plant (a species of *Canna*) known as *Tous les mois* ; the average diameter of those of the *Potato* is about the same as the diameter of the smallest of

FIG. 209.

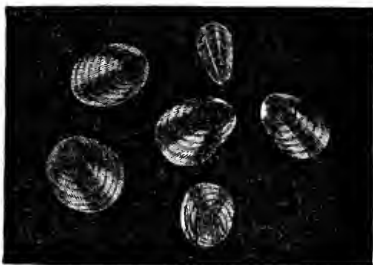
Granules of *Starch*, as seen under Polarized Light.

* The first of these opinions is the one which was generally received, until Mr. G. Busk supported the latter by new observations made upon the unfolding of the starch-granules by dilute sulphuric acid ; since when, Prof. Allman, after repeating Mr. Busk's observations, has been led to affirm them to be fallacious, and to revert to the first of the above-mentioned doctrines.—See Mr. Busk's memoir in "Trans. of Microsc. Soc." 2nd Ser. Vol. i. (1853), p. 58, and that of Prof. Allman in "Quart. Journ. of Microsc. Science," Vol. ii. (1854), p. 163 ; also Cruger, on the Development of Starch, in the same volume, p. 173 ; Grundy in "Pharmaceutical Journal," April, 1855 ; Henfrey in Ann. of "Nat. Hist." Ser. 2, Vol. xv. p. 246 ; and Rainey in "Quart. Journ. of Microsc. Science," Vol. viii. (1860), p. 1.

the 'Tous les mois;' and the size of the ordinary Starch-grains of *Wheat* and of *Sago* is about the same as that of the smallest grains of potato-starch; whilst the granules of *Rice*-starch are so very minute as to be at once distinguished from any of the preceding.

293. Deposits of mineral matter in a crystalline condition, known as *Raphides*, are not unfrequently found in the Cells of Plants; where they are at once brought into view by the use of Polarized light. Their designation (derived from $\rho\alpha\phi\iota\varsigma$, a Needle) is very appropriate to one of the most common states in which these bodies present themselves, that, namely, of bundles of needle-like crystals, lying side-by-side in the cavity of the cells: such bundles are well seen in the cells lying immediately beneath the cuticle of the bulb of the medicinal Squill. It does not apply, however, to other forms which are scarcely less abundant; thus, instead of bundles of minute Needles, single large crystals, octohedral or prismatic, are frequently met with; and the prismatic crystals are often aggregated in beautiful stellate groups. One of the most common materials of raphides is Oxalate of Lime, which is generally found in the stellate form; and no plant yields these stellate raphides so abundantly as the common *Rhubarb*, the best specimens of the dry medicinal root containing as much as 35 per cent. of them. In the Cuticle of the Bulb of the *Onion* the same material occurs under the octohedral or the prismatic form. In other instances, the Calcareous base is combined with Tartaric, Citric, or Malic acid; and the acicular raphides are said to consist usually of Phosphate of Lime. Some Raphides are as long as 1-40th of an inch, while others measure no more than 1-100th. They occur in all parts of plants,—the Wood, Pith, Bark, Root, Leaves, Stipules, Sepals, Petals, Fruit, and even in the Pollen. They are always situated in cells, and not, as some have stated, in inter-cellular passages; the cell-membrane, however, is often so much thinned away as to be scarcely distinguishable. Certain Plants of the *Cactus* tribe, when aged, have their tissue so loaded with Raphides as to become quite brittle; so that when some large specimens of *C. senilis*, said to be a thousand years old, were sent to Kew Gardens from South America, some years since, it was found necessary for their preservation during transport to pack them in cotton, like jewellery. It is not yet known what office the Raphides fulfil in the economy of the Plant, or whether they are to be considered in any other light than as non-essential results of the Vegetative processes. For as all these processes require the introduction of Mineral Bases from the soil, and themselves produce Organic Acids in the substance of the plant, it may be surmised that the accidental union of such components will occasion the formation of Raphides wherever such union may occur; and this view is supported by the fact, that the late Mr. E. Quekett succeeded in artificially producing raphides within the cells

of Rice-paper (§ 284), by first filling these with Lime-water by means of the air-pump, and then placing the paper in weak solutions of Phosphoric and Oxalic acids. The artificial Raphides of Phosphate of Lime were rhombohedral; while those of Oxalate of Lime were stellate, exactly resembling the natural Raphides of the Rhubarb.*

294. A large proportion of the denser parts of the fabric of the higher Plants is made-up of the substance which is known as *Ligneous Tissue* or *Woody Fibre*. This, however, can only be regarded as a very simple variety of Cellular Tissue; for it is composed of peculiarly-elongated Cells (Fig. 216), usually pointed at their two extremities so as to become spindle-shaped, whose walls have a special tendency to undergo consolidation by the internal deposit of Sclerogen. It is obvious that a tissue consisting of elongated cells, adherent together by their entire length, and strengthened by internal deposit, must possess much greater tenacity than any tissue in which the cells depart but little from the primitive spherical form; and we accordingly find Woody Fibre introduced wherever it is requisite that the fabric should possess not merely density, but the power of resistance to tension. In the higher classes of the Vegetable Kingdom it constitutes the chief part of the Stem and Branches, where these have a firm and durable character; and even in more temporary structures, such as the Herbaceous Stems of *annual* Plants, and the Leaves and Flowers of almost every tribe, this tissue forms a more or less important constituent, being especially found in the neighbourhood of the Spiral Vessels and Ducts, to which it affords protection and support. Hence the bundles or fasciculi composed of these elements, which form the 'Veins' of Leaves, and which give 'stringiness' to various esculent Vegetable substances, are commonly known under the name of *Fibro-Vascular* tissue. In their young and unconsolidated state the Ligneous cells seem to conduct fluids with great facility in the direction of their length; and in the *Coniferous* tribe, whose Stems and Branches are destitute of Ducts, they afford the sole channel for the ascent of the sap. But after their walls have become thickened by internal deposit, they are no longer subservient to this function; nor, indeed, do they then appear to fulfil any other purpose in the

* The materials of the above paragraph are derived from the excellent section on this subject in Prof. Quekett's "Lectures on Histology."— Besides the vegetables therein named as affording good illustrations of different kinds of Raphides, may be mentioned the parenchyma of the leaf of *Agave*, *Aloe*, *Cycas*, *Encephalartos*, &c.; the cuticle of the bulb of the *Hyacinth*, *Tulip*, and *Garlic* (and probably of other bulbs); the bark of the *Apple*, *Cascarilla*, *Cinchona*, *Lime*, *Locust*, and many other trees; the pith of *Eleagnus*, and the testa of the seeds of *Anagallis* and the *Elm*.—The Raphides characteristic of the different Natural Orders of Plants have been carefully studied by Mr. Gulliver; who has given an account of them in successive Papers in the "Annals of Natural History."

Vegetable economy than that of affording Mechanical support. It is this which constitutes the difference between the *Alburnum* or 'Sap-wood,' and the *Duramen* or 'Heart-wood,' of Exogenous Stems (§ 301).—A peculiar set of markings seen on the Woody fibres of the *Coniferæ*, and of some other tribes, is represented in Fig. 210 : in each of these spots the inner circle appears to mark a deficiency of the lining deposit, as in the porous cells of other plants ; whilst the *outer* circle indicates the boundary of a lenticular cavity which intervenes between the adjacent cells at this point, and which contains a small globular body that may be sometimes detached. Of the purpose of these minute bodies interposed between the Wood-Cells, nothing is known ; there can be no doubt, however, from the definiteness and constancy of their arrangement, that they fulfil some important object in the economy of the Plants in which they occur ; and there are varieties in this arrangement so characteristic of different Tribes, that it is sometimes possible to determine, by the microscopic inspection of a minute fragment, even of a Fossil wood, the tribe to which it belonged. The Woody Fibre thus marked is often designated as *glandular*.

FIG. 210.

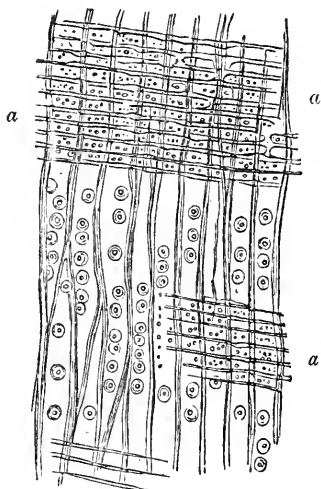

Section of *Coniferous Wood* in the direction of the Fibres, showing their 'glandular' dots :—*a a a*, Medullary Rays crossing the fibres.

295. All the more perfect forms of Phanerogamia contain, in some part of their fabric, the peculiar structures which are known as *Spiral vessels*.* These have the elongated shape of Woody Fibres ; but the internal deposit, as in the Spiral Cells (§ 291), takes the form of a spiral fibre winding from end to end, remaining distinct from the cell-wall, and retaining its elasticity ; this fibre may be single, double, or even quadruple—this last character presenting itself in the very large elongated Fibre-Cells of the *Nepenthes* (Chinese Pitcher-plant). These cells are especially found in the delicate membrane (Medullary Sheath) surrounding the Pith of Exogens, and in the midst of the woody bundles

* So long, however, as they retain their original cellular character and do not coalesce with each other, these fusiform spiral cells cannot be regarded as having any more claim to the designation of *vessels*, than have the elongated cells of the ligneous tissue.

occurring in the stem of Endogens; thence they proceed in each case to the Leaf-stalks, through which they are distributed to the leaves. By careful dissection under the Microscope they may be separated entire; but their structure may be more easily displayed by cutting *round*, but not *through*, the leaf-stalk of the Strawberry, Geranium, &c., and then drawing the parts asunder. The Membrane composing the tubes of the vessels will thus be broken across; but the Fibres within, being elastic, will be drawn-out and unrolled. Spiral vessels are sometimes found to convey *liquid*, whilst in other cases they contain *air* only; the conditions of this difference are not yet certainly known.

296. Although fluid generally finds its way with tolerable facility through the various forms of Cellular Tissue, especially in the direction of the greatest length of their cells, a more direct means of connection between distant parts is required for its active transmission. This is afforded by what has been termed *Vasiform tissue*, which consists merely of Cells laid end-to-end, the partitions between them being more or less obliterated, so that a continuous *Duct* is formed. The origin of these Ducts in Cells is occasionally very evident, both in the contraction of their calibre at regular intervals, and in the persistence of remains of their partitions (Plate XIII., fig. 2, *b, b*); but in most cases it can only be ascertained by studying the history of their development, neither of these indications being traceable. The component Cells appear to have been sometimes simply Membranous, but more commonly to have possessed the Fibrous type (§ 291). Some of the Ducts formed from the latter (Fig. 211, 2) are so like continuous Spiral Vessels as to be scarcely distinguishable from them, save in the want of elasticity in their spiral fibre, which causes it to break when the attempt is made to draw it out. This rupture would seem to have taken place, in some instances, from the natural elongation of the cells by growth; the fibre being broken-up into rings, which lie sometimes close together, but more commonly at considerable intervals; such a Duct is said to be *Annular* (Fig. 211, 1). Intermediate forms between the Spiral and Annular Ducts, which show the derivation of the latter from the former, are very frequently to be met-with. The spires are sometimes broken-up still more completely, and the fragments of the fibre extend in various directions, so as to meet and form an irregular network lining the Duct, which is then said to be *Reticulated*. The continuance of the deposit, however, gradually contracts the meshes, and leaves the walls of the Duct marked only by pores like those of Porous Cells (§ 290); and canals upon this Plan, commonly designated as *Dotted Ducts*, are among the most common forms of Vasiform tissue, especially in parts of most solid structure and least rapid growth (Fig. 211, 3). The Scalariform Ducts of Ferns (§ 278) are for the most part of the spiral type; but Spiral Ducts are frequently to be met with also in the rapidly-growing Leaf-stalks of Flowering-plants, such as the

Rhubarb. Not unfrequently, however, we find all forms of Ducts in the same bundle, as seen in Fig. 211.—The size of these Ducts is occasionally so great as to enable their openings to be distinguished by the unaided eye : they are usually largest in Stems whose size is small in proportion to the surface of Leaves which they support, such as the common Cane, or the Vine ; and, generally speaking, they are larger in woods of dense texture, such as Oak or Mahogany, than in those of which the fibres, remaining

FIG. 211.

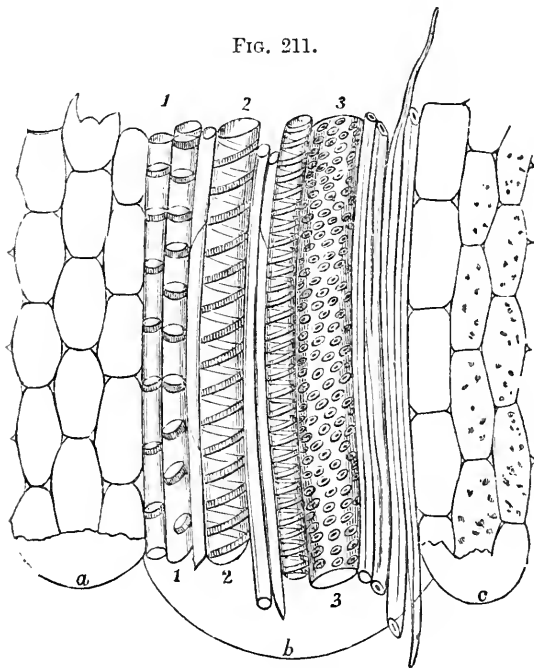

Longitudinal section of stem of *Italian Reed* :—*a*, Cells of the Pith ; *b*, Fibro-Vascular bundle, containing 1, Annular Duct ; 2, Spiral Duct ; 3, Dotted Duct, with Woody Fibre : *c*, Cells of the integument.

unconsolidated, can serve for the conveyance of fluid. They are entirely absent in the *Coniferae*.

297. The Vegetable tissues whose principal forms have been now described, but among which an immense variety of detail is found, may be either studied as they present themselves in thin *Sections* of the various parts of the plant under examination, or in the isolated conditions in which they are obtained by

Dissection.—The former process is the most easy, and yields a large amount of information; but still it cannot be considered that the characters of any tissue have been properly determined until it has been dissected-out. Sections of some of the hardest Vegetable substances, such as 'Vegetable-Ivory,' the 'Stones' of fruit, the 'Shell' of the Cocoa-nut, &c. (§ 290), can scarcely be obtained except by slicing and grinding (§ 135); and these may be mounted either in Canada Balsam or in Glycerine Jelly. In cases, however, in which the tissues are of only moderate firmness, the section may be most readily and effectually made with the 'Section-Instrument' (§ 137); and there are few parts of the Vegetable fabric which may not be advantageously examined by this means, any very soft or thin portions being placed in it between two pieces of cork. In certain cases, however, in which even this compression would be injurious, the sections must be made with a sharp knife, the substance being laid upon a slip of glass.—In dissecting the Vegetable Tissues scarcely any other instrument will be found really necessary than a pair of needles (in handles), one of them ground to a cutting edge. The adhesion between the component cells, fibres, &c., is often sufficiently weakened by a few hours' maceration to allow of their readily coming apart, when they are torn-asunder by the needle-points beneath the simple lens of a Dissecting-microscope. But if this should not prove to be the case, it is desirable to employ some other method for the sake of facilitating their isolation. None is so effectual as the boiling of a thin slice of the substance under examination, either in dilute nitric acid, or in a mixture of nitric acid and chlorate of potass. This last method (which was devised by Schultz) is the most rapid and effectual, requiring only a few minutes for its performance: but as oxygen is liberated with such freedom as to give an almost explosive character to the mixture, it should be put in practice with extreme caution. After being thus treated, the tissue should be boiled in Alcohol, and then in Water; and it will then be found very easy to tear-apart the individual Cells, Ducts, &c., of which it may be composed. These may be preserved by mounting in weak Spirit.

298. *Structure of the Stem and Root.*—It is in the Stems and Roots of Plants that we find the greatest variety of tissues in combination, and the most regular plans of structure; and sections of these viewed under a low magnifying power are objects of peculiar beauty, independently of the scientific information which they afford. The Axis (under which term is included the Stem with its branches, and the Root with its ramifications) always has for the basis of its structure a dense Cellular Parenchyma; though this, in the advanced stage of development, may constitute but a small proportion of it. In the midst of the Parenchyma we generally find Fibro-Vascular bundles; that is, fasciculi of Woody-Fibre, with Ducts of various kinds, and (very commonly) Spiral Vessels. It is

in the mode of arrangement of these bundles, that the fundamental difference exists between the Stems which are commonly designated as *Endogenous*, and those which are (more appropriately) termed *Exogenous*; for in the former the bundles are dispersed throughout the whole diameter of the Axis without any peculiar plan, the intervals between them being filled-up by Cellular Parenchyma; whilst in the latter they are arranged side by side in such a manner as to form a hollow cylinder of *Wood*, which includes within it the portion of the Cellular substance known as *Pith*, whilst it is itself enclosed in an envelope of the same substance that forms the *Bark*. These two plans of Axis-formation, respectively characteristic of those two great groups into which the Phanerogamia are subdivided—namely, the *Monocotyledons* and the *Dicotyledons*,—will now be more particularly described.

299. When a transverse Section (Fig. 212) of a *Monocotyledonous* Stem is examined microscopically, it is found to exhibit a

FIG. 212.

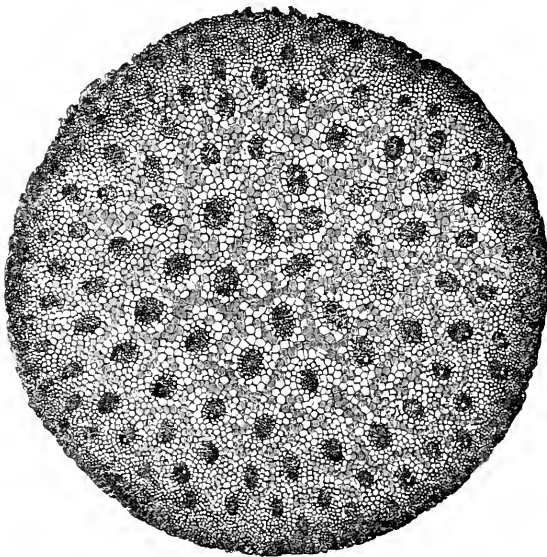

Transverse section of Stem of young *Palm*.

number of Fibro-Vascular bundles, disposed without any regularity in the midst of the mass of Cellular tissue, which forms (as it were) the matrix or basis of the fabric. Each bundle contains two, three, or more large Ducts, which are at once distinguished by the size of their openings; and these are surrounded by Woody Fibre

and Spiral Vessels, the transverse diameter of which is so extremely small, that the portion of the bundles which *they* form is at once distinguished in transverse section by the *closeness* of its texture (Fig. 213). The bundles are least numerous in the centre of the Stem, and become gradually more approximated towards its circumference: but it frequently happens that the portion of the area in which they are most compactly arranged is not absolutely at its exterior, this portion being itself surrounded by an investment composed of Cellular tissue only; and sometimes we find the central portion, also, completely destitute of Fibro-Vascular bundles; so that a sort of indication of the distinction between Pith, Wood, and bark is here presented. This distinction, however, is very imperfect; for we do not find either the central or the peripheral portions ever separable, like Pith and Bark, from the intermediate Woody layer. In its young state the centre of the Stem is always filled-up with Cells; but these not unfrequently disappear after a time, except at the *nodes*, leaving the Stem hollow, as we see in the whole tribe of Grasses. When a vertical section is made of a Woody stem (as that of a Palm) of sufficient length to trace the whole extent of the Fibro-Vascular bundles, it is found that whilst they pass at their upper extremity into the Leaves, they pass at the lower end towards the surface of the Stem, and assist, by their interlacement with the outer bundles, in forming that extremely tough investment which the lower ends of these stems present. The Fibro-Vascular bundles once formed receive no further additions; and the augmentation of the Stem in diameter depends upon the development of new Woody bundles, in continuity with the leaves which are successively evolved at its summit. It was formerly supposed that these successively-formed bundles descend in the interior of the Stem through its entire length until they reach the Roots; and as the successive development of Leaves involves a successive development of new bundles, the Stem was imagined to be continually receiving additions to its

FIG. 213.

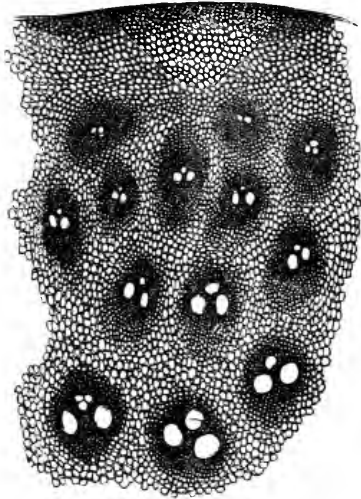

Portion of Transverse Section of
Stem of *Wanghie Cane*.

interior, whence the term *Endogenous* was given to this type of stem-structure. From the fact just stated, however, regarding the course of the Fibro-Vascular bundles, it is obvious that such a doctrine cannot be any longer admitted ; for those which are most recently formed only pass into the centre of the Stem during the higher part of their course, and usually make their way again to its exterior at no great distance below ; and thus the lower and older portions of a Palm-stem really do receive very little augmentation in diameter, while a rapid elongation is taking place at its summit. In fact, the dense unyielding nature of the fabric which is formed by the interlacement of the Fibro-vascular bundles at or near the surface of the trunk, would prevent any considerable augmentation by expanding pressure from within.

300. In the Stems of *Dicotyledonous* Phanerogamia, on the other hand, we find a method of arrangement of the several parts, which

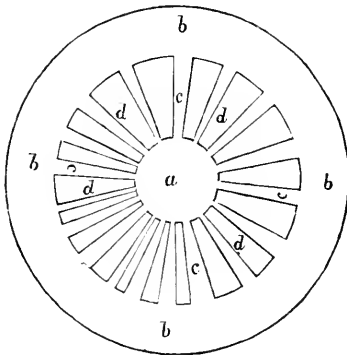

Diagram of the first formation of an Exogenous Stem ;—*a*, Pith ; *b b*, Bark ; *c c*, plates of Cellular Tissue (Medullary Rays) left between the Woody bundles *d d*.

must be regarded as the highest form of the development of the Axis, being that in which the greatest *differentiation* exists. A distinct division is always seen in a Transverse Section between the three concentric areas of the *Pith*, the *Wood*, and the *Bark* ; the first (*a*) being central and the last (*b*) peripheral, and these having the *Wood* interposed between them, its circle being made up of wedge shaped bundles (*d, d*), kept apart by the bands (*c, c*) that pass between the Pith and the Bark. The *Pith* (Plate XII., fig. 1, *a*) is almost invariably composed of Cellular tissue only, which usually presents (in transverse section) a hexagonal areolation.

When newly formed it has a greenish hue, and its cells are filled with fluid ; but it gradually dries-up and loses its colour ; and not unfrequently its component Cells are torn apart by the rapid growth of their envelope, so that irregular cavities are found in it ; or, if the Stem should increase with extreme rapidity, it becomes hollow, the Pith being reduced to fragments, which are found adhering to its interior wall. The Pith is immediately surrounded by a delicate Membrane consisting almost entirely of Spiral Vessels, which is termed the *Medullary Sheath*.

301. The *Woody* portion of the Stem (Plate XII., fig. 1, *b, b*) is made up of Woody Fibres, usually with the addition of Ducts of

PLATE XII.

FIG. 1.

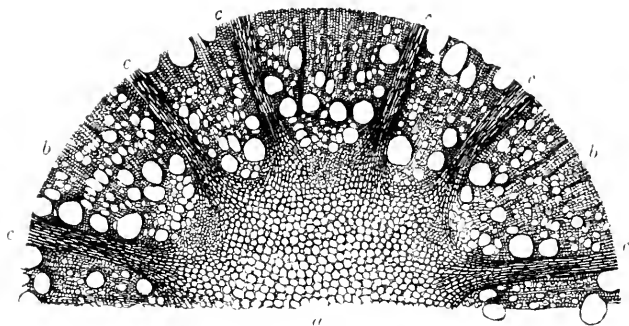

FIG. 2.



FIG. 3.

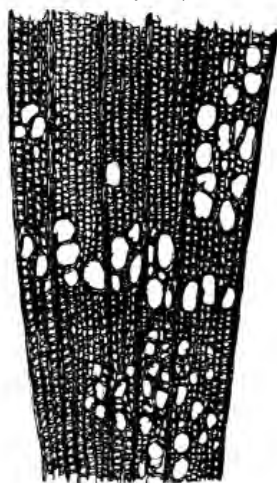
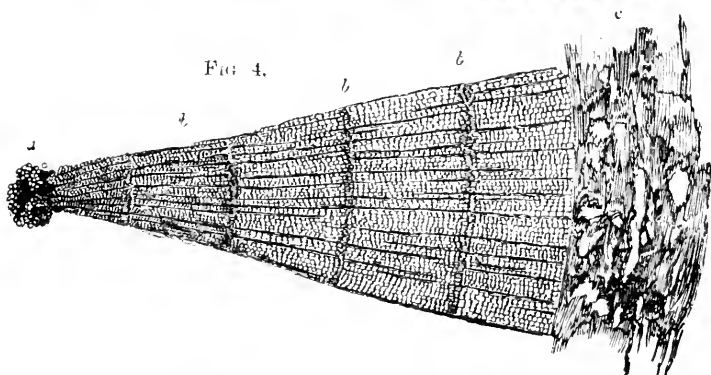

FIG. 4.



TRANSVERSE SECTIONS OF EXOGENOUS STEMS.

[*To face p. 49.*]

various kinds ; these, however, are absent in one large group, the *Coniferae* or Fir Tribe with its allies (Plate XIII., fig. 4, and Figs. 215-217), in which the Woody Fibres are of unusually large diameter, and have the peculiar Glandular markings already described (§ 294). In any Stem or Branch of more than one year's growth, the Woody structure presents a more or less distinct appearance of division into Concentric Rings, the number of which varies with the age of the tree (Plate XII., fig. 2). The composition of the several Rings, which are the sections of so many cylindrical Layers, is uniformly the same, however different their thickness ; but the arrangement of the two principal elements,—namely, the Woody fibre and the Ducts,—varies in different species : the Ducts being sometimes almost uniformly diffused through the whole layer, but in other instances being confined to its inner part ; while in other cases, again, they are dispersed with a certain regular irregularity (if such an expression may be allowed), so as to give a curiously-figured appearance to the Transverse Section (Plate XII., figs. 2, 3). The general fact, however, is, that the Ducts predominate towards the inner side of the ring (which is the part of it first formed), and that the outer portion of each layer is almost exclusively composed of Woody tissue : such an arrangement is shown in Plate XII., fig. 1. This alternation of Ducts and Woody fibre frequently serves to mark the succession of Layers, when, as it is not uncommon, there is no very distinct line of separation between them.—The number of Layers is usually considered to correspond with that of the *Years* during which the Stem or Branch has been growing ; and this is, no doubt, generally true in regard to the Trees of Temperate climates, which thus ordinarily increase by Annual layers. There can be no doubt, however, that such is not the universal rule ; and that we should be more correct in stating that each layer indicates an *Epoch of Vegetation* ; which, in Temperate climates, is usually (but not invariably) a year, but which is commonly much less in the case of trees flourishing in Tropical regions. Thus among the latter it is very common to find the Leaves regularly shed and replaced *twice* or even *thrice* in a year, or *five* times in two years ; and for every crop of Leaves there will be a corresponding Layer of wood. It sometimes happens, even in Temperate climates, that Trees shed their leaves prematurely in consequence of continued drought, and that, if rain then follow, a fresh crop of leaves appears in the same season ; and it cannot be doubted that in such a year there would be *two* rings of Wood produced, which would probably not together exceed the ordinary *single* layer in thickness. That such a division may even occur as a consequence of an interruption to the processes of Vegetation produced by seasonal changes,—as by heat and drought in a tree that flourishes best in a cold damp atmosphere, or by a fall of temperature in a tree that requires heat,—would appear from the frequency with which a *double* or even a *multiple* succession of Rings is found in Transverse Sections of wood

to occupy the place of a *single* one. Thus in a section of Hazel-stem (in the Author's possession), of which a portion is represented in Fig. 214, between two Layers of the ordinary thickness there intervenes a band whose breadth is altogether less than that of either of them, and which is yet composed of no fewer than six Layers, four of them (*c*) being very narrow, and each of the other

FIG. 214.

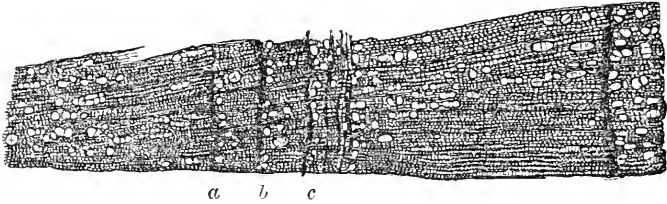

Portion of Transverse Section of Stem of *Hazel*, showing, in the portion *a, b, c*, six narrow layers of Wood.

two (*a, b*) being about as wide as these four together.—The inner Layers of Wood are the oldest, and the most solidified by matters deposited within their component Cells and Vessels; hence they are spoken of collectively under the designation *Duramen* or Heart-wood. On the other hand, it is through the Cells and Ducts of the outer and newer layers that the sap rises from the roots towards the leaves; and these are consequently designated as *Alburnum* or Sap-wood. The line of demarcation between the two is sometimes very distinct, as in *Lignum-vitæ* and *Cocos* wood; and as a new layer is added every year to the exterior of the *Alburnum*, an additional layer of the innermost part of the *Alburnum* is every year consolidated by internal deposit, and is thus added to the exterior of the *Duramen*. More generally, however, this consolidation is gradually effected, and the *Alburnum* and *Duramen* are not separated by any abrupt line of division.

302. The *Medullary Rays* which cross the successive rings of Wood, connecting the Cellular substance of the Pith with that of the Bark, and dividing each ring of Wood into wedge-shaped segments, are thin plates of Cellular Tissue (Plate XII., fig. 1), not usually extending to any great depth in the vertical direction. It is not often, however, that their character can be so clearly seen in a Transverse section as it is in that just referred to; for they are usually compressed so closely as to appear darker than the wedges of Woody tissue between which they intervene (Plate XII., figs. 3, 4); and their real nature is best understood by a comparison of *Longitudinal* sections made in two different directions,—namely, *radial* and *tangential*,—with the transverse. Three such sections of a fossil Coniferous wood in the Author's possession are shown in Figs. 215–217. The Stem was of such large size, that, in so small a part of the area of its Transverse section as is represented in

Fig. 215, the Medullary Rays seem to run parallel to each other, instead of radiating from a common centre. They are very narrow; but are so closely set together, that only two or three rows of Woody Fibres (no ducts being here present) intervene between any pair of them. In the Longitudinal Section taken in a Radial direction (Fig. 216), and consequently passing in the same course with the Medullary Rays, these are seen as thin plates (*a, a, a*) made-up of superposed Cells very much elongated,

FIG. 215.

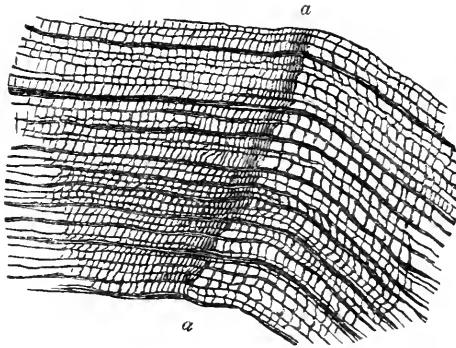

Portion of Transverse Section of large Stem of *Coniferous Wood* (fossil), showing part of two Annual Layers, divided at *a, a*, and traversed by very thin but numerous Medullary Rays.

FIG. 216.

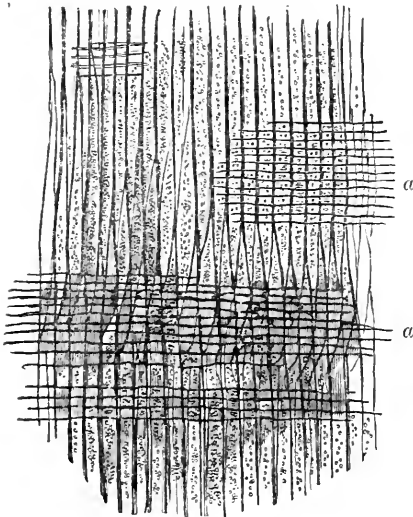

Portion of Vertical Section of the same Wood, taken in a Radial direction, showing the glandular Woody fibres, without Ducts, crossed by the Medullary Rays, *a, a*.

FIG. 217.

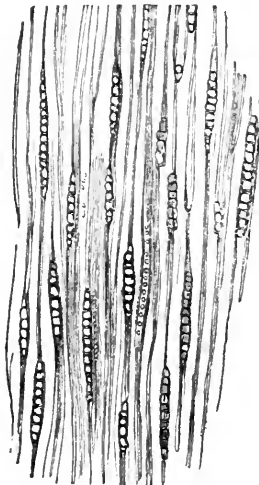

Portion of Vertical Section of the same Wood, taken in a Tangential direction, so as to cut across the Medullary Rays.

and crossing in a horizontal direction the Woody Fibres which lie parallel to one another vertically. And in the Tangential section (Fig. 217), which passes a direction at right angles to that of the Medullary rays, and therefore cuts them across, we see that each of the plates thus formed has a very limited depth from above downwards, and is composed of no more than one thickness of horizontal Cells.—A section of the Stem of *Mahogany* taken in the same direction as the last (Fig. 218), gives a very good view of the cut ends of the Medullary Rays, as they pass between the

FIG. 218.

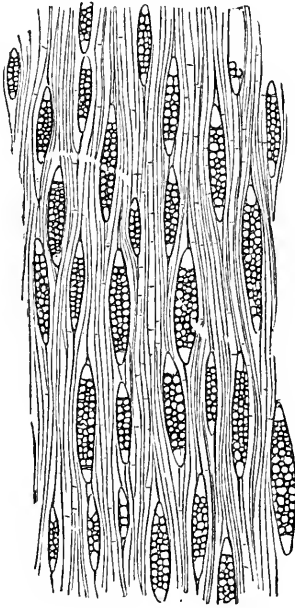
Vertical section of *Mahogany*.

Woody Fibres ; and they are seen to be here of somewhat greater thickness, being composed of two or three rows of Cells, arranged side by side.—In another Fossil Wood, whose Transverse section is shown in Plate XIII., fig. 1, and its Tangential section in fig. 2, the Medullary Rays are seen to occupy a much larger part of the substance of the Stem ; being shown in the Transverse section as broad bands (*a a, a a*) intervening between the closely-set Woody Fibres, among which some large Ducts are scattered ; whilst in the Tangential, they are observed to be not only deeper than the preceding from above downwards, but also to have a much greater thickness. This section also gives an excellent view of the Ducts *b b, b b*, which are here plainly seen to be formed by the coalescence of large cylindrical Cells, lying end-to-end.—In another Fossil Wood in the Author's possession, the Medullary Rays

constitute a still larger proportion of the Stem ; for in the Transverse section (Plate XIII., fig. 3) they are seen as very broad bands (*b, b*), alternating with plates of Woody structure (*a, a*), whose thickness is often less than their own ; whilst in the Tangential section (fig. 4) the cut extremities of the Medullary Rays occupy a very large part of the area, having apparently determined the sinuous course of the Woody Fibres ; instead of looking (as in Fig. 217) as if they had forced their way between the Woody Fibres, which there hold a nearly straight and parallel course on either side of them. The purpose of the Medullary Rays appears to be to maintain a connection between the external and the internal

FIG. 1.

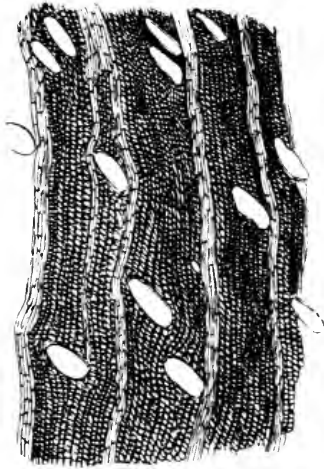

FIG. 2.

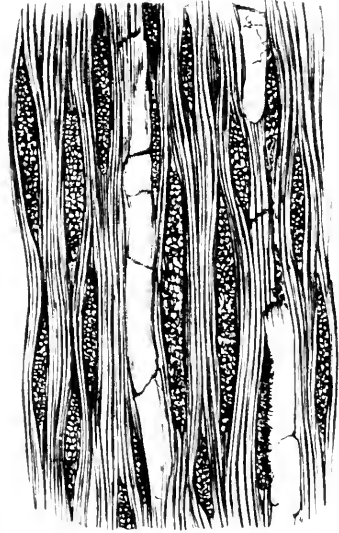

FIG. 3.



FIG. 4.

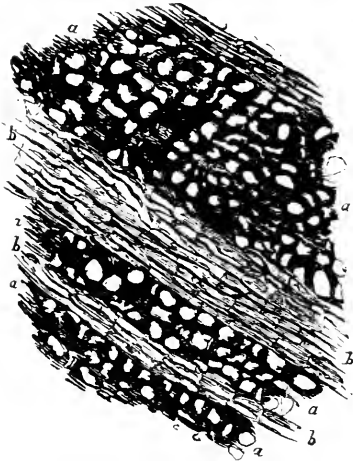
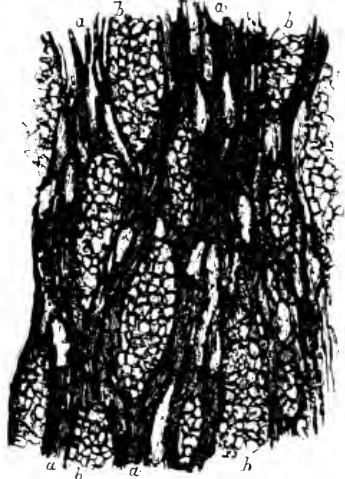
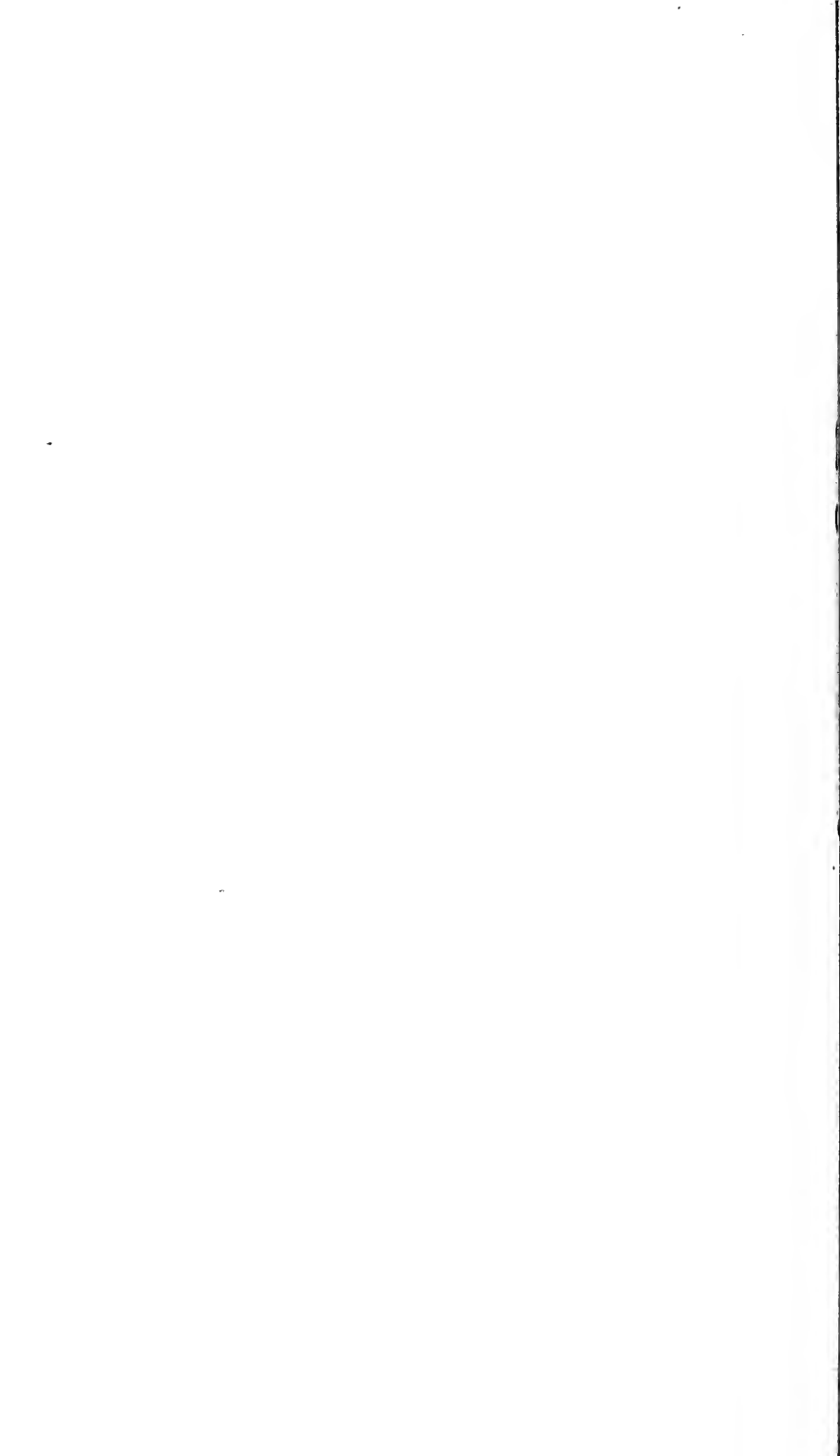

FIG. 5.





parts of the Cellular basis of the stem, which have been separated by the interposition of the Wood.

303. The *Bark* may be usually found to consist of three principal layers; the external, or *Epiphylæum*, also termed the *Suberous* (or *Corky*) layer; the middle, or *Mesophylæum*, also termed the *Cellular Envelope*; and the internal, or *Endophylæum*, which is more commonly known as the *Liber*. The two outer layers are entirely Cellular; and are chiefly distinguished by the form, size, and direction of their cells. The *Epiphylæum* is generally composed of one or more layers of colourless or brownish cells, which usually present a cubical or tabular form, and are arranged with their long diameters in the horizontal direction; it is this which, when developed to an unusual thickness, forms *Cork*, a substance which is by no means the product of one kind of Tree exclusively, but exists in greater or less abundance in the Bark of every Exogenous stem. The *Mesophylæum* consists of Cells, usually of green colour, prismatic in their form, and disposed with their long diameters parallel to the axis; it is more loosely arranged than the preceding, and contains Intercellular Passages, which often form a network of canals that have been termed Laticiferous Vessels; and although usually less developed than the suberous layer, it sometimes constitutes the chief thickness of the bark. The *Liber* or Inner Bark, on the other hand, usually contains Woody Fibre in addition to the Cellular tissue and Laticiferous Vessels of the preceding; and thus approaches more nearly in its character to the Woody layers, with which it is in close proximity on its inner surface. The *Liber* may generally be found to be made up of a succession of thin layers, equalling in number those of the Wood, the innermost being the last formed; but no such succession can be distinctly traced in the Cellular Envelope, or in the Suberous layer; although it is certain that they too augment in thickness by additions to their interior, whilst their external portions are frequently thrown-off in the form of thickish plates, or detach themselves in smaller and thinner laminæ.—The bark is always separated from the wood by the *Cambium-Layer*, which is the part wherein all new growth takes place: this seems to consist of mucilaginous semi-fluid matter; but it is really made-up of Cells of a very delicate texture, which gradually undergo transformations, whereby they are for the most part converted into Woody Tissue, Ducts, Spiral Vessels, &c. These materials are so arranged as to augment the Fibro-Vascular bundles of the Wood on their external surface, thus forming a new layer of *Alburnum* which *encloses* all those that preceded it; whilst they also form a new layer of *Liber*, on the *interior* of all those which preceded it: they also extend the Medullary Rays, which still maintain a continuous connection between the Pith and the Bark; and a portion remains unconverted, so as always to keep apart the *Liber* and *Alburnum*.—This type of Stem-structure is termed *Exogenous*; a designation which applies

very correctly to the mode of increase of the Woody layers, although (as just shown) the Liber is formed upon a truly Endogenous plan.

304. Numerous departures from the normal type are found in particular tribes of Exogens. Thus in some the Wood is not marked by concentric circles, their growth not being interrupted by any seasonal change. In other cases, again, each Woody zone is separated from the next by the interposition of a thick layer of Cellular substance. Sometimes Wood is formed in the Bark (as in *Calycanthus*), so that several woody columns are produced, which

FIG. 219.

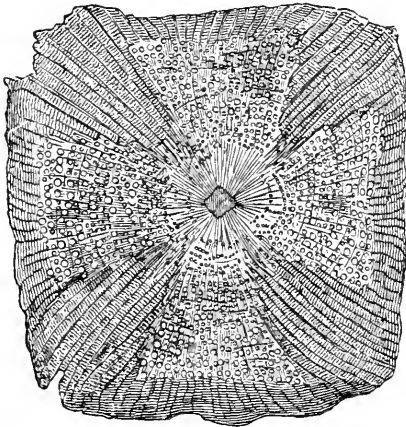

Transverse section of the stem of a climbing-plant (*Aristolochia*?) from New Zealand.

are quite independent of the principal woody axis, but cluster around it. Occasionally the Woody Stem is divided into distinct segments by the peculiar thickness of certain of the Medullary Rays; and in the Stem of which Fig. 219 represents a transverse section, these Cellular plates form four large segments, disposed in the manner of a Maltese cross, and alternating with the four Woody segments, which they equal in size.

305. The Exogenous Stem, like the so-called Endogenous, consists in its first-developed state of Cellular tissue only; but after the Leaves have been actively performing their functions for a short time, we find a circle of Fibro-Vascular bundles, as represented in the Diagram, p. 408, interposed between the central (or Medullary) and the peripheral (or Cortical) portions of the Cellular matrix; these Fibro-Vascular bundles being themselves separated from each other by plates of Cellular tissue, which still remain to connect the central and the peripheral portions of the matrix. This first stage in the formation of the Exogenous axis, in which its principal parts—the Pith, Wood, Bark, and Medullary Rays—are marked out, is seen even in the stems of Herbaceous Plants, which are destined to die down at the end of the season (Fig. 220); and sections of these, which are very easily prepared, are most interesting Microscopic objects. In such stems, the difference between the Endogenous and the Exogenous types is manifested in little else than the disposition of the Fibro-Vascular layers; which are scat-

tered through nearly the whole of the Cellular matrix (although most abundant towards its exterior) in the former case; but are limited to a circle within the peripheral portion of the Cellular tissue in the latter. It is in the further development which takes place during succeeding years in the Woody Stems of perennial Exogens, that those characters are displayed, which separate them most completely from the Ferns and their allies, whose stems contain a cylindrical layer of Fibro-Vascular bundles, as well as from (so-called) Endogens. For whilst the Fibro-Vascular layers of the latter, when once formed, undergo no further increase, those of Exogenous Stems are progressively augmented by the metamorphosis of the Cambium-layer; so that each of the bundles which once lay as a mere series of parallel cords beneath the Cellular investment of a first-year's stem, may become in time the small end of a wedge-shaped mass of Wood, extending continuously from the centre to the exterior of a Trunk of several feet in diameter, and becoming progressively thicker as it passes outwards. The fibro-vascular bundles of Exogens are therefore spoken of as 'indefinite;' whilst those of Exogens and Acrogens (Ferns, &c.) are said to be 'definite' or 'closed.'

306. The structure of the *Roots* of Endogens and Exogens is essentially the same in plan with that of their respective Stems. Generally speaking, however, the *Roots* of Exogens have no Pith, although they have Medullary Rays; and the succession of distinct rings is less apparent in them, than it is in the Stems from which they diverge. In the delicate Radical Filaments which proceed from the larger Root-fibres, a central bundle of Vessels will be seen, enveloped in a sheath of Cellular substance; and this investment also covers-in the end of the fibril, which is usually somewhat dilated, and composed of peculiarly succulent tissue, forming what is termed the *Spongiole*. The structure of the Radical filaments may be well studied in the common *Duckweed*, every floating leaf of which has a single fibril hanging down from its lower surface.

307. The structure of Stems and Roots cannot be thoroughly examined in any other way, than by making Sections in different directions with the Section-instrument. The general instructions

FIG. 220.

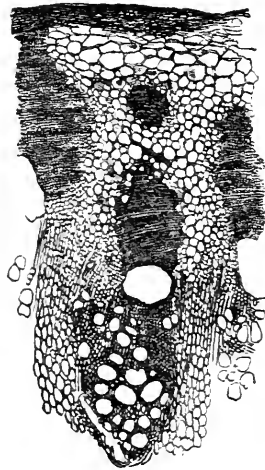

Portion of transverse section of *Burdock* (*Arctium*), showing one of the Fibro-Vascular bundles that lies beneath the Cellular integument.

already given (§ 137) leave little to be added respecting this special class of objects ; the chief points to be attended-to being the preparation of the Stems, &c., for slicing, the sharpness of the knife and the dexterity with which it is handled, and the method of mounting the sections when made. The Wood, if green, should first be soaked in strong Alcohol for a few days, to get-rid of the Resinous matter; and it should then be macerated in Water for some days longer, for the removal of its Gum, before being submitted to the cutting-process. If the Wood be dry, it should first be softened by soaking for a sufficient length of time in Water, and then treated with Spirit and afterwards with Water, like green wood. Some Woods are so little affected even by prolonged maceration, that boiling in water is necessary to bring them to the degree of softness requisite for making sections. No Wood that has once been dry, however, yields such good sections as that which is cut fresh. When a piece, of the appropriate length, has been placed in the grasp of the Section-instrument (wedges of deal or other soft wood being forced-in with it, if necessary for its firm fixation), a few thick slices should first be taken, to reduce its surface to an exact level; the surface should then be wetted with Spirit, the Micrometer-screw moved through a small part of a revolution, and the slice taken off with the razor, the motion given to which should partake both of *drawing* and *pushing*. A little practice will soon enable the operator to discover, in each case, *how thin* he may venture to cut his sections without a breach of continuity; and the Micrometer-screw should be turned so as to give the required elevation. If the surface of the Wood has been sufficiently wetted, the section will not curl-up in cutting, but will adhere to the surface of the Razor, from which it is best detached by dipping the razor in water so as to float away the slice of wood, a camel-hair pencil being used to push it off, if necessary. All the Sections that may be found sufficiently thin and perfect, should be put aside in a bottle of weak Spirit until they be mounted. For the minute examination of their structure, it is generally best to preserve them in fluid; and no fluid answers better than weak Spirit. Where a mere general view only is needed, Dry-mounting answers the purpose sufficiently well; and there are many Stems, such as the Clematis, of which Transverse Sections rather thicker than ordinary make very beautiful Opaque objects, when mounted dry on a Black Ground. Glycerine-jelly answers very well for most Sections; but Canada Balsam should not be had recourse to except in the case of very opaque sections, as it usually makes the structure too transparent. Transverse sections, however, when slightly charred by heating between two plates of Glass until they turn brown, may be mounted with advantage in Canada Balsam, and are then very showy specimens for the Solar or Gas-Microscope. The number of beautiful and interesting objects which may be thus obtained, at the cost of a very small amount of trouble, can

scarcely be conceived save by those who have made a special study of these wonderful structures. Even the commonest Trees, Shrubs, and Herbaceous Plants, yield specimens that exhibit a varied elaboration of design, which cannot but strike with astonishment even the most cursory observer; and there is none in which a careful study of sections made in different parts of the stem, and especially in the neighbourhood of the 'growing point,' will not reveal to the eye of the scientific Physiologist some of the most important phenomena of Vegetation.—*Fossil Woods*, when well preserved, are almost invariably *Silicified*, and require, therefore, to be cut and polished by a Lapidary. Should the Microscopist be fortunate enough to meet with a portion of a *Calciſied* stem in which the Organic structure is preserved, he should proceed with it after the manner of other hard substances which need to be reduced by grinding (§§ 138-40).

308. *Structure of the Cuticle and Leaves*.—On all the softer parts of the higher Plants, save such as grow under water, we find a surface-layer, differing in its texture from the parenchyma beneath, and constituting a distinct membrane, known as the *Cuticle*. This membrane is composed of Cells, the walls of which are flattened above and below, whilst they adhere closely to each other laterally, so as to form a continuous stratum (Figs. 225, 227, *a, a*). Their shape is different in almost every tribe of Plants; thus in the Cuticle of the *Yucca* (Fig. 221), *Indian Corn* (Fig. 222), *Iris* (Fig. 226), and most other Monocotyledons, the cells are elongated, and present an approach to a rectangular contour; their margins being straight in the *Yucca* and *Iris*, but minutely sinuous or crenated in the *Indian Corn*. In most Dicotyledons, on the other hand, the cells of the Cuticle depart less from the form of circular disks; but their margins usually exhibit large irregular sinuosities, so that they seem to fit together like the pieces of a Dissected Map, as is seen in the cuticle of the *Apple* (Fig. 223, *b, b*). Even here, however, the Cells of that portion of the Cuticle (*a, a*) which overlies the Veins of the leaf, have an elongated form, approaching that of the Wood-cells of which these veins are chiefly composed; and it seems likely, therefore, that the elongation of the ordinary Cuticle-cells of Monocotyledons has reference to that parallel arrangement of the Veins which their Leaves almost constantly exhibit.

309. The Cells of the Cuticle are colourless, or nearly so, no Chlorophyll being formed in their interior; and their walls are generally thickened by secondary deposit, especially on the side nearest the atmosphere. This deposit is of a waxy nature, and consequently renders the membrane very impermeable to fluids, the retention of which within the soft tissue of the leaf is obviously the purpose to be answered by the peculiar organization of the Cuticle. In most European Plants the Cuticle contains but a single row of Cells, which are usually, moreover, thin-sided; whilst

in the generality of Tropical species, there exist two, three, or even four layers of thick-sided Cells ; this last number being seen

FIG. 221.

Cuticle of Leaf of *Yucca*.

FIG. 222.

Cuticle of Leaf of *Indian Corn* (*Zea Mais*).

FIG. 223.

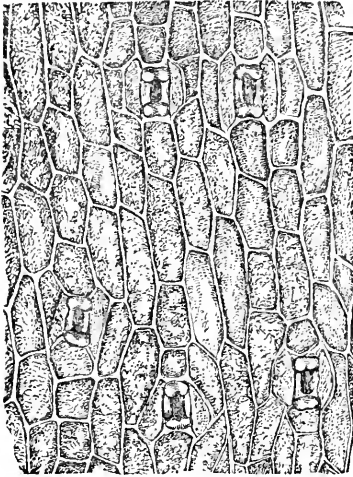

Portion of the Cuticle of the inferior surface of the Leaf of the *Apple*, with the layer of Parenchyma in immediate contact with it:—*a*, *a*, elongated Cells of the Cuticle overlying the Veins of the leaf; *b*, *b*, ordinary Cuticle-cells, overlying the Parenchyma; *c*, *c*, Stomata; *d*, *d*, green Cells of the Parenchyma, forming a very open network near the lower surface of the leaf.

in the *Oleander*, the Cuticle of which, when separated, has an almost leathery firmness. This difference in conformation is obviously adapted to the conditions of growth under which these Plants respectively exist ; since the Cuticle of a plant indigenous to Temperate climates, would not afford a sufficient protection to the interior structure against the rays of a Tropical sun ; whilst the diminished heat of this country would scarcely overcome the resistance presented by the dense and non-conducting tegument of a species formed to exist in Tropical climates.

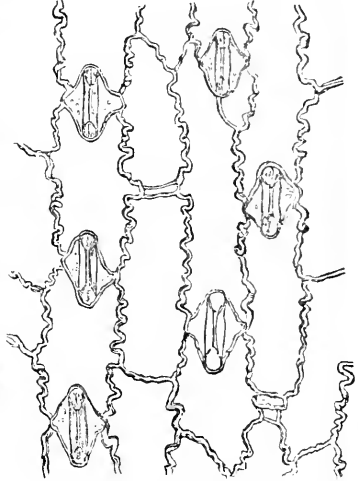
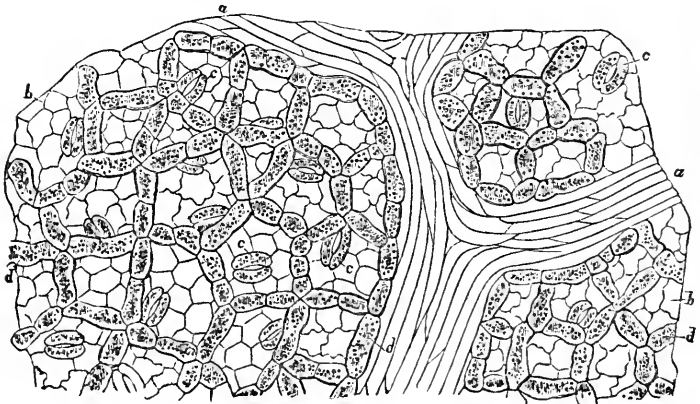
310. A very curious modification of the Cuticle is presented by the *Rochea falcata*, which has the surface of its ordinary cuticle (Figs. 224, 225, *a, a*) nearly covered with a layer of large prominent isolated cells, *b, b*. A somewhat similar structure is found in the *Mesembryanthemum crystallinum*, commonly known as the Ice-Plant ; a designation it owes to the peculiar appearance of its surface, which looks as if it were covered with frozen dewdrops. In other instances, the Cuticle is partially invested by a layer of Scales, which are nothing else than flattened Cells, often having a very peculiar form ; whilst in numerous cases, again, we find the surface beset with Hairs, which occasionally consist of single elongated cells, but are more commonly made up of a linear series, attached end to end, as in Fig. 202. Sometimes these Hairs bear little Glandular bodies at their extremities, by the secretion of which a peculiar viscidty is given to the surface of the leaf, as in the Sundew (*Drosera*) ; in other instances, the Hair has a Gland-

FIG. 224.

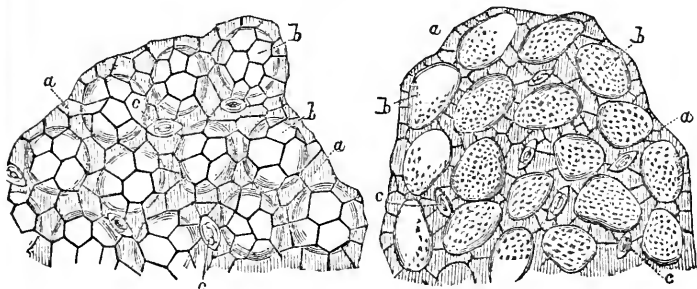

Portion of the Cuticle of the upper surface of the Leaf of *Rochea falcata*, as seen at A from its inner side, and at B from its outer side :—*a, a*, small Cells forming the inner layer of the Cuticle ; *b, b*, large prominent Cells of the outer layer ; *c, c*, Stomata disposed between the latter.

ular body at its base, with whose secretion it is moistened, so that when this secretion is of an irritating quality, as in the *Nettle*, it constitutes a 'Sting.' A great variety of such organs may be found, by a microscopic examination of the surface of the leaves

of Plants having any kind of superficial investment to the cuticle. Many connecting links present themselves between Hairs and Scales, such as the Stellate Hairs of the *Deutzia scabra*, which a good deal resemble those with in the air-chambers of the Yellow Water-lily (Fig. 200).

FIG. 225.

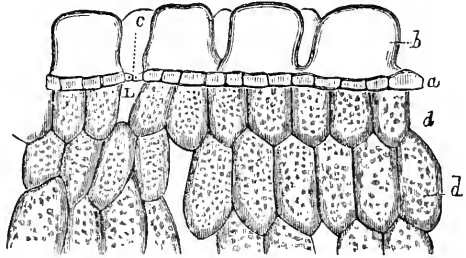

Portion of vertical section of Leaf of *Rochea*, showing the small Cells, *a, a*, of the inner layer of Cuticle; the large Cells, *b, b*, of the outer layer; *c*, one of the Stomata; *d, d*, Cells of the Parenchyma; *L*, lacuna between the Parenchymatous Cells, into which the Stoma opens.

311. The Cuticle in many Plants, especially those belonging to the *Grass* tribe, has its cell-walls impregnated with Silex like that of the *Equisetum* (§ 281); so that when the Organic matter seems to have been got-rid-of

by heat or by acids, the forms of the Cuticle-cells, Hairs, Stomata, &c., are still marked-out in Silex, and (unless the dissipation of the Organic matter has been most perfectly accomplished) are most beautifully displayed by Polarized light. Such Silicified Cuticles are found in the Husks of the Grains yielded by these plants: and there is none in which a larger proportion of Mineral matter exists, than that of *Rice*, which contains some curious elongated cells with toothed margins. The Hairs with which the *Paleæ* (chaff-scales) of most Grasses are furnished, are strengthened by the like siliceous deposit; and in the *Festuca pratensis*, one of the common Meadow-Grasses, the paleæ are also beset with longitudinal rows of little cup-like bodies formed of silica. The Cuticle and Scaly Hairs of *Deutzia scabra* also contain a large quantity of Silex; and are remarkably beautiful objects for the Polariscope.

312. Externally to the Cuticle there usually exists a very delicate transparent pellicle, without any decided traces of organization, though occasionally somewhat granular in appearance, and marked by lines that seem to be impressions of the junctions of the cells with which it was in contact. When detached by maceration, it not only comes-off from the surface of the Cuticle, but also from that of the Hairs, &c., which this may bear. This membrane is obviously formed by the agency of the Cells of the Cuticle; and it seems to consist of the external layers of their thickened Cellulose walls, which have coalesced with each other, and have separated themselves from the subjacent layers, by a change somewhat

analogous to that which occurs in the Palmelleæ (§ 317), the outer walls of whose original cells seem to melt-away into the gelatinous investment that surrounds the 'broods' which have originated in their subdivision.

313. In nearly all Plants which possess a distinct Cuticle, this is perforated by the minute openings termed *Stomata* (Figs. 223, 224, c, c); which are bordered by Cells of a peculiar form, distinct from those of the Cuticle, and more resembling in character those of the tissue beneath. These boundary-cells are usually somewhat kidney-shaped, and lie in pairs (Fig. 226, b, b), with an oval opening

between them; but by an alteration in their form, the opening may be contracted or nearly closed. In the Cuticle of *Yucca*, however, the opening is bounded by two pairs of cells, and is somewhat quadrangular (Fig. 221); and a like doubling of the boundary-cells, with a narrower slit between them, is seen in the cuticle of the *Indian Corn* (Fig. 222). In the Stomata of no Phanerogamic Plant, however, do we meet with any conformation at all to be compared in complexity with that which has

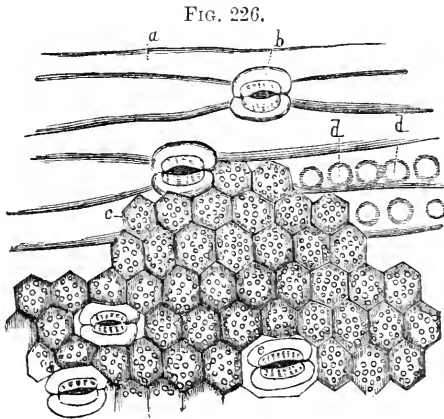

Portion of the Cuticle of the Leaf of the *Iris germanica*, torn from its surface, and carrying away with it a portion of the Parenchymatous layer in immediate contact with it:—a, a, elongated cells of the cuticle; b, b, cells of the stomata; c, c, cells of the parenchyma; d, d, impressions on the epidermic cells formed by their contact; e, e, lacunæ in the parenchyma, corresponding to the stomata.

been described as existing in the humble *Marchantia* (§ 272).—Stomata are usually found most abundantly (and sometimes exclusively) in the Cuticle of the lower surfaces of Leaves, where they open into the Air-chambers that are left in the Parenchyma which lies next the inferior cuticle; in Leaves which float on the surface of water, however, they are found in the Cuticle of the upper surface only; whilst in Leaves that habitually live entirely submerged, as there is no distinct Cuticle, so there are no Stomata. In the erect Leaves of Grasses, the *Iris* tribe, &c., they are found equally (or nearly so) on both surfaces. As a general fact, they are least numerous in succulent Plants, whose moisture, obtained in a scanty supply, is

destined to be retained in the system ; whilst they abound most in those which exhale fluid most readily, and therefore absorb it most quickly. It has been estimated that no fewer than 160,000 are contained in every square inch of the under surface of the Leaves of *Hydrangea* and of several other plants ; the greatest number seeming always to present itself in species, the upper surface of whose leaves is entirely destitute of these organs. In *Iris germanica*, each surface has nearly 12,000 stomata in every square inch ; and in *Yucca*, each surface has 40,900.—In *Oleander*, *Banksia*, and some other plants, the Stomata do not open directly upon the lower surface of the Cuticle, but lie in the deepest part of little pits or depressions, which are excavated in it and lined with hairs ; the mouths of these pits, with the hairs that line them, are well brought into view by taking a thin slice from the surface of the Cuticle with a sharp knife ; but the form of the cavities and the position of the Stomata can only be well made out in vertical sections of the leaves.

314. The Internal Structure of *Leaves* is best brought into view by making vertical sections, that shall traverse the two layers of Cuticle and the intermediate Cellular Parenchyma ; portions of such sections are shown in Figs. 225, 227, and 228. In close

FIG. 227.

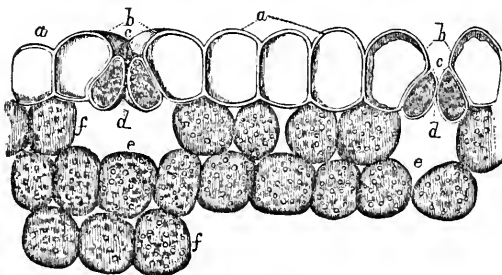

Vertical section of the Cuticle, and of a portion of the subjacent Parenchyma, of a Leaf of *Iris germanica*, taken in a transverse direction :—*a, a*, Cells of the Cuticle ; *b, b*, Cells at the sides of the Stomata ; *c, c*, small green Cells placed within these ; *d, d*, openings of the Stomata ; *e, e*, lacunæ of the Parenchyma into which the Stomata open ; *f, f*, Cells of the Parenchyma.

which the Stoma opens (Fig. 227, *e*) ; and the compactness of this superficial layer is well seen, when, as often happens, it adheres so closely to the Cuticle as to be carried away with this when it is torn off (Fig. 226, *c, c*). Beneath this first layer of Leaf-Cells,

apposition with the cells of the upper Cuticle (Fig. 227, *a, a*), which may or may not be perforated with Stomata (*c, c, d, d*), we find a layer of soft thin-walled Cells, containing a large quantity of Chlorophyll ; these generally press so closely one against another, that their sides become mutually flattened, and no spaces are left, save where there is a definite Air-chamber into

there are usually several others rather less compactly arranged ; and the tissue gradually becomes more and more lax, its Cells not being in close apposition, and large Intercellular Passages being left amongst them, until we reach the lower Cuticle, which the Parenchyma only touches at certain points, its lowest layer forming a set of network (Fig. 223, *d, d*) with large interspaces, into which the Stomata open. It is to this arrangement that the darker shade of green almost invariably presented by the superior surfaces of Leaves is principally due ; the colour of the component Cells of the Parenchyma not being deeper in one part of the Leaf than in another.—In those Plants, however, whose Leaves are erect instead of being horizontal, so that their two surfaces are equally exposed to light, the Parenchyma is arranged on both sides in the same manner, and their Cuticles are furnished with an equal number of Stomata. This is the case, for example, with the Leaves of the common Garden *Iris* (Fig. 228) ; in which, moreover, we find a

FIG. 228.

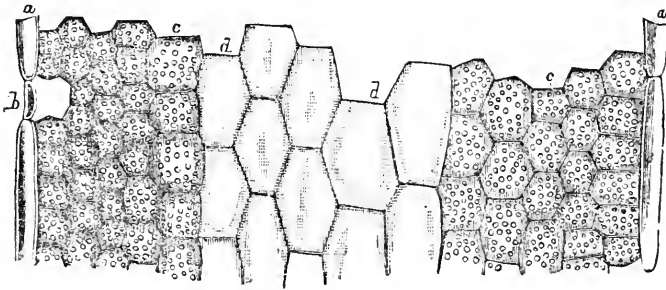

Portion of a Vertical longitudinal section of the Leaf of *Iris*, extending from one of its flattened sides to the other:—*a, a*, elongated Cells of the Cuticle ; *b, b*, Stomata cut-through longitudinally ; *c, c*, green Cells of the Parenchyma ; *d, d*, colourless tissue, occupying the interior of the leaf.

central portion (*d, d*) formed by thick-walled colourless tissue, very different either from ordinary Leaf-cells or from Woody Fibre. The explanation of its presence is to be found in the peculiar conformation of the leaves ; for if we pull one of them from its origin, we shall find that what appears to be the flat expanded blade really exposes but half its surface ; the blade being doubled together longitudinally, so that what may be considered its under surface is entirely concealed. The two halves are adherent together at their upper part, but at their lower they are commonly separated by a new leaf which comes-up between them ; and it is from this arrangement, which resembles the position of the legs of a man on horseback, that the leaves of the *Iris* tribe are said to

be *equitant*. Now by tracing the middle layer of colourless Cells, *d, d*, down to that lower portion of the leaf where its two halves diverge from one another, we find that it there becomes continuous with the Cuticle, to the cells of which (Fig. 226, *a*) these bear a strong resemblance in every respect save the greater proportion of their breadth to their length.—Another interesting variety in Leaf-structure is presented by the *Water-Lily* and other Plants whose leaves float on the surface ; for here the usual arrangement is entirely reversed, the closely-set layers of green Leaf-Cells being found in contact with the lower surface, whilst all the upper part of the leaf is occupied by a loose spongy Parenchyma, containing a very large number of Air-spaces that give buoyancy to the leaf ; and these spaces communicate with the external air through the numerous Stomata, which, contrary to the general rule (§ 313), are here found in the upper Cuticle alone.

315. The examination of the foregoing structures is attended with very little difficulty. Many Cuticles may be torn-off, by the exercise of a little dexterity, from the surfaces of the Leaves they invest, without any preparation : this is especially the case with Monocotyledonous plants, the Veins of whose leaves run parallel, and with such Dicotyledons as have very little woody structure in their leaves ; in those, on the other hand, whose Leaves are furnished with reticulated Veins to which the Cuticle adheres (as is the case in by far the larger proportion), this can only be detached by first macerating the leaf for a few days in water ; and if their texture should be particularly firm, the addition of a few drops of nitric acid to the water will render their cuticles more easily separable. Cuticles may be advantageously mounted in weak spirit, or in Glycerine-Jelly, if it be desired to preserve them.—Very good sections of most Leaves may be made by a sharp Knife, handled by a careful manipulator ; but it is generally preferable to use Valentin's Knife (§ 136) or the Section-Instrument (§ 137) ; taking care in the former case to cut-down upon a piece of fine Cork ; and in the latter not to crush the leaf between the two pieces of cork that hold it, very soft cork being used whenever the delicacy of the Leaf renders this desirable. In order to study the structure of Leaves with the fulness that is needed for scientific research, numerous sections should be made in different directions ; and slices taken parallel to the surfaces, at different distances from them, should also be examined. There is no known medium in which such Sections can be preserved altogether without change ; but some one of the methods formerly described (§ 163) will generally be found to answer sufficiently well.

316. *Structure of Flowers*.—Many small Flowers are, when looked-at entire with a low magnifying power, very striking Microscopic objects ; and the interest of the young in such observations can scarcely be better excited, than by directing their attention to the new view they thus acquire of the 'Composite'

nature of the humble down-trodden *Daisy*, or to the beauty of the minute blossoms of many of those *Umbelliferous* Plants which are commonly regarded only as rank weeds. The scientific Microscopist, however, looks more to the organization of the separate parts of the Flower; and among these he finds abundant sources of gratification, not merely to his love of knowledge, but also to his taste for the beautiful. The general structure of the *Sepals* and *Petals*, which constitute the Perianth or Floral Envelopes, closely corresponds with that of Leaves; the chief difference lying in the peculiar change of hue which the Chlorophyll almost invariably undergoes in the latter class of organs, and very frequently in the former also. There are some Petals, however, whose cells exhibit very interesting peculiarities, either of form or marking, in addition to their distinctive coloration; * such are those of the *Geranium* (*Pelargonium*), of which a small portion is represented in Fig. 229. The different portions of this Petal,—when it has been dried after stripping it of its cuticle, immersed for an hour or two in oil of tur-

pentine, and then mounted in Canada balsam,—exhibit a most beautiful variety of vivid coloration, which is seen to exist chiefly in the thickened partitions of the cells; whilst the surface of each cell presents a very curious opaque spot with numerous diverging prolongations. This method of preparation, however, does not give a true idea of the structure of the cells;

for each of them has a peculiar mammillary protuberance, the base of which is surrounded by hairs; and this it is which gives the velvety appearance to the surface of the petal, and which, when altered by drying and compression, occasions the peculiar spots represented in Fig. 229. The real character may be brought into view by Dr. Inman's method; which consists in drying the Petal (when stripped of its Cuticle) on a slip of glass, to which it adheres, and then placing on it a little Canada Balsam diluted with Turpentine, which is to be boiled for an instant over the Spirit-

FIG. 229.

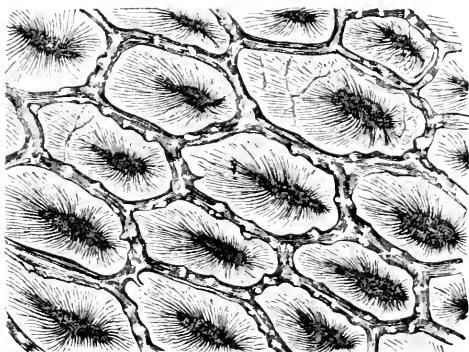
Cells from the Petal of the *Geranium*
(*Pelargonium*).

* See especially Mr. Tuffen West 'On some Conditions of the Cell-Wall in the Petals of Flowers,' in "Quart. Journ. of Microsc. Science," Vol. vii. (1859), p. 22.

lamp, after which it is to be covered with a thin glass. The boiling 'blisters' it, but does not remove the colour; and on examination many of the Cells will be found showing the mammilla very distinctly, with a score of hairs surrounding its base, each of these slightly curved, and pointing towards the apex of the mammilla.—The Petal of the common Scarlet Pimpernel (*Anagallis arvensis*), that of the common Chickweed (*Stellaria media*), together with many others of a small and delicate character, are also very beautiful microscopic objects; and the two just named are peculiarly favourable subjects for the examination of the Spiral Vessels in their natural position. For the Veins which traverse these petals are entirely made-up of Spiral Vessels, none of which individually attain any great length; but one follows or takes the place of another, the conical commencement of each somewhat overlapping the like termination of its predecessor; and where the Veins seem to branch, this does not happen by the bifurcation of a Spiral Vessel, but by the 'splicing-on' (so to speak) of one to the side of another, or by the 'splicing-on' of two new vessels diverging from one another, to the end of that which formed the principal vein.*

317. The *Anthers* and *Pollen-grains*, also, present numerous objects of great interest, both to the scientific Botanist and to the amateur Microscopist. In the first place, they afford a good opportunity of studying that form of 'free' Cell-development, which seems peculiar to the parts concerned in the Reproductive process, and which consists in the development of a new Cell-wall round an isolated mass of Protoplasm forming part of the contents of a 'parent-cell;' so that the new Cell lies free within its cavity, instead of being developed in continuity with it, as in the ordinary methods of multiplication (§ 249). If the Anther be examined by thin sections at an early stage of its development within the young flower-bud, it will be found to be made-up of ordinary Cellular Parenchyma in which no peculiarity anywhere shows itself: but a gradual 'differentiation' speedily takes-place, consisting in the development of a set of very large Cells in two vertical rows, which occupy the place of the *Loculi* or Pollen Chambers that afterwards present themselves; and these Cells give origin to the Pollen-Grains, whilst the ordinary Parenchyma remains to form the walls of the Pollen-Chambers. The first change consists in the multiplication of the Cells of the primary row by cell-division, in correspondence with the general increase in the size of the Anther; until at length they form masses of considerable size, composed of large squarish cells, filled with granular contents, well-defined as constituting a distinct tissue from the walls of the Pollen-Chambers. The history of the development of the Pollen-Grains in their interior is thus described by Mr. Henfrey,

* See Mr. R. H. Solly's description and figure of the petal of the *Anagallis*, in "Trans. of Soc. of Arts," Vol. xlviii.

who made a special study of it. "The contents of each of these cells secrete a layer of cellulose, which does not adhere to the wall of the parent-cell to form a layer of secondary deposit, but lies free against it, so that a new free cell is formed within each old one, nearly filling it. The walls of the old cells then dissolve, so that the free cells become free, no longer in their parent-cells, but in a cavity which is to constitute the pollen-chamber or loculus of the anther. These free cells are the 'parent-cells of the pollen' of authors. A new phenomenon soon occurs in these. These parent-cells divide into four by ordinary cell-division; either by one or two successive partings, by septa at right angles to each other, but both perpendicular to an imaginary axis (as when an orange is quartered); or by simultaneously formed septa, which cut-off portions in such a manner, that the new cells stand in the position of cannon balls piled into a pyramid (tetrahedrally). These new cells are the 'special parent-cells of the pollen;' and in each of these the entire protoplasmic contents secrete a series of layers, which, in the ordinary course, by the solution of the primary walls of the special parent-cells upon which they were applied, become the walls of free-cells, which constitute the simple ordinary pollen-cells. These subsequently increase in size, and their outer coat assumes its characteristic form and appearance, while free in the chamber of the anther."* This history bears a very close parallel with that of the development of the spores within the Theca of Mosses (§ 277); and it is not a little curious that the layer of cells which lines the Pollen Chambers should exhibit, in a considerable proportion of Plants, a strong resemblance in structure, though not in form, to the Elaters of *Marchantia* (Fig. 180). For they have in their interior a Fibrous deposit; which sometimes forms a continuous spiral (like that in Fig. 206), as in *Narcissus* and *Hyosciamus*; but is often broken-up, as it were, into rings, as in the *Iris* and *Hyacinth*; in many instances forms an irregular net-work, as in the *Violet* and *Saxifrage*; in other cases, again, forms a set of interrupted arches, the fibres being deficient on one side, as in the *Yellow Water-lily*, *Bryony*, *Primrose*, &c.; whilst a very peculiar stellate aspect is often given to these Cells, by the convergence of the interrupted fibres towards one point of the cell-wall, as in the *Cactus*, *Geranium*, *Madder*, and many other well-known plants. Various intermediate modifications exist; and the particular form presented often varies in different parts of the wall of one and the same anther. It seems probable that, as in *Hepaticæ*, the elasticity of these Spiral Cells may have some share in the opening of the Pollen-Chambers and in the dispersion of the Pollen-Grains.

318. The form of the Pollen-Grains seems to depend in part upon the mode of division of the cavity of the parent-cell into

* "Micrographic Dictionary," 2nd Edition, p. 558.

quarters ; generally speaking it approaches the spheroidal, but it is sometimes elliptical, and sometimes tetrahedral. It varies more, however, when the Pollen is dry, than when it is moist ; for the effect of the imbibition of fluid, which usually takes-place when the Pollen is placed in contact with it, is to soften-down angularities, and to bring the cell nearer to the typical sphere. The Pollen-Cell (save in a few submerged plants) has a thick outer coat surrounding a thin interior wall ; and this often exhibits very curious markings, which seem due to an increased thickening at some points and a thinning-away at others. Sometimes these markings give to the surface-layer so close a resemblance to a stratum of cells (Fig. 230, B, c, D), that only a very careful examination can detect

FIG. 230.

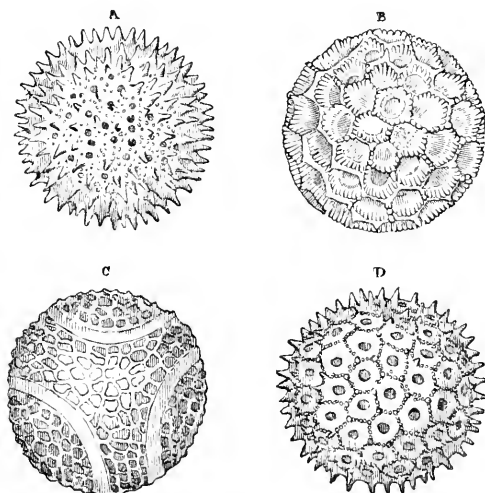

Pollen-grains of,—A, *Althaea rosea* ; B, *Cobaea scandens* ; C, *Passiflora carulea* ; D, *Ipomoea purpurea*.

nation can detect the difference. The roughening of the surface by spines or knobby protuberances, as shown at A, is a very common feature ; and this seems to answer the purpose of enabling the Pollen-Grains more readily to hold to the surface whereon they may be cast. Besides these and other inequalities of the surface, most Pollen-Grains have what appear to be pores or slits in the outer coat, varying in number in different species, through which

the inner coat protrudes itself as a tube when the bulk of its contents has been increased by imbibition ; it seems probable, however, that the outer coat is not absolutely deficient at these points, but is only thinned-away. Sometimes the pores are covered by little disk-like pieces, or lids which fall-off when the Pollen-Tube is protruded. This action takes-place naturally when the Pollen-Grains fall upon the surface of the Stigma, which is moistened with a viscid secretion ; and the Pollen-Tubes, at first mere protrusions of

the inner coat of their cell, insinuating themselves between the loosely-packed cells of the Stigma, grow downwards through the Style, sometimes even to the length of several inches, until they reach the Ovarium. The first change,—namely, the protrusion of the inner membrane through the pores of the exterior,—may be made to take-place artificially, by moistening the Pollen with water, thin syrup, or dilute acids (different kinds of Pollen-Grains requiring different modes of treatment); but the subsequent extension by growth will only take-place under the natural conditions.

319. The darker kinds of Pollen may be best mounted for the Microscope in Canada balsam; but as this renders the more transparent kinds too faintly distinguishable, it is better to mount them either dry or (if they will bear it without rupturing) in fluid. The most delicate and interesting forms are found, for the most part, in plants of the Natural families *Amarantaceæ*, *Uchioraceæ*, *Cucurbitaceæ*, *Mulvaceæ*, and *Passifloreæ*; others are furnished also by *Convolvulus*, *Campanula*, *Œnothera*, *Pelargonium* (Geranium), *Polygonum*, *Sedum*, and many other Plants. It is frequently preferable to lay-down the entire Anther with its adherent Pollen-Grains (where these are of a kind that hold to it), as an opaque object; this may be done with great advantage in the case of the common Mallow (*Malva sylvestris*) or of the Hollyhock (*Althæa rosea*); the Anthers being picked soon after they have opened, whilst a large proportion of their Pollen is yet undischarged; and before they have begun to wither, being laid down as flat as possible between two pieces of smooth Blotting-Paper, then subjected to moderate pressure, and finally mounted upon a black surface. They are then, when properly illuminated, most beautiful objects for Objectives of 2-3rds, 1, 1½, or 2 in. focus, especially with the Binocular Microscope.

320. The structure and development of the *Ovules* that are produced within the Ovarium at the base of the Pistil, and the operation in which their Fertilization essentially consists, are subjects of investigation which have a peculiar interest for scientific Botanists, but which, in consequence of the special difficulties that attend the inquiry, are not commonly regarded as within the province of amateur Microscopists.—The Ovule, in its earliest condition, is, like the Anther, a mass of cells in which no part is differentiated from the rest; gradually this body, which is termed the *Nucleus*, is found to be enveloped in one, two, or three coats, which are formed by the multiplication of cells that at first constitute merely an annular enlargement at its base; these coats, however, do not entirely close-in around the nucleus, at the point of which there always remains a small aperture called the *Micropyle*. In the interior of the nucleus a large cavity is formed, apparently by the enlargement of one of its cells at the expense of those which surround it; and this cavity, which is called the *Embryo-sac*, is at first filled only with a liquid Protoplasm. Some little time before

fecundation, however, a small number of peculiar corpuscles, which seem to be unwallled masses of viscid protoplasm, are seen lying freely in this liquid, near the apex of the Embryo-sac; these are incipient Germ-cells, of which one only, the *Embryonal Corpuscle*, is ordinarily destined to be fertilized. This act is accomplished by the penetration of the Pollen-tube, which, when it has made its way down to the ovarium, enters the Micropyle of the Ovule, and impinges upon the apex of the Embryo-sac, which it sometimes pushes before it in such a manner as to have given origin to the idea that the tube enters its cavity: no such penetration, however, really takes place; and it is only by transudation through the membrane of the Embryo-sac, as well as that of the Pollen-tube, that the contents of the latter can reach the interior of the former. As a consequence of this transudation (the influence of which seems to be the same as that of the contact of the Antherozoids in the Cryptogamia) the Embryonal Corpuscle is completed into a Cell by the development of a Cellulose-wall around it; and the production of this Primordial Cell lays the foundation of the fabric of the Embryo, which is developed from it like the brood that springs from the Oo-spore of the Protophytes.

321. The early processes of Embryonic Development correspond closely with those which have been described as taking place through the whole of the inferior tribes: for the Primordial Cell gives origin by binary subdivision to a pair, this again to four, and so on; it being usually in the terminal cell of the filament so generated, that the process of multiplication chiefly takes-place, as in the Confervæ (§ 249). The filament then begins to enlarge at its lower extremity, where its cells are often multiplied into a somewhat globular mass; of this mass, by far the larger proportion is destined to be evolved into the *Cotyledons*, or Seed-Leaves, whose function is limited to the earliest part of the life of the young Plant; the small remainder is the rudiment of the *Plumula*, which is to be developed into the Stem and Leaves; while the prolonged extremity of the embryonic filament which is directed towards the Micropyle, is the original of the *Radicle* or embryonal Root. The mucilaginous protoplasm filling the Embryo-sac, in which the Embryonal Corpuscle was imbedded, becomes converted by the formation of free cells, soon after fecundation, into a loose cellular tissue, which constitutes what is known as the *Endosperm*; this, however, usually deliquesces again, as the embryonal mass increases in bulk and presses upon it.*

322. In tracing the origin and early history of the Ovule, very thin sections should be made through the Flower-bud, both verti-

* A more detailed account of the Generative process in Phanerogamia will be found in the article 'Reproduction, Vegetable,' in the "Cyclopædia of Anatomy and Physiology," Supplement, p. 211. The most recent information on the subject will be found in Prof. Hofmeister's "Neue Beiträge zur Kenntniss der Embryo-bildung der Phanerogamen," Leipzig, 1859-61.

cally and transversely; but when the Ovule is large and distinct enough to be separately examined, it should be placed on the thumb-nail of the left hand, and very thin sections made with a sharp razor; the ovule should not be allowed to dry-up, and the section should be removed from the blade of the razor by a wetted camel-hair pencil. The tracing-downwards the Pollen-Tubes through the tissue of the Style, may be accomplished by sections (which, however, will seldom follow one tube continuously for any great part of its length), or, in some instances, by careful dissection with needles. Plants of the *Orchis* tribe are the most favourable subjects for this kind of investigation, which is best carried-on by artificially applying the Pollen to the Stigma of several flowers, and then examining one or more of the styles daily. "If the style of flower of an *Epipactis* (says Schacht), to which the Pollen has been applied about eight days previously, be examined in the manner above mentioned, the observer will be surprised at the extraordinary number of Pollen-tubes, and he will easily be able to trace them in large strings, even as far as the Ovules. *Viola tricolor* (Heartsease) and *Ribes nigrum* and *rubrum* (Black and Red Currant) are also good plants for the purpose; in the case of the former plant, withered flowers may be taken, and branched pollen-tubes will not unfrequently be met-with." The entrance of the Pollen-tube into the Micropyle may be most easily observed in *Orchideous* plants and in *Euphrasia*; it being only necessary to tear-open with a needle the Ovary of a flower which is just withering, and to detach from the Placenta the Ovules, almost every one of which will be found to have a Pollen-tube sticking in its Micropyle. These Ovules, however, are too small to allow of sections being made, whereby the origin of the embryo may be discerned; and for this purpose, *Ænothera* (Evening Primrose) has been had recourse to by Hoffmeister, whilst Schacht recommends *Lathræa squamaria*, *Pedicularis palustris*, and particularly *Pedicularis sylvatica*.

323. We have now, in the last place, to notice the chief points of interest to the Microscopist which are furnished by mature *Seeds*. Many of the smaller kinds of these bodies are very curious, and some are very beautiful objects, when looked-at in their natural state under a low magnifying power. Thus the Seed of the *Poppy* (Fig. 231, A) presents a regular reticulation upon its surface, pits for the most part hexagonal being left between projecting walls; that of *Caryophyllum* (D) is regularly covered with curiously-jagged divisions, every one of which has a small bright black hemispherical knob in its middle; that of *Amaranthus hypochondriacus* has its surface traced with extremely delicate markings (B); that of *Antirrhinum* is strangely irregular in shape (C), and looks almost like a piece of furnace-slag; and that of many *Bignoniaceæ* is remarkable for the beautiful radiated structure of the translucent membrane which surrounds it (E).

This structure is extremely well seen in the Seed of the *Eccremocarpus scaber*, a half-hardy climbing plant now common in our gardens; and when its membranous 'Wing' is examined under a sufficient magnifying power, it is found to be formed by an extraordinary elongation of the cells of the seed-coat at the margin of

FIG. 231.

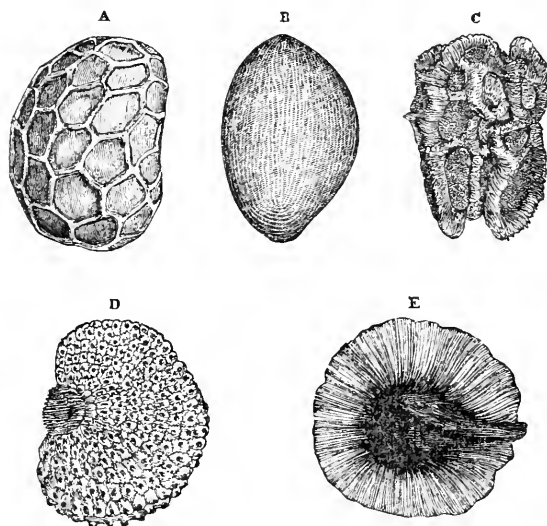

Seeds, as seen under a low magnifying power:—A, *Poppy*; B, *Amaranthus* (Prince's feather); C, *Antirrhinum majus* (Snap-dragon); D, *Caryophyllum* (Clove-pink); E, *Bignonia*.

the seed, the side-walls of which cells (those, namely, which lie in contact with one another) are thickened so as to form radiating ribs for the support of the wing, whilst the front and back walls (which constitute its membranous surface) retain their original transparency, being marked only with an indication of spiral deposit in their interior. In the seed of *Dictyoloma Peruviana*, besides the principal Wing prolonged from the edge of the seed-coat, there is a series of successively smaller wings, whose margins form concentric rings over either surface of the seed; and all these wings are formed of radiating fibres only, composed, as in the preceding case, of the thickened walls of adjacent cells; the intervening membrane, originally formed by the front and back walls of these cells, having disappeared, apparently in consequence of being unsupported by any secondary deposit.* Several other

* See Brady in "Transactions of Microsc. Society," N.S., Vol. ix. (1861), p. 65.

Seeds, as those of *Sphenogyne speciosa* and *Lophospermum erubescens*, possess wing-like appendages; but the most remarkable development of these organs is said by Mr. Quekett to exist in a seed of *Calosanthus Indica*, an East Indian plant, in which the Wing extends more than an inch on either side of the seed.—Some Seeds are distinguished by a peculiarity of form, which, although readily discernible by the naked eye, becomes much more striking when they are viewed under a very low magnifying power; this is the case, for example, with the Seeds of the *Carrot*, whose long radiating processes make it bear, under the Microscope, no trifling resemblance to some kinds of Star-fish; and with those of *Cyanthus minor*, which bear about the same degree of resemblance to shaving-brushes. In addition to the preceding, the following may be mentioned as Seeds easily to be obtained, and as worth mounting for opaque objects:—*Anagallis*, *Anethum graveolens*, *Begonia*, *Carum carui*, *Coriopsis tinctoria*, *Datura*, *Delphinium*, *Digitalis*, *Elatine*, *Erica*, *Gentiana*, *Gesnera*, *Hyosciamus*, *Hypericum*, *Lepidium*, *Limncharis*, *Linaria*, *Lychnis*, *Mesembryanthemum*, *Nicotiana*, *Origamme onites*, *Orobanche*, *Petunia*, *Reseda*, *Saxifraga*, *Scrophularia*, *Sedum*, *Sempervivum*, *Silene*, *Stellaria*, *Symphytum asperrimum*, and *Verbena*. The following may be mounted as transparent objects in Canada balsam:—*Drosera*, *Hydrangea*, *Monotropa*, *Orchis*, *Parnassia*, *Pyrola*, *Saxifraga*.* The Seeds of Umbelliferous plants generally are remarkable for the peculiar *Vittæ*, or receptacles for essential oil, which are found in their coats. Various points of interest respecting the structure of the *Testæ* or Envelopes of seeds,—such as the Fibre-cells of *Cobæa* and *Colomia*, the Stellate cells of the *Star-Anise*, and the densely-consolidated tissue of the ‘Shells’ of the *Coquilla-nut*, *Cocoa-nut*, &c.,—having been already noticed, we cannot here stop to do more than advert to the peculiarity of the constitution of the Husk of the *Corn-grains*. In these, as in other Grasses, the Ovary itself continues to envelope the seed, giving a covering to it that surrounds its own testa: this covering (which forms the ‘bran’ that is detached in grinding) is composed of hexagonal cells of remarkable regularity and density; and these are so little altered by a high temperature, as still to be readily distinguishable when the grain has been ground after roasting,—thus enabling the Microscopist to detect even a small admixture of Roasted Corn with Coffee or Chicory, without the least difficulty.†

* These lists have been chiefly derived from the “Micrographic Dictionary.”

† In a case in which the Author was called-upon to make such an investigation, he found as many as *thirty* distinctly-recognizable fragments of this cellular envelope, in a *single grain* of a mixture consisting of Chicory with only 5 per cent. of roasted Corn.

CHAPTER IX.

MICROSCOPIC FORMS OF ANIMAL LIFE :—PROTOZOA ;
ANIMALCULES.

324. PASSING-ON, now, to the Animal Kingdom, we begin by directing our attention to those minute and simple forms which correspond, in the Animal Series, with the *Protophyta* in the Vegetable (Chap. VI.) ; and this is the more desirable, since the formation of a distinct group to which the name of PROTOZOA (first proposed by Siebold) may be appropriately given, is not merely one of the most interesting results of recent Microscopic inquiry, but is a subject on which it is particularly important that the Microscopic observer should know what the Physiologist believes himself to have ascertained. This group, which must be placed at the very base of the Animal scale, beneath the great Sub-Kingdoms marked-out by Cuvier, is characterized by the extreme simplicity that prevails in the structure of the beings composing it ; for in the lowest of them there is absolutely nothing that can be properly called 'organization,' while in the highest there is no such differentiation of parts as constitutes the 'organs' of even the simplest Zoophyte or Worm.—As we have seen (§ 183) that among the lowest Protophytes all the essential processes of Vegetative life may be carried on by a minute mass of 'protoplasm' which is not even bounded by a distinct limitary membrane, so as to constitute a cell,—the differentiation between cell-wall and cell-contents not having yet manifested itself,—so amongst the lowest Protozoa we find the power of maintaining an independent existence of a kind essentially similar to that of the higher Animals to be possessed by similar particles of that peculiar *blastema*, or formative substance, to which the name *sarcode* (expressive of its rudimental relation to the flesh of higher animals) was given by Dujardin, who first drew attention to its extraordinary endowments. This Animal 'sarcode' very closely resembles the 'protoplasm' of Vegetables in chemical composition and behaviour with re-agents, and in many of its vital manifestations ; but a definite distinction seems to exist between even the simplest Protophyte

and the simplest Protozoon, in regard alike to the nature of the aliment on which each respectively is supported, and to the means by which that aliment is introduced (§180). Hence these simplest members of the two Kingdoms, which can scarcely be distinguished from each other by any *structural* characters, seem to be *physiologically* separable by the mode in which they perform those actions wherein their life most essentially consists; for the *Protophyte* decomposes Carbonic acid under the influence of Light, and generates Chlorophyll and Albuminous compounds, in a manner in all respects comparable to that in which the same operations are performed by the leaf-cells of the most perfect Plant; whilst the *Protozoon* ingests and digests both Vegetable and Animal food, and applies it to the nutrition of its body, no less effectively than an Animal possessing the most complex digestive and circulating apparatus. And in the present state of our knowledge, we seem justified in laying it down as the most ready and certain differential character we are acquainted with, between those Protophytes and Protozoa which are apparently most closely related to each other in the simplicity of their structure, that the former (with the exception of the Fungi) decompose carbonic acid under the influence of light, and acquire a red or green colour from the new compounds which they form in their interior; whilst the latter, having no such power, receive animal and vegetable organisms, or particles of such, into the interior of their bodies, where they extract from them the ready prepared nutriment they are fitted to yield.*

325. RHIZOPODA.—The lowest Order of the Protozoa consists of a group of minute animals which were formerly ranked among *Infusoria*, but were first separated from that group by Dujardin, who conferred upon them the name by which they are now known; that name (which means 'root-footed') being the most appropriate expression yet given of the leading feature in their organization, namely, the extension of their sarcode-body into long processes, termed *pseudopodia* (false feet), which serve at the same time as instruments of locomotion and as prehensile organs for obtaining food. The other characters by which this group is distinguished from ordinary Animalcules are for the most part negative; consisting in the *absence* of any definite mouth or digestive cavity, and in the want of an enveloping membrane sufficiently firm to resist the introduction of particles from with-

* Many instances have been cited, of *Animalcules* acquiring a green colour by the decomposition of Carbonic acid under the influence of light; but there can be no doubt in the mind of any one who is familiar with the results of recent Microscopic research, that in all these cases the supposed Animalcules were really *Protophytes*. The peculiarities in the nutrition of Fungi, which have been already adverted-to (§§ 263-270), whilst separating them from ordinary Protophytes, do not give them any title to a place in the Animal kingdom.

out into the substance of the body at any point. That body may be almost entirely enclosed within a shelly or horny casing ; but one or more apertures always exist in that casing, through which the prolongations of the sarcode-body are put forth ; and the particles of food introduced by their instrumentality no more enter into the interior of that body by any definite mouth, than they do in the naked or shell-less forms. In the lowest Rhizopods, indeed, there seems no distinction whatever between the containing and the contained portion of the sarcode-body, the whole being apparently composed of a viscid homogeneous protoplasm. In the highest, which most nearly approach those more elevated Protozoa that exhibit a more or less definite organization, there is a decided differentiation between the external or containing and the internal or contained portion of the sarcode-body ; to the former, which sometimes has an almost membranous firmness, the name *Ectosarc* has been given ; whilst the latter, which is a liquid of almost watery thinness, has received the name of *Endosarc*. Now upon the degree of this differentiation between the Ectosarc and the Endosarc depends the character of the Pseudopodial prolongations ; and these may present themselves under three distinct conditions ; namely (1), as indefinite extensions of the viscid homogeneous Protoplasm, freely branching and subdividing into threads of extreme tenuity, and undergoing complete mutual coalescence wherever they come into contact (Fig. 232), so as to form an irregular network that may be likened to an animated Spider's-web ; (2) as more definite rod-like extensions of the Ectosarc, having a more or less regular radiating arrangement (Fig. 233), and exhibiting little disposition either to ramify or to coalesce, so as almost constantly to maintain their distinctness ; (3) as lobose extensions of the body itself, having like it an almost membranous Ectosarc with a very liquid Endosarc, and exhibiting an entire absence of any tendency either to ramify or to coalesce when they come into mutual contact (Figs. 234, 235). To the first of the Orders thus marked-out, the name *Reticularia* seems appropriate ; the second have been distinguished as *Radialaria* ; and the third may be designated *Lobosa*. It must be freely admitted, however, that these groups cannot be distinctly marked out ; the typical examples which will now be described being connected by many intermediate forms. This is not to be wondered at, when the extreme *indefiniteness* which characterizes this lowest type of Animal existence is duly borne in mind.*

* For a more detailed exposition of his "Systematic Arrangement of the Rhizopoda," see the Author's Memoir on that subject in the "Natural History Review," October, 1861 ; and his "Introduction to the Study of the Foraminifera," published by the Ray Society, 1862.—Another Classification has been more recently proposed by Dr. Wallich, whose Memoir on the Structure and Affinities of the *Polycystina* ("Transact. of Microsc. Society," N.S., Vol. xiii., 1865, p. 57) contains much important information

326. *Reticularia*.—The peculiarities of this type have been most fully studied in a remarkable naked form, which has been described by MM. Claparède and Lachmann* under the name of *Lieberkühnia*. The whole substance of the body of this animal and its pseudopodial extensions is composed of a homogeneous, semifluid, granular Protoplasm; the particles of which, when the animal is in a state of activity, are continually performing a circulatory movement, which may be likened to the rotation of the particles in the protoplasmic network within the cell of a *Tradescantia* (§ 289). The entire absence of anything like a membranous envelope is evinced by the readiness with which the Pseudopodian extensions coalesce whenever they come into contact, and with which the principal branches subdivide into finer and yet finer threads, by whose continual insculcations a complicated network is produced. Any small alimentary particles that may come into contact with the glutinous surface of the pseudopodia, are retained in adhesion by it, and speedily partake of the general movement going on in their substance. This movement takes place in two principal directions; from the body towards the extremities of the pseudopodia, and from these extremities back to the body again. In the larger branches a double current may be seen, two streams passing at the same time in opposite directions; but in the finest filaments the current is single, and a granule may be seen to move in one of them to its very extremity, and then to return, perhaps meeting and carrying back with it a granule that was seen advancing in the opposite direction. Even in the broader processes, granules are sometimes observed to come to a stand, to oscillate for a time, and then to take a retrograde course, as if they had been entangled in the opposing current,—just as is often to be seen in *Chara*. When a granule arrives at a point where a filament bifurcates, it is often arrested for a time until drawn into one or the other current; and when carried across one of the bridge like connections into a different band, it not unfrequently meets a current proceeding in the opposite direction, and is thus carried back to the body without having proceeded very far from it. The pseudopodial network along which this ‘cyclosis’ takes place is continually undergoing changes in its own arrangement; new filaments being put forth in different directions, sometimes from

derived from personal observation. So much remains to be learned, however, in regard to the Life-history of the Rhizopods, and especially as to their Sexual Generation, that the Author does not think it worth while yet to abandon his own classification, which he looks upon as purely *provisional*, for another system which may prove to be equally destitute of the characters of permanence.

* *Etudes sur les Infusaires et les Rhizopodes.* Geneva, 1858-1861. The beautiful figure of *Lieberkühnia*, given by M. Claparède, has been reproduced by the Author in Plate 1 of his “Introduction to the Study of the Foraminifera.”

its margin, sometimes from the midst of its ramifications, whilst others are retracted. Not unfrequently it happens that to a spot where two or more filaments have met, there is an afflux of the Protoplasmic substance that causes it to accumulate there as a sort of secondary centre, from which a new radiation of filamentous processes takes place, just as in Fig. 232. The entire absence of differentiation in the Protoplasmic substance, the freedom of the mutual inosculation of its Pseudopodial extensions, and the active cyclosis incessantly going on between these and the body, are three mutually-related conditions, which not only serve to characterize the group of Animals that exhibits them, but to differentiate that group from others. There is, moreover, a negative character of much importance, which is naturally associated with the absence of differentiation,—namely, the deficiency of the 'Nucleus' and of the 'Contractile Vesicle' that present themselves alike in the *Radiolaria* and in the *Lobosa*.

327. It is by Animals belonging to this Order, that those very remarkable minute Shells are formed, which are known under the designation FORAMINIFERA. These constitute a group of organisms altogether so peculiar, and presenting so many features of interest, as to call for a somewhat detailed account of them, which will be most conveniently given in a separate Chapter (Chap. x.).

328. In *Gromia*, however, we have an example of a Rhizopod which very characteristically exhibits the Reticularian type in the disposition of its pseudopodia (Fig. 232), but which, according to Dr. Wallich (Op. cit. p. 60), possesses both Nucleus and Contractile Vesicle, and thus shows a transition to the higher orders. The sarcode-body of this animal is enclosed in an egg-shaped brownish-yellow membranous 'test,' which seems to be composed of the horny substance termed Chitine; and this has a single round orifice, whence issue very long pseudopodia that spread at their base over the external surface of the 'test' so as to form a continuous layer, from any portion of which fresh pseudopodia may extend themselves. The smooth coloured 'test' of *Gromia*, which commonly attains a diameter of from 1-10th to 1-12th of an inch, looks to the naked eye very much like the egg of a Zoophyte or the seed of an aquatic Plant; and its real nature would not be suspected until, after an interval of rest, the animal begins to creep about by means of its pseudopodia, and to mount along the sides of the glass vessel that contains it. Some *Gromiæ* are marine, and are found among tufts of Corallines and Algae; whilst others inhabit fresh water, adhering to Confervæ and other plants of running streams.

329. *Radiolaria*.—A characteristic example of this Order is presented by the *Actinophrys sol* (Fig. 233), a minute creature which is not uncommon in ponds and lakes, occurring for the most part amongst Confervæ and other aquatic Plants, and which may be distinguished with the naked eye as a whitish-grey motionless

spherical particle. The sarcode of which the body and pseudopodia of Actinophrys are composed, is less homogeneous than that

FIG. 232.

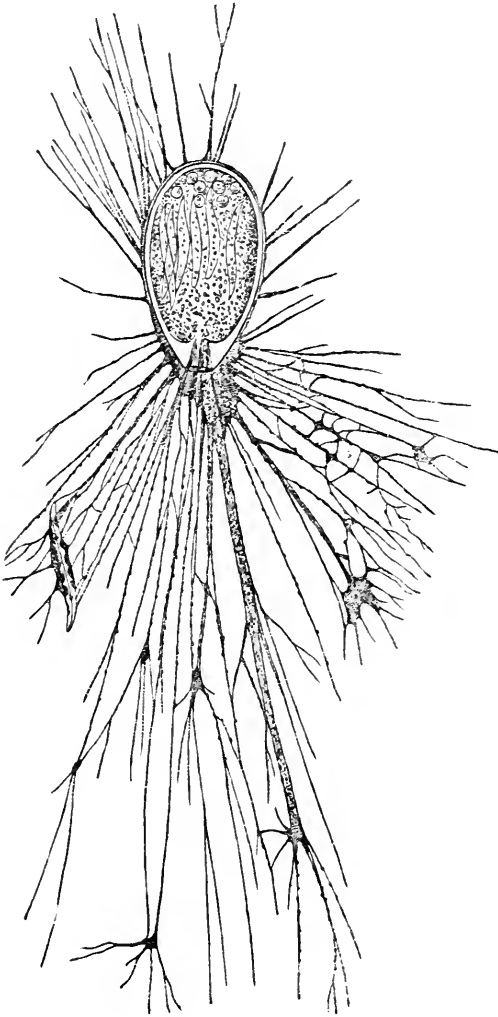

Gromia oviformis, with its pseudopodia extended.

of *Gromia* and its allies ; its external layer or Ectosarc being more condensed, while its contained substance or Endosarc is more

liquid. Although the existence of a 'nucleus' in Actinophrys has been denied, yet its presence (in certain species at least) must be regarded as a well-established fact. It presents itself as a flattened vesicular body with a well-defined margin, usually of circular outline, and very pellucid; and its central portion is occupied by an aggregation of granular particles, less defined at its margin and less regular in shape. It may be brought into view either by crushing the body of the animalcule, or by treating it with dilute acetic acid. Throughout the body, but more particularly near its surface, there are to be observed 'vacuoles' occupied by a watery fluid; these have no definite boundary, and may easily be artificially made either to coalesce into larger ones, or to subdivide into smaller; sometimes they have such a regularity of arrangement as to give to the intervening sarcode-substance the

FIG. 233.

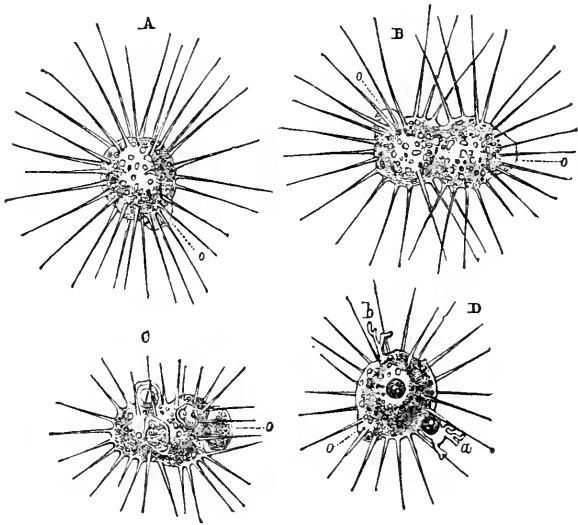

Actinophrys sol, in different states:—A, in its ordinary sun-like form, with a prominent Contractile Vesicle, *o*; B, in the act of division or of conjugation, with two Contractile Vesicles, *o, o*; C, in the act of feeding; D, in the act of discharging faecal (?) matters, *a* and *b*.

appearance of a cellular structure. A Contractile Vesicle, pulsating rhythmically with considerable regularity, is always to be distinguished either in the midst of the sarcode-body or (more commonly) at or near its surface; and it sometimes projects considerably from this in the form of a flattened sacculus with a

delicate membranous wall, as shown at *o*. It has been stated by various observers that the cavity of this sacculus is not closed externally, but communicates with the surrounding medium; and this appears to the Author to have been fully established by the careful observations of Dr. Zenker.* There does not seem to be any distinct and permanent orifice; but the membraniform wall gives way when the vesicle contracts, and then closes-over again. This alternating action seems to serve a respiratory purpose, the water thus taken in and expelled being distributed through a system of channels and vacuoles excavated in the substance of the body; some of the vacuoles which are nearest the surface being observed to undergo distension when the vesicle contracts, and to empty themselves gradually as it refills. The body of this animal is nearly motionless, but it is supplied with nourishment by the instrumentality of its pseudopodia; its food being derived not merely from Vegetable particles, but from various small Animals, some of them (as the young of Entomostraca) possessing great activity as well as a comparatively high organization. When any of these happens to come into contact with one of the pseudopodia, this usually retains it by adhesion; but the mode in which the particle thus taken captive is introduced into the body, differs according to circumstances. When the prey is large and vigorous enough to struggle to escape from its entanglement, it may usually be observed that the neighbouring pseudopodia bend over and apply themselves to it, so as to assist in holding it captive, and that it is slowly drawn by their joint retraction towards the body of its captor. Any small particle not capable of offering active resistance, on the other hand, may be seen after a little time to glide towards the central body along the edge of the pseudopodium, without any visible movement of the latter, much in the same manner as in *Gromia*. When in either of these modes the food has been brought to the surface of the body, this extends over it on either side a prolongation of its own sarcode-substance; and thus a marked prominence is formed (Fig. 233, *c*) which gradually subsides as the food is drawn more completely into the interior. The struggles of the larger Animals, and the ciliary action of *Infusoria* and *Rotifera*, may sometimes be observed to continue even after they have been thus received into the body; but these movements at last cease, and the process of digestion begins. The alimentary substance is received into one of the vacuoles of the Endosarc, where it lies in the first instance surrounded by liquid; and its nutritive portion is gradually converted into an undistinguishable gelatinous mass, which becomes incorporated with the material of the sarcode-body, as may be seen by the general diffusion of any colouring particles it may contain. Several vacuoles

* See "Schultze's Arch. f. Mikrosk. Anatomie," Bd. ii., p. 332; and "Quart. Journ. of Microsc. Science," Vol. vii., N.S. (1867), p. 263.

may be thus occupied at one time by alimentary particles; frequently four to eight are thus distinguishable, and occasionally ten or twelve; Ehrenberg, in one instance, counted as many as sixteen, which he described as multiple stomachs. Whilst the digestive process, which usually occupies some hours, is going on, a kind of slow circulation takes place in the entire mass of the Endosarc with its included vacuoles. If, as often happens, the body taken in as food possesses some hard indigestible portion (as the shell of an Entomostracan or Rotifer), this, after the digestion of the soft parts, is gradually pushed towards the surface, and is thence extruded by a process exactly the converse of that by which it was drawn in: if the particle be large, it usually escapes at once by an opening which (like the mouth) extemporizes itself for the occasion (Fig. 233, D); but if small, it sometimes glides along a pseudopodium from its base to its point, and escapes from its extremity. What is known regarding the Reproduction of *Actinophrys* will be presently stated (§ 334).*

330. The Order *Radiolaria* includes various forms of Rhizopods which agree with Actinophrys in the leading peculiarities of its structure, but which differ in having the body included in an envelope of more or less firm consistence. This may be formed simply of a membranous or a chitinous exudation, as in certain genera which represent in this Order the *Gromia* among the Reticularia, and the *Arcella* and *Diffugia* among the Lobosa. But the types in this group that are of most general interest to the Microscopist are the POLYCYSTINA, whose bodies are furnished with siliceous skeletons of most wonderful beauty and variety of form and structure; these may be more conveniently described, with the Foraminifera, in a separate Chapter (Chap. x.).†

331. *Lobosa*.—No example of the Rhizopod type is more common in streams and ponds, Vegetable infusions, &c., than the *Amœba* (Fig. 234); a creature which cannot be described by its form, for this is as changeable as that of the fabled Proteus, but which may yet be definitely characterized by peculiarities that separate it from the two groups already described. The distinction between Ectosarc and Endosarc is here clearly marked, so that the body approaches much more closely in its characters to an ordinary Cell composed of cell-wall and cell-contents. It is through the Endosarc alone that those coloured and granular particles are diffused, on which the hue and opacity of the body depend; its central portion seems

* The following recent Memoirs should be consulted by such as wish to apply themselves to the study of this interesting organism:—Kölliker and Cohn, in "Siebold and Kölliker's Zeitschrift," 1849 and 1851; Claparède, in "Ann. of Nat. Hist.," 2nd Ser., Vol. xv., pp. 211, 285, and in his "Etudes sur les Infusoires" (1865), 2ième Partie; Weston, in "Quart. Journ. of Microsc. Science," Vol. iv., p. 116.

† It is maintained by Dr. Wallich (loc. cit.) that the *Polycystina* should be placed in the same Order with the *Foraminifera*; the characters of the Sarcod-body being essentially the same in both groups.

to have an almost watery consistence, the granular particles being seen to move quite freely upon one another with every change in the shape of the body ; but its superficial portion is more viscid, and graduates insensibly into the firmer substance of the Ectosarc.

FIG. 234.

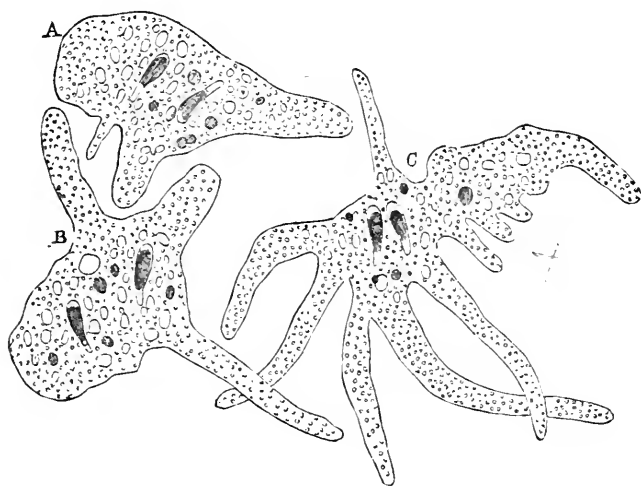

Amœba princeps, in different forms, A, B, C.

The Ectosarc, which is perfectly pellucid, forms an almost membranous investment to the endosarc ; still it is not possessed of such tenacity as to oppose a solution of its continuity at any point, for the introduction of alimentary particles, or for the extrusion of effete matter ; and thus there is no evidence, in *Amœba* and its immediate allies, of the existence of any more definite orifice, either oral or anal, than exists in other Rhizopods. The more advanced differentiation of the Ectosarc and the Endosarc of *Amœba* is made evident by the effects of re-agents. If, as Auerbach has shown, an *Amœba radiosa* be treated with a dilute alkaline solution, the granular and molecular Endosarc shrinks together and retreats towards the centre, leaving the radiating extensions of the Ectosarc in the condition of cæcal tubes, of which the walls are not soluble, at the ordinary temperature, either in acetic or mineral acids or in dilute alkaline solutions ; thus agreeing with the envelope noticed by Cohn as possessed by *Paramecium* and other ciliated *Infusoria*, and with the containing membrane of ordinary animal cells. A Nucleus is always distinctly visible in *Amœba*, adherent to the inner portion of the Ectosarc, and projecting from this into the cavity occupied by the Endosarc ; when most perfectly seen it

presents the aspect of a clear flattened vesicle surrounding a solid and usually spherical nucleolus ; it is readily soluble in alkalis, and first expands and then dissolves when treated with acetic or sulphuric acid of moderate strength ; but when treated with diluted acids it is rendered darker and more distinct, in consequence of the precipitation of a finely granular substance in the clear vesicular space that surrounds the nucleolus. A Contractile Vesicle seems also to be uniformly present ; though it does not usually make itself so conspicuous by its external prominence as it does in *Actinophrys*.

332. In all these particulars, therefore, the *Amœbina* present a nearer approach to Infusoria than is discernible among other Rhizopods ; and they tend towards Infusoria, also, in their higher locomotive powers, obtaining their food by actively going in search for it, instead of entrapping it and drawing it into the substance of their bodies by the agency of their extended pseudopodia. The pseudopodia, which are not so much appendages, as lobate extensions of the body itself, are few in number, short, broad, and rounded ; and their outlines present a sharpness which indicates that the substance of which their exterior is composed possesses considerable tenacity. No movement of granules can be seen to take place along the surface of the pseudopodia ; and when two of these organs come into contact, they scarcely show any disposition even to mutual cohesion, still less to a fusion of their substance. Sometimes the protrusion seems to be formed by the Ectosarc alone, but more commonly the Endosarc also extends into it, and an active current of granules may be seen to pass from what was previously the centre of the body into the protruded portion, when the latter is undergoing rapid elongation ; whilst a like current may set towards the centre of the body from some other protrusion which is being withdrawn into it. It is in this manner that an *Amœba* moves from place to place ; a protrusion like the finger of a glove being first formed, into which the substance of the body itself is gradually transferred ; and another protrusion being put forth, either in the same or in some different direction, so soon as this transference has been accomplished, or even before it is complete. The kind of progression thus executed by an *Amœba* is described by most observers as a 'rolling' movement, this being certainly the aspect which it commonly seems to present ; but it is maintained by MM. Claparède and Lachmann that the appearance of rolling is an optical illusion, for that the nucleus and contractile vesicle always maintain the same position relatively to the rest of the body, and that 'creeping' would be a truer description of their mode of progression. It is in the course of this movement from place to place, that the *Amœba* encounters particles which are fitted to afford it nourishment ; and it appears to receive such particles into its interior through any part of the Ectosarc, whether of the body itself or of any of its lobose

expansions, insoluble particles which resist the digestive process being got rid of in the like primitive fashion.

333. The Amœban, like the Actinophryan, type shows itself in the Testaceous as well as in the naked form; the commonest examples of this being known under the names *Arcella* and *Diffugia*. The body of the former is enclosed in a 'test' composed of a horny membrane, apparently resembling in constitution the *chitine* which gives solidity to the integuments of Insects; it is usually discoidal (Fig. 235, c, d) with one face flat and the other arched, the aper-

FIG. 235.

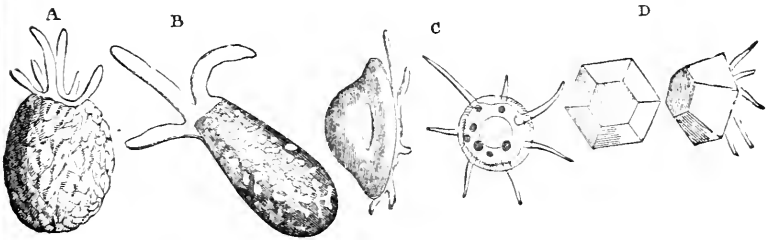

Testaceous forms of *Amœban* Rhizopods:—A, *Diffugia proteiformis*; B, *Diffugia oblonga*; C, *Arcella acuminata*; D, *Arcella dentata*.

ture being in the centre of the flat side; and its surface is often marked with a minute and regular pattern. The test of *Diffugia*, on the other hand, is more or less pitcher-shaped (Fig. 235, A, B), and is chiefly made up of minute particles of gravel, shell, &c., cemented together. In each of these genera, the sarcode-body resembles that of *Amœba* in every essential particular; the contrast between its large, distinct, lobose extensions (shown in Fig. 235) and the ramifying and inosculating pseudopodia of *Gromia* (Fig. 232), being as obvious as the difference between an *Amœba* and a *Lieberkühnia*. A marine example of this type, remarkable alike for its extraordinary size and for the nature of its 'test,' has been described by Dr. O. Sandahl under the name *Astrorhiza limicola*.* Its form is lenticular, with irregular radiating extensions which occasionally branch; the diameter of its central disk sometimes attains 1-5th of an inch; and its 'test' is composed of a spongy substance intermingled with more solid particles.† This Order, however, is not represented by any group of Calcareous-shelled

* "Ofversigt af Vet. Akad. Forhandl.," 1857, p. 299.

† Prof. Lovén, of Stockholm, to whom the Author is indebted for specimens of this remarkable organism, assures him that it is not uncommon; so that it might probably be found on our own coast, if carefully looked-for.

organisms like the *Foraminifera*, or by any Siliceous-shelled organisms like the *Polycystina*.*

334. *Reproduction of Rhizopoda*.—Very little is certainly known respecting the processes by which the multiplication of Rhizopods is effected. It may often be seen that portions of the sarcode-body detached from the rest can maintain an independent existence; and it is probable that such separation of fragments is the ordinary mode of increase in this group. Thus when the pseudopodian lobe of an *Amœba* has been put-forth to a considerable length, and has become enlarged and fixed at its extremity, the subsequent contraction of the connecting portion, instead of either drawing the body towards the fixed point, or retracting the pseudopodian lobe into the body, causes the connecting band to thin-away until it separates; and the detached portion speedily shoots out pseudopodian processes of its own, and comports itself in all respects as an independent Amœba. It is an interesting exemplification of the intimacy of the relation between the form of the pseudopodia and the properties of the sarcode-body of the Rhizopoda, that any small separated portion of that body will behave itself after the characteristic fashion of its type; thus, if the shell of an *Arcella* be crushed, so as to force out a portion of its sarcode, and this be detached from the rest, it will soon begin to put forth lobose extensions like those of an *Amœba*; whilst if the like operation be performed upon a *Polystomella*, or any other of the Foraminifera, the detached fragments of the protoplasm will extend itself into delicate ramifying and inosculating pseudopodia resembling those of *Gromia*. We shall find that the production of the 'polythalamous' (many-chambered) shells of Foraminifera is due to a repeated gemmation or budding of the sarcode-body; and there can be no reasonable doubt that in such 'monothalamous' (single-chambered) forms as *Gromia*, *Arcella*, and *Difflugia*, similar buds are put forth, but become detached before they develop their testaceous envelopes. There is evidence, again, that in such naked forms as *Actinophrys* and *Amœba*, multiplication takes place by a binary subdivision resembling that of Protophytes. Thus it may often be observed that the spherical body of *Actinophrys* is marked by an annular constriction, which gradually deepens so as to separate its two halves by a sort of hour-glass contraction; and the connecting band becomes more and more slender, until the two halves are completely separated. This process of fission, which may be completed within half an hour from its commencement, seems to take place first in the Contractile

* For more detailed information respecting *Amœba* and its allies, the reader may be specially referred to the Memoir of Dr. Auerbach in "Siebold and Kölliker's Zeitschrift," Band vii., 1856; to the "Etudes sur les Infusoires" of MM. Claparède and Lachmann; and to the elaborate series of Papers by Dr. Wallich in the "Annals of Natural History, 3rd Ser., Vols. xi., xii., xiii., 1863 and 1864.

Vesicle ; for each segment very early shows itself to be provided with its own (Fig. 233, B, o, o), and the two vesicles are commonly removed to a considerable distance from one another. The segments thus divided are not always equal, and sometimes their difference in size is very considerable.—On the other hand, a junction of two individuals has been seen to take place in *Actinophrys*, which has been supposed to correspond to the 'conjugation' of Protophytes. It is very doubtful, however, whether this junction really involves a complete fusion of the substance of the bodies which take part in it ; and there is not sufficient evidence that it has any relation to the act of Reproduction. Certain it is that such a junction or 'zygosis' may occur, not between two only, but between several individuals at once, their number being recognized by that of their contractile vesicles ; and that, after remaining thus coherent for several hours, they may separate again without having undergone any discoverable change.—It appears from the observations of Mr. H. J. Carter,* that a distinction of Sexes exists among *Amabina* and *Actinophryna* ; bodies resembling spermatozoa being developed from the nucleus in certain individuals, whilst in others ova seems to be dispersed through the general substance of the body. And these observations derive an increased significance from the discoveries which have been lately made by M. Balbiani respecting the Sexual propagation of *Infusoria* (§ 347). But Mr. Carter has not yet succeeded either in tracing any relation between the 'zygosis' just mentioned as occurring between two or more individuals, and the fertilization of the ova by the spermatozoids ; or in ascertaining with certainty whether the product of each ovum is a single Rhizopod, or an aggregation of independent Rhizopods ; and these problems have still to be worked out.†

335. GREGARINIDA.—A very curious animal parasite is often to be met with in the intestinal canal of Insects, Centipedes, &c., and sometimes in that of higher animals, the simplicity of whose structure requires that it should be ranked among the Protozoa. It is not yet certain, however, that we know the entire life-history of this parasite, the *Gregarina* ; and it may possibly be only a phase in the existence of some higher kind of Entozoon. Each individual (Fig. 236, A) essentially consists of a single cell, usually more or less ovate in form, and sometimes considerably elongated ; a sort of beak or proboscis frequently projects from one extremity ; and in some instances this is furnished with a circular row of hooklets, closely resembling that which is seen on the head of *Tænia*. There is here a much more complete differentiation

* 'Notes on the Freshwater *Infusoria* in the Island of Bombay,' in "Annals of Nat. Hist.," 2nd Ser., Vol. xviii. (1856), pp. 223-233.

† A summary of the present state of our knowledge upon the Reproduction of the Rhizopoda is given in the Author's "Introduction to the Study of the Foraminifera," published by the Ray Society, 1861.

between the cell-membrane and its contents, than exists either in *Actinophrys* or in *Amœba*; and in this respect we must look upon *Gregarina* as representing a decided advance in organization. Being nourished upon the juices already prepared for it by the digestive operations of the animal which it infests, it has no need

FIG. 236.

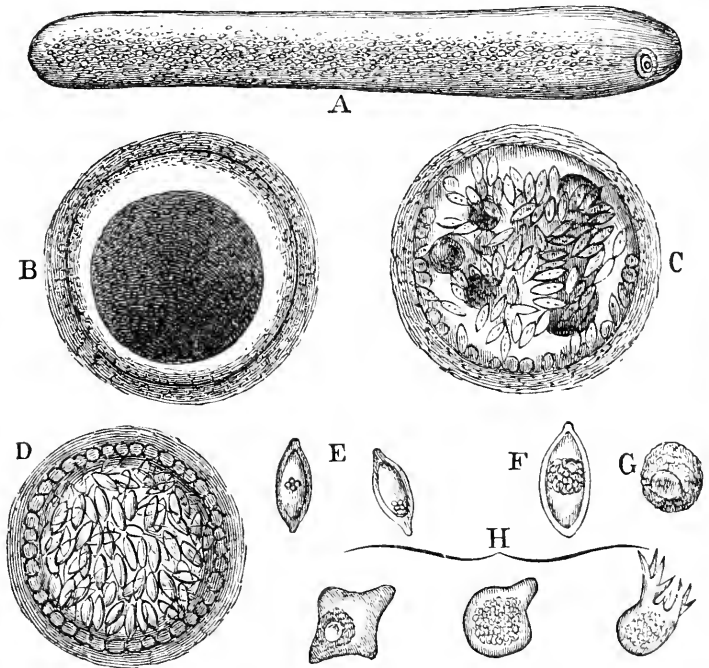

Gregarina of the Earthworm:—A, in its ordinary aspect; B, in its encysted condition; C, D, showing division of its contents into Pseudo-navicellæ; E, F, free Pseudo-navicellæ; G, free Amœboid; H, free Amœboids produced from them.

of any such apparatus for the introduction of solid particles into the interior of its body, as is provided in the 'pseudopodia' of the Rhizopods and in the oral cilia of the Infusoria. Within the cavity of the cell, whose contents are usually milk-white and minutely granular, there is generally seen a pellucid Nucleus; and this becomes first constricted and then cleft, when, as often happens, the cell subdivides into two, by a process exactly analogous to that which takes-place in the simplest Protophytes (§ 185). The membrane and its contents, except the nucleus, are soluble in

acetic acid. Cilia have been detected both upon the outer and the inner surface; but these would seem destined, not so much to give motion to the body, as to renew the stratum of fluid in contact with it; for such change of place as the animal does exhibit is effected by the contractions and extensions of the body generally, as in the *Amœba* (§ 332). An 'encysting process,' very much resembling that of the lower *Protophytes* (§§ 188, 189), is occasionally observed to take place in *Gregarinæ*, and seems to be preparatory to their multiplication. Whatever the original form of the body may be, it becomes globular, ceases to move, and becomes invested by a structureless 'cyst,' within which the substance of the body undergoes a singular change. The Nucleus disappears; and the sarcodic mass breaks up into a series of globular particles, which gradually resolve themselves (as shown at B, c, Fig. 236) into forms so like those of *Naviculæ* (§ 233) as to have been mistaken for them; though their walls are destitute of siliceous, and there is no further resemblance between the two kinds of bodies than that of figure. These 'pseudo-navicellæ' are set-free, in time, by the bursting of the capsule that encloses them; and they develop themselves into a new generation of *Gregarinæ*, first passing through an *Amœba*-like form. A sort of 'conjugation' has been seen to take place between two individuals, whose bodies, coming into contact with each other by corresponding points, first become more globular in shape, and are then encysted by the formation of a capsule around them both; the partition-walls between their cavities disappear; and the substance of the two bodies becomes completely fused together. As the product of this 'zygosis' is the same as that of the ordinary encysting process, there seems no reason for regarding it, like the 'conjugation' of *Protophytes*, as a true Generative act; and the resolution of the sarcodic body into 'pseudo-navicellæ' must thus be regarded as analogous to the resolution of the endochrome-mass of an *Achlya* or *Ulva* into Zoospores (§§ 241, 247).*

336. THALASSICOLLIDA.—A very curious type of Composite Rhizopods has been discovered by Prof. Huxley, which seems to connect the preceding forms with Sponges and Polycystina. The *Thalassicollæ*, or Sea-jellies, are gelatinous rounded bodies, of very variable size and shape, but usually either globular or discoidal. Externally they are invested by a layer of condensed sarcode, which sends forth pseudopodial extensions that commonly stand out like rays, but sometimes inosculate with each other so as to form networks. Towards the inner surface of this coat are scattered a great number of oval bodies resembling cells, having a tolerably distinct membraniform wall and a conspicuous round central nucleus, thus corresponding closely with the *Gregarina*

* For the most recent information on this point, see a Memoir by M. Nat. Lieberkühn in *Mém. de l'Acad. Roy. de Belgique*, tom. xvi.

type. Each of these bodies appears to be without any direct connection with the rest ; but it serves as a centre around which a number of minute yellowish-green vesicles are disposed. Each of these groups is protected by a Siliceous skeleton, which sometimes

FIG. 237.

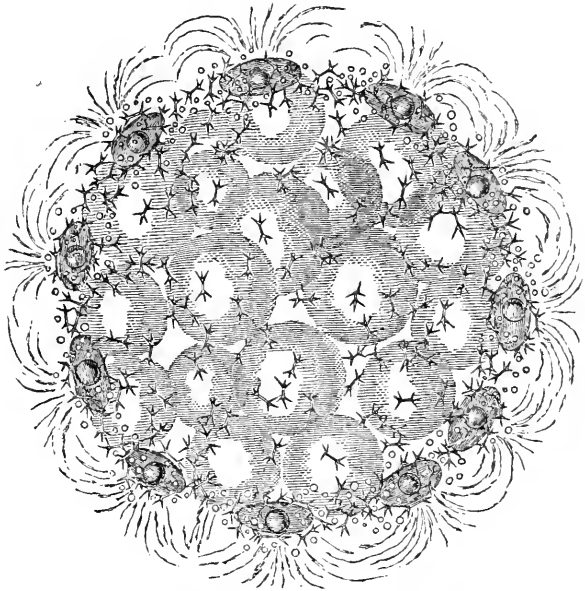

Spherozoum ovoidimare, one of the *Thalassicollida*.

consists of separate spicules (as in Fig. 237), but which may be a thin perforated sphere like that of certain *Polycystina* (§ 402), sometimes extending itself into radiating prolongations. The internal portion of each mass is composed of an aggregation of large vesicle-like bodies, imbedded in a softer sarcodic substance. Notwithstanding the subsequent observations of Müller and Haeckel,* much obscurity still hangs over the real nature of these bodies ; and as they so abound in the seas of warm latitudes as to be among the commonest products of the tow-net, the Microscopist who has the requisite opportunity should not neglect the careful search-for and observation of them.

* See Huxley in "Annals of Natural History," 2nd Ser., Vol. viii. (1851), p. 433 ; and "Quart. Journ. of Microsc. Science," Vol. iv. (1856), p. 72 ; also Müller in his Treatise "Ueber die Thalassicollen, Polycystinen, und Acanthometren des Mittelmeeres," originally published in the Transactions of the Berlin Academy for 1858 ; and the magnificent work of Haeckel, "Die Radiolarien," Berlin, 1862.

ANIMALCULES.

337. We have now to apply ourselves to the special subject of this Chapter, namely, the assemblage of those minute forms of Animal life which are commonly known under the designation of *Animalcules*. Nothing can be more vague or inappropriate than this title, since it only expresses the small dimensions of the beings to which it is applied, and does not indicate any of their characteristic peculiarities. In the infancy of Microscopic knowledge, it was natural to associate together all those creatures which could only be discerned at all under a high magnifying power, and whose internal structure could not be clearly made out with the instruments then in use; and thus the most heterogeneous assemblage of Plants, Zoophytes, minute Crustaceans (water-fleas, &c.), larvæ of Worms and Mollusks, &c., came to be aggregated with the true Animalcules under this head. The Class was being gradually limited by the removal of all such forms as could be referred to others; but still very little was known of the real nature of those that remained in it, until the study was taken up by Prof. Ehrenberg, with the advantage of instruments which had derived new and vastly improved capabilities from the application of the principle of Achromatism. One of the first and most important results of his study, and that which has most firmly maintained its ground, notwithstanding the weakening of Prof. Ehrenberg's authority in other respects, was the separation of the entire assemblage into two distinct groups, having scarcely any feature in common excepting their minute size, one being of very *low* and the other of comparatively *high* organization. On the lower group he conferred the designation of *Polygastrica* (many stomachs), in consequence of having been led to form an idea of their organization which the united voice of the most trustworthy observers now pronounces to be erroneous; and as the retention of this term must tend to perpetuate this error, it is well to fall back on the name *Infusoria*, or Infusory Animalcules, which simply expresses their almost universal prevalence in Infusions of Organic matter. For although this was applied by the older writers to the higher group as well as to the lower, yet as the former are now distinguished by an appropriate appellation of their own, and are, moreover, *not* found in infusions while in that state of rapid decomposition which is most favourable to the presence of the inferior kind of Animalcules, the designation may very well be restricted to the forms essentially constituting the *Polygastrica* of Ehrenberg, which is the sense wherein it has been used by many recent writers.—To the higher group, Prof. Ehrenberg's name *Rotifera* or *Rotatoria* is on the whole very appropriate, as significant of that peculiar arrangement of their Cilia upon the anterior parts of their bodies, which, in some of their most common forms, gives the appearance (when the cilia are in action) of Wheels in revolution; the group, however includes many members in which

the ciliated lobes are so formed as not to bear the least resemblance to wheels. In their general organization, these 'Wheel-animalcules' must certainly be considered as members of the *Articulated* division of the Animal Kingdom; and they seem to constitute a class in that lower portion of it, to which the designation *Worms* is now commonly given.—Notwithstanding this wide zoological separation between these two kinds of Animalcules, it seems most suitable to the plan of the present work to treat of them in connection with one another; since the Microscopist continually finds them associated together, and almost necessarily ranges them in his own mind under one and the same category.

338. INFUSORIA.—This term, as now limited by the separation of the Rotifera, is applied to a far smaller range of forms than that which was included by Prof. Ehrenberg under the name of 'polygastric' animalcules. For a large section of these, including the *Desmidiaceæ*, *Diatomaceæ*, *Volvocineæ*, and many other Protophytes, have been transferred by the almost concurrent voice of those Naturalists whose judgment is most to be relied-on, to the Vegetable Kingdom. The *Rhizopod* group, again, must be excluded, as being very distinct in its plan of organization from the true Infusoria. And, lastly, it is not impossible that many of the reputed Infusoria may be but larval forms of higher organisms, instead of being themselves complete animals. Still an extensive group remains, of which no other account can at present be given, than that the beings of which it is composed go through the whole of their lives, so far as we are acquainted with them, in a grade of existence which is essentially 'protozoic;' their lowest forms approximating closely to the highest Rhizopods, whilst even in their most elevated types we find no such differentiation of parts as would justify our associating them with any other class.—Passing by the descriptions of Prof. Ehrenberg as no longer authoritative, the following general account of the organization of *Infusoria* is given in accordance with the concurrent representations of the best observers of the present time.

339. The bodies of Infusoria consist of Sarcodæ, of which the outer layer possesses considerably more consistence than the internal portion: the process of differentiation having here advanced sufficiently far to establish a clear distinction between the Ectosarc and the Endosarc. Sometimes, as in *Paramecium*, a distinct pellicle may be recognized on the surface of the Ectosarc or 'cortical layer' of the body; and this pellicle, which is studded with regularly-arranged markings like those of Diatomaceæ, seems to be the representative of the carapace of *Arcella*, &c. (§ 333), as of the cellulose coat of Protophytes. In certain Infusoria, as *Paramecium* (*Loxodes*) *bursaria*, the surface of the body is beset with 'trichocysts' resembling those of Zoophytes in miniature (§ 428); but it is remarkable that these are not present in all the individuals of the species in which they occur. Sometimes, again, the tegu-

mentary membrane is hardened, so as to form a shield that protects the body on one side only, or a 'lorica' that completely invests it : and there are other cases in which it is so prolonged and doubled upon itself as to form a sheath resembling the 'cell' of a Zoophyte, within which the body of the Animalcule lies loosely, being attached only by a stalk at the bottom of the case, and being able either to project itself from the outlet or to retract itself into the interior.

FIG. 238.

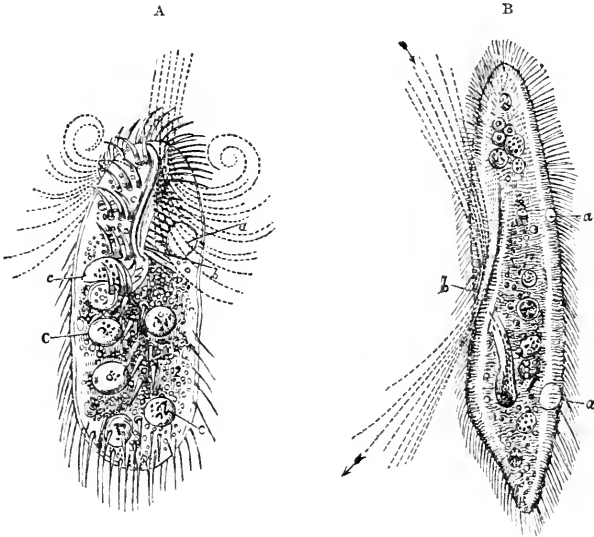

A, *Kerona silurus* :—*a*, contractile vesicle ; *b*, mouth ; *c*, *c*, Animalcules swallowed by the *Kerona*, after having themselves ingested particles of indigo. B, *Paramecium caudatum* :—*a*, *a*, contractile vesicles ; *b*, mouth.

The form of the body is usually much more definite than that of *Amœba* or *Actinophrys* ; each species having its characteristic shape, which is only departed from, for the most part, when the Animalcule is subjected to pressure from without, or when its cavity has been distended by the ingestion of any substance above the ordinary size. The body does not seem to possess much contractile power in its own substance, its movements being principally executed by the instrumentality of locomotive appendages ; one remarkable instance of contractility, however, is presented by the stalk of *Vorticella* (Fig. 239). The locomotive appendages, which may all be considered as prolongations of the tegumentary layer, are destitute of any more minute organization ; being, in fact, of the nature of *cilia*, though sometimes of much larger dimensions, and employed in a different manner. The vibration of Ciliary filaments, which are either disposed along the entire margin of the

body, as well as around the oral-aperture (Fig. 238 A, B), or are limited to some one part of it, which is always in the immediate vicinity of the mouth (Fig. 239), supplies the means by far the most frequently employed by the beings of this class, both for progression through the water and for drawing alimentary particles into the interior of their bodies. In some their vibration is constant, whilst in others it is only occasional, thus conveying the impression that the Animalcule has a voluntary control over them; but there is strong reason for questioning the existence of any such self-directing power. These cilia, like those of the zoospores of Protophytes, can usually be distinctly seen only when their movement is very much slackened in its rate, or when it has entirely ceased. Sometimes, however, instead of a multitude of short cilia, we find

FIG. 239.

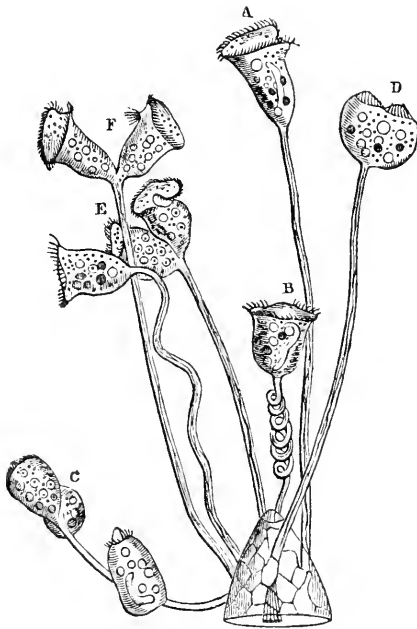

Group of *Vorticella nebulifera*, showing, A, the ordinary form; B, the same with the stalk contracted; C, the same with the bell closed; D, E, F, successive stages of fissionary multiplication.

a small number of long slender filaments usually proceeding from the anterior part of the body (that nearest the mouth), and strongly resembling the elongated cilia of *Protococcus* (Plate VIII., fig. 2, H) or of *Volvox* (Plate IX., figs. 9, 10, 11). But in other cases, the filaments are comparatively short and have a bristle-like firmness; and instead of being kept in vibration, they are moved (like the spines of Echini) by the contraction of the substance to which their bases are attached, in such a manner that the Animalcule crawls by their means over a solid surface, as we see especially in *Trychoda lynceus* (Fig. 241, P, Q). In *Chilodon* and *Nassula*, the mouth is provided

with a circle of these bristles, which have received the designation of 'teeth'; their function, however, is rather that of laying hold of alimentary particles by their expansion and subsequent

drawing-together (somewhat after the fashion of the tentacula of Zoophytes), than of reducing them by any kind of masticatory process.

340. The modes of movement which Infusory Animalcules execute by means of these instruments, are extremely varied and remarkable. Some propel themselves directly forwards, with a velocity which appears, when thus highly magnified, like that of an arrow, so that the eye can scarcely follow them, whilst others drag their bodies slowly along like a leech. Some attach themselves by one of their long filaments to a fixed point, and revolve around it with great rapidity, whilst others move by undulations, leaps, or successive gyrations: in short, there is scarcely any kind of animal movement which they do not exhibit. There is no sufficient reason, however, to regard such actions as indicative of consciousness; indeed, the very fact that they are performed by the instrumentality of Cilia seems to imply the contrary, since we know that ciliary action takes place to a large extent in our own bodies without the least dependence upon our consciousness; and that it is also used as a means of dispersion among the Zoospores of the lowest Plants, which cannot for a moment be supposed to be endowed with this attribute. We can only regard it, therefore, as indicative of a wonderful adaptation, on the part of these simple organisms, to a kind of life which enables them to go in quest of their own nutriment, and to introduce it when obtained into the interior of their bodies.—The curious contraction of the foot-stalk of the *Vorticella* (Fig. 239), however, is a movement of a different nature, and is due to the contractility of the tissue that occupies the interior of the tubular pedicle. This stalk serves to attach the bell-shaped body of the Animalcule to some fixed object, such as the leaf or stem of duck-weed; and when the animal is in search of food, with its cilia in active vibration, the stalk is fully extended. If, however, the Animalcule should have drawn to its mouth any particles too large to be received within it, or should be touched by any other that happens to be swimming near it, or should be 'jarred' by a smart tap on the stage of the Microscope, the stalk suddenly contracts into a spiral, from which it shortly afterwards extends itself again into its previous condition. The central cord, to whose contractility this action is due, has been described as muscular; but it does not possess the characteristic structure of either kind of muscular fibre, and is probably nothing else than a portion of sarcode specially endowed with the property. Nothing but the rapidity of its contraction and relaxation differentiates it from the pseudopodia of the Rhizopods.—There is no reason whatever to believe that these Animalcules possess any organs of special sense. The red spots which may be seen in many of them, and which have been designated as eyes by Prof. Ehrenberg, from their supposed correspondence with the eye-spots of *Rotifera* (§356), really bear a much greater resemblance to the red spots which are

so frequently seen among Protophytes (§ 188). If these creatures are really endowed with consciousness, as their movements *seem* to indicate, though other considerations render it very doubtful, they must derive their perceptions of external things from the impressions made upon their general surface, but more particularly upon their filamentous appendages.

341. The interior of the body does not always seem to consist of a simple undivided cavity occupied by soft Sarcodæ; for the tegumentary layer appears in many instances to send prolongations across it in different directions, so as to divide it into chambers of irregular shape, freely communicating with each other, which may be occupied either by sarcodæ, or by particles introduced from without. The alimentary particles which can be distinguished in the interior of the transparent bodies of Infusoria, are usually Protophytes of various kinds, either entire or in a fragmentary state. The Diatomaceæ seem to be the ordinary food of many; and the insolubility of their *loricæ* enables the observer to recognize them unmistakably. Sometimes entire Infusoria are observed within the bodies of others not much exceeding them in size (Fig. 242, B); but this is only when they have been recently swallowed, since the prey speedily undergoes digestion. It would seem as if these creatures do not feed by any means indiscriminately, since particular kinds of them are attracted by particular kinds of aliment; the crushed bodies and eggs of Entomostraca, for example, are so voraciously consumed by the *Coleps*, that its body is sometimes quite altered in shape by the distension. This circumstance, however, by no means proves, as some have considered it to do, that such creatures possess a sense of taste and a power of determinate selection; for many instances might be cited, in which actions of the like apparently-conscious nature are performed without any such guidance.—The ordinary process of feeding, as well as the nature and direction of the Ciliary currents, may be best studied by diffusing through the water containing the Animalecules a few particles of indigo or carmine. These may be seen to be carried by the ciliary vortex into the mouth, and their passage may be traced for a little distance down a short (usually ciliated) œsophagus. There they commonly become aggregated together, so as to form a little pellet of nearly globular form; and this, when it has attained the size of the hollow within which it is moulded, is projected into the 'general cavity of the body,' where it lies in a vacuole of the sarcodæ, its place in the œsophagus being occupied by other particles subsequently ingested. This 'moulding,' however, is by no means universal; the aggregations of coloured particles in the bodies of these animals being often destitute of any regularity of form. One after another of such particles being thus introduced into the interior of the body, each aggregation seems to push-on its predecessors; and a kind of circulation is thus occasioned in the contents of the cavity. The

pellets that first entered make their way out after a time (after yielding up their nutritive materials), generally by a distinct anal orifice, sometimes, however, by any part of the surface indifferently, and sometimes by the mouth. A circumstance which seems clearly to indicate that they cannot be enclosed (as maintained by Prof. Ehrenberg) in distinct stomachal cavities, is that, when the pellets are thus moving round the body of the Animalcule, two of them sometimes appear to become fused together, so that they obviously cannot have been separated by any membranous investment. When the Animalcule has not taken food for some time, 'vacuoles,' or clear spaces, extremely variable both in size and number, filled only with a very transparent fluid, are often seen in its sarcode; their fluid sometimes shows a tinge of colour, and this seems to be due to the solution of some of the vegetable chlorophyll upon which the Animalcule may have fed last.

342. Contractile Vesicles (Fig. 238, *a*, *a*), usually about the size of the 'vacuoles,' are found, either singly or to the number of from two to sixteen, in the bodies of most Animalcules; and may be seen to execute rhythmical movements of contraction and dilatation at tolerably-regular intervals, being so completely obliterated when emptied of their contents as to be quite indistinguishable, and coming into view again as they are refilled. These vesicles do not change their position in the individual, and they are pretty constant, both as to size and place, in different individuals of the same species; hence they are obviously quite different in character from the 'vacuoles.' In *Paramecium* there are always to be observed two globular vesicles (Fig. 238, *B*, *a*, *a*), each of them surrounded by several elongated cavities, arranged in a radiating manner, so as to give to the whole somewhat of a star-like aspect (Plate XIV., fig. 1, *v*, *v*); and the liquid contents are seen to be propelled from the former into the latter, and *vice versâ*. Further, in *Stentor*, a complicated network of canals, apparently in connection with the contractile vesicles, has been detected in the substance of the 'cortical layer;' and traces of this may be observed in other Infusoria. In some of the larger Animalcules it may be distinctly seen that the Contractile Vesicles have *permanent* valvular orifices opening outwards, and that an expulsion of fluid from the body into the water around is effected by their contraction. Hence it appears likely that their function is of a Respiratory nature, and that they serve, like the gill-openings of Fishes, for the expulsion of water which has been taken-in by the mouth, and which has traversed the interior of the body. (See § 329.)

343. Of the Reproduction of the Infusoria our knowledge has lately received a great accession in the discovery of their true Sexual Generation (§ 347); the attention of observers having, until a comparatively recent period, been fixed almost exclusively upon the act of Binary Subdivision, which, though by far the most frequent method of propagation, is not a true generative operation.

This seems to be effected in the same general mode as the subdivision of Protophyta; and has been observed in many instances to commence in the 'nucleus,' which may usually be distinguished in the bodies of the Infusoria. The division takes-place in some species longitudinally, that is, in the direction of the greatest length of the body (Fig. 239, D, E, F), in other species, transversely (Fig. 242, A, D), whilst in some, as in *Chilodon cucullulus*

FIG. 240.

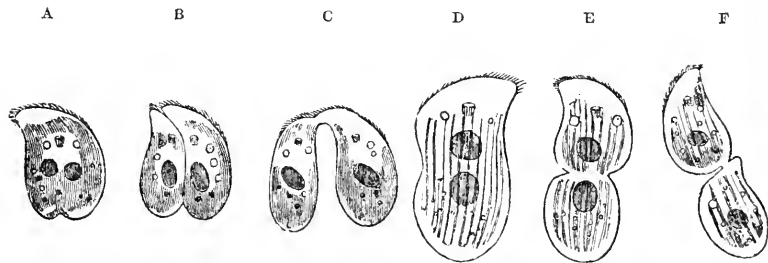

Fissiparous multiplication of *Chilodon cucullulus*:—A, B, C, successive stages of longitudinal fission (?); D, E, F, successive stages of transverse fission.

(Fig. 240), it has been supposed to occur in either direction indifferently; but it seems most probable from recent discoveries that what has been here supposed to be longitudinal fission (A, B, C) is really an act of Conjugation (§ 347), and that the real fission is transverse only (D, E, F). This operation is performed with such rapidity, under favourable circumstances, that, according to the calculation of Prof. Ehrenberg, no fewer than 268 millions might be produced in a month by the repeated subdivisions of a single *Paramecium*. When this fission occurs in *Vorticella* (Fig. 239), one of the divisions is usually smaller than the other, sometimes so much so as to look like a bud; and this generally detaches itself when mature from the main body, and swims freely about until it develops a new footstalk for itself. But sometimes the two parts are equal in size, and the fission extends down the stalk, which thus becomes double for a greater or less part of its length; and thus a whole bunch of *Vorticellæ* may spring (by a repetition of the same process) from one base. In some members of the same family, indeed, an arborescent structure is produced, just as in certain Diatoms (Fig. 139), by the like processes of division and gemmation.

344. Many Infusoria at certain times undergo an *Encysting process*, resembling the passage of Protophytes into the 'still' condition (§ 190), and apparently serving, like it, as a provision for their preservation under circumstances which do not permit the

continuance of their ordinary vital activity. Previously to the formation of the cyst, the movements of the Animalcule diminish in vigour, and gradually cease altogether; its form becomes more rounded; its oral aperture closes; and its cilia or other filamentous

FIG. 241.

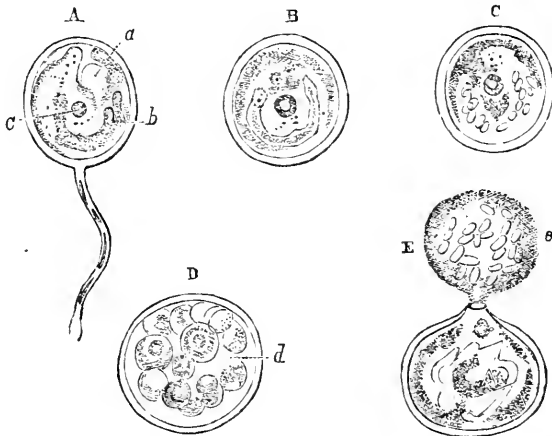

Encysting process in *Vorticella microstoma*:—A, full-grown individual in its encysted state: *a*, retracted oval circling of cilia; *b*, nucleus; *c*, contractile vesicle;—B, a cyst separated from its stalk;—C, the same more advanced, the nucleus broken-up into spore-like globules;—D, the same more developed, the original body of the *Vorticella*, *d*, having become sacculated, and containing many clear spaces;—E, one of the sacculations having burst through the enveloping cyst, a gelatinous mass, *e*, containing the gemmules, is discharged.

prolongations are either lost or retracted, as is well seen in *Vorticella* (Fig. 241, A). The surface of the body then exudes a gelatinous excretion that hardens around it so as to form a complete coffin-like case, within which little of the original structure of the animal can be distinguished. Even after the completion of the cyst, however, the contained Animalcule may often be observed to move freely within it, and may sometimes be caused to come forth from its prison by the mere application of warmth and moisture. In the simplest form of the 'encysting process,' indeed, the Animalcule seems to remain altogether quiescent through the whole period of its torpidity; so that, however long may be the duration of its imprisonment, it emerges without any essential change in its form or condition. But in other cases, this process seems to be subservient either to multiplication or to metamorphosis. For in *Vorticella* the substance of the encysted

body (B) appears to break up (C, D) into numerous gemmules, which are analogous to the 'zoospores' of Protophytes, and which, like them, are set free by the bursting of the parent-cyst (E), swimming forth to develop themselves into new individuals of the same kind, though at first, perhaps, bearing little or no resemblance to the type from which they sprang.

345. In *Trichoda lynceus*, on the other hand, the Encysting process appears subservient to a kind of Metamorphosis of the individual (like the somewhat parallel passage of Insects through the pupa-stage); the Animalcule which emerges from the cyst having characters in many respects different from those of the Animalcule which became encysted, but no multiplication being effected either by subdivision or gemmation. According to M. Jules Haime, by whom this history was very carefully studied,* the form to be considered as the Larval one is that shown in Fig 242, A—E, which has been described by Prof. Ehrenberg under the name of *Oxytricha*. This possesses a long, narrow, flattened body, furnished with cilia along the greater part of both margins, and having also at its two extremities a set of larger and stronger hair-like filaments; and its mouth, which is an oblique slit on the right-hand side of its fore-part, has a fringe of minute cilia on each lip. Through this mouth, large particles are not unfrequently swallowed, which are seen lying in the midst of the gelatinous contents of the general cavity of the body, without any surrounding 'vacuole;' and sometimes even an Animalcule of the same species, but in a different stage of its life, is seen in the interior of one of these voracious little devourers (B). In this phase of its existence, the *Trichoda* undergoes multiplication by transverse fission, after the ordinary mode (C, D); and it is usually one of the short-bodied 'doubles' thus produced (E) that passes into the next phase. This phase consists in the assumption of the globular form, and the almost entire loss of the locomotive appendages (F); in the escape of successive portions of the granular sarcode, so that 'vacuoles' make their appearance (G); and in the formation of a gelatinous envelope or cyst, which, at first soft, afterwards acquires increased firmness (H). After remaining for some time in this condition, the contents of the cyst become clearly separated from their envelope; and a space appears on one side, in which ciliary movement can be distinguished (I). This space gradually extends all round, and a further discharge of granular matter takes place from the cyst, by which its form becomes altered (K); and the distinction between the newly-formed body to which the cilia belong, and the effete residue of the old, becomes more and more apparent (L). The former increases in size, whilst the latter diminishes; and at last the former makes its escape through an aperture in the wall of the cyst, a part of

* "Annales des Sci. Nat." Sér. 3, Tom. xix. p. 109.

the latter still remaining within its cavity (M). The body thus discharged (N) does not differ much in appearance from that of the *Oxytricha* before its encystment (F), though only of about two-thirds its diameter; but it soon develops itself (O, P, Q) into an Animalcule very different from that in which it originated. First it becomes still smaller, by the discharge of a portion of its substance; numerous very stiff bristle-like organs are developed, on which the Animalcule creeps, as by legs, over solid surfaces; the external integument becomes more consolidated on its upper sur-

FIG. 242.

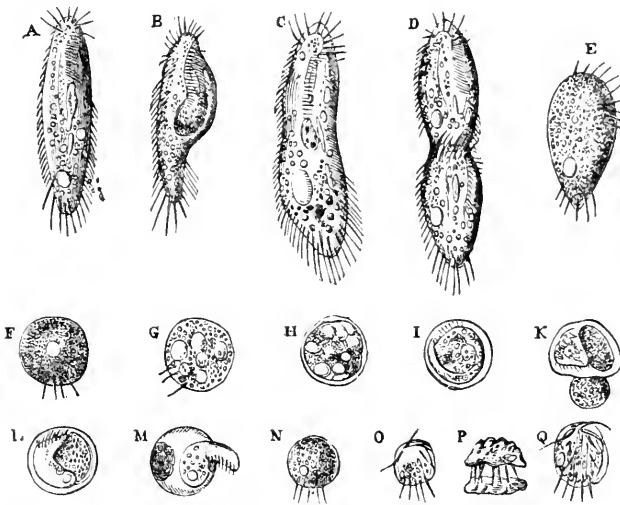

Metamorphoses of *Trichoda lynceus*:—A, larva (*Oxytricha*); B, a similar larva, after swallowing the animalcule represented at M; C, a very large individual on the point of undergoing fission; D, another in which the process has advanced further; E, one of the products of such fission; F, the same body become spherical and motionless; G, aspect of this sphere fifteen days afterwards; H, later condition of the same, showing the formation of the cyst; I, incipient separation between living substance and exuvial matter; K, partial discharge of the latter, with flattening of the sphere; L, more distinct formation of the confined animal; M, its escape from the cyst; N, its appearance some days afterwards; O, more advanced stage of the same; P, Q, perfect individuals, one as seen sideways, moving on its bristles, the other as seen from below; these are magnified twice as much as the preceding figures.

face, so as to become a kind of carapace; and a mouth is formed by the opening of a slit on one side, in front of which is a single hair-like filament, which is made to turn round and round with

great rapidity, so as to describe a sort of inverted cone, whereby a current is brought towards the mouth. This latter form has been described by Prof. Ehrenberg under the name of *Aspidisca*. It is very much smaller than the larva ; the difference being, in fact, twice as great as that which exists between Λ and P, Q (Fig. 242), since the last two figures are drawn under a magnifying power twice as great as that employed for the preceding. How the *Aspidisca*-form in its turn gives origin to the *Oxytricha*-form, has not yet been made-out. A Sexual process, it may be almost certainly concluded, intervenes somewhere ; but other transformations may not improbably take place, before the latter of these types is reproduced.

346. The Encysting process has been observed to take place among several other forms of Infusoria ; so that, considering the strong general resemblance in kind and degree of organization which prevails throughout the group, it does not seem unlikely that it may occur at some stage of the life of nearly all these Animalcules, just as the 'still' condition alternates with the 'motile' in the most active Protophytes (§§ 188-192). And it is not improbably in the 'encysted' condition that their dispersion takes place ; since they have been found to endure desiccation in this state, although in their ordinary condition of activity they cannot be dried-up without loss of life. When this circumstance is taken into account, in conjunction with the extraordinary rapidity of multiplication of these Animalcules, and with the fact that a succession of different forms may be presented by one and the same being, the difficulty of accounting for the universality of their diffusion, which has led some Naturalists to believe in their 'spontaneous generation,' and others to regard them as isolated particles of higher organisms set-free in their decomposition so as to constitute an 'equivocal generation,' is as readily got-over as we have seen it to be in the case of the Fungi (§ 268). Although it may be stated as a general fact, that wherever decaying Organic matter exists in a liquid state and is exposed to air and warmth, it speedily becomes peopled with these minute inhabitants,* yet it appears now to have been satisfactorily ascertained by the carefully conducted experiments of M. Pasteur, that perfectly free access of air to such infusions is essential to the appearance of Animalcules as well as of Protophytes (§ 263) in them. For having kept infusions of decaying Animal and Vegetable matter in air which had been filtered (so to speak) of any floating germs it might contain, by passing through a plug of cotton-wool, he found that no Animalcules made their appearance under these

* See his very important "Mémoire sur les Corpuscles Organisés qui existent dans l'Atmosphère," in "Ann. des Sci. Nat." Sér. 4, Tom. xvi. p. 5, which disposes effectually of the doctrine of 'spontaneous generation.'

circumstances, even after the lapse of several months ; although they were seen in abundance after the free exposure of the same infusions to the atmosphere for a few hours only. Hence it may be fairly inferred, that, as seems to be the case with the Fungi, the dried cysts or germs of Infusoria are everywhere floating about in the air, ready to develop themselves wherever the appropriate conditions are presented ; and all our knowledge of their history, as well as the strong analogy of the Fungi (§ 268), seems further to justify the belief that the same germs may develop themselves into several different forms, according to the nature of the liquid in which they chance to be deposited.—This is a subject peculiarly worthy of the attention of Microscopic observers ; who can scarcely be better employed than in tracing-out the succession of phases which any particular type may present, and in thus making a most important extension of our knowledge of its life-history, whilst at the same time effecting a most desirable reduction in the number of reputed Species.

347. A very important advance has recently been made in this direction, by the discovery that a true process of *Sexual Generation* occurs among Infusoria ;—a discovery which has been more or less nearly approached by various observers, but of which the satisfactory completion has been attained by the researches of M. Balbiani.* It appears from his observations, that male and female organs are combined in each individual of the numerous genera he has examined, but that the congress of two individuals is necessary for the impregnation of the ova, those of each being fertilized by the spermatozoa of the other. The *ovarium* (or aggregation of germ-cells) is that organ which has been described by many observers as the ‘nucleus ;’ whilst the *testis* (or aggregation of sperm-cells) is that which has been described as the ‘nucleolus.’ The development of each of these organs commences as a single minute cell, which usually multiplies itself in the usual way by subdivision ; and when this multiplication has proceeded to a certain point, the cells of the ovary become converted into Ova, whilst those of the testis develop Spermatozoa in their interior. The particular form and position which these organs present, and the nature of the changes which they undergo, vary in the several types of Infusoria ;† but as we have in the

* See his “Recherches sur les Phénomènes Sexuels des Infusoires,” in Dr. Brown-Séguard’s “Journal de la Physiologie” for 1861. An abstract of these researches is contained in the “Quart. Journ. of Microsc. Science,” for July and October, 1862.

† Thus, according to M. Balbiani, the ovary of *Chilodon cucullulus* never advances beyond the condition of a single ‘primitive ovum,’ formed by the differentiation of the contents of the original ‘germ-cell’ into the granular yolk-substance and the pellucid ‘germinal vesicle’ imbedded in it. But in other Infusoria the ‘germ-cell’ undergoes repeated subdivisions ; so that from 2 to 4 Ova (as in *Paramecium*), from 8 to 15 (as in *Stentor*), from 20 to 25 (as in *Amphileptus gigas*), from 20 to 50 (as in

common *Paramecium aurelia* an example, which, although exceptional in some particulars, affords peculiar facilities for the observation of the process, and has been most completely studied by M. Balbiani, it is here selected for illustration. This Animalcule, as is well known, multiplies itself with great rapidity (under favourable circumstances) by duplicative subdivision, which always takes place in the *transverse* direction; and the condition represented in Plate xiv., figs. 1, 2, is not, as has been usually supposed, another form of the same process, but is really the Sexual congress of two individuals previously distinct. When the period arrives at which the *Paramecia* are to propagate in this manner, they are seen assembling upon certain parts of the vessel, either towards the bottom or on the walls; and they are soon found coupled in pairs, closely adherent to each other, with their similar extremities turned in the same direction, and their two mouths closely applied to one another. The *Paramecia* and other free-swimming Animalcules, while conjugated, continue moving with agility in the liquid, turning constantly round upon their axes; but those which, like *Stentor*, are attached by a foot-stalk, remain almost motionless (fig. 21). This conjugation lasts for five or six days, during which period very important changes take place in the condition of the reproductive organs. In order to distinguish these, the Animalcules should be slightly flattened by compression, and treated with acetic acid, which brings the reproductive apparatus into more distinct view, as shown in Plate xiv., figs. 1-5. In fig. 1 each individual contains an Ovary, *a*, which is shown to present in the first instance a smooth surface; and from this there proceeds an excretory canal or oviduct, *c*, that opens externally at about the middle of the length of the body into the buccal fissure, *e*. Each individual also contains a Seminal Capsule, *b*, in which is seen lying a bundle of spermatozooids curved upon itself, and which communicates by an elongated neck with the orifice of the excretory canal. The successive stages by which the seminal capsule arrives at this condition from that of a simple cell, whose granular contents resolve themselves (as it were) into a bundle of filaments, are shown in figs. 6-10. In fig. 2 the surface of the ovary, *a*, is seen to present a lobulated appearance, which is occasioned by the

Spirostomum ambiguum), and even 100 or more (as in a species of *Urostyla*), may be developed in a single individual. In some cases, again, the subdivision does not involve the entire 'germ-cells' in the first instance, but affects only their 'germinal vesicles;' these being multiplied in the midst of the undivided granular yolk-mass, but drawing round themselves, near the time of conjugation, their several shares of this substance, and becoming completed into ova by the formation of an investment round their respective yolk-segments: this is the mode in which ova are produced in the *Vorticellina*. In *Paramecium* it seems as if the whole of the granular yolk-mass were not thus appropriated; a number of sterile yolk-segments (*a*, *a*, Plate xiv., fig. 5) being left after the maturation of the ova.

PLATE XIV.

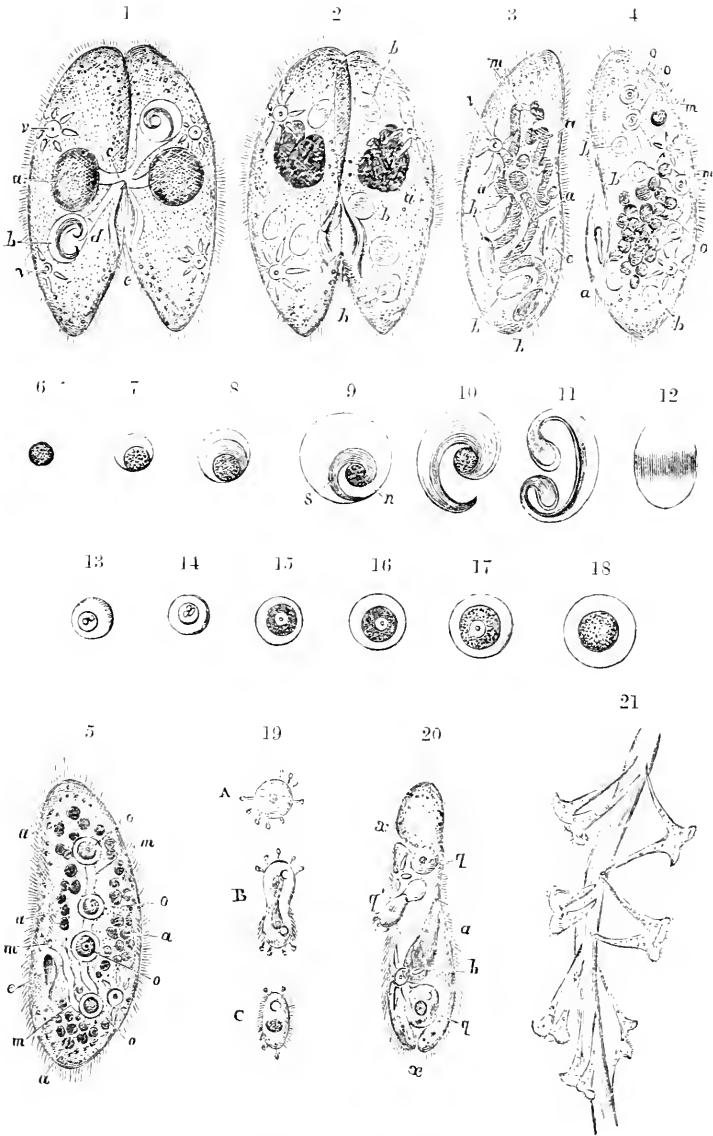

SEXUAL REPRODUCTION OF INFUSORIA.

[To face p. 464.



commencement of its resolution into separate ova; while the Seminal capsule is found to have undergone division into two or four secondary capsules, *b, b*, each of which contains a bundle of Spermatozoa now straightened out. This division takes place by the elongation of the capsule into the form represented in fig. 11, and by the narrowing of the central portion whilst the extremities enlarge; the further multiplication being effected by the repetition of the same process of elongation and fission. In fig. 3, which represents one of the individuals still in conjugation, the four Seminal capsules, *b, b*, are represented as thus elongated in preparation for another subdivision; whilst the Ovary, *a, a*, has begun as it were to unroll itself, and to break-up into fragments which are connected by the tube *m*. In this condition it is that the object of the conjugation appears to be effected by the passage of the seminal capsules of each individual, previously to their complete maturation, into the body of the other. In fig. 4 is shown the condition of a *Paramecium* ten hours after the conclusion of the conjugation; the Ovary has here completely broken up into separate granular masses, of which some, *a, a*, remain unchanged, whilst others, *o, o, o, o*, either two, four, or eight in number, are converted into Ovules that appear to be fertilized by the escape of the Spermatozoa from the seminal capsules, these being now seen in process of withering. Finally, in fig. 5, which represents a *Paramecium* three days after the completion of the conjugation, are seen four complete Ova, *o, o, o, o*, within the connecting tube, *m, m*; whilst the seminal capsules have now altogether disappeared. In figs. 13-18 are seen the successive stages of the development of the ovule, which seems at first (fig. 13) to consist of a germ-cell having within it a secondary cell containing minute granules, which is to become the 'vitelline vesicle.' This secondary cell augments in size, and becomes more and more opaque from the increase of its granular contents (figs. 14, 15, 16), forming the 'vitellus' or yolk; in the midst of which is seen the clear 'germinal vesicle,' which shows on its wall, as the ovule approaches maturity, the 'germinal spot' (fig. 17). The germinal vesicle is subsequently concealed (fig. 18) by the increase in the quantity and opacity of the vitelline granules. The fertilized ova seem to be expelled by the gradual shortening of the tube that contains them; and this shortening also brings together the scattered fragments of the granular substance of the original ovarium, so as to form a mass resembling that shown in fig. 1, *a*, by the evolution of which after the same fashion another brood of ova may be produced. The development of the ova after their extrusion from the body has not yet been followed out; and its history constitutes a most important object of inquiry.

348. The Reproductive process in the ordinary Infusoria was entirely misconceived by Prof. Stein, who advanced the doctrine that they commonly pass through the condition of *Acinete*, which

constitute a peculiar tribe of *suctorial* Animalcules, furnished with tubular prolongations which act as suckers. This doctrine of the Acineta-forms, which received for a time very general credence on Prof. Stein's authority, but was strongly contested by others, may now be regarded as finally set aside; having been based on a misinterpretation of the curious phenomena of *parasitism* exhibited by these Animalcules, which penetrate the bodies of other Animalcules, either in their inactive or in their encysted condition, and develope and multiply themselves in their interior. In fig. 20 is seen a *Paramcium* containing three of these parasites, *q, q, q'*, which work their way into the body without rupturing its integument, pushing this before them so as to form a sort of pouch, wherein they lie, that opens externally in a canal of which the mouth is seen at *x, x*. The sexual organs of this individual, displaced by the parasites, are shown at *a, b*. In fig. 19 are seen three *Acinetæ* in different stages of their free state; one of them, *A*, being in repose, but putting forth its suctorial appendages; another, *B*, undergoing self-division, and having cilia as well as suckers on one-half; and a third, *c*, swimming actively in the liquid by means of its cilia. Another parasitic growth, consisting of a large vesicle crowded with Vibrios, has been mistaken by some excellent observers for a spermatic cyst filled with spermatozoa.

349. It is obvious that no Classification of Infusoria can be of any permanent value, until it shall have been ascertained by the study of their entire life-history what are to be accounted really distinct forms; and the differences between them, consisting chiefly in the shape of their bodies, the disposition of their cilia, the possession of other locomotive appendages, the position of the mouth, the presence of a distinct anal orifice, and the like, are matters of such trivial importance as compared with those leading features of their structure and physiology on which we have been dwelling, that it does not seem desirable to attempt in this place to give any account of them. The most remarkable departure from the ordinary type is presented by the *Vorticellinæ*, the habit of which is to attach themselves to the stems of aquatic plants or some other supports, either by the apex of their own conical body,—as is the case with *Stentor* (Plate XIV., fig. 21), one of the largest of all Infusoria (being visible to the naked eye), which is very common in ponds and ditches, attaching itself to duck-weed, decaying reeds, or other floating bodies, round which it forms a sort of slimy fringe, but which is often found swimming freely, its trumpet-shaped body drawn together into the form of an egg,—or by a footstalk several times its own length, as is the case with *Vorticella* (Fig. 239), which also occasionally quits its attachment (the stalk apparently dying and being thrown-off), and swims rapidly through the water, being propelled by the fringe of cilia, which, when the body was fixed by its stalk, served to produce

a vortex in the surrounding fluid, that brought it both food and air.

350. Another curious departure from the ordinary type is presented by the Family *Ophrydinæ*; the Animalcules of which, closely resembling some Vorticellinæ in their individual structure, are usually found imbedded in a gelatinous mass of a greenish colour, which is sometimes adherent, sometimes free, and may attain the diameter of four or five inches, presenting such a strong general resemblance to a mass of *Nostoc* (§ 244) or even of Frogs' spawn, as to have been mistaken for such. The mode in which these masses are produced closely resembles that in which the masses of *Mastogloia* (§ 234) or of *Palmella* (§ 239) are formed; since they simply result from the fact that the multitude of individuals produced by a repetition of the process of self-division, remain connected with each other for a time by a gelatinous exudation from the surface of their bodies, instead of at once becoming completely isolated. From a comparison of the dimensions of the individual *Ophrydia*, each of which is about 1-120th of an inch in length, with those of the composite masses, some estimate may be formed of the number included in the latter; for a cubic inch would contain nearly *eight millions* of them, if they were closely packed; and many times that number must exist in the larger masses, even making allowance for the fact that the bodies of the Animalcules are separated from each other by their gelatinous cushion, and that the masses have their central portions occupied only by water. Hence we have, in such clusters, a distinct proof of the extraordinary extent to which multiplication by duplicative subdivision may proceed, without the interposition of any other operation. These Animalcules, however, free themselves at times from their gelatinous bed, and have been observed to undergo an 'encysting-process' corresponding with that of the Vorticellinæ (§ 344).

351. It is much to be desired that Microscopic observers should devote themselves systematically to the continuous study of even the commonest and best-known forms of Infusory Animalcules; since there is *not a single one* whose entire Life-history, from one Generative act to another, is known to us. And since it cannot be even guessed at, without such knowledge, what, among the many dissimilar forms that have been described by Prof. Ehrenberg and others, are to be accounted as truly distinct Species, and what are mere phases in the existence of others that are perhaps very dissimilar to them in aspect, it is obvious that no credit is really to be gained by the discovery of any number of apparently-new species, which shall be at all comparable with that to be acquired by the complete and satisfactory elucidation of the Life-history of any one.

352. As it is among Animalcules that the action of the organs termed *Cilia* has the most important connection with the vital functions, it seems desirable to introduce here a more particular

notice of them. They are always found in connection with *cells*, of whose substance, as we have seen among Protophytes (§§ 189, 194), they may be considered as extensions. The form of the filaments is usually a little flattened, and tapering gradually from the base to the point. Their size is extremely variable; the largest that have been observed being about 1-500th of an inch in length, and the smallest about 1-13,000th. When in motion, each filament appears to bend from its root to its point, returning again to its original state, like the stalks of corn when depressed by the wind; and when a number are affected in succession with this motion, the appearance of progressive waves following one another is produced, as when a corn-field is agitated by successive gusts. When the ciliary action is in full activity, however, little can be distinguished save the whirl of particles in the surrounding fluid; but the *back-stroke* may often be perceived, when the *forward-stroke* is made too quickly to be seen; and the real direction of the movement is then opposite to the apparent. In this back-stroke, when made slowly enough, a sort of 'feathering' action may be observed; the thin edge being made to cleave the liquid, which has been struck by the broad surface in the opposite direction. It is only when the rate of movement has considerably slackened, that the shape and size of the cilia, and the manner in which their stroke is made, can be clearly seen. It has been maintained by some that the action of the Cilia is Muscular; but they are often too small to contain even the minutest fibrillæ of true muscular tissue, and no such elements can be discerned around their base; their presence in Plants, moreover, seems distinctly to negative such an idea. Hence we must consider them as organs *sui generis*, wherein the contractility of the cell to which they belong is (as it were) concentrated. We have seen that in the *Rhizopods*, the entire mass of whose sarcode is highly contractile, no cilia are present; whilst in the Infusoria, whose bodies have comparatively little contractility, the movements are delegated to the cilia.—Cilia are not confined, however, to Animalcules and Zoophytes, but exist on some of the free internal surfaces, especially the walls of the Respiratory passages, of all the higher Animals, not excepting Man himself. Our own experience assures us that their action takes place, not only without any exercise of *will* on our own parts, but even without affecting our *consciousness*; and it has been found to continue for many hours, or even days, after the death of the body at large. How far it is subject to any conscious control on the part of these Animalcules, in which the cilia serve as instruments for locomotion, as well as for bringing to them food or oxygen, it is impossible for any one to say with confidence. In this important respect, however, the ciliary movement of Animalcules differs from that which is observable in the higher animals,—that whilst in the latter it is *constant*, giving the idea of purely automatic agency, in the former it is so interrupted and renewed.

as almost necessarily to suggest to the observer the notion of choice and direction.

353. ROTIFERA, OR WHEEL-ANIMALCULES.—We now come to that higher group of Animalcules, which, in point of complexity of organization, is as far removed from the preceding, as Mosses are from the simplest Protophytes; the only point of real resemblance between the two groups, in fact, being the minuteness of size which is common to both, and which was long the obstacle to the recognition of the comparatively elevated character of the *Rotifera*, as it still is to the precise determination of certain points of their structure. Some of the Wheel-Animalcules are inhabitants of Salt-water only, but by far the larger proportion are found in collections of Fresh-water, and rather in such as are free from actively decomposing matter, than in those which contain organic substances in a putrescent state. Hence when they present themselves in Vegetable infusions, it is usually after that offensive condition which is favourable to the development of many of the Infusoria has passed-away; and they are consequently to be looked-for after the disappearance of many successions (it may be) of Animalcules of inferior organization. Rotifera are more abundantly developed in liquids which have been long and freely exposed to the open air, than in such as have been kept under shelter; certain kinds, for example, are to be met-with in the little pools left after rain in the hollows of the lead with which the tops of houses are partly covered; and they are occasionally found in enormous numbers in cisterns which are not beneath roofs or otherwise covered-over.* They are not, however, absolutely confined to collections of liquid; for there are a few species which can maintain their existence in damp earth; and the common *Rotifer* is occasionally found in the interior of the leaf-cells of *Sphagnum* (§ 275).

354. The Wheel-like organs from which the class derives its designation, are most characteristically seen in the common form just mentioned (Fig. 244), where they consist of two disk-like lobes or projections of the body, whose margins are fringed with long cilia; and it is the uninterrupted succession of strokes given by these cilia, each row of which nearly returns (as it were) into itself, that gives rise by an optical illusion to the notion of 'wheels.' This arrangement, however, is by no means universal; in fact, it obtains in only a small proportion of the group; and by far the more general plan is that seen in Fig. 243, in which the cilia form one continuous line across the body, being disposed upon the sinuous edges of certain lobes or projections which are borne upon its anterior portion. Some of the chief departures from this plan will be noticed hereafter (§ 363).

355. The great transparency of the Rotifera permits their

* See a remarkable instance of this in p. 246, *note*.

general structure to be easily recognized. They have usually an elongated form, similar on the two sides; but this rarely exhibits any traces of segmental division. The body is covered with a double envelope, both layers of which are extremely thin and flexible in some species, whilst in others the outer one seems to possess a horny consistence. In the former case the whole integument is drawn together in a wrinkled manner when the body is shortened; in some of the latter the sheath has the form of a polype-cell, and the body lies loosely in it, the inner layer of the

FIG. 243.

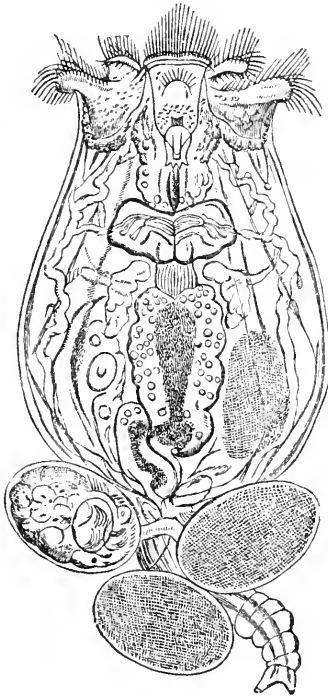
*Brachionus pala.*

integument being separated from the outer by a considerable space (Fig. 246); whilst in others the envelope or *lorica* is tightly fitted to the body, and strongly resembles the horny casing of an Insect or the shell of a Crab, except that it is not jointed, and does not extend over the head and tail, which can be projected from the openings at its extremities, or completely drawn within it for protection (Fig. 247). In those Rotifera in which the flexibility of the body is not interfered with by the consolidation of the external integument, we usually find it capable of great variation in shape, the elongated form being occasionally exchanged for an almost globular one, as is seen especially when the animals are suffering from deficiency of water; whilst by alternating movements of contraction and extension, they can make their way over solid surfaces, after the manner of a Worm or a Leech, with considerable activity,—some even of the loricated species being rendered

capable of this kind of progression by the contractility of the head and tail. All these, too, can swim readily through the water by the action of their cilia; and there are some species which are limited to the latter mode of progression. The greater number have an organ of attachment at the posterior extremity of the body, which is usually prolonged into a tail, by which they can affix

themselves to any solid object ; and this is their ordinary position, when keeping their 'wheels' in action for a supply of food or of water ; they have no difficulty, however, in letting-go their hold and moving through the water in search of a new attachment, and may therefore be considered as perfectly free. The polypoid species, on the other hand, remain attached by the posterior extremity to the spot on which they have at first fixed themselves ; and their cilia are consequently employed for no other purpose than that of creating currents in the surrounding water.

356. In considering the internal structure of Rotifera, we shall take as its type the arrangement which it presents in the *Rotifer vulgaris* (Fig. 244) ; and specify the principal variations exhibited elsewhere. The body of this animal, when fully extended, possesses greater length in proportion to its diameter than that of most others of the Class ; and the tail is composed of three joints or segments, which are capable of being drawn-up, one within another, like the sliding tubes of a telescope, each having a pair of prongs or points at its extremity. Within the external integument of the body are seen a set of longitudinal muscular bands (*h*), which serve to draw the two extremities towards each other ; and these are crossed by a set of transverse annular bands, which also are probably muscular, and serve to diminish the diameter of the body, and thus

FIG. 244.

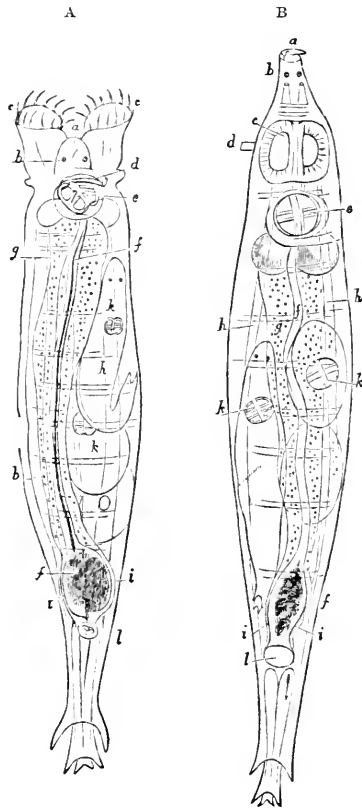

Rotifer vulgaris, as seen at A with the wheels drawn-in, and at B with the wheels expanded:—*a*, mouth ; *b*, eye-spots ; *c*, wheels ; *d*, calcar (antenna?) ; *e*, jaw and teeth ; *f*, alimentary canal ; *g*, glandular (?) mass enclosing it ; *h*, longitudinal muscles ; *i*, *i*, tubes of water-vascular system ; *k*, young animal ; *l*, cloaca.

to increase its length. Between the

wheels is a prominence bearing two red spots (*b*), supposed to be rudimentary eyes, and having the mouth (*a*) at its extremity; this prominence may be considered, therefore, as a true head, notwithstanding that it is not clearly distinguishable from the body. This head also bears upon its undersurface a projecting tubular organ (*d*), which was thought by Professor Ehrenberg to be a siphon for the admission of water to the cavity of the body for the purpose of respiration; this, however, is certainly not the case, the tube being imperforate at its extremity; and there seems much more probability in the idea of Dujardin, that it represents the *antennæ* or *palpi* of higher Articulata, the single organ being replaced in many Rotifera by a pair, of which each is furnished at its extremity with a brush-like tuft of hairs that can be retracted into the tube. The œsophagus, which is narrow in the *Rotifer*, but is dilated into a crop in *Stephanoceros* (Fig. 246) and in some other genera, leads to the masticating apparatus (Fig. 244, *e*), which in these animals is placed far behind the mouth, and in close proximity to the stomach.

357. The Masticating apparatus has recently been made the subject of attentive study by Mr. P. H. Gosse; who has given an elaborate account of the various types of form which it presents in the several subdivisions of the group.* The following description of one of the more complicated will serve our present purpose. The various movable parts are included in a muscular bulb, termed the *mastax* (Fig. 245 *a*), which intervenes between the buccal funnel (*m*) and œsophagus (*p*). The mastax includes a pair of organs, which, from the resemblance of their action to that of hammers working on an anvil, may be called *mallei*, and a third, still more complex, termed the *incus*. Each Malleus consists of two principal parts placed nearly at right angles to each other, the *manubrium* (*c*), and the *uncus* (*e*); these are articulated to one another by a sort of hinge-joint. The former, as its name imports, serves the purpose in some degree of a handle; and it is the latter which is the instrument for crushing and dividing the food. This is done by means of the finger-like processes with which it is furnished at the edge where it meets its fellow; these being five or six in number, set parallel to each other like the teeth of a comb. The Incus also consists of distinct articulated portions, namely, two stout *rami* (*a*) resting on what seems a slender footstalk (*h*) termed the *fulcrum*; when viewed laterally, however, the fulcrum is seen to be a thin plate, having the rami so jointed to one edge of it that they can open and close like a pair of shears. The uncus of each Malleus falls into the concavity of its respective ramus, and is connected with it by a stout triangular muscle (*i*) which is seen passing from the hollow of the ramus to the under surface of the uncus. It is difficult to say with certainty what is

* "Philosophical Transactions," 1856, p. 419.

the substance of which these firm structures are composed ; it is not affected by solution of potass, but is instantly dissolved without effervescence by the mineral acids and by acetic acid. Besides the muscles already described, a thick band (*j*) embraces the upper

FIG. 245.

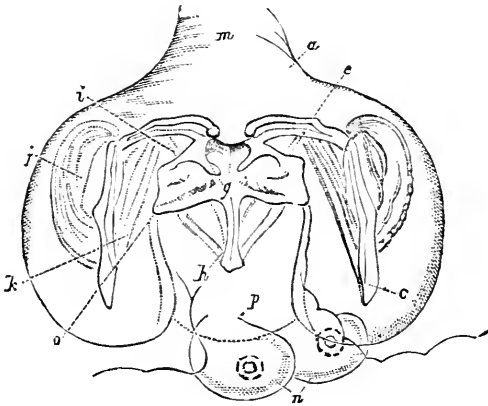

Masticating Apparatus of *Euchlanis deflexa* :—*a*, Mastax ; *c*, manubrium, and *e*, uncus, of Malleus ; *g*, rami, and *h*, fulcrum, of Incus ; *i*, muscle connecting ramus and uncus ; *j*, muscle passing from malleus to mastax ; *k*, muscle connecting uncus and manubrium ; *m*, buccal funnel ; *n*, salivary glands ; *p*, œsophagus.

and outer angle of the articulation of the malleus ; and is inserted in the adjacent wall of the mastax ; and a semicrescentic band (*k*) is inserted by its broad end into the inferior and basal part of the uncus, and by its slender end into the middle of the inner side of the manubrium ; the former of these may be considered as an extensor, and the latter as a flexor, of the malleus. By these and other muscles which cannot be so clearly distinguished, the unci are made to approach and recede by a perpendicular motion on the hinge-joint, so that their opposing faces come into contact, and their teeth bruise-down the particles of food ; but at the same time they are carried apart and approximated laterally by the movement of the free extremities of the manubria. The rami of the Incus also open and shut with the working of the Mallei : and by the conjoint action of the whole, the food is effectually comminuted in its passage downwards.

358. The form of the Alimentary Canal varies ; this being sometimes a simple tube, passing without enlargement or constriction from the masticating apparatus to the anal orifice at the posterior part of the body ; whilst in other instances there is a marked dis-

inction between the stomach and intestinal tube, the former being a large globular dilatation immediately below the jaws, whilst the latter is cylindrical and comparatively small. The alimentary canal of *Rotifer* (Fig. 244) most resembles the first of these types, but presents a dilatation (*l*) close to the anal orifice, which may be considered as a cloaca; that of *Brachionus* (Fig. 243) is rather formed upon the second. Connected with the alimentary canal are various Glandular appendages, more or less developed; sometimes clustering round its walls as a mass of separate follicles, which seems to be the condition of the glandular investment (*g*) of the alimentary canal in *Rotifer*; in other cases having the form of caecal tubuli. Some of these open into the stomach close to the termination of the oesophagus, and have been supposed to be Salivary or Pancreatic in their character, whilst others, which discharge their secretion into the intestinal tube, have been regarded, and probably with correctness, as the rudiment of a Liver.—In a curious animalcule of this class, minutely described by Mr. Dalrymple,* although the mouth, masticating apparatus, and stomach are constructed upon the regular type of the genus *Notommata*, to which it seems nearly allied, yet there is neither intestine nor anal orifice, the indigestible matters being rejected through the mouth. This, so far as is yet known, is a solitary example of the existence of this character of degradation in the class Rotifera.

359. There does not appear to be any special Circulating Apparatus in these animals; but the fluid which is contained in the 'general cavity of the body,' between the exterior of the alimentary canal and the inner tegumentary membrane, is probably to be regarded as nutritive in its character; and its aeration is provided for by a peculiar apparatus, which seems to be a rudimentary form of the 'water-vascular system,' that attains a high development in the class of Worms. On either side of the body there is usually to be observed a long flexuous tube (Fig. 243), which extends from a contractile vesicle common to both and opening into the Cloaca (Fig. 244, *i, i*) towards the anterior region of the body, where it frequently subdivides into branches, one of which may arch-over towards its opposite side, and inosculate with a corresponding branch from its tube. Attached to each of these tubes are a number of peculiar organs (usually from two to eight on each side), in which a trembling movement is seen, very like that of a flickering flame; these appear to be pear-shaped sacs, attached by hollow stalks to the main tube, and each having a long cilium in its interior, that is attached by one extremity to the interior of the sac, and vibrates with a quick undulatory motion in its cavity; and there can be little doubt that their purpose is to keep-up a constant movement in the contents of the aquiferous tubes, whereby fresh water may be continually introduced from without for the

* "Philosophical Transactions," 1849, p. 339.

aeration of the fluids of the body.*—There is much uncertainty with regard to the structures which Prof. Ehrenberg has described as Ganglia and Nerves; and it seems doubtful if there is more than a single nervous centre in the neighbourhood of the single, double, or multiple red spots, which are seen upon the head of the Rotifera, and which, corresponding precisely in situation with those that in the higher Articulata are unquestionably eyes, are probably to be regarded as rudiments of Visual organs.

360. The Reproduction of the Rotifera has not yet been completely elucidated. There is no instance, in this group, in which multiplication by external gemmation or spontaneous fission is certainly known to take place; but the occurrence of clusters formed by the aggregation of a number of individuals of *Conochilus*, adherent by their tails, and enclosed within a common *lorica*, would seem to indicate that these clusters, like the aggregations of Polygastrica, Bryozoa, and Tunicata, must have been formed by continuous growth from a single individual. It will be presently shown, moreover, that there is strong reason for the belief that what are commonly termed 'eggs' are really internal gemmæ. Although the Rotifera were affirmed by Prof. Ehrenberg to be hermaphrodite, yet the existence of distinct Sexes has been detected in so many genera (for the most part by Mr. Gosse †), that it may fairly be presumed to be the general fact. The Male is inferior in size to the female, and sometimes differs so much in organization that it would not be recognized as belonging to the same species, if the copulative act had not been witnessed. In all the cases yet known, as in the *Asplanchna*, whose separate male was first discovered by Mr. Brightwell in 1848, there is an absolute and universal atrophy of the digestive system; neither masticatory, jaws, œsophagus, stomach, nor intestines, being discoverable in any male; in fact, no other organs being fully developed than those of generation. It would appear, therefore, quite unfit to obtain aliment for itself; and its existence is probably a very brief one, being continued only so long as the store of nutriment supplied by the egg remains unexhausted. In *Rotifer*, however, as in by far the larger proportion of the class, no males have been discovered; probably because they are produced only at certain times. The Female organ consists of a single ovarian sac, which frequently occupies a large part of the cavity of the body, and opens at its lower end by a narrow orifice into the Cloaca. Although the number of eggs in these animals is so small, yet the rapidity with which the whole process of their development and

* See Mr. Huxley's account of these organs, in his description of *Lacunararia socialis*, "Transact. of Microsc. Soc.," Ser. 2, Vol. i.—Other observers have supposed that the pyriform sacs communicate with the general cavity of the body; but the Author has much confidence in the correctness of Mr. Huxley's statements on this point.

† "Philosophical Transactions," 1857.

maturation is accomplished, renders the multiplication of the race very rapid. The Egg of the *Hydatina* is extruded from the cloaca within a few hours after the first rudiment of it is visible; and within twelve hours more the shell bursts, and the young animal comes forth. In the *Rotifer* and several other genera, the development of the Embryo takes-place whilst the egg is yet retained within the body of the parent (Fig. 244, *k*), and the young are extruded alive; whilst in some other instances the eggs, after their extrusion, remain attached to the posterior extremity of the body (Fig. 243), until the young are set free. In general it would seem that whether the rupture of the egg-membrane takes-place before or after the egg has left the body, the germinal mass within it is developed at once into the form of the young animal, which resembles that of its parent; no preliminary metamorphosis being gone through, nor any parts developed which are not to be permanent. The transparency of the egg-membrane, and also of the tissues, of the parent Rotifer, allows the process of development to be watched, even when the egg is retained within the body; and it is curious to observe, at a very early period, not merely the red eye-spot of the embryo, but also a distinct ciliary movement. The multiplication of *Hydatina* (in which genus three or four eggs are deposited at once, and their development completed out of the body) takes place so rapidly, that, according to the estimate of Prof. Ehrenberg, nearly *seventeen millions* may be produced within twenty-four days from a single individual.

361. Even in those species which usually hatch their eggs within their bodies, a different set of Ova is occasionally developed, which are furnished with a thick glutinous investment; these, which are extruded entire, and are laid one upon another, so as at last to form masses of considerable size in proportion to the bulk of the animals, seem not to be destined to come so early to maturity, but very probably remain dormant during the whole winter season, so as to produce a new brood in the spring. These 'winter-eggs' are inferred by Mr. Huxley, from the history of their development, to be really *gemmæ* produced by a non sexual operation; while the bodies ordinarily known as ova, he considers to be true Generative products. Dr. Cohn, however, states that he has ascertained, by direct experiment upon those species in which the sexes are distinct, that the bodies commonly termed 'ova' (Figs. 243, 244), are really *internal gemmæ*, since they are reproduced, through many successions, without any sexual process, just like the external *gemmæ* of *Hydra* (§ 411), or the internal *gemmæ* of *Entomostraca* (§ 502) and *Aphides* (§ 533); whilst the 'winter-eggs' are only produced as the result of a true Generative act.* And this view appears to the Author more accordant with general

* See his important Memoir, 'Ueber die Fortpflanzung der Rädertiere, in "Siebold and Kölliker's Zeitschrift," 1855.

physiological analogy than that of Mr. Huxley ; since, in the other instances referred-to, as in the Rotifera, the multiplication by Gemmation goes-on rapidly so long as food and warmth are abundantly supplied ; but gives place to the Generative process, when the nutritive activity is lowered by their withdrawal.

362. Certain Rotifera, among them the common Wheel-Animalcule, are remarkable for their tenacity of life, even when reduced to the state of most complete dryness ; for they can be kept in this condition for any length of time, and will yet revive very speedily upon being moistened. Experiments have been carried still farther with the tribe of *Tardigrada* (§ 363, iv.) ; individuals of which have been kept in a vacuum for thirty days, with sulphuric acid and chloride of calcium (thus suffering the most complete desiccation that the Chemist can effect), and yet have not lost their capability of revivification. This fact, taken in connection with the extraordinary rate of increase mentioned in the preceding paragraph, removes all difficulty in accounting for the extent of the diffusion of these animals, and for their occurrence in incalculable numbers in situations where, a few days previously, none were known to exist. For their entire bodies may be wafted in a dry state by the atmosphere from place to place ; and their return to a state of active life, after a desiccation of unlimited duration, may take place whenever they meet with the requisite conditions—moisture, warmth, and food. It is probable that the Ova are capable of sustaining treatment even more severe than the fully developed Animals can bear ; and that the race is frequently continued by them when the latter have perished.

363. The principles on which the various forms that belong to this Class should be systematically arranged, have not yet been satisfactorily determined. By Prof. Ehrenberg, the disposition of the ciliated lobes or wheel-organs, and the enclosure or non-enclosure of the body in a *lorica* or case, were taken as the basis of his classification ; but as his ideas on both these points are inconsistent with the actual facts of organization, the arrangement founded upon them cannot be received. Another division of the class has been propounded by M. Dujardin, which is based on the several modes of life of the most characteristic forms. And in a third, more recently put forth by Prof. Leydig, the general configuration of the body, with the presence, absence, and conformation of the foot (or tail) are made to furnish the characters of the subordinate groups. Either of the two latter is certainly more *natural* than the first, as bringing together for the most part the forms which most agree in general organization, and separating those which differ ; and we shall adopt that of M. Dujardin as most suitable to our present purpose.

1. The first group includes those that habitually live attached by the Foot, which is prolonged into a pedicle ; and it includes two families, the *Floscularians* and the *Melicertians*, both of which bear

a certain general resemblance to the *Vorticellinae* (§ 340) on the one hand, and to Zoophytes (Chap. XI.) on the other. For they are commonly found attached to the stems and leaves of aquatic

FIG. 246.

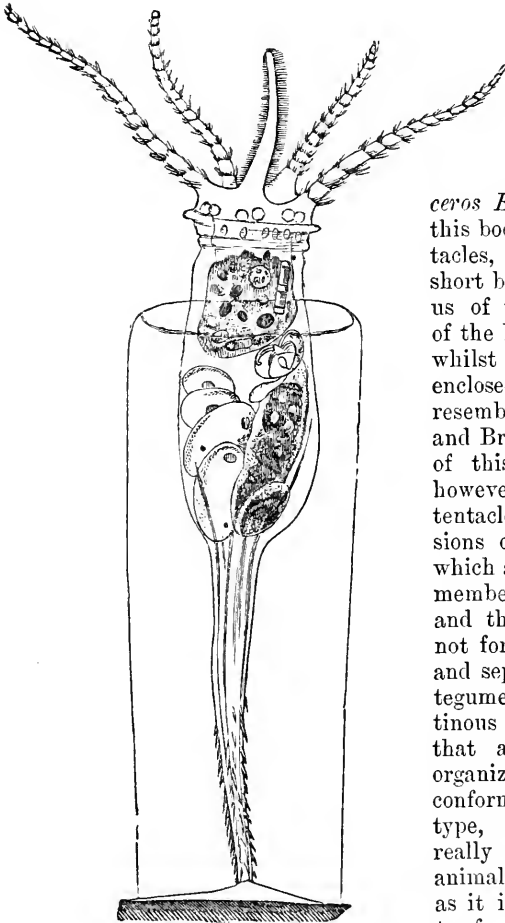
*Stephanoceros Eichornii.*

plants, by a long pedicle or foot-stalk, which bears a somewhat bell-shaped body; and in one of the most beautiful species, the *Stephanoceros Eichornii* (Fig. 246), this body has five long tentacles, beset with tufts of short bristly cilia, reminding us of the ciliated tentacles of the Bryozoa (Chap. XIII.), whilst the body seems to be enclosed in a cylindrical cell, resembling that of Hydrozoa and Bryozoa. A comparison of this with other forms, however, shows that these tentacles are only extensions of the ciliated lobes which are common to all the members of these families; and the so-called 'cell' is not formed by a thickening and separation of the outer tegument; but by a gelatinous secretion from it; so that as the rest of the organization is essentially conformable to the Rotiferous type, no such passage is really established by this animal towards other groups, as it is commonly supposed to form. — In one respect *Floscularia* is still more aberrant; for the long bristly filaments, which its lobes are beset with, are not capable of rhythmical vibration. The true representative of the 'wheels' of other Rotifera is a ciliated band that may be detected around the entrance of the Œsophageal funnel.—The body of *Melicerta* is

plants, by a long pedicle or foot-stalk, which bears a somewhat bell-shaped body; and in one of the most beautiful species, the *Stephanoceros Eichornii* (Fig. 246), this body has five long tentacles, beset with tufts of short bristly cilia, reminding us of the ciliated tentacles of the Bryozoa (Chap. XIII.), whilst the body seems to be enclosed in a cylindrical cell, resembling that of Hydrozoa and Bryozoa. A comparison of this with other forms, however, shows that these tentacles are only extensions of the ciliated lobes which are common to all the members of these families; and the so-called 'cell' is not formed by a thickening and separation of the outer tegument; but by a gelatinous secretion from it; so that as the rest of the organization is essentially conformable to the Rotiferous type, no such passage is really established by this animal towards other groups, as it is commonly supposed to form. — In one respect *Floscularia* is still more aberrant; for the long bristly filaments, which its lobes are beset with, are not capable of rhythmical vibration. The true representative of the 'wheels' of other Rotifera is a ciliated band that may be detected around the entrance of the Œsophageal funnel.—The body of *Melicerta* is

plants, by a long pedicle or foot-stalk, which bears a somewhat bell-shaped body; and in one of the most beautiful species, the *Stephanoceros Eichornii* (Fig. 246), this body has five long tentacles, beset with tufts of short bristly cilia, reminding us of the ciliated tentacles of the Bryozoa (Chap. XIII.), whilst the body seems to be enclosed in a cylindrical cell, resembling that of Hydrozoa and Bryozoa. A comparison of this with other forms, however, shows that these tentacles are only extensions of the ciliated lobes which are common to all the members of these families; and the so-called 'cell' is not formed by a thickening and separation of the outer tegument; but by a gelatinous secretion from it; so that as the rest of the organization is essentially conformable to the Rotiferous type, no such passage is really established by this animal towards other groups, as it is commonly supposed to form. — In one respect *Floscularia* is still more aberrant; for the long bristly filaments, which its lobes are beset with, are not capable of rhythmical vibration. The true representative of the 'wheels' of other Rotifera is a ciliated band that may be detected around the entrance of the Œsophageal funnel.—The body of *Melicerta* is

protected by a most curious cylindrical tube, composed of little rounded pellets agglutinated together; this is obviously an artificial construction, and Mr. Gosse has been fortunate enough to have an opportunity of watching the animal whilst engaged in building it up. Beneath a projection on its head, which he terms the chin, there is observed a small disk-like organ, in which, when the wheels are at work, a movement is seen very much resembling that of a revolving ventilator. Towards the disk the greater proportion of the solid particles that may be drawn from the surrounding liquid into the vortex of the wheel-organs, are driven by their ciliary movement, a small part only being taken into the alimentary canal; and there they accumulate until the aggregation (probably cemented by a glutinous secretion furnished by the organ itself) acquires the size and form of one of the globular pellets of the case; the time ordinarily required being about three minutes. The head of the animal then bends itself down, the pellet-disk is applied to the edge of the tube, the newly-formed pellet is left attached there, and, the head being lifted into its former position, the formation of a new pellet at once commences.

II. The next of M. Dujardin's primary groups (ranged by him, however, as the third) consists of the ordinary *Rotifer* and its allies, which pass their lives in a state of alternation between the conditions of those attached by a pedicle, of those which habitually swim freely through the water, and of those which creep or crawl over hard surfaces.—As these have already been fully described, it is not requisite to dwell longer upon them.

III. The next group consists of those Rotifers which seldom or never attach themselves by the foot, but habitually swim freely through the water; and putting aside the peculiar aberrant form *Albertia*, which has only been found as a parasite in the intestines of Worms, it may be divided into two families, the *Brachionians* and the *Furcularians*. The former are for the most part distinguished by the short, broad, and flattened form of the body (Figs. 243, 247); which is, moreover, enclosed in a sort of cuirass, formed by the consolidation of the external integument. This cuirass is often very beautifully marked on its surface, and may be prolonged into extensions of various forms, which are sometimes of very considerable length. The latter (corresponding almost exactly with the *Hydatineæ* of Prof. Ehrenberg) derive their name from the bifurcation of the foot into a sort of two-bladed forceps; their bodies are ovoidal or cylindrical, and are enclosed in a flexible integument, which is often seen to wrinkle itself into longitudinal and transverse folds at equidistant lines. To this family belongs the *Hydatina senta*, one of the largest of the Rotifera, which was employed by Prof. Ehrenberg as the chief subject of his examination of the internal structure of this group; as does also the *Asplanchna*, the curious condition of whose male has been already referred-to (§ 360).

IV. The fourth of M. Dujardin's primary orders consists of the very curious tribe, first carefully investigated by M. Doyère, to which the name of *Tardigrada* has been given, on account of the slowness of their creeping movement. Their relation to the true Rotifera, however, is not at all clear ; and many naturalists regard

FIG. 247.

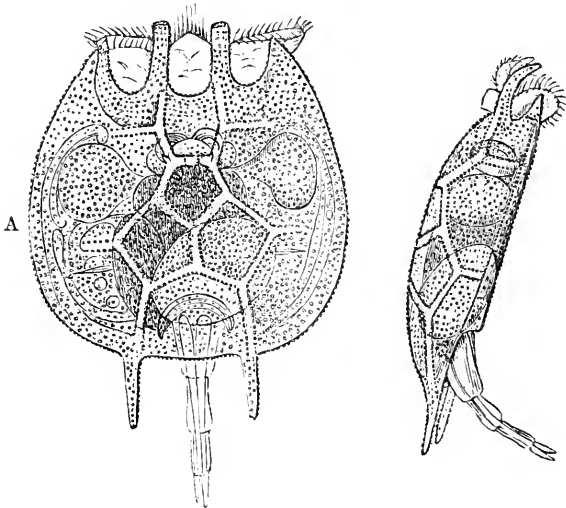

Notozoum quadricornis ; A, dorsal view ; B, side view.

them as altogether distinct. They are found in the same localities with the Rotifers, and, like them, can be revived after desiccation (§ 362) ; but they have a vermiform body, divided transversely into five segments, of which one constitutes the head, whilst each of the others bears a pair of little fleshy protuberances, furnished with four curved hooks, and much resembling the prolegs of a caterpillar. The head is entirely unpossessed of ciliated lobes ; and it is only in the presence of a pair of jaws somewhat resembling those of Rotifera, and in the correspondence of their general grade of organization, that they bear any structural relation to the class we have now been considering. They may be pretty certainly regarded as a connecting link between the Rotifera and the Worms ; but they should probably be ranked on the worm-side of the boundary.

364. Notwithstanding that all the best-informed Zoologists are now agreed in ranking the class of Rotifera in the Articulated series, yet there is still a considerable discordance of opinion as to the precise part of that series in which they should stand. For

whilst Prof. Leydig, who has recently devoted much attention to the study of the class, regards them as most allied to the *Crustacea*, and terms them 'Cilio-crustaceans,' Mr. Huxley, with (as it seems to the Author) a clearer insight into their real nature, has argued that they are more connected with the *Annelida*, through the resemblance which they bear to the early larval forms of that class (§ 489). Considered in this light, the *Tardigrada* might seem to represent a more advanced phase of the same developmental history.*

* The following are the Treatises and Memoirs which (in addition to those already referred-to) contain the most valuable information in regard to the principal forms of Animalcules:—Ehrenberg, "Die Infusionsthierchen," Berlin, 1838; Dujardin, "Histoire Naturelle des Zoophytes Infusoires," Paris, 1841; and Pritchard, "History of Infusoria," 4th Ed., London, 1861 (a comprehensive repertory of information). For the RHIZOPODA and INFUSORIA specially, see Claparède and Lachmann, "Etudes sur les Infusoires et les Rhizopodes," Geneva, 1858-1861; Cohn, in "Siebold and Kölliker's Zeitschrift," 1851-4 and 1857; Leiberkühn, in "Muller's Archiv," 1856, and "Ann. of Nat. Hist.," 2nd Ser., Vol. xviii. 1856; and the elaborate systematic Treatise of Stein, "Der Organismus der Infusionsthier," Leipzig, Erste Abtheilung, 1859, Zweite Abtheilung, 1867. And for the ROTIFERA specially, see Leydig, in "Siebold and Kölliker's Zeitschrift," Bd. vi., 1854; Gosse on *Meliceria ringens*, in "Transact. of Microsc. Soc.," Ser. 1, Vol. iii. 1852), p. 58; and "Quart. Journ. of Microsc. Science," Vol. i., p. 71; Williamson on *Meliceria ringens*, "Quart. Journ. of Microsc. Science," Vol. i. (1853), p. 1; Huxley on *Lacinularia socialis*, in "Transact. of Microsc. Soc.," Ser. 2, Vol. i. (1853), p. 1; and Cohn, in "Siebold and Kölliker's Zeitschrift," Bde. vii. ix., 1856, 1858. Mr. Slack's "Marvels of Pond Life" (London, 1861) contains many interesting observations on the habits of Infusoria and Rotifera.

CHAPTER X.

FORAMINIFERA, POLYCYSTINA, AND SPONGES.

365. RETURNING now to the lowest or *Rhizopod* type of Animal life (§ 326), we have to direct our attention to three very remarkable series of forms, almost exclusively Marine, under which that type manifests itself; all of them distinguished by *Skeletons* of greater or less density, and these skeletons generally so consolidated by Mineral deposit as to retain their form and intimate structure long after the Animals to which they belonged have ceased to live, even for those undefined periods in which they have been imbedded as Fossils in strata of various Geological ages. In the first of these groups, the *Foraminifera*, the Skeleton usually consists of a *Calcareous* many-chambered Shell, which closely invests the Sarcode-body, and which, in a large proportion of the group, is perforated with numerous minute apertures; this shell, however, is sometimes replaced by a 'Test' formed of minute grains of Sand cemented together; and there are a few cases in which the Animal has no other protection than a Membranous envelope.—In the second group, also, the *Polycystina*, there is an investing Shell perforated with apertures; but this shell is *Siliceous*, and has usually but one chamber; and its apertures are often so large and numerous, that the solid portion of the shell forms little more than a network, thus indicating a transition to the succeeding group.—In the group of *Porifera* or *Sponges*, the Skeleton is usually composed of a network of Horny fibres, strengthened either by Calcareous or by Siliceous Spicules, and having the soft Animal substance, which is composed of an aggregate of Amœba-like bodies, in its interstices: in this group, moreover, we have a departure from the *Rhizopod* type, in the fact that certain parts of the free surfaces are furnished with Cilia, whereby currents of water are maintained, that serve both for Nutrition and for Respiration.

366. FORAMINIFERA.—The beings now known under this designation possess, for the most part, *Polythalamous* or 'many-chambered' Shells (Plate xv.), often so strongly resembling those of *Nautilus*, *Spirula*, and other Cephalopod Mollusks, that it is not surprising that the older Naturalists, to whom the structure of

PLATE XV

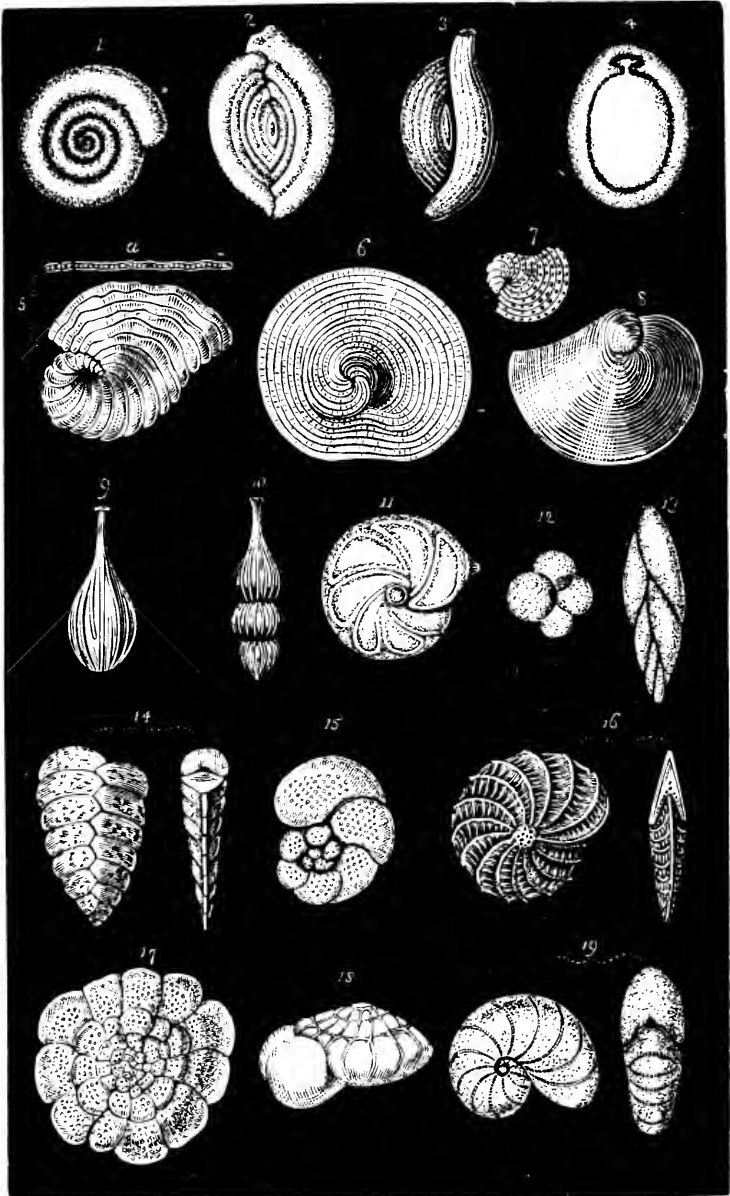

VARIOUS FORMS OF FORAMINIFERA.

[To face p. 485.]

these Animals was entirely unknown, ranked them under that class. As such they were described by M. D'Orbigny (to whom we owe much of our knowledge of this group), in all his earlier publications; and they were distinguished from the ordinary Cephalopods that possess a single Siphon passing from chamber to chamber, by the designation *Foraminifera*, which originally imported that the communications *between the chambers* are commonly made by several such apertures, though it is now more commonly understood as applying to the sieve-like structure often presented by the external shell. It was by M. Dujardin, in 1835, that the structure of these animals was first shown to be conformable to the Rhizopod type; and notwithstanding the opposition to his views which was set-up by Prof. Ehrenberg (who associated them with *Bryozoa*, Chap. XIII.), they have been confirmed by all subsequent observers, and more especially by the researches of Prof. Schultze,* who has given admirable descriptions of the animals of several different kinds of Foraminifera, derived from observation of them during their living state. The essential conformity of the Foraminifera to the ordinary Rhizopod type is best seen in such simple forms as *Lagena* (Plate xv., Fig. 9), in which there is no multiplication of chambers; for these, which are termed *Monothalamous* or 'single-chambered,' hold the same place in the Order *Reticularia*, that *Arcella* and *Difflugia* (Fig. 235) hold in the Order *Lobosa*.

367. By far the greater number of Foraminifera are *composite* fabrics, evolved by a process of continuous gemmation, each bud remaining in connection with the body by which it was put forth; and according to the plan on which this gemmation takes place, will be the configuration of the composite body thereby produced. Thus, if the bud should be put forth from the aperture of *Lagena* in the direction of the axis of its body, and a second shell should be formed around this bud in continuity with the first, and this process should be successively repeated, a straight rod-like shell would be produced (fig. 10), having many chambers communicating with each other by the openings that originally constituted their mouths; the mouth of the last-formed chamber being the only aperture through which the sarcode-body, thus composed of a number of segments connected by a peduncle or 'stolon' of the same material, could now project itself or draw-in its food. The successive segments may be all of the same size, or nearly so, in which case the entire rod will approach the cylindrical form, or will resemble a line of beads; but it often happens that each segment is somewhat larger than the preceding (fig. 11), so that the composite shell has a conical form, the apex of the cone being the original segment, and its base the one last formed. The method of growth now described is common to a large number of Foraminifera,

* "Über den Organismus der Polythalamien (Foraminiferen)," Leipzig, 1854.

chiefly belonging to the genus *Nodosarina*; but even in that genus we have every gradation between the *rectilineal* (fig. 10), and the *spiral* mode of growth (fig. 11); whilst in the genus *Peneroplis* (fig. 5) it is not at all uncommon for Shells which commence in a spiral to exchange this in a more advanced stage for the rectilineal. When the successive segments are added in a spiral direction, the character of the spire will depend in great degree upon the enlargement or non-enlargement of the successively-formed chambers; for sometimes it opens-out very rapidly, every whorl being considerably broader than that which it surrounds, in consequence of the great excess of the size of each segment over that of its predecessor, as in *Peneroplis*; but more commonly there is so little difference between the successive segments, after the spire has made two or three turns, that the breadth of each whorl scarcely exceeds that of its predecessor, as is well seen in the section of the *Rotalia* represented in Fig. 255. An intermediate condition is presented by such a *Rotalia* as is shown in Fig. 248

FIG. 248.

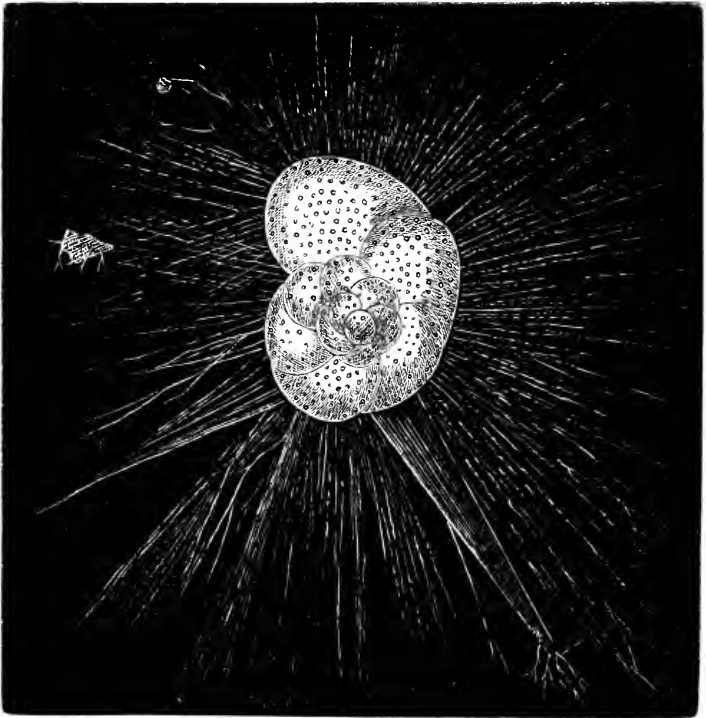
*Rotalia ornata*, with its pseudopodia extended.

which may be taken as a characteristic type of a very large and important group of Foraminifera, whose general features will be presently described. Again, a spiral may be either 'Nautiloid' or 'Turbinoid;' the former designation being applied to that form in which the successive convolutions all lie in one plane (as they do in the *Nautilus*), so that the shell is 'equilateral' or similar on its two sides; whilst the latter is used to mark that form in which the spire passes obliquely round an axis, so that the shell becomes 'inequilateral,' having a more or less conical form, like that of a Snail or a Periwinkle, the first-formed chamber being at the apex. Of the former we have characteristic examples in *Polystomella* (Plate xv., fig. 16) and *Nonionina* (fig. 19); whilst of the latter we find a typical representation in *Rotalia Beccarii* (fig. 18). Further, we find among the shells whose increase takes place upon the Spiral plan, a very marked difference as to the degree in which the earlier convolutions are invested and concealed by the later. In the great *Rotaline* group, whose characteristic form is a Turbinoid spiral, all the convolutions are usually visible, at least on one side (Plate xv., figs. 15, 17, 18); but among the Nautiloid tribes it more frequently happens that the last-formed whorl encloses the preceding to such an extent that they are scarcely, or not at all, visible externally, as is the case in *Cristellaria* (Plate xv., fig. 11), *Polystomella* (fig. 16), and *Nonionina* (fig. 19).—The Turbinoid spire may coil so rapidly round an elongated axis, that the number of chambers in each turn is very small; thus in *Globigerina* (Plate xv., fig. 12) there are usually only four; and in *Valvulina* the regular number is only three. Thus we are led to the *biserial* arrangement of the chambers which is characteristic of the *Textularian* group (Plate xv., fig. 14); in which we find the chambers arranged in two rows, each chamber communicating with that above and that below it on the opposite side, without any direct communication with the chambers of its own side, as will be understood by reference to Fig. 253, A, which shows a 'cast' of the sarcode-body of the animal.—On the other hand, we find in the Nautiloid spire a tendency to pass (by a curious transitional form to be presently described, § 374) into the *Cyclical* mode of growth; in which the original segment, instead of budding forth on one side only, puts forth *gemmæ* all round, so that a ring of small chambers (or chamberlets) is formed around the primordial chamber, and this in its turn surrounds itself after the like fashion with another ring; and by successive repetitions of the same process the Shell comes to have the form of a disk made up of a great number of Concentric Rings, as we see in *Orbitolites* (Fig. 250) and in *Cycloclypeus* (Plate xvi., fig. 1).

368. These and other differences in the *plan of growth* were made by M. D'Orbigny the foundation of his Classification of this group, which, though at one time generally accepted, has now been abandoned by most of those who have occupied themselves

in the study of the Foraminifera. For it has come to be generally admitted that 'plan of growth' is a character of very subordinate importance among the Foraminifera, so that any classification which is primarily based upon it must necessarily be altogether unnatural; those characters being of primary importance which have an immediate and direct relation to the Physiological condition of the Animal, and are thus indicative of the real affinities of the several groups which they serve to distinguish. The most important of these characters will now be noticed.*

369. Two very distinct types of Shell-structure prevail among ordinary Foraminifera,—namely, the *Porcellanous*, and the *Hyaline* or *Vitreous*. In the former, the shell when viewed by reflected light presents an opaque-white aspect which bears a strong resemblance to Porcelain; but when thin natural or artificial laminae of it are viewed by transmitted light, the opacity gives place to a rich brown or amber colour, which in a few instances is tinged with crimson. No structure of any description can be detected in this kind of Shell-substance, which is apparently homogeneous throughout. Although the shells of this 'Porcellanous' type often present the appearance of being perforated with Foramina, yet this appearance is illusory, being due to a mere 'pitting' of the external surface, which, though often very deep, never extends through the whole thickness of the shell. Some kind of inequality of that surface, indeed, is extremely common in the Shells of the porcellanous Foraminifera; one of the most frequent forms of it being a regular alternation of ridges and furrows, such as is occasionally seen in *Miliola* (Plate xv., fig. 3), but which is an almost constant characteristic of *Peneroplis* (fig. 5). But no difference of texture accompanies either this or any other kind of inequality of surface; the raised and depressed portions being alike homogeneous.—In the shells of the *Vitreous* or *Hyaline* type, on the other hand, the proper Shell-substance has an almost glassy transparence, which is shown by it alike in thin natural lamellæ, and in artificially-prepared specimens of such as are thicker and older. It is usually colourless, even when (as is the case with many *Rotalinæ*) the substance of the Animal is deeply coloured; but in certain aberrant *Rotalines* the Shell is commonly, like the animal body, of a rich crimson hue. All the Shells of this type are beset more or less closely with *tubular perforations*, which pass directly, and (in general) without any subdivision, from one surface to the other. These Tubuli are in some instances sufficiently coarse for their orifices to be distin-

* This subject will be found amply discussed in the Author's "Introduction to the study of the Foraminifera," published by the Ray Society; to which work he would refer such of his readers as may desire more detailed information in regard to it. It has been with great satisfaction that he has found his own views on this subject to be in full accordance with those of Prof. Reuss, of Vienna, the highest Continental authority upon this group.

gished as punctations on the surface of the Shell with a low magnifying power, as is shown in Fig. 248; whilst in other cases they are so minute as only to be discernible in thin sections seen by transmitted light under a higher magnifying power, as is shown in Figs. 258, 259. When they are very numerous and closely set, the Shell derives from their presence that kind of opacity which is characteristic of all minutely-tubular textures, when their tubuli are occupied either by air or by any substance having a refractive power different from that of the intertubular substance, however perfect may be the transparence of the latter. The straightness, parallelism, and isolation of these Tubuli are well seen in vertical sections of the thick shells of the largest examples of the group, such as *Nummulina* (Fig. 253). It often happens, however, that certain parts of the Shell are left unchanneled by these tubuli; and such are readily distinguished, even under a low magnifying power, by the readiness with which they allow transmitted light to pass through them, and by the peculiar vitreous lustre they exhibit when light is thrown obliquely on their surface. In Shells formed upon this type, we frequently find that the surface presents either bands or spots which are so distinguished; the non-tubular *bands* usually marking the position of the septa, and being sometimes raised into ridges, though in other instances they are either level or somewhat depressed; whilst the non-tubular *spots* may occur on any part of the surface, and are most commonly raised into tubercles, which sometimes attain a size and number that give a very distinctive aspect to the shells that bear them.

370. Now between the comparatively *coarse* perforations which are common in the *Rotaline* type, and the *minute* tubuli which are characteristic of the *Nummuline*, there is such a continuous gradation as indicates that their mode of formation, and probably their uses, are essentially the same. In the former it has been demonstrated by actual observation that they allow the passage of pseudopodial extensions of the sarcode-body through every part of the external wall of the chambers occupied by it (Fig. 248); and there is nothing to oppose the idea that they answer the same purpose in the latter, since, minute as they are, their diameter is not too small to enable them to be traversed by the finest of the threads into which the branching pseudopodia of Foraminifera are known to subdivide themselves. Moreover, the close approximation of the tubuli in the most finely-perforated Nummulines, makes their collective area fully equal to that of the larger but more scattered pores of the most coarsely-perforated Rotalines. Hence it is obvious that the *tubulation* or *non-tubulation* of Foraminiferous Shells is the key to a very important Physiological difference between the Animal inhabitants of the two kinds respectively; for whilst every segment of the Sarcode-body in the former case gives off Pseudopodia, which pass at once into the surrounding

medium, and contribute by their action to the nutrition of the segment from which they proceed, these Pseudopodia are limited in the latter case to the *final* segment, issuing forth only through the aperture of the last chamber, so that all the nutrient material which they draw-in must be first received into the last segment, and be transmitted thence from one segment to another until it reaches the earliest. With this difference in the Physiological condition of the Animal of these two types, is usually associated a further very important difference in the conformation of the Shell—viz., that whilst the aperture of communication between the chambers, and between the last chamber and the exterior, is usually very small in the Vitreous Shells, serving merely to give passage to a slender *Stolon* or thread of Sarcodæ from which the succeeding segment may be budded-off, it is much wider in the Porcellanous Shells, so as to give passage to a *Stolon* that may not only bud-off new segments, but may serve as the medium for transmitting nutrient material from the outer to the inner chambers. There is no reason to believe, however, that anything like an Alimentary Canal exists among Foraminifera; the nutrition of the entire body being doubtless effected by that interchange and circulation of particles, which (as we have already seen, § 326) is continually going-on throughout its soft Sarcodæ substance in this form of the Rhizopod type.

371. Between the highest types of the *Porcellanous* and the *Vitreous* series respectively, which frequently bear a close resemblance to each other in *form*, there are certain other well-marked differences in *structure*, which clearly indicate their essential dissimilarity. Thus, for example, if we compare *Orbitolites* (Fig. 250) with *Cycloclypeus* (Plate XVI., fig. 1), we recognize the same plan of growth in each, the chamberlets being arranged in concentric rings around the primordial chamber; and to a superficial observer there would appear little difference between them. But a minuter examination shows that not only is the texture of the Shell porcellanous and non-tubular in *Orbitolites*, whilst it is vitreous and minutely-tubular in *Cycloclypeus*; but that the partitions between the chamberlets are *single* in the former, whilst they are *double* in the latter, each segment of the Sarcodæ-body having its own proper shelly investment. Moreover, between these double partitions an additional deposit of Calcareous substance is very commonly found, constituting what may be termed the 'Intermediate' or Supplemental Skeleton; and this is traversed by a peculiar system of inosculating Canals, which pass around the chamberlets in interspaces left between the two laminae of their partitions, and which seem to convey through its substance extensions of the Sarcodæ-body whose segments occupy the chamberlets. We occasionally find this 'Intermediate Skeleton' extending itself into peculiar *outgrowths*, which have no direct relation to the chambered Shell; of this we have a very curious example

in *Calcarina* (Plate XVI., fig. 3); and it is in these that we find the 'Canal-System' attaining its greatest development. Its most regular distribution, however, is seen in *Polystomella* and in *Operculina*; and an account of it will be given in the description of those types.

372. *Miliolida*. — Commencing, now, with the *Porcellanous* series, we shall briefly notice some of its most important forms. Its simplest type is presented by the *Cornuspira* (Plate xv., fig. 1), of our own coasts, found attached to Sea-weeds and Zoophytes; this is a minute spiral Shell, of which the interior forms a continuous tube not divided into chambers; the latter portion of the spire is often very much flattened-out, as in *Peneroplis* (fig. 5), so that the form of the mouth is changed from a circle to a long narrow slit. Among the commonest of all Foraminifera, and abounding near the shores of almost every sea, are some forms of the *Milioline* type, so named from the resemblance of some of their minute fossilized forms (of which enormous beds of Limestone in the neighbourhood of Paris are almost entirely composed) to Millet-seeds. The peculiar mode of growth by which these are characterized will be best understood by examining in the first instance the form which has been designated as *Spiroloculina* (Plate xv., fig. 2). This Shell is a spiral elongated in the direction of one of its diameters, and having in each turn a contraction at either end of that diameter, which partially divides each convolution into two chambers; the separation between the consecutive chambers is made more complete by a peculiar projection from the inner side of the cavity, known as the 'tongue' or 'valve,' which may be considered as an imperfect septum; of this a characteristic example is shown in the upper part of fig. 4. Now it is a very general habit in the *Milioline* type for the chambers of the later convolutions to extend themselves over those of the earlier, so as to conceal them more or less completely; and this they very commonly do somewhat unequally, so that more of the earlier chambers are visible on one side than on the other. *Miliolæ* thus modified (fig. 3) have received the names of *Quinqueloculina* and *Triloculina* according to the number of chambers visible externally; but the extreme inconstancy which is found to mark such distinctions, when the comparison of specimens has been sufficiently extended, entirely destroys their value as differential characters. Sometimes the earlier convolutions are so completely concealed by the later, that only the two chambers of the last turn are visible externally; and in this type, which has been designated *Biloculina*, there is often such an increase in the breadth of the chambers as altogether changes the usual proportions of the Shell, which has almost the shape of an egg when so placed that either the last or the penultimate chamber faces the observer (Plate xv., fig. 4). It is very common in *Milioline* shells for the external surface to present a 'pitting,' more or less deep, a ridge-and-furrow arrangement (fig. 3), or a

honeycomb division ; and these diversities have been used for the characterization of Species. Not only, however, may every intermediate gradation be met-with between the most strongly marked forms, but it is not at all uncommon to find some parts of the surface smooth whilst others are deeply pitted or strongly ribbed or honeycombed ; so that here again the inconstancy of these differences deprives them of all value as distinctive characters.

373. Reverting again to the primitive type presented in the simple Spiral of *Cornuspira*, we find the most complete development of this type in *Peneroplis* (Plate xv., fig. 5), a very beautiful form, which, although very rare on our own coasts, is one of the commonest of all Foraminifera in the shore-sands and shallow-water dredgings of the warmer regions of every part of the globe. This is a Nautiloid Shell, of which the spire flattens itself out as it advances in growth ; it is marked externally by a series of transverse bands, which indicate the position of the internal septa that divide the cavity into chambers ; and these chambers communicate with each other by numerous minute pores traversing each of the septa, and giving passage to threads of sarcodite that connect the segments of the body. At *a* is shown the Septal Plane closing-in the last-formed chamber, with its single row of pores, through which the Pseudopodial filaments extend themselves into the surrounding medium. The surface of the Shell, which has a peculiarly Porcellanous aspect, is marked by closely-set *striae* that cross the spaces between the successive septal bands ; these markings, however, do not indicate internal divisions, and are due to a ridge-and-furrow arrangement of the shelly walls of the chambers. This type passes into two very curious modifications ; one having a Spire which remains turgid like that of a *Nautilus*, instead of flattening itself out, with a single aperture which sends out fissured extensions that subdivide like the branches of a tree, suggesting the name of *Dendritina* which has been given to this variety ; the other having its spire continued in a rectilinear direction so that the shell has the form of a crosier, and being distinguished by the name of *Spirolina*. A careful examination of intermediate forms, however, has made it evident that these modifications, though ranked as of Generic value by M. D'Orbigny, are merely *varietal* ; a continuous gradation being found to exist from the elongated septal plane of *Peneroplis*, with its single row of isolated pores, to the arrow-shaped, oval, or even circular septal plane of *Dendritina*, with all its pores fused together (so to speak) into one dendritic aperture ; and a like gradation being presented between the ordinary and the ' spiroline ' forms, into which both *Peneroplis* and *Dendritina* tend to elongate themselves under conditions not yet fully understood.

374. From the ordinary Nautiloid multilocular spiral, we now pass to a more complex and highly-developed form, which is restricted to tropical regions, but is there very abundant,—that,

namely, which has received the designation *Orbiculina* (Plate xv., figs. 6, 7, 8). The relation of this to the preceding will be best understood by an examination of its early stage of growth, represented in fig. 7 ; for here we see that the Shell resembles that of *Peneroplis* in its general form, but that its principal chambers are divided by Secondary Septa passing at right angles to the primary, into 'chamberlets' occupied by sub-segments of the sarcode-body. Each of these secondary septa is perforated by an aperture, so that a continuous gallery is formed, through which there passes a stolon that unites together all the sub-segments of each row. The Chamberlets of successive rows alternate with one another in position ; and the pores of the principal septa are so disposed, that each chamberlet of any row normally communicates with two chamberlets in each of the adjacent rows. The later turns of the Spire very commonly grow completely over the earlier, and thus the central portion or 'Umbilicus' comes to be protuberant, whilst the growing edge is thin. The Spire also opens-out at its growing margin, which tends to encircle the first-formed portion, and thus gives rise to the peculiar shape represented in fig. 8, which is the common *aduncal* type of this organism. But sometimes, even at an early age, the growing margin extends so far round on each side, that its two extremities meet on the opposite side of the original spire, which is thus completely enclosed by it ; and its subsequent growth is no longer *spiral* but *cyclical*, a succession of *concentric rings* being added, one around the other, as shown in fig. 6. This change is extremely curious, as demonstrating the intimate relationship between the *spiral* and the *cyclical* plans of growth, which at first sight appear essentially distinct. In all but the youngest examples of *Orbiculina*, the septal plane presents more than a single row of pores, the number of rows increasing in the thickest specimens to six or eight. This increase is associated with a change in the form of the sub-segments of sarcode from little blocks to columns, and with a greater complexity in the general arrangement, such as will be more fully described in a subsequent paragraph (§ 379). The largest existing examples of this type are far surpassed in size by those which make up a considerable part of a Tertiary Limestone on the Malabar coast of India, whose diameter reaches 7 or 8 lines.

375. A very curious modification of the same general plan is shown in *Alveolina*, a Genus of which the largest existing forms (Fig. 249) do not attain the size of the smallest sugar-plum, but of which we find specimens in the Tertiary Limestones of Scinde not less than three inches in length and more than an inch in diameter. Here the Spire turns round a very elongated axis, so that the Shell has almost the form of a cylinder drawn to a point at each extremity. Its surface shows a series of longitudinal lines which mark the principal Septa ; and the bands which intervene between these are marked transversely by lines which show the

subdivision of the principal Chambers into Chamberlets. The Chamberlets of each row are connected with each other, as in the preceding type, by a continuous gallery; and they communicate with those of the next row by a series of multiple Pores in the

FIG. 249.

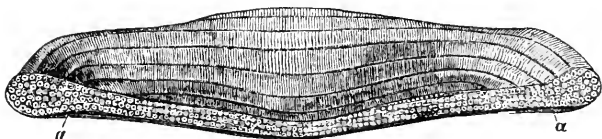

Alveolina Quoiï.—*a, a*, septal plane, showing multiple pores.

principal septa, such as constitute the external orifices of the last-formed series, seen on its Septal Plane at *a, a*.

376. The highest development of that Cyclical plan of growth which we have seen to be sometimes taken-on by *Orbiculina*, is found in *Orbitolites*; a type which, long known as a very abundant fossil in the early Tertiaries of the Paris basin, has lately proved to be scarcely less abundant in certain parts of the existing Ocean, whilst it attained a gigantic development in that very early Geological period known as the Silurian. The largest recent specimens of it, sometimes attaining the size of a sixpence, have hitherto been obtained only from the coast of New Holland and various parts of the Polynesian Archipelago; but disks of comparatively minute size (from the diameter of an ordinary pin's head to that of a small pea) and of simpler organization, are to be found in almost all Foraminiferous sands and dredgings from the shores of the warmer regions of the globe, being especially abundant in those of some of the Philippine Islands, of the Red Sea, of the Mediterranean, and especially of the Ægean. When such Disks are subjected to Microscopic examination, they are found (if uninjured by abrasion) to present the structure represented in Fig. 250; where we see on the surface (by incident light) a number of rounded elevations, arranged in concentric zones around a sort of nucleus (which has been laid-open in the figure to show its internal structure); whilst at the margin we observe a row of rounded projections, with a single aperture or pore in each of the intervening depressions. In very thin Disks, the structure may often be brought into view by mounting them in Canada Balsam and transmitting light through them; but in those which are too opaque to be thus seen-through, it is sufficient to rub-down one of the surfaces upon a stone, and then to mount the specimen in Balsam. Each of the superficial elevations will then be found to be the roof or cover of an ovate cavity or Chamberlet, which communicates by means of a lateral passage with the chamberlet

on either side of it in the same Ring ; so that each circular Zone of chamberlets might be described as a continuous annular passage, dilated into cavities at intervals. On the other hand, each Zone communicates with the zones that are internal and external to it,

Fig. 250.

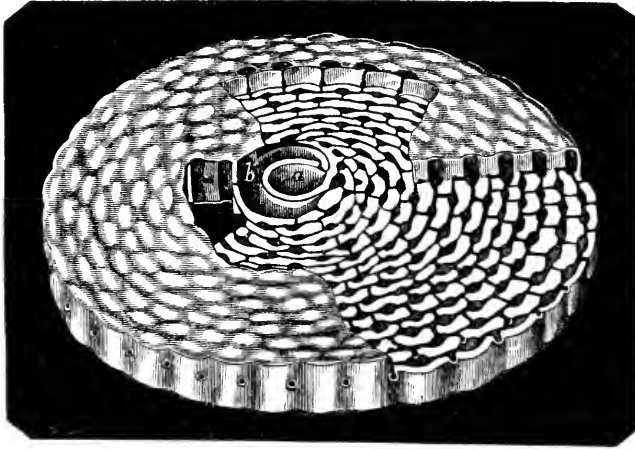

Simple disk of *Orbitolites complanatus*, laid open to show its interior structure:—*a*, central chamber; *b*, circumambient chamber, surrounded by concentric zones of chamberlets, connected with each other by annular and radiating passages.

by means of passages in a radiating direction ; these passages run, however, not from the Chamberlets of the inner zone to those of the outer, but from the connecting Passages of the former to the Chamberlets of the latter ; so that the Chamberlets of each Zone *alternate* in position with those of the zones internal and external to it. The Radial passages from the outermost annulus make their way at once to the margin, where they terminate, forming the 'pores' which (as already mentioned) are to be seen on its exterior. The central Nucleus, when rendered sufficiently transparent by the means just adverted-to, is found to consist of a Primordial Chamber (*a*), usually somewhat pear-shaped, that communicates by a narrow passage with a much larger Circumambient Chamber (*b*), which nearly surrounds it, and which sends-off a variable number of radiating passages towards the Chamberlets of the first Zone, which forms a complete ring around the circumambient chamber.*

* Although the above may be considered the *typical* form of the Orbitolite, yet, in a very large proportion of specimens, the first few Zones are not complete circles, the early growth having taken-place rather in a

377. The idea of the nature of the living occupant of these cavities which might be suggested by the foregoing account of their arrangement, is fully borne-out by the results of the examination of the Sarcode-Body that may be obtained by the maceration in dilute acid (so as to remove the shelly investment) of specimens of *Orbitolite*, which have been gathered fresh from the Sea-weeds to which in the living state they are found adherent, and have been kept in Spirit. For this body is found to be composed (Fig. 251) of a multitude of Segments of 'Sarcode,' presenting not

FIG. 251.

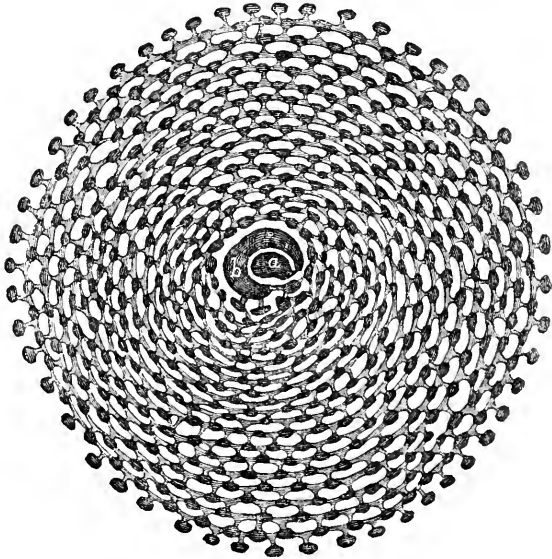

Composite Animal of simple type of *Orbitolites complanatus*:—
a, central mass of sarcode; *b*, circumambient mass, giving off peduncles, in which originate the concentric zones of sub-segments connected by annular bands.

the least trace of higher organization in any part, and connected together by Stolons of the like substance. The Primordial pear-shaped Segment, *a*, is seen to have budded-off its Circumambient Segment, *b*, by a narrow footstalk or Stolon; and this circumambient segment, after passing almost entirely round the central one, has

spiral than in a *radial* direction; between these two plans, there is every variety of gradation; and even where the Spiral is most distinctly marked in the first instance, the additions soon come to be made in *Concentric Zones*.

budded-off three Stolons, which swell into new Sub-segments from which the first Ring is formed. Scarcely any two specimens are precisely alike as to the mode in which the first Ring originates from the Circumambient Segment; for sometimes a score or more of radial passages extend themselves from every part of the margin of the latter (and this, as corresponding with the plan of growth afterwards followed, is probably the *typical* arrangement); whilst in other cases (as in the example before us) the number of these primary offsets is extremely small. Each Zone is seen to consist of an assemblage of ovate Sub-segments, whose height (which could not be shown in the figure) corresponds with the thickness of the disk; these Sub-segments, which are all exactly similar and equal to one another, are connected by annular Stolons; and each Zone is connected with that on its exterior by Radial extensions of those stolons passing-off between the sub-segments.

378. Although no opportunity has yet been obtained for a microscopic examination of these animals in their living state, yet there can be no reasonable doubt that the Radial extensions of the outermost zone issue-forth as Pseudopodia from the marginal pores, and that they search-for and draw-in alimentary materials in the same manner as do those of other Foraminifera; the whole of the soft body, which has no communication whatever with the exterior, save through these marginal pores, being nourished by the transmission of the products of digestion from zone to zone, through similar bands of protoplasmic substance. In all cases in which the growth of the Disk takes-place with normal regularity, it is probable that a complete circular zone is added at once. When the Sarcod-body has increased beyond the capacity of its enveloping disk, it may be presumed that its Pseudopodial extensions, proceeding from the marginal pores, coalesce, so as to form a complete annulus of Sarcod round the margin of the outermost zone; and it is probable that it is by a deposit of Calcareous matter in the surface-portion of this annulus, that the new Zone of Shell-substance is formed, which constitutes the walls of the cells and passages occupied by the soft Sarcod-body. Thus we find this simple type of organization giving origin to fabrics of by no means microscopic dimensions, in which, however, there is no other differentiation of parts than that concerned in the formation of the Shell; every segment and every stolon (with the exception of the two forming the 'Nucleus') being, so far as can be ascertained, a precise repetition of every other, and the segments of the Nucleus differing from the rest in nothing else than their form. The equality of the endowments of the Segments is shown by the fact, of which accident has repeatedly furnished proof,—that a small portion of a Disk, entirely separated from the remainder, will not only continue to live, but will so increase as to form a new disk; the want of the Nucleus not appearing to be of the slightest consequence, from the time that active life is established in the outer

zones. In what manner the multiplication and reproduction of the species are accomplished, we can as yet do little more than guess ; but from appearances sometimes presented by the Sarcod-body, it seems reasonable to infer that *Gemmules*, corresponding with the Zoospores of Protophytes (§ 241), are occasionally formed by the breaking-up of the Sarcod into globular masses ; and that these, escaping through the marginal pores, are sent forth to develop themselves into new fabrics. Of the mode wherein that Sexual operation is performed, however, in which alone true Generation consists, nothing whatever is known.

379. One of the most curious features in the history of this Animal, is its capacity for developing itself into a form which, whilst fundamentally the same as that previously described, is very much more complex. In all the larger specimens of *Orbitolites* we observe that the Marginal Pores, instead of constituting but a single row, form many rows one above another ; and besides this, the Chamberlets of the two surfaces, instead of being rounded or ovate in form, are usually oblong and straight-sided, their long diameters lying in a radial direction, like those of the cyclical type

FIG. 252.

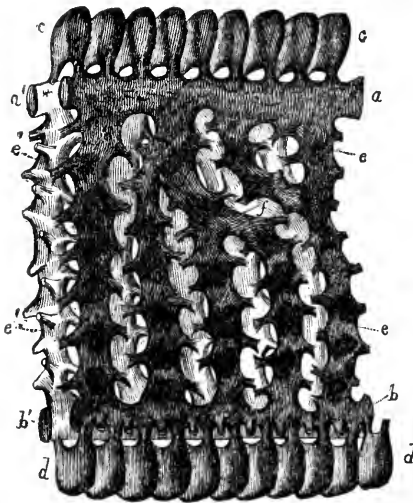

Portion of Composite Animal of Complex Type of *Orbitolites complanatus*:—*a a'*, *b b'*, the upper and lower Rings of two Concentric Zones ; *c c*, the upper layer of superficial Sub-segments, and *d d*, the lower layer, connected with the Annular bands of both Zones ; *e e* and *e' e'*, vertical Sub-segments of the two Zones.

of *Orbiculina* (Plate xv., fig. 6). When a vertical section is made through such a Disk, it is found that these oblong Chambers constitute two superficial layers, between which are interposed columnar chambers of a rounded form ; and these last are connected together by a complex series of passages, the arrangement of which will be best understood from the examination of a part of the Sarcod-body that occupies them (Fig. 252). For the oblong superficial chambers are occupied by Sub-segments of Sarcod, *c c*, *d d*, lying side by side, so as to form part of an annulus, but

each of them being disconnected from its neighbours, and communicating only by a double footstalk with the two Annular Stolons, *a a'*, *b b'*, which obviously correspond with the single stolon of the Simple type (Fig. 251). These indirectly connect together not merely all the superficial Chamberlets of each zone, but also the columnar Sub-segments of the intermediate layer; for these Columns (*e e*, *e' e'*) terminate above and below in the Annular Stolons, sometimes passing directly from one to the other, but sometimes going out of the direct course to coalesce with another column. The Columns of the successive Zones (two sets of which are shown in the figure) communicate with each other by threads of Sarcodæ, in such a manner that (as in the Simple type) each column is thus brought into connection with two columns of the Zone next interior, to which it alternates in position. Similar threads, passing off from the outermost zone, through the multiple ranges of Marginal Pores, would doubtless act as Pseudopodia.—Now this plan of growth is so different from that previously described, that there would at first seem ample ground for separating the *Simple* and the *Complex* types as distinct Species. But the test furnished by the examination of a *large number of specimens*, which ought never to be passed by when it can possibly be appealed to, furnishes these very singular results:—1st. That the two forms must be considered as Specifically identical; since there is not only a gradational passage from one to the other, but they are often combined in the same individual, the *inner* and first-formed portion of a large Disk frequently presenting the Simple type, whilst the *outer* and later-formed part has developed itself upon the Complex:—2nd. That although the last-mentioned circumstance would naturally suggest that the change from the one plan to another may be simply a feature of advancing Age, yet this cannot be the case; since the Complex sometimes evolves itself even from the very first (the Nucleus, though resembling that of the simple form, sending out two or more tiers of radiating threads), whilst, more frequently, the Simple prevails for an indefinite number of Zones, and then changes itself in the course of a few zones into the Complex. A more striking instance could scarcely be drawn from any department of Natural History, of the wide *Range of Variation* that may occur within the limits of one and the same Species; and the Microscopist needs to be specially put on his guard as to this point, in respect to the lower types of Animal as to those of Vegetable life, since the determination of form seems to be far less precise among such, than it is in the higher types.*

* For a fuller account of the Organization of *Orbitolites*, and of the various conditions under which it presents itself, see the Author's Memoir upon that Genus in the "Philosophical Transactions," 1856, and his "Introduction to the Study of the Foraminifera," published by the Ray Society, 1862.

380. It is not a little singular that a peculiar Fossil, to which the name *Receptaculites* has been given, and which has been supposed by some to be a *Sponge* and by others to be a *Coral*, should prove to be a gigantic *Orbitolites*. Specimens of this fossil have been found in the Silurian Limestones of Canada, of which the diameter must have been 12 or 14 inches, and their thickness half an inch; yet, notwithstanding this enormous excess in size, the *internal casts*, produced by infiltration of their chambers with Siliceous minerals (§ 390), correspond so precisely in the form and arrangement of their parts with the Sarcode-body of the recent *Orbitolites*, as described in the last paragraph, that no reasonable doubt can be entertained as to the essential similarity of these two types.*—It is highly probable that several other problematical Fossils of the earlier Geological Epochs (such as the *Stromatopora* of the Silurian and Devonian formations), will be shown by Microscopic examination to have a Foraminiferal character. The determination by this means of the Foraminiferal structure of *Eozoon Canadense* (§ 397),—a Fossil occurring in Rocks so much more ancient, that the existence of Animal life at the period of their formation was previously almost universally disbelieved-in,—may be considered one of the most important contributions which Microscopy has made to Geological Science.

381. *Lituolida*.—In certain forms of the preceding family, and especially in the genus *Miliola*, we not unfrequently find the Shells encrusted with particles of Sand, which are imbedded in the proper shell-substance. This incrustation, however, must be looked on as (so to speak) accidental; since we find Shells that are in every other respect of the same type, altogether free from it. A similar accidental incrustation presents itself among certain Vitreous and tubular Shells (§ 385); but here, too, there is a basis of true Shell, and the Sandy incrustation is often entirely absent. There is, however, a group of Foraminifera in which the true Shell is constantly and entirely *replaced* by a Sandy envelope; the Arenaceous particles not being imbedded in a shelly cement, but being held together only by an organic glue. If the sand be Siliceous, the 'test' of course has that composition; and this envelope often bears such a resemblance to a true *shell* exuded from the animal, as to have been mistaken for it by some excellent observers.† It is not a little curious that the forms of these Arenaceous 'tests' should represent those of many different types among both the Porcellanous and the Vitreous series; whilst yet they graduate into one another in such a manner as to indicate that all the members of this Arenaceous group are closely related to each other, so as to

* See Mr. Salter's Memoir on the Genus *Receptaculites* in the First Decade of "Figures and Descriptions of Canadian Organic Remains," Montreal, 1859.

† It is the conviction of the Author, as of his friends Messrs. Parker and Rupert Jones, that there is not really any true *siliceous shell* (analogous to that of *Polycystina*) in the entire group of Foraminifera.

form a series of their own. The genus *Trochammina* in its simplest form represents the undivided spiral *Cornuspira* among the Porcellanous, and *Spirillina* among the Vitreous Foraminifera; but besides presenting a number of other curious varieties of form, it exhibits in some instances such a tendency to the subdivision of its tube into chambers, as to approach the lower and less regular forms of the *Rotaline* series in its plan of growth. The 'test' of *Trochammina* is very fine in its texture, the cemented particles being very minute. That of *Lituola*, on the other hand, is very coarse, especially in those large fossil specimens which are very common in the Chalk. The typical shape of this genus, from which it derives its name, very much resembles that of the 'spiroline' *Peneroplis* (§ 373), being a nautiloid spiral partly unrolled; but its lower forms are often very irregular, growing adherent to Shells, Corals, Stones, &c., and losing all definiteness of plan, not unfrequently even branching and spreading themselves out in different directions. On the other hand, *Lituola* sometimes presents itself as a simple Nautiloid spiral, so exactly resembling *Nonionina* (Plate xv., fig. 19) as to have been mistaken for it, though at once to be distinguished by the nature of its 'test.' In the largest and most developed Fossil forms, especially those having a 'spiroline' mode of growth, the chambers are irregularly subdivided into 'chamberlets' by secondary septa, which, like the principal septa, are formed of the same material as the external walls of the 'test,' namely, particles of Calcareous or Siliceous sand, cemented together by a sort of mortar composed of finer particles united by an Organic exudation. Still more remarkable Arenaceous 'tests' of gigantic size have been lately discovered; some of them resembling *Alveoline* in plan of growth, whilst others are Spheres made up of concentric layers. The Physiological relationship of the foregoing is obviously to the Porcellanous Foraminifera; since, as the walls of the 'test' are not perforated for the passage of Pseudopodia, the Sarcodibody enclosed in them has no other communication with the exterior than through the aperture of the last segment. There is, however, another Arenaceous genus, *Valvulina*, in which the test has a true shelly basis, perforated with distinct pores, and therefore leading us towards the Vitreous series. The characteristic form of this Genus resembles that of *Textularia* (Plate xv., fig. 14), except that the chambers are piled one on another in *three* series (so as to form a kind of pyramid having the primordial chamber at its apex) instead of in *two*; the aperture, however, is furnished with a valve-like flap or tongue, somewhat resembling that of *Miliola* (Plate xv., fig. 4). But this form is subject to a great variety of modifications; the chambers, for example, being sometimes arranged in a Bulimine spiral, whilst sometimes they are attached end to end, so as to constitute but a single straight series, thus giving a 'clavuline' or nail-like form to the shell.

382. *Lagenida*.—Passing-on, now, to the Vitreous series of Foraminifera, we revert in the first instance to those simple *Monothalamous* or Single-chambered shells, some of which repeat in a very curious manner the lowest forms already described. Thus *Spirillina* has a minute, spirally-convoluted, undivided tube, resembling that of *Cornuspira* (Plate xv., fig. 1), but having its wall somewhat coarsely perforated by numerous apertures for the emission of Pseudopodia. So in *Lagena* we seem to have the representative of *Gromia*; not only, however, is the membranous 'test' of the latter replaced by a minutely-porous Shell, but its wide mouth is narrowed and prolonged into a tubular neck (fig. 9), giving to the shell the form of a microscopic flask; this neck terminates in an everted lip, which is marked with radiating furrows. A mouth of this kind is a distinctive character of a large group of *Polythalamous* shells, of which each single chamber bears a more or less close resemblance to the simple *Lagena*, and of which, like it, the external surface generally presents some kind of ornamentation, which may have the form either of longitudinal ribs or of pointed tubercles. Thus the shell of *Nodosaria* (fig. 10) is obviously made up of a succession of Lageniform chambers, the neck of each being received into the cavity of that which succeeds it; whilst in *Cristellaria* (fig. 11) we have a similar succession of chambers, presenting the characteristic radiate aperture, and often longitudinally ribbed, disposed in a Nautiloid spiral. Between *Nodosaria* and *Cristellaria*, moreover, there is such a gradational series of connecting forms as shows that no essential difference exists between these two types, which must be combined into one genus *Nodosarina*; and it is a fact of no little interest that these varietal forms, of which many are to be met with on our own shores, but which are more abundant on those of the Mediterranean, and especially of the Adriatic, can be traced backwards in Geological time even as far as the New Red Sandstone period. In another Genus, *Polymorphina*, we find the shell to be made up of Lageniform chambers arranged in a double series, alternating with each other on the two sides of a rectilinear axis (fig. 13); here again, the forms of the individual chambers, and the mode in which they are set one upon another, vary in such a manner as to give rise to very marked differences in the general configuration of the shell, which are indicated by the name it bears.

—All those Foraminifera, whether Simple or Composite, whose Shells are made up of Lageniform chambers, may be very naturally associated under one Family *Lagenida*; notwithstanding that they were distributed by D'Orbigny (according to the differences of their plans of growth) under four different Orders.

383. *Globigerinida*.—Returning once again to the simple *Monothalamous* condition, we have in *Orbulina*—a minute spherical shell that presents itself in greater or less abundance in Deep Sea dredgings from almost every region of the globe—a globular

chamber with porous walls, and a simple circular aperture that is frequently replaced by a number of large pores scattered throughout the wall of the sphere. There is some reason to think that *Orbulina* is really nothing else than the detached Reproductive segment of *Globigerina* ; which consists of an assemblage of such chambers (Fig. 12), coherent externally into a more or less regular Turbinoid spire, but all of them opening separately into a common 'vestibule' which occupies the centre of the under side of the spire. This Genus has recently attracted great attention, from the extraordinary abundance in which it seems to occur at great depths over large areas of the Ocean-bottom. Thus its minute Shells have been found to constitute no less than 97 per cent. of the 'ooze' brought up in the scoop attached to the deep-sea Sounding apparatus, from depths of from 1,260 to 2,000 fathoms in the middle and northern parts of the Atlantic Ocean, where the presence of this type in such quantities seems to follow the course of the Gulf-stream. The surface-layer of this ooze consists of living *Globigerinæ* ; whilst its deeper layers are almost entirely composed of dead shells of the same type. And it is probable that these *Globigerinæ* form an important article of sustenance to the forms of Star-fish which have been brought up alive from the same ocean-depths.

384. A very remarkable type has recently been discovered adherent to Shells and Corals brought from tropical seas, to which the name *Carpenteria* has been given ; this may be regarded as a highly developed form of *Globigerina*, its first-formed portion having all the essential characters of that genus. It grows attached by the apex of its spire to Shells, Corals, &c. ; and its later chambers increase rapidly in size, and are piled on the earlier in such a manner as to form a depressed cone with an irregular spreading base. The essential character of *Globigerina*—the separate orifice of each of its chambers—is here retained with a curious modification ; for the central Vestibule, into which they all open, forms a sort of Vent whose orifice is at the apex of the cone, and is sometimes prolonged into a tube that proceeds from it ; and the external wall of this cone is so marked out by septal bands, that it comes to bear a strong resemblance to a minute *Balanus* (acorn-shell) for which this type was at first mistaken. The principal Chambers are partly divided into Chamberlets by incomplete partitions ; and the whole assemblage of cavities is occupied in the living state by a Spongy substance beset with Siliceous spicules.*

385. A less aberrant modification of the *Globigerine* type, however, is presented in the two great series which may be designated

* A detailed account of this very curious Organism, which seems to constitute a connecting link between Sponges and Foraminifera, will be found in the Author's Memoir in the "Philosophical Transactions" for 1860, and in his "Introduction to the Study of the Foraminifera," published by the Ray Society.

(after the leading forms of each) as the *Textularian* and the *Rotalian*. For notwithstanding the marked difference in their respective plans of growth, the characters of the individual chambers are the same ; their walls being coarsely-porous, and their apertures being oval, semi-oval, or crescent-shaped, sometimes merely fissured. In *Textularia* (Plate xv., fig. 14) the chambers are arranged biserially along a straight axis, the position of those on the two sides of it being alternate, and each chamber opening into those above and below it on the opposite side by a narrow fissure ; as is well shown in such 'internal casts' (Fig. 253, A) as exhibit the forms and connections of the segments of Sarcode by which the chambers are occupied during life. In the

FIG. 253.

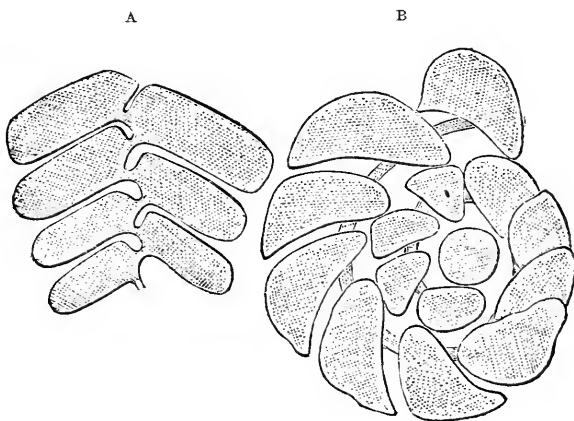

Internal siliceous casts, representing the forms of the segments of the animals of A, *Textularia*, B, *Rotalia*.

genus *Bulimina* the chambers are so arranged as to form a spire like that of a *Bulimus*, and the aperture is a curved fissure whose direction is nearly transverse to that of the fissure of *Textularia* ; but in this, as in the preceding type, there is an extraordinary variety in the disposition of the chambers. In both, moreover, the Shell is often covered by a sandy incrustation, so that its perforations are completely hidden, and can only be made visible by the removal of the adherent crust.

386. In the *Rotalian* series, the chambers are disposed in a Turbinoid spire, opening one into another by an aperture situated on the lower and inner side of the spire, as shown in Plate xv., fig. 18 ; the forms and connections of the segments of their Sarcode-bodies being shown in such 'internal casts' as are represented in Fig. 253, B.

One of the lowest and simplest forms of this type is that very common one now distinguished as *Discorbina*, of which a characteristic example is represented in Plate xv., fig. 15. The early form of *Planorbulina* is a Rotaline spire, very much resembling that of *Discorbina*; but this afterwards gives place to a cyclical plan of growth (fig. 17); and in those most developed forms of this type which occur in warmer seas, the earlier chambers are completely overgrown by the latter, which are often piled-up in an irregular 'acervuline' manner, spreading over the surfaces of Shells, or clustering round the stems of Zoophytes. In the genus *Tinoporus* there is a more regular growth of this kind, the chambers being piled successively on the two sides of the original median plane, and those of adjacent piles communicating with each other obliquely (like those of *Textularia*) by large apertures, whilst they communicate with those directly above and below by the ordinary pores of the shell. The simple or smooth form of this Genus presents great diversities of shape, with

great constancy in its internal structure; being sometimes spherical, sometimes resembling a minute sugar-loaf, and sometimes being irregularly flattened-out. A peculiar form of this type (Fig. 254), in which the walls of the piles are thickened at their meeting-angles into solid columns that appear on the surface as tubercles, and are sometimes prolonged into spinous outgrowths that radiate from the central mass, is of very common occurrence in Shore-sands and shallow water Dredgings on some parts of the Australian coast and among the Polynesian islands.—To the simple form of this Genus we are probably to refer a large part of the Fossils of the early Tertiary period that have been described under the name *Orbitolina*, some of which attain a very large size. Globular *Orbitolinæ*, which appear to have been artificially perforated and strung as beads, are not unfrequently found associated with the "Flint-implements" of Gravel-beds. Others of these appear to belong to a type of which we have now but very feeble and insignificant representatives, namely, *Patellina*, a minute shell occasionally found on our own coasts, but more common on those of Australia, the form of which is a limpet-shaped cone, more or less depressed. This seems to commence as

FIG. 254.

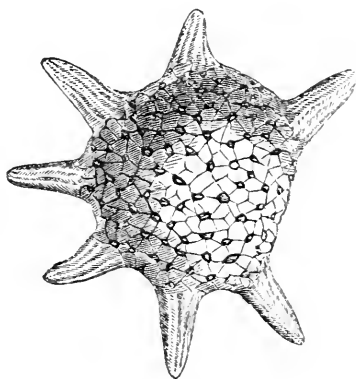
Tinoporus baculatus.

a Rotaline spire, but soon undergoes a change from the Spiral to the Cyclical mode of increase; the rings being divided into Chamberlets, which are again partially subdivided, and the hollow of the cone being more or less completely filled up by a secondary chamber-growth.* Another very curious modification of the Rotaline type is presented by *Polytrema*, which so much resembles a Zoophyte as to have been taken for a minute Millepore; but which is made up of an aggregation of Globigerine chambers communicating with each other like those of *Tinoporus*, and differs from that genus in nothing else than its erect and usually branching manner of growth, and the freer communications between its chambers.

387. In *Rotalia*, properly so called, we find a marked advance

FIG. 255.

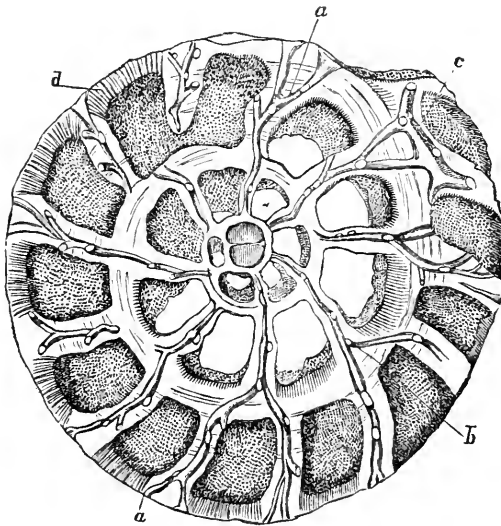

Section of *Rotalia Schroetteriana* near its base and parallel to it:—showing, *a a*, the radiating interseptal canals; *b*, their internal bifurcations; *c*, a transverse branch; *d*, tubular wall of the chambers.

towards the highest type of Foraminiferal structure; the partitions that divide the chambers being composed of two laminae, and spaces being left between them which give passage to a system of canals whose general distribution is shown in Fig. 255. The proper walls of the chambers, moreover, are thickened by an extraneous deposit, or 'intermediate skeleton,' which sometimes forms radiating outgrowths; but

this peculiarity of conformation is carried much further in the Genus which has been designated *Calcarina* from its resemblance

* This curious type was first described by Prof. Williamson in his "Recent Foraminifera of Great Britain," published by the Ray Society, 1858; and to it are probably to be referred the fossils (1861, p. 309) described by Mr. Carter ("Ann. of Nat. Hist.," 3rd Ser., Vol. viii.) under the names *Conulites* and *Orbitolina*.

to a Spur-rowel (Plate XVI., fig. 3). The solid club-shaped appendages with which this shell is provided, entirely belong to the 'Intermediate Skeleton' *b*, which is quite independent of the chambered structure *a*; and this is nourished by a set of Canals containing prolongations of the Sarcod-body, which not only furrow the surface of these appendages, but are seen to traverse their interior when this is laid open by section, as shown at *c*. In no other recent Foraminifer does the Canal-system attain a like development; and its distribution in this minute Shell, which has been made out by careful microscopic study, affords a valuable clue to its meaning in the comparatively gigantic Fossil organism to be presently described under the designation *Eozoon Canadense* (§ 397). The resemblance which *Calcarina* bears to the radiate forms of *Tinoporus* (Fig. 254) which are often found with them in the same Dredgings, is frequently extremely striking; and in their early growth the two can scarcely be distinguished, since both commence in a Rotaline spire with radiating appendages; but whilst the successive chambers of *Calcarina* continue to be added on the same plan, those of *Tinoporus* are heaped-up in less regular piles.

388. Certain beds of Carboniferous Limestone in Russia are entirely made-up, like the more modern Nummulitic Limestone (§ 392), of an aggregation of the remains of a peculiar type of Foraminifera, to which the name *Fusulina* (indicative of its fusi-form or spindle shape) has been given. In general aspect and plan of growth it so much resembles *Alveolina*, that its relationship to that type would scarcely be questioned by the superficial observer. But when its mouth is examined, it is found to consist of a single slit in the middle of the lip; and the interior, instead of being minutely divided into chamberlets, is found to consist of a regular series of simple chambers; while from each of these proceeds a pair of elongated extensions, which correspond to the 'alar prolongations' of other spirally-growing Foraminifera (§ 391), but which, instead of wrapping round the preceding whorls, are prolonged in the direction of the axis of the spire, those of each whorl projecting beyond those of the preceding, so that the shell is elongated with every increase in its diameter. Thus it appears that in general plan of growth *Fusulina* bears much the same relation to a symmetrical Rotaline or Nummuline shell, that *Alveolina* bears to *Orbiculina*; and this view of its affinities is fully confirmed by the Author's microscopic examination of the structure of its shell. For although the *Fusulina*-limestone of Russia has undergone a degree of metamorphism, which so far obscures this character that he could not speak confidently of the shells of which it is composed, yet the appearances he could distinguish were decidedly in its favour. And having since received specimens from the Upper Coal Measures of Iowa, U.S., which are in a much more perfect state of preservation, he is able to state with

certainty, not only that *Fusulina* is tubular, but that its tubulation is of the large coarse nature that marks its affinity rather to the *Rotaline* than to the *Nummuline* series.—This type is of peculiar interest as having long been regarded as the oldest form of Foraminifera, which was known to have occurred in sufficient abundance to form Rocks by the aggregation of its individuals. It will be presently shown, however, that in point both of antiquity and of importance, it is far surpassed by another (§ 397).

389. *Nummulinida*.—All the most elaborately constructed, and the greater part of the largest, of the Vitreous Foraminifera belong to the group of which the well-known *Nummulite* may be taken as the representative. Various plans of growth prevail in this Family; but its distinguishing characters consist in the completeness of the wall that surrounds each segment of the body (the septa being double instead of single as elsewhere), the density and fine porosity of the Shell-substance, and the presence of an Intermediate Skeleton, with a Canal-system for its nutrition. It is true that these characters are also exhibited in the highest of the Rotaline series (§ 387), whilst they are deficient in the genus *Amphistegina*, which connects the Nummuline series with the Rotaline; but the occurrence of such modifications in their border-forms is common to other truly Natural groups. With the exception of *Amphistegina*, all the Genera of this family are symmetrical in form; the spire being Nautiloid in such as follow that plan of growth, whilst in those which follow the Cyclical plan there is a constant equality on the two sides of the median plane: but in *Amphistegina* there is a reversion to the Rotalian type in the Turbinoid form of its spire, as in the characters already specified, whilst its general conformity to the Nummuline type is such as to leave no reasonable doubt as to its title to be placed in this family. Notwithstanding the want of symmetry of its spire, it accords with *Operculina* and *Nummulina* in having its chambers extended by 'alar prolongations' over each surface of the previous whorl; but on the under side these prolongations are almost entirely cut off from the principal chambers, and are so displaced as apparently to alternate with them in position; so that M. D'Orbigny, supposing them to constitute a distinct series of chambers, described its plan of growth as a biserial spiral, and made this the character of a separate Order.*

390. The existing *Nummulinida* are almost entirely restricted to tropical climates; but a beautiful little form, the *Polystomella crispa* (Plate xv., fig. 16), the representative of a Genus that presents the most regular and complete development of the Canal system anywhere to be met with, is common on our own coasts.

* For an account of this curious modification of the Nummuline plan of growth, the real nature of which was first elucidated by Messrs. Parker and Rupert Jones, see the Author's "Introduction to the Study of the Foraminifera" (Ray Society).

The peculiar surface-marking shown in the figure consists in a strongly marked ridge-and-furrow plication of the Shelly wall of each segment along its posterior margin; the furrows being sometimes so deep as to resemble fissures opening into the cavity of the chamber beneath. No such openings, however, exist; the only communication which the Sarcode-body of any segment has with the exterior being either through the fine tubuli of its shelly walls, or through the row of pores that are seen in front view along the inner margin of the septal plane, collectively representing a fissured aperture divided by minute bridges of shell. The meaning of the plication of the shelly wall comes to be understood when we examine the conformation of the segments of the sarcode body, which may be seen in the common *Polystomella crispa* by dissolving-away the shell of fresh specimens by the action of dilute acid, but which may be better studied in such internal casts (Fig. 256) of the Sarcode-body and Canal-system of the large *P. craticulata* of the Australian coast, as may sometimes be obtained by the same means from dead shells which have undergone infiltration with Ferruginous Silicates.* Here we see that the Segments of the Sarcode-body are smooth along their anterior edge b, b^1 , but that along their posterior edge, a , they are prolonged backwards into a set of 'retral processes;' and these processes lie under the ridges of the shell, whilst the shelly wall dips down into the spaces between them, so as to form the furrows seen on the surface. The connections of the segments by Stolons c, c^1 , passing through the pores at the inner margin of each septum, are also admirably displayed in such 'casts.' But what they serve most beautifully to demonstrate is the Canal-system, of which the distribution is here most remarkably complete and symmetrical. At d, d^1, d^2 , are seen three turns of a Spiral canal which passes along one end of all the segments of the like number of convolutions, whilst a corresponding canal is found on the side which in the figure is undermost; these two spires are connected by a set of Meridional canals, e, e^1, e^2 , which pass down between the two layers of the septa that divide the segments; whilst from each of these there passes-off towards the surface a set of pairs of Diverging Branches, f, f^1, f^2 , which open upon the surface along the two sides of each septal band,

* It was by Prof. Ehrenberg that the existence of such 'Casts' in the Green Sands of various Geological periods (from the Silurian to the Tertiary) was first pointed out, in his Memoir 'Ueber der Grünsand und seine Einläuterung des organischen Lebens,' in "Abhandlungen der Königl. Akad. der Wissenschaften," Berlin, 1855. It was soon afterwards shown by the late Prof. Bailey ("Quart. Journ. of Microsc. Science," Vol. v. 1857. p. 83) that the like infiltration occasionally takes place in recent Foraminifera, enabling similar 'Casts' to be obtained from them by the solution of their Shells in dilute acid. And, acting upon this hint, Messrs. Parker and Rupert Jones succeeded in obtaining from what had been put aside as the refuse of Mr. Jukes's Australian dredgings, a number of Casts of *Polystomella*, *Alveolina*, *Amphistegina*, and other types, of most wonderful completeness.

the external openings of those on its anterior margin being in the furrows between the retral processes of the next segment. These Canals appear to be occupied in the living state by prolongations of the Sarcod-body ; and the Diverging branches of those of each

FIG. 256.

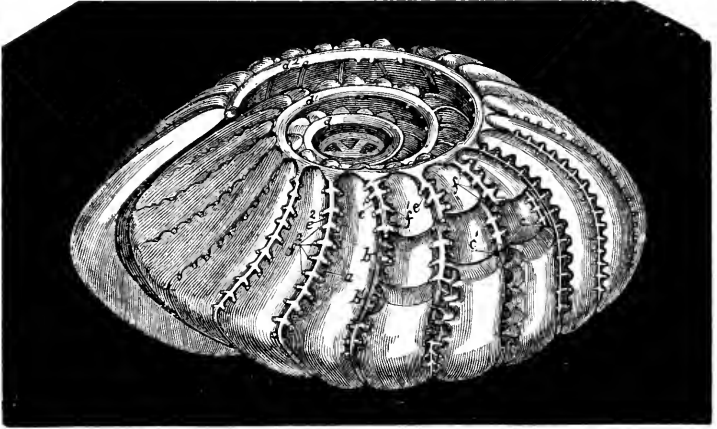

Internal cast of *Polystomella craticulata* :—*a*, retral processes, proceeding from the posterior margin of one of the segments ; *b*, *b*¹, smooth anterior margin of the same segment ; *c*, *c*¹, stolons connecting successive segments, and uniting themselves with the diverging branches of the meridional canals ; *d*, *d*¹, *d*², three turns of one of the Spiral canals ; *e*, *e*¹, *e*², three of the Meridional canals ; *f*, *f*¹, *f*², their Diverging branches.

convolution unite themselves, when this is enclosed by another convolution, with the stolon-processes connecting the successive segments of the latter, as seen at *c*¹. There can be little doubt that this remarkable development of the Canal-system has reference to the unusual amount of Shell-substance which is deposited as an 'intermediate skeleton' upon the layer that forms the proper walls of the chambers, and which fills-up with a solid 'boss' what would otherwise be the depression at the Umbilicus of the spire. The substance of this 'boss' is traversed by a set of straight Canals, which pass directly from the spiral canal beneath, towards the external surface, where they open in little pits, as is shown in Pl. xv., fig. 16 ; the Umbilical boss in this species, however, being much smaller in proportion than it is in *P. craticulata*.—There is a group of Foraminifera to which the term *Nonionina* is properly applicable, that is probably to be considered as a Sub-genus of *Polystomella* ; agreeing with it in its general conformation, and especially in the distribution of its Canal-system ; but differing in

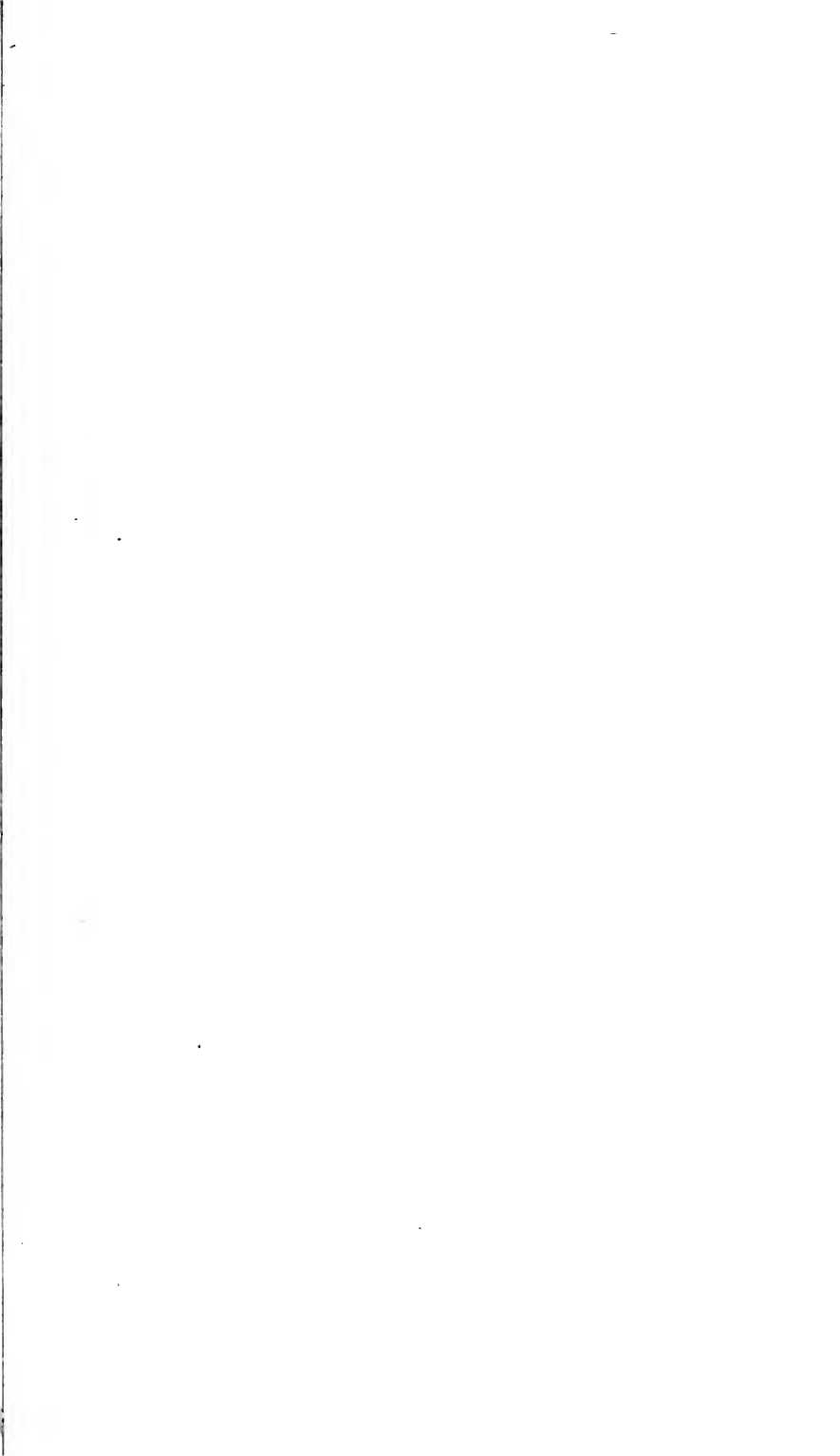

PLATE XVI.

FIG. 1.

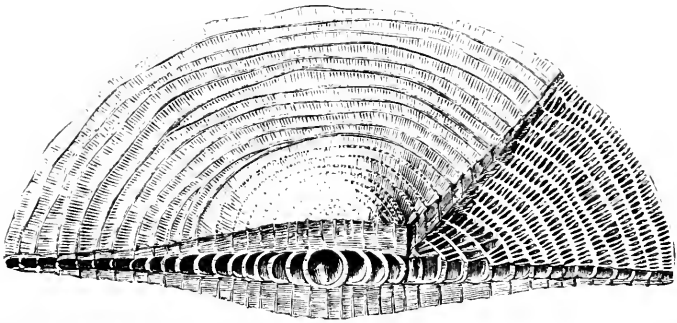

FIG. 2.

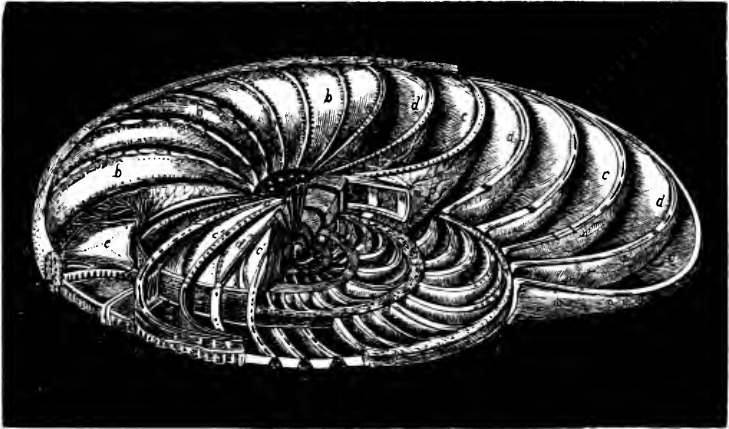
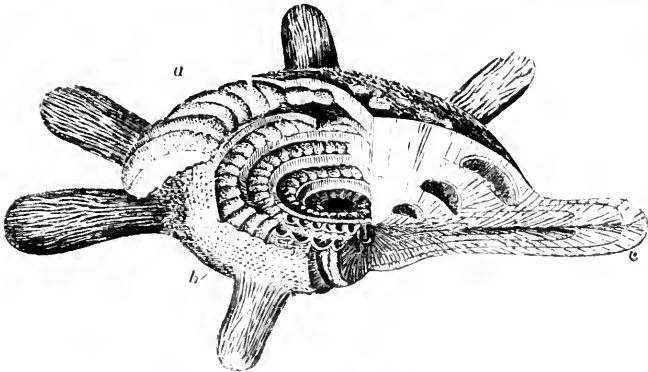

FIG. 3.



VARIOUS FORMS OF FORAMINIFERA.

[To face p. 509.]

its aperture, which is here a single fissure at the inner edge of the septal plane (Plate xv., fig. 19), and in the absence of the 'retrol processes' of the segments of the Sarcode-body, the external walls of the chambers being smooth. This form constitutes a transition to the ordinary Nummuline type, of which *Polystomella* is a more aberrant modification.

391. The Nummuline type is most characteristically represented at the present time by the Genus *Operculina*; which is so intimately united to the true *Nummulite* by intermediate forms that it is not easy to separate the two, notwithstanding that their typical examples are widely dissimilar. The former Genus (Plate xvi., fig. 2) is represented on our own coast by very small and feeble forms; but it attains a much higher development in Tropical seas, where its diameter sometimes reaches 1-4th of an inch. The Shell is a flattened Nautiloid spire, the breadth of whose earlier convolutions increases in a regular progression, but of which the last convolution (in full-grown specimens) usually flattens itself out like that of *Peneroplis*, so as to be very much broader than the preceding. The external walls of the Chambers, arching over the spaces between the septa, are seen at *b, b*; and these are bounded at the outer edge of each convolution by a peculiar band *a*, termed the Marginal Cord. This band, instead of being perforated by minute tubuli like those which pass from the inner to the outer surface of the chamber-walls without division or inosculation, is traversed by a system of comparatively large inosculating Passages, seen in cross section at *a'*; and these form part of the Canal system to be presently described. The principal cavities of the Chambers are seen at *c, c*; while the Alar Prolongations of those cavities over the surface of the preceding whorl are shown at *c', c'*. The chambers are separated by the septa *d, d, d*, formed of two laminae of shell, one belonging to each chamber, and having spaces between them in which lie the Interseptal Canals, whose general distribution is seen in the septa marked *e, e*, and whose smaller branches are seen irregularly divided in the septa *d', d'*, whilst in the septum *d''* one of the principal trunks is laid open through its whole length. At the approach of each septum to the marginal cord of the preceding, is seen the narrow fissure which constitutes the principal Aperture of communication between the chambers; in most of the septa, however, there are also some isolated pores (to which the lines point that radiate from *e, e*) varying both in number and position. The Interseptal Canals of each septum take their departure at its inner extremity from a pair of Spiral Canals, of which one passes along each side of the marginal cord; and they communicate at their outer extremity with the Canal-system of the marginal cord, as shown in Fig. 260. The external walls of the Chambers are composed of the same finely-tubular Shell-substance that forms them in the Nummulite; but, as in that Genus, not only are the septa themselves composed

of vitreous non-tubular substance, but that which lies over them, continuing them to the surface of the shell, has the same character; showing itself externally in the form sometimes of continuous ridges, sometimes of rows of tubercles, which mark the position of the septa beneath. These non-tubular Plates or Columns are often traversed by branches of the Canal-system, as seen at *g, g*. Similar columns of non-tubular substance, of which the summits show themselves as Tubercles on the surface, are not unfrequently seen between the septal bands, giving a variation to the surface-marking, which, taken in conjunction with variations in general conformation, might be fairly held sufficient to characterize distinct Species, were it not that, on a comparison of a great number of specimens, these variations are found to be so gradual, that no distinct line of demarcation can be drawn between the individuals which present them.

392. The Genus *Nummulina*, of which the fossil forms are commonly known as *Nummulites*, though represented at the present time by small and comparatively infrequent examples, was formerly developed to a vast extent; the Nummulitic Limestone chiefly made-up by the aggregation of its remains (the material of which the Pyramids are built) forming a band, often 1800 miles in breadth and frequently of enormous thickness, that may be traced from the Atlantic shores of Europe and Africa, through Western Asia to Northern India and China, and over vast areas of North America likewise. The diameter of a large proportion of Fossil Nummulites ranges between half an inch and an inch; but there are some whose diameter does not exceed 1-16th of an inch, whilst others attain the gigantic diameter of $4\frac{1}{2}$ inches. Their typical form is that of a double-convex lens; but sometimes it much more nearly approaches the globular shape, whilst in other cases it is very much flattened; and great differences exist in this respect among individuals of what must be accounted one and the same Species. Although there are some Nummulites which closely approximate *Operculina* in their mode of growth, yet the typical forms of this Genus present certain well-marked distinctive peculiarities. Each Convolution is so completely invested by that which succeeds it, and the external wall or Spiral Lamina of the new convolution is so completely separated from that of the convolution it encloses by the Alar prolongations of its own chambers (the peculiar arrangement of which will be presently described), that the Spire is scarcely if at all visible on the external surface. It is brought into view, however, by splitting the Nummulite through the median plane, which may often be accomplished simply by striking it on one edge with a hammer, the opposite edge being placed on a firm support; or, if this method should not succeed, by heating it in the flame of a spirit-lamp, and then throwing it into cold water or striking it edgeways. Nummulites usually show many more turns, and a more gradual rate of increase

in the breadth of the Spire, than Foraminifera generally: this will be apparent from an examination of the Vertical section shown in Fig. 257, which is taken from one of the commonest and most characteristic Fossil examples of the genus, and which shows no fewer than ten convolutions in a fragment that does not by any means extend to the centre of the spire. This section also shows the complete enclosure of the older convolutions by the newer, and the interposition of the Alar prolongations of the Chambers between the successive layers of the Spiral lamina. These prolongations are variously arranged in different examples of the genus; thus in some, as *N. distans*, they keep their own separate course, all tending radially towards the centre; in others, as *N. laevigata*, their partitions inosculate with each other, so as to divide the space intervening between each layer and the next into an irregular network, presenting in vertical section the appearance shown in Fig. 257; whilst in *N. garansensis* they are broken

FIG. 257.

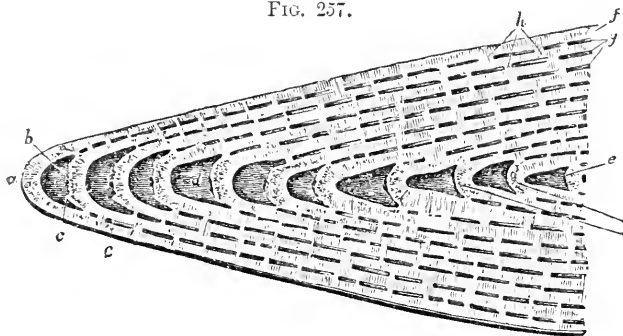

Vertical Section of portion of *Nummulina laevigata*:—*a*, margin of external Whorl; *b*, one of the outer row of Chambers; *c, c*, Whorl invested by *a*; *d*, one of the Chambers of the fourth Whorl from the margin; *e, e*, marginal portions of the enclosed Whorls; *f*, investing portion of outer Whorl; *g, g*, spaces left between the investing portions of successive Whorls; *h, h*, sections of the Partitions dividing these.

up into a number of Chamberlets, having little or no direct communication with each other.

393. Notwithstanding that the inner chambers are thus so deeply buried in the mass of investing whorls, yet there is evidence that the segments of Sarcodæ which they contained were not cut off from communication with the exterior, but that they may have retained their vitality to the last. The Shell itself is almost everywhere minutely porous, being penetrated by parallel Tubuli which pass directly from one surface to the other. These tubes are shown, as divided lengthways by a Vertical section, in Fig. 258,

a, a; whilst the appearance they present when cut across in a Horizontal section is shown in Fig. 259, the transparent Shell

FIG. 258.

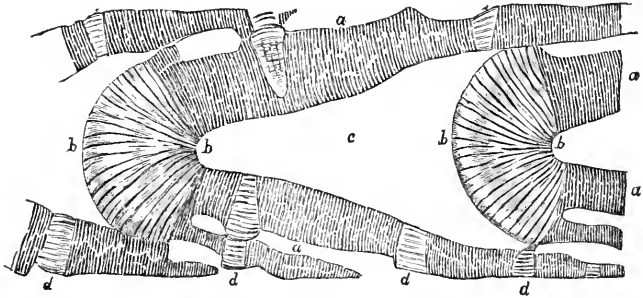

Portion of a thin Section of *Nummulina larvigata*, taken in the direction of the preceding, highly magnified to show the minute structure of the Shell:—*a, a*, portions of the ordinary Shell-substance traversed by parallel Tubuli; *b, b*, portions forming the Marginal wall, traversed by diverging and larger Tubuli; *c*, one of the Chambers laid open; *d, d, d*, Pillars of solid substance not perforated by tubuli.

substance *a, a, a*, being closely dotted with minute punctations which mark their orifices. In that portion of the Shell, however, which forms the margin of each whorl (Fig. 258, *b, b*), the tubes

FIG. 259.

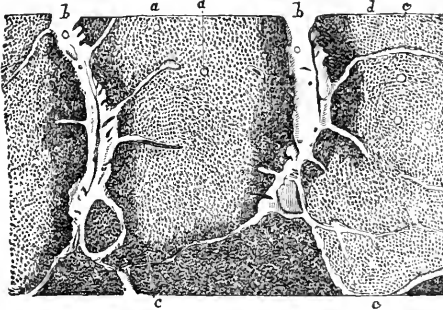

are larger, and diverge from each other at greater intervals; and it is shown by Horizontal sections that they communicate freely with each other laterally, so as to form a network such as is shown at *b, b*, Fig. 260. At certain other points, *d, d, d* (Fig. 258), the Shell-substance is not perforated by tubes, but is peculiarly dense in its texture, forming solid Pillars which seem to strengthen

Portion of Horizontal Section of *Nummulite*, showing the structure of the Walls and of the Septa of the Chambers:—*a, a, a*, portion of the wall covering three Chambers, the punctations of which are the orifices of Tubuli; *b, b*, Septa between these chambers, containing Canals which send out lateral branches, *c, c*, entering the Chambers by larger orifices, one of which is seen at *d*.

the other parts; and in Nummulites whose surfaces have been much exposed to attrition, it commonly happens that the pillars of the superficial layer, being harder than the ordinary shell-substance, and being consequently less worn down, are left as prominences, the presence of which has often been accounted (but erroneously) as a Specific character. The successive chambers of the same whorl communicate with each other by a passage left between the inner edge of the partition that separates them and the Marginal Cord of the preceding whorl; this passage is sometimes a single large broad Aperture, but is more commonly formed by the more or less complete coalescence of several separate perforations, as is seen in Fig. 256, *b*. There is

also, as in Operculina, a variable number of isolated pores in most of the septa, forming a secondary means of communication between the Chambers.—The Canal-system of *Nummulina* seems to be distributed upon essentially the same plan as in *Operculina*; its passages, however, are usually more or less obscured by fossilizing material. A careful examination will generally disclose traces of them in the middle of the partitions that divide the Chambers (Fig. 259, *b, b*), while from these may be seen to proceed the lateral branches (*c, c*), which, after burrowing (so to speak) in the walls of the chambers, enter them by large orifices (*d*). The Interseptal Canals, and their communication with the inosculating system of passages excavated in the Marginal Cord, are extremely well seen in the Internal Cast represented in Fig. 260.

FIG. 260.

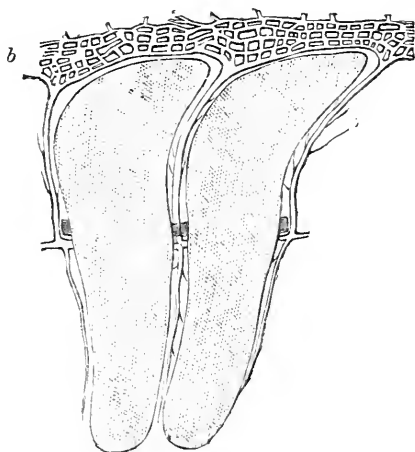

Cast of the Interior of two of the Chambers, *a, a*, of *Nummulina striata*, with the network of Canals, *b, b*, in the Marginal Cord, communicating with canals passing between the chambers.

394. A very interesting modification of the Nummuline type is presented in the genus *Heterostegina* (Fig. 261), which bears a very strong resemblance to *Orbiculina* in its Plan of growth, whilst in every other respect it is essentially different. If the principal chambers of an *Operculina* were divided into Chamberlets by secondary partitions in a direction transverse to that of the principal septa, it would be converted into a *Heterostegina*; just as a *Penc-*

roplis would be converted by the like subdivision into an *Orbiculina* (§ 374). Moreover, we see in *Heterostegina*, as in *Orbiculina*, a great tendency to the opening-out of the Spire with the advance of

FIG. 261.

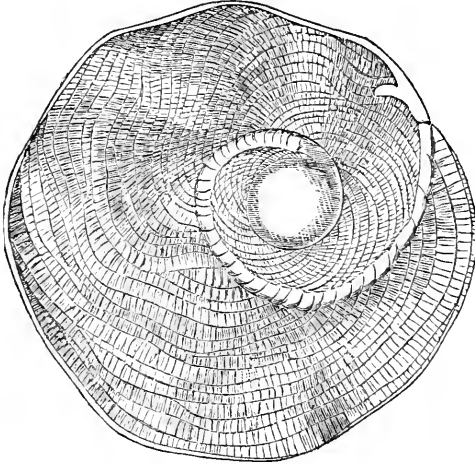
*Heterostegina.*

age; so that the apertural margin extends round a large part of the Shell, which thus tends to become discoidal. And it is not a little curious that we have in this series another form, *Cycloclypeus*, which bears exactly the same relation to *Heterostegina*, that *Orbitolites* does to *Orbiculina*; in being constructed upon the *cyclical* plan from the commencement, its chamberlets being arranged in rings around a central chamber (Plate XVI., fig. 1). This remarkable Genus, at present only known by specimens dredged up from considerable depths off the coast of Borneo, is the largest of existing Foraminifera; some specimens of its Disks in the British Museum having a diameter of $2\frac{1}{4}$ inches. Notwithstanding the difference of its plan of growth, it so precisely accords with the Nummuline type in every character which essentially distinguishes that Genus, that there cannot be a doubt of the intimacy of their relationship. It will be seen from the examination of that portion of the figure which shows *Cycloclypeus* in Vertical Section, that the solid layers of Shell by which the chambered portion is enclosed are so much thicker, and consist of so many more Lamellæ, in the central portion of the disk, than they do nearer its edge, that new lamellæ must be progressively added to the surfaces of the disk, concurrently with the addition of new rings of Chamberlets to its margin. These Lamellæ, however, are closely applied one to the other, without any intervening spaces; and they are all traversed by Columns of non-tubular substance, which spring from the septal bands, and gradually increase in diameter with their approach to the surface, from which they project in the central portion of the disk as glistening tubercles.

395. The Nummulitic Limestone of certain localities (as the

apertural margin extends round a large part of the Shell, which thus tends to become discoidal. And it is not a little curious that we have in this series another form, *Cycloclypeus*, which bears exactly the same relation to *Heterostegina*, that *Orbitolites* does to *Orbiculina*; in being constructed upon the *cyclical* plan from the commencement, its chamberlets being arranged in rings around a central

South-west of France, North-eastern India, &c.) contains a vast abundance of discoidal bodies termed *Orbitoides*, which are so similar to Nummulites as to have been taken for them, but which bear a much closer resemblance to *Cycloclypeus*.

These are only known in the Fossil state, and their structure can only be ascertained by the examination of Sections thin enough to be translucent. When one of these disks (which vary in size, in different species, from that of a fourpenny-piece to that of half-a-crown) is rubbed-down so as to display its internal organization, two different kinds of structure are usually seen in it; one being composed of Chamberlets of very definite form, quadrangular in some species, circular in others, arranged with a general but not constant regularity in concentric circles (Figs. 262, 263, *b, b*); the other, less transparent, being formed of minuter Chamberlets which have no such constancy of form, but which might almost be taken for the pieces of a Dissected Map (*a, a*).

FIG. 262.

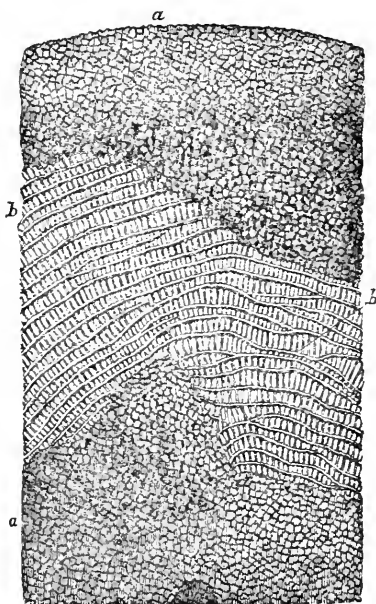

Section of *Orbitoides Fortisii*, parallel to the surface; traversing at *a, a* the Superficial layer, and at *b, b* the Median layer.

might almost be taken for the pieces of a Dissected Map (*a, a*).

FIG. 263.

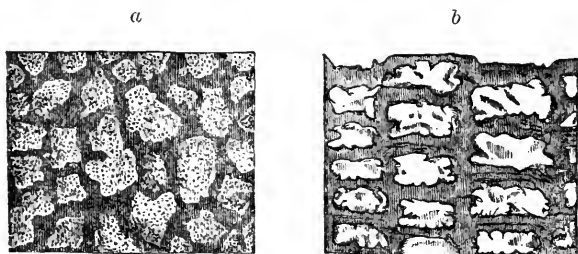

Portions of the same section, more highly magnified;—*a*, Superficial layer; *b*, Median layer.

In the upper and lower walls of these last, minute punctations may be observed, which seem to be the orifices of connecting Tubes whereby they are perforated. The relations of these two

FIG. 264.



Vertical Section of *Orbitoides Fortisii*, showing the large Central chamber at *a*, and the Median layer surrounding it, covered above and below by the Superficial layers.

kinds of structure to each other are made evident by the examination of a vertical section (Fig. 264); which shows that the portion *a*, Figs. 262, 263, forms the Median plane, its concentric circles of Chamberlets being arranged round a large central chamber *a*, as in *Cycloclypeus*; whilst the Chamberlets of the portion *b* are irregularly superposed one upon the other, so as to form several layers which are most numerous towards the centre of the disk, and thin-away gradually towards its margin. The disposition and connections of the Chamberlets of the Median layer in *Orbitoides* seem to correspond very closely with those which have been already described as prevailing in *Cycloclypeus*; the most satisfactory indications to this effect being furnished by the

FIG. 265.

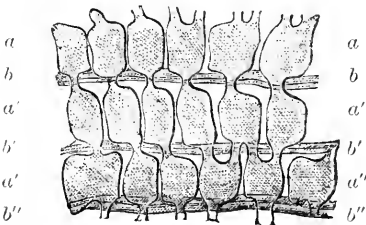

Siliceous cast of portion of Median plane of *Orbitoides Fortisii*, showing at *a a, a' a', a'' a'*, six Chambers of each of three zones, with their mutual communications; and at *b b, b' b', b'' b''*, portions of three Annular Canals.

Siliceous casts to be met with in certain Green Sands, which afford a model of the Sarcode-body of the animal. In such a fragment (Fig. 265) we recognize the Chamberlets of three successive zones, *a, a', a''*, each of which seems normally to communicate by one or two passages with the Chamberlets of the zone internal and external to its own; whilst between the Chamberlets of the same zone there seems to be no direct connection. They are brought into relation, however, by means of Annular Canals,

which seem to represent the Spiral canals of the Nummulite, and of which the Internal Casts are seen at *b b, b' b', b'' b''*.

396. A most remarkable Fossil, referable to the Foraminiferal type, has been recently discovered in Strata much older than the

very earliest that were previously known to contain Organic Remains ; and the determination of its real character may be regarded as one of the most interesting results of Microscopic research. This fossil, which has received the name *Eozoon Canadense*, is found in beds of Serpentine Limestone that occur near the base of the *Laurentian Formation** of Canada, which has its parallel in Europe in the Fundamental Gneiss of Bohemia and Bavaria, and in the very earliest Stratified Rocks of Scandinavia and Scotland. These beds are found in many parts to contain masses of considerable size, but usually of indeterminate form, disposed after the manner of an ancient Coral Reef, and consisting of alternating layers—frequently numbering more than *fifty*—of Carbonate of Lime and Serpentine (Silicate of Magnesia). The regularity of this alternation, and the fact that it presents itself also between other Calcareous and Siliceous minerals, having led to a suspicion that it had its origin in Organic Structure, thin Sections of well-preserved specimens were submitted to Microscopic examination by Dr. Dawson of Montreal, who at once recognized its Foraminiferal nature :† the *Calcareous* layers presenting the characteristic appearances of true *Shell*, so disposed as to form an irregularly chambered structure, and frequently traversed by systems of ramifying Canals corresponding to those of *Calcarina* (§ 387) ; whilst the *Serpentinous* or other Siliceous layers were regarded by him as having been formed by the infiltration of Silicates in solution into the cavities originally occupied by the Sarcode-body of the *Animal*,—a process of whose occurrence at various Geological periods, and also at the present time, abundant evidence has already been adduced. Although this determination has been called in question, on the ground that some resemblance to the supposed Organic structure of *Eozoon* is presented by bodies of purely Mineral origin,‡ yet, as it has not only been accepted by all those whose knowledge of Foraminiferal structure gives weight to their judgment, but has been fully confirmed by subsequent discoveries,§ the Author feels justified in here describing *Eozoon* as he believes it to have existed when it originally extended itself as an Animal

* This *Laurentian Formation* was first identified as a regular series of Stratified Rocks, underlying the equivalents not merely of the Silurian, but also of the Upper and Lower Cambrian Systems of this country, by Sir William Logan, the accomplished Director of the Geological Survey of Canada.

† This recognition was due, as Dr. Dawson has explicitly stated in his original Memoir ("Quarterly Journal of the Geological Society," Vol. xxi., p. 54), to his acquaintance not merely with the Author's previous Researches on the Minute Structure of the *Foraminifera*, but with the special characters presented by *Calcarina*, as exhibited in thin sections which had been transmitted to him by the Author.

‡ See the Memoir of Profs. King and Rowney, in the "Quart. Journ. of Geol. Soc.," Vol. xxii., p. 185.

§ See Dr. Dawson's account of a specimen of *Eozoon* discovered in a homogeneous Limestone, in "Quart. Journ. of Geol. Soc.," Vol. xxiii., p. 257.

growth over vast areas of the Sea-bottom in the Laurentian epoch.*

397. Whilst essentially belonging to the *Nummuline* group, in virtue of the fine tubulation of the Shelly layers forming the 'proper wall' of its chambers, *Eozoon* is related to various types of recent Foraminifera in its other characters. For in its indeterminate Zoophytic mode of Growth it agrees with *Polytrema* (§ 386); in the incomplete separation of its Chambers it has its parallel in *Carpenteria* (§ 384); whilst in the high development of its Intermediate Skeleton and of the Canal system by which this is nourished, it finds its nearest representative in *Calcarina* (§ 387). Its Calcareous layers were so superposed, one upon another, as to include between them a succession of 'storeys' of Chambers (Plate xvii., fig. 1, A¹, A¹, A², A²); the Chambers of each 'storey' usually opening one into another, as at *a*, *a*, like Apartments *en suite*; but being occasionally divided by complete *Septa*, as at *b*, *b*. These *Septa* are traversed by passages of communication between the chambers which they separate; resembling those which, in existing types, are occupied by *stolons* connecting together the segments of the Sarcode-body. Each layer of Shell consists of two finely-tubulated or 'Nummuline' lamellæ, B, B, which form the boundaries of the chambers beneath and above, serving (so to speak) as the *ceiling* of the former, and as the *floor* of the latter; and of an intervening deposit of homogeneous Shell substance, c, c, which constitutes the 'Intermediate Skeleton.' The thickness of this interposed layer varies considerably in different parts of the same mass; being in general greatest near its base, and progressively diminishing towards its upper surface. The 'intermediate skeleton' is occasionally traversed by large passages (D), which seem to establish a connection between the successive layers of Chambers; and it is penetrated by arborescent systems of Canals (E, E), which are often distributed both so extensively and so minutely through its substance, as to leave very little of it without a branch.

398. Now in the Fossilized condition in which *Eozoon* is most commonly found, not only the cavities of the Chambers, but the Canal-systems to their smallest ramifications, are filled up by the Siliceous infiltration which has taken the place of the original Sarcode-body, as in the cases already cited (§ 390, *note*); and thus when a piece of this fossil is subjected to the action of dilute Acid, by which its Calcareous portion is dissolved away, we obtain an *Internal Cast* of its Chambers and Canal-system (Plate xvii., fig. 2), which, though altogether dissimilar in *arrangement*, is essentially analogous in *character* to the 'internal casts' re-

* For a fuller account of the results of the Author's own Study of *Eozoon*, and of the basis on which the above reconstruction is founded, see his Papers in "Quart. Journ. of Geol. Soc.," Vol. xxi., p. 59, and Vol. xxii., p. 219; and in the "Intellectual Observer," Vol. vii. (1865), p. 278.

PLATE XVII.

FIG. 1.

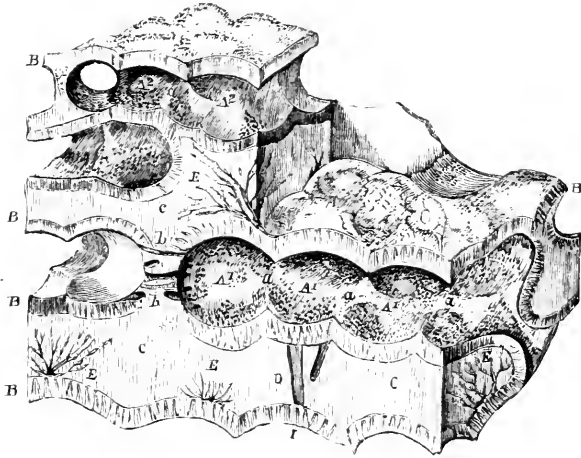
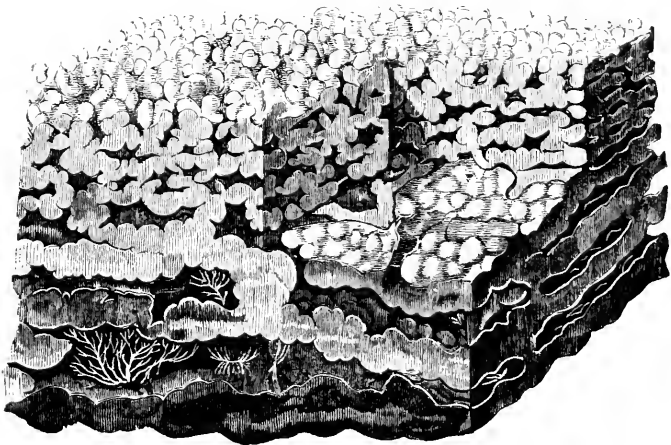
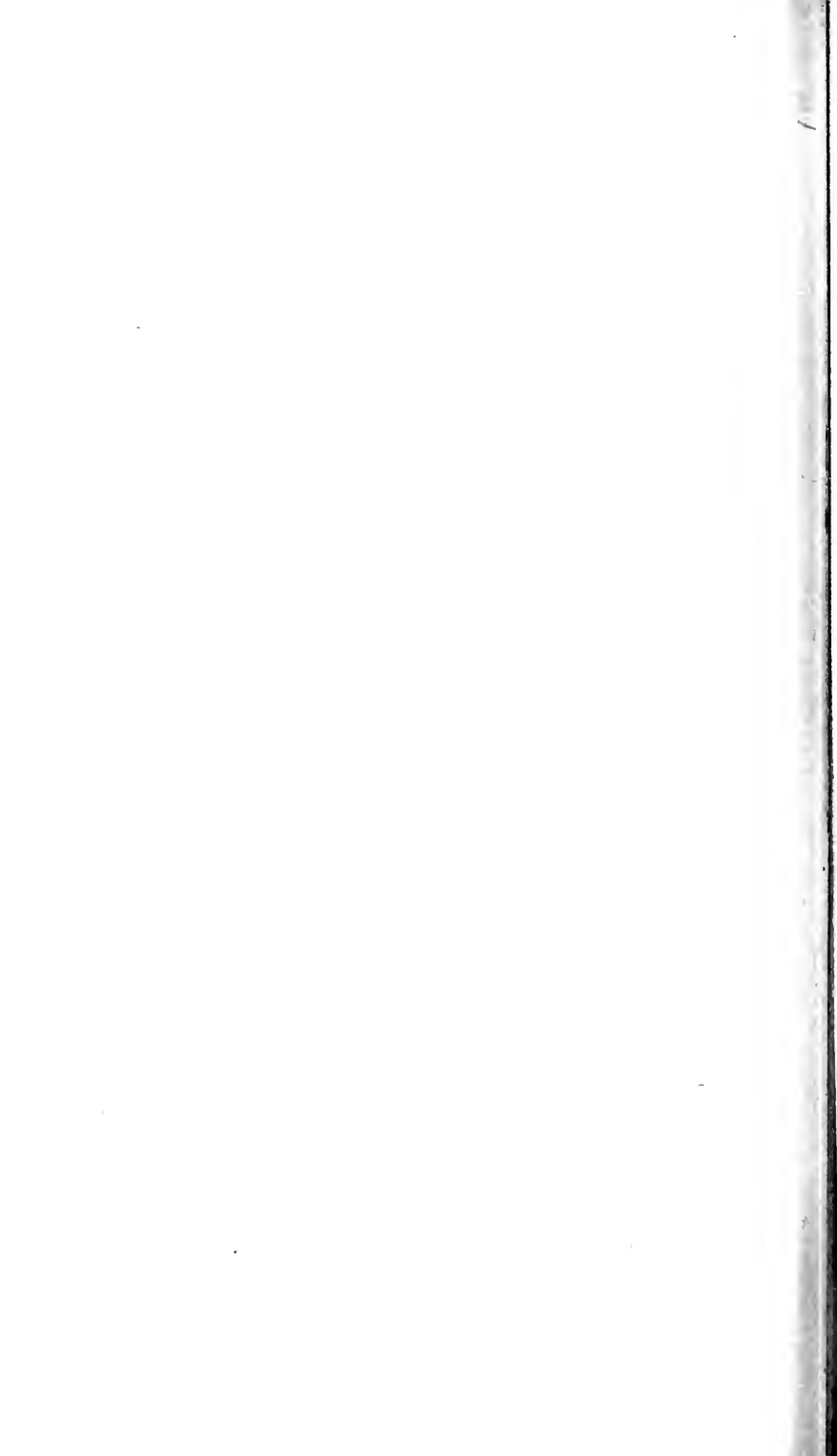

FIG. 2.



STRUCTURE OF EOZOON CANADENSIS.

[To face p. 518.]



presented in Figs. 258, 259. This Cast presents us, therefore, with a *model* in hard Serpentine of the soft Sarcode-body which originally occupied the Chambers, and extended itself into the ramifying Canals, of the Calcareous Shell; and, like that of *Polystomella* (§ 390), it affords an even more satisfactory elucidation of the relations of these parts, than we could have gained from the study of the living Organism. We see that each of the layers of Serpentine, forming the lower part of such a specimen, is made up of a number of coherent Segments, which have only undergone a partial separation; these appear to have extended themselves horizontally without any definite limit; but have here and there developed new segments in a vertical direction, so as to give origin to new layers. In the spaces between these successive layers, which were originally occupied by Calcareous Shell, we see the 'internal casts' of the branching Canal-System; which give us the exact models of the extensions of the Sarcode-body that originally passed into them.—But this is not all. In specimens in which the Nummuline Layer constituting the 'proper wall' of the chambers was originally well preserved, and in which the Decalcifying process has been carefully managed (so as not, by too rapid an evolution of Carbonic acid gas, to disturb the arrangement of the Serpentinous residuum), that layer is represented by a thin white film covering the exposed surfaces of the segments; the superficial aspect of which, as well as its sectional view, are shown in Fig. 2. And when this layer is examined with a sufficient magnifying power, it is found to consist of extremely minute needle-like fibres of Serpentine, which sometimes stand upright, parallel, and almost in contact with each other, like the fibres of Asbestos (so that the film which they form has been termed the 'Asbestiform layer'), but which are frequently grouped in converging brush-like bundles, so as to be very close to each other in certain spots at the surface of the film, whilst widely separated in others. Now these fibres, which are less than 1-10,000th of an inch in diameter, are the 'internal casts' of the tubuli of the Nummuline layer (a precise parallel to them being presented in the 'internal cast' of a *recent* *Amphistegina* in the Author's possession); and their arrangement presents all the varieties which have been described (§ 391) as existing in the Shells of *Operculina*.—Thus these delicate and beautiful Siliceous fibres represent those *pseudopodial* threads of Sarcode, which originally traversed the minutely-tubular walls of the chambers; and a *precise model* of the most ancient Animal of which we have any knowledge, notwithstanding the extreme softness and tenuity of its substance, is thus presented to us with a completeness that is scarcely even approached in any later Fossil.

399. In the upper part of the 'decalcified' specimen shown in Fig. 2, it is to be observed that the segments are confusedly heaped together, instead of being regularly arranged in layers,

the *lamellated* mode of growth having given place to the *acerruline*. This change is by no means uncommon among Foraminifera; an irregular piling-together of the chambers being frequently met with in the later growth of types whose earlier increase takes place upon some much more definite plan. After what fashion the *earliest* development of *Eozoon* took place, we have at present no knowledge whatever; but in a *young* specimen which has been recently discovered, it is obvious that each successive 'storey' of chambers was limited by the closing-in of the shelly layer at its edges, so as to give to the entire fabric a definite form closely resembling that of a straightened *Peneroplis* (Plate xv., fig. 5). Thus it is obvious that the chief peculiarity of *Eozoon* lay in its capacity for *indefinite extension*; so that any single Organism might attain a size comparable to that of a massive Coral.—Now this, it will be observed, is simply due to the fact that its increase by Gemmation takes place *continuously*; the new segments successively budded-off remaining in connection with the original stock, instead of detaching themselves from it, as in Foraminifera generally. Thus the little *Globigerina* forms a shell of which the number of chambers never seems to increase beyond *ten*, any additional segments detaching themselves so as to form separate shells; but by the repetition of this multiplication the sea-bottom of large areas of the Atlantic Ocean at the present time has come to be covered with accumulations of *Globigerinae*, which, if fossilized, would form beds of Limestone not less massive than those which have had their origin in the growth of *Eozoon*. The difference between the two modes of increase may be compared to the difference between a Plant and a Tree. For in the Plant the individual organism never attains any considerable size, its extension by gemmation being limited; though the aggregation of individuals produced by the detachment of its buds (as in a Potato-field) may give rise to a mass of vegetation as great as that formed in the largest Tree by the continuous putting-forth of new buds.

400. It has been hitherto in the Laurentian Serpentine-Limestones of Canada alone, that *Eozoon* has presented itself in such a state of preservation as fully to justify the assumption of its Organic nature. But from the greater or less resemblance which is presented to these by Serpentine-Limestones occurring in various localities* among strata that seem the Geological equivalents of the

* The Author has satisfied himself of this fact, in regard to various specimens of *Ophicalcite* obtained from various depths in the great Fundamental Gneiss of Central Europe, the thickness of which Formation is estimated by Sir Roderick Murchison at 90,000 feet; and the form of *Eozoon* which there presents itself has been elaborately studied by Prof. Gümbel. (See his Memoir 'Ueber das Vorkommen von *Eozoon* im ostbayerischen Urgebirge,' in the "Sitzungsberichte der Königl. Acad. der Wissenschaften in München," 1866, i, 1). He has also examined with the same result specimens of Serpentine-Limestone, obligingly sent to him by Prof. Lovén, of Stockholm, from the Laurentians of Scandinavia. In

Canadian Laurentians, it seems a justifiable conclusion that this type was very generally diffused in the earlier ages of the earth's history; and that it had a large (and probably the chief) share in the production of the most ancient Calcareous strata, separating Carbonate of Lime from its solution in the Ocean-waters, in the same manner as do the Polypes by whose growth Coral-reefs and islands are being upraised at the present time.

401. *Collection and Selection of Foraminifera.*—Many of the Foraminifera attach themselves in the living state to Sea-weeds, Zoophytes, &c.; and they should, therefore, be carefully looked-for on such bodies, especially when it is desired to observe their internal organization and their habits of life. They are often to be collected in much larger numbers, however, from the Sand or Mud dredged-up from the sea-bottom, or even from that taken from between the tide-marks. In a paper containing some valuable hints on this subject,* Mr. Legg mentions that, in walking over the Small Mouth Sand, which is situated on the north-side of Portland Bay, he observed the sand to be distinctly marked with white ridges, many yards in length, running parallel with the edge of the water; and upon examining portions of these, he found Foraminifera in considerable abundance. One of the most fertile sources of supply that our own coasts afford, is the Ooze of the Oyster-beds, in which large numbers of living specimens will be found; the variety of specific forms, however, is usually not very great. In separating these bodies from the particles of Sand, Mud, &c., with which they are mixed, various methods may be adopted, in order to shorten the tedious labour of picking them out, one by one, under the Simple Microscope; and the choice to be made among these will mainly depend upon the condition of the Foraminifera, the importance (or otherwise) of obtaining them alive, and the nature of the substances with which they are mingled.—Thus, if it be desired to obtain *living* specimens from the Oyster-ooze, for the examination of their soft parts, or for preservation in a Vivarium, much time will be saved by stirring the mud (which should be taken from the surface only of the deposit) in a jar with water, and then allowing it to stand for a few moments; the finer particles will remain diffused through the liquid, while the heavier

the case of these, however, as in that of the Connemara Marble, it is obvious that the rock has undergone very considerable *metamorphic* action; so that its originally Organic structure has in great degree given place to a purely Mineral arrangement, as has occurred in numberless other cases. And he believes that the objections taken by Profs. King and Rowney to the doctrine of the Foraminiferal character of *Eozoon*, have been mainly suggested by their having especially studied one of its *most altered and least characteristic* forms, and having had comparatively little opportunity of examining the Canadian specimens in which the evidences of Organic structure are most unmistakable, and of comparing their characters with those of other Fossil as well as Recent Foraminifera.

* "Transactions of Microscopical Society," 2nd Series, Vol. ii. (1854), p. 19.

will subside; and as the Foraminifera (in the present case) belong to the latter category, they will be found at the bottom of the vessel, almost entirely free from extraneous matter, after this operation has been repeated two or three times. It would always be well to examine the first deposit let fall by the water that has been poured-away; as this may contain the smaller and lighter forms of Foraminifera.—But supposing that it be only desired to obtain the *dead* Shells from a mass of Sand brought-up by the dredge, a very different method should be adopted. The whole mass should be exposed for some hours to the heat of an oven, and be turned-over several times, until it is found to have been thoroughly dried throughout; and then, after being allowed to cool, it should be stirred in a large vessel of water. The chambers of their shells being now occupied by Air alone (for the bodies of such as were alive will have shrunk up almost to nothing), the Foraminifera will be the lightest portion of the mass; and they will be found floating on the water, while the particles of sand, &c., subside.—Another method, devised by Mr. Legg, consists in taking advantage of the relative sizes of different kinds of Foraminifera and of the substances that accompany them. This, which is especially applicable to the sand and rubbish obtainable from Sponges (which may be got in large quantity from sponge-merchants), consists in sifting the whole aggregate through successive sieves of wire-gauze, commencing with one of 10 wires to the inch, which will separate large extraneous particles, and proceeding to those of 20, 40, 70, and 100 wires to the inch, each (especially that of 70) retaining a much larger proportion of Foraminiferal Shells than of the accompanying particles; so that a large portion of the extraneous matters being thus got-rid-of, the final selection becomes comparatively easy.—Certain forms of Foraminifera are found attached to Shells, especially Bivalves (such as the *Chamaceæ*) with foliated surfaces; and a careful examination of those of Tropical seas, when brought home 'in the rough,' is almost sure to yield most valuable results.—The final selection of specimens for mounting should always be made under some appropriate form of Single Microscope (§§ 34–37); a fine camel-hair pencil, with the point wetted between the lips, being the instrument which may be most conveniently and safely employed, even for the most delicate specimens. In mounting Foraminifera as Microscopic objects, the method to be adopted must entirely depend upon whether they are to be viewed by *transmitted* or by *reflected* light. In the former case they should be mounted in Canada-balsam; the various precautions to prevent the retention of air-bubbles, which have been already described (§ 160), being carefully observed. In the latter no plan is so simple, easy, and effectual, as the attaching them with a little Gum to Wooden Slides (§ 155). They should be fixed in various positions, so as to present all the different aspects of the Shell, particular care being taken that its

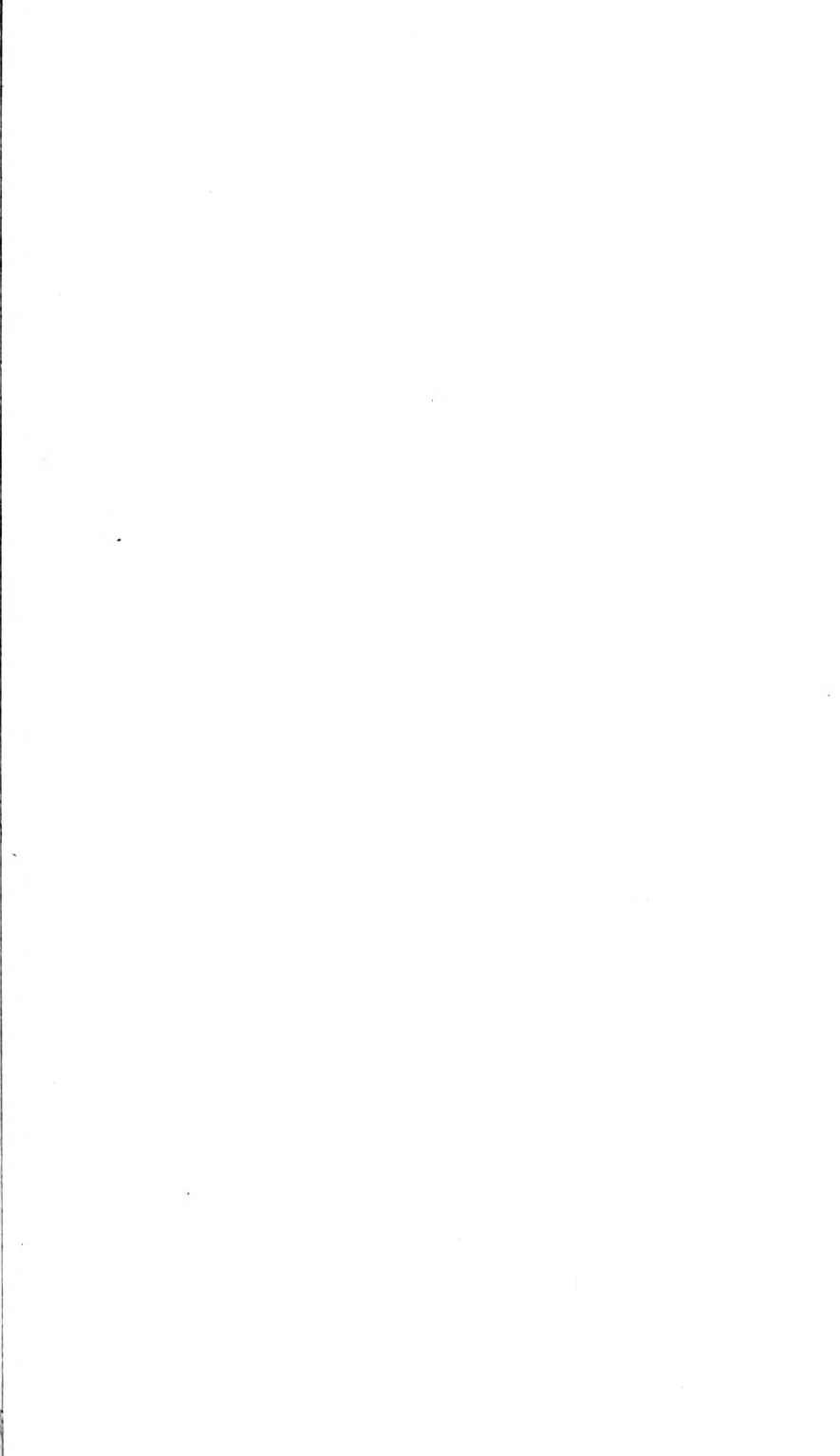

PLATE XVIII

FIG. 1.

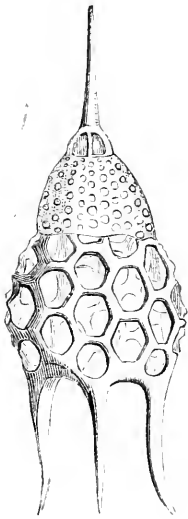

FIG. 3.

FIG. 2.

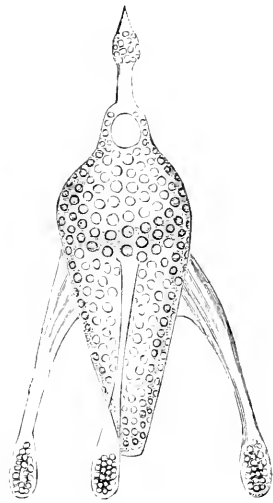
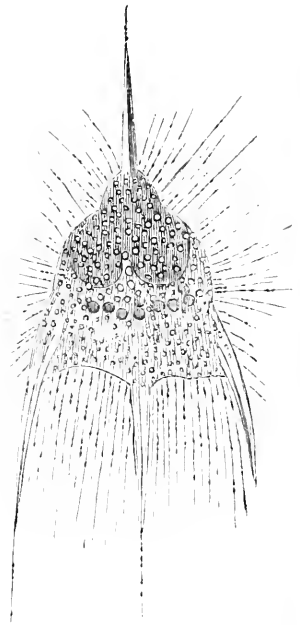
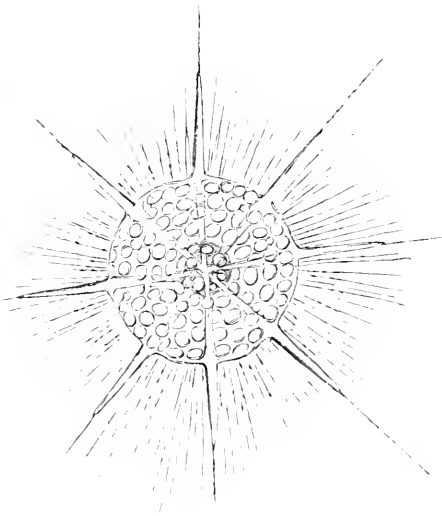

FIG. 4.



VARIOUS FORMS OF POLYCYSTINA.

[To face p. 523.]

Mouth is clearly displayed; and this may often be most readily managed by attaching the specimens *sideways* to the wall of the circular depression of the Slide. Or the specimens may be attached to Disks fitted for being held in Morris's Disk-Holder (§ 95); whilst, for the examination of specimens in every variety of position, Mr. R. Beck's 'Revolving Disk-Holder' (Fig. 76) will be found extremely convenient. Where, as will often happen, the several individuals differ considerably from one another, special care should be taken to arrange them in *Series* illustrative of their Range of Variation and of the mutual connections of even the most diverse forms.—For the display of the Internal Structure of Foraminifera, it will often be necessary to make extremely Thin Sections, in the manner already described (§§ 138–140); and much time will be saved by attaching a number of specimens to the Glass-slide at once, and by grinding them down together. For the preparation of Sections, however, of the extreme thinness that is often required, those which have been thus reduced should be transferred to separate slides, and finished-off each one by itself.

402. POLYCYSTINA.—These are minute Siliceous shells, possessing wonderful beauty and variety of form and structure, which contain in the living state an olive-brown 'sarcodæ,' that extends itself into pseudopodial prolongations (resembling those of the *Actinophrys*, § 329), which pass through the large apertures by which the shells are perforated (Plate XVIII., figs. 3, 4). The sarcodæ-body does not always fill the shell; often occupying only its upper part or vault, and showing a regular division into four lobes. The Shells are in some instances most perfect spheres (Plate XIX., fig. 1); and occasionally we find a whole series of such spheres arranged concentrically one within another, and connected by radiating rods (fig. 2). They are often prolonged into spines or other projections, which sometimes branch in a very remarkable manner (figs. 4, 5). It seems probable that these creatures are almost as widely diffused at the present time as are the Foraminifera, although from their greater minuteness they have not been so often recognized. For having been first discovered by Prof. Ehrenberg at Cuxhaven on the North Sea, they were afterwards found by him in collections made in the Antarctic Seas, and have been described by Prof. Bailey as presenting themselves (with Foraminifera and Diatomaceæ) in the deposits brought-up by the sounding-lead from the bottom of the Atlantic, at depths of from 1000 to 2000 fathoms. They have also been studied by Prof. Müller* in the Mediterranean; and an immense variety of forms occurring in the Adriatic has been described in the magnificent work of Prof. Haeckel;†

* 'Über die Thallassicollen, Polycystinen, und Acanthometren des Mittelmeeres,' in "Abhandlungen der Königl. Akad. der Wissensch. zu Berlin," 1858, and separately published; also 'Ueber die im Hafen von Messina beobachteten Polycystinen,' in the "Monatsberichte" of the Berlin Academy for 1855, pp. 671–676.

† "Die Radiolarien (Rhizopoda Radiaria)," Berlin, 1862.

whilst Dr. Wallich has met with this type abundantly in the Indian Ocean. It appears to have been yet more abundant, however, during the later Geological periods; for not only have certain forms (among them *Haliomma*, Fig. 266) been detected by Prof.

FIG. 266.

*Haliomma Humboldtii.*

FIG. 267.

*Perichlamyidium prætextum.*

FIG. 268.

Fig. 268. *Stylodyctya gracilis.*

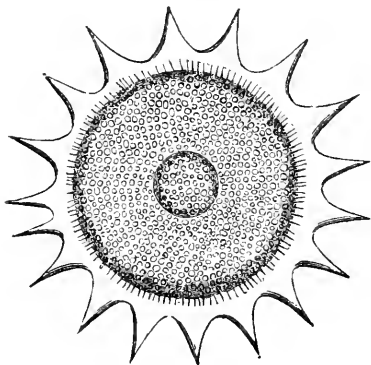
FIG. 269.

Fig. 269. *Astromma Aristotelis.*

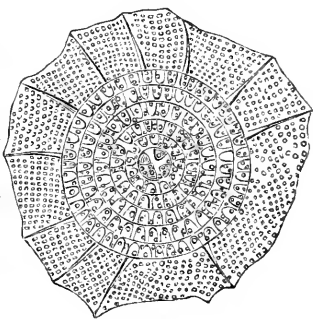
Ehrenberg in the Chalks and Marls of Sicily and Greece, and of Oran in Africa, and also in the Diatomaceous deposits of Bermuda and Richmond (Virginia); but a large proportion of the rock that prevails through an extensive district in the island of Barbadoes has been found by him to be composed of Polycystina, mingled with Diatomaceæ, with a few calcareous Foraminifera, and with Calcareous earth which was probably derived from the decomposition of Corals, &c.

FIG. 270.

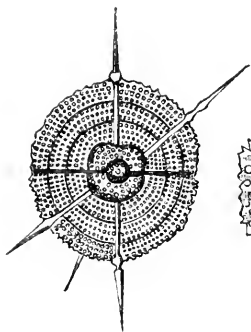
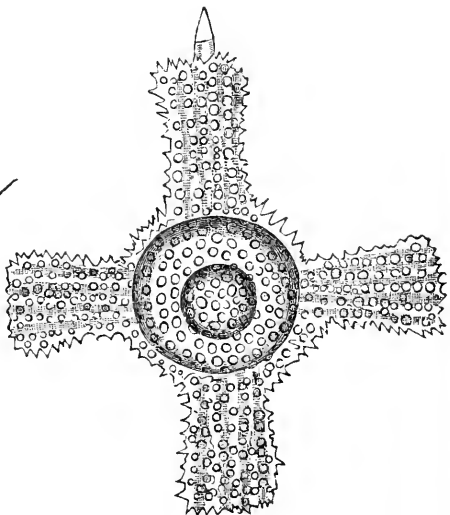

Fossil *Polycystina*, &c., from Barbadoes:—*a*, *Podocyrtes mitra*; *b*, *Rhabdolithus sceptrum*; *c*, *Lychnocanium falciferum*; *d*, *Eucyrtidium tubulus*; *e*, *Flustrella concentrica*; *f*, *Lychnocanium lucerna*; *g*, *Eucyrtidium elegans*; *h*, *Dictyospyris clathrus*; *i*, *Eucyrtidium Mongolfieri*; *k*, *Stephanolithis spinescens*; *l*, *S. nodosa*; *m*, *Lithocyelia ocellus*; *n*, *Cephalolithis sylvina*; *o*, *Podocyrtes cothurnata*; *p*, *Rhabdolithus pipa*.

403. Few Microscopic objects are more beautiful than an assemblage of the most remarkable forms of the Barbadian *Polycystina* (Fig. 270), especially when seen brightly illuminated upon a black ground; since (for the reason formerly explained, § 86) their solid forms then become much more apparent than they are

when these objects are examined by light transmitted through them. And when they are mounted in Canada Balsam, the Black-ground illumination, either by the Webster Condenser (§ 80), the Spot Lens (§ 84), or the Paraboloid (§ 85), is much to be preferred for the purpose of display, although minute details of structure can be better made-out when they are viewed as transparent objects with higher powers. Many of the more solid forms, when exposed to a high temperature on a slip of Platinum foil, undergo a change in aspect which renders them peculiarly beautiful as Opaque objects; their Glassy transparence giving place to an enamel-like opacity. They may then be mounted on a black ground, and illuminated either with a Side-Condenser, or with the Parabolic Speculum (§ 91).—No class of objects is more suitable than these to the Binocular Microscope; its Stereoscopic projection causing them to be presented to the mind's eye in complete relief, so as to bring-out with the most marvellous and beautiful effect all their delicate sculpture.*

404. ACANTHOMETRINA.—In this little group, which seems to form a connecting link between the *Polycystina* and *Sponges*, the animal is not enclosed within a shell, but is furnished with a very regular Skeleton composed of elongated spines, which radiate in all directions from a common centre (Plate XIX., fig. 3). The soft sarcode-body is spherical in form, and occupies the spaces left between the bases of these spines, which are sometimes partly enclosed (as in the species represented) by transverse projections. The Ectosarc seems to have a more definitely membranous consistence than in *Actinophrys*; but it is pierced by the pseudopodia, whose convergence may be traced from without inwards, after passing through it; and it is itself enveloped in a layer of less tenacious protoplasm, resembling that of which the pseudopodia are composed. The Endosarc contains a number of yellow cell-like globules, resembling those of *Thalassicollæ* (§ 336). As one species, the *Acanthometra echinoides*, is very common on some parts of the coast of Norway, especially during the prevalence of westerly winds, it might probably be found on the eastern coast of Britain, especially when easterly winds prevail. To the naked eye it presents itself as a crimson-red point: the diameter of the central part of its body being about 6-1000ths of an inch.

* The general Plan of Structure of the *Polycystina*, and the signification of their immense variety of forms, are ably discussed by Dr. Wallich, in the "Trans. of the Microsc. Society," N.S., Vol. xiii., p. 75: but no system of Classification can at present, in the Author's opinion, be regarded as otherwise than provisional. For a fuller description of the Fossil forms of this group, see Prof. Ehrenberg's Memoirs in the "Monatsberichte" of the Berlin Academy for 1846, 1847, and 1850; also his 'Microgeologie,' 1854; and "Ann. of Nat. Hist.," Vol. xx. (1847).—The best method of separating the *Polycystina* from the Barbadoes sandstone is described by Mr. Furlong in the "Quart. Journ. of Microsc. Science," New Ser., Vol. i. (1861), p. 64.

PLATE XIX.

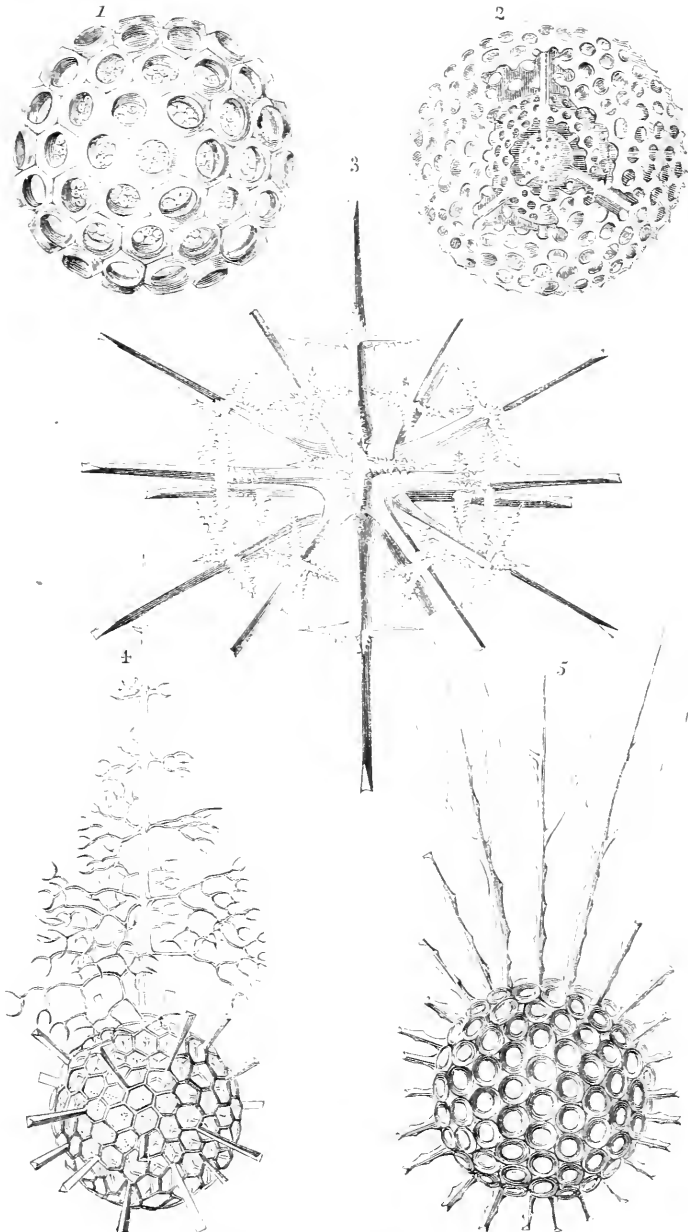

VARIOUS FORMS OF RADIOLARIA.

[To face p. 526.]



405. PORIFERA.—Although the tribe of *Sponges* has been banished from the Animal to the Vegetable kingdom, and back again, several times in succession, yet its claim to a place among the Protozoa may now be considered as pretty certainly determined, by the information derived from Microscopic examination of its minute structure. For the skeleton of the living Sponge, usually composed of a fibrous network strengthened by spicules of mineral matter, is clothed with a soft flesh; and this flesh has been found by Dujardin and all subsequent observers to consist of an aggregation of Amœba-like bodies (Fig. 271, B), some of which (as Dr.

FIG. 271.

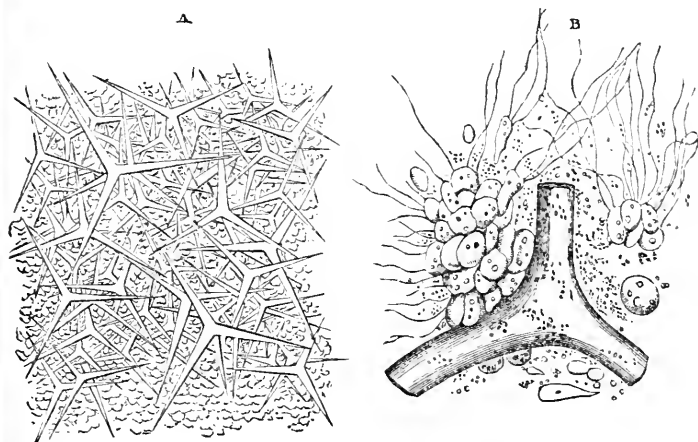

Structure of *Grantia compressa*:—A, portion moderately magnified, showing general arrangement of Triradiate Spicules and intervening tissue;—B, small portion highly magnified, showing Ciliated Cells.

Dobie was the first to show*) are furnished with one or more long cilia, closely resembling those of *Volvox* (Plate ix., fig. 9), by the agency of which a current of water is kept up through the passages and canals excavated in the substance of the mass. And from the observations of Mr. Carter† upon the early development of Sponges, it appears that they begin life as solitary *Amœbæ*; and that it is only in the midst of aggregations formed by the multiplication of these, that the characteristic *Sponge*-structure makes its appearance, the formation of Spicules being the first indication of such organization. The ciliated cells seem usually to form

* "Goodsir's Annals of Anatomy and Physiology," No. 2, May, 1852. See also Bowerbank, in "Transact. of Microsc. Society," First Series, Vol. iii. (1852), p. 137.

† "Annals of Natural History," Second Series, Vol. iv. (1849), p. 81.

the walls of special chambers lying at some distance beneath the surface ; and these communicate with a system of Canals by which the whole fabric of the Sponge is traversed. These Canals, which are very irregular in their distribution, may be said to commence in the small pores of the surface, and to terminate in the large vents ; and a current of water, maintained by the action of the cilia lining the chambers, is continually entering at the former, and passing-forth from the latter, during the whole life of the Sponge, bringing-in alimentary particles and oxygen, and carrying-out excrementitious matter.

406. The Skeleton which gives shape and substance to the mass of sarcode-particles that constitutes the living animal, is composed, in the Sponges with which we are most familiar, of an irregular reticulation of Horny fibres. The arrangement of these may be best made-out, by cutting thin slices of a piece of Sponge submitted to firm compression, and viewing these slices, mounted upon a dark ground, with a low magnifying power, under incident light. Such sections, thus illuminated, are not merely striking objects, but serve to show, very characteristically, the general disposition of the larger canals and of the smaller areolæ with which

FIG. 272.

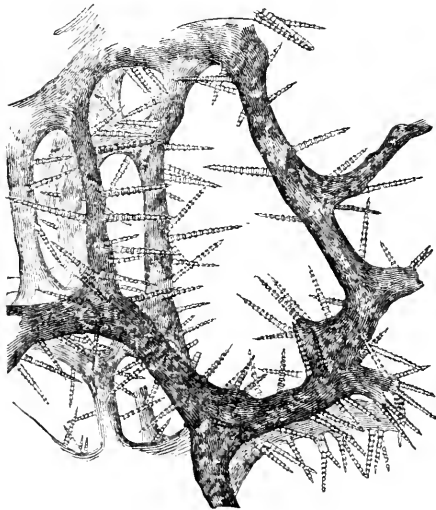

Portion of *Halichondria* (?) from Madagascar, with spicules projecting from the fibrous network.

they communicate. In the ordinary Sponge, the fibrous skeleton is almost entirely destitute of Spicules, the absence of which, in fact, is one important condition of that flexibility and compressibility on which its uses depend. When Spicules exist in connection with such a skeleton, they are either altogether imbedded in the fibres, or they are implanted into them at their bases, as shown in Fig. 272. In the curious and beautiful *Dactylocaliax pumiceus* of Barbadoes, however, the entire network of fibres is composed of

Silex, and is so transparent that it looks as if composed of spun glass. The same is the case in the wonderful *Euplectella* of the

Manilla Seas ; which, for some time one of the greatest of zoological rarities, has now been found in sufficient abundance to allow every Microscopist to acquaint himself with its beautiful structure.*—Another extraordinary production, which is probably to be referred to the same type, is the *Hyalonema*, originally brought from the Japan seas, but since found upon the coast of Portugal and elsewhere. This consists of “a bundle of from 2– to 300 threads of transparent Silica, glistening with a satiny lustre, like the most brilliant spun-glass ; each thread about *eighteen inches* long, in the middle of the thickness of a knitting-needle, and gradually tapering towards either end to a fine point ; the whole bundle coiled like a strand of rope into a lengthened spiral, the threads of the middle and lower portions remaining compactly coiled by a permanent twist of the individual threads ; the upper portions of the coil frayed out, so that the glassy threads stand separate from one another, like the bristles of a glittering brush ; the lower extremity of the coil imbedded perpendicularly in the middle of a hemispherical or conical undoubted Sponge, and usually part of the exposed portion of the siliceous coil and part of the sponge covered with a brown leathery coating, whose surface is studded with the Polypes of an equally undoubted Zoantharian Zoophyte.”†—There are many Sponges, on the other hand, in which no fibrous network can be discerned, the spicules lying imbedded in the midst of the sarcodemass ; such is the case in *Grantia* (Fig. 271 A), whose triradiate spicules are composed of Carbonate of Lime.—Sponge-spicules are much more frequently Siliceous than Calcareous ; and the variety of forms presented by the Siliceous spicules is much greater than that which we find in the comparatively small number of species in which they are composed of Carbonate of Lime. The long needle-like spicules (Fig. 273), which are extremely abundant in several Sponges, lying close together in bundles, are sometimes straight, sometimes slightly curved ; they are sometimes pointed at both ends, sometimes at one only ; one or both ends may be furnished with a head like that of a pin, or may carry three or more diverging points which sometimes curve-back so as to form hooks (Fig. 390, H). When the spicules project from the horny framework, they are usually somewhat conical in form, and their surface is often beset with little spines, arranged at regular intervals,

* See Prof. Owen in “Transact. of Zool. Soc.,” Vol. iii., p. 203, and in “Transact. of Linn. Soc.,” Vol. xxii., p. 117 ; Dr. J. E. Gray in “Popular Science Review,” Vol. vi., p. 239 ; and Mr. H. J. Slack in “Intellectual Observer,” Vol. xii., p. 161.

† See Prof. Wyville Thomson in the “Intellectual Observer,” Vol. xi., p. 81.—The nature of this organism has been the subject of much controversy, of which a *resumé* is given in the Paper just referred to. The Author agrees with Prof. Max Schultze and Prof. Wyville Thomson in regarding it as essentially a Sponge on which a Zoophyte is parasitic ; whilst Dr. J. E. Gray maintains that the ‘flint-rope’ is the stem of an Alcyonarian Zoophyte, and Dr. Bowerbank regards the whole as a Sponge, of which the so-called Polypes are the oscula.

giving them a jointed appearance (Fig. 272). Sponge-spicules frequently occur, however, under forms very different from the preceding; some being short and many-branched, and the branches being themselves very commonly stunted into mere tubercles (some

FIG. 273.

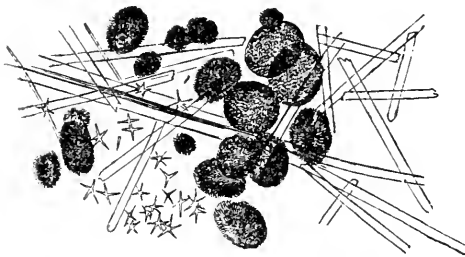
Siliceous Spicules of *Pachymatisma*.

examples of which type are presented in Fig. 403, A, c); whilst others are stellate, having a central body with conical spines projecting from it in all directions (as at D of the same figure). Great varieties present themselves in the stellate form, according to the relative predominance of the body and of the rays: in those represented in Fig. 273, the rays, though very numerous, are extremely short; in other instances the rays are much longer, and scarcely any central nucleus can be said to exist. The varieties in the form of Sponge-spicules are, in fact, almost endless; and a single sponge often presents two or more (as shown in Fig. 273), the *stellate* spicules usually occurring either in the inter-spaces between the elongated kinds, or in the external crust.* In one curious Sponge described by Mr. Bowerbank (the *Dusideia fragilis*), the spicules are for the most part replaced by particles of sand, of very uniform size, which are found imbedded in the horny fibre.—The Spicules of Sponges cannot be considered, like the Raphides of Plants (§ 293), simply as deposits of mineral matter in a crystalline state. For the forms of many of them are such as no mere crystallization can produce; many of them possess internal cavities, which contain organic matter; and the calcareous spicules, whose mineral matter can be readily dissolved-away by an acid, are found to have a distinct animal basis. Hence it seems probable that each spicule was originally a segment of Sarcodæ, which has undergone calcification or silicification, and by the self-shaping power of which the form of the spicule is mainly determined.

407. Of the Reproductive process in Sponges, much has yet to be learned:—the following is perhaps the most probable account

* A minute account of the various forms of spicules contained in Sponges is given by Mr. Bowerbank in his First Memoir 'On the Anatomy and Physiology of the Spongiadæ,' in "Philos. Transact.," 1858, pp. 279-332; and in his "Monograph of the British Spongiadæ" published by the Ray Society.

of it. Multiplication by Gemmation is effected by the detachment of minute globular particles of sarcode from the interior of the canals, where they sprout-forth as little protuberances, whose foot-stalks gradually become narrower and narrower until they give way altogether; these *gemmules*, like the zoospores of Algæ, possess cilia, and issuing-forth from the vents, transport themselves to distant localities, where they may lay the foundation of new fabrics. —But according to the observations of Mr. Huxley on the marine genus *Tethya*,* a true sexual Generation also takes-place; both ova and sperm-cells being found imbedded in the substance of the Sponge. The bodies distinguished as *capsules*, which are larger than the gemmules, and which usually have their investment strengthened with siliceous spicules very regularly disposed, are probably the products of this operation. They contain numerous globular particles of sarcode, every one of which, when set free by the rupture of its envelope, becomes an independent Amœba-like body, and may develope itself into a complete Sponge. The phenomena of Sexual reproduction and development have since been more particularly studied in the *Spongilla* or Fresh-water Sponge, especially by Carter† and Lieberkühn.‡

408. With the exception of those that belong to the genus *Spongilla*, all known Sponges are Marine; but they differ very much in habit of growth. For whilst some can only be obtained by dredging at considerable depths, others live near the surface, whilst others attach themselves to the surfaces of rocks, shells, &c., between the tide-marks. The various species of *Grantia*, in which alone of all the marine Sponges has Ciliary movement yet been seen, belong to this last category. They have a peculiarly simple structure, each being a sort of bag whose wall is so thin that no system of canals is required, the water absorbed by the outer surface passing directly towards the inner, and being expelled by the mouth of the bag. The cilia may be plainly distinguished with a 1-8th in. objective, on some of the cells of the gelatinous substance scraped from the interior of the bag; or they may be seen *in situ*, by making very thin transverse sections of the substance of the Sponge.§ It is by such sections alone that the internal structure of Sponges, and the relation of their spicular and horny

* 'On the Anatomy of the genus *Tethya*,' in "Ann. of Nat. Hist.," 2nd Ser., Vol. vii. (1851), p. 370.

† See his Memoirs 'On Zoosperms in *Spongilla*' in "Ann. of Nat. Hist.," 2nd Ser., Vol. xiv. (1854), p. 334, and 'On the Ultimate Structure of *Spongilla*,' in "Ann. of Nat. Hist.," 2nd Ser., Vol. xx. (1857), p. 21.

‡ See the Memoirs of Lieberkühn 'On the Development of the *Spongilla*,' in "Müller's Archiv." for 1856, and his 'New Researches on the Anatomy of Sponges' in "Reichert's und Du Bois Reymond's Archiv." for 1859. Abstracts of the former are contained in the "Annals of Nat. Hist.," 2nd Ser., Vol. xvii. (1856), p. 403, and in the "Quart. Journ. of Microsc. Science," Vol. v. (1857), p. 212.

§ See Dobie, loc. cit.; and Bowerbank, in "Trans. of Microsc. Soc.," 1st Ser., Vol. iii., p. 137.

Skeletons to their fleshy substance, can be demonstrated.—In order to obtain the Spicules in an isolated condition, however, the animal matter must be got-rid-of, either by incineration, or by chemical reagents. The latter method is preferable, as it is difficult to free the mineral residue from carbonaceous particles by heat alone. If (as is commonly the case) the spicules are Siliceous, the Sponge may be treated with strong nitric or nitro-muriatic acid, until its animal substance is dissolved away ; if, on the other hand, they be Calcareous, a strong solution of potass must be employed instead of the acid. The operation is more rapidly accomplished by the aid of heat ; but if the saving of time be not of importance, it is preferable on several accounts to dispense with it. The spicules, when obtained in a separate state, should be mounted in Canada balsam.—Sponge-tissue may often be distinctly recognized in sections of Agate, Chalcedony, and other Siliceous accretions, as will hereafter be stated in more detail (Chap. XIX.).

CHAPTER XI.

ZOOPHYTES.

409. THE term Zoophyte, although sometimes used in a wider signification, is properly restricted to the class of *Polypifera*, or Polype-bearing animals, whose composite skeletons or 'Polyparies' have more or less of a Plant-like form; even the *Polyzoa* (or Bryozoa) being now excluded, on account of their truly Molluscan structure (Chap. XIII.), notwithstanding the Zoophytic character of their forms and of their habits of life.—The true Zoophytes may be divided into two primary groups, the *Hydrozoa* and the *Anthozoa*; the *Hydra* (or Fresh-water Polype) standing as the type of the one, and the *Sea-Anemone* as the representative of the other. As most of the Hydrozoa are essentially Microscopic animals, they need to be described with some minuteness; whilst in regard to the Anthozoa those points only can be dwelt-on which are of special interest to the Microscopist.

410. The *Hydra* is to be searched-for in pools and ditches, where it is most commonly to be found attached to the leaves or stems of Aquatic Plants, floating pieces of stick, &c. Two species are common in this country, the *H. viridis* or Green Polype, and the *H. vulgaris*, which is usually Orange-brown, but sometimes yellowish or red (its colour being liable to some variation according to the nature of the food on which it has been subsisting); a third less common species, the *H. fusca*, is distinguished from both the preceding by the length of its tentacula, which in the former are scarcely as long as the body, whilst in the latter they are, when fully extended, many times longer (Fig. 274). The body of the Hydra consists of a simple bag or sac, which may be regarded as a Stomach, and which is capable of varying its shape and dimensions in a very remarkable degree; sometimes extending itself in a straight line so as to form a long narrow cylinder, at other times being seen (when empty) as a minute contracted globe, whilst, if distended with food, it may present the form of an inverted flask or bottle, or even of a button. At the upper end of this sac is a central opening, the Mouth, and this is surrounded by a circle of Tentacles or 'Arms,' usually from six to ten in number, which are

arranged with great regularity around the orifice. The body is prolonged at its lower end into a narrow base, which is furnished with a suctorial Disk; and the Hydra usually attaches itself by this, while it allows its tendril-like tentacula to

FIG. 274.

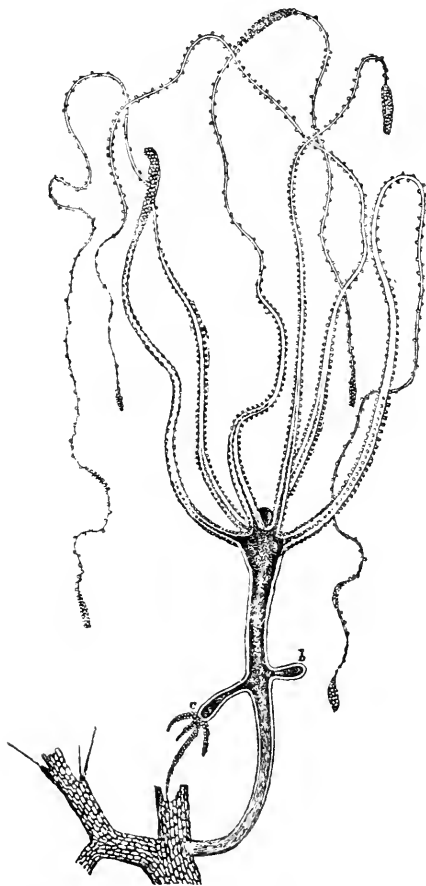

Hydra fusca, with a young bud at *b*, and a more advanced bud at *c*.

float freely in the water, like so many fishing-lines. The wall of the Body is composed of Cells imbedded in Sarcodesubstance; and it consists of two principal layers, an outer and more compact, of which the cells form a tolerably-even surface, and an inner that lines the Stomach, into the cavity of which some of the cells project. Between these layers there is a space chiefly occupied by undifferentiated Sarcodes, having many 'vacuoles' or 'lacunæ' (which often seem to communicate with one another) excavated in its substance. The Arms are made-up of the same materials as the body; but their surface is beset with little wart-like prominences, which, when carefully examined, are found to be composed of clusters of 'Thread-cells,' having a single large cell with a long

spiculum in the centre of each. The structure of these Thread-cells or 'Urticating organs' will be described hereafter (§ 428); at present it will be enough to point-out that this apparatus, repeated many times on each Tentacle, is doubtless intended to give

to the organ a great prehensile power ; the minute filaments forming a rough surface adapted to prevent the object from readily slipping out of the grasp of the arm, whilst the central spicule or 'dart' is projected into its substance, probably conveying into it a poisonous fluid secreted by a vesicle at its base. The latter inference is founded upon the oft-repeated observation, that if the living prey seized by the Tentacles have a body destitute of hard integument, as is the case with the minute Aquatic Worms which constitute a large part of its aliment, this speedily dies, even if, instead of being swallowed, it escapes from their grasp ; on the other hand, minute Entomostracous Crustacea, Insects, and other animals with hard envelopes, may escape without injury, even after having been detained for some time in the Polype's embrace. The contractility of the Tentacles (the interior of which is traversed by a canal which communicates with the cavity of the Stomach) is very remarkable, especially in the *Hydra fusca* ; whose Arms, when extended in search of prey, are not less than seven or eight inches in length ; whilst they are sometimes so contracted, when the stomach is filled with food, as to appear only like little tubercles around its entrance. By means of these instruments the Hydra is enabled to derive its subsistence from animals whose activity, as compared with its own slight powers of locomotion, might have been supposed to remove them altogether from its reach ; for when, in its movements through the water, a minute Worm or a Water-Flea happens to touch one of the tentacles of the Polype, spread-out as these are in readiness for prey, it is immediately seized by this, other arms are soon coiled around it, and the unfortunate victim is speedily conveyed to the Stomach, within which it may frequently be seen to continue moving for some little time. Soon, however, its struggles cease, and its outline is obscured by a turbid film, which gradually thickens, so that at last its form is wholly lost. The soft parts are soon completely dissolved, and the harder indigestible portions are rejected through the Mouth. A second orifice has been observed at the lower extremity of the Stomach ; but this would not seem to be properly regarded as Anal, since it is not used for the discharge of such exuvix ; it is probably rather to be considered as representing, in the Hydra, the entrance to that ramifying cavity, which, in the *Compound Hydrozoa*, brings into connection the lower extremities of the stomachs of all the individual Polyypes (Plate xx.). A striking proof of the simplicity of the structure of the *Hydra*, is the fact that it may be turned inside out like a glove ; that which was before its external Tegument becoming the lining of its Stomach, and *vice versa*.

411. The ordinary mode of Multiplication in this animal is by a Gemmation resembling that of Plants. Little bud-like processes (Fig. 274, b, c) are developed from its external surface, which are soon observed to resemble the parent in character, possessing a digestive sac, mouth, and tentacles ; for a long time, however,

their cavity is connected with that of the parent, but at last the communication is cut-off by the closure of the canal of the foot-stalk, and the young Polype quits its attachment and goes in quest of its own maintenance. A second generation of Buds is sometimes observed on the young Polype before quitting its parent ; and as many as *nineteen* young *Hydræ* in different stages of development have been thus connected with a single original stock (Fig. 275).

FIG. 275.

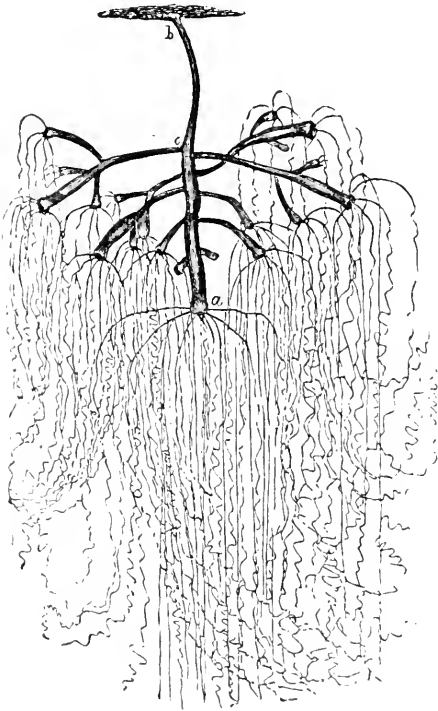

Hydra fusca in gemination ; a, mouth ; b, base ; c, origin of one of the buds.

Another very curious endowment seems to depend on the same condition,—the extraordinary power which one portion possesses of reproducing the rest. Into whatever number of parts a *Hydra* may be divided, each may retain its vitality, and give origin to a new and entire fabric ; so that *thirty* or *forty* individuals may be formed by the section of one.

412. The *Hydra* also propagates itself, however, by a truly Sexual process ; the fecundating apparatus, or vesicle producing Sperm-cells, and the Ovum (containing the Germ-cell, imbedded in a store of nutriment adapted for its early development) being both evolved in the substance of the walls of the Stomach, the former just

beneath the arms, the latter nearer to the lower end of the body. It would appear that sometimes one individual *Hydra* develops only the Male cysts or Sperm-cells, while another develops only the Female cysts or Ovisacs ; but the general rule seems to be that the same individual forms both organs. The fertilization of the Ova, however, cannot take-place until after the rupture of the Spermatic cyst and that of the Ovisac also ; so that the parent

has no further participation in it, than has the *Fucus* in the analogous fertilization of its germ-cells after their discharge (§ 258). Although the production, from such an egg, of a new *Hydra*, similar in all respects to its parent, has not yet been witnessed, there seems no reason to doubt the fact. It would seem that this alternation in the method of Reproduction, between the Gemmiparous and the Sexual, is greatly influenced by external temperature; the Eggs being produced at the approach of winter, and serving to regenerate the species in the spring, the parents not being able to survive the cold season; whilst the Budding-process naturally takes-place only during the warmer part of the year, but may be made to continue through the whole winter by keeping the water inhabited by the polypes at a sufficiently high temperature.—The *Hydra* possesses the power of free Locomotion, being able to remove from the spot to which it has attached itself, to any other that may be more suitable to its wants; its changes of place, however, seem rather to be performed under the influence of *light*, towards which the *Hydra* seeks to move itself, than with reference to the search after food.

413. Some of the simpler forms of the *Compound Hydrozoa* may be likened to a *Hydra* whose Gemmæ, instead of becoming detached, remain permanently connected with the parent; and as these in their turn may develop gemmæ from their own bodies, a structure of more or less arborescent character may be produced. The form which this will present, and the relation of the component Polypes to each other, will depend upon the mode in which the gemmation takes-place; in all instances, however, the entire cluster is produced by continuous growth from a single individual; and the stomachs of the several polypes are united by tubes, which proceed from the base of each, along the stalk and branches, to communicate with the cavity of the central stem.—This is the case with the family *Corynidae*, which are composite fabrics, sometimes quite arborescent in form, but unpossessed of any firm investment, the external wall being only strengthened by a thin horny cuticle. A very beautiful Marine species of this family (the *Coryne pusilla*) is common on Sea-weeds and stones between tide-marks; sometimes clustering parasitically round the stalks of *Tubularia* so as to form a thick beard-like mossiness; each aggregate structure, however, not being more than an inch in length. The Tentacles (as in Fig. 276, A) are short, and arise from the whole surface of the body of the polype, instead of from the margin of the mouth alone; and at first it seems difficult to understand how they can be of service in bringing food to the mouth, which is situated at the very extremity of the branch. Observation of the living animal, however, soon removes this difficulty; for the head is so very flexible, that the mouth can bend itself down towards any of the tentacles which may have entrapped prey, all its movements being performed in a very

leisurely manner. The Fresh-water genus *Cordylophora* has as yet been only found in a few localities; and the chief interest attaching to it is derived from the fact of its having been made

FIG. 276.

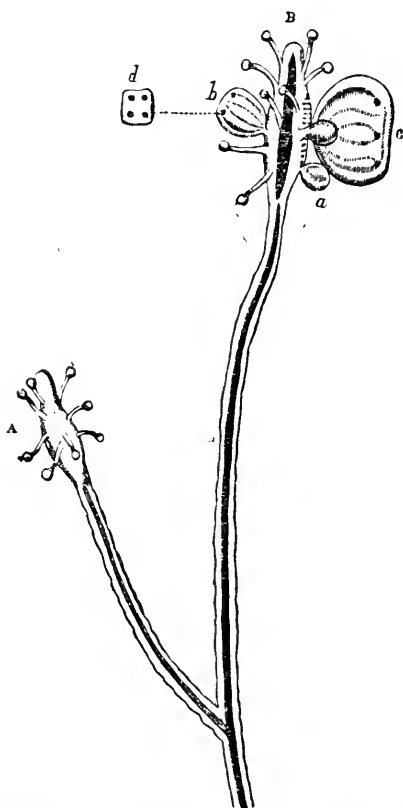

Development of Medusa-buds in *Syncoryna Sarsii*:—A, an ordinary Polype, with its club-shaped body covered with tentacles:—B, a Polype putting-forth Medusan gemmæ; a, a very young bud; b, a bud more advanced, the quadrangular form of which, with the four nuclei whence the cirrhi afterwards spring, is shown at d; c, a bud still more advanced.

polype-structure that bore it, just as the male (or Stamiferous) flower of the *Vallisneria spiralis* discharges its pollen upon the

the subject of an admirable Memoir by Prof. Allman,* to which every one should refer who desires to acquaint himself with the minute organization of this group of Zoophytes.

414. The phenomena of the Reproductive process exhibited by these Hydrozoa, are extremely curious. In *Coryne* and its allies, besides the ordinary Gemmation which extends the original fabric, certain Gemmæ are developed, which gradually come to present an organization altogether comparable to that of the simpler *Medusæ* (Fig. 276, B), and which, when detached, swim freely away. These stand in the same relation to the ordinary Polype-buds, as the Flower-buds of a Plant do to its Leaf-buds; each Medusa-bud containing either male or female Sexual organs, and performing its part in the Sexual act, after it has been set-free from the

* 'On the Anatomy and Physiology of *Cordylophora*,' in "Philosophical Transactions," 1853.

female (or Pistilline) flower, whilst floating on the surface of the water, after it has broken itself off from the stem. The Ova thus fertilized, being deposited by the free-swimming Medusa-buds, evolve themselves into single Polypes; and from every one of these is gradually produced by continuous gemmation a Composite fabric, which in its turn develops Medusa-buds, whose offspring resume the Polype-form.* In *Cordylophora*, instead of detached Medusa-buds, peculiar Capsules sprout-forth from the stem, some of which contain Sperm-cells and others Ova; and the spermatozoa set-free from the former enter the ovigerous capsules and fertilize their ova, after the fashion of *Vaucheria* (§ 246). The fertilized Ova undergo 'segmentation' according to the ordinary type (§ 476), the whole yolk-mass subdividing successively into 2, 4, 8, 16, 32 or more parts, until a 'Mulberry mass' is formed; this then begins to elongate itself, the surface becoming smooth, and showing a transparent margin; and this surface becomes covered with Cilia, by whose agency these little bodies, now called 'Gemmules,' first move-about within the capsule, and then swim forth freely when liberated by the opening of its mouth. At this period the Embryo can be made out to consist of an outer and an inner layer of cells, with a hollow interior; after some little time the cilia disappear, and one extremity becomes expanded into a kind of disk by which it attaches itself to some fixed object; a mouth is formed, and tentacles sprout forth around it; and the body increases in length and thickness, so as gradually to acquire the likeness of one of the parent Polypes, after which the Plant-like fabric characteristic of the genus is gradually evolved by the successive development of Polype-buds from the first-formed polype and its subsequent offsets.

415. In the Family *Tubularidæ*, the long Polype-stems are invested by tubular horny sheaths; but these stop-short below the polype-heads, which are consequently unprotected; and the reproductive Gemmæ bud-forth, as in the preceding case, from the base of the tentacles. The most common form of this Family is the *Tubularia indivisa*, which receives its specific name from the infrequency with which branches are given-off from the stems, these for the most part standing erect and parallel, like the stalks of corn, upon the base to which they are attached. This beautiful Zoophyte, which sometimes grows between the tide-marks, but is more abundantly obtained by dredging in deep water, often attains a size which renders it scarcely a microscopic object; its stems

* It is to this phenomenon that the term 'Alternation of Generations' has been applied. It is, however, an inappropriate designation; since the *Zoophyte* and the *Medusoid* are really the Vegetative and Reproductive portions of one and the same Organism; the only peculiarity of the case being that the Medusoid is here detached and leads an independent life. In many other *Hydrozoa* the Medusoid remains connected with the parent-fabric, to which its relation as the Generative Flower-bud then becomes obvious.

being sometimes no less than a foot in height and a line in diameter. Several curious phenomena, however, are brought into view by Microscopic examination. The Polype-stomach is connected with the cavity of the Stem by a circular opening, which is surrounded by a sphincter; and an alternate movement of dilatation and contraction takes-place in it, fluid being apparently forced-up from below, and then expelled again, after which the sphincter closes in preparation for a recurrence of the operation; this, as observed by Mr. Lister, being repeated at intervals of eighty seconds. Besides the foregoing movement, a regular flow of fluid, carrying with it solid particles of various sizes, may be observed along the whole length of the Stem, passing in a somewhat spiral direction, and a good deal resembling the rotation in *Chara* (§ 254).

416. The Reproductive process in this Family seems to be effected in various modes; and the true relation between them has not yet been clearly made-out. The Polype-stem sometimes puts-forth branches, at the termination of which new Polypes ultimately make their appearance, as in other Composite Hydrozoa; and in the genus *Eudendrium*, which is found on many parts of our coasts attached to old shells or stones dredged-up from deep water, a beautiful arborescent fabric from three to six inches high is thus formed. But around the Polype-heads in *Tubularia indivisa* are evolved Gemmæ of a different kind, which, like those of *Coryne*, have a Medusoid character, but do not detach themselves from the stem; within each of these are formed two ovoid bodies, which begin to develope themselves into the polype-form even before their escape from their containing cases, and soon fix themselves after their immersion, shooting-up into stems like those of the parent. In several Tubularidæ, however, the evolution of free Medusa-like buds, resembling those of *Syncoryne* (Fig. 276), has been observed.—It is worthy of mention here, that when a *Tubularia* is kept in confinement, the Polype-heads almost always drop-off after a few days, but are soon renewed again by a new growth from the stem beneath; and this exuviation and regeneration may take place many times in the same individual.

417. It is in the Families *Campanularidæ* and *Sertularidæ* (commonly known as 'Corallines') that the horny Polypary attains its completest development; not only affording an investment to the Stem, but forming cups or Cells for the protection of the polypes, as well as Capsules for that of the reproductive bodies. In the *Campanularidæ* the Polype-cells are campanulate or bell-shaped, and are borne at the extremities of ringed-stalks (Plate xx., c); in the *Sertularidæ*, on the other hand, the Polype-cells lie along the stem and branches, attached either to one side only, or to both sides (Fig. 277). In both, the general structure of the individual Polypes (Plate xx., d) closely corresponds with that of the *Hydra*; and the mode in which they obtain their food is essentially the same. Of the products of

PLATE XX.

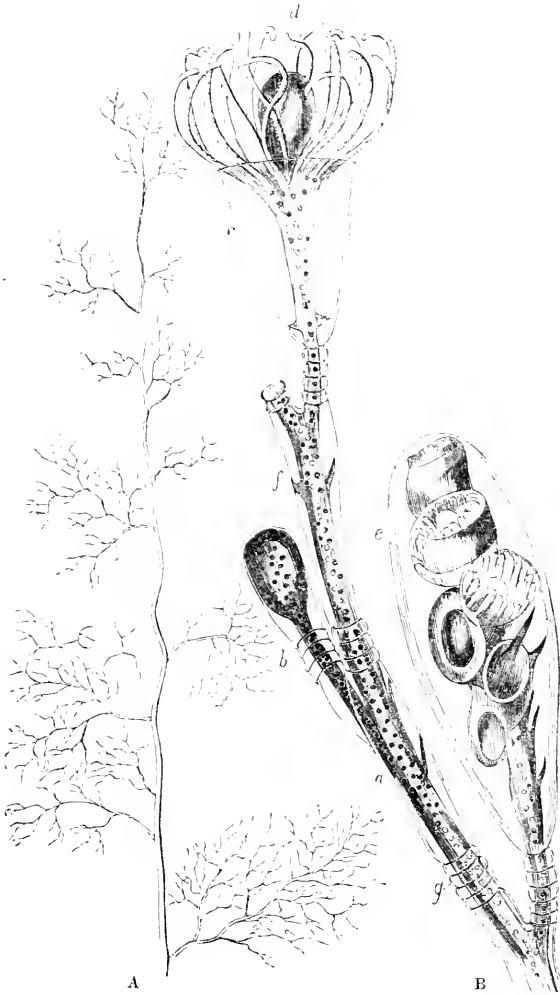

CAMPANULARIA GELATINOSA.

[To face p. 540.]

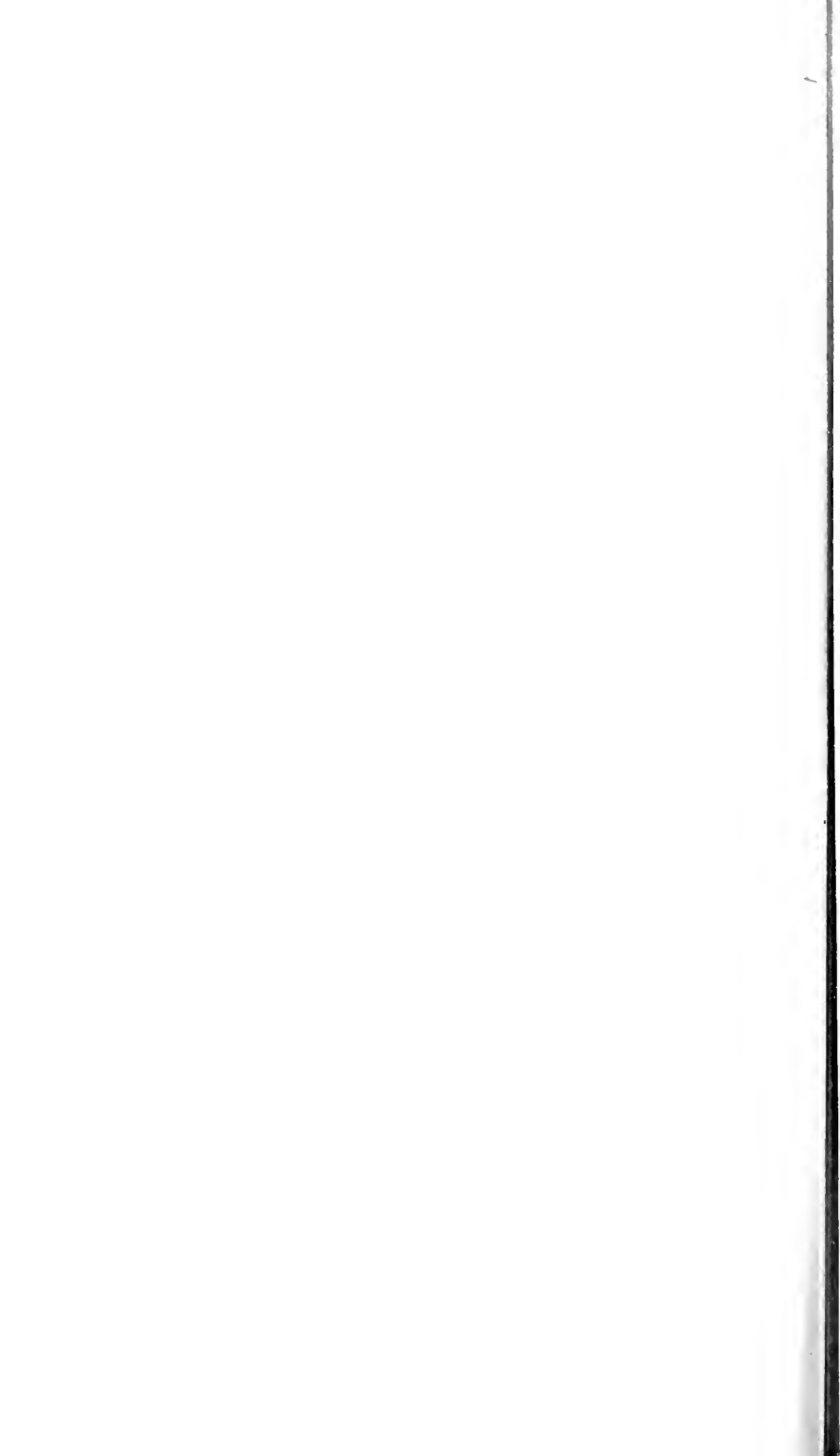

digestion, however, a portion finds its way down into the tubular Stem, for the nourishment of the general fabric ; and very much the same kind of circulatory movement can be seen in *Campanularia* as in *Tubularia*, the circulation being most vigorous in the neighbourhood of growing parts. It is from the soft flesh (*f*) contained in the Stem and branches, that new Polype-buds (*b*) are evolved ; these carry before them (so to speak) a portion of the horny integument, which at first completely invests the bud ; but as the latter acquires the organization of a Polype, the case thins-away at its most prominent part, and an opening is formed through which the young polype protrudes itself.

418. The origin of the bodies commonly but erroneously designated 'Ovarial Capsules' (*e*), is exactly similar ; but their destination is very different. Within them are evolved, by a budding process, the Generative organs of the Zoophyte : and these in the *Campanularidæ* may either develop themselves into the form of independent Medusoids, which completely detach themselves from the stock that bore them, make their way out of the capsule, and swim-forth freely, to mature their sexual products (some developing Spermatozoa, and others Ova) and give origin to a new generation of Polypes ; or, in cases in which the Medusan structure is less distinctly pronounced, may not completely detach themselves, but (like the Flower-buds of a Plant) expand one after another at the mouth of the capsule, withering and dropping-off after they have matured their generative products. In the *Sertularidæ*, on the other hand, the Medusan conformation is altogether wanting ; but the so-called Ovarial Capsules (Fig. 277), which have been shown by Prof. Ed. Forbes to be really metamorphosed branches, develop in their interior certain bodies which were formerly supposed to be Ova, but which are now known to be Medusoids reduced to their most rudimentary condition. Within these are developed, — in separate Capsules, sometimes perhaps on distinct Polyparies, — Spermatozoa and Ova ; and the latter are fertilized by the entrance of the former whilst still contained within their capsules. The fertilized Ova, whether produced in free or in attached Medusoids, develop themselves in the first instance into ciliated 'Gemmules,' which soon evolve themselves into true Polypes, from every one of which a new Composite fabric may spring.

419. There are few parts of our Coasts which will not supply some or other of the beautiful and interesting forms of Zoophytic life which have been thus briefly noticed, without any more trouble in searching for them than that of examining the surfaces of rocks, stones, sea-weeds, and dead shells between the tide-marks. Many of them habitually live in that situation ; and others are frequently cast-up by the waves from the deeper waters, especially after a storm. Many kinds, however, can only be obtained by means of the Dredge. For observing them during their living state, no means is so convenient as the Zoophyte Trough (§ 98), devised for

that express purpose by Mr. Lister, to whom we owe not only many improvements in the Microscope and its appurtenances, but also some of the earliest and best observations upon this class

FIG. 277.

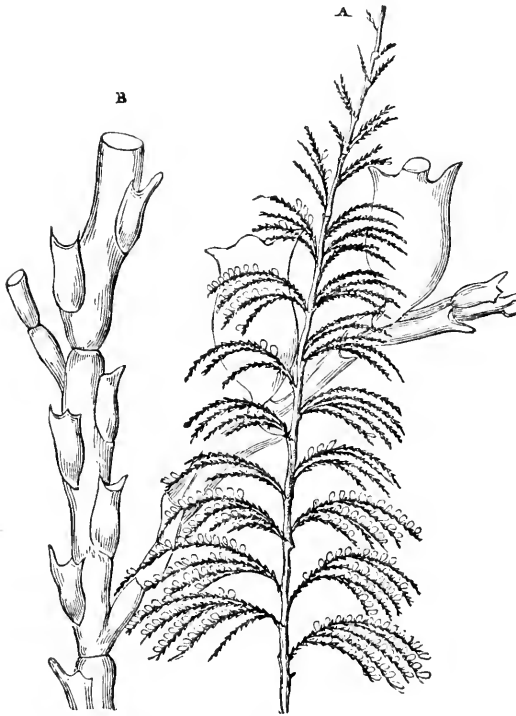

Sertularia cupressina :—A, natural size ; B, portion magnified.

of Zoophytes which the application of the Achromatic principle permitted.* In mounting Composite Hydrozoa, as well as Polyzoa, it will be found of great advantage to place the specimens alive in the Cells they are permanently to occupy, and to then add Alcohol drop by drop to the Sea-water ; this has the effect of causing the protrusion of the animals, and of rendering their tentacles rigid. The Alcoholized liquid may be withdrawn, and replaced by

Goadby's Solution, Deane's Gelatine, Glycerine Jelly, Weak Spirit, Diluted Glycerine, a mixture of Spirit and Glycerine with Sea-water, or any other menstruum, by means of the Syringe ; and it is well to mount specimens in several different menstrea, marking the nature and strength of each, as some forms are better preserved by one and some by another.† The size of the Cell must of course be proportioned to that of the object ; and if it be desired to mount such a specimen as may serve for a characteristic

* See his Memoir in the "Philosophical Transactions" for 1834.

† See Mr. J. W. Morris in "Quart. Journ. of Microsc. Science," N.S. Vol. ii. (1862), p. 116.

illustration of the mode of growth of the species it represents, the large shallow cells, whose walls are made by cementing four strips of glass to the plate that forms the bottom (§ 170), will generally be found preferable.

420. The horny Polyparies of the Sertularidæ, when mounted in Canada Balsam, are beautiful objects for the Polariscope; but in order to prepare them successfully, some nicety of management is required. The following are the outlines of the method recommended by Dr. Golding Bird, who very successfully practised it. The specimens selected, which should not exceed two inches in length, are first to be submitted, while immersed in water of 120° , to the vacuum of an Air-pump. The ebullition which will take-place within the cavities, will have the effect of freeing the Polyparies from dead Polypes and other animal matter; and this cleansing process should be repeated several times. The specimens are then to be dried, by first draining them for a few seconds on bibulous paper, and then by submitting them to the vacuum of an Air-pump, within a thick earthenware ointment-pot fitted with a cover, which has been previously heated to about 200° ; by this means the specimens are very quickly and completely dried, the water being evaporated so quickly that the cells and tubes hardly collapse or wrinkle. The specimens are then placed in Camphine, and again subjected to the exhausting process, for the displacement of the air by that liquid; and when they have been thoroughly saturated, they should be mounted in Canada Balsam in the usual mode. When thus prepared they become very beautiful transparent objects for low magnifying powers; and they present a gorgeous display of colours when examined by Polarized light, with the interposition of a plate of Selenite. These objects are peculiarly fitted for the use of the Polarizing Apparatus in combination with the Spot-Lens (§ 88); as they then exhibit all the richness of coloration which the former develops, with the peculiar solidity or appearance of projection which they derive from the use of the latter.

421. No result of Microscopic research has been more unexpected, than the discovery of the close relationship subsisting between the Hydroid *Zoophytes* and the Medusoid *Acalephæ* (or Jelly-fish.) We have seen that many of the small free-swimming Medusoids, belonging to that simple tribe of which *Thumantias* (Fig. 278) may be taken as a representative, are really to be considered as the detached Sexual apparatus of the Zoophytes from which they have been budded-off, endowed with independent organs of Nutrition and Locomotion, whereby they become capable of maintaining their own existence and of developing their Generative products. The general conformation of these organs will be understood from the accompanying figure. Many of this group are very beautiful objects for Microscopic examination, being small enough to be viewed entire in the Zoophyte-trough. There are some few parts of the coast

on which they may not be found, especially on a calm warm day, by skinning the surface of the sea with the Tow-net (§ 177); and they are capable of being well preserved in Goadby's Solution.

FIG. 278.

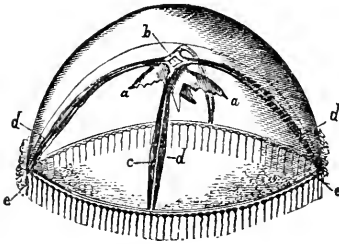

Thaumantias pilosella, one of the 'naked-eyed' Medusæ:—*a a*, Oral Tentacles; *b*, Stomach; *c*, Gastro-vascular Canals, having the Ovaries, *d d*, on either side, and terminating in the Marginal Canal, *e e*.

422. When we turn from these small and simple forms to the large and highly-developed *Medusæ* which are commonly known as 'Jelly-fish,' we find that their history is essentially similar; for their progeny have been ascertained to develop themselves in the first instance under the Polype-form, and to lead a life which in all essential respects is Zoophytic; their development into *Medusæ* taking-place only in the closing phase of their existence, and then rather by Gemmation from the original Polype, than by a metamorphosis of its own fabric. The Embryo emerges from the cavity of its parent, within which the first stages of its development have taken place, in the condition of a ciliated 'Gemmule,' of rather oblong form, very closely resembling an Infusory Animalcule, but destitute of a mouth. One end soon contracts and attaches itself, however, so as to form a foot; the other enlarges and opens to form a mouth, four tubercles sprouting around it, which grow into tentacles; whilst the central cells melt-down to form the cavity of the stomach. Thus a Hydra-like Polype is formed, which soon acquires many additional tentacles; and this, according to the observations of Sir J. G. Dalyell, leads in every important particular the life of a Hydra, propagates, like it, by repeated gemmation, so that whole colonies are formed as offsets from a single stock, and can be multiplied like it by artificial division, each segment developing itself into a perfect Hydra. There seems to be no definite limit to its continuance in this state, or to its power of giving origin to new Polype-buds; but under conditions not yet ascertained, the *Strobila* (as it is termed) ceases to propagate by ordinary gemmation, and enters upon an entirely new series of changes. In the first place, the body becomes more cylindrical in form than it previously was; then a constriction or indentation is seen around it, just below the ring which encircles the mouth and gives origin to the tentacles; and similar constrictions are soon repeated round the lower parts of the cylinder, so as to give to the whole body somewhat the appearance of a rouleau

of coins ; a sort of fleshy bulb, somewhat of the form of the original Polype, being still left at the attached extremity (Fig. 279, A). The number of circles is indefinite, and all are not formed at once, new constrictions appearing below, after the upper portions have been detached ; as many as 30 or even 40 have thus been produced in one specimen. The constrictions then gradually deepen, so as to divide the cylinder into a pile of saucer-like bodies ; the division being most complete above, and the upper disks usually presenting some increase in diameter : and whilst this is taking place, the edges of the disks become divided into lobes (B), each lobe soon presenting the cleft with the supposed rudimentary Eye (more probably an Auditory organ) at the bottom of it, which is to be plainly seen in the detached Medusæ (Fig. 280, c). Up to this period, the tentacles of the original Polype surmount the highest of the disks ; but before the detachment of the topmost disk this circle disappears, and a new one is developed at the summit of the bulb which remains at the base of the pile (c, c). At last the topmost and largest disk begins to exhibit a sort of

FIG. 279.

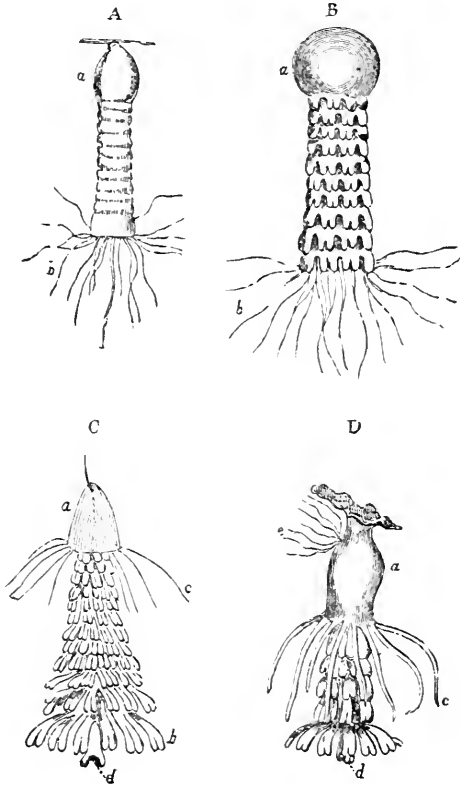

Successive Stages of Development of *Medusa-buds* from *Strobila-larva* :—*a*, Polype-body ; *b*, its original circle of Tentacles ; *c*, its secondary circle of Tentacles ; *d*, proboscis of most advanced *Medusa-disk* ; *e*, *Polype-bud* from side of Polype body.

convulsive struggle ; it becomes detached, and swims freely away ; and the same series of changes takes-place from above downwards, until the whole pile of disks is detached and converted into free-swimming Medusæ. But the original Polypoid body still remains ; and may return to its polype-like and original mode of gemmation (*d*, *e*), becoming the progenitor of a new colony of *Strobilæ*, every one of which may in its turn bud-off a pile of Medusa-disks.

423. The bodies thus detached have all the essential characters of the adult *Medusæ*. Each consists of an umbrella-like Disk, divided at its edge into a variable number of lobes, usually eight ; and of a Stomach, which occupies a considerable proportion of the disk, and projects downwards in the form of a Proboscis, in the centre of which is the quadrangular Mouth (Fig. 280, A, B). As

FIG. 280.

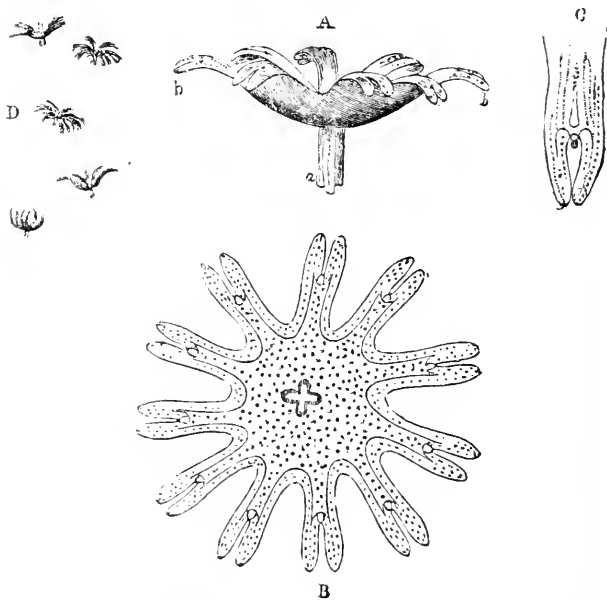

Development of *Medusæ* from detached gemmæ of *Strobilæ*.:—
 A, individual viewed sideways, and enlarged, showing the Proboscis *a*, and *b* the bifid lobes ; B, individual seen from above, showing the bifid lobes of the margin, and the quadrilateral Mouth ; *c*, one of the bifid lobes still more enlarged, showing the rudimentary Eye (?) at the bottom of the cleft ; D, group of young *Medusæ*, as seen swimming in the water, of the natural size.

the animal advances towards maturity, the intervals between the segments of the border of the disk gradually fill-up, so that the

divisions are obliterated ; tubular prolongations of the Stomach extend themselves over the disk ; and from its borders there sprout forth tendril-like filaments, which hang down like a fringe around its margin. From the four angles of the Mouth, which, even in the youngest detached animal, admits of being greatly extended and protruded, prolongations are put forth, which form the four large Tentacles of the adult. And finally the Generative organs make their appearance in four chambers disposed around the stomach, which are occupied by plaited membranous ribands containing Sperm-cells in the male and Ova in the female ; and the Embryoes evolved from the latter, when they have been fertilized by the agency of the former, repeat the extraordinary cycle of phenomena which has been now described, developing themselves in the first instance into Hydraform Polypes, from which Medusoids are subsequently budded-off.*

424. In connection with the preceding, it will be convenient to mention two curious little Marine animals of frequent occurrence, upon the true place of which in the scale Zoologists are not altogether agreed, but which, having the free-swimming habits, the soft texture, and the luminosity of the Medusæ, have been very commonly ranked as members of the same group. One of these is the *Cydippe pileus* (Fig. 281, A), very commonly known as the *Beroë*, which designation, however, properly appertains to another animal (B) of the same grade of organization. The body of *Cydippe* is a nearly-globular mass of soft jelly, usually about 3-8ths of an inch in diameter ; and it may be observed, even with the naked eye, to be marked by eight bright bands, which proceed from pole to pole like meridian lines. These bands are seen with the Microscope to be formed of rows of large flattened Cilia, which are in a state of pretty-constant vibration, though sometimes they are at rest ; and if the sun-light should fall upon them when they are in activity, they display very beautiful iridescent colours. The Mouth of the animal, situated at one of the poles, leads first to a quadrifid cavity bounded by four folds, which seem to the Author to represent the oral proboscis of the ordinary Medusæ (Fig. 278) ; and this leads to the true Stomach, which passes towards the opposite pole, near to which it bifurcates, its branches passing towards the polar surface on either side of a little body which has every appearance of being a Nervous ganglion, and which is surmounted externally by a fringe-like apparatus that

* Hence there is not a true ' Alternation of Generations ' in this case, any more than in the preceding (§ 414), the only difference between the two consisting in this,—that the *Zoophytic* phase of life is that which is most conspicuous in the *Campanularide* and *Tubularide* ; their Medusoids being small and rudimentary, and sometimes not being detached at all ; whilst in the Life-history of the ordinary Jelly-fish, the *Zoophytic* stage is passed in such obscurity as only to be detected by careful research, its Medusan product being that which becomes conspicuous.

seems essentially to consist of Sensory Tentacles.* From the cavity of the Stomach tubular prolongations pass-off beneath the ciliated bands, very much as in the true *Beroë* (B); these may easily be injected with coloured liquids, by the introduction of the

FIG. 281.

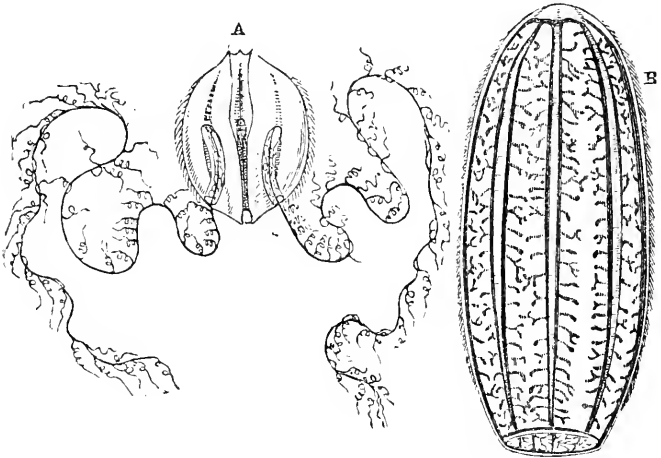

A, *Cydippe pileus* with its tentacles extended.--B, *Beroë Forskalii*, showing the tubular prolongations of the stomach.

extremity of a fine-pointed glass Syringe (Fig. 83) into the mouth. In addition to the bands of cilia, the *Cydippe* is furnished with a pair of Locomotive organs of a very peculiar kind; these are long Tendril-like filaments, arising from the bottom of a pair of cavities in the posterior part of the body, and furnished with lateral branches (A); within these cavities they are often doubled-up, so as not to be visible externally; and when they are ejected, which often happens quite suddenly, the main filaments first come-forth, and

* It is commonly stated that the two branches of the Alimentary Canal open on the surface by two pores situated in the hollow of the fringe, one on either side of the Nervous ganglion. The Author, however, has not been able to satisfy himself of the existence of such Excretory pores in the ordinary *Cydippe* or *Beroë*, although he has repeatedly injected their whole alimentary canal and its extensions, and has attentively watched the currents produced by Ciliary action in the interior of the bifurcating prolongations, which currents always appear to him to return as from Cæcal extremities. He is himself inclined to believe that this arrangement has reference solely to the nutrition of the Nervous ganglion and Tentacular apparatus, which lies imbedded (so to speak) in the bifurcation of the Alimentary Canal, so as to be able to draw its supply of nutriment direct from that cavity.

the lateral tendrils subsequently uncoil themselves, to be drawn-in again and packed-up within the cavities, with almost equal suddenness. The liveliness of this little creature, which may sometimes be collected in large quantities at once by the Tow-net, renders it a most beautiful subject for observation when due scope is given to its movements; but for the sake of Microscopic examination, it is of course necessary to confine these. Various species of true *Beroë*, some of them even attaining the size of a small Lemon, are occasionally to be met with on our coasts; in all of which the movements of the body are effected by the like agency of Cilia arranged in meridional bands. These are splendidly luminous in the dark, and the luminosity is retained even by fragments of their bodies, being augmented by agitation of the water containing them.

425. Very different, however, is the structure of another little globular jelly-like animal, the *Noctiluca miliaris* (Fig. 282), to

FIG. 282.

*Noctiluca miliaris.*

which the *diffused* Luminosity of the Sea, a beautiful phenomenon that is of very frequent occurrence on our shores, is chiefly attributable. This animal, much resembling in appearance a grain of boiled Sago, is just large enough to be discerned by the naked eye, when the water in which it may be swimming is contained in a glass jar exposed to the light; and a Tail-like appendage, marked with transverse rings, which is employed by the animal as an instrument of Locomotion, both for swimming and for pushing, may also be observed with a hand-glass. Near the point of its implantation in the body is a definite Mouth, on one side of which a projecting Tooth has been seen by Mr. Huxley; and this mouth

leads through a sort of Œsophagus into a large irregular cavity, apparently channelled-out in the jelly-like substance of the body, and therefore regarded by some in the light of a mere 'vacuole,' though by Mr. Huxley it is considered to possess regular walls and to be a true Stomach; whilst from its cavity there passes-forth a prolongation, which leads, in his belief, to a distinct Anal orifice.* The external coat is denser than the contained Sarcodæ; and the former sends thread-like prolongations through the latter, so as to divide the entire body into irregular chambers, in some of which 'vacuoles' are frequently to be seen. It seems to feed on Diatoms, as their *loricæ* may frequently be detected in its interior. This animal appears to multiply both by Subdivision and by Gemmation; † but nothing is yet known of its Sexual Generation; and until the mode in which it performs that important function shall have been made-out, and it shall have also been determined whether it passes through any other phase of existence, we are scarcely in a position to speak positively of its true affinities. So far as its character is at present known, its place would seem to be rather among the *Protozoa*, than in any more elevated group. The nature of its Luminosity is found by Microscopic examination to be very peculiar; for what appears to the eye to be a uniform glow, is resolvable under a sufficient magnifying power into a multitude of evanescent scintillations; and these are given-forth with increased intensity whenever the body of the animal receives any Mechanical shock, such as that produced by shaking the vessel or pouring out its contents, or is acted-on by various Chemical stimuli, such as dilute Acids, which, however, speedily exhaust the light-producing power, occasioning disorganization of the body.

426. *Anthozoa*.—This group, which constitutes the second great division of the Class of Zoophytes, includes all those larger forms, whose Polypes, when expanded, present the likeness of 'animal flowers:' and it consists of two principal subdivisions,—the *Asteroida* or Alcyonian Zoophytes, whose Polypes, having only six or eight broad short tentacles, present a star-like aspect when expanded,—and the *Helianthoida* or Actiniform Zoophytes, whose Polypes, having numerous tentacles disposed in several rows, bear a resemblance to Sunflowers or other Composite blossoms. Of the first of these orders, which contains no Solitary species, a characteristic example is found in the *Alcyonium digitatum* of our coasts, which is commonly known under the name of 'Dead-man's toes' or 'Sea-Paps.' When a specimen of this is first torn from the rock to which it has attached itself, it contracts into an unshapely mass, whose surface presents nothing but a series of slight depres-

* "Quart. Journ. of Microsc. Science," Vol. iii. (1855), p. 49; see also Dr. Webb, at p. 102, and Dr. Busch, at p. 199 of the same volume; and Gosse, in "Rambles on the Devonshire Coast," p. 257.

† See Brightwell in "Quart. Journ. of Microsc. Science," Vol. v. (1857), p. 185.

sions arranged with a certain regularity. But after being immersed for a little time in a jar of Sea-water, the mass swells-out again, and from every one of these depressions an eight-armed Polype is protruded, "which resembles a flower of exquisite beauty and perfect symmetry. In specimens recently taken, each of the petal-like tentacula is seen with a hand-glass to be furnished with a row of delicately-slender *pinnae* or filaments, fringing each margin, and arching outwards; and with a higher power, these *pinnae* are seen to be roughened throughout their whole length, with numerous prickly rings. After a day's captivity, however, the petals shrink up into short, thick, unshapely masses, rudely notched at their edges" (Gosse). When a mass of this sort is cut-into, it is found to be channelled-out, somewhat like a Sponge, by ramifying Canals; the vents of which open into the Stomachal cavities of the Polypes, which are thus brought into free communication with each other,—a character that especially distinguishes this Order. A movement of fluid is kept-up within these Canals, as may be distinctly seen through their transparent bodies, by means of Cilia lining the internal surfaces of the Polypes; but no cilia can be discerned on their external surfaces. The tissue of this spongy Polypidom is strengthened throughout, like that of Sponges (§ 406), with Mineral spicules (always, however, Calcareous), which are remarkable for the elegance of their forms: these are disposed with great regularity around the basis of the Polypes, and even extend part of their length upwards on their bodies. In the *Gorgonia* or Sea-fan, whilst the central part of the Polypidom is consolidated into a horny Axis, the soft flesh which clothes this axis is so full of tuberculated spicules, especially in its outer layer, that, when this dries-up, they form a thick yellowish or reddish incrustation upon the horny Stem; this crust is, however, so friable, that it may be easily rubbed down between the fingers, and, when examined with the Microscope, it is found to consist of Spicules of different shapes and sizes more or less resembling those shown in Figs. 283, 284, sometimes colourless, but sometimes of a beautiful crimson, yellow, or purple. These Spicules are best seen by the methods of Illumina-

FIG. 283.

Spicules of *Alcyonium* and *Gorgonia*.

tion that give a Black Ground, on which they stand out with great brilliancy, especially when viewed by the Binocular Microscope. They are, of course, to be separated from the Animal substance in the same manner as the Calcareous spicules of Sponges

(§ 408); and they should be mounted, like them, in Canada Balsam. — The Spicules always possess an Organic basis; as is proved by the fact, that when their lime is dissolved by dilute Acid, a gelatinous-looking residuum is left, which preserves the form of the spicule.

427. Of the order *Helianthoida*, the common *Actinia* or 'Sea-Anemone' may be taken as the type; the individual Polypes of all the

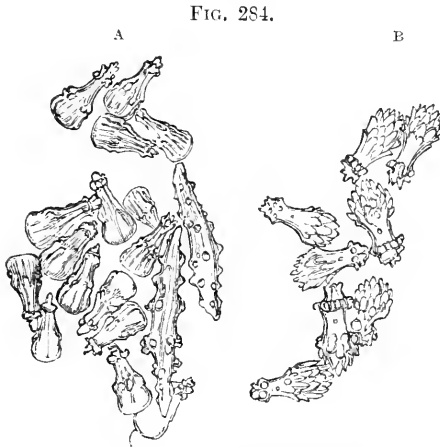

A, Spicules of *Gorgonia guttata*.
B, Spicules of *Muricea elongata*.

Composite fabrics included in the group being constructed upon the same model. In by far the larger proportion of these Zoophytes, the bases of the Polypes, as well as the soft flesh that connects-together the members of aggregate masses, are consolidated by Calcareous deposit into Stony Corals; and the surfaces of these are beset with cells, usually of a nearly-circular form, each having numerous vertical plates or *lamellæ* radiating from its centre towards its circumference, which are formed by the consolidation of the lower portions of the radiating partitions, that divide the space intervening between the Stomach and the general integument of the animal into separate chambers. This arrangement is seen on a large scale in the *Fungia* or 'Mushroom-Coral' of tropical seas, which is the stony base of a Solitary Anemone-like Polype; on a far smaller scale, it is seen in the little *Caryophyllia*, a like Solitary Polype of our own coasts, which is scarcely distinguishable from an *Actinia* by any other character than the presence of this disk, and also on the surface of many of those Stony Corals known as 'Madrepores;' whilst in some of these the individual Polype-cells are so small, that the lamellated arrangement can only be made-out when they are considerably magnified. Portions of the surface of such Corals, or sections taken at a small depth, are very beautiful objects for the lower powers of the Compound Microscope, the former being viewed by reflected and the

latter by transmitted light. And thin sections of various Fossil Corals of this group are very striking objects for the lower powers of the Oxyhydrogen Microscope.

428. The chief point of interest to the Microscopist, however, in the structure of these animals, lies in the extraordinary abundance and high development of those 'Filiferous Capsules,' or 'Thread-Cells,' the presence of which on the Tentacles of the Hydraform Polypes has been already noticed (§ 410), and which are also to be found, sometimes sparingly, sometimes very abundantly, in the Tentacles surrounding the mouth of the Medusæ, as well as on other parts of their bodies. If a Tentacle of any of the Sea-Anemones so abundant on our coasts (the smaller and more transparent kinds being selected in preference) be cut-off, and be subjected to gentle pressure between the two glasses of the Aquatic-Box or of the Compressorium, multitudes of little Dart-like organs will be

FIG. 285.

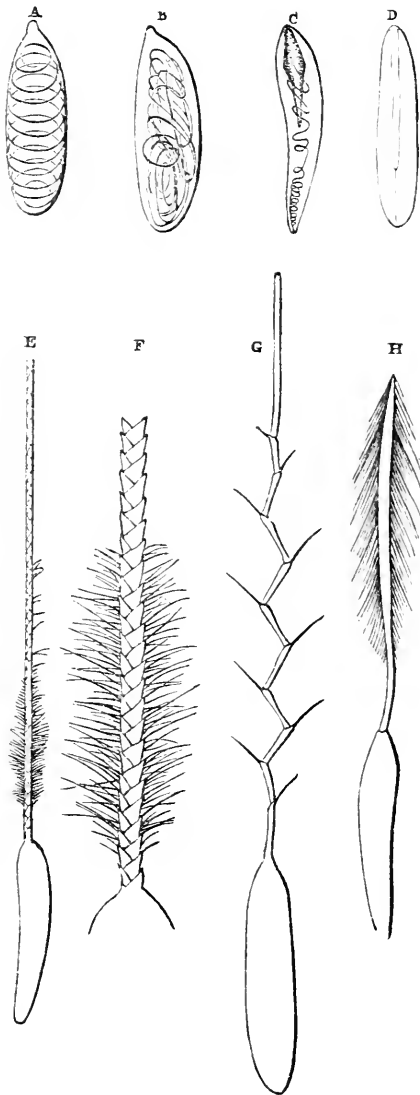

Filiferous Capsules of Helianthoid Polypes:—A, B, *Corynactis Allmanni*; C, E, F, *Caryophyllia Smithii*; D, G, *Actinia crassicornis*; H, *Actinia candida*.

seen to project themselves from its surface near its tip; and if the pressure be gradually augmented, many additional darts will every moment come into view. Not only do these organs present different forms in different species, but even in one and the same individual very strongly marked diversities are shown, of which a few examples are given in Fig. 285. At A, B, C, and D, is shown the appearance of the 'Filiferous capsules,' whilst as yet the thread lies coiled-up in their interior; whilst at E, F, G, H, are seen a few of the most striking forms which they exhibit when the thread or Dart has started-forth. The Thread-cells are found not merely in the Tentacles and other parts of the external integument of Helianthoid Zoophytes, but also in the long filaments which lie in coils within the chambers that surround the stomach, in contact with the Sexual organs which are attached to the lamellæ dividing the chambers. These sometimes contain Sperm-cells and sometimes Ova, the two sexes being here divided, not united, in the same individual.—What can be the office of the Filiferous filaments thus contained in the interior of the body, it is difficult to guess at. They are often found to protrude from rents in the external tegument, when any violence has been used in detaching the animal from its base; and when there is no external rupture, they are often forced through the wall of the Stomach into its cavity, and may be seen hanging out of the mouth. The largest of these Capsules, in their unprojected state, are about 1-300th of an inch in length; and the thread or Dart, in *Corynactis Allmanni*, when fully extended, is not less than 1-8th of an inch, or thirty-seven times the length of its capsule.*

* For the fullest description of these curious bodies, as well as for much other valuable information upon Zoophytes, see Mr. Gosse's "Naturalist's Rambles on the Devonshire Coast."—Those who may desire to acquire a more systematic and detailed acquaintance with this group, may be especially referred to the following Treatises and Memoirs, in addition to those already cited:—Dr. Johnston's "History of British Zoophytes," Prof. Milne-Edwards's "Recherches sur les Polypes," and his "Histoire des Coralliaires" (in the 'Suites à Buffon'), Paris, 1857, Prof. Van Beneden 'Sur les Tubulaires,' and 'Sur les Campanulaires,' in "Mém. de l'Acad. Roy. de Bruxelles," Tom. xvii., and his "Recherches sur l'Hist. Nat. des Polypes qui fréquentent les Côtes de Belgique," Op. cit. Tom. xxxvi., Sir J. G. Dalyell's "Rare and Remarkable Animals of Scotland," Vol. i., Trembley's "Mém. pour servir à l'histoire d'un genre de Polype d'Eau douce," M. Hollard's "Monographie du Genre *Actinia*," in "Ann. des Sci. Nat.," Sér. 3, Tom. xv., Mr. Mummery, 'On the development of *Tubularia indivisa*,' in "Trans. of Microsc. Soc.," 2nd Ser., Vol. i., p. 28; Prof. Max. Schultze, 'On the Male Reproductive Organs of *Campanularia geniculata*,' in "Quart. Journ. of Microsc. Sci.," Vol. iii. (1855), p. 59; Prof. Agassiz's beautiful Monograph on American Medusæ, forming the third volume of his "Contributions to the Natural History of the United States of America," and Prof. J. R. Greene's "Manual of the Sub-Kingdom *Calenterata*," which contains a Bibliography very complete to the date of its publication.

CHAPTER XII.

ECHINODERMATA.

429. As we ascend the scale of Animal life, we meet with such a rapid advance in complexity of structure, that it is no longer possible to acquaint one's-self with any organism by Microscopic examination of it as a whole; and the dissection or analysis which becomes necessary, in order that each separate part may be studied in detail, belongs rather to the Comparative Anatomist than to the ordinary Microscopist. This is especially the case with the *Echinus* (Sea-Urchin), *Asterias* (Star-fish), and other members of the class Echinodermata, even a general account of whose complex organization would be quite foreign to the purpose of this work. Yet there are certain parts of their structure which furnish Microscopic objects of such beauty and interest that they cannot by any means be passed by; besides which, recent observations on their Embryonic forms have revealed a most unexpected order of facts, the extension and verification of which will be of the greatest service to science,—a service that can only be effectually rendered by well-directed Microscopic research in fitting localities.

430. It is in the structure of that Calcareous Skeleton which probably exists under some form or other in every member of this class, that the Microscopist finds most to interest him. This attains its highest development in the *Echinida*; in which it forms a box-like Shell or 'Test,' composed of numerous polygonal plates jointed to each other with great exactness, and beset on its external surface with Spines, which may have the form of prickles of no great length, or may be stout club-shaped bodies, or, again, may be very long and slender rods. The intimate structure of the Shell is everywhere the same; for it is composed of a *network*, which consists of Carbonate of Lime with a very small quantity of Animal matter as a basis, and which extends in every direction (*i.e.*, in thickness as well as in length and breadth), its *Areolæ* or interspaces freely communicating with each other (Fig. 286). These 'Areolæ,' and the solid structure which surrounds them, may bear an extremely variable proportion one to the other; so that in two masses of equal size, the one or the other may greatly

predominate; and the texture may have either a remarkable lightness and porosity, if the network be a very open one like that of

FIG. 286.

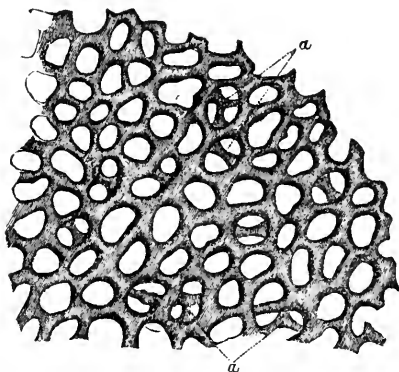

Section of Shell of *Echinus*, showing the calcareous network of which it is composed:—*a a*, portions of a deeper layer.

layers, it is easy, by properly 'focussing' the Microscope, to bring either one of them into distinct view. From this very simple but very beautiful arrangement, it comes to

FIG. 287.

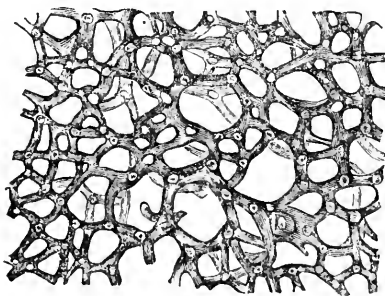

Transverse Section of central portion of Spine of *Acrocladia*, showing its more open network.

pass that the plates of which the entire 'Test' is made-up possess a very considerable degree of strength, notwithstanding that their porousness is such that if a portion of a fractured edge, or any other part from which the investing membrane has been removed, be laid upon fluid of almost any description, this will be rapidly sucked-up into its substance.—A very beautiful example of the same kind of Calcareous Skeleton, having a more regular conformation, is furnished by the Disk or Rosette which is contained in the tip of every one of the tubular Suckers put-forth by the living Echinus from the Ambulacral pores of its shell. If the entire Disk be cut-off, and be mounted when dry in Canada

Fig. 287, or may possess a considerable degree of compactness, if the solid portion be strengthened. Generally speaking, the different layers of this Network, which are connected together by pillars that pass from one to the other in a direction perpendicular to their plane, are so arranged that the perforations in one shall correspond to the intermediate solid structure in the next; and their transparence is such that when we are examining a section thin enough to contain only two or three such layers, it is easy, by properly 'focussing' the Microscope, to bring either one of them into distinct view. From this very simple but very beautiful arrangement, it comes to pass that the plates of which the entire 'Test' is made-up possess a very considerable degree of strength, notwithstanding that their porousness is such that if a portion of a fractured edge, or any other part from which the investing membrane has been removed, be laid upon fluid of almost any description, this will be rapidly sucked-up into its substance.—A very beautiful example of the same kind of Calcareous Skeleton, having a more

balsam, the Calcareous Rosette may be seen sufficiently well ; but its beautiful structure is better made-out when the Animal membrane that encloses it has been got-rid-of by boiling in a solution of Caustic Potass ; and the appearance of one of the five segments of which it is composed, when thus prepared, is shown in Fig. 288.

FIG. 288.

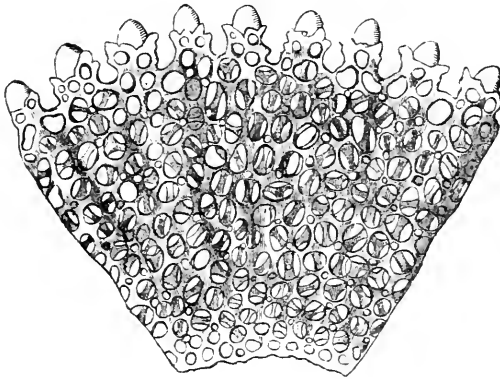

One of the segments of the Calcareous Skeleton of an Ambulacral Disk of *Echinus*.

431. The most beautiful display of this Reticulated structure, however, is shown in the structure of the 'Spines' of *Echinus*, *Cidaris*, &c.; in which it is combined with solid ribs or pillars, disposed in such a manner as to increase the strength of these organs ; a regular and elaborate pattern being formed by their intermixture, which shows considerable variety in different species. —When we make a thin Transverse Section (Plate II., fig. 1) of almost any Spine belonging to the genus *Echinus* (the small spines of our British species, however, being exceptional in this respect) or to its immediate allies, we are at once made aware of the existence of a number of Concentric Layers, arranged in a manner that strongly reminds us of the concentric rings of an Exogenous tree (Plate XII., fig. 3). The number of these Layers is extremely variable ; depending not merely upon the age of the Spine, but (as will presently appear) upon the part of its length from which the section happens to be taken. The centre is usually occupied by a very open network (Fig. 287) ; and this is bounded by a row of transparent spaces (like those at *a a'*, *b b'*, *c c'*, &c., Fig. 289), which on a cursory inspection might be supposed to be void, but which on a closer examination are found to be the sections of solid Ribs or Pillars, which run in the direction of the length of the Spine, and

form the exterior of every layer. Their solidity becomes very obvious, when we either examine a section of a Spine whose substance is pervaded (as often happens) with a Colouring matter of some depth, or when we look at a very thin section by the Black-Ground illumination. Around the innermost circle of these solid Pillars there is another layer of the Calcareous Network, which again is surrounded by another circle of solid pillars ; and this arrangement may be repeated many times, as shown in Fig. 289, the outermost

FIG. 289.

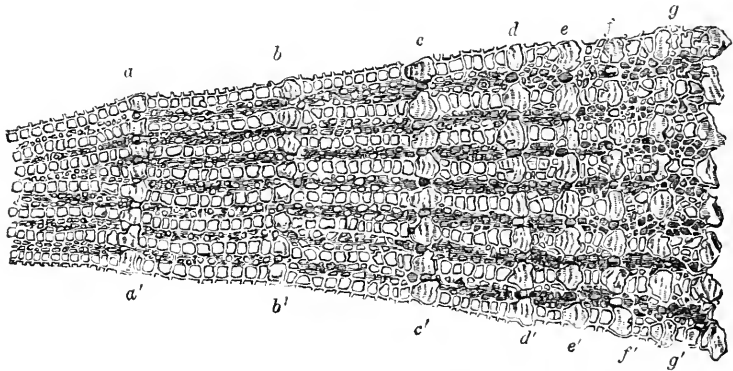
Portion of transverse section of Spine of *Acrocladia mammillata*.

row of pillars forming the projecting ribs that are very commonly to be distinguished on the surface of the Spine. Around the cup shaped base of the Spine is a membrane which is continuous with that covering the surface of the Shell, and which serves not merely to hold-down the Cup upon the Tubercle over which it works, but also by its contractility to move the Spine in any required direction. This membrane is probably continued onwards over the whole surface of the Spine, although it cannot be clearly traced to any distance from the base ; and the new formations may be presumed to take-place in its substance. Each new formation completely ensheaths the old ; not merely surrounding the part previously formed, but also projecting considerably beyond it ; and thus it happens that the number of Layers shown in a Transverse Section will depend in part upon the place of that section. For if it cross near the base, it will traverse every one of the successive layers from the very commencement ; whilst if it cross near the apex, it will traverse only the single layer of the last growth, notwithstanding that, in the club-shaped Spines, this terminal portion may be of considerably larger diameter than the basal ; and in any intermediate part of the Spine, so many layers will be traversed as have been formed since the spine first attained that length. The basal

portion of the Spine is enveloped in a reticulation of a very close texture, without concentric layers; forming the Cup or socket which works over the Tubercle of the Shell.

432. The combination of elegance of Pattern with richness of Colouring renders well-prepared specimens of these Spines among the most beautiful objects that the Microscopist can anywhere meet-with. The large spines of the various species of the Genus *Acrocladia* furnish sections most remarkable for size and elaborateness, as well as for depth of colour (in which last point, however, the deep purple spines of *Echinus lividus* are pre-eminent); but for exquisite neatness of pattern, there are no spines that can approach those of *Echinometra heteropora* (Plate II., fig. 1) and *E. lucunter*. The spines of *Heliocidaris variolaris* are also remarkable for their beauty.—No succession of concentric layers is seen in the spines of the British *Echini*, probably because (according to the opinion of the late Sir J. G. Dalyell) these Spines are cast-off and renewed every year; each new formation thus going to make an entire Spine, instead of making an addition to that previously existing.—Most curious indications are sometimes afforded by Sections of Echinus-spines, of an extraordinary power of Reparation inherent in these bodies. For irregularities are often seen in the transverse sections, which can be accounted-for in no other way than by supposing the Spines to have received an injury when the irregular part was at the exterior, and to have had its loss of substance supplied by the growth of new tissue, over which the subsequent layers have been formed as usual. And sometimes a peculiar ring may be seen upon the surface of a spine, which indicates the place of a complete fracture, all beyond it being a new growth, whose unconformableness to the older or basal portion is clearly shown by a longitudinal section.—The Spines of *Cidaris* present a marked departure from the plan of structure exhibited in Echinus; for not only are they destitute of concentric layers, but the calcareous Network which forms their principal substance is encased in a solid calcareous Sheath perforated with tubules, which seems to take the place of the separate pillars of the *Echini*. This is usually found to close-in the Spine at its tip also; and thus it would appear that the entire spine must be formed at once, since no addition could be made either to its length or to its diameter, save on the outside of the Sheath, where it is never to be found. The Sheath itself often rises up in prominent points or ridges on the surface of these spines; thus giving them a character by which they may be distinguished from those of *Echini*.—The slender, almost filamentary Spines of *Spatangus* (Fig. 290), and the innumerable minute Hair-like processes attached to the shell of *Clypeaster*, are composed of the like regularly-reticulated substance; and these are very beautiful objects for the lower powers of the Microscope, when laid upon a Black Ground and examined by reflected light without any further preparation.—It is interesting

also to find that the same structure presents itself in the curious *Pedicellariæ* (forceps-like bodies mounted on long stalks), which are found on the surface of many Echinida, and the nature of which was formerly a source of much perplexity to Naturalists, some maintaining that they are Parasites, whilst others considered them as proper appendages of the Echinus itself. The complete conformity

FIG. 290.

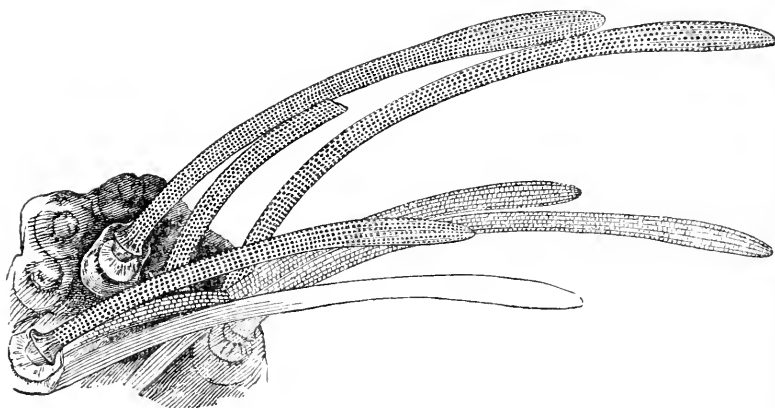
Spines of *Spatangus*.

which exists between the structure of their Skeleton and that of the animal to which they are attached, removes all reasonable doubt of their being truly appendages to it, as observation of their actions in the living state would indicate.*

433. Another example of the same structure is found in the peculiar framework of Plates which surrounds the interior of the Oral orifice of the shell, and which includes the five *Teeth* that may often be seen projecting externally through that orifice; the whole forming what is known as the 'Lantern of Aristotle.' The texture of the Plates or Jaws resembles that of the Shell in every respect, save that the network is more open: but that of the Teeth differs from it so widely, as to have been likened to that of the Bone and Dentine of Vertebrate animals. The careful investigations of Mr. James Salter,† however, have fully demonstrated that the appearances which have suggested this comparison are to be otherwise explained; the plan of structure of the *Tooth* being essentially the same as that of the *Shell*, although greatly modified in its working-

* See Dr. W. B. Herapath in "Quart. Journ. of Microsc. Science," Vol. v., N.S. (1865), p. 175.

† See his Memoir 'On the Structure and Growth of the Tooth of Echinus,' in "Philos. Transact." for 1861.

out. The complete Tooth has somewhat the form of that of the front tooth of a Rodent : save that its concave side is strengthened by a projecting 'keel,' so that a transverse section of the tooth presents the form of a **⊥**. This keel is composed of cylindrical rods of Carbonate of Lime having club-shaped extremities lying obliquely to the axis of the Tooth (Fig. 291, A, d) ; these rods do

FIG. 291.

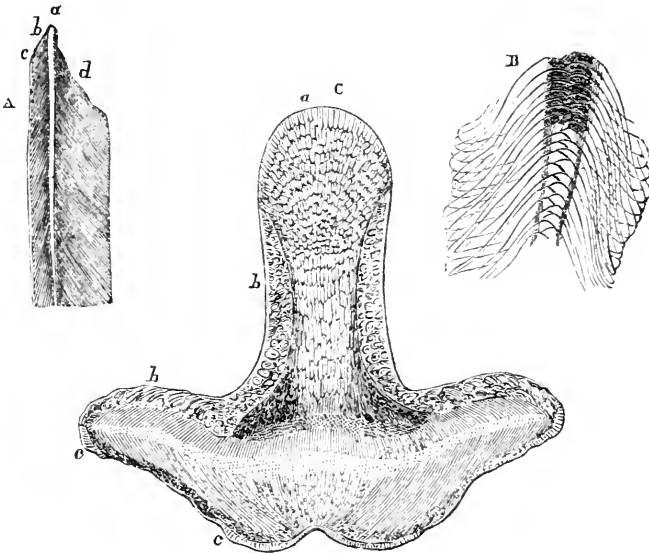

Structure of the Tooth of *Echinus*:—A, vertical section, showing the form of the apex of the Tooth as produced by wear, and retained by the relative hardness of its elementary parts ; *a*, the clear condensed axis ; *b*, the body formed of plates ; *c*, the so-called enamel ; *d*, the keel :—B, commencing growth of the Tooth, as seen at its base, showing its two systems of plates ; the dark appearance in the central portion of the upper part is produced by the incipient reticulations of the flabelliform processes :—*c*, transverse section of the Tooth, showing at *a* the ridge of the keel, at *b* its lateral portion, resembling the shell in texture ; at *c*, *c*, the enamel.

not adhere very firmly together, so that it is difficult to keep them in their places in making sections of the part. The convex surface of the Tooth (*c*, *c*, *c*) is covered with a firmer layer, which has received the name of 'Enamel ;' this is composed of shorter rods, also obliquely arranged, but having a much more intimate mutual adhesion than we find among the rods of the keel. The principal part of the substance of the Tooth (*A*, *b*) is made-up of what may

be called the 'primary plates;' these are triangular plates of calcareous Shell-substance, arranged in two series (as shown at B), and constituting a sort of framework with which the other parts to be presently described become connected. These plates may be seen by examining the growing base of an adult Tooth which has been preserved with its attached soft parts in Alcohol, or (which is preferable) by examining the base of the Tooth of a fresh specimen, the minuter the better. The lengthening of the Tooth below, as it is worn-away above, is mainly affected by the successive addition of new 'Primary Plates.' To the outer edge of the primary plates, at some little distance from the base, we find attached a set of lappet-like appendages, which are formed of similar plates of calcareous Shell-substance, and are denominated by Mr. Salter 'Secondary Plates.' Another set of appendages termed 'Flabelliform Processes' is added at some little distance from the growing base; these consist of elaborate reticulations of calcareous fibres, ending in fan-shaped extremities. And at a point still further from the base, we find the different components of the Tooth connected together by 'Soldering Particles,' which are minute Calcareous disks interposed between the previously-formed structures; and it is the increased development of this connective substance, which narrows the intervening spaces into the semblance of tubuli resembling those of Bone or Dentine. Thus a vertical section of the Tooth comes to present an appearance very like that of the *bone* of a Vertebrate animal, with its lacunæ, canaliculi, and lamellæ; but in a transverse section the body of the tooth bears a stronger resemblance to Dentine; whilst the keel and enamel-layer more resemble an oblique section of *Pinna* than any other form of Shell-structure. —It is interesting to remark that the gradational transition between the ordinary reticular structure of the Shell, and the dentine and enamel-like substance of the Tooth, which can only be traced in the adult Tooth of the *Echinus* by examining it near its base, is most distinctly presented by the tooth of *Ophiocoma*, which is so minute that it may be mounted in Balsam as a transparent object with scarcely any grinding-down, and which then shows that the basal portion of the Tooth is formed upon the open reticular plan characteristic of the 'Test,' but that this is so modified in the older portion by subsequent addition, that the upper part of the Tooth has the bone-like character of that of the tooth of *Echinus*.

434. The Calcareous Plates which form the less compact Skeletons of the *Asteriada* (Star-fish and their allies), and of the *Ophiurida* (Sand-stars and Brittle-stars), have the same texture as those of the shell of *Echinus*. And this presents itself, too, in the Spines or prickles of their surface, when these (as in the great *Goniaster equestris*) are large enough to be furnished with a Calcareous framework, and are not mere projections of the horny integument. An example of this kind, furnished by the *Astrophyton* (better known as the *Euryale*), is represented in Fig. 292.

The Spines with which the Arms of the species of *Ophiocoma* (Brittle-star) are beset, are often remarkable for their beauty of conformation; those of *O. rosula*, one of the most common kinds, might serve (as Prof. E. Forbes justly remarked), in point of lightness and beauty, as models for the Spire of a Cathedral. These are seen to the greatest advantage when mounted in Canada Balsam, and viewed by the Binocular Microscope with Black-ground illumination.

435. The Calcareous Skeleton is very highly developed in the *Crinoidea*; their stems and branches being made-up of a Calcareous network closely resembling that of the shell of the Echinus.

This is extremely well seen, not only in the Recent *Pentacrinus Caput Medusæ*, a somewhat rare animal of the West Indian seas, but also in a large proportion of the Fossil Crinoidea whose remains are so abundant in many of the older Geological formations; for notwithstanding that these bodies have been penetrated in the act of fossilization by a Mineral infiltration, which seems to have substituted itself for the original fabric (a regularly-crystalline cleavage being commonly found to exist in the Fossil Stems of *Encrinites*, &c., as in the Fossil Spines of *Echinida*), yet their Organic structure is often most perfectly preserved.* In the circular Stems of *Encrinites*, the texture of the Calcareous network is uniform, or nearly so, throughout; but in the pentangular *Pentacrini*, a certain figure or pattern is formed by variations of texture in different parts of the transverse section; and the patterns, though formed upon one general plan, are sufficiently diverse in different species to enable these to be recognized by the examination of a transverse section of a single joint of the Stem.

436. The minute structure of the Shells, Spines, and other solid parts of the Skeleton of Echinodermata can only be displayed by Thin Sections made upon the general plan already described

* The Calcareous Skeleton even of living Echinoderms has a Crystalline aggregation, as is very obvious in the more solid Spines of *Echinometra*, &c.; for it is difficult, in sawing these across, to avoid their tendency to cleavage in the oblique plane of Calcite. And the Author is informed by Mr. Sorby, that the Calcareous deposit which fills up the Areolæ of the Fossilized Skeleton has always the same Crystalline system with the Skeleton itself, as is shown not merely by the uniformity of their Cleavage, but by their similar action on Polarized Light.

FIG. 292.

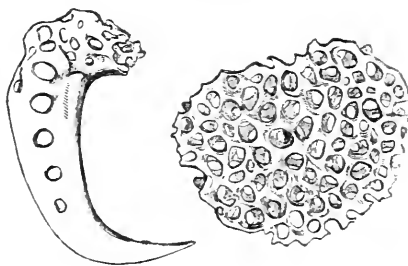

Calcareous plate and claw of *Astrophyton* (Euryale).

(§§ 138-140). But their peculiar texture requires that certain precautions should be taken ; in the first place, in order to prevent the section from breaking whilst being reduced to the desirable thinness ; and in the second, to prevent the interspaces of the network from being clogged by the particles abraded in the reducing process.—A section of the Shell, Spine, or other portion of the Skeleton should first be cut with a fine saw, and be rubbed on a flat file until it is about as thin as an ordinary card, after which it should be smoothed on one side by friction with water on a Water-of-Ayr stone. It should then be carefully dried, first on white blotting-paper, afterwards by exposure for some time to a gentle heat, so that no Water may be retained in the interstices of the network, which would oppose the complete penetration of the Balsam. Next, it is to be attached to a glass-slip by Balsam hardened in the usual manner ; but particular care should be taken, first, that the Balsam be brought to exactly the right degree of hardness, and second, that there be enough not merely to attach the specimen to the glass, but also to saturate its substance throughout. The right degree of hardness is that at which the Cement can be with difficulty indented by the thumb-nail ; if it be made harder than this, it is apt to chip-off the glass in grinding, so that the specimen also breaks away ; and if it be softer, it holds the abraded particles, so that the openings of the network become clogged with them. If, when rubbed-down nearly to the required thinness, the section appears to be uniform and satisfactory throughout, the reduction may be completed without displacing it ; but if (as often happens) some inequality in thickness should be observable, or some minute Air-bubbles should show themselves between the Glass and the under surface, it is desirable to loosen the specimen by the application of just enough heat to melt the Balsam (special care being taken to avoid the production of fresh air-bubbles), and to turn it over so as to attach the side last-polished to the Glass, taking care to remove or to break with the needle-point any Air-bubbles that there may be in the Balsam covering the part of the glass on which it is laid. The surface now brought uppermost is then to be very carefully ground down ; special care being taken to keep its thickness uniform through every part (which may be even better judged-of by the Touch than by the Eye), and to carry the reducing process far enough, without carrying it too far. Until practice shall have enabled the Operator to judge of this by passing his finger over the specimen, he must have continual recourse to the Microscope during the later stages of his work ; and he should bear constantly in mind that, as the specimen will become much more transparent when mounted in Balsam and covered with Glass, than it is when the ground surface is exposed, he need not carry his reducing process so far as to produce at once the entire transparence he aims at, the attempt to accomplish which would involve the risk of the

destruction of the specimen. In 'mounting' the specimen, liquid Balsam should be employed, and only a very gentle heat (not sufficient to produce air-bubbles, or to loosen the specimen from the glass) should be applied; and if after it has been mounted the section should be found too thick, it will be easy to remove the glass cover and to reduce it further, care being taken to harden to the proper degree the Balsam which has been newly laid-on.

437. If a number of Sections are to be prepared at once (which it is often useful to do for the sake of economy of time, or in order to compare sections taken from different parts of the same Spine), this may be most readily accomplished by laying them down, when cut-off by the saw, without any preliminary preparation save the blowing of the calcareous dust from their surfaces, upon a thick slip of glass well covered with hardened Balsam; a large proportion of its surface may thus be occupied by the Sections attached to it, the chief precaution required being that all the sections come into equally close contact with it. Their surfaces may then be brought to an exact level, by rubbing them down, first upon a flat piece of Grit (which is very suitable for the rough grinding of such sections), and then upon a large Water-of-Ayr stone whose surface is 'true.' When this level has been attained, the ground surface is to be well washed and dried, and some Balsam previously hardened is to be spread over it, so as to be sucked-in by the sections, a moderate heat being at the same time applied to the Glass slide; and when this has been increased sufficiently to loosen the sections without overheating the Balsam, the sections are to be turned-over, one by one, so that the *ground* surfaces are now to be attached to the Glass slip, special care being taken to press them all into close contact with it. They are then to be very carefully rubbed-down, until they are nearly reduced to the required thinness; and if, on examining them from time to time, their thinness should be found to be uniform throughout, the reduction of the entire set may be completed at once; and when it has been carried sufficiently far, the sections, loosened by warmth, are to be taken-up upon a camel-hair brush, dipped in Turpentine, and transferred to separate slips of Glass whereon some liquid Balsam has been previously laid, in which they are to be mounted in the usual manner. It more frequently happens, however, that, notwithstanding every care, the Sections, when ground in a number together, are not of uniform thickness, owing to some of them being underlaid by a thicker stratum of Balsam than others are; and it is then necessary to transfer them to separate slips before the reducing process is completed, attaching them with hardened Balsam, and finishing each Section separately.

438. A very curious *internal* Skeleton, formed of detached Plates or Spicules, is found in many members of this Class; often forming an investment like a Coat of Mail to some of the viscera, especially to the Ovaries. The forms of these plates and spicules

are generally so diverse, even in closely-allied Species, as to afford very good differential characters. This subject is one that has been as yet but very little studied, Mr. Stewart being the only Microscopist who has given much attention to it;* but it is well worthy of much more extended research.

439. It now remains for us to notice the curious and often very beautiful structures, which represent, in the order *Holothurida*, the solid Calcareous Skeleton of the orders already noticed. All the Animals belonging to this Order are distinguished by the flexibility and absence of firmness of their envelopes; and excepting in the case of certain species which have a set of Calcareous plates, supporting Teeth, disposed around the Mouth, very much as in the Echinida, we do not find among them any representation that is apparent to the unassisted eye, of that Skeleton which constitutes so distinctive a feature of the class generally. But a Microscopic examination of their Integument at once brings to view the existence of great numbers of minute isolated Plates, every one of them presenting the characteristic Reticulated structure, which are set with greater or less closeness in the substance of the Skin. Various forms of the Plates which thus present themselves in *Holothuria* are shown in Fig. 293; and at A is seen an oblique view of the

FIG. 293.

Calcareous plates in Skin of *Holothuria*.

kind marked *a*, more highly magnified, showing the very peculiar manner wherein one part is superposed on the other, which is not at all brought into view when it is merely seen-through in the ordinary manner.—In the *Synapta*, one of the long-bodied forms of this order, which abounds in the Adriatic Sea, and of which two species (the *S. digitata* and *S. inhaerens*) occasionally occur upon our own coasts, † the Calcareous plates of the integument have the regular

* See his Memoir in the "Linnæan Transactions," Vol. xxv. p. 365.

† See Woodward in "Proceedings of Zoological Society," July 13, 1858.

form shown at A, Fig. 294; and each of these carries the curious Anchor-like appendage, c, which is articulated to it by the notched piece at the foot, in the manner shown (in side view) at B. The Anchor-like appendages project from the surface of the skin, and

FIG. 294.

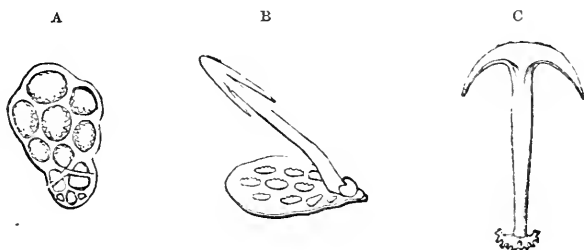

Calcareous Skeleton of *Synapta*:—A, plate imbedded in Skin; B, the same, with its anchor-like spine attached; c, anchor-like spine separated.

may be considered as representing the spines of Echinida.—Nearly allied to the *Synapta* is the *Chirodota*, the integument of which is entirely destitute of 'anchors,' but is furnished with very remarkable Wheel-like plates; those represented in Fig. 295 are found in the skin of *Chirodota violacea*, a species inhabiting the Mediterranean. These

FIG. 295.

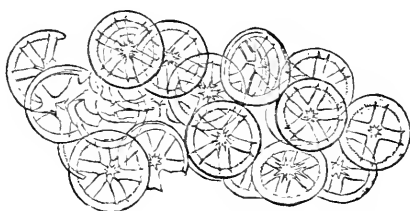

Wheel-like plates from Skin of *Chirodota violacea*.

Wheels are objects of singular beauty and delicacy, being especially remarkable for the very minute notching (scarcely to be discerned in the figures without the aid of a magnifying-glass) which is traceable round the inner margin of their

'tires.'—There can be scarcely any reasonable doubt that every member of this Order has some kind of Calcareous Skeleton, disposed in a manner conformable to the examples now cited; and it would be very valuable to determine how far the marked peculiarities by which they are respectively distinguished, are characteristic of Genera and Species. The plates may be obtained separately by the usual method of treating the Skin with a solution of

Potass; and they should be mounted in Canada Balsam. But their position in the Skin can only be ascertained by making sections of the Integument, both vertical and parallel to its surface; and these Sections, when dry, are most advantageously mounted in the same medium, by which their transparence is greatly increased. All the objects of this class are most beautifully displayed by the Black-Ground illumination (§§ 84-86); and their solid forms are seen with increased effect under the Binocular. The Black-Ground illumination applied to *very thin* sections of Echinus Spines brings out some effects of marvellous beauty; and even in these the solid form of the network connecting the pillars is better seen with the Binocular than it can be with the ordinary Microscope.*

440. *Echinoderm-Larvæ*.—We have now to notice that most remarkable set of objects furnished to the Microscopic inquirer by the Larval states of this class; for our present knowledge of which, imperfect as it still is, we are almost entirely indebted to the painstaking and widely-extended investigations of Prof. Müller. All that our limits permit is a notice of two of the most curious forms of these Larvæ, by way of sample of the wonderful phenomena which his researches have brought to light; so as (it may be hoped) to excite such an interest among those Microscopists in particular who may have the opportunity of pursuing these inquiries, as may induce them to apply themselves perseveringly to them, and thus to supply the numerous links which are at present wanting in the chain of Developmental history.—The peculiar feature by which the early history of the Echinoderms generally seems to be distinguished, is this,—that the Embryonic mass of cells is converted, not into a Larva which subsequently attains the adult form by a process of Metamorphosis, but into a peculiar *Zoid* or *Pseudembryo*, which seems to exist for no other purpose than to give origin to the Echinoderm by a kind of internal gemination, and to carry it to a distance by its active locomotive powers, so as to prevent the spots inhabited by the respective species from being overcrowded by the accumulation of their progeny. The Larval Zooids are formed upon a type quite different from that which characterizes the adults; for instead of a *radial* symmetry, they exhibit a *bilateral*, the two sides being precisely alike, and each having a ciliated fringe along the greater part or the whole of its length. The two fringes are united by a superior and an inferior transverse ciliated band; and between these two the mouth of the Zoid is always situated. Further, although the adult

* It may be here pointed out that the Reticulated appearance is sometimes deceptive; what seems to be a *solid* network being in many instances a *hollow* network of passages channelled-out in solid Calcareous substance. Between these two conditions, in which the relation between the solid framework and the intervening space is completely reversed, there is every intermediate gradation.

Star-fish and Sand-stars have usually neither Intestinal tube nor Anal orifice, their Larval Zooids, like those of other Echinoderms, always possess both. The external forms of these Larvæ, however, vary in a most remarkable degree, owing to the unequal evolution of their different parts; and there is also a considerable diversity in the several Orders, as to the proportion of the fabric of the Larva which enters into the composition of the Adult form. In the fully-developed Star-fish and Sea-urchin, the only part retained is a portion of the stomach and intestine, which is pinched-off, so to speak, from that of the Larval Zooid.

441. One of the most remarkable forms of Echinoderm Larvæ is that which has received the name of *Bipinnaria* (Fig. 296),

from the symmetrical arrangement of its natatory organs.

The Mouth (*a*), which opens in the middle of a transverse furrow, leads through an Œsophagus *a'* to a large Stomach, around which the body of a Star-fish is developing itself; and on one side of this mouth is observed the Intestinal tube and Anus (*b*). On either side of the anterior portion of the body are six or more narrow Fin-like appendages, which are fringed with Cilia; and the posterior part of the body is prolonged into a sort of pedicle, bilobed towards its extremity, which also is covered with Cilia. The organization of this Larva seems completed, and its move-

ments through the water become very active, before the mass at its anterior extremity presents anything of the aspect of the Star-fish; in this respect corresponding with the movements of the

FIG. 296.

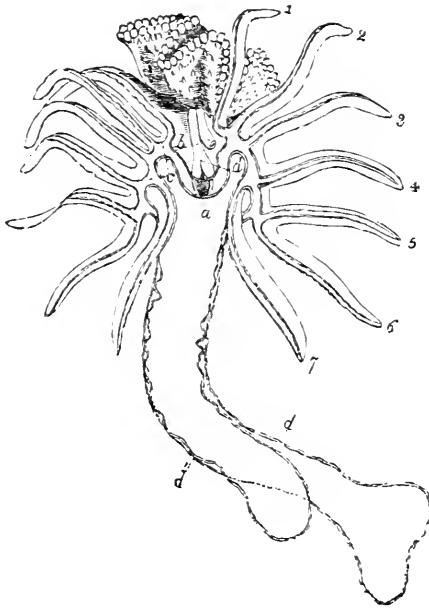

Bipinnaria asterigera, or Larva of Star-fish :
—*a*, Mouth; *a'*, Œsophagus; *b*, Intestinal tube
and Anal orifice; *c*, furrow in which the mouth
is situated; *d d'*, bilobed peduncle; 1, 2, 3, 4, 5,
6, 7, Ciliated Arms.

Pluteus of the Echinida (§ 442). The temporary Mouth of the Larva does not remain as the permanent mouth of the Star-fish; for the Œsophagus of the latter enters on what is to become the dorsal side of its body, and the true mouth is subsequently formed by the thinning-away of the integument on its ventral surface. The young Star-fish is separated from the Bipinnarian Larva by the forcible contractions of the connecting stalk, as soon as the Calcareous consolidation of its integument has taken-place and its true Mouth has been formed, but long before it has attained the adult condition; and as its ulterior development has not hitherto been observed in any instance, it is not yet known what are the species in which this mode of evolution prevails. The Larval Zooid continues active for several days after its detachment; and it is possible, though perhaps scarcely probable, that it may develop another Asteroid by a repetition of this process of gemination.*

442. In the Bipinnaria, as in other Larval Zooids of the Asterozoa, there is no internal Calcareous frame-work; such a frame-work, however, is found in the larvæ of the *Echinida* and *Ophiurida*, of which the form delineated in Fig. 297 is an example.† The Embryo issues from the Ovum as soon as it has attained, by repeated 'segmentation' of the Yolk (§ 476), the condition of the 'mulberry-mass;' and the superficial cells of this are covered with Cilia, by whose agency it swims freely through the water. So rapid are the early processes of development, that no more than from twelve to twenty-four hours intervene between Fecundation and the emersion of the Embryo; the division into two, four, or even eight segments taking-place within three hours after impregnation. Within a few hours after its emersion, the Embryo changes from the spherical into a sub-pyramidal form with a flattened base; and in the centre of this base is a depression, which gradually deepens, so as to form a Mouth that com-

* See the observations of Koren and Danielsen (of Bergen) in the "Zoologiske Ridrag," Bergen, 1847 (translated in the "Ann. des Sci. Nat.," Sér. 3, Zool., Tom. iii., p. 347; and the Memoir of Prof. Müller, 'Ueber die Larven und die Metamorphose der Echinodermen,' in "Abhandlungen der Königlichen Akademie der Wissenschaften zu Berlin," 1848.—Another very dissimilar mode of development in certain Star-fish was first described by Sars in his "Fauna littoralis Norvegiæ," 1846, and has been since investigated by Busch ("Beobachtungen über Anatomie und Entwicklung einiger Wirbelloser Seethiere," 1851), Prof. Müller ("Über den allgemeinen Plan in der Entwicklung der Echinodermen," 1853), and Prof. Wyville Thomson ('On the Embryology of *Asteracanthion violaceus*') in "Quart. Journ. of Microsc. Science," N.S., Vol. i. (1861), p. 99.

† See Prof. Müller, 'Ueber die Larven und die Metamorphose der Ophiuren und Seeigel,' in "Abhandlungen der Königlichen Akademie der Wissenschaften zu Berlin," 1846. See also, for the earlier stages, a Memoir by M. Derbès, in "Ann. des Sci. Nat.," Sér. 3, Zool., Tom. viii., p. 80; and for the later, Krohn's "Beitrag zur Entwicklungsgeschichte der Seeigellarven," Heidelberg, 1849, and his Memoir in "Müller's Archiv.," 1851.

municates with a cavity in the interior of the body, which is surrounded by a portion of the Yolk-mass that has returned to the

FIG. 297.

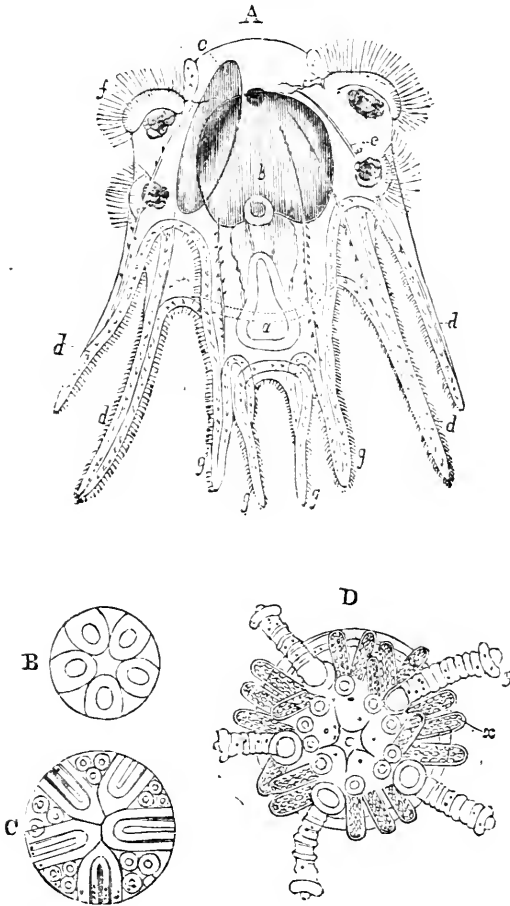

Embryonic development of *Echinus*.—A, *Pluteus-larva* at the time of the first appearance of the disk; a, Mouth in the midst of the four-pronged proboscis; b, Stomach; c, Echinoid disk; d, d, d, d, four arms of the *Pluteus*-body; e, Calcareous framework; f, Ciliated lobes; g, g, g, g, Ciliated processes of the proboscis;—B, Disk with the first indication of the Cirrhi;—C, Disk, with the origin of the Spines between the Cirrhi;—D, more advanced Disk, with the Cirrhi, g, and Spines, x, projecting considerably from the surface. (N.B.—In Figs. B, c, and D, the *Pluteus* is not represented, its parts having undergone no change, save in becoming relatively smaller.)

liquid granular state. Subsequently a short Intestinal tube is found, with an Anal orifice opening on one side of the body. The pyramid is at first triangular, but it afterwards becomes quadrangular; and the angles are greatly prolonged round the mouth (or base), whilst the apex of the pyramid is sometimes much extended in the opposite direction, but is sometimes rounded-off into a kind of dome (Fig. 297, A). All parts of this curious body, and especially its most projecting portions, are strengthened by a frame-work of thread-like Calcareous rods (*e*). In this condition the Embryo swims freely through the water, being propelled by the action of the Cilia, which clothe the four angles of the pyramid and its projecting arms, and which are sometimes thickly set upon two or four projecting lobes (*f*); and it has received the designation of *Pluteus*. The Mouth is usually surrounded by a sort of Proboscis, the angles of which are prolonged into four slender processes (*g, g, g, g*), shorter than the four outer legs, but furnished with a similar Calcareous frame-work.

443. The first indication of the production of the young Echinus from its 'Pluteus,' is given by the formation of a circular Disk (Fig. 297, A, *c*), on one side of the central Stomach (*b*); and this Disk soon presents five prominent tubercles (*b*), which subsequently become elongated into tubular Cirrhi. The Disk gradually extends itself over the Stomach, and between its cirrhi the rudiments of Spines are seen to protrude (*c*); these, with the Cirrhi, increase in length, so as to project against the envelope of the Pluteus, and to push themselves through it; whilst, at the same time, the original angular appendages of the Pluteus diminish in size, the Ciliary movement becomes less active, being superseded by the action of the cirrhi and spines, and the Mouth of the Pluteus closes-up. By the time that the Disk has grown over half of the gastric sphere, very little of the Pluteus remains, except some of the slender calcareous rods; and the number of cirrhi and spines rapidly increases. The Calcareous frame-work of the shell at first consists, like that of the Star-fishes, of a series of isolated networks developed between the Cirrhi; and upon these rest the first-formed Spines (*d*). But they gradually become more consolidated, and extend themselves over the granular mass, so as to form the series of plates constituting the Shell. The Mouth of the Echinus (which is altogether distinct from that of the Pluteus) is formed at that side of the granular mass over which the Shell is last extended; and the first indication of it consists in the appearance of the five calcareous concretions, which are the summits of the five portions of the frame-work of Jaws and Teeth that surround it. All traces of the original Pluteus are now lost; and the Larva, which now presents the general aspect of an Echinoid animal, gradually augments in size, multiplies the number of its Plates, Cirrhi, and Spines, evolves itself into its particular Generic and Specific type, and undergoes various changes of internal structure, tending to the development of the complete organism.—In collect-

ing the free-swimming Larvæ of Echinodermata, the Tow-net should be carefully employed in the manner already described (§ 177); and the search for them is of course most likely to be successful in those localities in which the Adult forms of the respective Species abound, and on warm calm days, in which they seem to come to the surface in the greatest numbers.*

444. One of the most interesting of all Echinodermata to the Microscopist is the *Antedon*† (more generally known as *Comatula*), or 'Feather-Star' (Fig. 298), which is the commonest existing

FIG. 298.

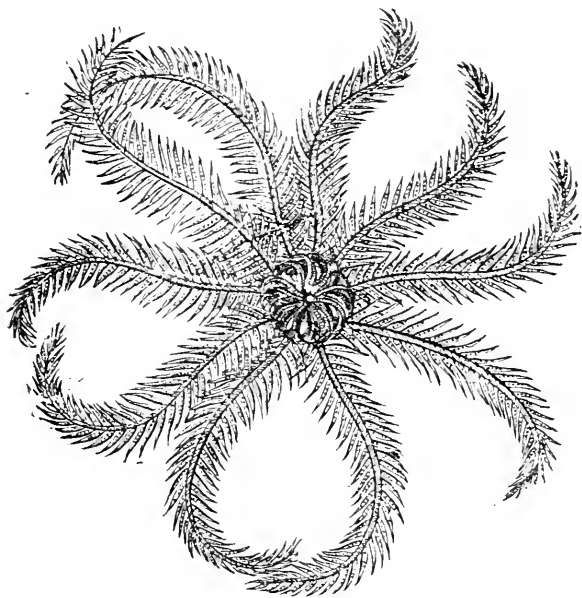

Antedon (Comatula) or Feather-star.

representative of the great Fossil series of *Crinoidea*, or Lily-Stars, that were among the most abundant types of this Class in the earlier epochs of the world's history. Like these, the

* The development of the *Holothurida* generally has been studied by Prof. Müller (see his Memoir in the "Berlin Transactions" for 1849); and that of *Synapta inharens*, by Prof. Wyville Thomson, in "Quart. Journ. of Micros. Science," N.S., Vol. ii. (1862), p. 105.

† The Author has found himself obliged by the accepted Rules of Zoological Nomenclature, to adopt the designation *Antedon*, instead of the much better known and very appropriate name given to this type by Lamarck. See his 'Researches on the Structure, Physiology, and Development of *Antedon rosaceus*, in "Philos. Transact." 1866, p. 671.

young of *Antedon* is attached by a stalk to a fixed base, as shown in Fig. 299; but when it has arrived at a certain stage of development, it drops-off from this like a fruit from its stalk; and the animal is thenceforth free to move through the Ocean-waters it inhabits. It can swim with considerable

Fig. 299.

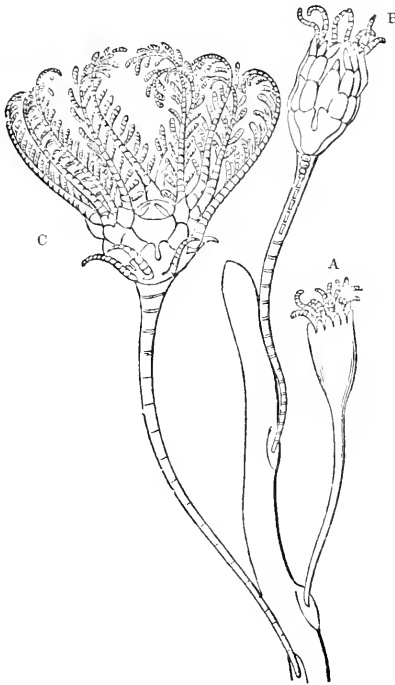

Crinoid Larva of *Antedon*:—A, B, C, successive stages of development.

activity; but it exerts this power chiefly to gain a suitable place for attaching itself by means of the jointed prehensile cirrhi put forth from the under side of the central disk (Fig. 298), so that, notwithstanding its locomotive power, it is nearly as stationary in its free adult condition, as it is in its earlier Pentacrinoid stage. The *Pentacrinoid Larva*,—first discovered by Mr. J. V. Thomson, of Cork, in 1823, but originally supposed by him to be a permanently-attached Crinoid,—forms a most beautiful object for the lower powers of the Microscope, when well preserved in fluid, and viewed by a strong incident light (Plate XXI., fig. 3); and a series of specimens in different stages of development shows most curious modifications in the form and arrangement of the various component pieces of its Calcareous skeleton. In its earliest stage (Fig. 299, A), the body is enclosed in a Calyx composed of two circles of plates; namely, five *basals*, forming a sort of pyramid whose apex points downwards, and is attached to the highest joint of the Stem; and five *orals* superposed on these, forming when closed a like pyramid whose apex points upwards, but usually separating to give passage to the *cirrhi*, of which a circlet surrounds the mouth. In this condition there is no rudiment of arms. In the more advanced stage shown at B, the Arms have begun to make their appearance; and the skeleton, when carefully examined, is found to consist of the following pieces, as shown in Plate XXI.,

activity; but it exerts this power chiefly to gain a suitable place for attaching itself by means of the jointed prehensile cirrhi put forth from the under side of the central disk (Fig. 298), so that, notwithstanding its locomotive power, it is nearly as stationary in its free adult condition, as it is in its earlier Pentacrinoid stage. The *Pentacrinoid Larva*,—first discovered by Mr. J. V. Thomson, of Cork, in 1823, but originally supposed by him to be a permanently-attached Crinoid,—forms a most beautiful object for the lower powers of the Microscope, when well preserved in fluid, and viewed by a strong incident light (Plate XXI., fig. 3); and a series of specimens in different stages of development shows most curious modifications in the form and arrangement of the various

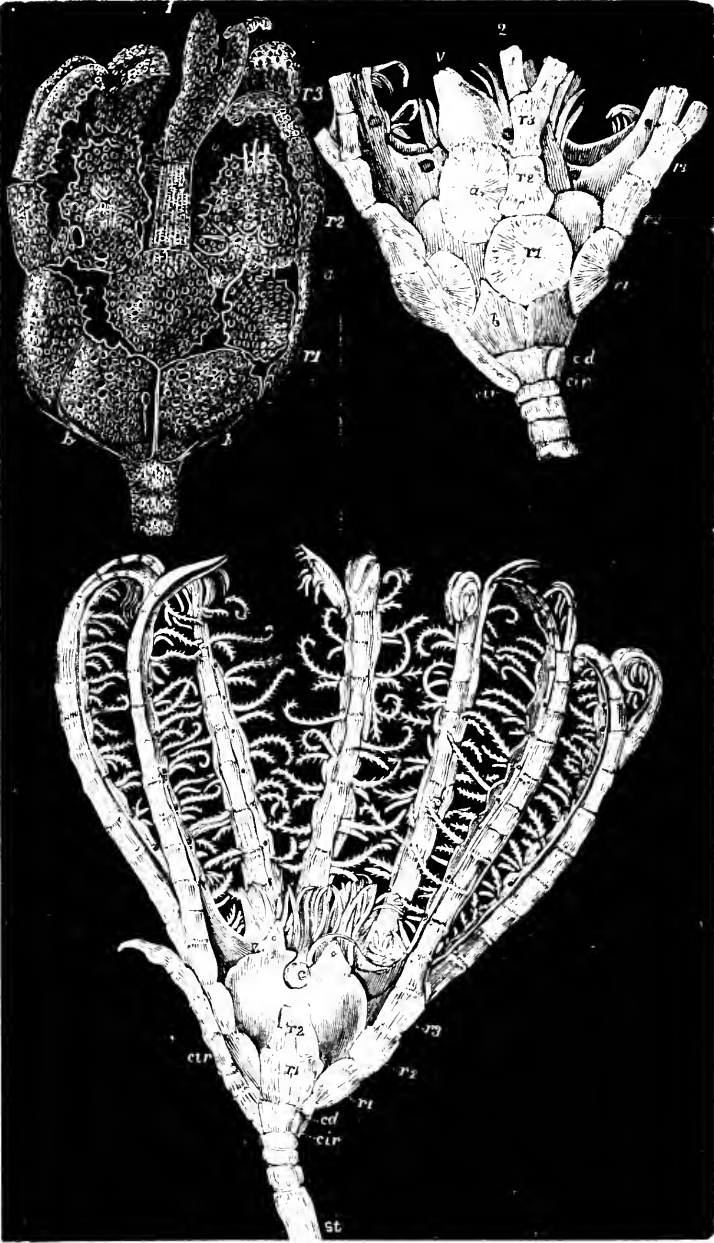

PENTACRINOID LARVA OF ANTEDON.

[To face p. 575.]

fig. 1 :—*b*, *b*, the circlet of *basals* supported on the top of the Stem ; *r*¹, the circlet of *first radials*, now interposed between the *basals* and the *orals*, and alternating with both ; between two of these is interposed the single *anal plate*, *a* ; whilst they support the *second* and the *third radials* (*r*², *r*³), from the latter of which the bifurcating Arms spring ; finally, between the *second radials* we see the five *orals*, lifted from the *basals* on which they originally rested, by the interposition of the *first radials*. In the more advanced stage shown in Fig. 299, c, and on a larger scale in Plate XXI., figs. 2, 3, we find the highest joint of the Stem beginning to enlarge, to form the *centro-dorsal plate* (Fig. 2, *cd*), from which are beginning to spring the dorsal cirrhi (*cir*), that serve to anchor the animal when it drops from the stem ; this supports the *basals* (*b*), on which rest the *first radials* (*r*¹) ; whilst the *anal plate* (*a*) is now lifted nearly to the level of the *second radials* (*r*²), by the development of the *anal funnel* or vent (*v*) to which it is attached. The *oral plates* are not at first apparent, as they no longer occupy their first position ; but on being carefully looked-for, they are found still to form a circlet around the mouth (Fig. 3, *o*, *o*), not having undergone any increase in size, whilst the *Visceral Disk* and the *Calyx* in which it is lodged have greatly extended. These *oral plates* finally disappear by absorption ; while the *basals* are at first concealed by the great enlargement of the *Centro-dorsal* (which finally extends so far as to conceal the *first radials* also), and at last undergo metamorphosis into a beautiful 'rosette' which lies between the cavity of the *centro-dorsal*, and that of the *calyx*.—In common with other members of its Class, the *Antedon* is represented in its earliest phase of development by a free-swimming Larval Zooid or *Pseudembryo*, which was first observed by Busch, but has recently been most carefully studied by Prof. Wyville Thomson. This Zooid has an elongated egg-like form, and is furnished with transverse bands of Cilia, and with a Mouth and Anus of its own. After a time, however, rudiments of the *Calcareous plates* forming the Stem and *Calyx* begin to show themselves in its interior ; a disk is then formed at the posterior extremity, by which it attaches itself to a Sea-Weed (very commonly *Laminaria*), Zoophyte, or Polyzoary ; the *Calyx*, containing the true Stomach, with its central mouth surrounded by Tentacles, is gradually evolved ; and the sarcode substance of the *Pseudembryo*, by which this *Calyx* and the rudimentary Stem were originally invested, gradually shrinks, until the young *Pentacrinoid* presents itself in its characteristic form and proportions.*

* See Prof. Wyville Thomson's Memoir 'On the Development of *Antedon rosaceus*' in the "Philos. Transact." for 1865, p. 513.—The *Pentacrinoid Larvæ* of *Antedon* have been found abundantly at Millport, on the Clyde, and in Lamlash Bay, Arran ; in Kirkwall Bay, Orkney ; in Lough Strangford near Belfast, and in the Bay of Cork ; and at Ilfracombe, and in Salcombe Bay, Devon.

CHAPTER XIII.

POLYZOA AND TUNICATA.

At the lower extremity of the great series of Molluscous animals, we find two very remarkable groups, whose mode of life has much in common with Zoophytes, whilst their type of structure is conformable in all essential particulars to that of the true Mollusks. These animals are for the most part microscopic in their dimensions; and as some members of both these groups are found on almost every coast, and are most interesting objects for anatomical examination as well as for observation in the living state, a brief general account of them will be here appropriate.

445. POLYZOA.—The group which is known under this name to British naturalists, corresponds with that which by Continental Zoologists is designated *Bryozoa*: the former name (though first used in the singular instead of the plural number), as having been introduced by Mr. J. V. Thompson in a memoir published in 1830, seems to have precedence in point of time over the latter, which was conferred by Prof. Ehrenberg in 1831 on a most heterogeneous group, wherein the Bryozoa, as now limited, were combined with the Foraminifera. It has been entirely by Microscopic research that the *Polyzoa* have been raised from the Class of Zoophytes (in which they were formerly ranked, for the most part in apposition with the Hydrozoa), to the Molluscan Sub-kingdom; whilst the *Foraminifera* have been remitted, by the more careful study of their living forms, to the very lowest division of the Animal Kingdom. The animals of the Polyzoa, in consequence of their universal tendency to multiplication by gemmation, are seldom or never found solitary, but form clusters or colonies of various kinds; and as each is enclosed in either a Horny or a Calcareous sheath or 'Cell,' a composite structure is formed, closely corresponding with the Polypidom of a Zoophyte, which has been appropriately designated the *Polyzoary*. The individual Cells of the Polyzoary are sometimes only connected with each other by their common relation to a creeping stem or *Stolon*, as in *Laguncula* (Plate XXII.); but more frequently they bud-forth directly, one from another, and extend themselves in different directions over

plane surfaces, as is the case with *Flustra*, *Lepralica*, &c. (Fig. 300); whilst not unfrequently the Polyzoary develops itself into

FIG. 300.

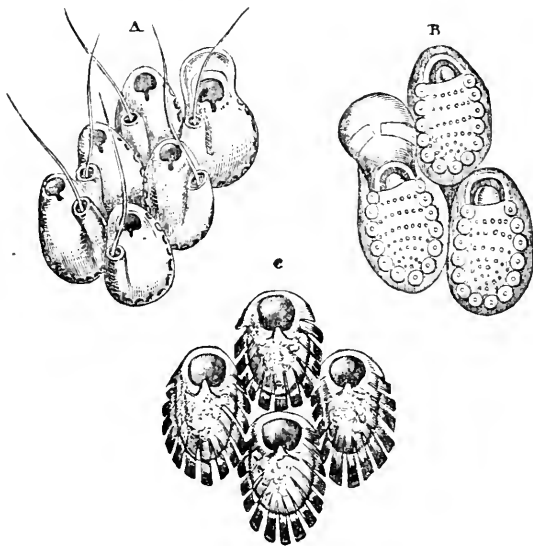

Cells of *Lepralica* :—A, *L. Hyndmanni*; B, *L. figularis*; C, *L. verrucosa*.

an arborescent structure (Fig. 301), which may even present somewhat of the density and massiveness of the Stony Corals. Each individual, designated as a *Polypide* or polype-like animal, is composed externally of a sort of sac, of which the outer or tegumentary layer is either simply membranous, or is horny, or in some instances calcified, so as to form the Cell; this investing sac is lined by a more delicate membrane, which closes its orifice, and which then becomes continuous with the wall of the alimentary canal; this lies freely in the visceral sac, floating (as it were) in the liquid which it contains.

446. The principal features in the structure of this group will be best understood from the examination of a characteristic example, such as the *Laguncula repens*; which is shown in the state of expansion at A, Plate XXII., and in the state of contraction at B and C. The Mouth is surrounded by a circle of tubular Tentacula, which are clothed with vibratile cilia; these tentacula, in the species we are considering, vary from ten to twelve in number, but in some other instances they are more numerous. By the ciliary investment of their tentacula, the Polyzoa are at once dis-

tinguishable from those Hydraform Polypes to which they bear a superficial resemblance, and with which they were at one time confounded ; and accordingly, whilst still ranked among the Zoophytes, they were characterized as *Ciliobrachiata*. The tentacula are seated upon an annular disk, which is termed the *Lophophore*, and which forms the roof of the visceral or perigastric cavity ; and this cavity extends itself into the interior of the tentacula, through perforations in the Lophophore, as is shown at *D*, Plate XXII., representing a portion of the tentacular circle on a larger scale, *aa* being the tentacula, *bb* their internal canals, *c* the muscles of the tentacula, *d* the lophophore, and *e* its retractile muscles. The Mouth, situated in the centre of the lophophore, as shown at *A*, leads to a funnel-shaped cavity or Pharynx, *b*, which is separated from the Œsophagus, *d*, by a valve at *c* ; and this Œsophagus opens into the Stomach, *e*, which occupies a considerable part of the visceral cavity. (In the *Bowerbankia*, and some other Polyzoa, a muscular stomach or Gizzard or the trituration of the food intervenes between the Œsophagus and the true digestive stomach.) The walls of the Stomach, *h*, have considerable thickness ; and they are beset with minute follicles, which seem to have the character of a rudimentary Liver. This, however, is more obvious in some other members of the group. The stomach is lined, especially at its upper part, with vibratile cilia, as seen at *c*, *g* ; and by the action of these the food is kept in a state of constant agitation during the digestive process. From the upper part of the stomach, which is (as it were) doubled upon itself, the Intestine *i* opens, by a pyloric orifice, *f*, which is furnished with a regular valve ; within the intestine are seen at *k* particles of excrementitious matter, which are discharged by the Anal orifice at *l*. No Circulating apparatus here exists ; but the liquid which fills the cavity that surrounds the viscera contains the nutritive matter which has been prepared by the digestive operation, and which has transuded through the walls of the alimentary canal ; a few corpuscles of irregular size are seen to float in it. The visceral sacs of the different Polypides put forth from the same stem, appear to communicate with each other. No other Respiratory organs exist than the Tentacula ; into whose cavity the nutritive fluid is probably sent from the perivisceral cavity, for aeration by the current of water that is continually flowing over them.

447. The production of *Gemmæ* or Buds may take place either from the bodies of the Polypides themselves, which is what always happens when the cells are in mutual apposition ; or from the connecting stem or Stolon where the cells are distinct one from the other, as in *Laguncula*. In the latter case there is first seen a bud-like protuberance of the horny external integument, into which the soft membranous lining prolongs itself ; the cavity thus formed, however, is not to become (as in Hydra and its allies) the stomach of the new Zooid ; but it constitutes the chamber surrounding the digestive viscera, which organs have their origin in a

PLATE XXII.

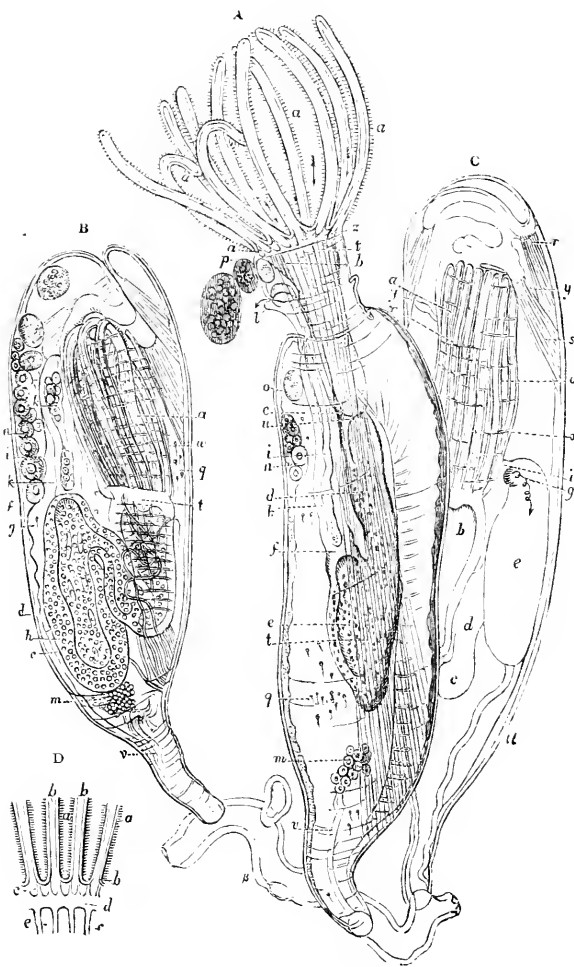

LAGUNCULA REPENS.

[To face p. 578.]

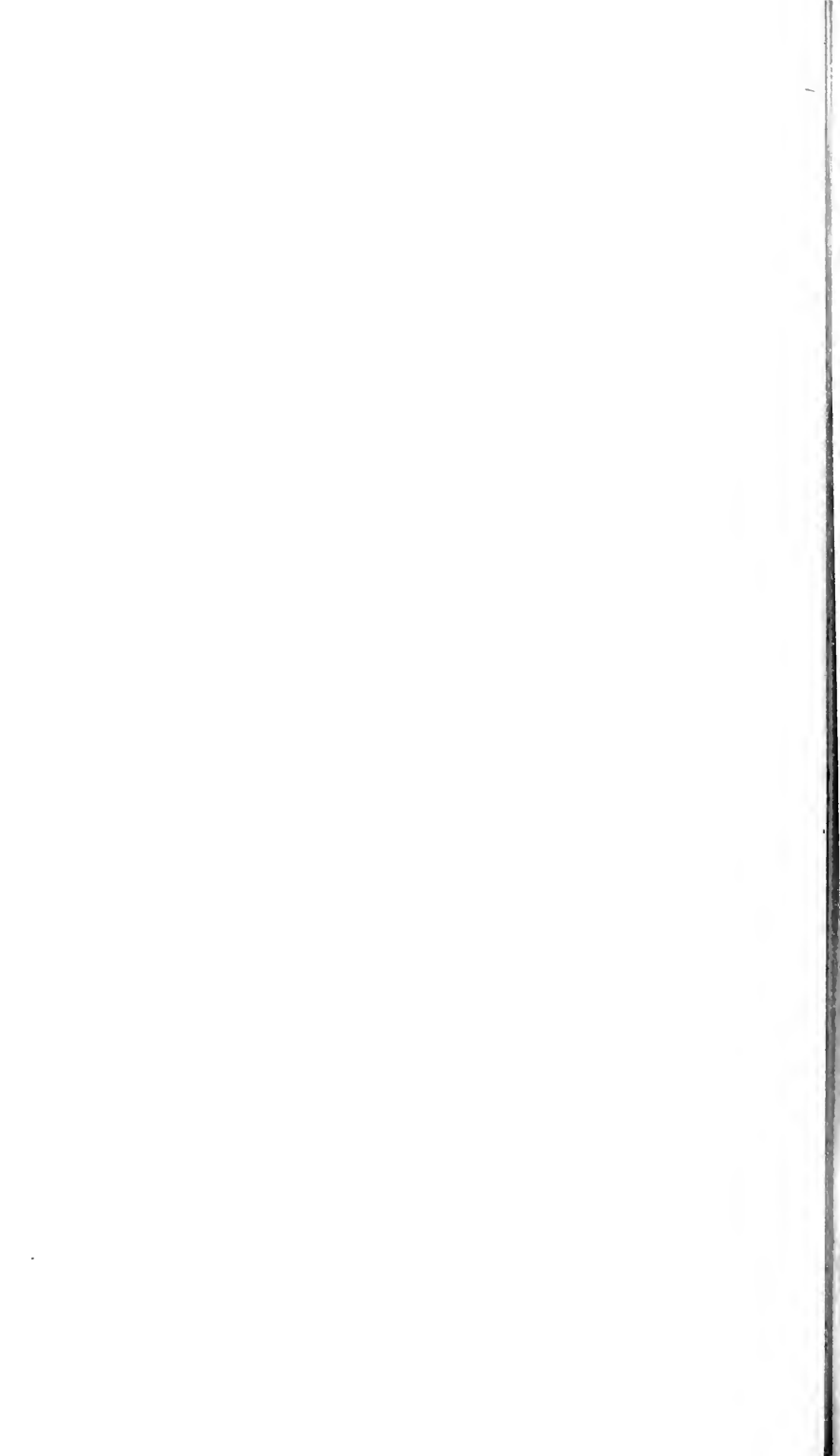

thickening of the lining membrane, that projects from one side of the cavity into its interior, and gradually shapes itself into the alimentary canal with its tentacular appendages. Of the production of Gemmæ from the Polypides themselves, the best examples are furnished by the *Flustra* and their allies. From a single cell of the *Flustra*, five such buds may be sent-off, which develope themselves into new Polypides around it; and these, in their turn, produce buds from their unattached margins, so as rapidly to augment the number of cells to a very large amount. To this extension there seems no definite limit; and it often happens that the cells in the central portion of the leaf-like expansion of a *Flustra* are devoid of contents and have lost their vitality, whilst the edges are in a state of active growth.—Independently of their propagation by gemmation, the Polyzoa have a true sexual Generation; the sexes, however, being usually, if not invariably, united in the same Polypides. The Sperm-cells are developed in a glandular body, the *Testis m*, which lies beneath the base of the stomach; when mature, they rupture, and set free the Spermatozoa *q q*, which swim freely in the liquid of the visceral cavity. The Ova, on the other hand, are formed in an Ovarium *n*, which is lodged in the membrane lining the tegumentary sheath near its outlet; the ova, having escaped from this into the visceral cavity, as at *o*, are fertilized by the spermatozoa which they there meet with; and are finally discharged by an outlet at *p*, beneath the tentacular circle.

448. These creatures possess a considerable number of Muscles, by which their bodies may be projected from their sheaths, or drawn within them; of these muscles, *r, s, t, u, v, w, x*, the direction and points of attachment sufficiently indicate the uses; they are for the most part *retractors*, serving to draw-in and double-up the body, to fold-together the circle of tentacula, and to close the aperture of the sheath, when the animal has been completely withdrawn into its interior. The *projection* and *expansion* of the animal, on the contrary, appear to be chiefly accomplished by a general pressure upon the sheath, which will tend to force out all that can be expelled from it. The Tentacula themselves are furnished with distinct muscular fibres, by which their separate movements seem to be produced. At the base of the tentacular circle, just above the anal orifice, is a small body (seen at *A, a*), which is a Nervous Ganglion; as yet no branches have been distinctly seen to be connected with it in this species; but its character is less doubtful in some other Polyzoa.—Besides the independent movements of the individual Polypides, other movements may be observed, which are performed by so many of them simultaneously as to indicate the existence of some connecting agency; and such connecting agency has lately been detected by Dr. Fritz Müller,*

* See his Memoir in "Wiegmann's Archiv.," 1860, p. 311; translated in "Quart. Journ. of Microsc. Science," New Ser., Vol. i. (1861), p. 300.

who has discovered what he terms a Colonial-Nervous system in a *Serialaria* having a branching Polyzoary that spreads itself on Sea-weeds over a space of three or four inches. A Nervous Ganglion may be distinguished at the origin of each branch, and another ganglion at the origin of each polypide-bud; and all these ganglia are connected together, not merely by principal trunks, but also by plexuses of Nerve-Fibres, which may be distinctly made-out with the aid of Chromic Acid in the cylindrical joints of the Polyzoary.

449. Of all the Polyzoa of our own coasts, the *Flustræ* or Sea-Mats are the most common; these present flat expanded surfaces, resembling in form those of many Sea-Weeds (for which they are often mistaken), but exhibiting, when viewed even with a low magnifying power, a most beautiful network, which at once indicates their real character. The cells are arranged on both sides; and it has been calculated by Dr. Grant, that as a single square inch of an ordinary Flustra contains 1800 such cells, and as an average specimen presents about 10 square inches of surface, it will consist of no fewer than 18,000 Zooids. The want of transparency in the cell-wall, however, and the infrequency with which the animal projects its body far beyond the mouth of the cell, render the Polyzoa of this genus less favourable subjects for microscopic examination than are those of the *Bowerbankia*, a Polyzoan with a trailing stem and separated cells like those of *Laguncula*, which is very commonly found clustering around the basis of *Flustræ*. It was in this that many of the details of the organization of the interesting group we are considering were first studied by Dr. A. Farre, who discovered it in 1837, and subjected it to a far more minute examination than any Polyzoan had previously received;* and it is one of the best-adapted of all the Marine forms yet known, for the display of the beauties and wonders of this type of organization.—The *Halodactylus* (formerly called *Aleyonidium*), however, is among the most remarkable of all the Marine forms for the comparatively large size of the tentacular crowns; these, when expanded, being very distinctly visible to the naked eye, and presenting a spectacle of the greatest beauty when viewed under a sufficient magnifying power. The Polyzoary of this genus has a spongy aspect and texture, very much resembling that of the *Aleyonian Zoophytes*, for which it might readily be mistaken when its contained animals are all withdrawn into their cells; when these are expanded, however, the aspect of the two is altogether different, as the minute plumose tufts which then issue from the surface of the *Halodactylus*, making it look as if it were covered with the most delicate downy film, are in striking contrast with the larger, solid-looking polypes of the *Aleyonium*. The opacity of the polyzoary of the *Halodactylus* renders it quite unsuitable for the

* See his Memoir 'On the Minute Structure of some of the higher forms of Polypi' in the "Philosophical Transactions" for 1837.

examination of anything more than the tentacular crown and the oesophagus which it surmounts; the stomach and the remainder of the visceral apparatus being always retained within the cell. It furnishes, however, a most beautiful object for the Binocular Microscope, when mounted with all its Polypides expanded, in the manner described in § 419.—Several of the Fresh-water Polyzoa are peculiarly interesting subjects for Microscopic examination; alike on account of the remarkable distinctness with which the various parts of their organization may be seen, and the very beautiful manner in which their ciliated tentacula are arranged upon a deeply-crescentic or horseshoe-shaped *Lophophore*. By this peculiarity the Fresh-water Polyzoa are separated as a distinct Sub-Class from the Marine; the former being designated as *Hippocrepia* (horseshoe-like), while the latter are termed *Infundibulata* (funnel-like).

450. The *Infundibulata* or Marine Polyzoa, constituting by far the most numerous division of the class, are divided into four orders, as follows:—I. *Cheilostomata*, in which the mouth of the cell is *sub-terminal*, or not quite at its extremity (Fig. 300), is somewhat crescentic in form, and is furnished with a movable (generally membranous) lip, which closes it when the animal retreats. This includes a large part of the species that most abound on our own coasts, notwithstanding their wide differences in form and habit. Thus the Polyzoaries of some (as *Flustra*) are horny and flexible, whilst those of others (as *Eschara* and *Rctepora*) are so penetrated with calcareous matter as to be quite rigid; some grow as independent Plant-like structures (as *Bugula* and *Gemellaria*), whilst others, having a like arborescent form, creep over the surfaces of rocks or stones (as *Hippothoa*); and others, again, have their cells in close apposition, and form crusts which possess no definite figure (as is the case with *Lepralia* and *Membranipora*).—II. The second order, *Cyclostomata*, consists of those Polyzoa which have the mouth at the *termination* of tubular Calcareous cells, without any movable appendage or lip (Fig. 301). This includes a comparatively small number of genera, of which *Crisia* and *Tabulipora* contain the largest proportion of the species that occur on our own coasts.—III. The distinguishing character of the third order, *Ctenosomata*, is derived from the presence of a Comb-like circular fringe of bristles, connected by a delicate membrane, around the mouth of the cell, when the animal is projected from it; this fringe being drawn-in when the animal is retracted. The Polyzoaries of this group are very various in character, the cells being sometimes horny and separate (as in *Laguncula* and *Bowerbankia*), sometimes fleshy and coalescent (as in *Halodactylus*).—IV. In the fourth order, *Pedicellineæ*, which includes only a single genus, *Pedicellina*, the Lophophore is produced upwards on the back of the tentacles, uniting them at their base in a sort of muscular Calyx, and giving to the animal when expanded somewhat

the form of an inverted bell, like that of *Vorticella* (Fig. 239).—The cells of the *Hippocrepia* or Fresh-water Polyzoa are for the most part lodged in a sort of gelatinous substratum, which spreads over the leaves of Aquatic Plants, sometimes forming masses of considerable size; but in the very curious and beautiful *Cristatella*, the Polyzoary is unattached, so as to be capable of moving freely through the waters.—As the Polyzoa altogether resemble the true Zoophytes in their habits, and are found in the same localities, it is not requisite to add anything to what has already been said (§§ 419, 420), respecting the collection, examination, and mounting, of this very interesting class of objects.*

451. A large proportion of the Polyzoa of the first Order are furnished with very peculiar motile appendages, which are of two kinds, *Avicularia* and *Vibracula*. The *Avicularia* or 'bird's-head processes,' are so named from the striking resemblance they present to the head and jaws of a Bird (Fig. 301, B). They are generally 'sessile' upon the angles or margins of the cells, that is, are attached at once to them, without the intervention of a stalk, as in Fig. 301, A, being either 'projecting' or 'immersed;' but in the genera *Bugula* and *Bicellaria*, where they are present at all, they are 'pedunculate,' or mounted on footstalks (B). Under one form or the other, they are wanting in but few of the Genera belonging to this order; and their presence or absence furnishes valuable characters for the discrimination of Species. Each *Avicularium* has two 'mandibles,' of which one is fixed, like the upper jaw of a Bird, the other movable, like its lower jaw; the latter is opened and closed by two sets of muscles which are seen in the interior of the 'head;' and between them is a peculiar body, furnished with a pencil of bristles, which is probably a tactile organ, being brought forwards when the mouth is open, so that the bristles project beyond it, and being drawn-back when the mandible closes. The *Avicularia* keep-up a continual snapping action during the life of the Polyzoary; and they may often be observed to lay hold of minute Worms or other bodies, sometimes even closing upon the beaks of adjacent organs of the same kind, as shown in Fig. 301, B. In the pedunculate forms, besides the snapping action, there is a continual rhythmical nodding of the head upon the stalk; and few spectacles are more curious than a portion of the Polyzoary of *Bugula avicularia* (a very common British species) in a state of active vitality, when viewed under a power sufficiently low to

* For a more detailed account of the Structure and Classification of this group, see Prof. Van Beneden's 'Recherches sur les Bryozoaires de la Côte d'Ostende,' in "Mém. de l'Acad. Roy. de Bruxelles," tom. xvii.: Mr. G. Busk's "Catalogue of the Marine Polyzoa in the Collection of the British Museum;" Mr. Huxley's 'Note on the Reproductive Organs of the Cheilostome Polyzoa,' in "Quart. Journ. of Microsc. Sci.," Vol. iv. p. 191; Dr. G. Johnson's "History of British Zoophytes;" and Prof. Allman's beautiful "Monograph of the British Fresh-water Polyzoa," published by the Ray Society, 1857.

allow a number of these bodies to be in sight at once. It is still very doubtful what is their precise function in the economy of the animal; whether it is to retain within the reach of the ciliary current bodies that may serve as food; or whether it is, like the

FIG. 301.



A, Portion of *Cellularia ciliata*, enlarged; B, one of the 'bird's-head' processes of *Bugula avicularia*, more highly magnified, and seen in the act of grasping another.

Pedicellariæ of Echini (§ 432), to remove extraneous particles that may be in contact with the surface of the Polyzoary. The latter would seem to be the function of the *vibracula*, which are long bristle-shaped organs (Fig. 300, A), each one springing at its base out of a sort of cup that contains muscles by which it is kept in almost constant motion, sweeping slowly and carefully over the surface of the Polyzoary, and removing what might be injurious to the delicate inhabitants of the cells when their tentacula are protruded. Out of 191 species of Cheilostomatous Polyzoa de-

scribed by Mr. Busk, no fewer than-126 are furnished either with Avicularia, or with Vibracula, or with both these organs.*

452. TUNICATA.—The Tunicated Mollusca are so named from the enclosure of their bodies in a 'tunic,' which is sometimes leathery or even cartilaginous in its texture, and which very commonly includes Calcareous spicules, whose forms are often very beautiful. They present a strong resemblance to the Polyzoa, not merely in their general plan of conformation, but also in their tendency to produce Composite structures by Gemination; they are differentiated from them, however, by the absence of the Ciliated Tentacula which form so conspicuous a feature in the external aspect of the Polyzoa, by the presence of a distinct Circulating apparatus, and by their peculiar Respiratory apparatus, which may be regarded as a dilatation of their Pharynx. In their habits, too, they are for the most part very inactive, exhibiting scarcely anything comparable to those rapid movements of expansion and retraction which it is so interesting to watch among the Polyzoa; whilst, with the exception of the *Salpidae* and other floating species which are chiefly found in seas warmer than those that surround our coast, and the curious *Appendicularia* to be presently noticed (§ 457), they are rooted to one spot during all but the earliest period of their lives.—The larger forms of the *Ascidian* group, which constitutes the bulk of the Class, are always solitary; either not propagating by gemination at all, or, if this process does take place, the gemmæ being detached before they have advanced far in their development. Although of special importance to the Comparative Anatomist and the Zoologist, this group does not afford much to interest the ordinary Microscopist, except in the peculiar actions of its Respiratory and Circulatory apparatus. In common with the Composite forms of the group, the Solitary Ascidiæ have a large Branchial sac, with fissured walls, resembling that shown in Figs. 302 and 303; into this sac water is admitted by the oral orifice, and a large proportion of it is caused to pass through the fissures, by the agency of the Cilia with which they are fringed, into a surrounding chamber, whence it is expelled through the anal orifice. This action may be distinctly watched through the external walls in the smaller and more transparent species; and not even the ciliary action of the Tentacula of the Polyzoa affords a more beautiful spectacle. It is peculiarly remarkable in one species that occurs on our own coasts—the *Ascidia parallelogramma*†—in which the wall of the branchial sac is divided into a number of areolæ, each of them shaped into a shallow funnel; and round one of these funnels each branchial

* See Mr. G. Busk's 'Remarks on the Structure and Function of the Avicularian and Vibracular Organs of Polyzoa,' in "Transact. of Microsc. Soc.," Ser. 2, Vol. ii. (1854), p. 26.

† See Alder in "Ann. of Nat. Hist.," 3rd Ser., Vol. xi. (1863), p. 157; and Hancock in "Journ. of Linn. Soc.," Vol. ix., p. 333.

fissure makes two or three turns of a spiral. When the cilia of all these spiral fissures are in active movement at once, the effect is most singular.—Another most remarkable phenomenon presented throughout the group, and well seen in the solitary Ascidian just referred-to, is the *alternation* in the direction of the Circulation. The Heart, which lies at the bottom of the branchial sac, is composed of two chambers imperfectly divided from each other; one of these is connected with the principal trunk leading to the Body, and the other with that leading to the Branchial sac. At one time it will be seen that the blood flows *from* the Respiratory apparatus to the cavity of the Heart in which its trunk terminates, which then contracts so as to drive it into the other cavity, which in its turn contracts and propels it through the Systemic trunk *to* the body at large; but after this course has been maintained for a time, the heart ceases to pulsate for a moment or two, and the course is reversed, the blood flowing into the Heart *from* the body generally, and being propelled *to* the Branchial sac. After this reversed course has continued for some time, another pause occurs, and the first course is resumed. The length of time intervening between the changes does not seem by any means constant. It is usually stated at from half-a-minute in the Composite forms to two minutes; but in the Solitary Ascidian just referred to, the Author has repeatedly observed an interval of from five to fifteen minutes, and in some instances he has seen the circulation go-on for half-an-hour or even longer without change.

453. The *Compound Ascidiæ* are very commonly found adherent to Sea-weeds, Zoophytes, and Stones between the tide-marks; and they present objects of great interest to the Microscopist, since the small size and transparence of their bodies, when they are detached from the mass in which they are imbedded, not only enables their structure to be clearly discerned without dissection, but allows many of their living actions to be watched. Of these we have a characteristic example in *Amaroucium proliferum*; of which the form of the composite mass and the anatomy of a single individual are displayed in Fig. 302. Its clusters appear almost completely inanimate, exhibiting no very obvious movements when irritated; but if they be placed when fresh in Sea-water, a slight pouting of the orifices will soon be perceptible, and a constant and energetic series of currents will be found to enter by one set and to be ejected by the other, indicating that all the machinery of active life is going-on within these apathetic bodies. In the tribe of *Polyclinians* to which this genus belongs, the body is elongated, and may be divided into three regions, the Thorax (A) which is chiefly occupied by the Respiratory sac, the Abdomen (B) which contains the Digestive apparatus, and the Post-abdomen (C) in which the Heart and Generative organs are lodged. At the summit of the Thorax is seen the Oral orifice *c*, which leads to the Branchial sac *e*; this is perforated by an immense number of

FIG. 302.

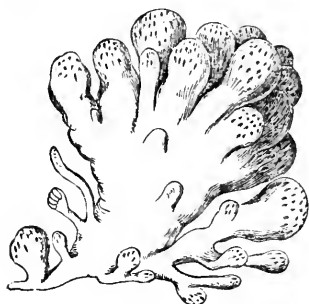
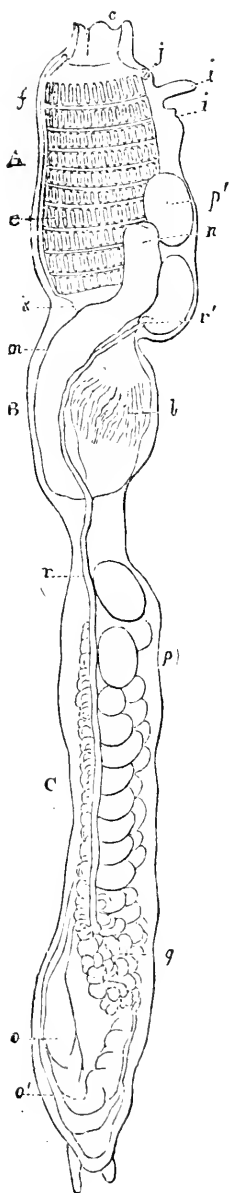

Compound mass of *Amaroucium proliferum*, with the anatomy of a single Zooid:—A, thorax; B, abdomen; C, post-abdomen:—c, oral orifice; e, branchial sac; f, thoracic sinus; i, anal orifice; i', projection overhanging it; j, nervous ganglion; k, oesophagus; l, stomach surrounded by biliary tubuli; m, intestine; n, termination of intestine in cloaca; o, heart; o', pericardium; p, ovarium; p', egg ready to escape; q, testis; r, spermatocanal; r', termination of this canal in the cloaca.

slits, which allow part of the water to pass into the space between the branchial sac and the muscular mantle, where it is especially collected in the Thoracic Sinus *f*. At *k* is seen the Oesophagus, which is continuous with the lower part of the pharyngeal cavity; this leads to the Stomach *l*, which is surrounded by Biliary follicles; and from this passes-off the Intestine *m*, which terminates at *n* in the Cloaca, or common vent. A current of Water is continually drawn-in through the mouth by the action of the Cilia of the branchial sac and of the alimentary canal; a part of this current passes through the fissures of the branchialsac into the thoracic sinus, and thence into the cloaca; whilst another portion, entering the stomach by an aperture at the bottom of the pharyngeal sac, passes through the alimentary canal, giving up any

nutritive materials it may contain, and carrying away with it any excrementitious matters to be discharged; and this having met the respiratory current in the cloaca, the two mingled currents pass forth together by the Anal orifice *i*. The long post-abdomen is principally occupied by the large Ovarium, *p*, which contains Ova in various stages of development. These, when matured and set-free, find their way into the cloaca; where two large ova are seen (one marked *p'*, and the other immediately below it) waiting for expulsion. In this position they receive the fertilizing influence from the Testis, *q*, which discharges its products by the long spermatic canal, *r*, that opens into the cloaca, *r'*. At the very bottom of the post-abdomen we find the Heart *o*, enclosed in its pericardium, *o'*.—In the tribe we are now considering, a number of such animals are imbedded together in a sort of gelatinous mass, and covered with an integument common to them all; the composition of this gelatinous substance is remarkable as including Cellulose, which generally ranks as a Vegetable product. The mode in which new individuals are developed in this mass, is by the extension of *Stolons* or creeping stems from the bases of those previously existing; and from each of these stolons several buds may be put-forth, every one of which may evolve itself into the likeness of the stock from which it proceeded, and may in its turn increase and multiply after the same fashion. A communication between the Circulating systems of the different individuals is kept-up, through their connecting stems, during the whole of life; and thus their relation-

FIG. 303.

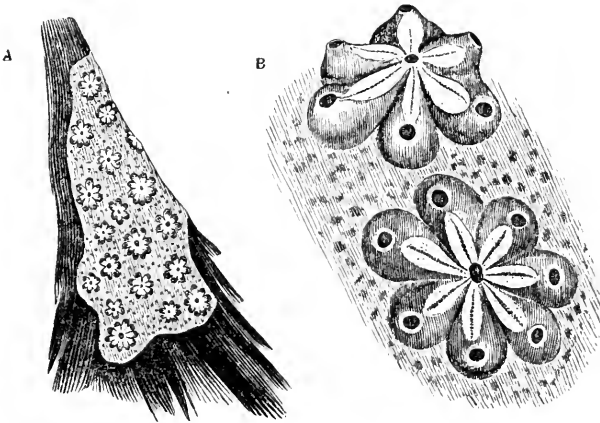

Botryllus violaceus.—A, cluster on the surface of a Fucus:—B, portion of the same enlarged.

ship to each other is somewhat like that of the several Polypes on the polypidom of a *Campanularia* (§ 417).

454. In the family of *Didemnians* the Post-abdomen is absent, the Heart and Generative apparatus being placed by the side of the Intestine in the Abdominal portion of the body. The Zooids are frequently arranged in star-shaped clusters, their Anal orifices being all directed towards a common vent which occupies the centre.— This shortening is still more remarkable, however, in the family of *Botryllians*, whose beautiful stellate gelatinous incrustations are extremely common upon Sea-weeds and submerged rocks (Fig. 303). The anatomy of these animals is very similar to that of the *Amaroucium* already described; with this exception, that the body exhibits no distinction of cavities, all the organs being brought together in one, which must be considered as Thoracic. In this respect there is an evident approximation towards the Solitary species.

455. This approximation is still closer, however, in the 'Social' Ascidians, or *Clavellinidae*; in which the general plan of structure is nearly the same, but the Zooids are simply connected by their stolons (Fig. 304) instead of being included in a common investment; so that their relation to each other is very nearly the same as that of the Polypides of *Laguncula* (§ 446), the chief difference being that a regular Circulation takes-place through the stolon in the one case, such as has no existence in the other. A better opportunity of studying the living actions of the Ascidians can scarcely be found, than that which is afforded by the genus *Perophora*, first discovered by Mr. Lister, which occurs not unfrequently on the south coast of England and in the Irish Sea, living attached to Sea-weeds, and looking like an assemblage of minute globules of jelly, dotted with orange and brown, and linked by a silvery winding thread. The isolation of the body of each Zooid from that of its fellows, and the extreme transparence of its tunics, not only enable the movements of fluid within the body to be distinctly discerned, but also allow the action of the Cilia that border the slits of the Respiratory sac to be clearly made-out. This sac is perforated with four rows of narrow oval openings, through which a portion of the water that enters its Oral orifice (*g*) escapes into the space between the sac and the mantle, and is thus discharged immediately by the Anal funnel (*f'*). Whatever little particles, animate or inanimate, the current of water brings, flow into the sac, unless stopped at its entrance by the Tentacula (*g'*), which do not appear fastidious. The particles which are admitted usually lodge somewhere on the sides of the sac, and then travel horizontally until they arrive at that part of it down which the current proceeds to the entrance of the Stomach (*i*), which is situated at the bottom of the sac. Minute animals are often swallowed alive, and have been observed darting about in the cavity for some days, without any apparent injury either to them-

selves or to the creature which encloses them. In general, however, particles which are unsuited for reception into the stomach are ejected by the sudden contraction of the Mantle (or muscular tunic), the vent being at the same time closed, so that they are forced-out by a powerful current through the Oral orifice. The curious alternation of the Circulation that is characteristic of the Class generally (§ 452), may be particularly well studied in *Perophora*. The creeping-stalk (Fig. 304) that connects the individuals

FIG. 304.

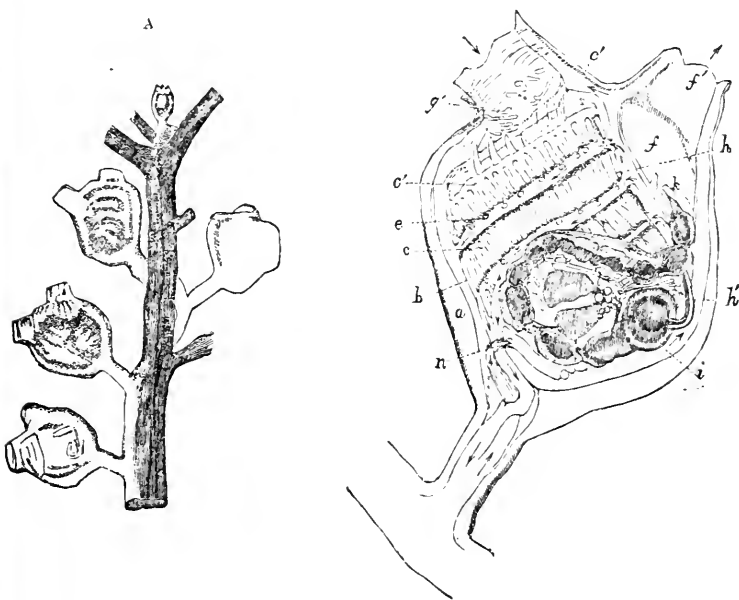

A, Group of *Perophora* (enlarged), growing from a common stalk:—B, single *Perophora*; a, test; b, inner sac; c, branchial sac, attached to the inner sac along the line $c'c'$; $e e$, finger-like processes projecting inwards; f , cavity between test and internal coat; f' , anal orifice or funnel; g , oral orifice; g' , oral tentacula; h , downward stream of food; h' , oesophagus; i , stomach; k , vent; l , ovary (?); n , vessels connecting the circulation in the body with that in the stalk.

of any group contains two distinct canals, which send-off branches into each peduncle. One of these branches terminates in the Heart, which is nothing more than a contractile dilatation of the principal trunk; this trunk subdivides into vessels (or rather

sinuses, which are mere channels not having proper walls of their own), of which some ramify over the Respiratory sac, branching off at each of the passages between the oval slits, whilst others are first distributed to the Stomach and Intestine, and to the soft surface of the Mantle. All these reunite so as to form a trunk, which passes to the peduncle and constitutes the returning branch. Although the Circulation in the different bodies is brought into connection by the common stem, yet that of each is independent of the rest, continuing when the current through its own footstalk is interrupted by a ligature; and the stream which returns from the branchial sac and the viscera is then poured into the posterior part of the heart, instead of entering the peduncle.

456. The *Development* of the Ascidiæ, the early stages of which are observable whilst the Ova are still within the cloaca of the parent, presents some phenomena of much interest to the Microscopist. After the ordinary repeated segmentation of the yolk, whereby a 'mulberry mass' is produced, a sort of ring is seen encircling its central portion; but this soon shows itself as a tapering tail-like prolongation from one side of the yolk, which gradually becomes more and more detached from it, save at the part from which it springs. Either whilst the egg is still within the cloaca, or soon after it has escaped from the vent, its envelope bursts, and the Larva escapes; and in this condition it presents very much the appearance of a Tadpole, the tail being straightened out, and propelling the body freely through the water by its lateral strokes. The centre of the body is occupied by a mass of liquid Yolk; and this is continued into the interior of three prolongations which extend themselves from the opposite extremity, each terminating in a sort of sucker. After swimming-about for some hours with an active wriggling movement, the Larva attaches itself to some solid body by means of one of these suckers: if disturbed from its position, it at first swims about as before; but it soon completely loses its activity, and becomes permanently attached; and important changes manifest themselves in its interior. The prolongations of the central Yolk-substance into the anterior processes and tail are gradually drawn back, so that the whole of it is concentrated into one mass; and the tail, now consisting only of the gelatinous envelope, is either detached entire from the body by the contraction of the connecting portion, or withers, and is thrown-off gradually in shreds. The shaping of the internal organs out of the Yolk-mass takes-place very rapidly, so that by the end of the second day of the sedentary state the outlines of the branchial sac and of the stomach and intestine may be traced; no external orifices, however, being as yet visible. The pulsation of the heart is first seen on the third day, and the formation of the branchial and anal orifices takes-place on the fourth; after which the ciliary currents are immediately established through

the branchial sac and alimentary canal.—The Embryonic Development of other Ascidiæ, solitary as well as composite, takes-place on a plan essentially the same as the foregoing, a free tadpole-like larva being always produced in the first instance.*

457. This Larval condition is represented in a very curious adult free-swimming form, termed *Appendicularia*, which is frequently to be taken with the Tow-Net on our own coasts. This animal has an oval or flask-like body, which in large specimens attains the length of one-fifth of an inch, but which is often not more than one-fourth or one-fifth of that size. It is furnished with a tail-like appendage three or four times its own length, broad, flattened, and rounded at its extremity; and by the powerful vibrations of this appendage it is propelled rapidly through the water. The structure of the body differs greatly from that of the Ascidiæ, its plan being much simpler; in particular, the pharyngeal sac is entirely destitute of ciliated branchial fissures opening into a surrounding cavity; but two canals, one on either side of the entrance to the stomach, are prolonged from it to the external surface; and by the action of the long cilia with which these are furnished, in conjunction with the cilia of the branchial sac, a current of water is maintained through its cavity. From the observations of Prof. Huxley, however, it appears that the direction of this current is by no means constant; since, although it usually enters by the mouth and passes-out by the ciliated canals, it sometimes enters by the latter and passes-out by the former. The caudal appendage has a central axis, above and below which is a riband-like layer of muscular fibres; a nervous cord, studded at intervals with minute ganglia, may be traced along its whole length.—By Mertens, one of the early observers of this animal, it was said to be furnished with a peculiar gelatinous envelope or *Haus* (house), very easily detached from the body, and capable of being re-formed after having been lost. Notwithstanding the great numbers of specimens which have been studied by Müller, Huxley, Leuckart, and Gegenbaur, neither of these excellent observers has met with this appendage; but it has been recently seen by Prof. Allman, who describes it as an egg-shaped gelatinous mass, in which the body is imbedded, the tail alone being free; whilst from either side of the central plane there radiates a kind of double fan, which seems to be formed by a semicircular membranous lamina folded upon itself. It is surmised by Prof. Allman, with much probability, that this curious appendage is 'nidamental,' having reference to the development and protection of the young; but on this point

* For more special information respecting the Compound Ascidiæ, see especially the admirable Monograph of Prof. Milne Edwards on that group; Mr. Lister's Memoir 'On the Structure and Functions of Tubular and Cellular Polypi, and of Ascidiæ,' in the "Philos. Transact.," 1834; and the Art. *Tunicata* in the "Cyclopædia of Anatomy and Physiology."

further observations are much needed, and any Microscopist, who may meet with *Appendicularia* furnished with its 'house,' should do all he can to determine its structure and its relations to the body of the animal. *

* For details in respect to the structure of *Appendicularia*, see Huxley in "Philos. Transact." for 1851, and in "Quart. Journ. of Microsc. Science," Vol. iv. (1856), p. 181; also Allman in the same journal, Vol. vii. (1859), p. 86; Gegenbaur in Siebold and Kölliker's "Zeitschrift," Bd. vi. (1855), p. 406; and Leuckart's "Zoologische Untersuchungen," Heft ii., 1854.—For the Tunicata generally, see Prof. T. Rupert Jones in Vol. iv. of the "Cyclop. of Anatomy and Physiology;" Mr. Alder's 'Observations on the British Tunicata' in "Ann. of Nat. Hist.," Ser. 4, Vol. xi. (1863), p. 153; and Mr. Hancock's Memoir 'On the Anatomy and Physiology of the Tunicata' in the "Journal of the Linnean Society," Vol. ix., p. 309.

CHAPTER XIV.

MOLLUSCOUS ANIMALS GENERALLY.

THE various forms of 'Shell-fish,' with their 'naked' or Shell-less allies, furnish a great abundance of objects of interest to the Microscopist; of which, however, the greater part may be grouped under three heads;—namely, (1) the structure of the *Shell*, which is most interesting in the *Conchifera* or 'Bivalves;' (2) the structure of the *Tongue* of the *Gasteropoda*, most of which have 'Univalve' shells, others, however, being 'naked;' (3) the *Developmental History* of the Embryo, for the study of which certain of the Gasteropods present the greatest facilities.—These three subjects, therefore, will be first treated of systematically; and a few miscellaneous facts of interest will be subjoined.

458. *Shells of Mollusca*.—These investments were formerly regarded as mere Inorganic exudations, composed of Calcareous particles, cemented together by Animal glue; Microscopic examination, however, has shown that they possess a definite *structure*, and that this structure presents certain very remarkable variations in some of the Natural Groups of which the Molluscos series is composed. We shall first describe that which may be regarded as the characteristic structure of the ordinary Bivalves; taking as a type the group of *Margaritaceæ*, which includes the 'Pearl-oyster' and its allies, the common *Pinna* ranking amongst the latter. In all these Shells we readily distinguish the existence of two distinct layers; an external, of a brownish-yellow colour; and an internal, which has a pearly or 'nacreous' aspect, and is commonly of a lighter hue.—The structure of the *outer* layer may be conveniently studied in the shell of *Pinna*, in which it commonly projects beyond the inner, and there often forms laminae sufficiently thin and transparent to exhibit its general characters without any artificial reduction. If a small portion of such a lamina be examined with a low magnifying power by transmitted light, each of its surfaces will present very much the appearance of a Honeycomb; whilst its broken edge exhibits an aspect which is evidently fibrous to the eye, but which, when examined under the Microscope with reflected light, resembles that of an assemblage of

Basaltic columns (Fig. 403, p). The Shell is thus seen to be composed of a vast number of *prisms*, having a tolerably-uniform size, and usually presenting an approach to the hexagonal shape. These are arranged perpendicularly (or nearly so) to the surface of the lamina of the shell; so that its thickness is formed by their length, and its

FIG. 305.

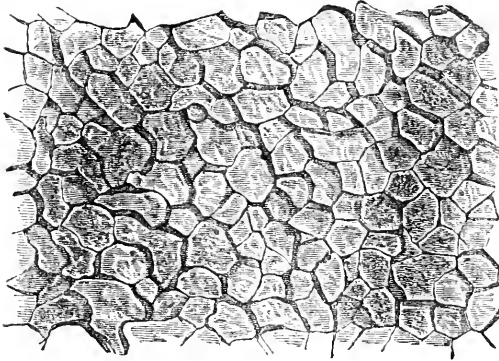

FIG. 306.

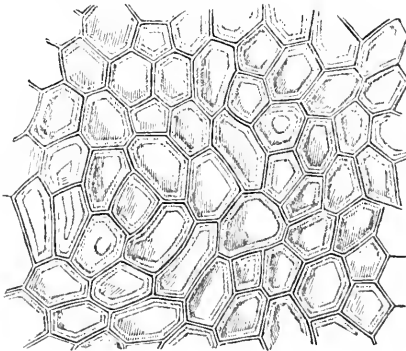

Fig. 305. Section of Shell of *Pinna*, transversely to the direction of its prisms.

Fig. 306. Membranous basis of the same.

length, and its two surfaces by their extremities. A more satisfactory view of these prisms is obtained by grinding-down a lamina until it possesses a high degree of transparence; and it is then seen (Fig. 305) that the prisms themselves appear to be composed of a very homogeneous substance, but that they are separated by definite and strongly-marked lines of division. When such a lamina is submitted to the action of dilute acid, so as to dissolve-away the carbonate of lime, a tolerably firm and consistent

Membrane is left, which exhibits the prismatic structure just as perfectly as did the original shell (Fig. 306); its hexagonal divisions bearing a strong resemblance to the walls of the Cells of the pith or bark of a Plant. By making a section of the Shell perpendicularly to its surface, we obtain a view of the prisms cut in the direction of

their length (Fig. 307); and they are frequently seen to be marked by delicate transverse striæ (Fig. 308), closely resembling those observable on the prisms of the Enamel of teeth, to which this kind of shell-structure may be considered as bearing a very close resemblance, except as regards the mineralizing ingredient. If a similar section be decalcified by dilute acid, the Membranous residuum will exhibit the same resemblance to the walls of prismatic cells viewed longitudinally, and will be seen to be more or less regularly

FIG. 307.

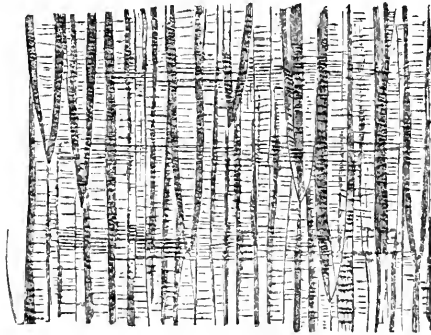
Section of the Shell of *Pinna*, in the direction of its prisms.

marked by the transverse striæ just alluded to (Fig 308). It sometimes happens in recent, but still more commonly in Fossil

FIG. 308.

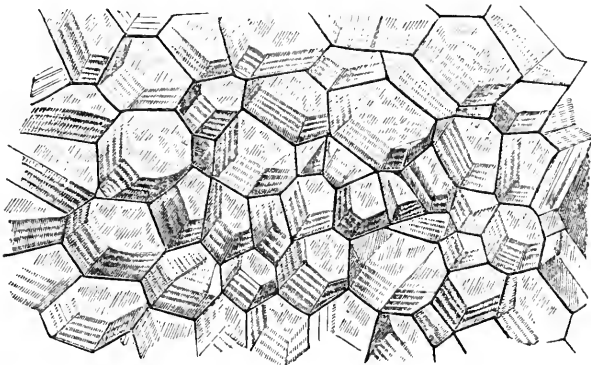

Oblique Section of Prismatic Shell-substance.

Shells, that the decay of the animal membrane leaves the contained Prisms without any connecting medium: as they are then quite isolated, they can be readily detached one from another; and each one may be observed to be marked by the like striations, which,

when a sufficiently high magnifying power is used, are seen to be minute grooves, apparently resulting from a thickening of the intermediate wall in those situations. These appearances seem best accounted-for by supposing that each is lengthened by successive additions at its base, the lines of junction of which correspond with the transverse striation; and this view corresponds well with the fact that the Shell-Membrane not unfrequently shows a tendency to split into thin laminae along the lines of striation; whilst we occasionally meet with an excessively thin natural lamina lying between the thicker prismatic layers, with one of which it would have probably coalesced, but for some accidental cause which preserved its distinctness. That the Prisms are not formed in their entire length at once, but that they are progressively lengthened and consolidated at their lower extremities, would appear also from the fact that where the Shell presents a deep colour (as in *Pinna nigrina*) this colour is usually disposed in distinct strata, the outer portion of each layer being the part most deeply tinged, whilst the inner extremities of the prisms are almost colourless.

459. This Prismatic arrangement of the Carbonate of Lime in the Shells of *Pinna* and its allies, has been long familiar to Conchologists, and regarded by them as the result of Crystallization. When it was first more minutely investigated by Mr. Bowerbank* and the Author,† and was shown to be connected with a similar arrangement in the Membranous residuum left after the decalcification of the Shell-substance by acid, Microscopists generally‡ agreed to regard it as a 'calcified' Epidermis: the long prismatic cells being supposed to be formed by the coalescence of the epidermic cells in piles, and giving their shape to the deposit of carbonate of lime formed within them. The progress of inquiry, however, has led to an important modification of this interpretation; the Author being now disposed to agree with Prof. Huxley§ in the belief that the entire thickness of the Shell is formed as an *excretion* from the surface of the Epidermis, and that the horny layer, which in ordinary shells forms their external envelope or 'periostracum,'|| being here thrown out at the same time with the calcifying material, is converted into the likeness of a cellular membrane by the pressure of the prisms that are formed by crystallization at regular distances in the midst of it. The peculiar conditions under which

* 'On the Structure of the Shells of Molluscous and Conchiferous Animals,' in "Transact. of Microsc. Society," 1st Ser. 1844, Vol. i., p. 123.

† 'On the Microscopic Structure of Shells,' in "Reports of British Association" for 1844 and 1847.

‡ See Mr. Quekett's "Histological Catalogue of the College of Surgeons' Museum," and his "Lectures on Histology," Vol. ii.

§ See his article 'Tegumentary Organs,' in "Cyclopædia of Anatomy and Physiology," Supplementary Volume, pp. 489-492.

|| The *periostracum* is the yellowish-brown membrane covering the surface of many shells, which is often (but erroneously) termed their *epidermis*.

calcareous concretions form themselves in an organic matrix, have been carefully studied by Mr. Rainey; whose researches (of which some account will be given hereafter, § 599) are worthy of more attention than they have received.*

460. It is only in the Shells of a few families of Bivalves, that the combination of Organic with Mineral components is seen in this very distinct form; and these families are for the most part nearly allied to *Pinna*. In all the Genera of the *Margaritaceæ*, we find the external layer of the shell Prismatic, and of considerable thickness; the internal layer being Nacreous. In the *Unionidæ* (fresh-water Mussels), on the contrary, nearly the whole thickness of the shell is made-up of the internal or Nacreous layer; but a uniform stratum of Prismatic substance is always found between the Nacre and the Periostracum, really constituting the inner layer of the latter, the outer being simply horny. In the *Ostraceæ* (or Oyster tribe), the greater part of the shell is composed of a Sub-Nacreous substance, the successively-formed laminae of which have very little adhesion to each other; but every one of these laminae is bordered at its free edge by a layer of the Prismatic substance, distinguished by its brownish-yellow colour. In these and some other cases, a distinct membranous residuum is left after the decalcification of the prismatic layer by dilute acid; and this is most tenacious and substantial, where (as in the *Margaritaceæ*) there is no proper periostracum. Generally speaking, a thin Prismatic layer may be detected upon the external surface of Bivalve shells, where this has been protected by a Periostracum, or has been prevented in any other manner from undergoing abrasion; thus it is found pretty generally in *Chama*, *Trigonia*, and *Solen*, and occasionally in *Anomia* and *Pecten*.

461. In many other instances, however, nothing like a Cellular structure can be distinctly seen in the delicate Membrane left after Decalcification; and in such cases the Animal basis bears but a very small proportion to the Calcareous substance, and the Shell is usually extremely hard. This hardness appears to depend upon the Mineral arrangement of the Carbonate of Lime; for whilst, in the *prismatic* and ordinary *nacreous* layer this has the crystalline condition of *Calcite*, it can be shown in the hard shell of *Pholas* to have the arrangement of *Arragonite*; the difference between the two being made evident by Polarized light. A very curious appearance is presented by a section of the large Hinge-tooth of *Mya arenaria* (Fig. 309), in which the Carbonate of Lime seems to be deposited in nodules that possess a crystalline structure resembling that of the Mineral termed *Wavellite*. Approaches to this curious arrangement are seen in many other Shells.

462. The *internal* layer of Bivalve Shells rarely presents any

* See his Treatise "On the Mode of Formation of the Shells of Animals, of Bone, and of several other structures, by a Process of Molecular Coalescence, demonstrable in certain artificially-formed Products," 1853.

distinct structure when examined in a thin section ; and the residuum left after decalcification is usually a structureless ' basement-membrane.' In the *Margaritacea* and many other families, however, this internal layer has a Nacreous or Iridescent lustre, which

FIG. 309.

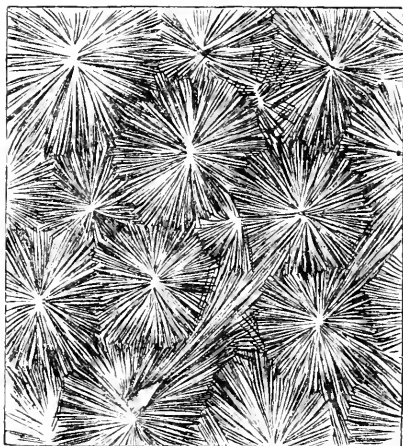
Section of hinge-tooth of *Mya arenaria*.

depends (as Sir D. Brewster has shown*) upon the striation of its surface with a series of grooved lines, which usually run nearly parallel to each other (Fig 310.) As these lines are not obliterated by any amount of polishing, it is obvious that their presence depends upon something peculiar in the texture of this substance, and not upon any mere superficial arrangement. When a piece of the Nacre of the *Aricula* or Pearl-Mussel (commonly known as 'Mother-of-Pearl') is carefully examined, it becomes evident that the lines are produced by the cropping-out of laminae of Shell situated more or less obliquely to the plane of the surface. The greater the *dip* of these laminae, the closer will their edges be ; whilst the less the angle which they make with the surface, the wider will be the interval between the lines. When the section passes for any distance in the plane of a lamina, no lines will present themselves on that space. And thus the appearance of a section of Nacre is such as to have been aptly compared by Sir J. Herschel to the surface of a smoothed deal board, in which the woody layers are cut perpendicularly to their surface in one part, and nearly in their plane in another. Sir D. Brewster (*loc. cit.*) appears to have supposed that Nacre consists of a multitude of layers of Carbonate of Lime alternating with Animal Membrane ; and that the presence of the grooved lines on the most highly-polished surface is due to the wearing-away of the edges of the animal laminae, whilst those of the hard calcareous laminae stand out. If each line upon the nacreous surface, however, indicates a distinct layer

* "Philosophical Transactions," 1814.—The late Mr. Barton (of the Mint) succeeded in producing an artificial Iridescent on metallic buttons, by drawing closely-approximated lines with a diamond-point upon the surface of the steel die by which they were struck.

of Shell-substance, a very thin section of Mother-of-Pearl ought to contain many hundred laminae, in accordance with the number of lines upon its surface; these being frequently no more than 1-7500th of an inch apart. But when the Nacre is treated with

FIG. 310.

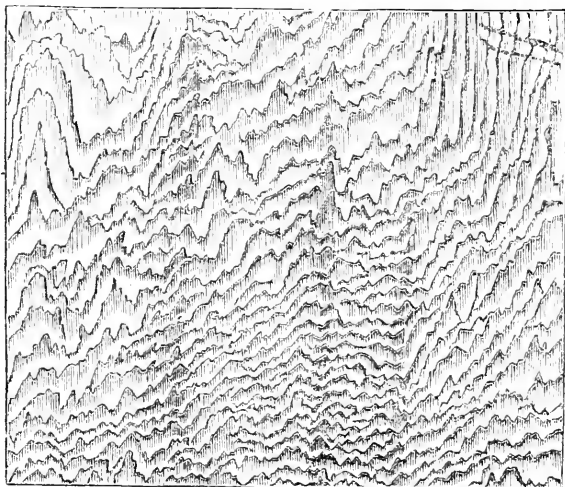

Section of Nacreous lining of Shell of *Avicula margaritacea* (Pearl-oyster).

dilute acid so as to dissolve its calcareous portion, no such repetition of Membranous layers is to be found; on the contrary, if the piece of Nacre be the product of one act of shell-formation, there is but a single layer of Membrane. This layer, however, is found to present a more or less folded or plaited arrangement; and the lineation of the nacreous surface may perhaps be thus accounted for. A similar arrangement is found in *Pearls*; which are rounded concretions projecting from the inner surface of the *Avicula*, and possessing a Nacreous structure corresponding to that of 'Mother-of-Pearl.' Such concretions are found in many other Shells, especially the Fresh-water Mussels, *Unio* and *Anodon*; but these are usually less remarkable for their pearly lustre, and when formed at the edge of the valves, they may be partly or even entirely made-up of the Prismatic substance of the external layer, and may be consequently altogether destitute of the pearly character.

463. There are several Bivalve Shells which present what may be termed a *Sub-Nacreous* structure, their polished surfaces being marked by lines, but these lines being destitute of that regularity of arrangement which is necessary to produce the Iridescent

lustre. This is the case, for example, with most of the *Pectinidæ* (or Scallop tribe), also with some of the *Mytilacæ* (or Mussel tribe), and with the common *Oyster*. In the internal layer of by far the greater number of Bivalve Shells, there is not the least approach to the Nacreous aspect; the presence of true Nacre being exceptional, save in a small number of Families.*

464. The ordinary account of the mode of growth of the Shells of Bivalve Mollusca,—that they are progressively enlarged by the deposition of new laminae, each of which is in contact with the internal surface of the preceding, and extends beyond it,—does not express the whole truth; for it takes no account of the fact that most Shells are composed of two layers of very different texture, and does not specify whether *both* these layers are thus formed by the entire surface of the Mantle whenever the shell has to be extended, or whether only *one* is produced. An examination of Fig. 311 will clearly show the mode in which the operation is

FIG. 311.

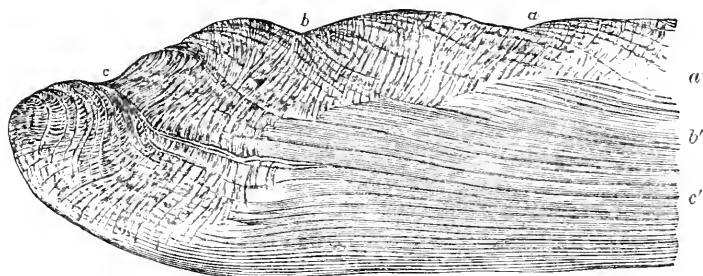

Vertical section of the lip of one of the valves of the shell of *Unio*:—*a, b, c*, successive formations of the Outer Prismatic layer; *a', b', c'*, the same of the inner Nacreous layer.

effected. This figure represents a section of one of the valves of *Unio oscidens*, taken perpendicularly to its surface, and passing from the margin or lip (at the left hand of the figure) towards the hinge (which would be at some distance beyond the right). This section brings into view the two substances of which the Shell is composed; traversing the outer or Prismatic layer in the direction of the length of its prisms, and passing through the Nacreous lining in such a manner as to bring into view its numerous laminae, separated by the lines *a a', b b', c c'*, &c. These lines evidently indicate the successive formations of this layer; and it may be easily shown, by tracing them towards the hinge on the one side and towards the margin on the other, that at every enlargement

* For an explanation of the real nature of what was formerly described by the Author as 'Tubular Shell-substance,' see § 267.

of the Shell its whole interior is lined by a new Nacreous lamina in immediate contact with that which preceded it. The number of such laminae, therefore, in the oldest part of the shell, indicates the number of enlargements which it has undergone. The outer or Prismatic layer of the growing shell, on the other hand, is only formed where the new structure projects beyond the margin of the old; and thus we do not find one layer of it overlapping another, except at the lines of junction of two distinct formations. When the Shell has attained its full dimensions, however, new laminae of both layers still continue to be added; and thus the lip becomes thickened by successive formations of Prismatic structure, each being applied to the inner surface of the preceding, instead of to its free margin. A like arrangement may be well seen in the *Oyster*; with this difference, that the successive layers have but a comparatively slight adhesion to each other.

465. The shells of *Terebratula*, and of several other Genera of *Brachiopoda*, are distinguished by peculiarities of structure which serve to distinguish them from all others. When thin sections of them are Microscopically examined, they exhibit the appearance of long flattened Prisms (Fig 312, A, B), which are arranged with

FIG. 312.

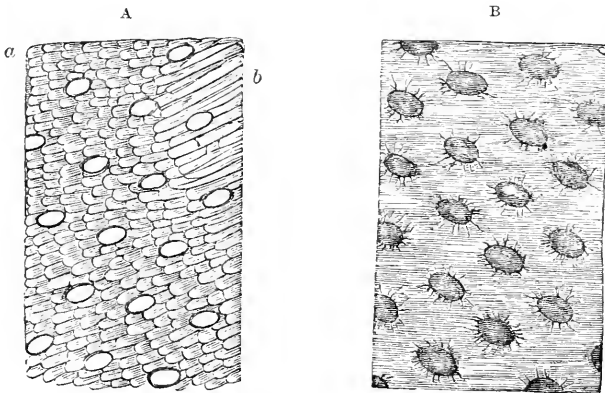

A, Internal surface (a), and oblique section (b), of Shell of *Terebratula* (*Waldheimia*) *australis*: B, external surface of the same.

such obliquity that their rounded extremities crop-out upon the inner surface of the Shell in an imbricated (tile-like) manner (a). All true *Terebratulidæ*, both Recent and Fossil, exhibit another very remarkable peculiarity; namely, the perforation of the Shell by a large number of Canals, which generally pass nearly perpendicularly from one surface to the other (as is shown in vertical sections, Fig. 313), and terminate internally by open orifices

(Fig. 312, A), whilst externally they are covered by the Periostracum (B). Their diameter is greatest towards the external surface, where they sometimes expand suddenly, so as to become trumpet-shaped; and it is usually narrowed rather suddenly, when, as sometimes happens, a new internal layer is formed as a lining to the preceding (Fig. 313, A, *d d*). Hence the diameter of these Canals,

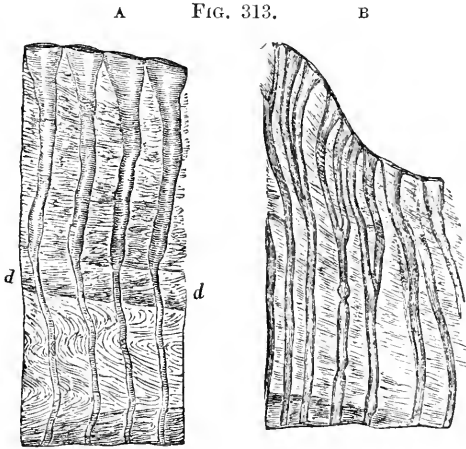

as shown in different transverse sections of one and the same Shell, will vary according to the part of its thickness which the section happens to traverse. The shells of different species of perforated *Brachiopods*, however, present very striking diversities in the size and closeness of their Canals, as shown by sections taken in corresponding parts; three examples of this kind are given for the sake of comparison in Figs. 314-316. These Canals are occupied in the living state by tubular prolongations of the Mantle, whose interior is filled with a fluid containing minute cells and granules, which, from its corresponding in appearance with the fluid contained in the great sinuses of the mantle, may be considered to be the animal's Blood. Hence these cæcal tubes may be inferred to possess a Respiratory function.

466. In the Family *Rhynchonellidæ*, which is represented by only two Recent species (the *Rh. psittacea* and *Rh. nigricans*, both of which formerly ranked as *Terebratulæ*), but which contains a very large proportion of Fossil *Brachiopods*, these Canals are entirely absent; so that the uniformity of their presence in the *Terebratulidæ*, and of their absence in the *Rhynchonellidæ*, supplies a character of great value in the discrimination of the fossil shells belonging to these two groups respectively. Great caution is necessary, however, in applying this test; *mere surface-markings cannot be relied-on*; and no statement on this point is worthy of reliance, which is not based on a Microscopic examination of thin

Sections of the shell.—In the Families *Spiriferidæ* and *Strophomenidæ*, on the other hand, some Species possess the perforations, whilst others are destitute of them; so that their presence or

FIG. 314.



FIG. 315.

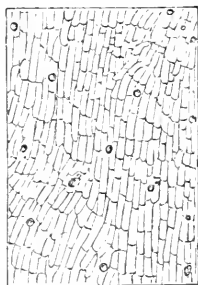

FIG. 316.

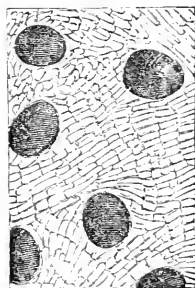

Fig. 314. Horizontal section of Shell of *Terebratula bullata* (fossil, Oolite).
 Fig. 315. Ditto of *Megerlia lima* (fossil, Chalk).
 Fig. 316. Ditto of *Spiriferina rostrata* (Triassic).

absence *there* serves only to mark-out subordinate groups. This, however, is what holds-good in regard to characters of almost every description, in other departments of Natural History; a character which is of fundamental importance from its close relation to the general plan of organization in one group, being, from its want of constancy, of far less account in another.*

467. There is not by any means the same amount of diversity in the structure of the Shell in the class of *Gasteropoda*; a certain typical plan of construction being common to by far the greater number of them. The small proportion of Animal matter contained in most of these Shells, is a very marked feature in their character; and it serves to render other features indistinct, since the residuum left after the removal of the Calcareous matter is usually so imperfect, as to give no clue whatever to the explanation of the appearances shown by sections. Nevertheless, the structure of these shells is by no means homogeneous, but always exhibits indications, more or less clear, of a definite arrangement. The

* For a particular account of the Author's researches on this group, see his Memoir on the subject, forming part of the introduction of Mr. Davidson's "Monograph of the British Fossil Brachiopoda," published by the Palæontographical Society.—A very remarkable example of the importance of the presence or absence of the perforations, in distinguishing Shells whose internal structure shows them to be Generically different, whilst from their external conformation they would be supposed to be not only *generically* but *specifically identical*, will be found in the "Annals of Natural History," Ser. 3, Vol. xx. (1867), p. 68.

'Porcellanous' Shells are composed of three layers, all presenting the same kind of structure, but each differing from the others in the mode in which this is disposed. For each layer is made-up of an assemblage of thin laminae placed side-by-side, which separate one from another, apparently in the planes of rhomboidal cleavage, when the shell is fractured; and, as was first pointed-out by Mr. Bowerbank, each of these laminae consists of a series of elongated spicules (considered by him as prismatic cells filled with carbonate of lime) lying side-by-side in close apposition; and these series are disposed alternately in contrary directions, so as to intersect each other nearly at right angles, though still lying in parallel planes. The direction of the planes is different, however, in the three layers of the Shell, bearing the same relation to each other as have those three sides of a cube which meet each other at the same angle; and by this arrangement, which is better seen in the fractured edge of the *Cypraea* or any similar shell, than in thin sections, the strength of the Shell is greatly augmented.—A similar arrangement, obviously answering the same purpose, has been shown by Mr. Tomes to exist in the Enamel of the Teeth of Rodentia.

468. The principal departures from this plan of structure are seen in *Patella*, *Chiton*, *Haliotis*, *Turbo* and its allies, and in the 'Naked' Gasteropods, many of which last, both Terrestrial and Marine, have some rudiment of a shell. Thus in the common Slug, *Limax rufus*, a thin oval plate of Calcareous texture is found imbedded in the shield-like fold of the mantle covering the fore-part of its back; and if this be examined in an early stage of its growth, it is found to consist of an aggregation of minute calcareous nodules, generally somewhat hexagonal in form, and sometimes quite transparent, whilst in other instances presenting an appearance closely resembling that delineated in Fig. 309.—In the Epidermis of the Mantle of some species of *Doris*, on the other hand, we find long Calcareous Spicules, generally lying in parallel directions, but not in contact with each other, giving firmness to the whole of its dorsal portion; and these are sometimes covered with small tubercles, like the Spicules of *Gorgonia* (Fig. 233). They may be separated from the soft tissue in which they are imbedded, by means of caustic Potash; and when treated with dilute acid, whereby the Calcareous matter is dissolved-away, an Organic basis is left, retaining in some degree the form of the original spicule. This basis cannot be said to be a true Cell; but it seems to be rather a cell in the earliest stage of its formation, being an isolated particle of Sarcodæ without wall or cavity; and the close correspondence between the appearance presented by thin sections of various Univalve Shells, and the forms of the Spicules of *Doris*, seems to justify the conclusion that even the most compact Shells of this group are constructed out of the like elements, in a state of closer aggregation and more definite arrangement, with the occasional occurrence of a layer of more Spheroidal bodies of

the same kind, like those forming the rudimentary shell of *Limax*.

469. The animals composing the Class of *Cephalopoda* (Cuttle-fish and Nautilus tribe) are for the most part unpossessed of Shells ; and the structure of the few that we meet-with in the genera *Nautilus*, *Argonauta* (Paper-nautilus), and *Spirula*, does not present any peculiarities that need here detain us. The rudimentary Shell or *Sepiostaire* of the common Cuttle-fish, however, which is frequently spoken-of as the Cuttle-fish Bone, exhibits a very beautiful and remarkable structure, such as causes sections of it to be very interesting Microscopic objects. The outer shelly portion of this body consists of horny layers, alternating with calcified layers, in which last may be seen a hexagonal arrangement somewhat corresponding with that in Fig. 309. The soft friable substance that occupies the hollow of this boat-shaped shell, is formed of a number of delicate Calcareous plates, running across it from one side to the other in parallel directions, but separated by intervals several times wider than the thickness of the plates ; and these intervals are in great part filled-up by what appear to be fibres or slender pillars, passing from one plate or floor to another. A more careful examination shows, however, that instead of a large number of detached pillars, there exists a comparatively small number of very thin sinuous laminae, which pass from one surface to the other, winding and doubling upon themselves, so that each lamina occupies a considerable space. Their precise arrangement is best seen by examining the parallel plates, after the sinuous laminae have been detached from them ; the lines of junction being distinctly indicated upon these. By this arrangement each layer is most effectually supported by those with which it is connected above and below ; and the sinuosity of the thin intervening laminae, answering exactly the same purpose as the 'corrugation' given to Iron plates for the sake of diminishing their flexibility, adds greatly to the strength of this curious texture ; which is at the same time lightened by the large amount of open space between the parallel plates, that intervenes among the sinuosities of the laminae. The best method of examining this structure, is to make Sections of it with a sharp knife in various directions, taking care that the sections are no thicker than is requisite for holding-together ; and these may be mounted on a Black Ground as Opaque objects, or in Canada Balsam as Transparent objects, under which aspect they furnish very beautiful objects for the Polariscope.

470. The structure of Shells generally is best examined by making *Sections* in different planes, as nearly parallel as may be possible to the surfaces of the shell ; and other Sections at right angles to these : the former may be designated as *horizontal*, the latter as *vertical*. Nothing need here be added to the full directions for making such Sections which have already been given (§§ 138-140). Much valuable information may also be derived,

however, from the examination of the surfaces presented by *fracture*. The Membranous residua left after the Decalcification of the shell by dilute acid, may be mounted in weak Spirit or in Goadby's solution.

471. *Tongue of Gasteropod Mollusks.*—The organ which is commonly known under this designation is one of a very singular nature; and we should be altogether wrong in conceiving of it as having any likeness to that on which our ordinary ideas of such an organ are founded. For instead of being a projecting body lying in the cavity of the mouth, it is a tube that passes backwards and downwards beneath the mouth; its hinder end being closed, whilst in front it opens obliquely upon the floor of the mouth, being (as it were) slit-up and spread-out so as to form a nearly flat surface.

FIG. 317.

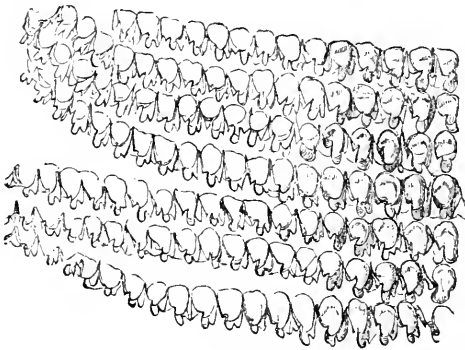

Portion of the left half of the Tongue of *Helix hortensis*; the rows of Teeth near the edge separated from each other to show their form.

FIG. 318.

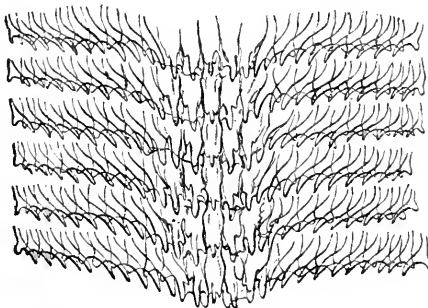

Tongue of *Zonites cellarius*.

On the interior of the tube, as well as on the flat expansion of it, we find numerous transverse rows of minute Teeth, which are set upon flattened plates; each principal tooth sometimes having a basal plate of its own, whilst in other instances one plate carries several teeth.—Of the former arrangement we have an example in the 'Tongue' of many Terrestrial Gasteropods, such as the Snail (*Helix*) and Slug (*Limax*), in which the number of plates in each row is very considerable (Figs. 317, 318), amounting to 180 in the large garden Slug (*Limax maximus*); whilst the latter prevails in

many Marine Gasteropods, such as the common Whelk (*Buccinum undatum*), the tongue of which has only three plates in each row, one bearing the small central teeth, and the two others the large lateral teeth (Fig. 321). The length of the Tongue, and the number of rows of Teeth, vary greatly in different species. Generally speaking, the Tongue of the Terrestrial Gasteropods is short, and is contained entirely within the nearly globular head; but the rows of Teeth being closely set together are usually very numerous, there being frequently more than 100, and in some species as many as 160 or 170; so that the total number of Teeth may mount-up, as in *Helix pomatia*, to 21,000, and in *Limax maximus*, to 26,800. The transverse rows are usually more or less curved, as shown in Fig. 318, whilst the longitudinal rows are quite straight; and the curvature takes its departure on each side from a central longitudinal row; the Teeth of which are symmetrical, whilst those of the lateral portions of each transverse row present a modification of that symmetry, the prominences on the *inner* side of each tooth being suppressed, whilst those on the outer side are increased; this modification being observed to augment in degree, as we pass from the central line towards the edges.

472. The Tongue of the Marine Gasteropods is generally longer, and its teeth larger; and in many instances it extends far beyond the head, which may, indeed, contain but a small part of it. Thus in the common Limpet (*Patella*), we find the principal part of the Tongue to lie folded up, but perfectly free, in the Abdominal cavity, between the intestines and the muscular foot; and in some species its length is twice or even three times as great as that of the entire animal. In a large proportion of cases, these Tongues exhibit a very marked separation between the central and the lateral portions (Figs. 319, 321); the Teeth of the central band being frequently small and smooth at their edges, whilst those of the lateral are large and ser-

FIG. 319.

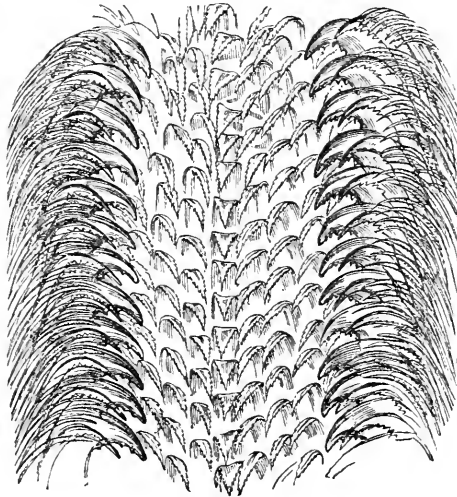
Tongue of *Trochus zizyphinus*.

rated. The Tongue of *Trochus zizyphinus*, represented in Fig. 319, is one of the most beautiful examples of this form; not

FIG. 320.

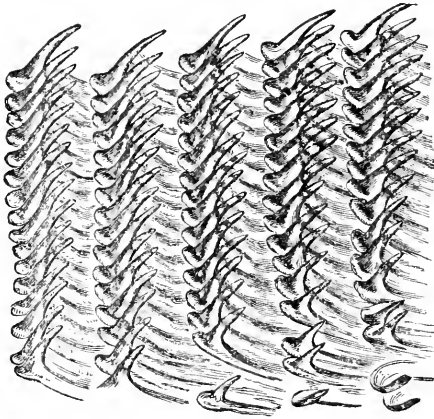

Tongue of *Doris tuberculata*.

only the large Teeth of the lateral bands, but the delicate leaf-like Teeth of the central portion, having their edges minutely serrated. A yet more complex type, however, is found in the Tongue of *Haliotis*; in which there is a central band of Teeth having nearly straight edges instead of points; then, on each side, a lateral band consisting of large Teeth shaped like those of the Shark; and beyond this, again, another lateral band on either side, composed of several rows of smaller teeth. Very curious differences also present themselves among the different species of the same Genus. Thus in *Doris pilosa*, the central band is almost entirely wanting, and each lateral band is formed of a single row of very large hooked teeth, set obliquely, like those of the lateral band in Fig. 319; whilst in *Doris tuberculata*, the central band is the part most developed, and contains a number of rows of conical Teeth, standing almost perpendicularly, like those of a harrow (Fig. 320).

473. Many other varieties might be described, did space permit; but we must be content with adding, that the form and arrangement of the Teeth afford characters of great value in classification, as was first pointed-out by Prof. Lovèn (of Stockholm) in 1847, and has been since very strongly urged by Dr. J. E. Gray, who considers that the structure of the Tongue is one of the best guides to the natural affinities of the Species, Genera, and Families of this group, since any important alteration in the form or position of the Teeth must be accompanied by some corresponding peculiarity in the habits and food of the animal.* Hence a systematic examination and delineation of the structure and arrangement of these organs, by the aid of the Microscope and Camera Lucida, would be of the greatest service to this department of Natural History. The short thick tube of the *Limax* and other Terrestrial Gasteropods, appears adapted for the trituration of the food pre-

* "Annals of Natural History," Ser. 2, Vol. x. (1852), p. 413.

vously to its passing into the Œsophagus; for in these animals we find the roof of the mouth furnished with a large strong horny plate, against which the flat end of the tongue can work. On the other hand, the flattened portion of the Tongue of *Buccinum* and its allies is used by these animals as a file, with which they bore holes through the shells of the Mollusks that serve as their prey; this they are enabled to effect by everting that part of the proboscis-shaped mouth whose floor is formed by the flattened part of the tongue, which is thus brought to the exterior, and by giving a kind of sawing-motion to the organ by means of the alternate action of two pairs of muscles,—a protractor, and a retractor,—which put-forth and draw-back a pair of Cartilages whereon the tongue is supported, and also elevate and depress its teeth. Of the use of the long blind tubular part of the Tongue in these Gasteropods, however, scarcely any probable guess can be made; unless it be a sort of 'cavity of reserve,' from which a new toothed surface may be continually supplied as the old one is worn-away, somewhat as the front Teeth of the Rodents are constantly being regenerated from the surface of the pulps which occupy their hollow conical bases, as fast as they are rubbed-down at their edges.

474. The preparation of these Tongues for the Microscope can, of course, be only accomplished by carefully dissecting them from their attachments within the head; and it will be also necessary to remove the membrane that forms the sheath of the tube, when this is thick enough to interfere with its transparency. The tube itself should be slit-up with a pair of fine scissors through its entire length; and should be so opened out, that its expanded surface may be a continuation of that which forms the floor of the mouth. The mode of mounting it will depend upon the manner in which it is to be viewed. For the ordinary purposes of Microscopic examination, no method is so good as mounting in fluid; either weak Spirit or Goadby's solution answering very well. But many of these Tongues, especially those of the marine Gasteropods, become most beautiful objects for the Polariscope when they are mounted in Canada Balsam; the form and arrangement of the

FIG. 321.

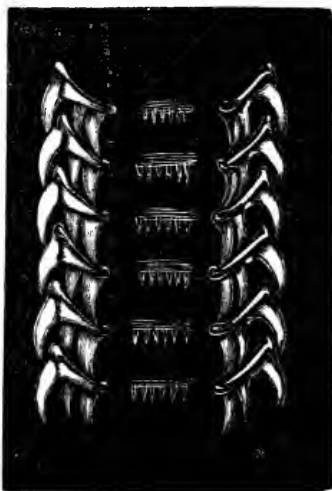

Palate of *Buccinum undatum* as seen under Polarized Light.

Teeth being very strongly brought-out by it (Fig. 321), and a gorgeous play of colours being exhibited when a Selenite plate is placed behind the object, and the analyzing prism is made to rotate.*

475. *Development of Mollusca.*—Although no application of the Microscope is more important to the scientific Physiologist than that which enables him to watch the successive steps of the process of the Development of organized structures, yet the ordinary Microscopist cannot be expected to feel the same interest in its history, and will expect only to have his attention directed to such of its phenomena as are of most general interest. The study of the early stages of the Embryonic Development of Bivalve Mollusks is attended with considerable difficulty, and has been, with few exceptions, but very incompletely prosecuted. Of the very unsatisfactory nature of our present knowledge of its history, we have a marked example in the fact that what are undoubtedly the Embryoes of a fresh-water Mussel, the *Anodon cygneus*, when found adhering to the gills of their parent, have been described as Parasites, under the name of *Glochidium*, and are still maintained to be such by some persons who assume to be authorities on the subject. It has been lately shown † that these Embryoes, after being excluded from between the valves of their parent, attach themselves in a peculiar manner to the fins and gills of small Fishes (Fig. 322, A). In this stage of the existence of the young *Anodon*, its valves are provided with curious barbed or serrated hooks (D, B), and are continually snapping together (so as to remind the observer of the *Aricularia* of Polyzoa, § 451), until they have inserted their hooks into the skin of the Fish, which seems so to retain the barbs as to prevent the re-opening of the valves. In this stage of its existence no internal organ is definitely formed, except the strong 'adductor' Muscle (C, A) which draws the valves together, and the long, slender, byssus-filament (B, A, D) which makes its appearance while the embryo is still within the egg-membrane, lying coiled-up between the lateral lobes. The hollow of each valve is filled with a soft granular-looking mass, in which are to be distinguished what are perhaps the rudiments of the branchiæ and of oral tentacles; but their nature can only be certainly determined by further observation, which is rendered difficult by the opacity of the valves. By keeping an adequate supply of Fish, however, with these embryoes attached, any dexterous Microscopist may overcome this difficulty, and may work out the

* For additional details on the organization of the Tongue and Teeth of the Gasteropod Mollusks, see Mr. W. Thomson, in "Cyclop. of Anat. and Physiol.," Vol. iv., pp. 1142, 1143; and in "Ann. of Nat. Hist.," Ser. 2, Vol. vii., p. 86.

† See the Rev. W. Houghton 'On the Parasitic Nature of the Fry of the *Anodonta cygnea*,' in "Quart. Journ. of Microsc. Sci.," N.S., Vol. ii. (1861), p. 162.

entire history of the development of the fresh-water Mussel as successfully as M. Lacaze Duthiers has worked out an important part of that of the common *Mytilus edulis* or true Mussel.*

FIG. 322.

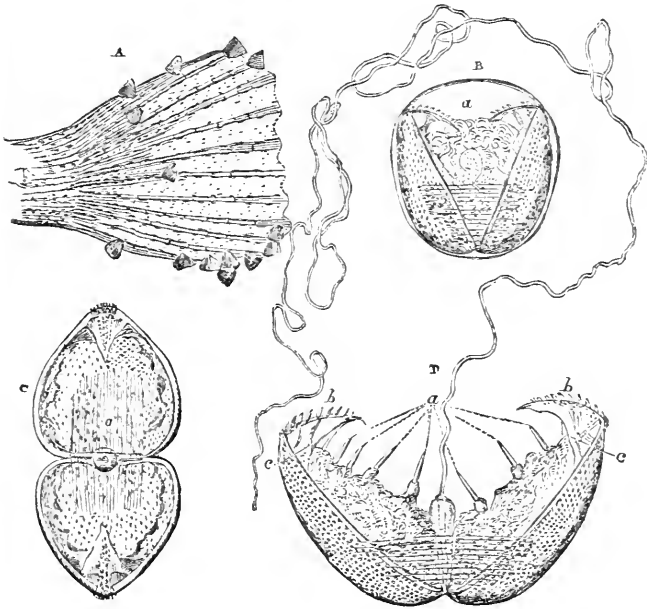

Parasitic Larva ('Glochidium') of *Anodon*.—A, Glochidia attached to the tail of a Stickleback; B, side view of Glochidium still enclosed in the egg-membrane, showing the hooks of its valves and the byssus-filament *a*; c, Glochidium with its valves widely opened, showing the adductor-muscle *a*; D, side view of Glochidium, with the valves opened to show the origin of the byssus-filament and the three pairs of tentacular ? organs, the barbed hooks *b*, and the muscular or membranous folds *c, c*, connected with them.

476. The history of Embryonic Development may be studied with peculiar facility in certain members of the Class of *Gasteropods*, and presents numerous phenomena of great interest. The Eggs (save among the Terrestrial species) are usually deposited in aggregate masses, each enclosed in a common protective envelope or *Nidamentum*. The nature of this Envelope, however, varies

* See his admirable 'Mémoire sur le Développement des Branchies des Mollusques Acéphales Lamellibranches,' in "Ann. des Sciences Nat.," Sér. 4, Tom. v. (1856), p. 5.

FIG. 323.

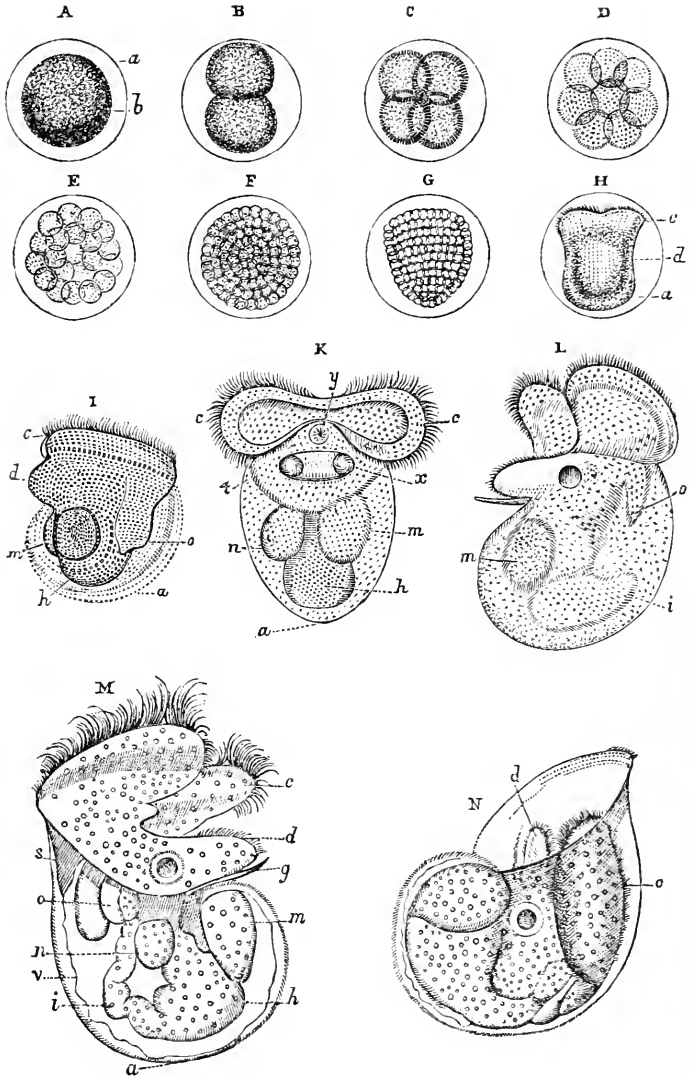

Embryonic Development of *Doris bilamellata*:—A, Ovum, consisting of Enveloping membrane *a* and yolk *b*; B, C, D, E, F, successive stages of Segmentation of Yolk; *c*, first marking-out of the shape of the Embryo; H, Embryo on the 8th day; I, the same on the 9th day; K, the same on the 12th day, seen on the left

greatly: thus in the common *Lymnæus stagnalis* or 'Water-Snail' of our ponds and ditches, it is nothing else than a mass of soft jelly about the size of a sixpence, in which from 50 to 60 eggs are imbedded, and which is attached to the leaves or stems of aquatic plants; in the *Buccinum undatum*, or common Whelk, it is a membranous case, connected with a considerable number of similar cases by short stalks, so as to form large globular masses which may often be picked-up on our shores, especially between April and June; in the *Purpura lapillus*, or Rock-Whelk, it is a little flask-shaped capsule, having a firm horny wall, which is attached by a sort of foot to the surface of rocks between the tide-marks, great numbers being often found standing erect side by side; whilst in the *Nudibranchiate* order generally (consisting of the *Doris*, *Eolis*, and other 'Sea-Slugs') it forms a long tube with a membranous wall, in which immense numbers of eggs (even half a million or more) are packed closely together in the midst of a jelly-like substance, this tube being disposed in coils of various forms, which are usually attached to Sea-weeds or Zoophytes.—The course of Development, in the first and last of these instances, may be readily observed from the very earliest period down to that of the emersion of the Embryo; owing to the extreme transparency of the Nidamentum and of the egg-membranes themselves. The first change which will be noticed by the ordinary observer, is the 'Segmentation' of the Yolk-mass, which divides itself (after the manner of a cell undergoing binary subdivision) into two parts, each of these two into two others, and so on, until a mulberry-like mass of minute yolk-segments is evolved (Fig. 323, A—F). Soon after this 'Mulberry mass' has been formed, it commonly begins to exhibit a very curious alternating rotation within the egg, two or three turns being made in one direction, and the same number in a reverse direction: this movement, which is due to Ciliary action, is often extremely transitory in its duration; but in the *Lymnæus* it continues almost up to the escape of the embryo, and, when several Ova are brought into view at once under a low magnifying power, the spectacle is a very curious one.

477. A separation is usually seen at an early period, between the anterior or Cephalic portion, and the posterior or Visceral portion, of the Embryonic mass; and the development of the former advances with the greater activity. One of the first changes

side at L; M, still more advanced Embryo, seen at N as retracted within its shell:—*a*, superficial layer of Yolk-segments coalescing to give origin to the Shell; *c, c*, Ciliated Lobes; *d*, Foot; *g*, hard plate or operculum attached to it; *h*, Stomach; *i*, Intestine; *m, n*, masses (glandular) at the sides of the œsophagus; *o*, Heart?; *s*, Retractor Muscle (?); *t*, situation of Funnel; *v*, membrane enveloping the body; *x*, Auditory Vesicles; *y*, Mouth.

which is seen in it consists in its extension into a sort of fin-like membrane on either side, the edges of which are fringed with long Cilia (Fig. 323, H—L, c), whose movements may be clearly distinguished whilst the Embryo is still shut-up within the egg; at a very early period may also be discerned the 'Auditory Vesicles' (κ , α) or rudimentary Organs of Hearing (§ 482), which scarcely attain any higher development in these creatures during the whole of life; and from the immediate neighbourhood of these is put-forth a projection, which is afterwards to be evolved into the 'Foot' or Muscular disk of the animal. While these organs are making their appearance, the Shell is being formed on the surface of the posterior portion, appearing first as a thin covering over its hinder part, and gradually extending itself until it becomes large enough to enclose the Embryo completely, when this contracts itself. The Ciliated Lobes are best seen in the Embryoes of *Nudibranchs*, in which they are much larger than in *Lymnæus*; and the fact of the universal presence of a Shell in the Embryoes of the former group is of peculiar interest, as it is destined to be cast-off very soon after they enter upon active life. These Embryoes may be seen to move-about as freely as the narrowness of their prison permits, for some time previous to their emersion; and when set free by the rupture of the egg-cases, they swim forth with great activity by the action of their ciliated lobes,—these, like the 'Wheels' of Rotifera, serving also to bring food to the mouth, which is at that time unprovided with the reducing apparatus subsequently found in it. The same is true of the Embryo of *Lymnæus*, save that its swimming movements are less active, in consequence of the inferior development of the ciliated lobes; and the currents produced by these seem to have reference chiefly to the provision of supplies of food, and of aerated water for respiration. The disappearance of the Cilia has been observed by Mr. Hogg to be coincident with the development of the Teeth to a degree sufficient to enable the young Water-Snail to crop its Vegetable food; and he has further ascertained that if the growing animal be kept in fresh water alone for some time, without vegetable matter of any kind, the gastric teeth are very imperfectly developed, and the cilia are still retained.*

478. A very curious modification of the ordinary plan of Development is presented in the *Purpura lapillus*; and it is probable that something of the same kind exists also in *Buccinum*, as well as in other Gasteropods of the same extensive Order (*Pectinibranchiata*).—Each of the capsules already described (§ 476) contains from 500 to 600 Egg-like bodies (Fig. 324, A), imbedded in a viscid gelatinous substance; but only from 12 to 30 Embryoes usually attain complete development; and it is obvious from the large comparative size which these attain (Fig. 325, B), that each

* See "Transact. of Microsc. Soc.," 2nd Ser., Vol. ii. (1854), p. 93.

of them must include an amount of substance equal to that of a great number of the bodies originally found within the capsule. The explanation of this fact (long since noticed by Dr. J. E. Gray in regard to Buccinum) seems to be as follows:—Of those

500 or 600 Egg-like bodies, only a small part are true *Ova*, the remainder being merely *Yolk-spherules*, which are destined to serve for the nutrition of the Embryoes. The distinction between them manifests itself at a very early period, even in the first segmentation; for while the *Yolk-spherules* divide into two equal hemispheres (Fig. 324, B), the real *Ova* divide into a larger and a smaller

FIG. 324.

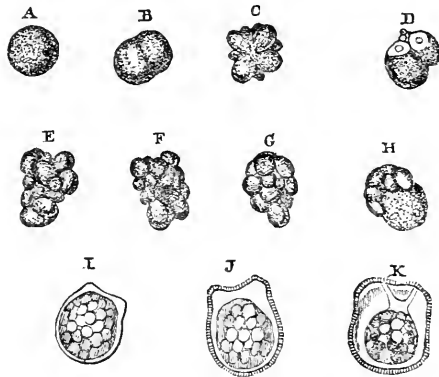

Early stages of Embryonic Development of *Purpura lapillus*:—A, egg-like spherule; B, C, E, F, G, successive stages of segmentation of yolk-spherules; D, H, I, J, K, successive stages of development of early embryoes.

segment (D); in the cleft between these are seen the minute 'directive vesicles,' which appear to be always double or even triple, although, from being seen 'end-on,' only one may be visible; and near these is generally to be seen a clear space in each segment. The difference is still more strongly marked in the subsequent divisions; for whilst the cleavage of the *Yolk-spherules* goes on irregularly, so as to divide each into from 14 to 20 segments, having no definiteness of arrangement (C, E, F, G), that of the *Ova* takes place in such a manner as to mark-out the distinction already alluded-to between the Cephalic and the Visceral portions of the mass (H); and the evolution of the former into distinct organs very speedily commences. In the first instance, a narrow transparent border is seen around the whole Embryonic mass, which is broader at the Cephalic portion (I); next, this border is fringed with short Cilia, and the cephalic extension into two Lobes begins to show itself; and then between the lobes a large Mouth is formed, opening through a short, wide Œsophagus, the interior of which is ciliated, into the Visceral cavity, occupied as yet only by the yolk-particles originally belonging to the ovum (K).

479. Whilst these developmental changes are taking place in the Embryo, the whole aggregate of segments formed by the subdivision of the *Yolk-spherules* coalesces into one mass, as shown

at A, Fig. 325 ; and the embryos are often, in the first instance, so completely buried within this, as only to be discoverable by tearing its portions asunder ; but some of them may commonly be found upon its exterior ; and those contained in one capsule very

FIG. 325.

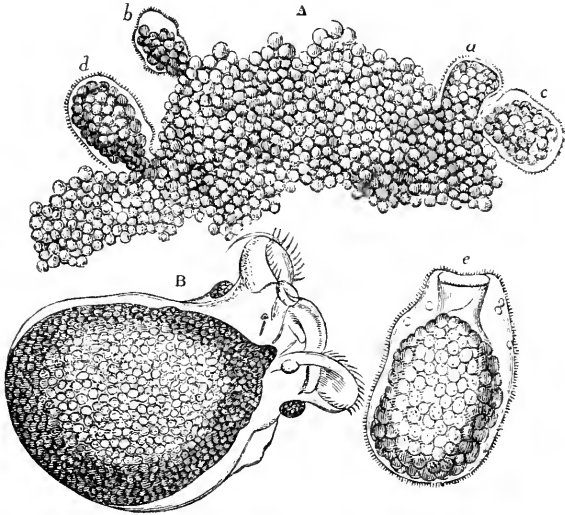

Later stages of Embryonic Development of *Purpura lapillus*.—A, conglomerate mass of vitelline segments, to which were attached the embryos, a, b, c, d, e :—B, full-sized embryo, in more advanced stage of development.

commonly exhibit the different stages of development represented in Fig. 324, H—K. After a short time, however, it becomes apparent that the most advanced Embryoes are beginning to swallow the Yolk-segments of the conglomerate mass ; and capsules will not unfrequently be met-with, in which Embryoes of various sizes, as a, b, c, d, e (Fig. 325, A), are projecting from its surface, their difference of size not being accompanied by advance in development, but merely depending upon the amount of this 'supplemental' Yolk which the Embryoes have respectively gulped-down. For during the time in which they are engaged in appropriating this additional supply of nutriment, although they increase in size, yet they scarcely exhibit any other change ; so that the large Embryo, Fig. 325, e, is not apparently more advanced as regards the formation of its organs, than the small embryo, Fig. 324, K. So soon as this operation has been completed, however, and the Embryo has attained its full bulk, the evolution of its organs

takes-place very rapidly; the ciliated lobes are much more highly developed, being extended in a long sinuous margin, so as almost to remind the observer of the 'Wheels' of Rotifera (§ 354), and being furnished with very long Cilia (Fig. 325, B); the Auditory Vesicles, the Tentacula, the Eyes, and the Foot, successively make their appearance; a curious rhythmically-contractile Vesicle is seen, just beneath the edge of the shell in the region of the neck, which may, perhaps, serve as a temporary heart; a little later, the real Heart may be seen pulsating beneath the dorsal part of the shell; and the mass of yolk-segments of which the body is made-up, gradually shapes itself into the various organs of Digestion, Respiration, &c., during the evolution of which (and while they are as yet far from complete) the Capsule thins-away at its summit, and the Embryoes make their escape from it.*

480. It happens not unfrequently that one of the Embryoes which a Capsule contains does not acquire its Supplemental Yolk in the manner now described, and can only proceed in its development as far as its original yolk will afford it material; and thus, at the time when the other embryoes have attained their full size and maturity, a strange-looking creature, consisting of two large ciliated lobes with scarcely the rudiment of a body, may be seen in active motion among them. This may happen, indeed, not only to one but to several Embryoes within the same Capsule, especially if their number should be considerable; for it sometimes appears as if there were not food enough for all, so that whilst some attain their full dimensions and complete development, others remain of unusually small size, without being deficient in any of their organs, and others again are more or less completely abortive,—the supply of supplemental yolk which they have obtained having been too small for the development of their Viscera, although it may have afforded what was needed for that of the Ciliated Lobes, Eyes, Tentacles, Auditory vesicles, and even the Foot,—or, on the other hand, no additional supply whatever having been acquired by them, so that their development has been arrested at a still earlier stage.—These phenomena are of so novel and remarkable a character, that they furnish an abundant source of interest to any Microscopist who may happen to be spending the months of August and September in a locality in which the *Purpura* abounds; since, by opening a sufficient number of Capsules, no difficulty need be experienced in arriving at all the facts which have been noticed in this

* The Author thinks it worth while to mention the method which he has found most convenient for examining the contents of the Capsules of *Purpura*; as he believes that it may be advantageously adopted in many other cases. This consists in cutting-off the two ends of the capsule (taking care not to cut far into its cavity), and in then forcing a jet of water through it, by inserting the end of a fine-pointed Syringe (§ 101) into one of the orifices thus made, so as to drive the contents of the capsule before it through the other. These should be received into a shallow cell, and first examined under the Simple Microscope.

brief summary.* It is much to be desired that such Microscopists as possess the requisite opportunity, would apply themselves to the study of the corresponding history in other Pectinibranchiate Gasteropods, with a view of determining how far the plan now described prevails through the Order. And now that these Mollusks have been brought not only to live, but to breed, in artificial *Vivaria*, it may be anticipated that a great addition to our knowledge of this part of their life-history will ere long be made.

481. *Ciliary Motion on Gills*.—There is no object that is better suited to exhibit the general phenomena of Ciliary Motion (§ 352), than a portion of the Gill of some Bivalve Mollusk. The *Oyster* will answer the purpose sufficiently well; but the Cilia are much larger on the gills of the *Mussel*,† as they are also on those of the *Anodon* or common Fresh-water Mussel of our ponds and streams. Nothing more is necessary than to detach a small portion of one of the riband-like bands, which will be seen running parallel with the edge of each of the valves when the shell is opened; and to place this, with a little of the liquor contained within the shell, upon a slip of glass,—taking care to spread it out sufficiently with needles to separate the *bars* of which it is composed, since it is on the edges of these, and round their knobbed extremities, that the Ciliary movement presents itself,—and then covering it with a thin-glass disk. Or it will be convenient to place the object in the Aquatic Box, which will enable the observer to subject it to any degree of pressure that he may find convenient. A magnifying power of about 120 diameters is amply sufficient to afford a general view of this spectacle; but a much greater amplification is needed to bring into view the peculiar mode in which the stroke of each Cilium is made. Few spectacles are more striking to the unprepared mind, than the exhibition of such wonderful activity as will then become apparent, in a body which to all ordinary observation is so inert. This activity serves a double purpose; for it not only drives a continual current of water over the surface of the Gills themselves, so as to affect the aeration of the blood, but it also directs a portion of this current (as in the *Tunicata*, § 453)

* Fuller details on this subject will be found in the Author's account of his researches, in "Transactions of the Microscopical Society," 2nd Ser., Vol. iii. (1855), p. 17. His account of the process has been called in question by MM. Koren and Danielssen, who had previously given an entirely different version of it, but has been fully confirmed by the observations of Dr. Dyster; see "Ann. of Nat. Hist.," 2nd Ser., Vol. xx. (1857), p. 16. The independent observations of M. Claparède on the development of *Neritina fluviatilis* ("Müller's Archiv.," 1857, p. 109, and abstract in "Ann. of Nat. Hist.," 2nd Ser., Vol. xx., 1857, p. 196) show the mode of development in that species to be the same in all essential particulars as that of *Purpura*.

† This Shell-fish may be obtained, not merely at the Sea-side, but likewise at the shops of the Fishmongers who supply the humbler classes, even in Midland towns.

to the Mouth, so as to supply the Digestive apparatus with the aliment afforded by the *Diatomacea*, *Infusoria*, &c., which it carries-in with it.

482. *Organs of Sense of Mollusks*.—Some of the minuter and more rudimentary forms of the special organs of Sight, Hearing, and Touch, which the Molluscous series presents, are very interesting objects of Microscopic examination. Thus just within the margin of each valve of *Pecten*, we see (when we observe the animal in its living state, under water) a row of minute circular points of great brilliancy, each surrounded by a dark ring; these are the Eyes, with which this creature is provided, for the purpose (it can scarcely be doubted) of directing its peculiarly-active movements. Each of them, when their structure is carefully examined, is found to be protected by a Sclerotic coat with a transparent Cornea in front, and to possess a coloured Iris (having a pupil) that is continuous with a layer of pigment lining the sclerotic, a Crystalline lens and Vitreous body, and a Retinal expansion proceeding from an Optic nerve which passes to each eye from the trunk that runs along the margin of the mantle. Eyes of still higher organization are borne upon the head of most Gasteropod Mollusks, generally at the base of one of the pairs of tentacles, but sometimes, as in the *Snail* and *Slug*, at the points of these organs. In the latter case, the tentacles are furnished with a very peculiar provision for the protection of the eyes; for when the extremity of either of them is touched, it is drawn-back into the basal part of the organ, much as the finger of a glove may be pushed-back into the palm. The retraction of the tentacle is accomplished by a long muscular slip, which arises within the head, and proceeds to the extremity of the tentacle; whilst its protrusion is effected by the agency of the circular bands with which the tubular wall of the tentacle is itself furnished, the inverted portion being (as it were) squeezed-out by the contraction of the lower part into which it has been drawn back. The structure of the Eyes, and the curious provision just described, may easily be examined by snipping-off one of the Eye-bearing tentacles with a pair of scissors.—None but the Cephalopod Mollusks have distinct organs of Hearing; but rudiments of such organs may be found in most Gasteropods (Fig. 323, κ, x), attached to some part of the nervous collar that surrounds the Œsophagus; and even in many Bivalves, in connection with the nervous ganglion imbedded in the base of the Foot. These 'Auditory Vesicles,' as they are termed, are minute sacculi, each of which contains a fluid, wherein are suspended a number of minute Calcareous particles (named *Otolithes* or ear-stones), which are kept in a state of continual movement by the action of Cilia lining the vesicles. This "wonderful spectacle," as it was truly designated by its discoverer Siebold, may be brought into view without any dissection, by submitting the head of any small and not very thick-skinned Gasteropod, or the young of the larger forms, to gentle compression

under the Microscope, and transmitting a strong light through it. The very early appearance of the Auditory Vesicles in the Embryo Gasteropod has been already alluded-to (§ 477).—Those who have the opportunity of examining young specimens of the common *Pecten*, will find it extremely interesting to watch the action of the very delicate tentacles which they have the power of putting-forth from the margin of their mantle, the animal being confined in a shallow Cell, or in the Zoophyte-trough; and if the observer should be fortunate enough to obtain a specimen so young that the valves are quite transparent, he will find the spectacle presented by the Ciliary movement of the Gills, as well as the active play of the Foot (of which the adult animal can make no such use), to be worthy of more than a cursory glance.

483. *Chromatophores of Cephalopods*.—Almost any species of Cuttle-fish (*Sepia*) or Squid (*Loligo*) will afford the opportunity of examining the very curious provision which their Skin contains for changing its hue. This consists in the presence of numerous large 'Pigment-Cells,' containing colouring matter of various tints; the prevailing colour, however, being that of the fluid of the Ink-bag. These Pigment-cells may present very different forms, being sometimes nearly globular, whilst at other times they are flattened and extended into radiating prolongations; and, by the peculiar contractility with which they are endowed, they can pass from one to the other of these conditions, so as to spread their coloured contents over a comparatively-large surface, or to limit them within a comparatively-small area. Very commonly there are different layers of these Pigment-cells, their contents having different hues in each layer; and thus a great variety of coloration may be given, by the alteration in the form of the cells of which one or another layer is made-up. It is curious that the changes in the hue of the Skin appear to be influenced, as in the case of the Chameleon, by the colour of the surface with which it may be in proximity. The alternate contractions and extensions of these Pigment-cells or *Chromatophores* may be easily observed in a piece of Skin detached from the living animal and viewed as a transparent object; since they will continue for some time, if the skin be placed in Sea-water. And they may also be well seen in the Embryo Cuttle-fish, which will sometimes be found in a state of sufficient advancement in the grape-like eggs of these animals attached to Sea-weeds, Zoophytes, &c.—The Eggs of the small Cuttle-fish termed the *Sepiola*, which is very common on our southern coasts, are imbedded, like those of the Doris, in gelatinous masses, which are attached to Sea-weeds, Zoophytes, &c.; and their Embryoes, when near maturity, are extremely beautiful and interesting objects, being sufficiently transparent to allow the action of the Heart to be distinguished, as well as to show most advantageously the changes incessantly occurring in the form and hue of the Chromatophores.

CHAPTER XV.

ANNULOSA, OR WORMS.

UNDER the general designation of 'Annulose' animals, or Worms, may be grouped-together all that lower portion of the great *Articulated* Sub-kingdom, in which the division of the body into longitudinally-arranged Segments is not distinctly marked-out, and in which there is an absence of those 'Articulated' or jointed limbs that constitute so distinct a feature of Insects and their allies. This group includes the classes of *Entozoa* or Intestinal Worms, *Rotifera* or Wheel-Animalcules, *Turbellaria*, and *Annelida*; each of which furnishes many objects for Microscopic examination, that are of the highest scientific interest. As our business, however, is less with the professed Physiologist, than with the general inquirer into the minute wonders and beauties of Nature, we shall pass over these Classes (the *Rotifera* having been already treated-of in detail, Chap. IX.), with only a notice of such points as are likely to be specially deserving the attention of observers of the latter order.

484. ENTOMOZOA.—This Class consists almost entirely of Animals of a very peculiar plan of organization, which are Parasitic within the bodies of other animals, and which obtain their nutriment by the absorption of the juices of these,—thus bearing a striking analogy to the Parasitic Fungi (§§ 264-267). The most remarkable feature in their structure consists in the entire absence or the extremely low development of their Nutritive system, and the extraordinary development of their Reproductive apparatus. Thus, in the common *Tenia* (Tape-worm), which may be taken as the type of the Cestoid group, there is neither Mouth nor Stomach, the so-called 'Head' being merely an organ for attachment, whilst the segments of the 'Body' contain repetitions of a complex Generative apparatus, the male and female sexual organs being so united in each as to enable it to fertilize and bring to maturity its own very numerous eggs; and the chief connection between these segments is established by two pairs of Longitudinal Canals, which, though regarded by some as representing a digestive apparatus, and by others as a circulating system, appear really to represent

the 'Water-Vascular system,' whose simplest condition has been noticed in the Wheel-Animalcule (§ 359).—Few among the recent results of Microscopic inquiry have been more curious, than the elucidation of the real nature of the bodies formerly denominated *Cystic Entozoa*, which have always ranked until recently as a distinct group. These are not found, like the preceding, in the cavity of the Alimentary Canal of the animals they infest; but always occur in the substance of solid organs, such as the Glands, Muscles, &c. They present themselves to the eye as bags or vesicles of various sizes, sometimes occurring singly, sometimes in groups; but upon careful examination each vesicle is found to bear upon some part a 'Head' furnished with hooklets and suckers; and this may be either single, as in *Cysticercus* (the Entozoon whose presence gives to Pork what is known as the 'Measly' disorder), or multiple, as in *Cœnurus*, which is developed in the brain, chiefly of Sheep, giving rise to the disorder known as 'the Staggers.' Now in none of these Cystic forms has any Generative apparatus ever been discovered, and hence they are obviously to be considered as imperfect animals. The close resemblance between the 'Head' of certain *Cysticerci* and that of certain *Tænie* first suggested that the two might be different states of the same animal; and experiments made by those who have devoted themselves to the working-out of this curious subject have led to the assured conclusion, that the Cystic Entozoa are nothing else than Cestoid Worms, whose development has been modified by the peculiarity of their position,—the large bag being formed by a sort of dropsical accumulation of fluid when the young are evolved in the midst of solid tissues, whilst the very same bodies, conveyed into the Alimentary canal of some Carnivorous animal which has fed upon the flesh infested with them, begin to bud-forth the Generative segments, the long succession of which, united end-to-end, gives to the entire series a Worm-like aspect.

485. The higher forms of Entozoa, belonging to the *Nematoid* or thread-like Order,—of which the common *Ascaris* may be taken as a type, one species of it (the *A. lumbricoides*, or 'Round Worm') being a common parasite in the Small Intestine of Man, while another (the *A. vermicularis*, or 'Thread Worm') is found rather in the lower bowel,—approach more closely to the ordinary type of conformation of Worms; having a distinct Alimentary Canal, which commences with a mouth at the anterior extremity of the body, and which terminates by an anal orifice near the other extremity; and also possessing a regular arrangement of circular and longitudinal Muscular fibres, by which the body can be shortened, elongated, or bent in any direction. The smaller species of *Ascaris*, by some or other of which almost every Vertebrated animal is infested, are so transparent, that every part of their internal organization may be made-out, especially with the assistance of the Compressor, without any dissection; and the

study of the structure and actions of their Generative apparatus has yielded many very interesting results, especially in regard to the first formation of the Ova, the mode of their fertilization, and the history of their subsequent development.—Some of the Worms belonging to this group are not parasitic in the bodies of other Animals, but live in the midst of dead or decomposing Vegetable matter. The *Gordius* or 'Hair-Worm,' which is peculiar in not having any perceptible anal orifice, seems to be properly a parasite in the intestines of Water-Insects; but it is frequently found in large knot-like masses (whence its name) in the water or mud of the pools inhabited by such insects, and may apparently be developed in these situations. The *Anguillule* are little Eel-like Worms, of which one species, *A. juliiatilis*, is very often found in Fresh-water amongst *Desmidiæ*, *Confervæ*, &c., also in wet Moss and moist Earth, and sometimes also in the Alimentary canal of Snails, Frogs, Fishes, Insects, and larger Worms; whilst another species, *A. tritici*, is met-with in the ears of Wheat affected with the blight termed the 'Cockle;' another, the *A. glutinis*, is found in sour Paste; and another, the *A. acetii*, was often found in stale Vinegar, until the more complete removal of mucilage and the addition of sulphuric acid, in the course of the manufacture, rendered this liquid a less favourable 'habitat' for these little creatures. A writhing mass of any of these species of 'Eels,' is one of the most curious spectacles which the Microscopist can exhibit to the unscientific observer; and the capability which they all possess (in common with the Rotifera and Tardigrada) of revival after desiccation, at however remote an interval, enables him to command this spectacle at any time. A grain of Wheat within which these Worms (often erroneously called *Vibriones*) are being developed, gradually assumes the appearance of a black Pepper-corn; and if it be divided in two, the interior will be found almost completely filled with a dense white cottony mass, occupying the place of the flour, and leaving merely a small place for a little glutinous matter. The cottony substance seems to the eye to consist of bundles of fine fibres closely packed-together; but on taking-out a small portion, and putting it under the Microscope with a little water under a thin glass-cover, it will be found after a short time (if not immediately) to be a wriggling mass of life, the apparent fibres being really *Anguillule*, or the 'Eels' of the Microscopist. If the seeds be soaked in water for a couple of hours before they are laid open, the eels will be found in a state of activity from the first; their movements, however, are by no means so energetic as those of the *A. glutinis* or 'Paste-Eel.' This last frequently makes its appearance spontaneously in the midst of Paste that is turning sour; but the best means of securing a supply for any occasion, consists in allowing any portion of a mass of paste in which they may present themselves to dry up, and then, laying this by so long as it may not be wanted, to introduce it into a mass of fresh paste, which, if

it be kept warm and moist, will be found after a few days to swarm with these curious little creatures.

486. Besides the foregoing Orders of Entozoa, the *Trematode* group must be named; of which the *Distoma hepaticum*, or 'Fluke,' found in the Livers of Sheep affected with the 'Rot,' is a typical example. Into the details of the structure of this animal, which has the general form of a Sole, there is no occasion for us here to enter: it is remarkable, however, for the branching form of its digestive cavity, which extends throughout almost the entire body, very much as in the Planariæ (Fig. 326); and also for the curious phenomena of its development, several distinct forms being passed through between one Sexual Generation and another. These have been especially studied in the *Distoma* which infests the *Lymnæus*; the Ova of which are not developed into the likeness of their parents, but into minute Worm-like bodies, which seem to be little else than masses of cells enclosed in a contractile integument, no formed organs being found in them; these cells, in their turn, are developed into independent Zooids, which escape from their containing cyst in the condition of free Ciliated Animalcules; in this condition they remain for some time, and then imbed themselves in the mucus that covers the tail of the Mollusk, in which they undergo a gradual development into true Distomata; and having thus acquired their perfect form, they penetrate the soft integument, and take-up their habitation in the interior of the body. Thus a considerable number of Distomata may be produced from a single Ovum, by a process of Cell-multiplication in an early stage of its development. In some instances the free ciliated Larva possesses distinct Eyes; although they are wanting in the fully-developed *Distoma*, the peculiar 'habitat' of which would render them useless.

487. TURBELLARIA.—This group of animals, which is distinguished by the presence of Cilia over the entire surface of the body, seems intermediate in some respects between the Trematode Entozoa and the Leech-tribe among Annelida. It deserves special notice here, chiefly on account of the frequency with which the Worms of the *Planarian* tribe present themselves among collections both of Marine and of Fresh-water animals (particular species inhabiting either locality), and on account of the curious organization which many of these possess. Most of the members of this tribe have elongated flattened bodies, and move by a sort of gliding or crawling action over the surfaces of Aquatic Plants and Animals. Some of the smaller kinds are sufficiently transparent to allow of their internal structure being seen by transmitted light, especially when they are slightly compressed; and the accompanying figure (Fig. 326) displays the general conformation of their principal organs, as thus shown. The body has the flattened Sole-like shape of the Trematode Entozoa; its Mouth, which is situated at a considerable distance from the anterior extremity

of the body, is surrounded by a circular Sucker that is applied to the living surface from which the animal draws its nutriment ; and the buccal cavity (b) opens into a short Oesophagus (c), which leads at once to the cavity of the Stomach.

FIG. 326.

In the true *Planaria* the mouth is furnished with a sort of long funnel shaped Proboscis ; and this, even when detached from the body, continues to swallow anything presented to it. The cavity of the Stomach does not give origin to any Intestinal tube, nor is it provided with any second orifice ; but a large number of ramifying Canals are prolonged from it, which carry its contents into every part of the body. This seems to render unnecessary any system of vessels for the Circulation of nutritive fluids ; and the two principal Trunks, with connecting and ramifying branches, which may be observed in them, are probably to be regarded in the light of a Water-Vascular system, the function of which is essentially Respiratory.

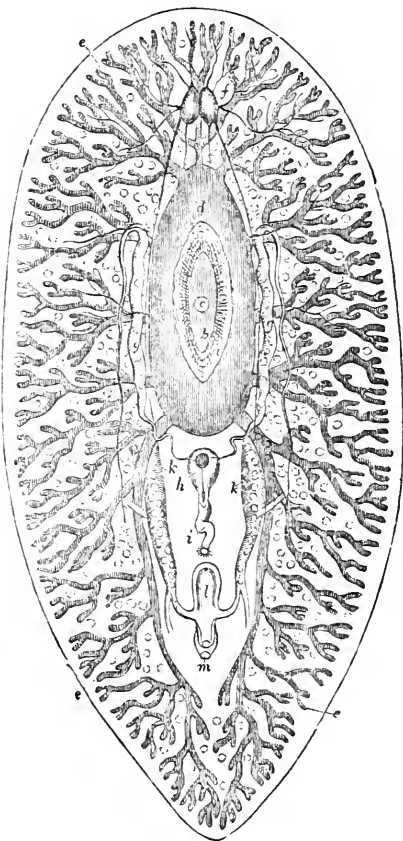

Structure of *Polycelis levigatus* (a Planarian worm):—a, Mouth, surrounded by its circular sucker; b, Buccal cavity; c, Oesophageal orifice; d, Stomach; e, ramifications of Gastric Canals; f, Cephalic Ganglia and their Nervous filaments; g, g, Testes; h, Vesicula seminalis; i, male genital canal; k, k, Oviducts; l, dilatation at their point of junction; m, Female genital orifice.

Both sets of Sexual organs are combined in the same individuals ; though the congress of two, each impregnating the

Ova of the other, seems to be generally necessary. The Ovaria, as in the Entozoa, extend through a large part of the body, their ramifications proceeding from the two Oviducts (*k, k*), which have a dilatation (*l*) at their point of junction.—There is much obscurity about the history of the Embryonic Development of these animals; and the facts observed by Siebold seem to be best explained upon the hypothesis, that what has been usually considered as an Egg is really an Egg-Capsule containing several Embryoes with a store of supplemental Yolk, as in *Purpura* (§ 479), which Yolk is swallowed by the Embryoes at a very early period of their development within the capsule.* After their emersion from the Capsule, the Embryoes bear so strong a resemblance to certain Infusoria, as to have led Prof. Agassiz to the conclusion that the genera *Paramecium* and *Kolpada* are nothing else than Planarian larvæ,—an idea decisively negated by recent discoveries (§ 347). The Planariæ, however, do not multiply by eggs alone; for they occasionally undergo spontaneous Fission in a transverse direction, each segment becoming a perfect animal; and an artificial division into two or even more parts may be practised with a like result. In fact, the power of the Planariæ to reproduce portions which have been removed, seems but little inferior to that of the Hydra (§ 411); a circumstance which is peculiarly remarkable, when the much higher character of their organization is borne in mind. They possess a distinct pair of Nervous Ganglia (*f, f*), from which branches proceed to various parts of the body; and in the neighbourhood of these are usually to be observed a number (varying from 2 to 40) of *Ocelli* or rudimentary Eyes, each having its refracting body or crystalline lens, its pigment layer, its nerve-bulb, and its cornea-like bulging of the skin. The integument of many of these animals is furnished with 'Thread-cells' or 'Filiferous capsules,' very much resembling those of Zoophytes (§ 428).

488. ANNELIDA.—This Class includes all the higher kinds of Worm-like animals, the greater part of which are Marine, though there are several species which inhabit Fresh water, and some which live on Land. The body in this class is usually very long, and nearly always presents a well-marked segmental division, the segments being for the most part similar and equal to each other, except at the two extremities; but in the lower forms, such as the Leech and its allies, the segmental division is very indistinctly seen, on account of the general softness of the integument. A large proportion of the Marine Annelids have special Respiratory appendages, into which the fluids of the body are sent for aeration; and these are situated upon the Head (Fig. 327), in those species which (like the *Serpula*, *Terebella*, *Sabellaria*, &c.) have their bodies enclosed by Tubes either formed of a Shelly substance produced from their own surface, or built-up by the agglutination

* See § 129 of Siebold and Stannius's "Vergleichende Anatomie;" also "Müller's Archiv," 1850, p. 485.

of grains of Sand, fragments of Shell, &c. ; whilst they are distributed along the two sides of the Body in such as swim freely through the water, or crawl over the surfaces of rocks, as is the case with the *Nereidæ*, or simply bury themselves in the sand, as the *Arenicola* or 'Lob-Worm.' In these Respiratory appendages the Circulation of the fluids may be distinctly seen by Microscopic examination; and these fluids are of two kinds,—first, a colourless fluid, containing numerous cell-like corpuscles, which can be seen in the smaller and more transparent species to occupy the space that intervenes between the outer surface of the Alimentary canal and the inner wall of the Body, and to pass from this into Canals which often ramify extensively in the Respiratory organs, but are never furnished with a returning series of passages,—and second, a fluid which is usually red, contains few floating particles, and is enclosed in a system of proper vessels that communicates with a central propelling organ, and not only carries the fluid away from this, but also brings it back again. In *Terebella* we find a distinct provision for the aeration of both fluids; for the first is transmitted to the tendril-like Tentacula which surround the mouth (Fig. 327, *b, b*), whilst the second circulates through the beautiful arborescent Branchiæ

FIG. 327.

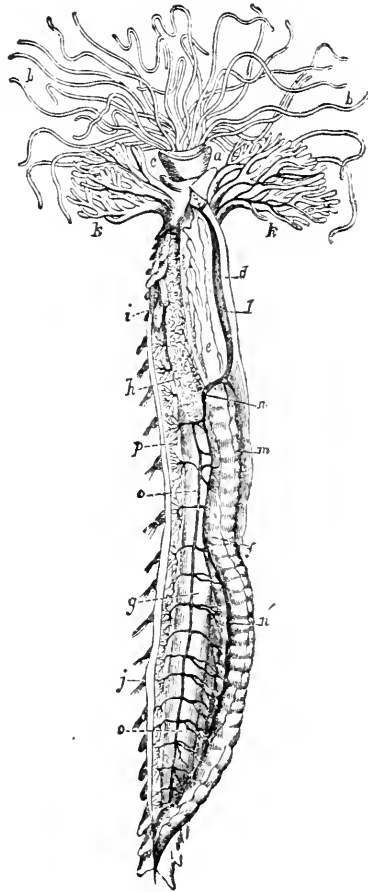

Circulating Apparatus of *Terebella conchilega*:—*a*, Labial ring; *b, b*, Tentacula; *c*, first segment of the trunk; *d*, skin of the back; *e*, Pharynx; *f*, Intestine; *g*, longitudinal muscles of the inferior surface of the body; *h*, Glandular organ (liver?); *i*, organs of Generation; *j*, Feet; *k, k*, Branchiæ; *l*, Dorsal Vessel acting as a Respiratory Heart; *m*, Dorso-Intestinal vessel; *n*, Venous Sinus surrounding cesophagus; *n'*, inferior Intestinal vessel; *o, o*, Ventral trunk; *p*, Lateral Vascular branches.

(*k*, *k*) situated just behind the head. The former are covered with Cilia, the action of which continually renews the stratum of water in contact with them, whilst the latter are destitute of these organs ; and this seems to be the general fact as to the several appendages to which these two fluids are respectively sent for aeration, the nature of their distribution varying greatly in the different members of the class. The red fluid is commonly considered as Blood, and the tubes through which it circulates as Blood-vessels ; but the Author has elsewhere given his reasons* for coinciding in the opinion of Mr. Huxley, that the Colourless Corpusculated fluid which moves in the Perivisceral cavity of the body and in its extensions, is that which really represents the Blood of other Articulated Animals ; and that the system of vessels carrying the red fluid is to be likened on the one hand to the 'Water-vascular system' of the inferior Worms, and on the other to the Tracheal apparatus of Insects (§ 524).—In the observation of the beautiful spectacle presented by the Respiratory Circulation of the various kinds of Annelids which swarm on most of our shores, and in the examination of what is going-on in the interior of their bodies (where this is rendered possible by their transparence), the Microscopist will find a most fertile source of interesting occupation ; and he may easily, with care and patience, make many valuable additions to our present stock of knowledge on these points. There are many of these marine Annelids, in which the appendages of various kinds put-forth from the sides of their bodies furnish very beautiful microscopic objects ; as do also the different forms of Teeth, Jaws, &c., with which the Mouth is commonly armed in the free or Non-Tubicolous species, these being eminently Carnivorous.

489. The early history of the Development of Annelids, too, is extremely curious ; for they come forth from the egg in a condition very little more advanced than the Ciliated Gemmules of Polypes, consisting of a globular mass of untransformed cells, certain parts of whose surface are covered with cilia ; in a few hours, however, this Embryonic mass elongates, and indications of a segmental division become apparent, the Head being (as it were) marked-off in front, whilst behind this is a large segment thickly covered with cilia, then a narrower and non-ciliated segment, and lastly the Caudal or tail-segment, which is furnished with cilia. A little later, a new segment is seen to be interposed in front of the caudal ; and the dark internal granular mass shapes itself into the outline of an Alimentary Canal.† The number of segments pro-

* See his "Principles of Comparative Physiology," 4th Edit., §§ 218, 219, 292.

† A most curious transformation once occurred within the Author's experience in the Larva of an Annelide, which was furnished with a broad collar or Disk fringed with very long Cilia, and showed merely an appearance of segmentation in its hinder part ; for in the course of a few minutes, during which it was not under observation, this larva assumed

gressively increases by the interposition of new ones between the caudal and its preceding segments; the various internal organs become more and more distinct, Eye-spots make their appearance, little bristly appendages are put-forth from the segments, and the animal gradually assumes the likeness of its parent; a few days being passed by the Tubicolar kinds, however, in the actively-moving condition, before they settle down to the formation of a Tube.*

490. To carry-out any systematic observations on the Embryonic Development of Annelids, the Eggs should be searched-for in the situations which these animals haunt; but in places where Annelids abound, free-swimming Larvæ are often to be obtained at the same time and in the same manner as small Medusæ (§ 421); and there is probably no part of our coasts off which some very curious forms may not be met with.—The following may be specially mentioned as departing widely from the ordinary type, and as in themselves extremely beautiful objects.—The *Actinotrocha* (Fig. 328) bears a strong resemblance in many particulars to the Bipinnarian Larva of a Star-fish (§ 441), having an elongated body, with a series of Ciliated Tentacula (*d*) symmetrically arranged; these Tentacula, however, proceed from a sort of Disk which somewhat resembles the 'Lophophore' of certain Polyzoa (§ 446). The Mouth (*e*) is concealed by a broad but pointed hood or 'epistome' (*a*), which sometimes closes-down upon the tentacular disk, but is sometimes raised and extended forwards. The nearly cylindrical body terminates abruptly at the other extremity, where the Anal orifice of the Intestine (*b*) is surrounded by a circling of very large Cilia. This animal swims with great activity, sometimes by the Tentacular Cilia, sometimes by the Anal circling, sometimes by both combined; and besides its movement of progression, it frequently doubles itself together, so as to bring the Anal extremity and the Epistome almost into contact. It is so transparent that the whole of its alimentary canal may be as distinctly seen as that of *Bowerbankia* (§ 449); and, as in that Polyzoan, the alimentary masses often to be seen in the Stomach (*c*) are kept in a continual whirling movement by the agency of Cilia with which its walls are clothed. This very interesting creature was for a long time a

the ordinary form of a Marine Worm three or four times its previous length, and the Ciliated Disk entirely disappeared. An accident unfortunately prevented the more minute examination of this Worm, which the Author would have otherwise made; but he may state that he is certain that there was no fallacy as to the fact above stated; this Larva having been placed by itself in a cell, on purpose that it might be carefully studied, and having been only laid aside for a short time whilst other selections were being made from the same gathering of the Townet.

* See especially the admirable Memoir of Prof. Milne-Edwards 'Sur le Développement des Annelides,' in the "Ann. des Sci. Nat.," Sér. 3, Zool., Tom. iii.; and the recent Systematic Treatise of M. de Quatrefages, entitled, "Histoire Naturelle des Annelides," in the "Suites à Buffon."

puzzle to Zoologists; since, although there could be no doubt of its being a Larval form, there was no clue to the nature of the adult produced from it, until this

FIG. 328.

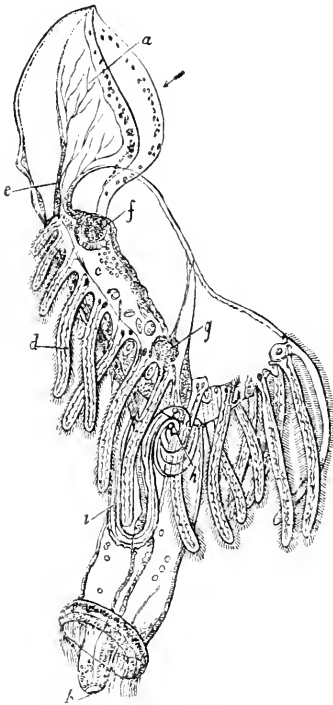

Actinotrocha branchiata:—*a*, Episotome or hood; *b*, Anus; *c*, Stomach; *d*, Ciliated Tentacula; *e*, Mouth.

was discovered by Krohn to be a Sipunculide Worm.* The process of transformation has been subsequently more fully described by Dr. A. Schneider, and seems to consist in a sort of turning-inside-out of the Actinotrocha. A long convoluted tube which was previously to be seen within the cavity of its body, closed at one end and opening at the other upon the ventral surface, is the body-wall of the future Worm; this everts itself, and issues from the body of the Larva, at the same time completely taking-in its Intestine, which is doubled together (as in a hernial protrusion), so that the Mouth and Anus are brought into close apposition with each other at the anterior end of the body. The entire body-wall of the Larva, with the hood and the anal cirrulus of cilia, disappears; the tentacles remain for a time at the anterior extremity of the tube, contracted into a close cirrulus; this cirrulus is subsequently cast-off,

however, by a kind of moult, at which period the whole surface of the body has become clothed with cilia. The development of the Circulating apparatus commences before the transformation, and this apparatus comes soon afterwards into active operation. †

491. An even more extraordinary departure from the ordinary

* 'Ueber *Pilidium* und *Actinotrocha*,' in "Müller's Archiv," 1858, p. 293; see also Wagener, 'Ueber den Bau der *Actinotrocha branchiata*,' op. cit., 1857, p. 202.

† 'On the Development of *Actinotrocha branchiata*' in the "Monatsberichte" of the Berlin Academy for Oct. 1861, p. 934, and in "Ann. of Nat. Hist.," Sér. 3, Vol. ix. (1862), p. 486.—The Author has met with *Actinotrocha*, sometimes in large numbers together, in Lamlash Bay, Arran; and Dr. Cobbold has taken it in the Frith of Forth.

type is presented by the Larva which has received the name *Pilidium* (Fig. 329) ; its shape being that of a helmet, the plume of which is replaced by a single long bristle-like appendage that

FIG. 329.

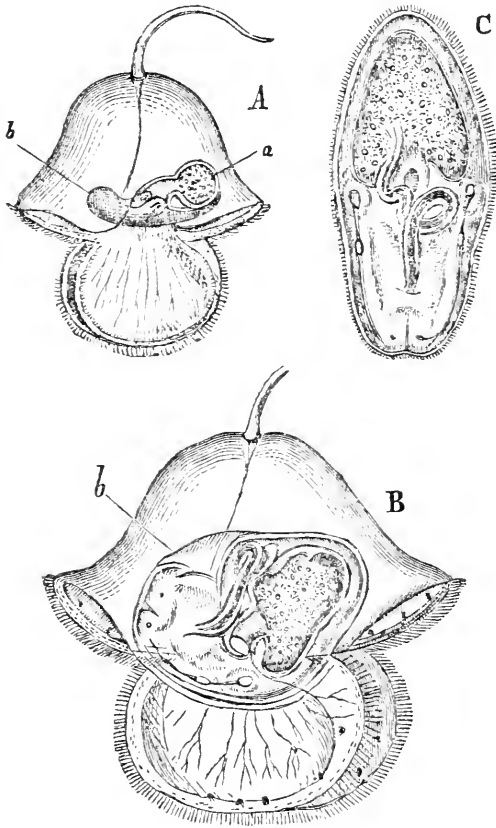

Pylidium gyrans :—A, young, showing at *a* the Alimentary canal, and at *b* the rudiment of the Nemertid :—B, more advanced stage of the same ;—c, newly-freed Nemertid.

is in continual motion, its point moving round and round in a circle. This curious organism, first noticed by Müller, has been since ascertained to be the Larva of the well-known *Nemertes*, a Turbellarian worm of enormous length, which is commonly found entwining itself among the roots of Algae.*

* See especially Leuckart and Parenstecher's 'Untersuchungen über niedere Seethiere,' in "Müller's Archiv.," 1853, p. 569. The Author has frequently met with *Pilidium* in Lamlash Bay.

492. Among other animals captured by the Tow-Net, the Marine Zoologist will be not unlikely to meet with an Annelid which, although by no means Microscopic in its dimensions, is an admirable subject for Microscopic observation from the extreme transparency of its entire body, which is such as to render it difficult to be distinguished when swimming in a glass jar, except by a very favourable light. This is the *Tomopteris*, so named from the division of the lateral portions of its body into a succession of Wing-like Segments (Plate XXIII., B), each of them carrying at its extremity a pair of Pinnules, by the movements of which the animal is rapidly propelled through the water. The full-grown animal, which measures nearly an inch in length, has first a curious pair of 'Frontal Horns' projecting laterally from the Head, so as to give the animal the appearance of a Hammer-headed Shark; behind these there is a pair of very long Antennæ, in each of which we distinguish a rigid bristle-like stem or *Seta*, enclosed in a soft sheath, and moved at its base by a set of Muscles contained within the lateral protuberances of the head. Behind these are about sixteen pairs of the ordinary Pinnulated Segments, of which the hinder ones are much smaller than those in front, gradually lessening in size until they become almost rudimentary; and where these cease, the body is continued onwards into a Tail-like prolongation, the length of which varies greatly according as it is contracted or extended. This prolongation, however, bears four or five pairs of very minute Appendages, and the Intestine is continued to its very extremity; so that it is really to be regarded as a continuation of the body. In the Head we find, between the origins of the antennæ, a Ganglionic mass, the component cells of which may be clearly distinguished under a sufficient magnifying power, as shown at F; seated upon this are two Pigment-spots (*b, b*), each bearing a double pellucid Lens-like body, which obviously have the character of rudimentary Eyes: whilst imbedded in its anterior portion are two peculiar Nucleated Vesicles, *a, a*, which are probably the rudiments of some other Sensory organs. On the under side of the head is situated the Mouth, which, like that of many other Annelids, is furnished with a sort of Proboscis that can be either projected or drawn-in; a short Œsophagus leads to an elongated Stomach, which, when distended with fluid, occupies the whole cavity of the central portion of the body, as shown in fig. B, but which is sometimes so empty and contracted as to be like a mere cord, as shown in fig. C. In the Caudal appendage, however, it is always narrowed into an Intestinal canal; this, when the appendage is in extended state, as at c, is nearly straight; but when the appendage is contracted, as seen at B, it is thrown into convolutions. The Perivisceral Cavity is occupied by fluid in which some minute corpuscles may be distinguished; and these are kept in motion by Cilia which clothe some parts of the outer surface of the Alimentary canal and line some parts of the

PLATE XXIII.

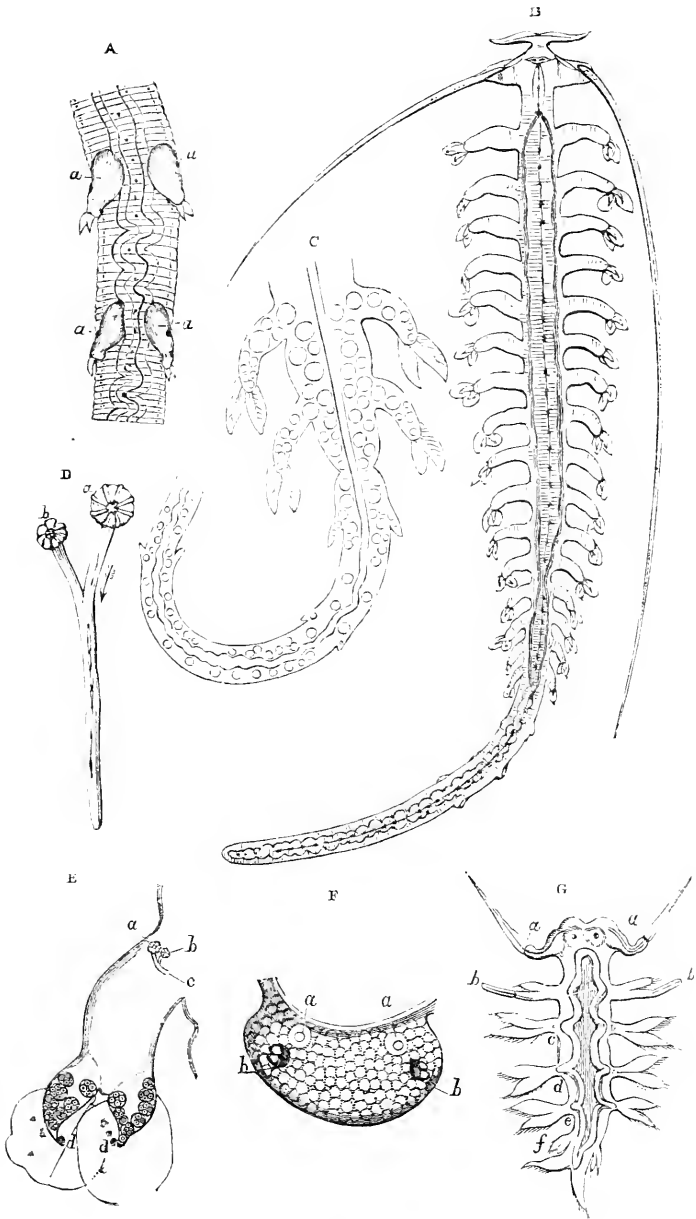

TOMOPTERIS ONISCIFORMIS.

[To face p. 632.]



wall of the body. No other more special apparatus either for the Circulation or for the Aeration of the nutrient fluid, exists in this curious Worm; unless we are to regard as subservient to the Respiratory function the Ciliated Canal which may be observed in each of the lateral appendages except the five anterior pairs. This Canal commences by two orifices at the base of the segment, as shown at fig. E, *b*, and on a larger scale at fig. D; each of these orifices (*d*, *a*, *b*) is surrounded by a sort of Rosette; and the rosette of the larger one (*a*) is furnished with radiating ciliated ridges. The two branches incline towards each other, and unite into a single Canal, that runs along for some distance in the wall of the body, and then terminates in the perivisceral cavity; and the direction of the motion of the cilia which line it is from without inwards.

493. The Reproduction and Developmental history of this Annelid present many points of great interest. The Sexes appear to be distinct, Ova being found in some individuals, and Spermatozoa in others. The development of the Ova commences in certain 'Germ-cells' situated within the extremities of the Pinnulated Segments, where they project inwards from the wall of the body; these, when set free, float in the fluid of the Perivisceral cavity, and multiply themselves by self-division; and it is only after their number has thus been considerably augmented, that they begin to increase in size and to assume the characteristic appearance of Ova. In this stage they usually fill the perivisceral cavity not only of the body but of its caudal extension, as shown at *c*; and they escape from it through transverse fissures which form in the outer wall of the body, at the third and fourth segments. The Male reproductive organs, on the other hand, are limited to the Caudal prolongation, where the Sperm-cells are developed within the pinnulated Appendages, as the germ-cells of the female are within the appendages of the body. Instead of being set free, however, into the perivisceral cavity, they are retained within a saccular envelope forming a Testis (*A*, *a*, *a*) which fills up the whole cavity of each appendage; and within this the Spermatozoa may be observed, when mature, in active movement. They make their escape externally by a passage that seems to communicate with the smaller of the two just-mentioned rosettes; but they also appear to escape into the perivisceral cavity by an aperture that forms itself when the spermatozoa are mature. Whether the Ova are fertilized while yet within the body of the female, by the entrance of Spermatozoa through the ciliated canals, or after they have made their escape from it, has not yet been ascertained.—Of the earliest stages of Embryonic Development nothing whatever is yet known; but it has been ascertained that the animal passes through a Larval form, which differs from the adult not merely in the number of the Segments of the body (which successively augment by additions at the posterior extremity), but also in that of the

Antennæ. At *g* is represented the earliest Larva hitherto met with, enlarged as much as ten times in proportion to the adult at *B* ; and here we see that the head is destitute of the frontal horns, but carries a pair of setigerous Antennæ, *a, a*, behind which there are five pairs of bifid appendages, *b, c, d, e, f*, in the first of which, *b*, one of the pinnules is furnished with a *seta*. In more advanced Larvæ having eight or ten segments, this is developed into a second pair of Antennæ resembling the first ; and the animal in this stage has been described as a distinct species, *T. quadricornis*. At a more advanced age, however, the second pair attains the enormous development shown at *B* ; and the first or larval antennæ disappear, the setigerous portions separating at a sort of joint (*g, a, a*), whilst the basal projections are absorbed into the general wall of the body.—This beautiful creature has been met-with on so many parts of our coast, that it cannot be considered at all uncommon ; and the Microscopist can scarcely have a more pleasing object for study.* Its elegant form, its crystal clearness, and its sprightly, graceful movements render it attractive even to the unscientific observer ; whilst it is of special interest to the Physiologist as one of the simplest examples yet known of the Annelid type.

494. To one phenomenon of the greatest interest, presented by various small marine Annelids, the attention of the Microscopist should be specially directed ; this is their *Luminosity*, which is not a steady glow like that of the Glow-worm or Fire-fly, but a series of vivid scintillations (strongly resembling those produced by an Electric discharge through a tube spotted with tin-foil), that pass along a considerable number of segments, lasting for an instant only, but capable of being repeatedly excited by any irritation applied to the body of the animal. These scintillations may be discerned under the Microscope, even in separated segments, when they are subjected to the irritation of a needle-point or to a gentle pressure ; and it has been ascertained by the careful observations of M. de Quatrefages, that they are given out by the Muscular Fibres in the act of contraction.†

495. Among the fresh-water *Annelida*, those most interesting to the Microscopist are the Worms of the *Nais* tribe, which are common in our rivers and ponds, living chiefly amidst the mud at the bottom, and especially among the roots of Aquatic Plants. Being blood-red in colour, they give to the surface of the mud, when they protrude themselves from it in large numbers and keep the protruded portion of their bodies in constant undulation, a very peculiar appearance ; but if disturbed, they withdraw themselves suddenly and completely. These Worms, from the extreme trans-

* See the Memoirs of the Author and M. Claparède in Vol. xxii. of the "Linnaean Transactions," and the authorities there referred to.

† See his Memoirs on the Annelida of La Manche, in "Ann. des Sci. Nat.," Sér. 2, Zool., tom. xix., and Sér. 3, Zool., tom. xiv.

parence of their bodies, present peculiar facilities for Microscopic examination, and especially for the study of the internal Circulation of the red liquid commonly considered as Blood. There are here no external Respiratory organs; and the thinness of the general integument appears to supply all needful facility for the Aeration of the fluids. One large Vascular trunk (dorsal) may be seen lying above the Intestinal canal, and another (ventral) beneath it; and each of these enters a contractile dilatation, or Heart-like organ, situated just behind the head. The fluid moves forwards in the dorsal trunk as far as the heart, which it enters and dilates; and when this contracts, it propels the fluid partly to the head, and partly to the ventral heart, which is distended by it. The ventral heart, contracting in its turn, sends the blood backwards along the ventral trunk to the tail, whence it passes towards the head as before. In this circulation, it branches-off from each of the principal trunks into numerous vessels proceeding to different parts of the body, which then return into the other trunk; and there is a peculiar set of vascular coils, hanging down in the Perivisceral cavity that contains the Corpusculated liquid representing the true Blood, which seem specially destined to convey to it the aerating influence received by the red fluid in its circuit, thus acting (so to speak) like Internal Gills.—The *Naiad*-worms have been observed to undergo spontaneous division during the summer months; a new Head and its organs being formed for the posterior segment behind the line of constriction, before its separation from the anterior. It has been generally believed that each Segment continues to live as an entire Worm; but it is asserted by Dr. T. Williams that from the time when the division occurs, neither half takes in any more food, and that the two segments only retain vitality enough to enable them to be (as it were) the ‘Nurses’ of the Eggs which both include.—In the *Leech* tribe, the Dental apparatus with which the Mouth is furnished is one of the most curious among their points of minute structure; and the common ‘medicinal’ leech affords one of the most interesting examples of it. What is commonly termed the ‘bite’ of the Leech, is really a saw-cut, or rather a combination of three saw-cuts, radiating from a common centre. If the Mouth of the Leech be examined with a hand-magnifier, or even with the naked eye, it will be seen to be a triangular aperture in the midst of a sucking disk; and on turning back the lips of that aperture, three little white ridges are brought into view. Each of these is the convex edge of a horny semicircle, which is bordered by a row of eighty or ninety minute hard and sharp Teeth; whilst the straight border of the semicircle is imbedded in the Muscular substance of the disk, by the action of which it is made to move backwards and forwards in a saw-like manner, so that the teeth are enabled to cut into the skin to which the suctorial disk has affixed itself.

CHAPTER XVI.

CRUSTACEA.

PASSING from the lower division of the Articulated series to the higher—that in which the body is furnished with distinctly-articulated or jointed limbs,—we come first to the Class of *Crustacea*, which includes (when used in its most comprehensive sense) all those animals belonging to this group, which are fitted for Aquatic Respiration. It thus comprehends a very extensive range of forms ; for although we are accustomed to think of the Crab, Lobster, Cray-fish, and other well-known species of the order *Decapoda* (ten-footed), as its typical examples, yet all these belong to the highest of its many Orders ; and among the lower are many of a far simpler structure, and not a few which would not be recognized as belonging to the Class at all, were it not for the information derived from the study of their Development as to their real nature, which is far more apparent in their early than it is in their adult condition. Many of the inferior kinds of Crustacea are so minute and transparent, that their whole structure may be made-out by the aid of the Microscope without any preparation ; this is the case, indeed, with nearly the whole group of *Entomostraca* (§ 497), and with the Larval forms even of the *Crab* and its allies (§ 508) ; and we shall give our first attention to these, afterwards noticing such points in the structure of the larger kinds as are likely to be of general interest.

496. A curious example of the reduction of an elevated type to a very simple form is presented by the group of *Pycnogonidæ* ; some members of which may be found by attentive search in almost every locality where Sea-weeds abound, it being their habit to crawl (or rather to sprawl) over the surfaces of these, and probably to imbibe as food the gelatinous substance with which they are invested. The general form of their bodies (Fig. 330) usually reminds us of that of some of the long-legged Crabs ; the Abdomen being almost or altogether deficient, whilst the Head is very small, and fused (as it were) into the Thorax ; so that the last-named region, with the members attached to it, constitutes nearly the whole bulk of the animal. The Head is extended in front into a

Proboscis-like projection, at the extremity of which is the narrow orifice of the Mouth ; which seems to be furnished with vibratile Cilia, that serve to draw into it the semi-fluid aliment. Instead of being furnished (as in the higher Crustaceans) with two pairs of

FIG. 330.

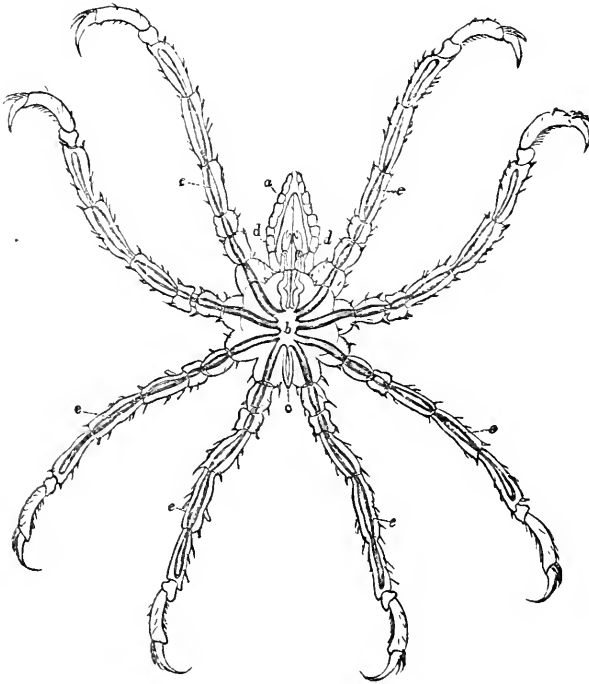

Ammothea pycnogonoides :—*a*, narrow Œsophagus ; *b*, Stomach ; *c*, Intestine ; *d*, Digestive Cæca of the Feet-jaws ; *e e*, Digestive Cæca of the Legs.

Antennæ and numerous pairs of 'Feet-jaws,' it has but a single pair of either ; it also bears four minute *Ocelli*, or rudimentary Eyes, set at a little distance from each other on a sort of tubercle. From the Thorax proceed four pairs of Legs, each composed of several joints, and terminated by a hooked claw ; and by these members the animal drags itself slowly along, instead of walking actively upon them like a crab. The Mouth leads to a very narrow Œsophagus (*a*), which passes back to the central Stomach (*b*) situated in the midst of the Thorax, from the hinder end of which a narrow Intestine (*c*) passes-off, to terminate at the posterior

extremity of the body. From the central stomach five pairs of Cæcal prolongations radiate; one pair (*d*) entering the Feet-jaws, the other four (*e*, *e*) penetrating the Legs, and passing along them as far as the last joint but one; and those extensions are covered with a layer of brownish-yellow granules, which are probably to be regarded as a diffused and rudimentary condition of the Liver. The Stomach and its Cæcal prolongations are continually executing peristaltic movements of a very curious kind; for they contract and dilate with an irregular alternation, so that a flux and reflux of their contents is constantly taking-place between the central portion and its radiating extensions, and between one of these extensions and another. The Perivisceral space between the widely-extended Stomach and the walls of the body and Limbs is occupied by a transparent liquid, in which are seen floating a number of minute transparent corpuscles of irregular size; and this fluid, which represents the Blood, is kept in continual motion, not only by the general movements of the animal, but also by the actions of the Digestive apparatus; since, whenever the Cæcum of any one of the legs undergoes dilatation, a part of the circumambient liquid will be pressed-out from the cavity of that Limb, either into the Thorax, or into some other Limb whose stomach is contracting. The fluid must obtain its Aeration through the general surface of the body, as there are no special organs of Respiration. The Nervous System consists of a single Ganglion in the Head (formed by the coalescence of a pair), and of another in the Thorax (formed by the coalescence of four pairs), with which the Cephalic ganglion is connected in the usual mode, namely, by two nervous cords which diverge from each other to embrace the œsophagus. Of the Reproduction of these animals, very little is yet known.*—In the study of the very curious phenomena exhibited by the Digestive apparatus, as well as of the various points of internal conformation which have been described, the Achromatic Condenser will be found useful, even with the 1 inch, 2-3rds inch, or $\frac{1}{2}$ inch Objectives; for the imperfect transparence of the bodies of these animals renders it of importance to drive a large quantity of light through them, and to give to this light such a quality as shall define the internal organs as sharply as possible.

497. ENTOMOSTRACA.—This group of Crustaceans, nearly all the existing members of which are of such minute size as to be only just visible to the naked eye, is distinguished by the enclosure of the entire body within a Horny or Shelly casing; which sometimes closely resembles a Bivalve shell in form and in the mode of junction of its parts, whilst in other instances it is formed of only a single piece, like the hard envelope of certain Rotifera (§ 363, III.).

* A curious account is given by Mr. Hodge in "Ann. of Nat. Hist.," Ser. 3, Vol. ix., p. 33, of the development of a species of *Pycnogon*, which in its larval state is parasitic on the Polypary of *Coryne*.

The Segments into which the body is divided, are frequently very numerous, and are for the most part similar to each other; but there is a marked difference in regard to the Appendages which they bear, and to the mode in which these minister to the locomotion of the animals. For in the *Lophyropoda*, or Bristly-footed tribe, the number of Legs is small, not exceeding five pairs, and their function is limited to Locomotion, the Respiratory organs being attached to the parts in the neighbourhood of the mouth; whilst in the *Branchiopoda*, or Gill-footed tribe, the same members serve both for Locomotion and for Respiration, and the number of these is commonly large, being in *Apus* not less than sixty pairs. The character of their movements differs accordingly; for whilst all the members of the first-named tribe dart through the water in a succession of jerks, so as to have acquired the common name of 'Water-Fleas,' those among the latter which possess a great number of 'Fin-feet,' swim with an easy gliding movement, sometimes on their back alone (as in the case with *Branchipus*), and sometimes with equal facility on the back, belly, or sides (as is done by *Artemia salina*, the 'Brine Shrimp').—Some of the most common forms of both tribes will now be briefly noticed.

498. The Tribe of *Lophyropoda* is divided into two *Orders*; of which the first, *Ostracoda*, is distinguished by the complete enclosure of the body in a Bivalve shell, by the small number of Legs, and by the absence of an external Ovary. One of the best known examples is the little *Cypris*, which is a common inhabitant of pools and streams; this may be recognized by its possession of two pairs of Antennæ, the first having numerous joints with a pencil-like tuft of filaments, and projecting forwards from the front of the head, whilst the second has more the shape of legs, and is directed downwards; and by the limitation of its Legs to two pairs, of which the posterior does not make its appearance outside the shell, being bent upwards to give support to the ovaries. The valves are generally opened sufficiently widely to allow the greater part of both pairs of Antennæ and of the front pair of Legs to pass-out between them; but when the animals are alarmed, they draw these members within the shell, and close the valves firmly. They are very lively creatures, being almost constantly seen in motion, either swimming by the united action of their foot-like Antennæ and Legs, or walking upon plants and other solid bodies floating in the water.—Nearly allied to the preceding is the *Cythere*, whose body is furnished with three pairs of Legs, all projecting out of the shell, and whose Superior Antennæ are destitute of the filamentous brush; this Genus is almost entirely Marine, and some species of it may almost invariably be met-with in little pools among the rocks between the tide-marks, creeping-about (but not swimming) amongst Confervæ and Corallines.—There is abundant evidence of the former existence of Crustacea of this group, of larger size than any now existing, to an enormous extent; for in certain Fresh-water strata, both of the Secondary and Tertiary

series, we find layers, sometimes of great extent and thickness, which are almost entirely composed of the Fossilized shells of *Cyprides*; whilst in certain parts of the Chalk, which was a Marine deposit, the remains of Bivalve shells resembling those of *Cythere* present themselves in such abundance as to form a considerable part of its composition.

499. In the Order *Copepoda*, there is a jointed Shell forming a kind of Buckler or Carapace that almost entirely encloses the head and thorax, an opening being left beneath, through which the members project; and there are five pairs of Legs, mostly adapted for swimming, the fifth pair, however, being rudimentary in the genus *Cyclops*, the commonest example of the group. This genus receives its name from possessing only a single Eye, or rather a single cluster of Ocelli; which character, however, it has in common with the two genera already named, as well as with *Daphnia*

FIG. 331.

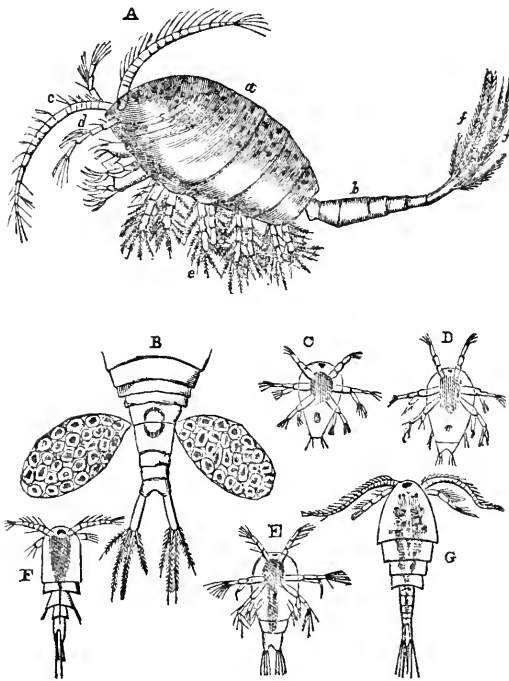

A, female of *Cyclops quadricornis* :—a, Body; b, Tail; c, Antenna; d, Antennule; e, Feet; f, Plumose setae of tail :—B, Tail, with external egg-sacs :—C, D, E, F, G, successive stage Development of young.

(§ 500), and with many other Entomostraca. It contains numerous species, some of which belong to Fresh water, whilst others are Marine. The Fresh-water species often abound in the muddiest and most stagnant pools, as well as in the clearest springs; the ordinary water with which London is supplied frequently contains large numbers of them. Of the Marine species, some are to be found in the localities in which the *Cythere* is most abundant, whilst others inhabit the open Ocean, and must be

collected by the Tow-net. The body of the Cyclops is soft and gelatinous, and it is composed of two distinct parts, a Thorax (Fig. 331, *a*) and an Abdomen (*b*), of which the latter, being comparatively slender, is commonly considered as a tail, though traversed by the Intestine which terminates near its extremity. The Head, which coalesces with the Thorax, bears one very large pair of Antennæ (*c*) possessing numerous articulations, and furnished with bristly appendages, and another small pair (*d*); it is also furnished with a pair of Mandibles or true jaws, and with two pairs of 'Feet-jaws,' of which the hinder pair is the longer and most abundantly supplied with bristles. The Legs (*e*) are all beset with plumose tufts, as is also the Tail (*f, f*) which is borne at the extremity of the abdomen. On either side of the Abdomen of the female, there is often to be seen an Egg-capsule or external Ovarium (*B*); within which the Ova, after being fertilized, undergo the earlier stages of their development.—The Cyclops is a very active creature, and strikes the water in swimming, not merely with its Legs and Tail, but also with its Antennæ. The rapidly-repeated movements of its Feet-jaws serve to create a whirlpool in the surrounding water, by which minute animals of various kinds, and even its own young, are brought to its mouth to be devoured.

500. The tribe of *Branchiopoda* also is divided into two Orders of which the *Cladocera* present the nearest approach to the preceding, having a Bivalve Carapace, no more than from four to six pairs of Legs, two pairs of Antennæ, of which one is large and branched and adapted for swimming, and a single Eye. The commonest form of this is the *Daphnia pulex*, sometimes called the 'Arborescent Water-Flea' from the branching form of its Antennæ. It is very abundant in many ponds and ditches, coming to the surface in the mornings and evenings and in cloudy weather, but seeking the depths of the water during the heat of the day. It swims by taking short springs; and feeds on minute particles of Vegetable substances, not, however, rejecting Animal matter when offered. Some of the peculiar phenomena of its Reproduction will be presently described (§ 503).

501. The other Order, *Phyllopoda*, includes those Branchiopoda whose body is divided into a great number of segments, nearly all of which are furnished with leaf-like members, or 'fin-feet.' The two Families which this order includes, however, differ considerably in their conformation; for in that of which the genera *Apus* and *Nebalia* are representatives, the body is enclosed in a Shell, either shield-like or bivalve, and the feet are generally very numerous; whilst in that which contains *Branchipus* and *Artemia*, the body is entirely unprotected, and the number of pairs of feet does not exceed eleven. The *Apus cancriformis*, which is an animal of comparatively large size, its entire length being about $2\frac{1}{2}$ inches, is an inhabitant of stagnant waters; but although occasionally very abundant in particular pools or ditches, it is not to be met-with

nearly so commonly as the Entomostraca already noticed. It is recognized by its large oval Carapace, which covers the head and body like a shield; by the nearly cylindrical form of its Body, which is composed of thirty Articulations; and by the multiplication of its Legs, which amount to about sixty pairs. The number of joints in these and in the other appendages is so great, that in a single individual they may be safely estimated at not less than two millions. These organs, however, are for the most part small; and the instruments chiefly used by the animal for locomotion are the first pair of Feet, which are very much elongated (bearing such a resemblance to the principal Antennæ of other Entomostraca, as to be commonly ranked in the same light), and are distinguished as *Rami* or Oars. With these they can swim freely in any position; but when the Rami are at rest and the animal floats idly on the water, its Fin-feet may be seen in incessant motion, causing a sort of whirlpool in the water, and bringing to the mouth the minute animals (chiefly the smaller Entomostraca inhabiting the same localities) that serve them as food.—The *Branchipus stagnalis* has a slender, cylindrical, and very transparent Body of nearly an inch in length, furnished with eleven pairs of Fin-feet, but is destitute of any protecting envelope; its head is furnished with a pair of very curious prehensile organs (which are really modified Antennæ), whence it has received the name of *Cheirocephalus*; but these are not used by it for the seizure of prey, the food of this animal being vegetable, and their function is to clasp the female in the act of copulation. The Branchipus or Cheirocephalus is certainly the most beautiful and elegant of all the Entomostraca, being rendered extremely attractive to the view by “the uninterrupted undulatory wavy motion of its graceful branchial feet, slightly tinged as they are with a light reddish hue, the brilliant mixture of transparent bluish-green and bright red of its prehensile antennæ, and its bright red tail with the beautiful plumose setæ springing from it:” unfortunately, however, it is a comparatively rare animal in this country.—The *Artemia salina* or ‘Brine Shrimp’ is an animal of very similar organization, and almost equally beautiful in its appearance and movements, but of smaller size, its body being about half an inch in length. Its ‘habitat’ is very peculiar; for it is only found in the Salt-pans or Brine-pits in which Sea-water is undergoing concentration (as at Lymington); and in these situations it is sometimes so abundant as to communicate a red tinge to the liquid.

502. Some of the most interesting points in the history of the *Entomostraca* lie in the peculiar mode in which their Generative function is performed, and in their tenacity of Life when desiccated, in which last respect they correspond with many Rotifera (§ 362). By this provision they escape being completely exterminated, as they might otherwise soon be, by the drying-up of the pools, ditches, and other small collections of water which constitute

their usual 'habitats.' It does not appear, however, that the adult Animals can bear a *complete* desiccation, although they will preserve their vitality in mud that holds the smallest quantity of moisture; but their Eggs are more tenacious of life, and there is ample evidence that these will become fertile on being moistened, after having continued for a long time in the condition of fine dust. Most Entomostraca, too, are killed by severe Cold, and thus the whole race of adults perishes every winter; but their Eggs seem unaffected by the lowest temperature, and thus continue the species, which would be otherwise exterminated.—Again, we frequently meet in this group with that *Ayamic* Reproduction, which we have seen to prevail so extensively among the lower Radiata and Mollusca. In many species there is a double mode of multiplication, the Sexual and the Non-sexual. The former takes-place at certain seasons only; the Males (which are often so different in conformation from the females, that they would not be supposed to belong to the same species, if they were not seen in actual congress) disappearing entirely at other times. The latter, on the other hand, continues at all periods of the year, so long as warmth and food are supplied; and is repeated many times (as in the Hydra), so as to give origin to as many successive 'broods.' Further, a single act of impregnation serves to fertilize not merely the Ova which are then mature or nearly so, but all those subsequently produced by the same female, which are deposited at considerable intervals. In these two modes, the multiplication of these little creatures is carried on with great rapidity, the young animal speedily coming to maturity and beginning to propagate; so that according to the computation of Jurine, founded upon data ascertained by actual observation, a single fertilized Female of the common *Cyclops quadricornis* may be the progenitor in one year of 4,442,189,120 young.

503. The Eggs of some Entomostraca are deposited freely in the water, or are carefully attached in clusters to Aquatic Plants: but they are more frequently carried for some time by the parent in special receptacles developed from the posterior part of the body; and in many cases they are retained there until the young are ready to come-forth, so that these animals may be said to be Ovo-Viviparous. In the *Daphnia*, the eggs are received into a large cavity between the back of the animal and its shell, and there the young undergo almost their whole development, so as to come-forth in a form nearly resembling that of their parent. Soon after their birth, a Moulting or exuviation of the Shell takes-place; and the egg-coverings are cast-off with it. In a very short time afterwards, another brood of eggs is seen in the cavity, and the same process is repeated, the shell being again exuviated after the young have been brought to maturity. At certain times, however, the *Daphnia* may be seen with a dark opaque substance within the back of the shell, which has been called the *Ephippium* from its resemblance to a saddle. This, when carefully examined, is found to be of dense texture, and

to be composed of a mass of hexagonal cells; and it contains two oval bodies, each consisting of an Ovum covered with a horny casing, enveloped in a Capsule which opens like a Bivalve shell. From the observations of Sir J. Lubbock,* it appears that the Ehippium is really only an altered portion of the Carapace; its outer valve being a part of the outer layer of the Epidermis, and its inner valve the corresponding part of the inner layer. The development of the Ehippial Eggs takes-place at the posterior part of the Ovaries, and is accompanied by the formation of a greenish-brown mass of granules; and from this situation the Eggs pass into the receptacle formed by the new carapace, where they become included between the two layers of the Ehippium. This is cast, in process of time, with the rest of the Skin, from which, however, it soon becomes detached; and it continues to envelope the eggs, generally floating on the surface of the water until they are hatched with the returning warmth of spring. This curious provision obviously affords protection to the Eggs which are to endure the severity of Winter cold; and some approach to it may be seen in the remarkable firmness of the envelopes of the 'Winter Eggs' of some Rotifera (§ 361). There seems a strong probability, from the observations of Sir J. Lubbock, that the Ehippial Eggs are true Sexual products, since Males are to be found at the time when the ehippia are developed; whilst it is certain that the ordinary Eggs can be produced Non-sexually, and that the young which spring from them can multiply the race in like manner. It has been ascertained by Dr. Baird, that the young produced from the Ehippial eggs have the same power of continuing the race by Non-sexual reproduction, as the young developed under ordinary circumstances.

504. In most Entomostraca, the Young at the time of their emersion from the egg differ considerably from the parent, especially in having only the Thoracic portion of the body as yet evolved, and in possessing but a small number of Locomotive appendages (see Fig. 331, c-g); the Visual organs, too, are frequently wanting at first. The process of Development, however, takes place with great rapidity; the animal at each successive Mout (which process is very commonly repeated at intervals of a day or two) presenting some new parts, and becoming more and more like its parent, which it very early resembles in its power of Multiplication, the female laying eggs before she has attained her own full size. Even when the Entomostraca have attained their full growth, they continue to exuviate their Shell at short intervals during the whole of life; and this repeated moulting seems to prevent the animal from being injured, or its movements obstructed, by the overgrowth of parasitic Animalcules and Confervæ; weak and sickly individuals being frequently seen to be so covered with such para-

* 'An account of the two methods of Reproduction in *Daphnia*, and of the structure of the Ehippium,' in "Philosophical Transactions," 1857, p. 79.

sites, that their motion and life are soon arrested, apparently because they have not strength to cast-off and renew their envelopes. The process of Development appears to depend in some degree upon the influence of Light, being retarded when the animals are secluded from it; but its rate is still more influenced by Heat; and this appears also to be the chief agent that regulates the time which elapses between the Moultings of the adult, these, in the *Daphnia*, taking-place at intervals of two days in warm summer weather, whilst several days intervene between them when the weather is colder. The cast Shell carries with it the sheaths not only of the Limbs and Plumes, but of the most delicate Hairs and Setæ which are attached to them. If the animal have previously sustained the loss of a Limb, it is generally renewed at the next moult, as in higher Crustacea.*

505. Closely connected with the Entomostracous group is the tribe of *Suctorial* Crustacea; which for the most part live as Parasites upon the exterior of other animals (especially Fish), whose juices they imbibe by means of the peculiar Proboscis-like organ which takes in them the place of the jaws of other Crustaceans; whilst other appendages, representing the Feet-jaws, are furnished with hooks, by which these parasites attach themselves to the animals from whose juices they derive their nutriment. Many of the Suctorial Crustacea bear a strong resemblance, even in their adult condition, to certain Entomostraca; but more commonly it is between the earlier forms of the two groups that the resemblance is the closest, most of the *Suctorina* undergoing such extraordinary changes in their progress towards the adult condition, that if their complete forms were alone attended-to, they might be excluded from the class altogether, as has (in fact) been done by many Zoologists.—Among those Suctorial Crustacea which present the nearest approach to the ordinary Entomostracous type, may be specially mentioned the *Argulus foliaceus*, which attaches itself to the surface of the bodies of Fresh-water fish, and is commonly known under the name of the 'Fish Louse.' This animal has its body covered with a large firm oval shield, which does not extend, however, over the posterior part of the abdomen. The mouth is armed with a pair of styliform Mandibles; and on each side of the proboscis there is a large short cylindrical appendage, terminated by a curious sort of Sucking-disk, with another pair of longer jointed members, terminated by prehensile Hooks. These two pairs of appendages, which are probably to be considered as representing the Feet-jaws, are followed by four pairs of Legs, which, like those of the Branchiopods, are chiefly adapted for swimming; and the Tail, also, is a kind of swimmeret. This little

* For a systematic and detailed account of this group, see Dr. Baird's "Natural History of the British Entomostraca," published by the Ray Society.

animal can leave the Fish upon which it feeds, and then swims freely in the water, usually in a straight line, but frequently and suddenly changing its direction, and sometimes turning over and over several times in succession. The Stomach is remarkable for the large Cæcal prolongations which it sends out on either side, immediately beneath the shell; for these subdivide and ramify in such a manner, that they are distributed almost as minutely as the cæcal prolongations of the stomach of the *Pianaria* (Fig. 326). The proper Alimentary Canal, however, is continued backwards from the central cavity of the stomach, as an Intestinal tube, which terminates in an Anal orifice at the extremity of the abdomen.—A far more marked departure from the typical form of the Class is shown in the *Lernæa*, which is found attached to the gills of Fishes. This creature has a long suctorial Proboscis; a short Thorax, to which is attached a single pair of Legs, which meet at their extremities, where they bear a Sucker which helps to give attachment to the parasite; a large Abdomen; and a pair of pendent Egg-sacs. In its adult condition it buries its anterior portion in the soft tissues of the animal it infests, and appears to have little or no power of changing its place. But the young, when they come forth from the egg, are as active as the young of *Cyclops* (Fig. 331, c, d), which they much resemble, and only attain the adult form after a series of metamorphoses, in which they cast off their locomotive members and their eyes. It is curious that the original form is retained with comparatively slight change by the Males, which increase but little in size, and are so unlike the females that no one would suppose the two to belong to the same Family, much less to the same Species, but for the Microscopic study of their Development.*

506. From the parasitic Suctorial Crustacea, the transition is not really so abrupt as it might at first sight appear to the group of *Cirrhipeda*, consisting of the *Barnacles* and their allies; which like many of the Suctoria, are fixed to one spot during the adult portion of their lives, but come into the world in a condition that bears a strong resemblance to the early state of many of the true Crustacea. The departure from the ordinary Crustacean type in the adults is, in fact, so great, that it is not surprising that Zoologists in general should have ranked them in a distinct Class; their superficial resemblance to the Mollusca, indeed, having caused most Systematists to place them in that series, until due weight was given to those structural features which mark their Articulated character. We must limit ourselves, in our notice of this group, to that very remarkable part of their history, the Microscopic

* As the group of Suctorial Crustacea is rather interesting to the professed Naturalist than to the amateur Microscopist, even an outline view of it would be unsuitable to the present work; and the Author would refer such of his readers as may desire to study it, to the excellent Treatise by Dr. Baird already referred-to.

study of which has contributed most essentially to the elucidation of their real nature. The observations of Mr. J. V. Thompson,* with the extensions and rectifications which they have subsequently

FIG. 332.

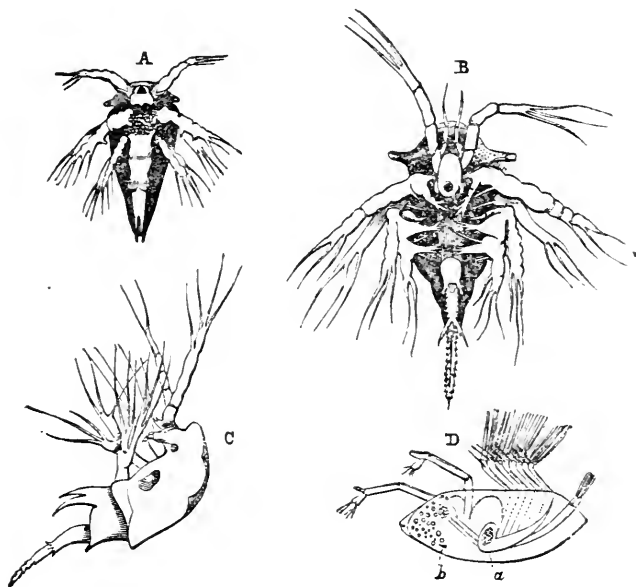

Development of *Balanus balanoides* :—A, earliest form;—B, Larva after second moult;—c, side view of the same;—D, stage immediately preceding the loss of activity; a, Stomach (?; b, Nucleus of future attachment (?).

received from others, show that there is no essential difference between the early forms of the *Sessile* (Balanidæ, or 'Acorn-shells') and of the *Pedunculated* Cirrhipeds (Lepadidæ or 'Barnacles'); for that both are active little animals (Fig. 332, A), possessing three pairs of Legs and a pair of Compound Eyes, and having the body covered with an expanded Carapace, like that of many Entomostracous Crustaceans, so as in no essential particular to differ from the Larva of *Cyclops* (Fig. 331, c). After going through a series of Metamorphoses, one stage of which is represented in Fig. 332, B, c, these Larvæ come to present a form, D, which reminds us strongly of that of *Daphnia*; the body being enclosed in a Shell composed of two Valves, which are united along the back, whilst they are free along their lower margin, where they

* "Zoological Researches," No. III., 1830.

separate for the protrusion of a large and strong anterior pair of prehensile Limbs provided with an adhesive Sucker and Hooks, and of six pairs of posterior Legs adapted for swimming. This Bivalve Shell, with the Members of both kinds, is subsequently thrown-off; the animal then attaches itself by its *Head*, a portion of which, in the Barnacle, becomes excessively elongated into the 'Peduncle' of attachment, whilst in *Balanus* it expands into a broad Disk of adhesion; the first Thoracic segment sends backwards a prolongation which arches over the rest of the body so as completely to enclose it, and of which the exterior layer is consolidated into the 'Multivalve' shell; whilst from the other Thoracic segments are evolved the six pairs of *Cirrhi*, from whose peculiar character the name of the group is derived. These are long, slender, many-jointed, tendril-like appendages, fringed with delicate filaments covered with Cilia, whose action serves both to bring Food to the Mouth, and to maintain Aërating currents in the water.

507. MALACOSTRACA.—The chief points of interest to the Microscopist in the more highly-organized forms of Crustacea are furnished by the structure of the *Shell*, and by the phenomena of *Metamorphosis*, both which may be best studied in the commonest kinds.—The Shell of the *Decapods* in its most complete form consists of three strata; namely, 1, a Horny structureless layer covering the exterior; 2, an Areolated stratum; and 3, a laminated Tubular substance. The innermost and even the middle layers, however, may be altogether wanting; thus in the *Phyllosomæ* or 'Glass-Crabs,' the envelope is formed by the transparent Horny layer alone; and in many of the small Crabs belonging to the genus *Portuna*, the whole substance of the carapace beneath the horny investment presents the Areolated structure. It is in the large thick-shelled Crabs, that we find the three layers most differentiated. Thus in the common *Cancer pagurus*, we may easily separate the structureless Horny covering after a short maceration in dilute acid; the Areolated layer, in which the Pigmentary matter of the coloured parts of the shell is chiefly contained, may be easily brought into view by grinding-away from the *inner* side as flat a piece as can be selected, having first cemented the outer surface to the Glass slide, and by examining this with a magnifying power of 250 diameters, driving a strong light through it with the Achromatic Condenser; whilst the Tubular structure of the thick inner layer may be readily demonstrated, by means of Sections parallel and perpendicular to its surface. This structure, which very strongly resembles that of *Dentine* (§ 546), save that the tubuli do not branch, but remain of the same size through their whole course, may be particularly well seen in the black extremity of the Claw, which (apparently from some difference in the molecular arrangement of the Mineral particles, the Organic structure being precisely the same) is much

denser than the rest of the Shell; the former having almost the semi-transparency of Ivory, whilst the latter has a Chalky opacity. In a transverse section of the Claw, the Tubuli may be seen to radiate from the central cavity towards the surface, so as very strongly to resemble their arrangement in a Tooth; and the resemblance is still further increased by the presence, at tolerably regular intervals, of minute sinuosities corresponding with the laminations of the shell, which seem, like the 'secondary curvatures' of the Dentinal Tubuli, to indicate successive stages in the calcification of the Animal basis. In thin sections of the Areolated layer it may be seen that the apparent walls of the areole are merely translucent spaces from which the tubuli are absent, their orifices being abundant in the intervening spaces.* The tubular layer rises-up through the pigmentary layer of the Crab's shell in little papillary elevations, which seem to be concretionary nodules; and it is from the deficiency of the pigmentary layer at these parts, that the coloured portion of the shell derives its minutely-speckled appearance.—Many departures from this type are presented by the different species of Decapods; thus in the *Prawns* there are large stellate Pigment-spots (resembling those of Frogs, Fig. 393, c), the colours of which are often in remarkable conformity with those of the bottom of the Rock-pools frequented by these creatures; whilst in the *Shrimps* there is seldom any distinct trace of the Areolated layer, and the Calcareous portion of the skeleton is disposed in the form of Concentric Rings, which seem to be the result of the concretionary aggregation of the calcifying deposit (§ 599).

508. It is a very curious circumstance, that a strongly-marked difference exists between Crustaceans that are otherwise very closely allied, in regard to the degree of change to which their young are subject in their progress towards the adult condition. For whilst the common *Crab*, *Lobster*, *Spiny Lobster*, *Prawn*, and *Shrimp* undergo a regular Metamorphosis, the young of the *Land-Crab* and the *Cray-fish* come-forth from the egg in a form which corresponds in all essential particulars with that of their parents. Generally speaking, a strong resemblance exists among the young of all the species of Decapods which undergo a Metamorphosis, whether they are afterwards to belong to the *Macrourous* (long-tailed) or to the *Brachyurous* (short-tailed) division of the group; and the forms of these Larvæ are so peculiar, and so entirely different from any of those into which they are ultimately to be developed, that they were considered as belonging to a distinct

* The Author is now quite satisfied of the correctness of the interpretation put by Prof. Huxley (see his Article, 'Tegumentary Organs,' in the "Cyclop. of Anat. and Phys.," Vol. v., p. 487) and by Prof. W. C. Williamson ('On some Histological Features in the Shells of Crustacea,' in "Quart. Journ. of Microsc. Science," Vol. viii., 1860, p. 38), upon the appearances which he formerly described ("Reports of British Association" for 1847, p. 128) as indicating a Cellular structure in this layer.

genus, *Zoea*, until their real nature was first ascertained by Mr. J. V. Thompson. Thus, in the earliest state of *Carcinus mænas* (small edible Crab), we see the head and thorax, which form the

FIG. 333.

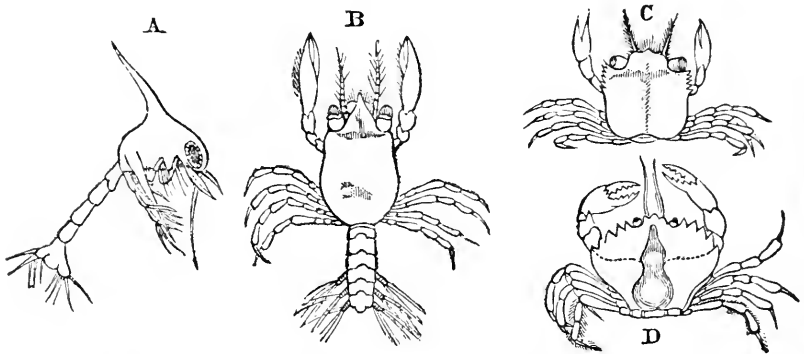

Metamorphosis of *Carcinus mænas*.—A, First or *Zoea* stage; B, Second or *Megalopa* stage; C, Third stage, in which it begins to assume the adult form; D, Perfect form.

principal bulk of the body, included within a large Carapace or shield (Fig. 333, A) furnished with a long projecting spine, beneath which the Fin-feet are put-forth: whilst the Abdominal segments, narrowed and prolonged, carry at the end a flattened Tail-fin, by the strokes of which upon the water, the propulsion of the animal is chiefly effected. Its condition is hence comparable, in almost all essential particulars, to that of *Cyclops* (§ 499). In the case of the Lobster, Prawn, and other Macrourous species, the Metamorphosis chiefly consists in the separation of the Locomotive and Respiratory organs; true Legs being developed from the Thoracic segments for the former, and true Gills (concealed within a special chamber formed by an extension of the Carapace beneath the body) for the latter; and the Abdominal segments increase in size, and become furnished with appendages (false feet) of their own. In the Crabs, or Brachyurous species, on the other hand, the alteration is much greater; for besides the change first noticed in the Thoracic members and Respiratory organs, the Thoracic region becomes much more developed at the expense of the abdominal, as seen at B, in which stage the Larva is remarkable for the large size of its Eyes, and hence received the name of *Megalopa* when it was supposed to be a distinct type. In the next stage, C, we find the Abdominal portion reduced to an almost rudimentary condition, and bent under the body; the Thoracic limbs are more completely adapted for walking, save the first pair,

which are developed into *Chelæ* or pincers ; and the little creature entirely loses the active swimming habits which it originally possessed, and takes-on the mode of life peculiar to the adult.

509. In collecting minute Crustacea, the Ring-net should be used for the Fresh-water species, and the Tow-net for the Marine. In localities favourable for the latter, the same 'gathering' will often contain multitudes of various species of Entomostraca, accompanied, perhaps, by the larvæ of higher Crustacea, by Echinoderm-larvæ, by Annelid-larvæ, and by the smaller Medusæ. The water containing these should be put into a large Glass Jar, freely exposed to the light ; and after a little practice, the eye will become so far habituated to the general appearance and modes of movement of these different forms of Animal life, as to be able to distinguish them one from the other. In selecting any specimen for Microscopic examination, the Dipping-tube (§ 100) will be found invaluable. If the Collector should happen to gather any floating leaves of *Zostera*, he will do well to examine these for *Megalopa*-larvæ, which the Author has frequently found clinging to their surface, his attention being directed to them by the brightness of their two black eye-spots.—The study of the Metamorphosis will be best prosecuted, however, by obtaining the fertilized Eggs which are carried-about by the Females, and watching the history of their products.—For preserving specimens, whether of Entomostraca, or of Larvæ of the higher Crustacea, the Author would recommend Glycerine-Jelly as the best medium.

CHAPTER XVII.

INSECTS AND ARACHNIDA.

THERE is no Class in the whole Animal Kingdom which affords to the Microscopist such a wonderful variety of interesting objects, and such facilities for obtaining an almost endless succession of novelties, as that of Insects. For, in the first place, the number of different kinds that may be brought-together (at the proper time) with extremely little trouble, far surpasses that which any other group of Animals can supply to the most painstaking Collector: then, again, each Specimen will afford, to him who knows how to employ his materials, a considerable number of Microscopic objects of very different kinds; and, thirdly, although some of these objects require much care and dexterity in their preparation, a large proportion may be got-out, examined, and mounted, with very little skill or trouble. Take, for example, the common House-Fly:—its *Eyes* may be easily mounted, one as a transparent, the other as an opaque object (§ 517); its *Antennæ*, although not such beautiful objects as those of many other Diptera, are still well worth examination (§ 518); its *Tongue* or ‘Proboscis’ is a peculiarly interesting object (§ 519), though requiring some care in its preparation; its *Spiracles*, which may be easily cut-out from the sides of its body, have a very curious structure (§ 525); its Alimentary canal affords a very good example of the minute distribution of the ‘Tracheæ’ (§ 524); its *Wings*, examined in a living specimen newly come-forth from the Pupa state, exhibit the Circulation of the blood in the ‘Nervures’ (§ 523); the Wing of this Insect, when dead, moreover, exhibits a most beautiful play of Iridescent colours, and shows a remarkable Areolation of surface, when it is examined by light reflected from its surface at a particular angle (§ 528); its *Foot* has a very peculiar conformation, which is doubtless connected with its singular power of walking over smooth surfaces in direct opposition to the force of gravity, although the mode in which it serves this purpose is not yet certainly ascertained (§ 530); and the structure and physiology of its Sexual apparatus, with the history of its Development and Metamorphoses, would of itself suffice to occupy the whole time of an

observer who should desire thoroughly to work it out, not only for months but for years. Hence, in treating of this department in such a work as the present, the Author labours under the *embarras des richesses*; for to enter into such a description of the parts of the structure of Insects most interesting to the Microscopist, as should be at all comparable in fulness with the accounts which it has been thought desirable to give of other Classes, would swell-out the volume to an inconvenient bulk; and no course seems open, but to limit the treatment of the subject to a notice of the *kinds* of objects which are likely to prove most generally interesting, with a few illustrations that may serve to make the descriptions more clear, and with an enumeration of some of the sources whence a variety of specimens of each class may be most readily obtained. And this limitation is the less to be regretted, since there already exist in our language numerous elementary treatises on Entomology, wherein the general structure of Insects is fully explained, and the conformation of their minute parts as seen with the Microscope is adequately illustrated.

510. A considerable number of the smaller Insects—especially those belonging to the Orders *Coleoptera* (Beetles), *Neuroptera* (Dragon-fly, May-fly, &c.), *Hymenoptera* (Bee, Wasp, &c.), and *Diptera* (two-winged Flies),—may be mounted entire as Opaque objects for low magnifying powers; care being taken to spread out their Legs, Wings, &c., so as adequately to display them, which may be accomplished, even after they have dried in other positions, by softening them by steeping them in hot water, or, where this is objectionable, by exposing them to steam. Full directions on this point, applicable to small and large Insects alike, will be found in all Text-books of Entomology. There are some, however, whose translucence allows them to be viewed as Transparent objects; and these are either to be mounted in Canada Balsam, or in Deane's Gelatine, Glycerine Jelly, or Farrants's Gum, according to the degree in which the horny opacity of their integument requires the assistance of the Balsam to facilitate the transmission of light through it, or the softness and delicacy of their textures render a preservative Medium more desirable. Thus an ordinary *Flea* or *Bug* will best be mounted in Balsam; but the various Parasites of the *Louse* kind, with some or other of which almost every kind of animal is affected, should be set-up in some of these 'Media.' Some of the Aquatic Larvæ of the *Diptera* and *Neuroptera*, which are so transparent that their whole internal organization can be made-out without dissection, are very beautiful and interesting objects when examined in the living state, especially because they allow the Circulation of the Blood and the action of the Dorsal Vessel to be discerned (§ 522). Among these, there is none preferable to the Larva of the *Ephemera marginata* (Day-fly), which is distinguished by the possession of a number of beautiful appendages on its body and tail, and is, moreover, an extremely common

inhabitant of our ponds and streams. This Insect passes two or even three years in its Larva state, and during this time it repeatedly throws-off its skin; the cast Skin, when perfect, is an object of extreme beauty, since, as it formed a complete sheath to the various appendages of the body and tail, it continues to exhibit their outlines with the utmost delicacy; and by keeping these Larvæ in a Vivarium, and by mounting the entire series of their cast Skins, a record is preserved of the successive changes they undergo. Much care is necessary, however, to extend them upon slides, in consequence of their extreme fragility; and the best plan is to place the slip of Glass under the skin whilst it is floating on water, and to lift the object out upon the slide.—A method of cutting *sections* of Insects, Caterpillars, &c., with the Section-instrument (§ 137), has lately been practised by Dr. Halifax, with most excellent results. The body of the Insect is first soaked for some time in thick Gum-mucilage, which passes into its substance, and gives support to its tissues. It is then enclosed in a casing of Wax, and this again is surrounded by a hollow cylinder of Wood made to fit the cavity of the Section-instrument, which for this purpose must be larger than usual; and this being raised by successive turns of the Screw, very thin sections can be obtained, by which the internal parts of the Insect are brought into view in their normal relations.

511. *Structure of the Integument.*—In treating of those separate parts of the organization of Insects which furnish the most interesting objects of Microscopic study, we may most appropriately commence with their Integument and its Appendages (Scales, Hairs, &c). The body and members are closely invested by a hardened Skin, which acts as their Skeleton, and affords points of attachment to the Muscles by which their several parts are moved; being soft and flexible, however, at the joints. This Skin is usually more or less Horny in its texture, and is consolidated by the Animal substance termed *Chitine*, as well as, in some cases, by a small quantity of Mineral matter. It is in the *Coleoptera* that it attains its greatest development; the Dermo-skeleton of many Beetles being so firm as not only to confer upon them an extraordinary power of passive resistance, but also to enable them to put forth enormous force by the action of the powerful Muscles which are attached to it. It may be stated as a general rule, that the outer layer of this Dermo-skeleton is always Cellular, taking the place of an Epidermis; and that the Cells are straight-sided and closely fitted-together, so as to be polygonal (usually hexagonal) in form. Of this we have a very good example in the *superficial* layers (Fig. 341, B) of the thin horny lamellæ or blades, which constitute the terminal portion of the Antenna of the *Cockchafer* (Fig. 340); this layer being easily distinguished from the intermediate portion of the lamina (A), by careful focussing. In many Beetles, the Hexagonal areolation of the surface is often distin-

guishable when the light is reflected from it at a particular angle, even when not discernible in transparent sections. The integument of the common *Red Ant* exhibits the hexagonal cellular arrangement very distinctly throughout; and the broad flat expansion of the leg of the *Crabro* (Sand-wasp) affords another beautiful example of a distinctly-cellular structure in the outer layer of the integument. The inner layer, however, which constitutes the principal part of the thickness of the horny casing of the Beetle-tribe, seldom exhibits any distinct organization; though it may be usually separated into several laminae, which are sometimes traversed by tubes that pass into them from the inner surface, and extend towards the outer without reaching it.

512. *Tegumentary Appendages*.—The surface of many Insects is beset, and is sometimes completely covered, with *appendages*, having sometimes the form of broad flat Scales, sometimes that of Hairs more or less approaching the cylindrical shape, and sometimes being intermediate between the two.—The *Scaly* investment is most complete among the *Lepidoptera* (Butterfly and Moth tribe); the distinguishing character of the Insects of this order being derived from the presence of a regular layer of Scales upon each side of their large membranous Wings. It is to the peculiar coloration of the Scales that the various hues and figures are due, by which these Wings are so commonly distinguished; all the Scales of one patch (for example) being green, those of another red; and so on; for the subjacent Membrane remains perfectly transparent and colourless, when the scales have been brushed-off from its surface. Each Scale seems to be composed of two superficial coloured laminae, enclosing a central lamina of structureless membrane, the surface of which is highly polished, and which acts as a 'foil' to increase their brilliancy by reflecting back the light that passes through them,—an arrangement which may often be discerned in Scales that have lost a portion of their superficial layer by some accidental injury.* The colour of the superficial laminae seems to be generally inherent in their substance, especially in the *Lepidoptera*; but it sometimes appears to be (like the prismatic hues of a soap-bubble) a purely-optical effect of their extreme thinness, this being especially the case among those Beetles, as the *Curculio imperialis* (Diamond-beetle), the Scales of which have a metallic lustre, and exhibit colours that vary with the mode in which the light glances from them. Each Scale is furnished with a sort of handle at one end (Figs. 334, 335), by which it is fitted into a minute socket attached to the surface of the insect; and on the Wings of *Lepidoptera* these sockets are so arranged that the scales lie in very regular rows, each row overlapping a portion of the next, so as to give to their surface, when sufficiently magnified,

* See the Memoir of M. Bern. Deschamps 'Sur l'Organisation des ailes de Lepidoptères,' in "Ann. des Sci. Nat.," Sér. 2, Zool., Tom. iii. (1835), p. 111.

very much the appearance of being *tiled* like the roof of a house. Such an arrangement is said to be 'Imbricated.' The forms of these Scales are often very curious, and frequently differ a good deal on the several parts of the Wings and of the Body of the same individual; being usually more expanded on the former, and narrower and more hair-like on the latter. The peculiar markings which many of these Scales exhibit, very early attracted the attention of those engaged in the improvement of the Microscope by the application of the principle of Achromatic Correction; since these markings are entirely invisible, however great may be the magnifying power employed, under Microscopes of the older construction, owing to the necessary limitation of their Angular Aperture; whilst, as they are brought into view with a clearness and strength that are proportionate to the extension of the Angular Aperture and the perfection with which the Aberrations are corrected, they serve as 'Test Objects' of the goodness of an Achromatic combination. At first, the Scale of the *Podura* (Fig. 335) was the most difficult Test known for the *highest* powers; and a Microscope which could only exhibit an alternation of dark and light bands or Striæ upon its surface, was considered a good one. But even the complete resolution of these Striæ into their component markings, is now considered as but a very ordinary test for the *medium*

FIG. 334.

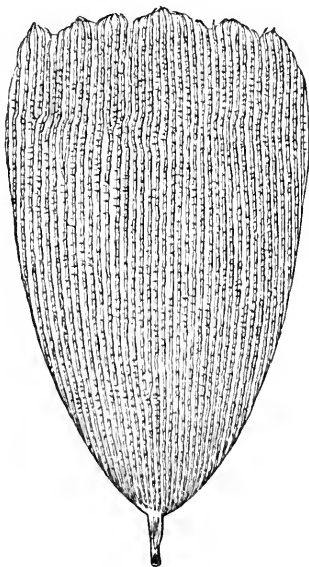
Scale of *Morpho Menelaus*.

powers of the Microscope; and Tests of much greater difficulty, and therefore more suitable for the higher, are afforded (as we have seen, § 132, III.) by the Valves of the Diatomaceæ. Still, the resolution of their markings depends more upon *angle of aperture* than upon other qualities of an Objective; and for testing *definition, penetration*, and that general excellence which is needed to constitute a good 'working power,' there is probably no better object than a *Podura* scale. Further, as even the easier Test-scales of Insects have their use, in enabling us to appreciate the performance of Achromatic Objectives of *medium* power (§ 132, II.), it will be advantageous here to notice a few of those which are most commonly employed for this purpose.

513. Among the most beautiful of all these Scales, both for colour and for regularity of marking, are those of the Butterfly termed *Morpho Menelaus* (Fig. 334). These are of a rich blue tint, and exhibit strong longitudinal striæ, which seem due to ribbed elevations of the superficial coloured layer. There is also an appearance of transverse striation, which cannot be seen at all with an inferior Objective, becomes very decided with a good Objective of medium focus, but is found, when submitted to the test of a high power and Achromatic Condenser, to depend upon a sort of beaded subdivision of the longitudinal ribs; the transverse striæ that may be seen *between* these ribs being apparently produced by the beading of the ribs on the other surface of the scale.—The large Scales of the *Polyommatus argus* (Azure-blue Butterfly) resemble those of the *Menelaus* in form and structure, but are more delicately marked. The same Insect, however, furnishes small Scales, which are commonly termed the 'Battledoor' scales, the resemblance which their form presents to that instrument being usually much greater than in the specimen represented in Fig. 335; these scales, also, are marked by narrow longitudinal ribbings, which at intervals expand into rounded or oval elevations that give to the scale a dotted appearance; at the lower part of the scale, however, these dots are wanting; and in the interval between the two portions, we observe a sort of crescent, formed of minute pigment-granules, crossing the scale transversely.—The Scales of the *Pontia brassica* (Cabbage-Butterfly) and of the *Hipparchia janira* (Meadow-brown Butterfly), have longitudinal markings of a somewhat similar nature, but less sharply defined; these are further noticeable for the brush-like appendage which each scale bears at the end furthest from its implantation.—Although scarcely useful as a 'Test-object,' since its structure is too easily resolved, the Scale of the *Lepisma saccharina* or 'Sugar-Louse' deserves notice; the longitudinal ribbings being so strongly marked and so regular, rising at intervals into tooth-like projections, as to give them an appearance resembling that of many Bivalve Shells. The long narrow Scale of the common *Gnat*, also, exhibits a few very prominent straight-edged ribbings; and from its small size, it serves as a good Test-object for the medium powers.—The *Podura plumbea* or 'Spring-Tail' is a little wingless Insect that is occasionally

FIG. 335.

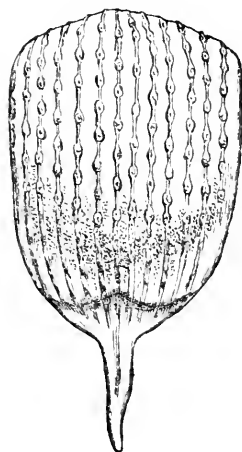

Battledoor Scale of
Polyommatus argus
(Azure-blue).

found amidst the sawdust of wine-cellars, in garden tool-houses, or near decaying wood, leaping about like a Flea by means of that

FIG. 336.

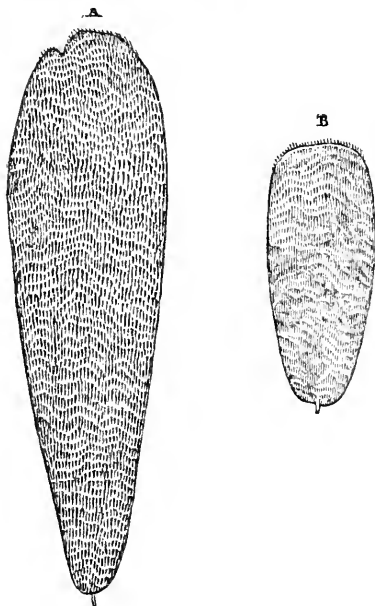

Scales of *Podura plumbea*:—A, large strongly-marked scale; B, small scale, more faintly-marked.

peculiar power of using its tail from which its name is derived. Its Scales are of different sizes and of different degrees of strength of marking (Fig. 336, A, B), and are therefore by no means of uniform value as tests. The general appearance of their surface, under a power not sufficient to resolve their marking, is that of Watered Silk, light and dark bands passing across with wavy irregularity; but a well-corrected Objective of very moderate Angular Aperture now suffices to resolve every dark band into a row of short lines, each of these being thick at one end and coming to a point at the other, so that the impression conveyed is that of a set of Spines projecting obliquely from the flat surface of the scale, like the teeth of a 'Hackle.' Under a well-corrected 1-8th

inch Objective, the appearance of the markings by transmitted light is that which is represented in Plate II., fig. 2; when, however, they are illuminated by oblique light from above (the Scales being placed under the objective without any cover, so as to avoid the loss of light by reflection from its surface), the appearances presented are those shown in fig. 4 when the markings are at right angles to the direction of the light, and in fig. 5 when they lie in the same direction as the light with their narrow ends pointing to it. When this last direction is reversed, the light from the points is so slight that the scales appear to have lost their markings altogether. When moisture insinuates itself between the Scale and the Covering-glass, the markings disappear entirely, as shown in fig. 3. All these phenomena seem best explained upon the supposition that the markings of the Podura-scale (between which, notwithstanding their *transverse* sinuosity, a *longitudinal* continuity may be traced)

resemble those of the *Lepisma*-scale in being due to a series of *toothed ridges*, the profile of which resembles the edge of a Saw.*

514. The *Hairs* of many Insects, and still more of their Larvæ, are very interesting objects for the Microscope, on account of their branched or tufted conformation; this being particularly remarkable in those with which the common hairy Caterpillars are so abundantly beset. Some of these afford very good tests for the perfect correction of Objectives. Thus, the hair of the *Bee* is pretty sure to exhibit strong prismatic colours, if the Chromatic Aberration should not have been exactly neutralized; and that of the Larva of the *Dermestes* or 'Bacon-beetle' was once thought a very good test of defining power, and is still useful for this purpose. It has a cylindrical shaft (Fig. 337, B) with closely-set whorls of spiny protuberances, four or five in each whorl; the highest of those whorls is composed of more knobby spines; and the hair is surmounted by a curious circle of six or seven large filaments, attached by their pointed ends to its shaft, whilst at their free extremities they dilate into knobs. An approach to this structure is seen in the Hairs of certain *Myriapods* (Centipedes, Gally-worms, &c.), of which an example is shown in Fig. 337, A; and some minute forms of this class are most beautiful objects under the Binocular Microscope, on account of the remarkable structure and regular arrangement of their hairs.

FIG. 337.

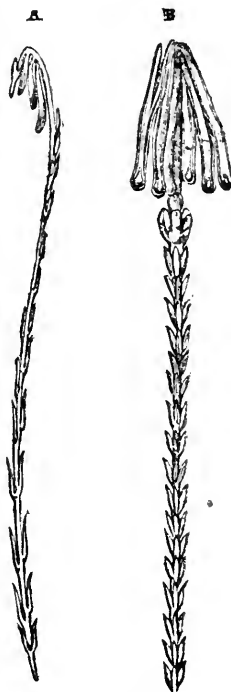

A, Hair of *Myriapod*.
B, Hair of *Dermestes*.

* See Mr. R. Beck 'On the Scales of *Lepidocyrtus* — ? hitherto termed *Podura*-scales, and their value as Tests for the Microscope,' in "Trans. of Microsc. Soc.," N.S., Vol. x. (1862), p. 83.—The Author quite accords with Mr. R. Beck in his interpretation of the appearances of the *Podura*-scale. Mr. Beck gives the following as his mode of removing the scales:—"Wherever practicable, I prefer taking the stone, piece of wood, or whatever the Insects may be on (if at all portable) into the house, where I spread a large piece of paper on the table; they are easily brushed-off on to this, when they should be immediately covered over, before they have time to hop, by some small thing, such as the top or bottom of a pill-box; if this be left over them for a minute or so, and then removed, they will be found to be quite quiet, and a slide or a piece of thin glass may be carefully pressed upon them, without squeezing out any of their juices,

515. In examining the Integument of Insects, and its Appendages, parts of the surface may be viewed either by reflected or transmitted light, according to their degree of transparence and the nature of their covering. The Beetle and the Butterfly tribes furnish the greater number of the objects suitable to be viewed as *opaque* objects; and nothing is easier than to mount portions of the *Elytra* of the former (which are usually the most showy portions of their bodies), or of the Wings of the latter, in the manner described in § 155. The tribe of *Curculionida*, in which the surface of the body is beset with Scales having the most varied and lustrous hues, is distinguished among Coleoptera for the brilliancy of the objects it affords; the most remarkable in this respect being the well-known *Curculio imperialis*, or 'Diamond Beetle' of South America, parts of whose *Elytra*, when properly illuminated and looked-at with a low power, show like clusters of jewels flashing against a dark velvet ground. In many of the British *Curculionida*, which are smaller and far less brilliant, the Scales lie at the bottom of little depressions of the surface; and if the *Elytra* of the Diamond Beetle be carefully examined, it will be found that each of the clusters of Scales which are arranged upon it in rows, seems to rise out of a deep pit which sinks-in by its side. The transition from Scales to Hairs is extremely well seen by comparing the different parts of the surface of the 'Diamond Beetle' with each other. The beauty and brilliancy of many objects of this kind are increased by mounting them in cells in Canada balsam, even though they are to be viewed with reflected light; other objects, however, are rendered less attractive by this treatment; and in order to ascertain whether it is likely to improve or to deteriorate the specimen, it is a good plan first to test some other portion of the body having Scales of the same kind, by touching it with Turpentine, and then to mount the part selected as an object, either in Balsam, or dry, according as the Turpentine increases or diminishes the brilliancy of the Scales on the spot to which it was applied. Portions of the Wings of *Lepidoptera* are best mounted as opaque objects, without any other preparation than gumming them flat down to the disk of the Wooden Slide (§ 155); care being taken to avoid disturbing the arrangement of the scales, and to keep the objects, when mounted, as secluded as possible from dust. In selecting such portions, it is well to choose those which have the brightest and the most contrasted colours, Foreign butterflies being in this respect usually preferable to British; and before attaching them to their Slides, care should be taken to ascertain in what position, with the arrangement of light ordinarily used, they are seen to the best

whilst the scales will adhere closely to the glass. As by this method, however, the Insects will frequently hop away and escape, they may be made perfectly motionless by applying, with a camel's hair pencil, a little Chloroform near them, upon the paper, before the cover is moved."

advantage, and to fix them there accordingly.—Whenever portions of the Integument of Insects are to be viewed as *transparent* objects, for the display of their intimate structure, they should be mounted in Canada Balsam, after soaking for some time in Turpentine; since this substance has a peculiar effect in increasing their translucence. Not only the Horny casings of perfect Insects of various orders, but also those of their Pupæ, are worthy of this kind of study; and objects of great beauty (such as the Chrysalis-case of the Emperor-moth), as well as of scientific interest, are sure to reward such as may prosecute it with any assiduity. Further information may often be gained by softening such parts in Potash, and viewing them in fluid.—The *Scales* of the Wings of Lepidoptera, &c., are best transferred to the Slide, by simply pressing a portion of the wing either upon the slip of Glass or upon the cover; if none should adhere, the glass may first be gently breathed-on. Some of them are best seen when examined 'dry,' whilst others are more clear when mounted in fluid; and for the determination of their exact structure it is well to have recourse to both these methods. If these Scales are to be used as Test Objects, it is preferable to place them between two pieces of Thin Glass, in the manner specified in § 154. Hairs, on the other hand, are best mounted in Balsam.

516. *Parts of the Head.*—The *Eyes* of Insects, situated upon the upper and outer part of the head, are usually very conspicuous organs, and are frequently so large as to touch each other in front (Fig. 338). We find in their structure a remarkable example of that multiplication of similar parts which seems to be the predominating 'Idea' in the conformation of Articulated animals; for each of the large protuberant bodies which we designate as an

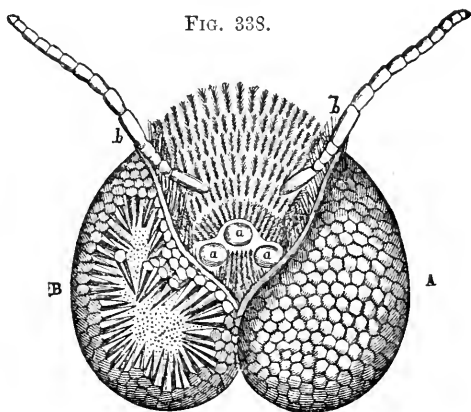

Head and Compound Eyes of the *Bee*, showing the Ocelli *in situ* on one side (A), and displaced on the other (B); a, a, a, Stemmata; b, b, Antennæ.

Eye, is really an aggregate of many hundred, or even many thousand minute eyes, which are designated *Ocelli*. Approaches to this structure are seen in the Annelida and Entomostraca; but

the number of Ocelli thus grouped-together is usually small. In the higher Crustacea, however, the Ocelli are very numerous;

FIG. 339.

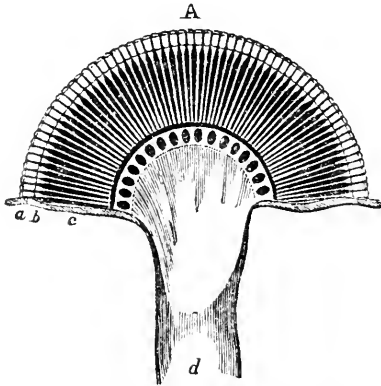

Section of the Eye of *Melolontha vulgaris* (Cockchafer):—*a*, facets of the Cornea; *b*, transparent pyramids surrounded with Pigment; *c*, fibres of the Optic Nerve; *d*, trunk of the Optic Nerve.

each facet is the 'Corneule' of a separate Ocellus, and has a convexity of its own; hence by counting the facets, we can ascertain the number of Ocelli in each Composite Eye. In the two Eyes of the common *Fly*, there are as many as 4000; in those of the *Cabbage-Butterfly*, there are about 17,000; in the *Dragon-fly*, 24,000; and in the *Mordella Beetle*, 25,000. Behind each 'Corneule' is a layer of dark Pigment, which takes the place and serves the purpose of the 'Iris' in the Eyes of Vertebrate animals; and this is perforated by a central aperture or 'Pupil,' through which the rays of light that have traversed the corneule gain access to the interior of the eye. The further structure of these bodies is best examined by vertical sections (Fig. 339); and these show that the shape of each Ocellus (*b*) is conical, or rather pyramidal, the Corneule forming its base (*a*), whilst its apex abuts upon the extremity of a fibre (*c*) proceeding from the termination of the Optic Nerve (*d*). The details of the structure of each Ocellus are shown in Fig. 340; in which it is shown that each Corneule is a double-convex Lens, made up by the junction of two plano-convex lenses, *a a* and *a' a'*, which have been found by Dr. Hicks to possess a different refractive power; by this arrangement (it seems probable) the Aberrations are diminished, as they are by the combination of 'humors' in the Human eye. That each 'Corneule' acts as a distinct Lens may be shown by detaching the entire assemblage by maceration, and then drying it (flattened-out) upon a slip of glass; for when this is placed under the Microscope, if the point of a knife, scissors, or any

their compound Eyes being constructed upon the same general plan as those of Insects, although their shape and position are often very peculiar (Fig. 406). The individual Ocelli are at once recognized, when the Composite Eyes are examined under even a low magnifying power, by the 'faceted' appearance of the surface (Fig. 338), which is marked-out by very regular divisions either into hexagons or into squares:

similar object, be interposed between the mirror and the stage, the image of this point will be seen, by a proper adjustment of the focus of the microscope, in every one of the lenses. The focus of each 'Corneule' has been ascertained by experiment to be equivalent to the length of the pyramid behind it; so that the image which it produces will fall upon the extremity of the filament of the Optic Nerve which passes to the latter. The pyramids (*b, b*) consist of a transparent substance, which may be considered as representing the 'Vitreous Humor;' and they are separated from each other by a layer of dark pigment, *d', d'*, which closes-in at *d, d*, between their bases and the corneules, leaving a set of Pupillary apertures, *c, c*, for the entrance of the rays which pass to them from the 'corneules.' After traversing these pyramids, the rays reach the bulbous extremities *e, e* of the fibres of the Optic Nerve, which are surrounded, like the pyramid, by pigmentary substance. Thus the rays which have passed through the several 'Corneules' are prevented from mixing with each other; and no rays, save those which pass in the axes of the Pyramids, can reach the fibres of the Optic Nerve. Hence it is evident, that, as no two Ocelli on the same side have exactly the same axis, no two can receive their rays from the same point of an object;

and thus, as each Composite Eye is immovably fixed upon the Head, the combined action of the entire aggregate will probably only afford but a single image, resembling that which we obtain by means of our Single eyes.—Although the foregoing may be considered as the typical structure of the Eyes of Insects, yet there are various departures from it (most of them slight) in the different members of the Class. Thus in some cases the posterior surface of each 'Corneule' is concave; and a space is left between it and the Iris-like diaphragm, which seems to be occupied by a watery fluid or 'Aqueous Humor;' in other instances, again, this space is occupied by a double-convex body, which seems to represent the 'Crystalline-Lens;' and this body is sometimes found behind the Iris, the number of Ocelli being reduced, and each one being larger, so that the cluster presents more resemblance to that of Spiders, &c.—Besides their Composite Eyes, Insects usually possess a small number of rudimentary Single Eyes,

FIG. 340.

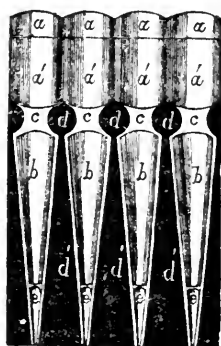

Minute structure of the Eye of the *Bee*:—*a a*, anterior lenses of Corneule; *a' a'*, its posterior lenses; *c c*, Pupillary apertures, separated by intervening Pigment *d d*; *b b*, Pyramids separated by Pigment *d' d'*, and abutting on *e e*, bulbous extremities of Nerve-fibres.

resembling those of the Arachnida ; these are seated upon the top of the head (Fig. 338, *a, a, a*), and are termed *Stemmata*.—It is remarkable that the Larvæ of Insects which undergo a complete Metamorphosis, only possess Single Eyes ; the Composite Eyes being developed, at the same time with the Wings and other parts which are characteristic of the Imago state, during the latter part of Pupal life.

517. Various modes of preparing and mounting the Eyes of Insects may be adopted, according to the manner wherein they are to be viewed. For the observation of their external faceted surface by reflected light, it is better to lay-down the entire Head, so as to present a front-face or a side-face, according to the position of the eyes ; the former giving a view of *both* eyes, when they approach each other so as nearly or quite to meet (as in Fig. 338) ; whilst the latter will best display *one*, when the eyes are situated more at the sides of the head. For the minuter examination of the 'Corneules,' however, these must be separated from the hemispheroidal mass whose exterior they form, by prolonged maceration ; and the pigment must be carefully washed-away, by means of a fine camel-hair brush, from the inner or posterior surface. In flattening them out upon the glass-slide, one of two things must necessarily happen ; either the margin must tear when the central portion is pressed-down to a level ; or, the margin remaining entire, the central portion must be thrown into plaits, so that its Corneules overlap one another. As the latter condition interferes with the examination of the structure much more than the former does, it should be avoided by making a number of slits in the margin of the convex membrane before it is flattened-out. Such preparations may be mounted either in Liquid, Medium, or Canada Balsam ; the latter being preferable when (as sometimes happens) the membrane is so horny as to be but imperfectly transparent. Vertical Sections, adapted to demonstrate the structure of the Ocelli and their relations to the Optic Nerve, can of course be only made when the body of the Insect is fresh ; and these should be mounted in Liquid or in Medium. The following are some of the Insects whose eyes are best adapted for Microscopic preparations :—*Coleoptera*, Cicindela, Dytiscus, Melolontha (Cockchafer), Lucanus (Stag-beetle) ;—*Orthoptera*, Acheta (House and Field Crickets), Locusta ;—*Hemiptera*, Notonecta (Boat-fly) ;—*Neuroptera* Libellula (Dragon-fly), Agrion ;—*Hymenoptera*, Vespidae (Wasps) and Apidae (Bees) of all kinds ;—*Lepidoptera*, Vanessa (various species of Butterflies), Sphinx ligustri (Privet hawk-moth), Bombyx (Silk-worm moth, and its allies) ;—*Diptera*, Tabanus (Gad-fly), Asilus, Eristalis (Drone-fly), Tipula (Crane-fly), Musca (House-fly), and many others.

518. The *Antennæ*, which are the two jointed appendages arising from the upper part of the head of Insects (Fig. 338, *b, b*), present a most wonderful variety of conformation in the several tribes of

Insects ; often differing considerably in the several Species of one Genus, and even in the two Sexes of the same Species. Hence the characters which they afford are extremely useful in Classification ; especially since their Structure must almost necessarily be in some way related to the Habits and general Economy of the creatures to which they belong, although our imperfect acquaintance with their function may prevent us from clearly discerning this relation. Thus, in the Coleopterous Order, we find one large Family, including the Glow-worm, Fire-fly, Skip-jack, &c., distinguished by the toothed or serrated form of the Antennæ, and hence called *Serricornes* ; in another, of which the Burying-beetle is the type, the Antennæ are terminated by a Club-shaped enlargement, so that these beetles are termed *Clavicornes* ; in another, again, of which the *Hydrophilus* or Large Water-beetle is an example, the Antennæ are never longer and are commonly shorter than one of the pairs of palpi, whence the name of *Palpicornes* is given to this group ;

FIG. 341.

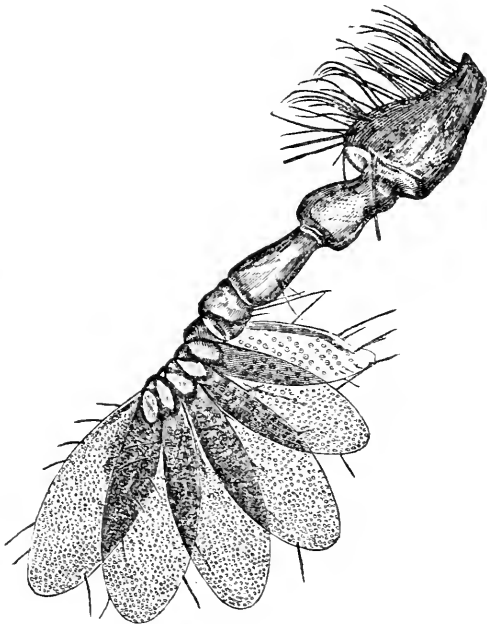
Antenna of *Melolontha* (Cockchafer).

in the very large family that includes the *Lucani* or Stag - Beetles with the *Scarabæi*, of which the Cockchafer is the commonest example, the Antennæ terminate in a set of Leaf-like appendages, which are sometimes arranged like a fan or the leaves of an open book (Fig. 341), are sometimes parallel to each other like the teeth of a comb, and sometimes fold one over the other, thence giving the name *Lammelicornes* ; whilst another large family is distinguished by the appellation *Longicornes*, from the great length of the Antennæ, which are at least as long as the body, and often longer. Among the Lepidoptera, again, the confor-

mation of the Antennæ frequently enables us at once to distinguish the group to which any specimen belongs. As every treatise on Entomology contains figures and descriptions of the principal types of conformation of these organs, there is no occasion here to dwell upon them longer than to specify such as are most interesting to the Microscopist:—*Coleoptera*, *Brachinus*, *Calathus*, *Harpalus*, *Dytiscus*, *Staphylinus*, *Philonthus*, *Elater*, *Lampyris*, *Silpha*, *Hydrophilus*, *Aphodius*, *Melolontha*, *Cetonia*, *Curculio*;—*Orthoptera*, *Forficula* (Earwig), *Blatta* (Cockroach);—*Lepidoptera*, *Sphinges* (Hawk-moths), and *Nocturna* (Moths) of various kinds, the large 'plumed' antennæ of the latter being peculiarly beautiful objects under a low magnifying power;—*Diptera*, *Culicidæ* (Gnats of various kinds), *Tipulidæ* (Crane-flies and Midges), *Tabanus*, *Eristalis*, and *Muscidæ* (Flies of various kinds). All the larger Antennæ should be put up in Balsam, after being soaked for some time in Turpentine; but the small feathery Antennæ of Gnats and Midges are so liable to distortion when thus mounted, that it is better to set them up in fluid, the Head with its pair of antennæ being thus preserved together when not too large.—A curious set of organs has been recently discovered in the Antennæ of many Insects, which have been supposed to constitute collectively an apparatus for Hearing. Each consists of a cavity hollowed out in the Horny Integument, sometimes nearly spherical, sometimes flask-shaped, and sometimes prolonged into numerous extensions formed by

FIG. 342.

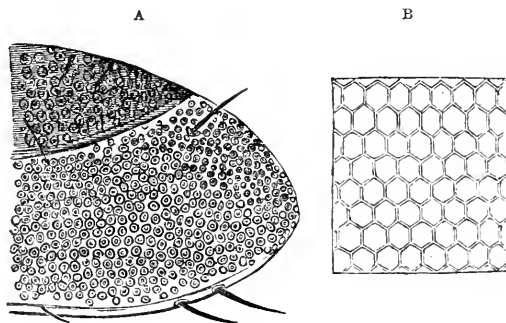

Minute structure of Leaf-like expansions of Antenna of *Melolontha*:—
A, their internal layer; B, their superficial layer.

the folding of its lining membrane; the mouth of the cavity seems to be normally closed-in by a continuation of this membrane, though its presence cannot always be satisfactorily determined; whilst to its deepest part a nerve-fibre may be traced. The expanded lamellæ of the Antennæ of *Melolontha* present a great display of these cavities, which are indicated in

Fig. 341, A, by the small circles that beset almost their entire area; their form, which is very peculiar, can here only be made-out by vertical sections; but in many of the smaller antennæ, such as those of the Bee, the cavities can be seen sideways without any other trouble than that of bleaching the specimen to render it more transparent.*

519. The next point in the organization of Insects to which the attention of the Microscopist may be directed, is the structure of the *Mouth*. Here, again, we find almost infinite varieties in the details of conformation; but these may be for the most part reduced to a small number of types or plans, which are characteristic of the different orders of Insects. It is among the *Coleoptera*, or Beetles, that we find the several parts of which the mouth is composed in their most distinct form; for although some of these parts are much more highly developed in other Insects, other parts may be so much altered or so little developed as to be scarcely recognizable. The *Coleoptera* present the typical conformation of the *Mandibulate* mouth, which is adapted for the prehension and division of solid substances; and this consists of the following parts:—1, a pair of Jaws, termed *Mandibles*, frequently furnished with powerful Teeth, opening laterally on either side of the mouth, and serving as the chief instruments of manducation; 2, a second pair of Jaws, termed *Maxillæ*, smaller and weaker than the preceding, beneath which they are placed, and serving to hold the food, and to convey it to the back of the mouth; 3, an upper Lip, or *Labrum*; 4, a lower Lip, or *Labium*; 5, one or two pairs of small jointed appendages termed *Palpi*, attached to the *Maxillæ*, and hence called *Maxillary Palpi*; 6, a pair of *Labial Palpi*. The labium is often composed of several distinct parts; its basal portion being distinguished as the *Mentum* or chin, and its anterior portion being sometimes considerably prolonged forwards, so as to form an organ which is properly designated the *Ligula*, but which is more commonly known as the 'Tongue,' though not really entitled to that designation, the real *tongue* being a soft and projecting organ which forms the floor of the mouth, and which is only found as a distinct part in a comparatively small number of Insects, as the Cricket.—

* See the Memoir of Dr. Hicks 'On a new Structure in the Antennæ of Insects,' in "Trans. of Linn. Soc.," Vol. xxii., p. 147; and his 'Further Remarks' at p. 383 of the same volume. See also the Memoir of M. Lespès 'Sur l'Appareil Auditif des Insectes,' in "Ann. des Sci. Nat.," Sér. 4, Zool., Tom. ix., p. 258; and that of M. Claparède "Sur les prétendus Organes Auditifs des Coléoptères lamellicornes et autres Insectes," in "Ann. des Sci. Nat.," Sér. 4, Zool., Tom. x., p. 236. Dr. Hicks lays great stress on the 'bleaching process,' as essential to success in this investigation; and he gives the following directions for performing it:—Take of Chlorate of Potass a drachm, and of Water a drachm and a half; mix these in a small wide bottle containing about an ounce; wait five minutes, and then add about a drachm and a half of strong Hydrochloric Acid. Chlorine is thus slowly developed; and the mixture will retain its bleaching power for some time.

This Ligula is extremely developed in the *Fly* kind, in which it forms the chief part of what is commonly called the 'Proboscis' (Fig. 343);

FIG. 343.

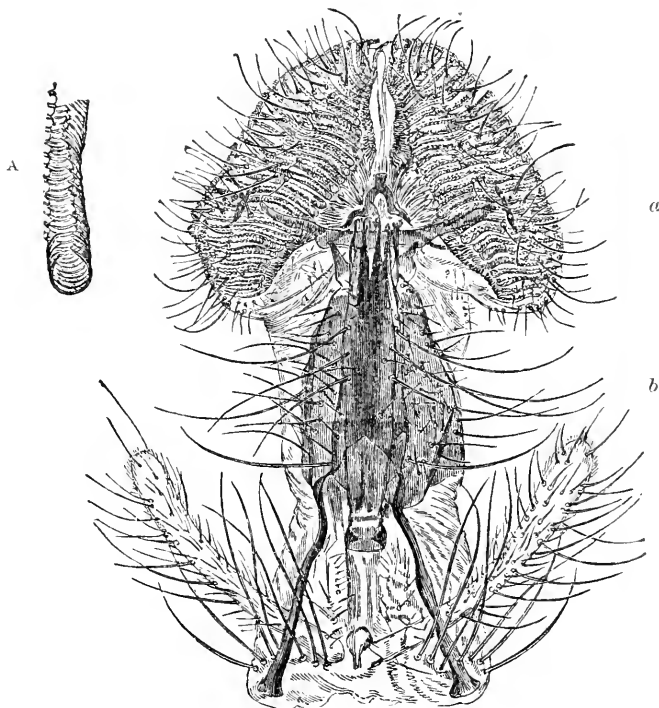

Tongue of common *Fly*:—*a*, lobes of Ligula; *b*, portion enclosing the Lancets formed by the metamorphosis of the Maxillæ; *c*, Maxillary Palpi:—*A*, portion of one of the metamorphosed Tracheæ enlarged.

and it also forms the 'Tongue' of the *Bee* and its allies (Fig. 344). The Tongue of the Common Fly presents a curious modification of the ordinary Tracheal structure (§ 525), the purpose of which is not apparent; for instead of its Tracheæ being kept pervious, after the usual fashion, by the winding of a continuous spiral fibre through their interior, the fibre is broken into rings, and these rings do not surround the whole tube, but are terminated by a set of arches that pass from one to another (Fig. 343, *A*).—In the *Diptera* or two-winged Flies generally, the Labrum, Maxillæ, Mandibles, and the internal Tongue (where it exists) are converted into delicate Lancet-shaped organs termed *Setæ*, which, when closed together, are received into

a hollow on the upper side of the Labium (Fig. 343, *b*), but which are capable of being used to make punctures in the Skin of Animals or the Epidermis of Plants, whence the juices may be drawn forth by the proboscis. Frequently, however, two or more of these organs may be wanting, so that their number is reduced from six, to four, three, or two.—In the *Hymenoptera* (Bee and Wasp tribe), however, the Labrum and the Mandibles (Fig. 344, *b*) much resemble those of

Mandibulate Insects, and are used for corresponding purposes; the Maxillæ (*c*) are greatly elongated, and form, when closed, a tubular sheath for the *Ligula* or 'Tongue,' through which the honey is drawn up; the Labial Palpi (*d*) also are greatly developed, and fold together, like the Maxillæ, so as to form an inner sheath for the 'Tongue;' while the 'Ligula' itself (*e*) is a long tapering muscular organ, marked by an immense number of short annular divisions, and densely covered over its whole length with long hairs (B). It is not tubular, as

FIG. 344.

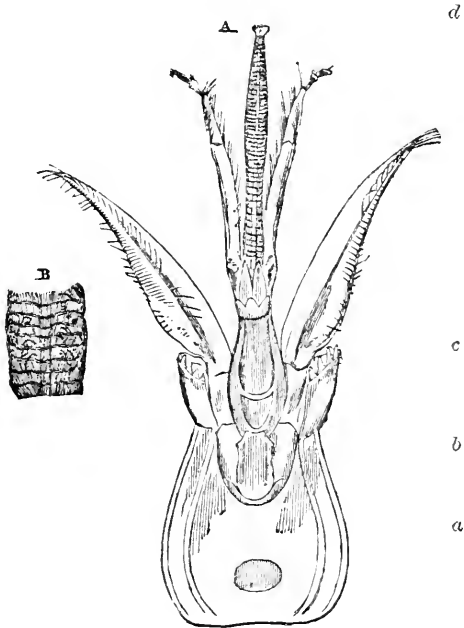

A, Parts of the Mouth of *Apis mellifica* (Honey-bee):—*a*, Mentum; *b*, Mandibles; *c*, Maxillæ; *d*, Labial Palpi; *e*, Ligula, or prolonged labium, commonly termed the Tongue:—*B*, portion of the surface of the Ligula, more highly magnified.

but is solid; when actively employed in taking food, it is extended to a great distance beyond the other parts of the mouth; but when at rest, it is closely packed-up and concealed between the Maxillæ. "The manner," says Mr. Newport, "in which the honey is obtained when the organ is plunged into it at the bottom of a flower, is by 'lapping,' or a constant succession of short and quick extensions and contractions of the organ, which occasion the fluid to accumulate upon it and to ascend along its upper surface, until it

reaches the orifice of the tube formed by the approximation of the maxillæ above, and of the labial palpi and this part of the ligula below."

520. By the plan of conformation just described, we are led to that which prevails among the *Lepidoptera* or Butterfly tribe, and which, being pre-eminently adapted for suction, is termed the *Haustellate* mouth. In these Insects, the Labrum and Mandibles are reduced to three minute triangular plates; whilst the Maxillæ are immensely elongated, and are united together along the median line to form the *Haustellium* or Proboscis, which contains a tube formed by the junction of the two grooves that are channelled-out along their mutually applied surfaces, and which serves to pump-up the juices of deep cup-shaped flowers, into which the size of their wings prevents these Insects from entering. The length of this *Haustellium* varies greatly: thus in such *Lepidoptera* as take no food in their perfect state, it is a very insignificant organ; in some of the white Hawk-Moths, which hover over blossoms without alighting, it is nearly two inches in length; and in most Butterflies and Moths it is about as long as the body itself. This *Haustellium*, which, when not in use, is coiled-up in a spiral beneath the mouth, is an extremely beautiful Microscopic object, owing to the peculiar banded arrangement it exhibits (Fig. 345), which is

FIG. 345.

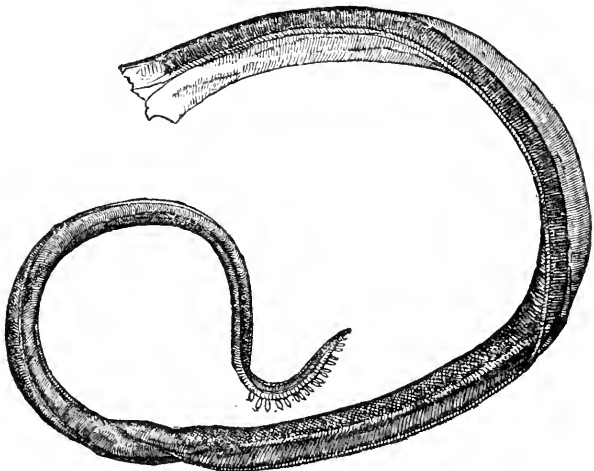

Haustellium (proboscis) of *Vanessa*.

probably due to the disposition of its muscles. In many instances, the two halves may be seen to be locked together by a set of hooked teeth, which are inserted into little depressions between the

teeth of the opposite side. Each half, moreover, may be ascertained to contain a Trachea or air-tube (§ 524); and it is probable, from the observations of Mr. Newport,* that the sucking-up of the juices of a flower through the Haustellium (which is accomplished with great rapidity) is effected by the agency of the Respiratory apparatus. The Proboscis of many Butterflies is furnished, for some distance from its extremity, with a double row of small projecting barrel-shaped bodies (shown in Fig. 345), which are surmised by Mr. Newport (whose opinion is confirmed by the kindred inquiries of Dr. Hicks, § 518) to be organs of Taste.—Numerous other modifications of the structure of the Mouth, existing in the different tribes of Insects, are well worthy of the careful study of the Microscopist; but as detailed descriptions of most of these will be found in every Systematic Treatise on Entomology, the foregoing general account of the principal types must suffice.

521. *Parts of the Body.*—The conformation of the several divisions of the *Alimentary Canal* presents such a multitude of diversities, not only in different tribes of Insects, but in different states of the same individual, that it would be utterly vain to attempt here to give even a general idea of it; more especially as it is a subject of far less interest to the ordinary Microscopist than it is to the professed Anatomist. Hence we shall only stop to mention that the muscular Gizzard in which the Œsophagus very commonly terminates, is often lined by several rows of strong Horny Teeth for the reduction of the food, which furnish very beautiful Microscopic objects, especially for the Binocular. These are particularly developed among the Grasshoppers, Crickets, and Locusts, the nature of whose food causes them to require powerful instruments for its reduction.

522. The *Circulation of Blood* may be distinctly watched in many of the more transparent Larvæ, and may sometimes be observed in the perfect Insect. It is kept-up, not by an ordinary heart, but by a 'Dorsal Vessel' (so named from the position it always occupies along the middle of the back), which really consist of a succession of Muscular Hearts or contractile cavities, one for each Segment, opening one into another from behind forwards, so as to form a continuous trunk divided by valvular partitions. In many Larvæ, however, these partitions are very indistinct, and the walls of the 'Dorsal vessel' are so thin and transparent that it can with difficulty be made-out, a limitation of the light by the Diaphragm being often necessary. The blood which moves through this trunk, and which is distributed by it to the body, is a transparent and nearly-colourless fluid, carrying with it a number of 'oat-shaped' corpuscles, by the motion of which its flow can be followed. The current enters the Dorsal Vessel at its posterior extremity, and is propelled forwards by the contractions of the successive chambers, being prevented from moving in the opposite direction by the valves

* "Cyclopædia of Anatomy and Physiology," Vol. ii., p. 902.

between the chambers, which only open forwards. Arrived at the anterior extremity of the Dorsal Vessel, the blood is distributed in three principal channels; a central one, namely, passing to the Head, and a lateral one to either side, descending so as to approach the lower surface of the body. It is from the two Lateral currents that the secondary streams diverge, which pass into the Legs and Wings, and then return back to the main stream; and it is from these also, that, in the Larva of the *Ephemera marginata* (Day-fly), the extreme transparence of which renders it one of the best of all subjects for the observation of Insect Circulation, the smaller currents diverge into the Gill-like appendages with which the body is furnished (§ 526). The blood-currents seem rather to pass through channels excavated among the tissues, than through vessels with distinct walls; but it is not improbable that in the perfect Insect the case may be different. In many Aquatic Larvæ, especially those of the *Culicidæ* (Gnat tribe), the body is almost entirely occupied by the visceral cavity; and the blood may be seen to move backwards in the space that surrounds the Alimentary canal, which here serves the purpose of the channels usually excavated through the solid tissues, and which freely communicates at each end with the Dorsal Vessel. This condition strongly resembles that found in many Annelida.*

523. The Circulation may be easily seen in the Wings of many Insects in their *Pupa* state, especially in those of the Neuropterous Order (such as Dragon-flies and Day-flies) which pass this part of their lives under water in a condition of activity; the *Pupa* of *Agrion puella*, one of the smaller Dragon-flies, is a particularly favourable subject for such observations. Each of the 'Nervures' of the wings contains a 'Trachea' or Air-tube (§ 524), which branches-off from the Tracheal system of the body; and it is in a space around the trachea that the Blood may be seen to move, when the hard framework of the nervure itself is not too opaque. The same may be seen, however, in the wings of Pupæ of Bees, Butterflies, &c., which remain shut-up motionless in their cases; for this condition of apparent torpor is one of great activity of their Nutritive system,—those organs, especially, which are peculiar to the perfect Insect, being then in a state of rapid growth, and having a vigorous Circulation of Blood through them. In certain Insects of nearly every Order, a movement of fluid has been seen in the Wings for some little time after their last Metamorphosis; but this movement soon ceases, and the Wings dry-up. The common *Fly* is as good a subject for this observation as can be easily found; it must be caught within a few hours or days of its first appearance; and the Circulation may be most conveniently

* See the Memoirs on *Corethra plumicorius*, by Prof. Rymer Jones, in "Transact. of Microsc. Soc.," Vol. xv. (N.S.), p. 99; by Mr. E. Ray Lankester in the "Popular Science Review" for October, 1865; and by Dr. A. Weissmann in "Siebold and Kölliker's Zeitschrift," Bd. xvi., p. 45.

brought into view by enclosing it (without water) in the Aquatic Box, and pressing-down the cover sufficiently to keep the body at rest without doing it any injury.

524. The *Respiratory Apparatus* of Insects affords a very interesting series of Microscopic objects; for, with great uniformity in its general plan, there is almost infinite variety in its details. The Aeration of the Blood in this class is provided-for, not by the transmission of the fluid to any special organ representing the *Lung* of a Vertebrated animal (§ 583) or the *Gill* of a Mollusk (§ 481), but by the introduction of Air into every part of the body, through a system of minutely-distributed *Tracheæ* or Air-tubes, which penetrate even the smallest and most delicate organs. Thus, as we have seen, they pass into the *Haustellium* or 'Pro-boscis' of the Butterfly (§ 520), and they are minutely distributed in the elongated *Labium* or 'Tongue' of the Fly (Fig. 343). Their general distribution is shown in Fig. 346; where we see two long trunks (*f*) passing from one end of the body to the other, and connected with each other by a transverse canal in every segment; these trunks communicate, on the one hand, by short wide passages, with the 'Stigmata,' 'Spiracles,' or Breathing-pores (*g*), through which the air enters and is discharged; whilst they give off branches to the different segments, which divide again and again into ramifications of extreme minuteness. They usually communicate also with a pair of Air-sacs (*h*) which is situated in the Thorax; but the size of these (which are only found in the perfect Insect, no trace of them existing in the Larvæ) varies greatly in different tribes, being usually greatest in those Insects which (like the Bee) can sustain the longest and most powerful flight, and least in such as habitually live upon the ground or upon the surface of the water. The structure of the Air-tubes reminds us of that of the 'Spiral Vessels' of Plants, which seem destined (in part at least) to perform a similar office (§ 295); for within the membrane that forms their outer wall, an elastic Fibre winds round and round, so as to form a Spiral closely resembling in its position and functions the spiral wire-spring of flexible Gas-pipes; within this again, however, there is another membranous wall to the Air-tubes, so that the spire winds between their inner and outer coats.—When a portion of one of the great Trunks with some of the principal Branches of the Tracheal system has been dissected-out, and so pressed in mounting that the sides of the tubes are flattened against each other (as has happened in the specimen represented in Fig. 347), the Spire forms two layers which are brought into close apposition; and a very beautiful appearance, resembling that of Watered Silk, is produced by the crossing of the two sets of fibres, of which one overlies the other. That this appearance, however, is altogether an Optical illusion, may be easily demonstrated by carefully following the course of any one of the fibres, which will be found to be perfectly regular.

525. The 'Stigmata' or 'Spiracles' through which the Air enters the Tracheal system, are generally visible on the exterior of the

FIG. 346.

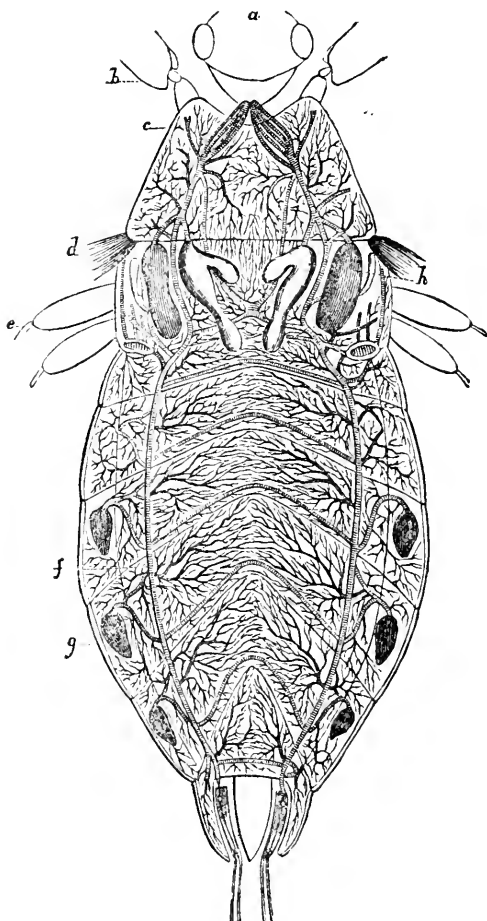

Tracheal system of *Nepa* (Water-scorpion):—*a*, Head; *b*, first pair of Legs; *c*, first segment of the Thorax; *d*, second pair of Wings; *e*, second pair of Legs; *f*, Tracheal trunk; *g*, one of the Stigmata; *h*, Air-sac.

body of the Insect (especially on the abdominal segments) as a series of pores along each margin of the under surface. In most

Larvæ, nearly every segment is provided with a pair ; but in the perfect Insect, several of them remain closed, especially in the Thoracic region, so that their number is often considerably reduced. The structure of the Spiracles varies greatly in regard to complexity in different Insects ; and even where the general plan is the same, the details of conformation are peculiar, so that perhaps in scarcely any two Species are they alike. Generally speaking they are furnished with some kind of Sieve at their entrance, by which particles of dust, soot, &c., which would otherwise enter the Air-passages, are filtered out ; and this sieve may be formed by the interlacement of the branches of minute arborescent growths from the borders of the Spiracle, as in the common *Fly* (Fig. 348), or in the *Dytiscus* ; or

FIG. 347.

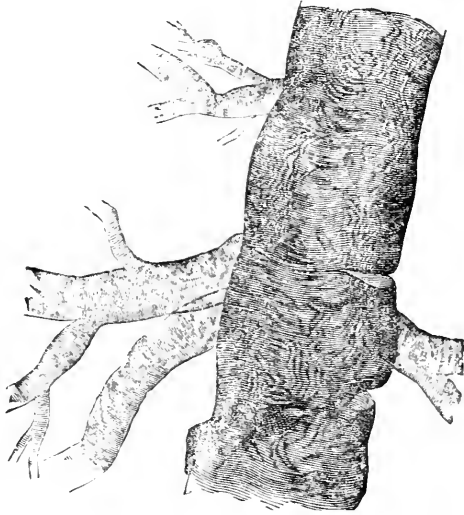

Portion of a large Trachea of *Dytiscus*, with some of its principal branches.

or in the common *Fly* (Fig. 348), or in the *Dytiscus* ; or

FIG. 348.

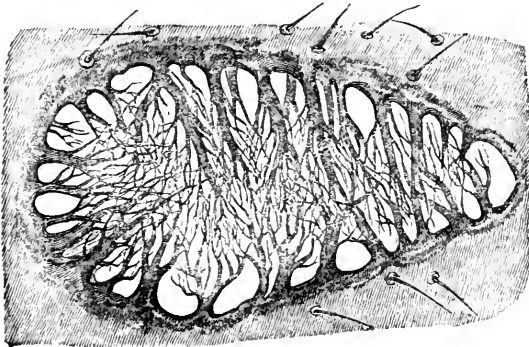

Spiracle of Common *Fly*.

x x 2

it may be a membrane perforated with minute holes, and supported upon a framework of bars that is prolonged in like manner from the thickened margin of the aperture (Fig. 349), as in the

FIG. 349.

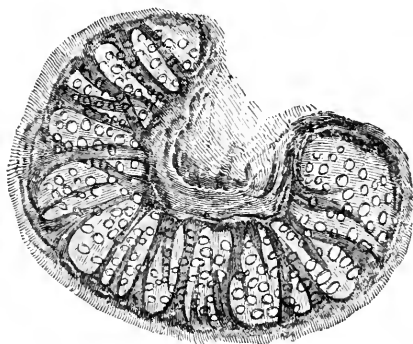
Spiracle of Larva of *Cockchafer*.

Larva of the *Melolontha* (Cockchafer). Not unfrequently, the centre of the aperture is occupied by an impervious disk, from which radii proceeded to its margin, as is well seen in the Spiracle of *Tipula* (Crane-fly).—In those Aquatic Larvæ which breathe air, we often find one of the Spiracles of the last segment of the abdomen prolonged into a tube, the mouth of which remains at the surface while the body is im-

mersed; the Larvæ of the *Gnat* tribe may frequently be observed in this position.

526. There are many Aquatic Larvæ, however, which have an entirely-different provision for respiration; being furnished with external Leaf-like or Brush-like appendages into which the Tracheæ are prolonged, so that, by absorbing Air from the water that bathes them, they may convey this into the interior of the body. We cannot have a better example of this than is afforded by the Larva of the common *Ephemera* (Day-fly), the body of which is furnished with a set of branchial appendages resembling the 'Fin-feet' of Branchiopods (§ 497), whilst the three-pronged Tail also is fringed with clusters of delicate hairs which appear to minister to the same function. In the Larva of the *Libellula* (Dragon-fly), the extension of the surface for Aquatic Respiration takes-place within the termination of the Intestine; the lining membrane of which is folded into an immense number of plaits, each containing a minutely ramified system of Tracheæ; the Water, slowly drawn-in through the Anus for bathing this surface, is ejected with such violence that the body is impelled in the opposite direction; and the Air taken-up by its Tracheæ is carried, through the system of Air-tubes of which they form part, into the remotest organs. This apparatus is a peculiarly interesting object for the Microscope, on account of the extraordinary copiousness of the distribution of the Tracheæ in the Intestinal folds.

527. The main trunks of the Tracheal system, with their principal ramifications, may generally be got-out with little difficulty, by laying-open the body of an Insect or Larva under water in a

Dissecting-trough (§ 134), and removing the whole Visceral mass, taking care to leave as many as possible of the branches which will be seen proceeding to this from the two great longitudinal Tracheæ, to whose position these branches will serve as a guide. Mr. Quekett recommends the following as the most simple method of obtaining a perfect system of Tracheal tubes from a Larva:—a small opening having been made in its body, this is to be placed in strong Acetic acid, which will soften or decompose all the viscera; and the tracheæ may then be well-washed with the Syringe, and removed from the body with the greatest facility, by cutting away the connections of the main tubes with the spiracles by means of fine pointed scissors. In order to mount them, they should be floated upon the Slide, on which they should then be laid-out in the position best adapted for displaying them. If they are to be mounted in Canada Balsam, they should be allowed to dry upon the slide, and should then be treated in the usual way; but their natural appearance is best preserved by mounting them in fluid (weak Spirit or Goadby's Solution), using a shallow cell to prevent pressure. The finer ramifications of the Tracheal system may generally be seen particularly well in the membranous wall of the Stomach or Intestine; and this, having been laid-out and dried upon the glass, may be mounted in Balsam so as to keep the Tracheæ full of air (whereby they are much better displayed), if care be taken to use Balsam that has been previously thickened, to drop this on the object without liquefying it more than is absolutely necessary, and to heat the Slide and the Cover (the heat may be advantageously applied directly to the cover, after it has been put-on, by turning-over the slide so that its upper face shall look downwards) only to such a degree as to allow the Balsam to spread and the cover to be pressed-down.—The Spiracles are easily dissected out by means of a pointed knife or a pair of fine scissors; they should be mounted in Fluid or Medium when their texture is soft, and in Balsam when the integument is hard and horny.

528. *Wings*.—These organs are essentially composed of an extension of the external membranous layer of the Integument, over a framework formed by prolongations of the inner Horny layer, within which prolongations Tracheæ are nearly always to be found, whilst they also include channels through which Blood circulates during the growth of the Wing and for a short time after its completion (§ 523). This is the simple structure presented to us in the Wings of *Neuroptera* (Dragon-flies, &c.), *Hymenoptera* (Bees and Wasps), *Diptera* (two-winged-Flies), and also of many *Homoptera* (Cicadæ and Aphides); and the principal interest of these Wings as Microscopic objects lies in the distribution of their 'veins' or 'nervures' (for by both names are the ramifications of their skeleton known), and in certain points of accessory structure. The Venation of the Wings is most beautiful in the smaller *Neuroptera*; since it is the distinguishing feature of this Order

that the veins, after subdividing, reunite again, so as to form a close network; whilst in the Hymenoptera and Diptera such reunions are rare, especially towards the margin of the wings, and the areolæ are much larger. Although the membrane of which these Wings are composed appears perfectly homogeneous when viewed by transmitted light, even with a high magnifying power, yet, when viewed by light reflected obliquely from their surfaces, an appearance of Cellular areolation is often discernible; this is well seen in the common *Fly*, in which each of these areolæ has a hair in its centre. In order to make this observation, as well as to bring-out the very beautiful Iridescent hues which the Wings of many minute Insects (as the Aphides) exhibit when thus viewed, it is convenient to hold the Wing in the Stage-Forceps for the sake of giving it every variety of inclination; and when that position has been found which best displays its most interesting features, it should be set up as nearly as possible in the same. For this purpose it should be mounted on an Opaque Slide; but instead of being laid down upon its surface, the wing should be raised a little above it, its 'stalk' being held in the proper position by a little cone of soft wax, in the apex of which it may be imbedded.—The Wings of most Hymenoptera are remarkable for the peculiar apparatus by which those of the same side are connected together, so as to constitute in flight but one large wing; this consists of a row of curved Hooklets on the anterior margin of the posterior wing, which lay hold of the thickened and doubled-down posterior edge of the anterior wing. These hooklets are sufficiently apparent in the wings of the common *Bee*, when examined with even a low magnifying power; but they are seen better in the *Wasp*, and better still in the *Hornet*.—The peculiar Scaly covering of the Wings of the Lepidoptera has already been noticed (§ 512); but it may here be added that the entire wings of many of the smaller and commoner Insects of this Order, such as the *Tineidæ* or 'Clothes-moths,' form very beautiful Opaque objects for low powers; the most beautiful of all being the divided wings of the *Fissipennes* or 'Plumed-moths,' especially those of the genus *Pterophorus*.

529. There are many Insects, however, in which the Wings are more or less consolidated by the interposition of a layer of Horny substance between the two layers of membrane. This plan of structure is most fully carried-out in the *Coleoptera* (Beetles), whose anterior wings are metamorphosed into *Elytra* or Wing-cases; and it is upon these that the brilliant hues by which the integument of many of these Insects is distinguished, are most strikingly displayed. In the Anterior Wings of the *Forficulidæ* or Earwig-tribe (which form the connecting link between this Order and the Orthoptera), the Cellular structure may often be readily distinguished when they are viewed by transmitted light, especially after having been mounted in Canada Balsam. The Anterior

Wings of the *Orthoptera* (Grasshoppers, Crickets, &c.), although not by any means so solidified as those of *Coleoptera*, contain a good deal of Horny matter : they are usually rendered sufficiently transparent, however, by Canada Balsam, to be viewed with transmitted light ; and many of them are so coloured as to be very showy objects (as are also the posterior fan-like wings) for the Solar or Gas-microscope, although their large size, and the absence of any minute structure, prevent them from affording much interest to the ordinary Microscopist.—We must not omit to mention, however, the curious Sound-producing apparatus which is possessed by most Insects of this order, and especially by the common *House-Cricket*. This consists of the 'Tympanum' or Drum, which is a space on each of the upper wings, scarcely crossed by veins, but bounded externally by a large dark vein provided with three or four longitudinal ridges ; and of the 'File' or 'Bow,' which is a transverse horny ridge in front of the Tympanum, furnished with numerous teeth : and it is believed that the sound is produced by the rubbing of the two Bows across each other, while its intensity is increased by the sound-board action of the Tympanum.—The Wings of the *Fulgoridæ* (Lantern-flies) have much the same texture with those of the *Orthoptera*, and possess about the same value as Microscopic objects ; differing considerably from the purely-membranous wings of the *Cicadæ* and *Aphides*, which are associated with them in the order *Homoptera*. In the order *Hemiptera*, to which belong various kinds of Land and Water Insects that have a Suctorial mouth resembling that of the common *Bug*, the wings of the anterior pair are usually of parchmenty consistence, though membranous near their tips, and are often so richly coloured as to become very beautiful objects, when mounted in Balsam and viewed by transmitted light ; this is the case especially with the Terrestrial Vegetable-feeding kinds, such as the *Pentatoma* and its allies, some of the tropical forms of which rival the most brilliant of the Beetles. The British species are by no means so interesting ; and the Aquatic kinds, which, next to the Bed-bugs, are the most common, always have a dull brown or almost black hue ; even among these last, however,—of which the *Notonecta* (Water-Boatman) and the *Nepa* (Water-Scorpion) are well-known examples,—the wings are beautifully variegated by differences in the depth of that hue. The *Halteres* of the *Diptera*, which are the representatives of the Posterior Wings, have lately been shown by Dr. J. B. Hicks to present a very curious structure, which is found also in the Elytra of *Coleoptera* and in many other situations ; consisting in a multitude of Vesicular projections of the superficial membrane, to each of which there proceeds a Nervous filament, that comes to it through an aperture in the Tegumentary wall on which it is seated. Various considerations are stated by Dr. Hicks, which lead him to the belief that this apparatus, when developed in the neighbourhood of the Spiracles or breathing-pores, essentially ministers to the sense of *Smell*,

whilst, when developed upon the Palpi and other organs in the neighbourhood of the Mouth, it ministers to the sense of *Taste*.*

530. *Fect.*—Although the Feet of Insects are formed pretty much on one general plan, yet that plan is subject to considerable modifications, in accordance with the habits of life of different species. The entire limb usually consists of five divisions, namely, the *Coxa* or Hip, the *Trochanter*, the *Femur* or Thigh, the *Tibia* or Shank, and the *Tarsus* or Foot; and this last part is made up of several successive joints. The typical number of these joints seems to be *five*; but that number is subject to reduction; and the vast order *Coleoptera* is subdivided into primary groups, according as the Tarsus consists of *five*, *four*, or *three* segments. The last joint of the Tarsus is usually furnished with a pair of strong Hooks or Claws (Figs. 350, 351); and these are often serrated (that is, furnished with saw-like teeth), especially near the base. The under-surface of the other joints is frequently beset with tufts of hairs, which are arranged in various modes, sometimes forming a complete 'Sole;' this is especially the case in the Family *Curculionidae*; so that a pair of the feet of the Diamond-Beetle, mounted so that one shows the upper surface made resplendent by

FIG. 350.

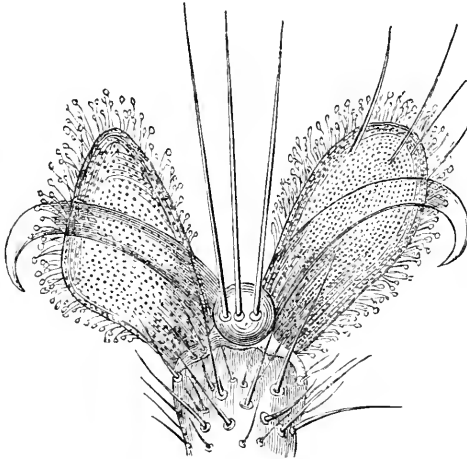

Foot of *Fly*.

its jewel-like scales, and the other the hairy cushion beneath, is a very interesting object. In many Insects, especially of the *Fly* kind, the Foot is furnished with a pair of membranous expansions termed *Pulvilli* (Fig. 350); and these are beset with numerous Hairs, each of which has a minute disk at its extremity. This structure is evi-

dently connected with the power which these Insects possess of

* See his Memoir 'On a new Organ in Insects,' in "Journal of Linnæan Society," Vol. i. 1856, p. 136; his 'Further remarks on the Organs found on the bases of the Halteres and Wings of Insects,' in "Transact. of the Linn. Soc.," Vol. xxii., p. 141; and his Memoir 'On certain Sensory Organs in Insects hitherto undescribed,' in "Transact. of Linn. Soc.," Vol. xxiii., p. 189.

walking over smooth surfaces in opposition to the force of gravity ; yet there is still considerable uncertainty as to the precise mode in which it ministers to this faculty. Some believe that the Pulvilli act as suckers, the Insect being held-up by the pressure of the air against their upper surface, when a vacuum is formed beneath ; whilst others maintain that the adhesion is the result of the secretion of a viscid liquid from the under side of the foot. The careful observations of Mr. Hepworth have led him to a conclusion which seems in harmony with all the facts of the case ; namely, that the minute disks at the extremity of the individual hairs act as suckers, and that each of them secretes a liquid which, though not viscid, serves to make its adhesion perfect.* And this view of the case derives confirmation from the presence of a similar apparatus, on a far larger scale, on the foot of the *Dytiscus* (Fig. 351, A). The first joints of the Tarsus of this Insect

FIG. 351.

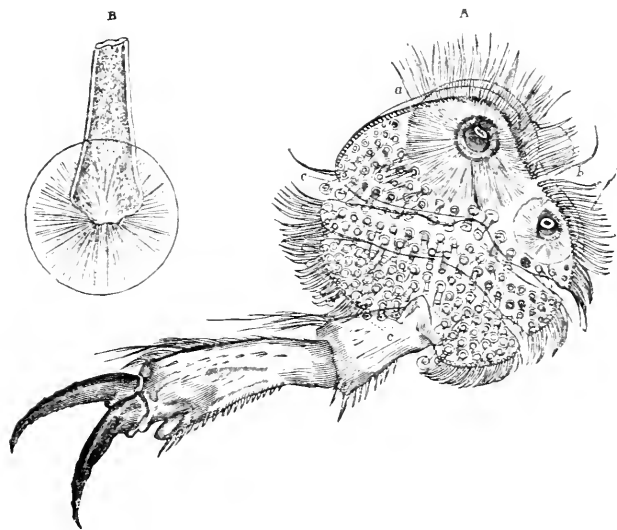

A, Foot of *Dytiscus*, showing its apparatus of Suckers ; *a*, *b*, large Suckers ; *c*, ordinary Suckers :—B, one of the ordinary Suckers more highly magnified.

are widely expanded, so as to form a nearly-circular plate ; and this is provided with a very remarkable apparatus of Suckers, of

* See Mr. Hepworth's communications to the "Quart. Journ. of Microsc. Science," Vol. ii. (1854), p. 158, and Vol. iii. 1855, p. 312. See also Mr. Tuffen West's Memoir 'On the Foot of the Fly,' in "Transact. of Linn. Society," Vol. xxii., p. 393.

which one disk (*a*) is extremely large, and is furnished with strong radiating fibres, a second (*b*) is a smaller one formed on the same plan (a third, of the like kind, being often present), whilst the greater number are comparatively-small tubular club-shaped bodies, each having a very delicate membranous Sucker at its extremity, as seen on a larger scale at *b*. These last seem to resemble the Hairs of the Fly's foot in every particular but dimension; and an intermediate size is presented by the Hairs of many Beetles, especially *Curculionidæ*. The Leg and Foot of the Dytiscus, if mounted without compression, furnish a peculiarly beautiful object for the Binocular Microscope.—The Feet of Caterpillars differ considerably from those of perfect Insects. Those of the first three segments, which are afterwards to be replaced by true-Legs, are furnished with strong horny claws; but each of those of the other segments which are termed 'Pro-Legs,' is composed of a circular series of comparatively-slender curved hooklets, by which the Caterpillar is enabled to cling to the minute roughnesses of the surface of the leaves, &c., on which it feeds. This structure is well seen in the Pro-Legs of the common Silk-worm.

531. *Stings and Ovipositors*.—The Insects of the Order *Hymenoptera* are all distinguished by the prolongation of the last segment of the Abdomen into a peculiar organ, which, in one division of the order, is a 'Sting,' and in the other is an 'Ovipositor,'—an instrument for the deposition of the eggs, which is usually also provided with the means of boring a hole for their reception. The former group consists of the Bees, Wasps, Ants, &c.; the latter of the Saw-flies, Gall-flies, Ichneumon-flies, &c. These two sets of instruments are not so unlike in structure, as they are in function.—The 'Sting' is usually formed of a pair of Darts, beset with barbed teeth at their points, and furnished at their roots with powerful muscles, whereby they can be caused to project from their Sheath, which is a horny case formed by the prolongation of the integument of the last segment, slit into two halves, which separate to allow the protrusion of the sting; whilst the peculiar 'Venom' of the sting is due to the ejection, by the same muscular action, of a poisonous liquid, from a bag situated near the root of the sting, which passes down a canal excavated between the darts, so as to be inserted into the puncture which they make. The Stings of the common Bee, Wasp, and Hornet, may all be made to display this structure without much difficulty in the dissection.—The 'Ovipositor' of such Insects as deposit their eggs in holes ready-made, or in soft animal or vegetable substances (as is the case with the *Ichneumonidæ*), is simply a long tube, which is enclosed, like the sting, in a cleft sheath. In the Gall-flies (*Cynipidæ*), the extremity of the Ovipositor has a toothed edge, so as to act as a kind of saw whereby harder substances may be penetrated; and thus an aperture is made in the leaf, stalk, or bud of the Plant or Tree infested by the particular species, in which the egg is deposited, together with

a drop of fluid that has a peculiarly-irritating effect upon the Vegetable tissues, occasioning the production of the 'Galls,' which are new growths that serve not only to protect the larvæ, but also to afford them nutriment. The Oak is infested by several species of these Insects, which deposit their eggs in different parts of its fabric; and some of the small 'Galls' which are often found upon the surface of Oak-leaves, are extremely beautiful objects for the lower powers of the Microscope. It is in the *Tenthredinidæ*, or Saw-flies, and in their allies the *Siricidæ*, that the Ovipositor is furnished with the most powerful apparatus for penetration; and some of these Insects can bore by its means into hard timber. Their 'Saws' are not unlike the 'Stings' of Bees, &c., but are broader, are toothed for a greater length, and are made to slide along a firm piece that supports each blade, like the 'back' of a Carpenter's 'tenon-saw;' they are worked alternately (one being protruded while the other is drawn back) with great rapidity; and when the perforation has been made, the two blades are separated enough to allow the passage of the eggs between them.—Many other Insects, especially of the order *Diptera*, have very prolonged Ovipositors, by means of which they can insert their eggs into the Integuments of Animals, or into other situations in which the Larvæ will obtain appropriate nutriment; a remarkable example of this is furnished by the Gad-fly (*Tabanus*), whose Ovipositor is composed of several joints, capable of being drawn-together or extended like those of a Telescope, and is terminated by boring instruments; and the egg being conveyed by its means, not only *into* but *through* the integument of the Ox, so as to be imbedded in the tissue beneath, a peculiar kind of inflammation is set-up there, which (as in the analogous case of the Gall-fly) forms a nidus appropriate both to the protection and to the nutrition of the Larva. Other Insects which deposit their eggs in the ground, such as the *Locusts*, have their Ovipositors so shaped as to answer for digging holes for their reception.—The preparations which serve to display the foregoing parts, are best seen when mounted in Balsam; save in the case of the Muscles and Poison-apparatus of the Sting, which are better preserved in Fluid or in Medium.

532. The Sexual organs of Insects furnish numerous objects of extreme interest to the Anatomist and Physiologist; but as an account of them would be unsuitable to the present work, a reference to a copious source of information respecting one of their most curious features, and to a list of the Species that afford good illustrations, must here suffice.* The *Eggs* of many Insects are objects

* See the Memoirs of M. Lacaze-Duthiers 'Sur l'armure genitale des Insectes,' in "Ann. des Sci. Nat." Sér. 3, Zool., Tomes xii., xiv., xvii., xviii., xix.; and M. Ch. Robin's "Memoir sur les Objets qui peuvent être conservés en Préparations Microscopiques" (Paris, 1856), which is peculiarly full in the enumeration of the objects of interest afforded by the Class of Insects.

of great beauty, on account of the regularity of their form, and the symmetry of the markings on their surface (Fig. 352). The most

FIG. 352.

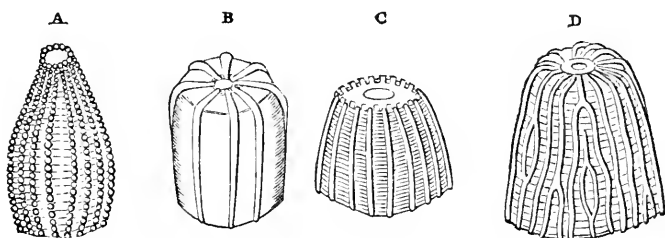

Eggs of Insects, magnified :—A, *Pontia napi*; B, *Vanessa urticae*; C, *Hipparchia janira*; D, *Argynnis Lathonia*.

interesting belong for the most part to the Order *Lepidoptera*; and there are few among these that are not worth examination, some of the commonest (such as those of the Cabbage-Butterfly, which are found covering large patches of the leaves of that plant) being as remarkable as any. Those of the Puss-moth (*Cerura vinula*), the Privet Hawk-moth (*Sphinx ligustri*), the small Tortoise-shell Butterfly (*Vanessa urticae*), the Meadow-brown Butterfly (*Hipparchia janira*), the Brimstone-moth (*Rumia crategata*), and the Silk-worm (*Bombyx mori*), may be particularly specified; and from other orders, those of the Cockroach (*Blatta orientalis*), Field Cricket (*Acheta campestris*), Water-Scorpion (*Nepa ranatra*), Bug (*Cimex lectularius*), Cow-dung-fly (*Scatophaga stercoraria*), and Blow-fly (*Musca vomitoria*). In order to preserve these Eggs, they should be mounted in fluid in a cell; since they will otherwise dry up and may lose their shape.—They are very good objects for the ‘conversion of relief’ effected by Nacht’s Stereo-Pseudoscopic Microscope (§ 29).

533. The remarkable mode of Reproduction that exists among the *Aphides* must not pass unnoticed here, from its curious connection with the Non-Sexual reproduction of *Entomostraca* (§ 502) and *Rotifera* (§ 361), as also of *Hydra* (§ 411) and *Zoophytes* generally, all of which fall specially, most of them exclusively, under the observation of the Microscopist. The *Aphides*, which may be seen in the spring and early summer, and which are commonly but not always wingless, are all of one Sex, and give birth to a brood of similar *Aphides*, which come into the world alive, and before long go through a like process of multiplication. As many as from seven to ten successive broods may thus be produced in the course of a single season; so that from a single *Aphis*, it has been calculated that no fewer than ten thousand million millions may be evolved within that period. In the latter

part of the year, however, some of these Viviparous Aphides attain their full development into Males and Females; and these perform the true Generative process, whose products are Eggs, which, when hatched in the succeeding spring, give origin to a new Viviparous brood that repeat the curious life-history of their predecessors. It appears from the observations of Prof. Huxley,* that the broods of Viviparous Aphides originate in *ova* which are not to be distinguished from those deposited by the perfect winged Female. Nevertheless, this Non-Sexual or *agamie* Reproduction must be considered analogous rather to the 'Gemmation' of other Animals and Plants, than to their Sexual 'Generation;' for it is favoured, like the gemmation of *Hydra* (§ 411), by warmth and copious sustenance, so that by appropriate treatment the Viviparous reproduction may be caused to continue (as it would seem) indefinitely, without any recurrence to the Sexual process. Recent observations render it probable that this mode of Reproduction is not at all peculiar to the Aphides, but that many other Insects ordinarily multiply by 'Agamic' propagation, the production of males and the performance of the true Generative act being only occasional phenomena; and the researches of Prof. Siebold have led him to conclude that even in the ordinary economy of the Hive-Bee the same double mode of reproduction occurs. The Queen, who is the only perfect Female in the hive, after impregnation by one of the Drones (or Males), deposits eggs in the 'Royal' cells, which are in due time developed into young Queens; others in the Drone-cells, which become Drones; and others in the ordinary cells, which become Workers or Neuters. It has long been known that these last are really undeveloped Females, which, under certain conditions, might become Queens; and it has been observed by bee-keepers that Worker-bees, in common with virgin or unimpregnated Queens, occasionally lay eggs, from which eggs none but Drones are ever produced. From careful Microscopic examination of the Drone eggs laid even by impregnated Queens, Siebold draws the conclusion that they have not received the fertilizing influence of the Male fluid, which is communicated to the Queen-eggs and Worker eggs alone; so that the products of Sexual generation are always Females, the Males being developed from these by a process which is essentially one of Gemmation.†

534. ARACHNIDA.—The general remarks which have been made in regard to Insects, are equally applicable to this Class; which includes, along with the *Spiders* and *Scorpions*, the tribe of *Acarida*, which consists of the *Mites* and *Ticks*. Many of these are Parasitic, and are popularly associated with the wingless parasitic Insects, to which they bear a strong general resemblance,

* 'On the Agamic Reproduction and Morphology of Aphis,' in "Transact. of Linn. Soc.," Vol. xxii., p. 193.

† See Prof. Siebold's Memoir "On true Parthenogenesis in Moths and Bees," translated by W. S. Dallas; London, 1857.

save in having *eight* legs instead of *six*. The true 'Mites' (*Acarinæ*) generally have the legs adapted for walking, and some of them are of active habits. The common *Cheese-Mite*, as seen by the naked eye, is familiar to every one; yet few who have not seen it under a Microscope have any idea of its real conformation and movements; and a cluster of them, cut out of the cheese they infest, and placed under a magnifying power sufficiently low to enable a large number to be seen at once, is one of the most amusing objects that can be shown to the young. There are many other species, which closely resemble the Cheese-Mite in structure and habits, but which feed upon different substances; and some of these are extremely destructive. To this group belongs a small species, the *Sarcoptes scabiei*, whose presence appears to be the occasion of one of the most disgusting diseases of the skin—the Itch,—and which is hence commonly termed the 'Itch-Insect.' It is not found in the pustule itself, but in a burrow which passes-off from one side of it, and which is marked by a red line on the surface; and if this burrow be carefully examined, the creature will very commonly, but not always, be met-with. It is scarcely visible to the naked eye; but when examined under the microscope, it is found to have an oval body, a mouth of conical form, and eight feet, of which the four anterior are terminated by small suckers, whilst the four posterior end in very prolonged bristles. The male is only about half the size of the female. The *Ricinæ* or 'Ticks' are usually destitute of Eyes, but have the Mouth provided with Lancets, that enable them to penetrate more readily the Skins of Animals whose blood they suck. They are usually of a flattened, round, or oval form; but they often acquire a very large size by suction, and become distended like a blown bladder. Different species are parasitic upon different animals; and they bury their suckers (which are often furnished with minute recurved hooks) so firmly in the skins of these, that they can hardly be detached without pulling away the skin with them. It is probably the young of a species of this group, which is commonly known as the 'Harvest-bug,' and which is usually designated as the *Acarus autumnalis*; this is very common in the autumn upon grass or other herbage, and insinuates itself into the skin at the roots of the hair, producing a painful irritation; like other Acarida, for some time after its emersion from the egg it possesses only six legs (the other pair being only acquired after the first moult), so that its resemblance to Parasitic Insects becomes still stronger.—It is probable that to this group also belongs the *Demodex folliculorum*, a creature which is very commonly found parasitic in the Sebaceous Follicles of the Human Skin, especially in those of the Nose. In order to obtain it, pressure should be made upon any one of these that appears enlarged and whitish with a terminal black spot; the matter forced-out will consist principally of the accumulated Sebaceous secretion, having the Parasites with their eggs and young

mingled with it. These are to be separated by the addition of Oil, which will probably soften the Sebaceous matter sufficiently to set free the Animals, which may be then removed with a pointed brush; but if this mode should not be effectual, the Fatty matter may be dissolved-away by digestion in a mixture of Alcohol and Ether. The pustules in the skin of a Dog affected with the 'Mange' have been found by Mr. Topping to contain a Demodex, which seems only to differ from that of the Human Sebaceous follicles in its somewhat smaller size; and M. Gruby is said to have given to a Dog a disease resembling the Mange, if not identical with it, by inoculating it with the Human Parasite.—The *Acarida* are best preserved as Microscopic objects, by mounting in one or other of the 'Media' described in § 163.

535. The number of objects of general interest furnished to the Microscopist by the *Spider* tribe, is by no means considerable. Their Eyes exhibit a condition intermediate between that of Insects and Crustaceans, and that of Vertebrata; for they are single, like the 'Stemmata' of the former (§ 516), usually number from six to eight, are sometimes clustered-together in one mass, but are sometimes disposed separately; while they present a decided approach in internal structure to the type characteristic of the visual organs of the latter.—The structure of the Mouth is always mandibulate, and is less complicated than that of the Mandibulate Insects.—The Respiratory apparatus, which, where developed at all among the *Acarida*, is Tracheary like that of Insects, is here constructed upon a very different plan; for the 'Stigmata,' which are usually four in number on each side, open into a like number of Respiratory Sacculi, each of which contains a series of leaf-like folds of its lining membrane, upon which the Blood is distributed so as to afford a large surface to the air. In the structure of the Limbs, the principal point worthy of notice is the peculiar appendage with which they usually terminate; for the strong Claws, with a pair of which the last joint of the Foot is furnished, have their edges cut into comb-like Teeth (Fig. 353), which seem to be used by the animal as cleansing-instruments.

536. One of the most curious parts of the organization of the Spiders, is the 'Spinning-Apparatus' by means of which they fabricate their elaborately constructed webs. This consists of the 'Spinnerets,' and of the Glandular organs in which the fluid that hardens into the thread is elaborated. The usual number of the Spinnerets, which are situated at the posterior extremity of the body, is six; they are little teat-like prominences, beset with hairy appendages; and it is through a certain set of these appendages, which are tubular and terminate in fine-drawn points, that the glutinous secretion is forced-out in a multitude of streams of extreme minuteness. These streams harden into fibrils immediately on coming into contact with the air; and the fibrils proceeding from all the apertures of each Spinneret coalesce into a

single thread. It is doubtful, however, whether all the Spinnerets are in action at once, or whether those of different pairs may not

FIG. 353.

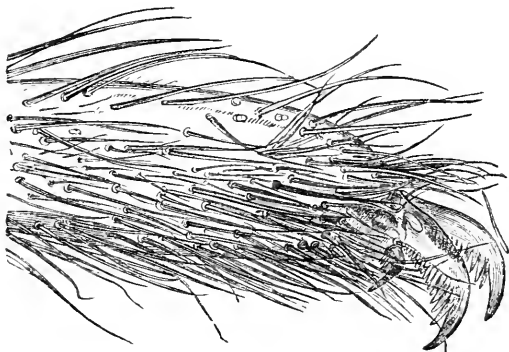

Foot, with comb-like claws of the common *Spider* (*Epeira*).

have dissimilar functions; for whilst the radiating threads of a Spider's Web are simple (Fig. 354, A), those which lie across these, forming its concentric circles, or rather polygons, are studded at intervals with viscid globules (B), which appear to give to these threads their peculiarly adhesive character;

and it does not seem by any means unlikely that each kind of Thread should be produced by its own pair of Spinnerets. It has

FIG. 354.



Ordinary thread (A), and viscid thread (B), of the common *Spider*.

been observed by Mr. R. Beck, that these viscid threads are of uniform thickness when first spun; but that undulations soon appear in them, and that the viscid matter then accumulates in globules at regular intervals.—The total number of Spinning-tubes varies greatly, according to the Species of the Spider, and the Sex and Age of the individual; being more than 1000 in some cases, and less than 100 in others. The size and complexity of the Secreting Glandulæ vary in like manner: thus in the Spiders which are most remarkable for the large dimensions and regular construction of their Webs, they occupy a large portion of the Abdominal cavity, and are composed of slender branching Tubes, whose length is increased by numerous Convolutions; whilst in those which have only occasional use for their threads, the Secreting organs are either short and simple Follicles, or are undivided Tubes of moderate length.

CHAPTER XVIII.

VERTEBRATED ANIMALS.

537. WE are now arrived at the highest division of the Animal Kingdom, in which the bodily fabric attains its greatest development, not only as to completeness, but also as to size; and it is in most striking contrast with the Class we have been last considering. Since not only the entire bodies of Vertebrated animals, but, generally speaking, the smallest of their integral parts, are far too large to be viewed as Microscopic objects, we can study their structure only by a separate examination of their component elements; and it seems, therefore, to be a most appropriate course to give under this head a sketch of the microscopic characters of those *Primary Tissues* of which their fabric is made-up, and which, although they may be traced with more or less distinctness in the lower tribes of Animals, attain their most complete development in this group.—Since the time when Schwann first made public the remarkable results of his researches, it has been very generally believed that all the Animal tissues are formed, like those of Plants, by a metamorphosis of *Cells*; an exception being taken, however, by some Physiologists in regard to the Simple Fibrous tissues (§ 558). The tendency of many recent investigations, however, has been to throw further doubt on the generality of this doctrine; and an attempt will now be made to show, that, whilst the *Vegetable* Physiologist may rightly treat the most highly organized Plant as a mere aggregation of *Cells*, analogous in all essential particulars to those which singly constitute the *Unicellular Protophytes* (§ 183), the *Animal* Physiologist does wrong in seeking a like cellular origin for the component parts of the Animal fabric; but that he may best interpret the phenomena of Tissue formation in the most complicated Organisms, by the study of the behaviour of that apparently-homogeneous substance of which the simplest *Protozoa* are made up.

538. Although there would at first sight appear but little in common between the simple body of those humble *Rhizopods* which constitute the lowest types of the Animal series (§ 325), and the

complex fabric of Man or other Vertebrates, yet it appears from recent researches that in the latter, as in the former, the process of Formation is essentially carried on by the instrumentality of *protoplasmic substance*, universally diffused through it in such a manner as to bear a close resemblance to the pseudopodial network of the Rhizopod (Fig. 232); whilst the *Tissues* produced by its agency lie, as it were, on the outside of this, bearing the same kind of relation to it as the Foraminiferal Shell (Fig. 248) does to the Sarcodic substance which fills its cavities and extends itself over its surface. For it appears that the smallest living 'elementary part' of every Organized fabric is composed of Organic matter in two states; the one, which may be termed *germinal matter*, possessing the power of selecting pabulum from the Blood, and of transforming this either into the material of its own extension, or into some product which it elaborates; whilst the other, which may be termed *formed material*, may present every gradation of character from a mere Inorganic deposit to a highly Organized structure, but is in every case altogether incapable of self-increase. A very definite line of demarcation can be generally drawn between these two substances by the careful use of the Staining-process (§ 145); but there are many instances in which there is the same gradation between the one and the other, as we have formerly noticed between the 'Endosarc' and the 'Ectosarc' of the *Amœba* (§ 331).—Thus it is on the 'germinal matter' that the existence of every form of Animal organization essentially depends; since it serves as the instrument by which the nutrient material furnished by the Blood is converted into the several forms of Tissue. Like the Sarcod substance of the Rhizopods, it seems capable of indefinite extension; and it may divide and subdivide into independent portions, each of which may act as the instrument of formation of an 'elementary part.' Two principal forms of such elementary parts present themselves in the fabric of the higher Animals,—namely, *Cells* and *Fibres*; and it will be desirable to give a brief notice of these, before proceeding to describe these more complex Tissues which are the products of a higher elaboration.*

* The doctrine here stated is that to which the Author has been led by the comparison of the results of the recent inquiries of several British and Continental Histologists, especially Prof. Beale and Prof. Max. Schultze, with those of his own study of the Rhizopod and Echinoderm types. Prof. Beale's views are most systematically expounded in his lectures "On the Structure of the simple Tissues of the Human Body," 1861; in his "How to work with the Microscope," 4th Edition, 1868; and in the Introductory portion of his new Edition of "Todd and Bowman's Physiological Anatomy," 1867. The principal results of the inquiries of German Histologists on this point are well stated in a Paper by Dr. Duffin on 'Protoplasm, and the part it plays in the actions of Living Beings,' in "Quart. Journ. of Microsc. Science," Vol. iii., N.S. (1863), p. 251.—The Author feels it necessary, however, to express his dissent from Prof. Beale's views in one important particular,—viz., his denial of Vital endowments to the 'formed material' of any of the Tissues. On this point, however, as on the general relations between the differentiated

539. The *Cells* of which many Animal-tissues are essentially composed, consist, when fully and completely formed, of the same parts as the typical Cell of the Plant (§ 182);—viz., a definite ‘cell-wall,’ enclosing ‘cell-contents’ (of which the nature may be very diverse), and also including a ‘nucleus,’ which is the seat of its formative activity. It is of such Cells, retaining more or less of their characteristic spheroidal shape, that every mass of *Fat*, whether large or small, is chiefly made up (§ 564). And the internal cavities of the body are lined by a layer of *Epithelium Cells* (§ 563), which, although of flattened form, present the like combination of components. But there is a large number of cases in which the Cell shows itself in a form of much less complete development; the ‘elementary part’ being a corpuscle of protoplasm or ‘germinal matter,’ of which the exterior has undergone a slight consolidation, like that which constitutes the ‘primordial utricle’ of the Vegetable Cell (§ 183) or the ‘ectosarc’ of the *Amœba* (§ 331), but in which there is no proper distinction of ‘cell-wall,’ ‘cell-contents,’ or nucleus. This condition, which is characteristically exhibited by the nearly-globular *Colourless Corpuscles* of the Blood (§ 556), appears to be common to all Cells in the incipient stage of their formation; and the progress of their development consists in the gradual *differentiation* of their parts, the ‘cell-wall’ and ‘cell-contents’ being separated (as ‘formed material’) from the ‘germinal-matter,’ which last usually remains as the ‘nucleus,’—generally, however, contracting, and sometimes (when its work has been completely done) disappearing altogether. The large flattened *Red Corpuscles* of the Blood of the Frog and other Oviparous Vertebrata (§ 555) appear to be generated from the Colourless by the production of a layer of the ‘formed material’ chemically known as Hæmatoglobulin around the original protoplasmic particles. For Corpuscles are met with, which seem to constitute an intermediate stage between the two kinds; their form being still globular, but their size being greater than that of the Colourless corpuscles; whilst their peripheral portion shows a distinct layer of ‘formed material,’ which is beginning to assume the characteristic hue of the Red disk, but which is not tinged by the Carmine-solution that deeply dyes the central or nuclear portion. This ‘formed material,’ however, does not seem ever to acquire a distinct membranous envelope or cell-wall; the changes of shape which the Red Corpuscles spontaneously undergo under favourable circumstances, being such as could scarcely occur if their form were thus limited. In Cartilage (§ 565), on the other hand, the ‘nucleus’ and the ‘cell-contents’ are completely differentiated from the ‘cell-wall;’ but the ‘cell-wall’ itself cannot be separated from the ‘intercellular sub-

or specialized Tissues of the higher Animals, and the undifferentiated Sarcod substance which alone represents those in the lowest, he has explained himself more fully in the Fourth Edition (1865) of his “Manual of Physiology.”

stance' which usually constitutes the principal portion of this tissue in its mature condition. And it would appear from the history of its development (which has been carefully studied by Dr. Beale), that the 'intercellular substance,' 'cell-wall,' and 'cell-contents,' are all to be regarded in the light of layers of 'formed material,' successively exuded from the corpuscle of 'germinal matter' wherein the cell originated, a portion of which remains as the 'nucleus.'

540. A large part of the fabric of the higher Animals, however, is made up of *Fibrous Tissues*, which serve to bind together the other components, and which, when consolidated by Calcareous deposit, constitute the substance of the Skeleton. In these, the relation of the 'germinal matter' and the 'formed material' presents itself under an aspect which seems at first sight very different from that just described. A careful examination, however, of those 'Connective-tissue-corpuscles' (Fig. 377) that have long been distinguished in the midst of the Fibres of which these tissues are made up, shows that they are the equivalents of the corpuscles of 'germinal matter' which in the previous instance came to constitute cell-nuclei; and that the fibres hold the same relation to them, that the 'walls' and 'contents' of Cells do to their germinal corpuscles. The transition from the one type to the other is well seen in Fibro-Cartilage, in which the so-called 'intercellular substance' is often as fibrous as a Tendon. The difference between the two types, in fact, seems essentially to consist in this,—that, whilst the segments of 'germinal matter' which form the cell-nuclei in Cartilage (Fig. 385) and in other Cellular Tissues, are completely isolated from each other, each being completely surrounded by the product of its own elaborating action, those which form the 'Connective-tissue-corpuscles' are connected together by radiating prolongations (Fig. 377) that pass between the fibres, so as to form a continuous network, closely resembling that formed by the pseudopodia of the Rhizopod (§ 326). Of this we have a most beautiful example in *Bone*; for whilst its solid substance may be considered as Connective Tissue solidified by Calcareous deposit, the 'lacunæ' and 'canaliculi' which are excavated in this (Fig. 356) give lodgment to a set of radiating corpuscles closely resembling those just described; and these are centres of 'germinal matter,' which appear to have an active share in the formation and subsequent nutrition of the Osseous texture. In Dentine (or Tooth-substance) we seem to have another form of the same thing; the walls of its 'tubuli' and the 'intertubular substance' (§ 545) being the 'formed material' that is produced from thread-like prolongations of 'germinal matters' issuing from its pulp, and continuing during the life of the Tooth to occupy its tubes; just as in the *Foraminifera* we have seen a minutely-tubular structure to be formed by a process of exudation around the individual threads of sarcode which proceeded from the body of the contained Animal (Figs. 248, 258).—Although there still remains much to be made out, in order to give

completeness to the doctrine which has been thus sketched, it may be stated with considerable confidence that the tendency of all recent inquiry has been to show, that the bodies of even the highest Animals are everywhere penetrated by that Sarcodic substance of which those of the lowest and simplest are entirely composed ; and that this substance, which forms a continuous network through almost every portion of the fabric, is the instrument of the Formation and Nutrition of the more specialized Tissues.

541. As it is the purpose of this work, not to instruct the Professional Student in Histology (or the Science of the Tissues),* but to supply Scientific information of general interest to the ordinary Microscopist, no attempt will here be made to do more than describe the most important of those distinctive characters, which the principal Tissues present when subjected to Microscopic examination; and as it is of no essential consequence what order is adopted, we may conveniently begin with the structure of the *Skeleton*,† which gives support and protection to the softer parts of the fabric.

542. *Bone*.—The Microscopic characters of Osseous tissue may sometimes be seen in a very thin natural plate of Bone, such as in that forming the Scapula (shoulder-blade) of a Mouse ; but they are displayed more perfectly by artificial Sections, the details of the arrangement being dependent upon the nature of the specimen selected, and the direction in which the section is made. Thus when the shaft of a 'long' Bone of a Bird or Mammal is cut-across in the middle of its length, we find it to consist of a hollow cylinder of dense bone, surrounding a cavity which is occupied by an oily marrow ; but if the section be made nearer its extremity, we find the outside wall gradually becoming thinner, whilst the interior, instead of forming one large cavity, is divided into a vast number of small chambers or *cancelli*, which communicate with each other and with the cavity of the shaft, and are filled, like it, with marrow. In the Bones of Reptiles and Fishes, on the other hand, this 'cancellated' structure usually extends throughout the shaft, which is not so completely differentiated into solid Bone and Medullary cavity as it is in the higher Vertebrata. In the most developed kinds of 'flat' Bones, again, such as those of the head, we find the two surfaces to be composed of dense plates of bone, with a 'cancellated' structure between them ; whilst in the less

* For more detailed information, the student may be specially referred to Messrs. Todd and Bowman's "Physiological Anatomy," Dr. Sharpey's Introduction to "Quain's Anatomy," (4th Edit., 1867), Prof. Kölliker's "Manual of Human Histology," Prof. Virchow's "Cellular Pathology," translated by Dr. Chance, and an important Review of the Cell-Theory, by Prof. Huxley, in the "Brit. and For. Med.-Chir. Review," Vol. xii. (Oct. 1853), p. 285.

† This term is used in its most general sense, as including not only the proper *Vertebral* or internal skeleton, but also the hard parts protecting the exterior of the body, which form the *Dermal* skeleton.

perfect type presented to us in the lower Vertebrata, the whole thickness is usually more or less 'cancellated,' that is, burrowed out by medullary cavities. When we examine, under a low magnifying power, a *longitudinal* section of a long Bone, or a section of a flat Bone *parallel* to its surface, we find it traversed by numerous canals, termed *Haversian* after their discoverer Havers, which are in connection with the central cavity, and are filled, like it, with marrow: in the shafts of long bones these canals usually run in the direction of their length, but are connected here and there by cross branches; whilst in the flat bones they form an irregular network.—On applying a higher magnifying power to a thin *transverse* section of a long Bone, we observe that each of the canals whose orifices present themselves in the field of view (Fig. 355), is the centre of a rod of bony tissue (1), usually more or less

FIG. 355.

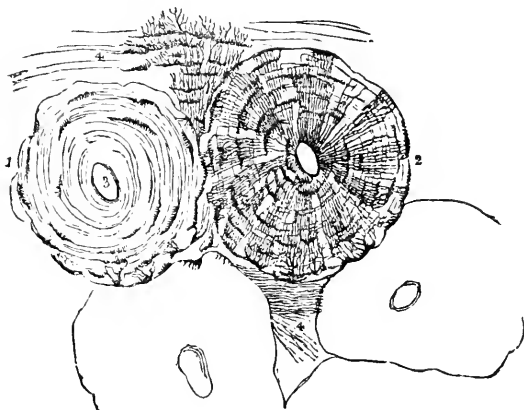

Minute structure of *Bone*, as seen in transverse section:—1, a rod surrounding an Haversian canal, 3, showing the concentric arrangement of the lamellæ; 2, the same, with the lacunæ and canaliculi; 4, portions of the lamellæ parallel with the external surface.

circular in its form, which is arranged around it in concentric rings, resembling those of an Exogenous Stem. These rings are marked out and divided by circles of little dark spots; which, when closely examined (2), are seen to be minute flattened cavities excavated in the solid substance of the bone, from the two flat sides of which pass-forth a number of extremely minute tubules, one set extending inwards, or in the direction of the centre of the system of rings, and the other outwards, or in the direction of its circumference; and by the inosculation of the tubules (which are termed

canaliculi) of the different rings with each other, a continuous communication is established between the central Haversian canal and the outermost part of the bony rod that surrounds it, which doubtless ministers to the nutrition of the texture. Blood-vessels are traceable into the Haversian canals, but the 'canaliculi' are far too minute to carry Blood-corpuscles; they are occupied, however, in the living Bone, by threads of sarcodic substance, which bring into communication with the walls of the Blood-vessels the segments of 'germinal matter' contained in the Lacunæ.

543. The minute cavities, or *Lacunæ* (sometimes, but erroneously termed 'bone-corpuscles,' as if they were solid bodies), from which the canaliculi proceed (Fig. 356), are highly characteristic of the true Osseous structure; being never deficient in the minutest parts of the bones of the higher Vertebrata, although those of Fishes are occasionally destitute of them. The dark appearance which they present in sections of a dried Bone is not due to opacity,

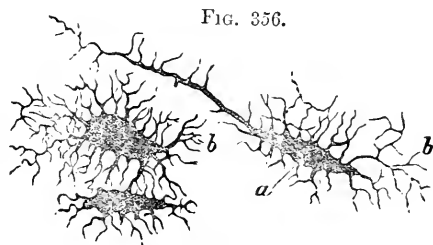

Lacunæ of Osseous substance :—*a*, central cavity ;
b, its ramifications.

but is simply an optical effect, dependent (like the blackness of air-bubbles in liquids) upon the dispersion of the rays by the highly-refracting substance that surrounds them (§ 128). The size and form of the *Lacunæ* differ considerably in the several Classes of Vertebrata, and even in some instances in the Orders; so as to allow of the determination of the tribe to which a bone belonged, by the Microscopic examination of even a minute fragment of it (§ 595). The following are the average dimensions of the *Lacunæ*, in characteristic examples drawn from the four principal Classes, expressed in fractions of an inch:—

	<i>Long Diameter.</i>	<i>Short Diameter.</i>
Man . . .	1-1440 to 1-2400	1-4000 to 1-8000
Ostrich . . .	1-1333 to 1-2250	1-5425 to 1-9650
Turtle . . .	1-375 to 1-1150	1-4500 to 1-5840
Conger-eel . . .	1-550 to 1-1135	1-4500 to 1-8000

The *Lacunæ* of *Birds* are thus distinguished from those of *Mammals* by their somewhat greater length and smaller breadth; but they differ still more in the remarkable tortuosity of their canaliculi, which wind backwards and forwards in a very irregular manner. There is an extraordinary increase in length in the *Lacunæ* of *Reptiles*, without a corresponding increase in breadth; and this is also seen in some *Fishes*, though in general the *Lacunæ* of the

latter are remarkable for their angularity of form and the fewness of their radiations,—as shown in Fig. 357, which represents the

FIG. 357.

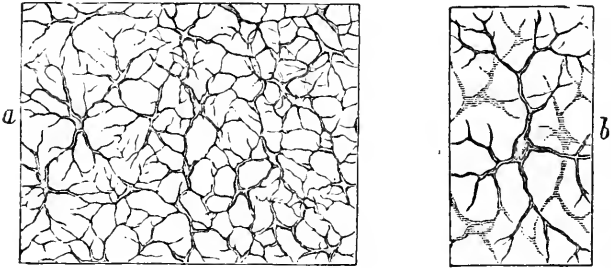

Section of the Bony Scale of *Lepidosteus*:—*a*, showing the regular distribution of the lacunæ and of the connecting canaliculi; *b*, small portion more highly magnified.

Lacunæ and Canaliculi in the bony Scale of the *Lepidosteus* ('bony pike' of the North American lakes and rivers), with which the bones of its internal skeleton perfectly agree in structure. The dimensions of the Lacunæ in any bone do not bear any relation to the size of the animal to which it belonged; thus there is little or no perceptible difference between their size in the enormous extinct *Iguanodon* and in the smallest Lizard now inhabiting the earth. But they bear a close relation to the size of the Blood-corpuscles in the several Classes; and this relation is particularly obvious in the 'perennibranchiate' Batrachia, the extraordinary size of whose blood-corpuscles will be presently noticed (§ 555):—

	<i>Long Diameter.</i>	<i>Short Diameter.</i>
Proteus . . .	1-570 to 1-980	1-885 to 1-1200
Siren . . .	1-290 to 1-480	1-540 to 1-975
Menopoma . . .	1-450 to 1-700	1-1300 to 1-2100
Lepidosiren . . .	1-375 to 1-494	1-980 to 1-2200
Pterodactyle . . .	1-445 to 1-1185	1-4000 to 1-5225*

544. In preparing Sections of Bone, it is important to avoid the penetration of the Canada balsam into the interior of the Lacunæ and Canaliculi; since, when these are filled by it, they become almost invisible. Hence it is preferable not to employ this cement at all, except it may be, in the first instance; but to rub-down the section beneath the finger, guarding its surface with a slice of Cork or a slip of Gutta-percha (§ 141); and to give it such a polish

* See Prof. J. Quekett's Memoir on this subject, in the "Transact. of the Microsc. Soc.," Ser. 1, Vol. ii.; and his more ample illustration of it in the "Illustrated Catalogue of the Histological Collection in the Museum of the Royal College of Surgeons," Vol. ii.

that it may be seen to advantage even when mounted dry. As the polishing, however, occupies much time, the benefit which is derived from covering the surfaces of the specimen with Canada balsam may be obtained, without the injury resulting from the penetration of the balsam into its interior, by adopting the following method:—a quantity of Balsam proportioned to the size of the specimen is to be spread upon a glass slip, and to be rendered stiffer by boiling, until it becomes nearly solid when cold; the same is to be done to the thin-glass-cover; next, the specimen being placed on the balsamed surface of the slide, and being overlaid by the balsamed cover, such a degree of warmth is to be applied as will suffice to liquefy the balsam without causing it to flow freely; and the glass cover is then to be quickly pressed-down, and the slide to be rapidly cooled, so as to give as little time as possible for the penetration of the liquefied balsam into the lacunar system.—The same method may be employed in making sections of Teeth.*—The study of the Organic basis of Bone (commonly, but erroneously, termed Cartilage) should be pursued by macerating a fresh Bone in dilute Nitro-Hydrochloric acid, then macerating it for some time in pure Water, and then tearing thin shreds from the residual substance, which will be found to consist of an imperfectly-fibrillated material, allied in its essential constitution to the White Fibrous tissue (§ 558).

545. *Teeth*.—The intimate structure of the Teeth in the several Classes and Orders of Vertebrata, presents differences which are no less remarkable than those of their external form, arrangement, and succession. It will obviously be impossible here to do more than sketch some of the most important of these varieties.—The principal part of the substance of all Teeth is made-up of a solid tissue that has been appropriately termed *Dentine*. In the Shark tribe, as in many other Fishes, the general structure of this Dentine is extremely analogous to that of Bone; the tooth being traversed by numerous canals, which are continuous with the Haversian canals of the subjacent bone, and receive blood-vessels from them (Fig. 358); and each of these canals being surrounded by a system of tubuli (Fig. 359), which radiate into the surrounding solid substance. These tubuli, however, do not enter lacunæ, nor is there any concentric annular arrangement around the medullary canals; but each system of tubuli is continued onwards through its own division of the tooth, the individual tubes sometimes giving-off lateral branches, whilst in other instances their trunks bifurcate. This arrangement is peculiarly well displayed, when sections of Teeth constructed upon this type are viewed as opaque objects (Fig. 360).—In the Teeth of the higher Vertebrata, however, we usually find the centre excavated into a single cavity (Fig. 361), and the remainder destitute of vascular canals; but there are intermediate

* Some useful hints on the mode of making these preparations will be found in the "Quart. Journ. of Microsc. Science," Vol. vii. (1859), p. 258.

cases (as in the teeth of the great fossil Sloths) in which the inner portion of the Dentine is traversed by prolongations of this cavity, conveying Blood-vessels, which do not pass into the exterior layers. The Tubuli of the 'non-vascular' Dentine, which exists by itself in the teeth of nearly all Mammalia, and which in the Elephant is

FIG. 358.

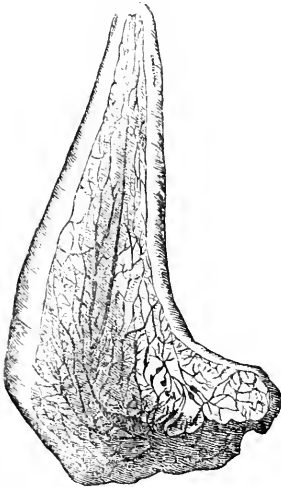

FIG. 359.

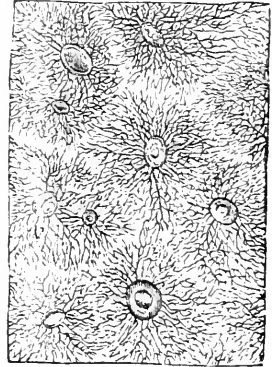

Fig. 358. Perpendicular section of Tooth of *Lamna*, moderately enlarged, showing network of Medullary Canals.

Fig. 359. Transverse section of portion of Tooth of *Pristis*, more highly magnified, showing orifices of Medullary Canals, with systems of radiating and inosculating Tubuli.

known as 'ivory,' all radiate from the central cavity, and pass towards the surface of the tooth in a nearly parallel course. Their diameter at their largest part averages 1-10,000th of an inch; their smallest branches are immeasurably fine. The Tubuli in their course present greater and lesser undulations; the former are few in number; but the latter are numerous, and as they occur at the same part of the course of several contiguous tubes, they give rise to the appearance of lines concentric with the centre of radiation. These 'secondary curvatures' probably indicate, in Dentine, as in the Crab's Shell (§ 507), successive stages of calcification.—The Tubuli are occupied, during the life of the Tooth, by delicate threads of protoplasmic substance, extending into them from the central pulp (§ 540).

546. In the Teeth of Man and most other Mammals, and in those of many Reptiles and some Fishes, we find two other substances, one of them harder, and the other softer, than Dentine; the former is termed *Enamel*; and the latter *Cementum* or *Crusta*

Petrosa.—The *Enamel* is composed of long prisms, closely resembling those of the Prismatic Shell-substance formerly described (§ 458), but on a

far more minute scale; the diameter of the prisms not being more, in Man, than 1-5600th of an inch. The length of the prisms corresponds with the thickness of the layer of Enamel; and the two surfaces of this layer present the ends of the prisms, the form of which usually approaches the hexagonal. The course of the Enamel - prisms is more or less wavy; and they are marked

FIG. 360.

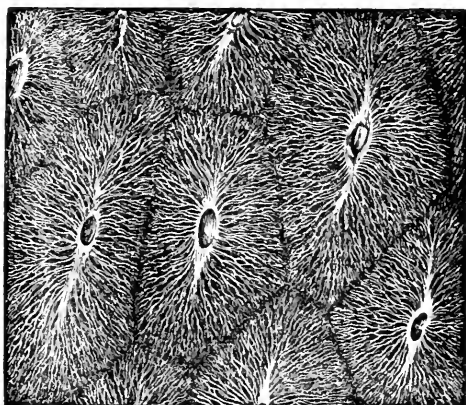

Transverse Section of Tooth of *Myliobates* (Eagle Ray) viewed as an opaque object.

by numerous transverse striae, resembling those of the prismatic Shell-substance (§ 458), and probably originating in the same cause,—the coalescence of a series of shorter prisms to form the lengthened prism. In Man and in Carnivorous animals the Enamel covers the crown of the tooth only, with a simple cap or superficial layer of tolerably uniform thickness (Fig. 361, a) which follows the surface of the dentine in all its inequalities; and its component prisms are directed at right angles to that surface, their inner extremities resting in slight but regular depressions on the exterior of the dentine. In the Teeth of many Herbivorous animals, however, the Enamel forms (with the Cementum) a series of vertical plates, which dip down into the substance of the Dentine, and present their edges alternately with it, at the grinding surface of the tooth; and there is in such teeth no continuous layer of enamel over the crown. The purpose of this arrangement is evidently to provide, by the unequal wear of these three substances,—of which the Enamel is the hardest, and the Cementum the softest,—for the constant maintenance of a rough surface, adapted to triturate the tough vegetable substances on which these animals feed. The Enamel is the least constant of the dental tissues. It is more frequently absent than present in the teeth of the Class of Fishes; it is wanting in the entire Order of Ophidia (serpents) among existing Reptiles; and it forms no part of the Edentata (sloths, &c.) and Cetacea (whales) amongst Mammals.—The *Cementum*, or *Crusta*

Petrosa, has the characters of true Bone ; possessing its distinctive stellate Lacunæ and radiating Canaliculi. Where it exists in small amount, we do not find it traversed by Medullary Canals ; but, like dentine, it is occasionally furnished with them, and thus resembles bone in every particular. These Medullary Canals enter its substance from the exterior of the Tooth, and consequently pass towards those which radiate from the central cavity in the direction of the surface of the Dentine, where this possesses a similar vascularity, — as was remarkably the case in the teeth of the extinct *Megatherium*. In the Human tooth, however, the Cementum has no such vascularity ; but forms a thin layer (Fig. 361, *b*), which envelops the root of the tooth, commencing near the termination of the capping of enamel. In the teeth of many Herbivorous Mammals, it dips down with the enamel to form the vertical plates of the interior of the tooth ; and in the teeth of the Edentata, as well as of many Reptiles and Fishes, it forms a thick continuous envelope over the whole surface, until worn-away at the crown.

547. *Dermal Skeleton*.—The Skin of Fishes, of most Reptiles, and of a few Mammals, is strengthened by plates of a Horny, Cartilaginous, Bony, or even Enamel-like texture ; which are sometimes fitted-together at their edges, so as to form a continuous box-like envelope ; whilst more commonly they are so arranged as partially to overlie one another, like the tiles on a roof ; and it is in this latter case that they are usually known as *Scales*. Although we are accustomed to associate in our minds the ‘Scales’ of Fishes with those of Reptiles, yet they are essentially-different structures ; the former being developed in the *substance* of the true Skin, with a layer of which in addition to the Epidermis they are always covered, and bearing a resemblance to Cartilage and Bone in their texture and composition ; whilst the latter are formed upon the *surface* of the true Skin, and are to be considered as analogous to Nails, Hoofs, &c., and other ‘Epidermic appendages.’ In nearly all the existing Fishes, the Scales are flexible, being but little con-

FIG. 361.

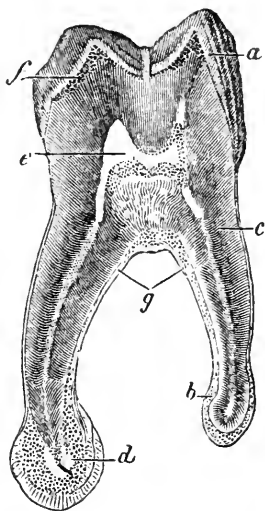

Vertical Section of *Human Molar Tooth* :—*a*, Enamel ; *b*, Cementum or crusta petrosa ; *c*, Dentine or ivory ; *d*, osseous excrescence, arising from hypertrophy of cementum ; *e*, pulp-cavity ; *f*, osseous lacunæ at outer part of Dentine.

solidated by calcareous deposit; and in some species they are so thin and transparent, that, as they do not project obliquely from the surface of the Skin, they can only be detected by raising the superficial layer of the skin, and searching beneath it, or by tearing-off the entire thickness of the skin, and looking for them near its under surface. This is the case, for example, with the common *Eel*, and with the *Viriparous Blenny*; of either of which fish the Skin is a very interesting object when dried and mounted in Canada balsam, the Scales being seen imbedded in its substance, whilst its outer surface is studded with pigment-cells. Generally speaking, however, the posterior extremity of each scale projects obliquely from the general surface, carrying before it the thin membrane that encloses it, which is studded with pigment-cells; and a portion of the skin of almost any Fish, but especially of such as have scales of the *Ctenoid* kind (that is, furnished at their posterior extremities with comb-like teeth, Fig. 363), when dried with its scales *in situ*, is a very beautiful opaque object for the low powers of the Microscope (Fig. 362), especially with the Binocular arrangement.

Care must be taken, however, that the light is made to glance upon it in the most advantageous manner; since the brilliance with which it is reflected from the comb-like projections entirely depends upon the angle at which it falls upon them. The

FIG. 362.

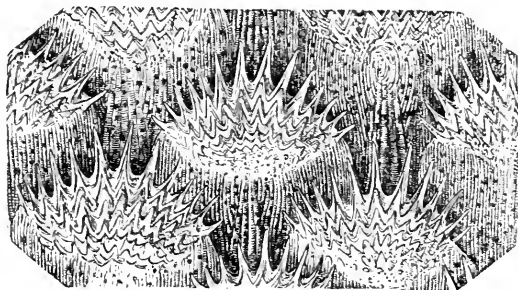
Portion of Skin of *Sole*, viewed as an opaque object.

only appearance of structure exhibited by the thin flat Scale of the *Eel*, when examined microscopically, is the presence of a layer of isolated spheroidal transparent bodies, imbedded in a plate of like transparency; these, from the researches of Prof. Williamson upon other scales, appear not to be Cells (as they might readily be supposed to be), but to be concretions of Carbonate of Lime. When the scale of the *Eel* is examined by Polarized light, its surface exhibits a beautiful St. Andrew's cross; and if a plate of Selenite be placed behind it, and the analyzing prism be made to revolve, a remarkable play of colours is presented.

548. In studying the structure of the more highly developed Scales, we may take as an illustration that of the *Carp*; in which two very distinct layers can be made-out by a vertical section,

with a third but incomplete layer interposed between them. The outer layer is composed of several concentric laminae of a structureless transparent substance, like that of Cartilage; the outermost of these laminae is the smallest, and the size of the plates increases progressively from without inwards, so that their margins appear on the surface as a series of concentric lines; and their surfaces are thrown into ridges and furrows, which commonly have a radiating direction. The inner layer is composed of numerous laminae of a fibrous structure, the fibres of each lamina being inclined at various angles to those of the lamina above and below it. Between these two layers is interposed a stratum of Calcareous concretions, resembling those of the scale of the Eel; these are sometimes globular or spheroidal, but more commonly 'lenticular,' that is, having the form of a double-convex lens. The Scales, which resemble those of the Carp in having a form more or less circular, and in being destitute of comb-like prolongations, are called *Cycloid*; and such are the characters of those of the Salmon, Herring, Roach, &c. The structure of the *Ctenoid* scales (Fig. 363),

FIG. 363.

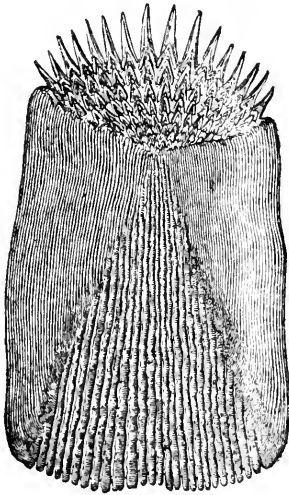

Scale of *Sole*, viewed as a transparent object.

which we find in the Sole, Perch, Pike, &c., does not differ essentially from that of the Cycloid, save as to the projection of the comb-like teeth from the posterior margin; and it does not appear that the strongly-marked division which Prof. Agassiz has attempted to establish between the 'cycloid' and the 'ctenoid' Orders of Fishes, on the basis of this difference, is in harmony with their general organization. Scales of either kind may become consolidated to a considerable extent by the calcification of their soft substance; but still they never present any approach to the true Bony structure, such as is shown in the two Orders to be next adverted-to.

549. In the *Ganoid* Scales, on the other hand, the whole substance of the scale is composed of a substance which is essentially Bony in its nature; its intimate structure being always comparable to that of one or other of the varieties which present themselves in the bones of the Vertebrate skeleton; and being very frequently identical with that of the Bones of the same fish, as is the case with the *Lepidosteus* (Fig. 357), one of the few existing representatives of this

Order, which, in former ages of the Earth's history, comprehended a large number of important families. Their name (from γανος, splendour) is bestowed on account of the smoothness, hardness, and high polish of the outer surface of the scales; which is due to the presence of a peculiar layer that has been likened (though erroneously) to the Enamel of teeth, and is now distinguished as *ganoin*. The Scales of this order are for the most part angular in their form; and are arranged in regular rows, the posterior edges of each slightly overlapping the anterior ones of the next, so as to form a very complete defensive armour to the body.—The Scales of the *Placoid* type, which characterizes the existing Sharks and Rays, with their Fossil analogues, are irregular in their shape, and very commonly do not come into mutual contact; but are separately imbedded in the skin, projecting from its surface under various forms. In the Rays each Scale usually consists of a flattened plate of a rounded shape, with a hard spine projecting from its centre; in the Sharks (to which tribe belongs the 'Dog-fish' of our own coast) the scales have more of the shape of teeth. This resemblance is not confined to external form; for their intimate structure strongly resembles that of Dentine, their dense substance being traversed by tubuli, which extend from their centre to their circumference in minute ramifications, without any trace of osseous Lacunæ. These tooth-like scales are often so small as to be invisible to the naked eye; but they are well seen by drying a piece of the skin to which they are attached, and mounting it in Canada balsam; and they are most brilliantly shown by the assistance of polarized light.—A like structure is found to exist in the Spiny-rays of the dorsal fin, which, also, are parts of the dermal skeleton; and these rays usually have a central cavity filled with medulla, from which the tubuli radiate towards the circumference. This structure is very well seen in thin sections of the Fossil spiny-rays, which, with the teeth and scales, are often the sole relics of the vast multitudes of Sharks that must have swarmed in the ancient seas, their cartilaginous internal skeletons having entirely decayed away.—In making sections of bony Scales, Spiny-rays, &c., the method must be followed which has been already detailed under the head of Bone (§ 544).*

550. The *Scales* of Reptiles, the *Feathers* of Birds, and the *Hairs*, *Hoofs*, *Nails*, *Claws*, and *Horns* (when not bony) of Mammals, are all *Epidermic* appendages; that is, they are produced upon the surface, not within the substance, of the True Skin, and are allied in structure to the Epidermis (§ 561); being essentially composed

* The structure of the Scales of Fishes has been most elaborately described by Prof. Williamson in his Memoirs 'On the Microscopic Structure of the Scales and Dermal Teeth of some Ganoid and Placoid Fish' in "Philos. Transact.," 1849, and 'Investigations into the Structure and Development of the Scales and Bones of Fishes' in "Philos. Transact.," 1851.

of aggregations of cells filled with horny matter, and frequently much altered in form. This structure may generally be made-out in Horns, Nails, &c., with little difficulty, by treating thin sections of them with a dilute solution of Soda; which after a short time causes the cells that had been flattened into scales, to resume their globular form. The most interesting modifications of this structure are presented to us in Hairs and in Feathers; which forms of clothing are very similar to each other in their essential nature, and are developed in the same manner,—namely, by an increased production of Epidermic cells at the bottom of a flask-shaped Follicle, which is formed in the substance of the True Skin, and which is supplied with abundance of blood by a special distribution of vessels to its walls. When a Hair is pulled-out 'by its root,' its base exhibits a bulbous enlargement, of which the exterior is tolerably firm, whilst its interior is occupied by a softer substance, which is known as the 'pulp;' and it is to the continual augmentation of this pulp in the deeper part of the follicle, and to its conversion into the peculiar substance of the hair when it has been pushed-upwards to its narrow neck, that the growth of the hair is due.—The same is true of Feathers, the stems of which are but hairs on a larger scale; for the 'quill' is the part contained within the follicle, answering to the 'bulb' of the hair; and whilst the outer part of this is converted into the peculiarly-solid horny substance forming the 'barrel' of the quill, its interior is occupied, during the whole period of the growth of the feather, with the soft pulp, only the shrivelled remains of which, however, are found within it after the quill has ceased to grow.

551. Although the *Hairs* of different Mammals differ greatly in the appearances they present, we may generally distinguish in them two elementary parts; namely, a *cortical* or investing substance, of a dense horny texture, and a *medullary* or pith-like substance, usually of a much softer texture, occupying the interior. The former can sometimes be distinctly made-out to consist of flattened scales arranged in an imbricated manner, as in some of the Hairs of the *Sable* (Fig. 364); whilst, in the same hairs, the Medullary substance is composed of large spheroidal cells. In the *Musk-deer*, on the other hand, the Cortical substance is nearly undistinguishable; and almost the entire hair seems made-up of thin-walled polygonal cells (Fig. 365). The Hair of the *Rein-deer*, though much larger, has a very similar structure; and its cells, except near the root, are occupied with air alone, so as to seem black by transmitted light, except when penetrated by the fluid in which they are mounted. In the Hair of the *Mouse*, *Squirrel*, and other small Rodents (Fig. 366, A, B), the Cortical substance forms a tube, which we see crossed at intervals by partitions that are sometimes complete, sometimes only partial; these are the walls of the single or double line of cells, of which the Medullary substance is made-up. The Hairs of the *Bat* tribe are commonly distin-

guished by the projections on their surface, which are formed by extensions of the component scales of the Cortical substance; these

FIG. 364.

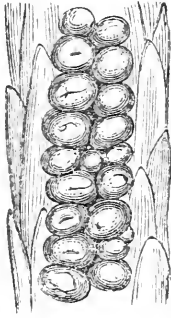

FIG. 365.

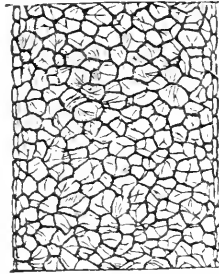

Fig. 364. Hair of *Sable*, showing large rounded cells in its interior, covered by imbricated scales or flattened cells.

Fig. 365. Hair of *Musk-deer*, consisting almost entirely of polygonal cells.

are particularly well seen in the hairs of one of the Indian species, which has a set of whorls of long narrow leaflets (so to speak)

arranged at regular intervals on its stem (c). In the Hair of the *Pecari* (Fig. 367), the Cortical envelope sends inwards a set of radial prolongations, the interspaces of which are occupied by the polygonal cells of the Medullary substance; and this, on a larger scale, is the structure of the 'quills' of the *Porcupine*; the radiating partitions of which, when seen through the more transparent parts of the Cortical sheath, give to the surface of the latter a fluted appearance. The Hair of the

FIG. 366.

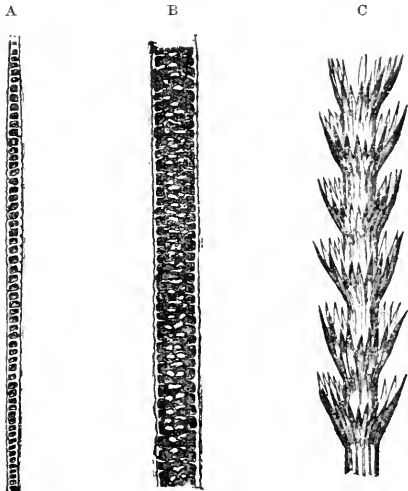

A, Small Hair of *Squirrel* :—B, Large Hair of *Squirrel* :—C, Hair of *Indian Bat*.

Ornithorhynchus is a very curious object; for whilst the lower part of it resembles the fine hair of the Mouse or Squirrel, this thins away and then dilates again into a very thick fibre, having a central portion composed of polygonal cells, enclosed in a flattened sheath of a brown fibrous substance.

FIG. 367.

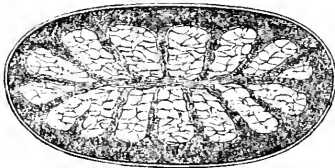
Transverse section of Hair of
Pecari.

552. The structure of the *Human Hair* is in certain respects peculiar. When its outer surface is examined, it is seen to be traversed by irregular lines (Fig. 368, A), which are most

strongly marked in foetal hairs; and these are the indications of the imbricated arrangement of the flattened cells or scales which form

FIG. 368.

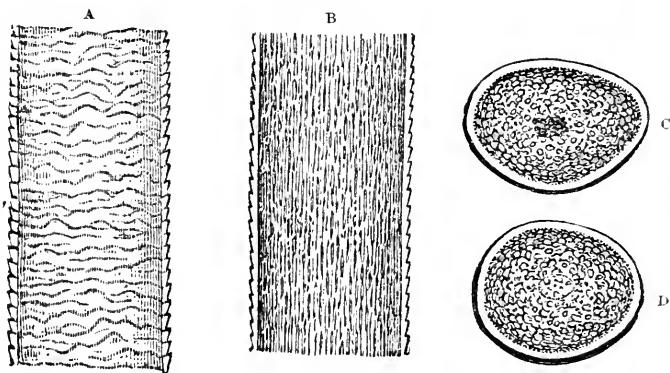

Structure of *Human Hair*:—A, external surface of the shaft, showing the transverse striae and jagged boundary caused by the imbrications of the Cortical substance; B, longitudinal section of the shaft, showing the fibrous character of the Medullary substance, and the arrangement of the pigmentary matter; C, transverse section, showing the distinction between the transparent envelope, the cylinder of medullary substance, and the cellular centre; D, another transverse section showing deficiency of the central cellular substance.

the Cortical layer. This layer, as is shown by transverse sections (C, D), is a very thin and transparent cylinder; and it encloses the peculiar fibrous substance that constitutes the principal part of the shaft of the hair. The constituent fibres of this substance, which are marked-out by the delicate striae that may be traced in longitudinal sections of the hair (B), may be separated from each other by crushing the hair, especially after it has been macerated for some time in sulphuric acid; and each of them, when com-

pletely isolated from its fellows, is found to be a long spindle shaped cell. In the axis of this fibrous cylinder there is very commonly a band which is formed of spheroidal cells; but this is usually deficient in the fine hairs scattered over the general surface of the body, and is not always present in those of the head.* The hue of the Hair is due, partly to the presence of pigmentary granules, either collected into patches, or diffused through its substance; but partly also to the existence of a multitude of minute air-spaces, which cause it to appear dark by transmitted and white by reflected light. The cells of the axis-band, in particular, are very commonly found to contain air, giving it the black appearance shown at c. The difference between the blackness of pigment and that of air-spaces may be readily determined by attending to the characters of the latter as already laid-down (§§ 128, 129); and by watching the effects of the penetration of Oil of Turpentine or other liquids, which do not alter the appearance of pigment-spots, but obliterate all the markings produced by air-spaces, these returning again as the hair dries.—In mounting Hairs as Microscopic preparations, they should in the first instance be cleansed of all their fatty matter by maceration in ether; and they may then be put up either in weak Spirit or in Canada balsam, as may be thought preferable, the former menstruum being well adapted to display the characters of the finer and more transparent hairs, while the latter allows the light to penetrate more readily through the coarser and more opaque. Transverse sections of Hairs are best made by gluing or gumming several together, and then putting them into the Section-instrument; those of Human Hair may be easily obtained, however, by shaving a second time, very closely, a part of the surface over which the razor has already passed more lightly, and by picking-out from the lather, and carefully washing, the sections thus taken-off.

553. The stems of *Feathers* exhibit the same kind of structure as Hairs; their Cortical portion being the horny sheath that envelops the shaft, and their Medullary portion being the pith-like substance which that sheath includes. In small Feathers, this may usually be made very plain by mounting them in Canada balsam; in large Feathers, however, the texture is sometimes so altered by the drying-up of the pith (the cells of which are always found to be occupied by air alone), that the cellular structure cannot be demonstrated save by boiling thin slices in a dilute solution of potass, and not always even then. In small Feathers, especially

* Several writers regard this band of polygonal cells as the Medullary substance, and the fibrous structure which forms the principal body of the hair as the Cortical substance; the transparent sheath receiving some separate designation. To the Author, however, it appears that the transparent horny sheath, with its lines of imbrication, is the representative of the Cortical substance of other Hairs; and that its entire contents, whether polygonal cells or cells elongated into fusiform fibres, must be considered as equivalent to their Medullary substance.

such as have a downy character, the cellular structure is very distinctly seen in the *laminae* or 'barbs,' which are sometimes found to be composed of single files of pear-shaped cells, laid end-to-end; but in larger feathers it is usually necessary to increase the transparency of the barbs, especially when these are thick and but little pervious to light, either by soaking them in Turpentine, mounting them in Canada balsam, or boiling them in a weak solution of Potass. In the feathers which are destined to strike the air with great force in the act of flight, we find the barbs fringed on each side with hair-like filaments or *pinnæ*; on one side of each barb these filaments are toothed on one edge, whilst on the other side they are furnished with curved hooks; and as the two sets of *pinnæ* which spring from two adjacent barbs cross one another at an angle, and each hooked *pinna* on one locks into the teeth of several of the toothed *pinnæ* arising from the other, the barbs are connected together very firmly by this apparatus of 'hooks and eyes,' which reminds us of that already mentioned as to be observed on the wings of Hymenopterous Insects (§ 528).—Feathers or portions of feathers of Birds distinguished by the splendour of their plumage are very good objects for low magnifying powers, when illuminated on an opaque ground; but care must be taken that the light falls upon them at the angle necessary to produce their most brilliant reflection into the axis of the Microscope; since feathers which exhibit the most splendid metallic lustre to an observer at one point, may seem very dull to the eye of another in a different position. The small feathers of Humming-birds, portions of the feathers of the Peacock, and others of a like kind, are well worthy of examination; and the scientific Microscopist who is but little attracted by mere gorgeousness, may well apply himself to the discovery of the peculiar structure which imparts to these objects their most remarkable character.

554. Sections of *Horns, Hoofs, Claws*, and other like modifications of Epidermic structure,—which may be made by the Section Instrument (§ 137), the substance to be cut having been softened, if necessary, by soaking in warm water,—do not in general afford any very interesting features when viewed in the ordinary mode; but there are no objects on which Polarized light produces more remarkable effects, or which display a more beautiful variety of colours when a plate of Selenite is placed behind them and the Analyzing prism is made to rotate. A curious modification of the ordinary structure of Horn is presented in the appendage borne by the *Rhinoceros* upon its snout, which in many points resembles a bundle of hairs, its substance being arranged in minute cylinders around a number of separate centres, which have probably been formed by independent papillæ (Fig. 369). When transverse sections of these cylinders are viewed by polarized light, each of them is seen to be marked by a cross, somewhat resembling that of Starch-grains (§ 292); and the lights and

shadows of this cross are replaced by contrasted colours, when the Selenite plate is interposed. The substance commonly but erroneously termed *Whalebone*, which is formed from the surface of the membrane that lines the mouth of the Whale, and has no relation to its true bony skeleton, is almost identical in structure with Rhinoceros horn, and is similarly affected by Polarized light. The central portion of each of its component fibres, like the Medullary

FIG. 369.

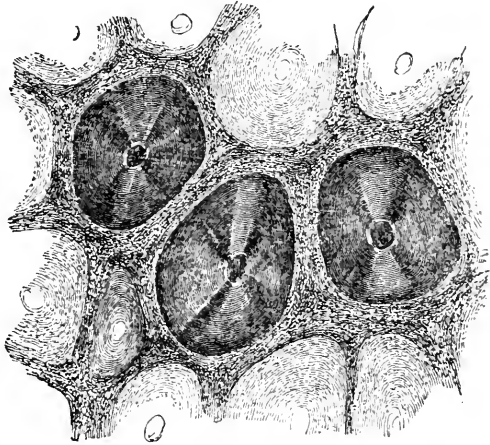
Transverse section of Horn of *Rhinoceros*, viewed by Polarized Light.

substance of Hairs, contains cells that have been so little altered as to be easily recognized; and the outer or Cortical portion also may be shown to have a like structure, by macerating it in a solution of potass, and then in water.—Sections of any of the Horny tissues are best mounted in Canada balsam.

555. *Blood*.—Carrying our Microscopic survey, now, to the elementary parts of which those softer Tissues are made up, that are subservient to the active life of the body rather than to its merely-mechanical requirements, we shall in the first place notice the isolated floating cells contained in the Blood, and known as the Blood-Corpuscles. These are of two kinds; the 'red,' and the 'white' or 'colourless.' The Red present, in every instance, the form of a flattened disk, which is circular in Man and most Mammalia (Fig. 371), but is oval in Birds, Reptiles (Fig. 370), and Fishes, as also in a few Mammals (all belonging to the *Camel* tribe). In the one form, as in the other, these Corpuscles seem to be flattened cells, the walls of which, however, are not distinctly differentiated from the viscid substance they contain; as appears from the changes of form which (as shown by Dr. Beale) they spontaneously undergo when kept at a temperature of about 100°, and from the effects of pressure in breaking them up. The Red corpuscles in the blood of Oviparous Vertebrata are distinguished by the presence of a central spot or *Nucleus*, which appears to be composed of an aggregation of minute

granules; this is most distinctly brought into view by treating the blood-disks with Acetic acid, which renders the remaining

FIG. 370.

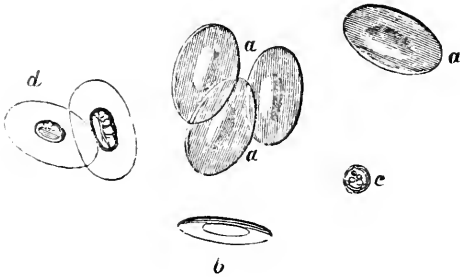

Red Corpuscles of *Frog's* Blood:—*a a*, their flattened face; *b*, particle turned nearly edge-ways; *c*, Colourless corpuscle; *d*, red corpuscles altered by dilute acetic acid.

portion extremely transparent, while it increases the opacity of the nucleus (Fig. 370, *d*). It is remarkable, however, that the Red corpuscles of the blood of Mammals should possess no obvious nucleus; the dark spot which is seen in their centre (Fig. 371, *b*) being merely an effect of refraction, consequent upon the

double-concave form of the disk. When the Corpuscles are treated with water, so that their form becomes first flat, and then double-

convex, the dark spot disappears; whilst, on the other hand, it is made more evident when the concavity is increased by the partial shrinkage of the corpuscles, which may be brought about by treating them with fluids of greater density than their own contents. The size of the Red Corpuscles is not altogether uniform in the same blood; thus it varies in that of Man from about-

FIG. 371.

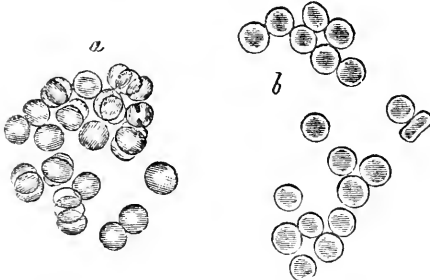

Red Corpuscles of *Human* Blood; represented at *a*, as they are seen when rather within the focus of the microscope, and at *b*, as they appear when precisely in the focus.

the 1-4000th to the 1-2800th of an inch. But we generally find that there is an average size, which is pretty constantly maintained among the different individuals of the same species; that of Man may be stated at about 1-3200th of an inch. The following Table* exhibits the average dimensions of some of the most interesting examples of the Red blood-corpuscles in the four classes of Verte-

* These measurements are chiefly selected from those given by Mr. Gulliver in his edition of Hewson's Works, p. 236, *et seq.*

brated Animals, expressed in fractions of an inch. Where two measurements are given, they are the long and the short diameters of the same corpuscles. (See also Fig. 372.)

MAMMALS.

Man	1-3200	Camel	1-3254, 1-5921
Dog	1-3542	Llama	1-3361, 1-6294
Whale	1-3099	Java Musk-Deer	1-12325
Elephant	1-2745	Caucasian Goat	1-7045
Mouse	1-3814	Two-toed Sloth	1-2865

BIRDS.

Golden Eagle	1-1812, 1-3832	Ostrich	1-1649, 1-3000
Owl	1-1830, 1-3400	Cassowary	1-1455, 1-2800
Crow	1-1961, 1-4000	Heron	1-1913, 1-3491
Blue-Tit	1-2313, 1-4128	Fowl	1-2102, 1-3466
Parrot	1-1898, 1-4000	Gull	1-2097, 1-4000

REPTILES.

Turtle	1-1231, 1-1882	Frog	1-1108, 1-1821
Crocodile	1-1231, 1-2286	Water-Newt	1-814, 1-1246
Green Lizard	1-1555, 1-2743	Siren	1-420, 1-760
Slow-worm	1-1178, 1-2666	Proteus	1-400, 1-727
Viper	1-1274, 1-1800	Lepidosiren	1-570, 1-941

FISHES.

Perch	1-2099, 1-2824	Pike	1-2000, 1-3555
Carp	1-2142, 1-3429	Eel	1-1745, 1-2842
Gold-Fish	1-1777, 1-2824	Gymnotus	1-1745, 1-2599

Thus it appears that the *smallest* red corpuscles known are those of the *Musk-Deer*; whilst the *largest* are those of that curious group of Batrachian (frog-like) Reptiles which retain their gills through the whole of life; and one of the oval blood-disks of the *Proteus*, being more than 30 times as long and 17 times as broad as those of the Musk-deer, would cover no fewer than 510 of them.—According to the recent estimate of Vierordt, a cubic inch of Human Blood contains upwards of *eighty millions* of Red corpuscles, and nearly a *quarter of a million* of the White.

556. The 'White' or 'Colourless' corpuscles are more readily distinguished in the blood of Reptiles than in that of Man; being, in the former case, of much smaller size, as well as having a circular outline (Fig. 370, *c*); whilst in the latter their size and contour are nearly the same, so that, as the Red corpuscles themselves when seen in a single layer have but a very pale hue, the deficiency of colour does not sensibly mark their difference of nature. It is remarkable that, notwithstanding the great variations in the sizes of the Red corpuscles in different species of Vertebrated animals, the size of the White is extremely constant throughout, their diameter being seldom much greater or less than 1-3000th of an inch in the Warm-blooded classes, and 1-2500th in Reptiles. Their ordinary form is globular; but their aspect is subject to considerable variations, which seem to depend in great part upon their phase of development. Thus in their early state,

in which they seem to be identical with the corpuscles found floating in *Chyle* and *Lymph*, they seem to be nearly homogeneous

FIG. 372.

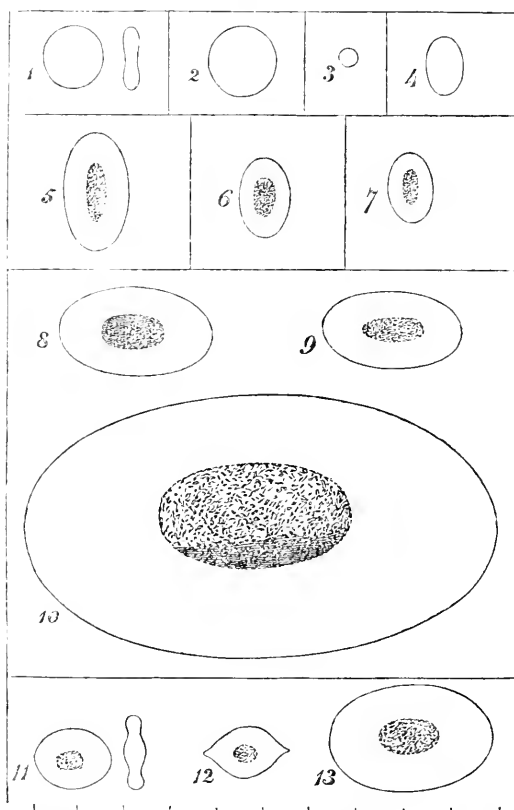

Comparative sizes of Blood-Corpuscles:—1. Man; 2. Elephant; 3. Musk-Deer; 4. Dromedary; 5. Ostrich; 6. Pigeon; 7. Humming Bird; 8. Crocodile; 9. Python; 10. Proteus; 11. Perch; 12. Pike; 13. Shark.

remind us of those of the *Amœba* (§ 331); a protrusion taking place from some portion of the Ectosarc, the form of which seems quite indeterminate; and this being soon succeeded by another from some different part, the first being either drawn-in again, or remaining as it was. These changes have been observed, not only in the Colourless corpuscles of the blood of various Vertebrated animals, but also in the corpuscles floating in the circulating

particles of protoplasmic substance; but in their more advanced condition a differentiation is observable, analogous to that which exists between the Ectosarc and Endosarc of Rhizopods (§ 325); and the isolated particles of the latter are often to be seen executing an active molecular movement within the former, which continues when they are discharged by the bursting of the corpuscle, consequent upon the addition of a solution of potass. These Corpuscles are occasionally seen to exhibit very curious changes of form, which

fluid of the higher Invertebrata, such as the Crab, which resemble the Colourless corpuscles of Vertebrated blood rather than its Red corpuscles,—these last, in fact, being altogether peculiar to the circulating fluid of Vertebrated animals.

557. In examining the Blood microscopically, it is, of course, of

importance to obtain as thin a stratum of it as possible, so that the Corpuscles may not overlie one another. This is best accomplished by selecting a piece of thin glass of perfect flatness, and then, having received a small drop of Blood upon a glass slide, to lay the Thin-glass cover *not upon* this, but with its edge just touching the edge of the drop; for the blood will then be drawn-in by

FIG. 373.

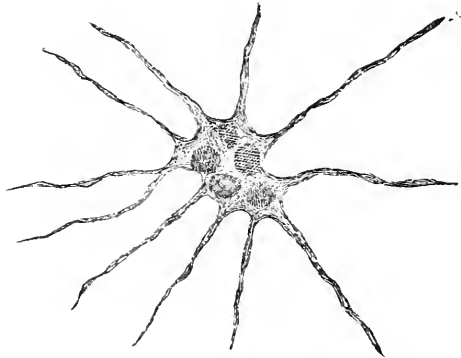

Altered Colourless (or White) Corpuscle of Blood, an hour after being drawn from the finger.

capillary attraction, so as to spread in a uniformly-thin layer between the two glasses. The inexperienced observer will be surprised at the very pale hue which the Red corpuscles exhibit beneath the Microscope, when seen in a single stratum; but this surprise need no longer be felt, when it is borne in mind that the thickness of the film of colouring fluid which they contain is probably not more than 1-20,000th of an inch; and if a drop of Ink, or of almost any coloured liquid, however dark, be pressed-out between two glasses into an equally thin film, its hue will be lightened in the same degree. The red hue of the corpuscles, however, becomes obvious enough, when two or more layers of them are seen-through at once. The Colourless corpuscles in Human blood are usually not more than 1:350 of the Red, so that no more than one or two are likely to be in the field at once; and these may generally be recognized most readily by their standing-apart from the rest; for whilst the Red corpuscles have a tendency to adhere to each other by their discoidal surfaces, the Colourless show no such disposition. Thin films of blood may be preserved in the liquid state, with little change, by applying Gold-size or Asphalte round the edge of the thin-glass cover before evaporation has had time to take-place; but it is in some respects preferable to dilute the liquid with a small quantity of Goadby's solution, its strength being so adjusted as not to produce any

endosmotic change of form in the corpuscles. But it is far simpler to allow such films to dry, without any cover, and then merely to cover them for protection; and in this condition the general characters of the corpuscles can be very well made-out, notwithstanding that they have in some degree shrivelled by the desiccation they have undergone. And this method is particularly serviceable, as affording a fair means of comparison, when the assistance of the Microscopist is sought in determining, for Medico-legal purposes, the source of suspicious Blood-stains; the average dimensions of the dried Blood-corpuscles of the several Domestic animals being sufficiently different from each other and from those of Man, to allow the nature of any specimen to be pronounced-upon with a high degree of probability.

558. *Simple Fibrous Tissucs.*—A very beautiful example of a tissue of this kind is furnished by the membrane of the common Fowl's Egg; which (as may be seen by examining an egg whose shell remains soft for want of consolidation by Calcareous particles), consists of two principal layers, one serving as the basis of the shell itself, and the other forming that lining to it which is known as the *membrana putaminis*. The latter may be separated by careful tearing with needles and forceps, after prolonged maceration in water, into several matted lamellæ resembling that represented in Fig. 374; and similar lamellæ may be readily obtained from

FIG. 374.

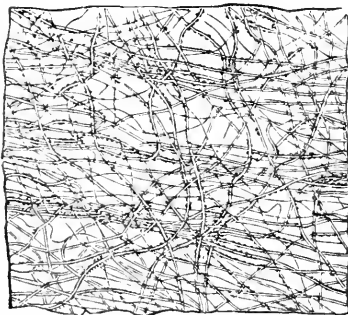

Fibrous membrane from Egg-shell.

the Shell itself, by dissolving away its Lime by dilute acid.* —The Simply-Fibrous structures of the body generally, however, belong to one of two very definite kinds of tissue, the 'White' and the 'Yellow,' whose appearance, composition, and properties are very different. The *White* fibrous tissue, though sometimes apparently composed of distinct fibres, more commonly presents the aspect of bands, usually of a flattened form, and attaining the breadth of 1-500th of an inch, which are marked by numerous longitudinal streaks,

* For an account of the curious manner in which the Carbonate of Lime is disposed in the Egg-shell, see § 599.

effect of Acetic acid, which swells it up and renders it transparent, at the same time bringing into view certain oval nuclear particles of 'germinal matter,' which

are known as 'Connective-Tissue - corpuscles' (§ 540). These are relatively much larger, and their connections more distinct, in the earlier stages of the formation of this Tissue (Fig. 376). It is perfectly inelastic; and we find it in such parts as Tendons, ordinary Ligaments, Fibrous Capsules, &c., whose function it is to resist tension without yielding to it. It constitutes, also, the organic basis or matrix of Bone; for although the substance which is left when a Bone has been macerated sufficiently long in dilute Acid for all its Mineral

components to be removed, is commonly designated as Cartilage, this is shown by careful Microscopic analysis not to be a correct description of it; since it does not show any of the characteristic structure of Cartilage, but is capable of being torn into lamellæ, in which, if sufficiently thin, the ordinary structure of a Fibrous Membrane can be distinguished.—The *Yellow* fibrous tissue exists in the form of long, single, elastic, branching filaments, with a dark decided border; which are disposed to curl when not put on the stretch (Fig. 377), and frequently anastomose, so as to form a network. They are for the most part between 1-5000th and 1-10,000th of an inch in diameter; but they are often met with both larger and smaller. This tissue does not undergo any change, when treated with Acetic acid. It exists alone (that is, without any mixture of the White) in parts which require a peculiar elasticity, such as the middle coat of the Arteries, the Vocal Cords, the Ligamentum Nuchæ of Quadrupeds, the elastic ligament which holds together the valves of a Bivalve shell, and that by which the claws of the Feline tribe are retracted when not in use; and

FIG. 375.

*White Fibrous Tissue from Ligament.*

FIG. 376.

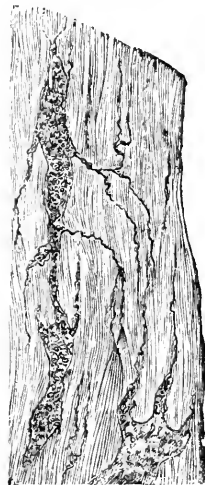

Portion of young Tendon, showing the corpuscles of Germinal Matter, with their stellate prolongations, interposed among its fibres.

it enters largely into the composition of *Areolar* or *Connective Tissue*.

559. The Tissue formerly known to Anatomists as 'cellular,'

FIG. 377.



Yellow Fibrous Tissue from *Ligamentum Nuchæ* of Calf.

but now more properly designated *Connective* or *Areolar Tissue*, consists of a network of minute fibres and bands, which are interwoven in every direction, so as to leave innumerable *areolæ* or little spaces that communicate freely with one another. Of these fibres, some are of the Yellow or elastic kind; but the majority are

composed of the White fibrous tissue; and, as in that form of elementary structure, they frequently present the form of broad flattened bands or membranous shreds, in which no distinct fibrous arrangement is visible. The proportion of the two forms varies, according to the amount of elasticity, or of simple resisting power, which the endowments of the part may require. We find this tissue in a very large proportion of the bodies of higher Animals; thus it binds-together the ultimate Muscular fibres into minute fasciculi, unites these fasciculi into larger ones, these again into still larger ones which are obvious to the eye, and these into the entire Muscle; whilst it also forms the membranous divisions between distinct muscles. In like manner it unites the elements of Nerves, Glands, &c., binds together the Fat-cells into minute masses, these into large ones, and so on; and in this way penetrates and forms part of all the softer organs of the body. But whilst the Fibrous structures of which the 'formed tissue' is composed have a purely Mechanical function, there is good reason to regard the 'Connective-tissue-corpuscles' which are everywhere dispersed among them, as having a most important function in the first production and subsequent maintenance of the more definitely organized portions of the fabric (§ 540). In these Corpuscles distinct *movements*, analogous to those of the sarcode extensions of Rhizopods, have lately been recognized in transparent parts, such as the Cornea of the Eye and the Tail of the young Tadpole, by observations made on these parts whilst living.—For the display of the characters of the Fibrous tissues, small and thin shreds may

be cut with the curved scissors from any part that affords them ; and these must be torn-asunder with needles under the Simple Microscope, until the fibres are separated to a degree sufficient to enable them to be examined to advantage under a higher magnifying power. The difference between the 'White' and the 'Yellow' components of Connective tissue is at once made apparent by the effect of Acetic acid ; whilst the 'Connective-tissue-corpuscles' are best distinguished by the Staining-process (§ 145), especially in the early stage of the formation of these tissues (Fig. 376).

560. *Skin, Mucous, and Serous Membranes.*—The Skin which forms the external envelope of the body, is divisible into two principal layers ; the *Cutis vera* or 'True Skin,' which usually makes up by far the larger part of its thickness, and the 'Cuticle,' 'Scarf-skin,' or *Epidermis*, which covers it. At the Mouth, Nostrils, and the other orifices of the *open* cavities and canals of the body, the Skin passes into the membrane that lines these, which is distinguished as the *Mucous* membrane, from the peculiar glairy secretion of Mucus by which its surface is protected. But those great *closed* cavities of the body, which surround the Heart, Lungs, Intestines, &c., are lined by membranes of a different kind ; which, as they secrete only a thin serous fluid from their surfaces, are known as *Serous* membranes. Both Mucous and Serous membranes consist, like the Skin, of a proper membranous basis, and of a thin cuticular layer, which, as it differs in many points from the epidermis, is distinguished as the Epithelium (§ 563).—The substance of the 'True Skin' and of the 'Mucous' and 'Serous' membranes is principally composed of the Fibrous tissues last described ; but the Skin and the Mucous membranes are very copiously supplied with Blood-vessels and with Glandulæ of various kinds ; and in the Skin we also find abundance of Nerves and Lymphatic vessels, as well as, in some parts, of Hair-follicles. The general appearance ordinarily presented by a thin vertical section of the Skin of a part furnished with numerous Sensory *papillæ* (§ 572), is shown in Fig. 378 ; where we see in the deeper layers of the *Cutis vera* little clumps of Fat-cells, *f*, and the Perspiratory glandulæ *d, d*, whose Ducts, *e, e*, pass upwards ; whilst on its surface we distinguish the *vascular* Papillæ, *p*, supplied with loops of Blood-vessels from the trunk, *g*, and a *tactile* Papilla, *t*, with its Nerve-twig. The spaces between the papillæ are filled-up by the soft Malpighian layer, *m*, of the Epidermis, *A*, in which its colouring matter is chiefly contained ; whilst this is covered by the horny layer, *h*, which is traversed by the spirally-twisted continuations of the perspiratory ducts, opening at *s*, upon the surface, which presents alternating depressions, *a*, and elevations, *b*.—The distribution of the Blood-vessels in the Skin and Mucous membranes, which is one of the most interesting features in their structure, and which is intimately connected with their several functions, will come under our notice hereafter (Figs. 394, 397,

398). In Serous membranes, on the other hand, whose function is simply protective, the supply of Blood-vessels is more scanty.

561. *Epidermic and Epithelial Cell-layers.*—The Epidermis or

FIG. 378.

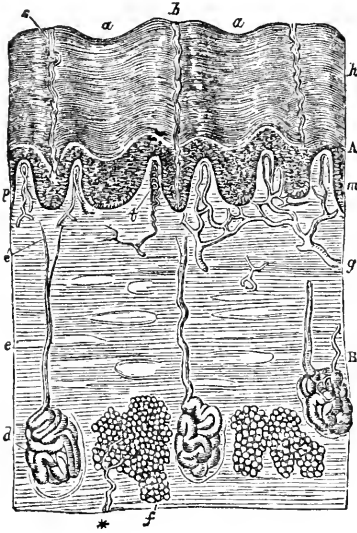

Vertical Section of Skin of Finger :
—A, Epidermis, the surface of which shows depressions *a, a*, between the eminences *b, b*, on which open the Perspiratory Ducts *s*; at *m* is seen the deeper layer of the Epidermis, or Stratum Malpighii:—B, Cutis Vera, in which are imbedded the Perspiratory Glands *d*, with their Ducts *e*, and aggregations of Fat-cells *f*; *g*, Arterial twig supplying the Vascular papillæ *p*; *t*, one of the Tactile papillæ with its Nerve.

are flattened one against another. As we proceed further towards the surface, we perceive that the cells are gradually more and more flattened until they become mere horny scales, their cavity being obliterated; their origin is indicated, however, by the Nucleus in the centre of each. This change in form is accompanied by a change in the Chemical composition of the tissue, which seems to be due to the metamorphosis of the contents of the Cells into a Horny substance identical with that of which Hair, Horn, Nails, Hoofs, &c., are composed.—Mingled with the Epidermic cells, we

‘Cuticle’ covers the whole exterior of the body, as a thin semi-transparent pellicle, which is shown by Microscopic examination to consist of a series of layers of Cells, that are continually wearing-off at the external surface, and renewed at the surface of the True Skin; so that the newest and deepest layers gradually become the oldest and most superficial, and are at last thrown-off by slow desquamation. In their progress from the internal to the external surface of the Epidermis, the cells undergo a series of well marked changes. When we examine the innermost layer, we find it soft and granular; consisting of germinal corpuscles in various stages of development into cells, held-together by a tenacious semi-fluid substance. This was formerly considered as a distinct tissue, and was supposed to be the peculiar seat of the colour of the skin; it received the designation of Malpighian layer or *rete mucosum*. Passing outwards, we find the cells more completely formed; at first nearly spherical in shape, but becoming polygonal where they

find others which secrete Colouring matter instead of horn; these which are termed 'Pigment-cells,' are especially to be noticed in the Epidermis of the Negro and other dark races, and are most distinguishable in the Malpighian layer, their colour appearing to fade as they pass towards the surface.—The most remarkable development of Pigment-cells in the higher animals, however, is on the inner surface of the Choroid coat of the Eye, where they have a very regular arrangement, and form several layers, known as the *Pigmentum nigrum*. When examined separately, these cells are found to have a polygonal form (Fig. 379, *a*), and to have a distinct nucleus (*b*) in their interior. The black colour is given by the accumulation, within the cell, of a number of flat rounded or oval granules, of extreme minuteness, which exhibit an active movement when set-free from the cell, and even whilst enclosed within it. The pigment-cells are not always, however, of this simply rounded or polygonal form; they sometimes present remarkable stellate prolongations, under which form they are well seen in the Skin of the

Frog (Fig. 393, *c, c*). The gradual formation of these prolongations may be traced in the pigment-cells of the Tadpole during its metamorphosis (Fig. 380). Similar varieties of form are to be met-with in the pigmentary cells of Fishes and small Crustacea, which also present a great variety of hues; and these seem to take the colour of the bottom over which the animal may live, so as to serve for its concealment.

562. The structure of the Epidermis may be examined in a variety of ways. If it be removed by maceration from the True Skin, the cellular nature of its under surface is at once recognized, when it is subjected to a magnifying power of 200 or 300 diameters, by light transmitted through it, with this surface uppermost; and if the Epidermis be that of a Negro or any other dark-skinned race, the pigment-cells will be very distinctly seen. This under-surface of the Epidermis is not flat, but is excavated into pits and channels for the reception of the Papillary elevations of the True Skin; an arrangement which is shown on a large scale in the thick cuticular covering of the Dog's foot, the subjacent papillæ being large enough to be distinctly seen (when injected) with the naked eye. The cellular nature of the newly-forming layers is best seen by examining a little of the soft film that is found upon the

FIG. 379.

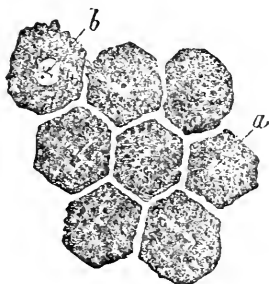

Cells from *Pigmentum Nigrum*:
—*a*, pigmentary granules concealing the nucleus; *b*, the nucleus distinct.

surface of the True Skin, after the more consistent layers of the Cuticle have been raised by a blister. The alteration which the

cells of the external layers have undergone, tends to obscure their character; but if any fragment of Epidermis be macerated for a little time in a weak solution of Soda or Potass, its dry scales become softened, and are filled-out by imbibition into rounded or polygonal cells. The same mode of treatment enables us to make out the cellular structure in Warts and Corns, which are Epidermic growths from the surface of papillæ enlarged by hypertrophy.

563. The *Epithelium* may be designated as a delicate Cuticle, covering all the free *internal* surfaces of the body, and thus lining all its cavities, canals, &c. Save in the mouth and other parts in which it approximates to the ordinary Cuticle both in locality and in nature, its Cells (Fig. 381) usually form but a single layer; and are so deficient in tenacity of mutual adhesion, that they cannot be detached in the form of a continuous Membrane. Their shape varies greatly; for sometimes they are broad, flat,

Pigment-cells from tail of Tadpole:—*a*, *a*, simple forms of recent origin; *b*, *b*, more complex forms subsequently assumed.

and scale-like, and their edges approximate closely to each other, so as to form what is termed a 'pavement' or 'tesselated' Epi-

thelium; such cells are observable on the web of a Frog's foot, or on the tail of a Tadpole; for, though covering an external surface, the soft moist Cuticle of these parts has all the characters of an Epithelium. In other cases, the cells have more of the form of cylinders, standing erect side-by-side, one extremity of each cylinder forming part of the free surface, whilst the other rests upon the membrane to which it serves as a covering. If the cylinders be closely pressed-to-

FIG. 380.

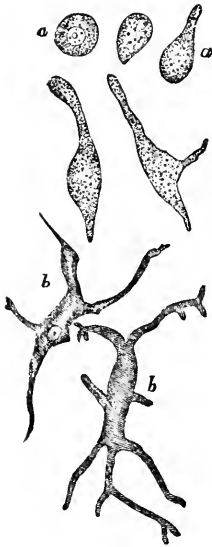
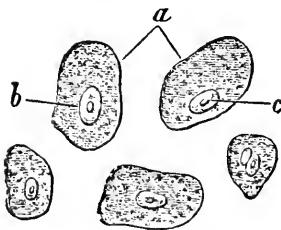

FIG. 381.



Detached Epithelium-cells *a*, with nuclei *b*, and nucleoli *c*, from Mucous Membrane of mouth.

ther, their form is changed into prisms; and such Epithelium is often known as 'prismatic.' On the other hand, if the surface on which it rests be convex, the bases or lower ends of the cylinders become smaller than their free extremities; and thus each has the form of a truncated cone rather than of a cylinder, and such Epithelium (of which that covering the *villi* of the Intestine, Fig. 394, is a peculiarly-good example) is termed 'conical.' But between these primary forms of Epithelial cells, there are several intermediate gradations; and one often passes almost insensibly into the other.—Any of these forms of Epithelium may be furnished with *Cilia*; but these appendages are more commonly found attached to the elongated, than to the flattened forms of epithelium-cells (Fig. 382). Ciliated Epithelium is found upon the lining membrane of the

Air-passages in all air-breathing Vertebrata; and it also presents itself in many other situations, in which a propulsive power is needed to prevent an accumulation of mucous or other secretions. Owing to the very slight attachment that usually exists between the Epithelium and the Mem-

FIG. 382.

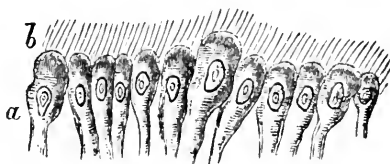

Ciliated Epithelium; a, nucleated cells, resting on their smaller extremities; b, cilia.

branous surface whereon it lies, there is usually no difficulty whatever in examining it; nothing more being necessary than to scrape the surface of the membrane with a knife, and to add a little water to what has been thus removed. The Ciliary action will generally be found to persist for some hours or even days after death, if the animal has been previously in full vigour;* and the cells that bear the cilia, when detached from each other, will swim freely about in water. If the thin fluid that is copiously discharged from the nose in the first stage of an ordinary 'cold in the head,' be subjected to microscopic examination, it will commonly be found to contain a great number of Ciliated Epithelium-cells which have been thrown-off from the lining membrane of the nasal passages.

564. *Fat*.—One of the best examples which the bodies of higher animals afford, of a tissue composed of an aggregation of Cells, is presented by the Adipose substance; the cells of which are distinguished by their power of drawing into themselves Oleaginous matter from the blood. Fat-cells are sometimes dispersed in the interspaces of Areolar tissue; whilst in other cases they are aggre-

* Thus it has been observed in the lining of the windpipe of a decapitated criminal, as much as seven days after death; and in that of the River Tortoise it has been seen fifteen days after death, even though putrefaction had already far advanced.

gated in distinct masses, constituting the proper Adipose tissue. The individual Fat-cells always present a nearly spherical or spheroidal form; sometimes, however, when they are closely pressed together, they become somewhat polyhedral, from the flattening of their walls against each other (Fig. 383). Their intervals are traversed by a minute network of

Blood-vessels (Fig. 395), from which they derive their secretion; and it is probably by the constant moistening of their walls with a *watery* fluid, that their contents are retained without the least transudation, although these are quite fluid at the temperature of the living body. Fat-cells, when filled with their characteristic contents, have the peculiar appearance which has been already described as appertaining to Oil-globules (§ 129), being very bright in their centre, and very dark towards their margin, in consequence of their high refractive power; but if, as often happens in preparations that have been long mounted, the oily contents should have escaped, they then look like any other cells of the same form. Although

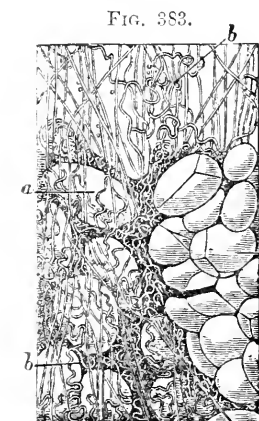

Areolar and Adipose tissue:
a, a, fat-cells; b, b, fibres of
areolar tissue.

the fatty matter which fills these cells (consisting of a solution of Stearine or Margarine in Oleine) is liquid at the ordinary temperature of the body of a warm-blooded animal, yet its harder portion sometimes crystallizes on cooling; the crystals shooting from a centre, so as to form a star-shaped cluster.—In examining the structure of Adipose tissue, it is desirable, where practicable, to have recourse to some specimen in which the Fat-cells lie in single layers, and in which they can be observed without disturbing or laying them open; such a condition is found, for example, in the mesentery of the Mouse; and it is also occasionally met with in the fat-deposits which present themselves at intervals in the Connective tissues of the muscles, joints, &c. Small collections of Fat-cells exist in the deeper layers of the True Skin, and are brought into view by vertical sections of it (Fig. 378, f). And the structure of large masses of Fat may be examined by thin sections, these being placed under water in thin cells, so as to take-off the pressure of the glass-cover from their surface, which would cause the escape of the oil-particles. No method of mounting (so far as the Author is aware) is successful in causing these Cells permanently to retain their contents.

565. *Cartilage*.—In the ordinary forms of Cartilage, also, we

have an example of a tissue essentially composed of Cells: but these are commonly separated from each other by an 'Intercellular substance,' which is so closely adherent to the outer walls of the cells as not to be separable from them (§ 539). The thickness of this substance differs greatly in different kinds of Cartilage, and even in different stages of the growth of any one. Thus in the Cartilage of the external Ear of a *Bat* or *Mouse* (Fig. 384), the cells are packed as closely together as are those of an ordinary Vegetable parenchyma (Fig. 198, A); and this seems to be the early condition of most Cartilages that are afterwards to present a different aspect. In the ordinary Cartilages, however, that cover the extremities of the bones, so as to form smooth surfaces for the working of the joints, the amount of Intercellular substance is usually considerable; and the cartilage-cells are commonly found imbedded in this, in clusters of two, three, or four (Fig. 385), which are evidently formed by a process of 'binary subdivision' analogous to that by which the multiplication of cells take place in the Vegetable Kingdom (§ 185). The substance of these *cellular* Cartilages is entirely destitute of Blood-vessels; being nourished solely by imbibition from the blood brought to the membrane covering their surface. Hence they may be compared, in regard to their grade of organization, with the larger Algae; which consist, like them, of aggregations of cells held

FIG. 384.

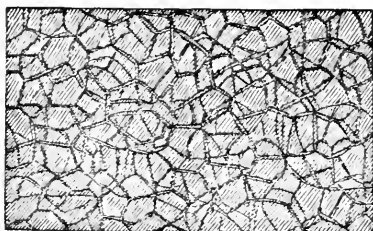

Cellular Cartilage of Mouse's-ear.

together as are those of an ordinary Vegetable parenchyma (Fig. 198, A); and this seems to be the early condition of most Cartilages that are afterwards to present a different aspect. In the ordinary Cartilages, however, that cover the extremities of the bones, so as to form smooth surfaces for the working of the joints, the amount of Intercellular substance is usually considerable; and the cartilage-cells are commonly found imbedded in this, in clusters of two, three, or four (Fig. 385), which are evidently formed by a process of 'binary subdivision' analogous to that by which the multiplication of cells take place in the Vegetable Kingdom (§ 185). The substance of these *cellular* Cartilages is entirely destitute of Blood-vessels; being nourished solely by imbibition from the blood brought to the membrane covering their surface. Hence they may be compared, in regard to their grade of organization, with the larger Algae; which consist, like them, of aggregations of cells held

FIG. 385.

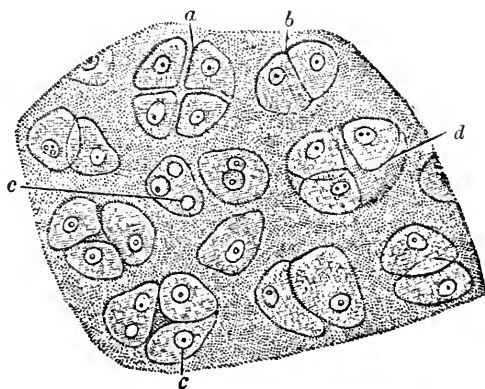

Section of the branchial *Cartilage* of Tadpole:—
a, group of four cells, separating from each other; *b*, pair of cells in apposition; *c*, *c*, nuclei of cartilage-cells; *d*, cavity containing three cells.

together as are those of an ordinary Vegetable parenchyma (Fig. 198, A); and this seems to be the early condition of most Cartilages that are afterwards to present a different aspect. In the ordinary Cartilages, however, that cover the extremities of the bones, so as to form smooth surfaces for the working of the joints, the amount of Intercellular substance is usually considerable; and the cartilage-cells are commonly found imbedded in this, in clusters of two, three, or four (Fig. 385), which are evidently formed by a process of 'binary subdivision' analogous to that by which the multiplication of cells take place in the Vegetable Kingdom (§ 185). The substance of these *cellular* Cartilages is entirely destitute of Blood-vessels; being nourished solely by imbibition from the blood brought to the membrane covering their surface. Hence they may be compared, in regard to their grade of organization, with the larger Algae; which consist, like them, of aggregations of cells held

together by intercellular substance, without vessels of any kind, and are nourished by imbibition through their whole surface.—There are many cases, however, in which the structureless Intercellular substance is replaced by bundles of Fibres, sometimes elastic, but more commonly non-elastic; such combinations, which are termed *Fibro-Cartilages*, are interposed in certain Joints, wherein tension as well as pressure has to be resisted, as for example, between the *Vertebræ* of the spinal column, and the bones of the *Pelvis*.—In examining the structure of Cartilage, nothing more is necessary than to make very thin sections with a sharp razor or scalpel, or with a *Valentin's Knife* (§ 136), or, if the specimen be large and dense (as the cartilage of the ribs), with the *Section-instrument* (§ 137). These sections may be mounted in weak Spirit, in *Goadby's solution*, or in *Glycerine-jelly*; but in whatever way they are mounted, they undergo a gradual *changé* by the lapse of time, which renders them less fit to display the characteristic features of their structure.

566. *Structure of Glands*.—The various Secretions of the body (as the saliva, bile, urine, &c.) are formed by the instrumentality of organs termed *Glands*; which are, for the most part, constructed on one fundamental type, whatever be the nature of their product. The simplest idea of a *Gland* is that which we gain from an examination of the '*Follicles*' or little bags imbedded in the wall of the *Stomach*; some of which secrete *Mucus* for the protection of its surface, and others *Gastric juice*. These little bags are filled with *Cells* of a spheroidal form, which may be considered as constituting their *Epithelial lining*; these cells, in the progress of their development, draw into themselves from the blood the constituents of the particular product they are to secrete; and they then seem to deliver it up, either by the bursting or by the melting-away of their walls, so that this product may be poured-forth from the mouth of the bag into the cavity in which it is wanted. The *Liver* itself, in the lowest animals wherein it is found, presents this condition. Some of the cells that form the lining of the stomach in the *Hydra* and *Actinia*, seem to be distinguished from the rest by their power of secreting *Bile*, which gives them a brownish-yellow tinge; in many *Polyzoa*, *Compound Tunicata*, and *Annelida*, these biliary cells can be seen to occupy follicles in the walls of the stomach; in *Insects* these follicles are few in number, but are immensely elongated so as to form biliary tubes, which lie loosely within the abdominal cavity, frequently making many convolutions within it, and discharge their contents into the commencement of the intestinal canal; whilst in the higher *Mollusca*, and in *Crustacea*, the follicles are vastly multiplied in number, and are connected with the ramifications of gland-ducts, like grapes upon the stalks of their bunch, so as to form a distinct mass which now becomes known as the *Liver*. The examination of the biliary tubes of the *Insect*, or of the biliary follicles of the *Crab*, which

may be accomplished with the utmost facility, is well adapted to give an idea of the essential nature of glandular structure. Among Vertebrated animals, the Salivary glands, the Pancreas (sweet-bread), and the Mammary glands, are well adapted to display the follicular structure (Fig. 386); nothing more being necessary than to make sections of these organs, thin enough to be viewed as transparent objects. The Liver of Vertebrata, however, presents certain peculiarities of structure, which are not yet fully understood; for although it is essentially composed, like other Glands, of secreting cells, yet it has not yet been determined beyond doubt whether these cells are contained within any kind of membranous investment. The Kidneys of Vertebrated animals are made-up of elongated tubes, which are straight and are lined with a pavement

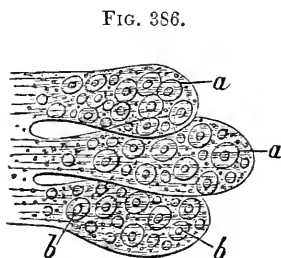

Ultimate Follicles of Mammary Gland, with their Secreting Cells *a, a*, containing nuclei *b, b*.

epithelium in the inner or 'medullary' portion of the kidney, whilst they are convoluted and filled with a spheroidal epithelium in the outer or 'cortical.' Certain flask-shaped dilatations of these tubes include curious little knots of blood-vessels, which are known as the 'Malpighian bodies' of the kidney; these are well displayed in injected preparations.—For such a full and complete investigation of the structure of these organs as the Anatomist and Physiologist require, various methods must be put in practice which this is not the place to detail. It is perfectly easy to demonstrate the cellular nature of the surface of the Liver, by simply scraping a portion of its cut surface; since a number of its cells will be then detached. The general arrangement of the Cells in the lobules may be displayed by means of sections thin enough to be transparent; whilst the arrangement of the Blood-vessels can only be shown by means of Injections (§ 577). Fragments of the tubules of the Kidney, sometimes having the Malpighian capsules in connection with them, may also be detached by scraping its cut surface; but the true relations of these parts can only be shown by thin transparent sections, and by Injections of the Blood-vessels and tubuli. The simple follicles contained in the walls of the Stomach are brought into view by vertical sections; but they may be still better examined by leaving small portions of the lining membrane for a few days in dilute nitric acid (one part to four of water), whereby the Fibrous tissue will be so softened, that the clusters of Glandular Epithelium lining the follicles (which are but very little altered) will be readily separated.

567. *Muscular Tissue*.—Although we are accustomed to speak

of this tissue as consisting of 'fibres,' yet the ultimate structure of the 'Muscular Fibre' is very different from that of the Simple Fibrous tissues already described. When we examine an ordinary Muscle (or piece of 'flesh') with the naked eye, we observe that it is made-up of a number of *fasciculi* or bundles of fibres, which are arranged side-by-side with great regularity in the direction in which the muscle is to act, and are united by Areolar tissue. These Fasciculi may be separated into smaller parts, which appear like simple fibres; but when these are examined by the Microscope, they are found to be themselves fasciculi, composed of minuter fibres bound together by delicate filaments of Connective tissue. By carefully separating these, we may obtain the ultimate Muscular Fibre. This fibre exists under two forms, the *Striated* and the *Non-striated*. The former is chiefly distinguished by the transversely-striated appearance which it presents (Fig. 387), and

FIG. 387.

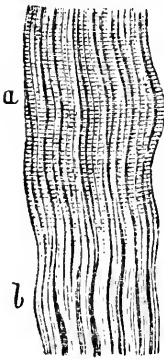

Fasciculus of Striated Muscular Fibre, showing at *a* the transverse striæ, and at *b* its junction with the Tendon.

which is due to an alternation of light and dark spaces along its whole extent; the breadth and distance of these striæ vary, however, in different fibres, and even in different parts of the same fibre, according to its state of contraction or relaxation. Longitudinal striæ are also frequently visible, which are due to a partial separation between the component fibrillæ into which the fibre may be broken up.—When a fibre of this kind is more closely examined, it is seen to consist of a delicate tubular sheath, quite distinct on the one hand from the Connective tissue which binds the fibres into fasciculi, and equally distinct from the internal substance of the fibre. This membranous tube, which has been termed the *Sarcolemma*, is not perforated either by Capillary vessels or by Nerves; and forms, in fact, a complete barrier between the real elements of Muscular structure and the surrounding parts. The diameter of the Fibres varies greatly in different kinds of Vertebrated animals. Its average is greater in Reptiles and Fishes than in Birds and Mammals, and its extremes also are wider; thus its dimensions vary in the Frog from 1-100th to 1-1000th of an inch, and in the Skate from 1-65th to 1-300th; whilst in the Human subject the average is about 1-400th of an inch, and the extremes about 1-200th and 1-600th.

568. The elements of Muscular Fibre appear to be very minute cylindrical particles with flattened faces of nearly uniform size, adherent to each other both longitudinally and laterally. The former adhesion is usually the most powerful; and causes the

substance of the fibre, when it is broken up, to present itself in the form of delicate *fibrillæ*, each of which is composed of a single row of the primitive particles (Fig. 388). Sometimes, however, the

FIG. 388.

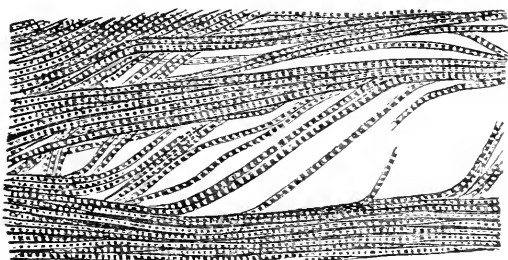
Striated *Muscular Fibre*, separating into fibrillæ.

lateral adhesion is the stronger, so that the Fibre tends to cleave transversely into disks, each of which is composed of a layer of the primitive particles arranged side by side. When the Fibrillæ are separately examined under a magnifying power of from 250 to 400 diameters, they are seen to present a cylindrical or slightly-beaded form; and they show the same alternation of light and dark spaces, as when the fibrillæ are united into fibres or into small bundles. The dark and light spaces are nearly of equal length; but each light space is usually divided by a fine dark transverse line, which, under a sufficient magnifying power, may be resolved into a row of dark points. The number of these alternations in a given length is extremely variable, and appears to depend in part upon the state of contraction or relaxation of the fibre; a converse variation showing itself in the diameter of the fibrillæ. The ordinary length of each space may be stated at about 1-17,000th of an inch, so that there would be eight or nine dark spaces, and as many light, in the length of 1-1000th of an inch; but not unfrequently there are double that number of alternations in the same length. The average diameter of the Fibrillæ seems to be tolerably uniform in different animals, being for the most part about 1-10,000th of an inch: it has been observed, however, as high as 1-5000th of an inch, and as low as 1,20,000th, even when the fibre was not put upon the stretch. In the 'anterior adductor' muscles, which draw together the valves of the shells of *Terebratulæ*, the Fibrillæ (Fig. 388), which are so easily separable that they can scarcely be bound together by a proper Sarcolemma, have a diameter of 1-7500th of an inch.

569. In the examination of Muscular Tissue, a small portion may be cut-out with the curved scissors; this should be torn up

into its component fibres ; and these, if possible, should be separated into their fibrillæ, by dissection with a pair of needles under the Simple Microscope. The general characters of the Striated Fibre are admirably shown in the large fibres of the Frog ; and by selecting a portion in which these fibres spread themselves out to unite with a broad Tendinous expansion, they may often be found so well displayed in a single layer, as not only to exhibit all their characters without any dissection, but also to show their mode of connection with the Simple Fibrous tissue of which that expansion is formed. As the ordinary characters of the Fibre are but little altered by boiling, this process may be had-recourse-to for their more ready separation, especially in the case of the Tongue. The separation of the fibres into their fibrillæ is only likely to be accomplished, in the higher Vertebrata, by repeated attempts, of which the greater number are likely to be unsuccessful ; but it may be accomplished with much greater facility in the Eel and other Fish, the tenacity of whose muscular tissue is much less. The characters of the fibrillæ are not nearly so well pronounced, however, in the Fish, as in the warm-blooded Vertebrata ; and among the latter, the Pig has been found by Mr. Lealand (who has been peculiarly successful in this class of preparations) to yield the best examples. He lays great stress on the freshness of the specimen, which should be taken from the body as soon as possible after death ; and when a successful preparation has been made, he preserves it in Goadby's solution. Dr. Beale, however, recommends Glycerine for the preparation, and Glycerine-media for the preservation, of objects of this class ; and states that the alternation of light and dark spaces in the Fibrillæ is rendered more distinct by such treatment. The Fibrillæ are often more readily separable when the Muscle has been macerated in a weak solution of Chromic Acid.—The shape of the Fibres can only be properly seen in cross sections ; and these are best made by partially drying a piece of muscle, so that very thin slices can be cut with a sharp instrument, which, on being moistened again, will resume in great part their original characters.—Striated Fibres, separable with great facility into their component Fibrillæ, are readily obtainable from the limbs of Crustacea and of Insects ; and their presence is also readily distinguishable in the bodies of Worms, even of very low organization ; so that it may be regarded as characteristic of the Articulated series generally. On the other hand, the Molluscous classes are for the most part distinguished by the non-striation of their fibre ; there are, however, two remarkable exceptions, strongly striated fibre having been found in the *Terebratula* and other *Brachiopods* (where, however, it is limited to the Adductor muscles of the shell), and also in many *Polyzoa*. Its presence seems always related to energy and rapidity of movement ; whilst the non-striated presents itself where the movements are slower and feebler in their character.

570. The 'smooth' or *Non-striated* form of Muscular fibre, which is especially found in the walls of the Stomach, Intestines, Bladder, and other similar parts, is composed of flattened bands whose diameter is usually between 1-2000th and 1-3000th of an inch; and these bands are collected into fasciculi, which do not lie parallel with each other, but cross and interlace. By macerating a portion of such Muscular substance, however, in dilute Nitric acid (about one part of ordinary acid to three parts of water) for two or three days, it is found that the bands just mentioned

may be easily separated into elongated Fusiform Cells, not unlike Woody Fibre in shape; each distinguished, for the most part, by the presence of a long staff-shaped Nucleus, brought into view by the action of Acetic acid. These cells, in which the distinction between cell-wall and cell-contents can by no means be clearly seen, are composed of a soft yellow substance often containing small pale granules, and sometimes yellow globules of fatty matter. In the coats of the Blood-vessels are found cells having the same general characters, but shorter and wider in form; and although some of these approach very closely in their general appearance to Epithelium-cells, yet they seem to have quite a different nature, being distinguished by their elongated Nuclei, as well as by their contractile endowments.

571. *Nerve-substance*.—Wherever a distinct Nervous System can be made-out, it is found to consist of two very different forms of tissue; namely, the *Cellular*, which are the essential components of the Ganglionic centres, and the *Fibrous*, of which the connecting Trunks consist. The typical form of the Nerve-Cells or 'ganglion-globules' may be regarded as globular; but they often present an extension into one or more long processes, which give them a 'caudate' or a 'stellate' aspect. These processes have been traced into continuity, in some instances, with the axis-cylinders of nerve-tubes (Fig. 390); whilst in other cases they seem to inosculate with those of other vesicles. The Cells, which do not seem to possess a definite cell-wall, are for the most part composed of a finely-granular substance, which extends into its prolongations; and in the midst of this is usually to be seen a large well-defined nucleus. They also generally contain Pigment-granules, which give them a reddish or yellowish-

FIG. 389.

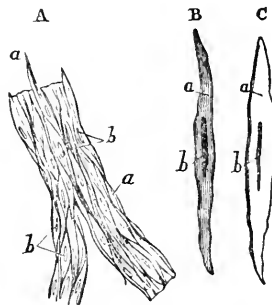

Structure of Non-striated Muscular Fibre:—A, portion of tissue showing Fusiform Cells *a, a*, with elongated Nuclei *b, b*;—B, a single cell isolated and more highly magnified;—C, a similar cell treated with acetic acid.

brown colour ; and thus impart to collections of ganglionic-cells in the warm-blooded Vertebrata that peculiar hue, which causes it to be known as the *Cineritious* or *Grey* matter ; these, however, are commonly absent among the lower Animals.—

FIG. 390.

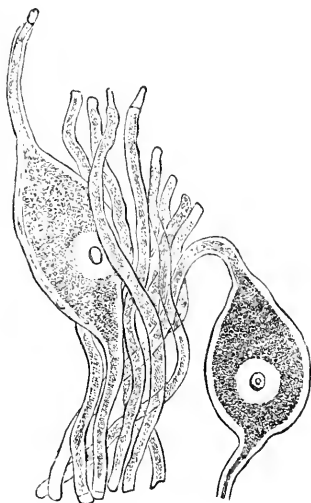

Ganglion-cells and Nerve-fibres, from a Ganglion of *Lamprey*.

Each of the Nerve-Tubes, on the other hand, of which the trunks are composed, consists, in its most completely-developed form, of a delicate membranous sheath, within which is a hollow cylinder of a material known as the 'white substance of Schwann,' whose outer and inner boundaries are marked out by two distinct lines, giving to each margin of the nerve-tube what is described as a 'double contour.' The centre or axis of the tube is occupied by a transparent substance which is known as the 'Axis-Cylinder : ' and there is reason to believe that this last, which is a Protoplasmic substance, is the *essential* component of

the Nerve-fibre, and that the hollow cylinder which surrounds it, and which is composed of a combination of Fat and Albuminous matter, serves, like the tubular sheath, for its complete isolation. The contents of the membranous envelope are very soft, yielding to slight pressure ; and they are so quickly altered by the contact of water or of any liquids which are foreign to their nature, that their characters can only be properly judged-of when they are quite fresh.—Besides the proper Tubular Fibres, however, there are others, known as 'Gelatinous,' which are considerably smaller than the preceding, and do not exhibit any differentiation of parts (Fig. 391). They are flattened, soft, and homogeneous in their appearance, and contain numerous Nuclear particles, which are brought into view by Acetic acid. They can sometimes be seen to be continuous with the axis-cylinders of the ordinary Fibres, and also with the radiating prolongations of the Ganglion-cells ; so that their Nervous character, which has been questioned by some anatomists, seems established beyond doubt.

572. The ultimate distribution of the Nerve-fibres is a subject on which there has been great divergence of opinion, and which can only be successfully investigated by observers of great experi-

ence. The Author believes that it may be stated as a general fact, that both in the Motor and the Sensory nerve-tubes, as they approach their terminations in the Muscles and in the Skin respectively, the protoplasmic axis-cylinder is continued beyond its envelopes ; and that it then breaks-up into very minute fibrillæ, which inosculate with each other so as to form a network closely resembling that formed by the pseudopodial threads of *Rhizopods* (Fig. 232). Recent observers have described the fibrillæ of Motor nerves as terminating in 'motorial end-plates' seated upon the Muscular Fibres ; and these seem analogous to the little 'islets' of sarcodic substance, into which those threads often dilate.—Where the skin is specially endowed with Tactile sensibility, we find a special Papillary apparatus, which in the Skin may be readily made out in thin vertical sections treated with solution of Soda (Fig. 392). It was formerly supposed that all the Cutaneous

FIG. 391.

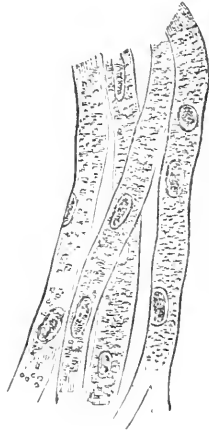

Gelatinous Nerve-fibres, from Olfactory Nerve.

Papillæ are furnished with nerve - fibres, and minister to Sensation ; but is now known that a large proportion (at any rate) of those furnished with loops of Blood-vessels (Figs. 378, *p*, 398), being destitute of Nerve-fibres, must have for their special office the production of the Epidermis ; whilst those which, possess-

FIG. 392.

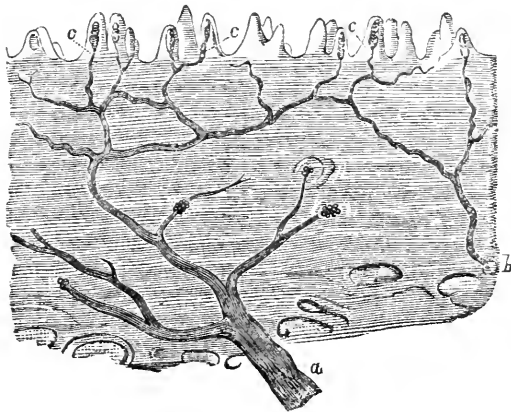

Vertical Section of the Skin of the Finger, showing the branches of the Cutaneous Nerves, *a*, *b*, inosculating to form a plexus, of which the ultimate fibres pass into the Cutaneous Papillæ, *c*, *c*.

ing Nerve-fibres, have Sensory functions, are usually destitute of Blood-vessels. The greater part of the interior of each Sensory papilla (Fig. 392, c, c) of the Skin is occupied by a peculiar 'axile body,' which seems to be merely a bundle of ordinary Connective tissue, whereon the Nerve-fibre appears to terminate. The Nerve-fibres are more readily seen, however, in the 'fungiform' papillæ of the Tongue, to each of which several of them proceed; these bodies, which are very transparent, may be well seen by snipping-off minute portions of the tongue of the Frog; or by snipping-off the papillæ themselves from the surface of the living Human tongue, which can be readily done by a dexterous use of the curved scissors, with no more pain than the prick of a pin would give. The transparency of any of these Papillæ is increased by treating them with a weak solution of Soda.

573. For the sake of obtaining a general acquaintance with the Microscopic characters of these principal forms of Nerve-substance, it is best to have recourse to minute Nerves and Ganglia. The small Nerves which are found between the Skin and the Muscles of the back of the Frog, and which become apparent when the former is being stripped-off, are extremely suitable for this purpose; but they are best seen in the *Hyla* or 'Tree-Frog,' which is recommended by Dr. Beale as being much superior to the Common Frog for the general purposes of minute Histological investigation. If it be wished to examine the natural appearance of the Nerve-fibres, no other fluid should be used than a little Blood-serum; but if they be treated with strong Acetic acid, a contraction of their tubes takes-place, by which the axis-cylinder is forced-out from their cut extremities, so as to be made more apparent than it can be in any other way. On the other hand, by immersion of the tissue in a dilute solution of Chromic acid (about one part of the solid crystals to two hundred of water), the Nerve-fibres are rendered firmer and more distinct. Again, the Axis-cylinders are brought into distinct view by the Staining-process (§ 145), being dyed much more quickly than their envelopes; and they may thus be readily made-out by reflected light, in transverse sections of Nerves that have been thus treated.* The *Gelatinous* fibres are found in the greatest abundance in the Sympathetic nerves; and their characters may be best studied in the smaller branches of that system.—So, for the examination of the Ganglionic cells, and of their relation to the Nerve-tubes, it is better to take some minute Ganglion as a whole (such as one of the Sympathetic ganglia of the Frog, Mouse, or other small animal), than to dissect the larger ganglionic masses, whose structure can only be successfully studied by such as are proficient in this kind of investigation. The Nerves of the orbit of the Eyes of Fishes, with the Ophthalmic Ganglion and its branches, which may be very readily got-at in the Skate, and of which

* See Prof. Lister's 'Observations on the Structure of Nerve-fibres,' in "Quart. Journ. of Microsc. Science," Vol. viii. (1860), p. 29.

the components may be separated without much difficulty, form one of the most convenient objects for the demonstration of the principal forms of Nerve-tissue, and especially for the connection of Nerve-fibres and Ganglion-cells.—For these minute inquiries, however, into the ultimate distribution of the Nerve-fibres in Muscles and Organs of Sense, certain special methods must be followed, and very high magnifying powers must be employed. As this very difficult investigation has been prosecuted by Dr. Beale with more success (in the Author's opinion) than by any other Anatomist, either British or Continental, and as his methods ought to be carefully studied and followed by any one who either desires to verify, or feels disposed to contest, his results, the Author would refer to Dr. Beale's own Treatise, in which these methods and results are fully set forth, such of his Readers as desire further information upon this subject.*

574. *Circulation of the Blood.*—One of the most interesting spectacles that the Microscopist can enjoy, is that which is furnished by the Circulation of the Blood in the Capillary blood-vessels, which distribute the fluid through the tissues it nourishes. This, of course, can only be observed in such parts of Animal bodies as are sufficiently thin and transparent to allow of the transmission of light through them, without any disturbance of their ordinary structure; and the number of these is very limited. The web of the Frog's foot is perhaps the most suitable for ordinary purposes, more especially since this animal is to be easily obtained in almost every locality; and the following is the arrangement which the Author has found most convenient for the purpose. A piece of thin Cork is to be obtained, about 9 inches long and 3 inches wide (such pieces are prepared by Cork-cutters, as soles), and a hole about $\frac{3}{8}$ ths of an inch in diameter is to be cut at about the middle of its length, in such a position that, when the cork is secured upon the Stage, this aperture may correspond with the axis of the Microscope. The body of the Frog is then to be folded in a piece of wet calico, one leg being left free, in such a manner as to confine its movements, but not to press too tightly upon its body; and being then laid down near one end of the cork plate, the free leg is to be extended, so that the foot can be laid over the central aperture. The spreading-out of the foot over the aperture is to be accomplished, either by passing pins through the edge of the web into the cork beneath, or by tying the ends of the toes with threads to pins stuck into the cork at a small distance from the aperture; the former method is by far the least troublesome, and it may be doubted whether it is really the source of more

* See his Treatise "How to Work with the Microscope," 4th Ed. (1868), pp. 290-304, and pp. 330-339.—The method recommended by Mr. J. Lockhart Clarke for making Transparent Sections of the Spinal Cord, will be found in his 'Observations on the Structure of Nerve-Fibre' in the "Quart. Journ. of Microsc. Science," Vol. viii. (1860), p. 66.

suffering to the animal than the latter, the confinement being obviously that which is most felt. A few turns of tape, carried *loosely* around the calico bag, the projecting leg, and the cork, serve to prevent any sudden start; and when all is secure, the Cork-plate is to be laid-down upon the Stage of the Microscope, where a few more turns of the tape will serve to keep it in place. The web being moistened with water (a precaution which should be repeated as often as the membrane exhibits the least appearance of dryness), and an adequate light being reflected through the web from the mirror, this wonderful spectacle is brought into view on the adjustment of the focus (a power of from 75 to 100 diameters being the most suitable for ordinary purposes), provided that no obstacle to the movement of the Blood be produced by undue pressure upon the body or leg of the animal. It will not unfrequently be found, however, that the current of Blood is nearly or altogether stagnant for a time; this seems occasionally due to the animal's alarm at its new position, which weakens or suspends the action of its Heart, the movement recommencing again after the lapse of a few minutes, although no change has been made in any of the external conditions. But if the movement should not renew itself, the tape which passes over the body should be slackened; and if this does not produce the desired effect, the calico envelope must also be loosened. When everything has once been properly adjusted, the animal will often lie for hours without moving, or will only give an occasional twitch. Even this may be avoided by previously subjecting the animal to the influence of Chloroform; and this may be renewed from time to time whilst it is under observation. The movement of the Blood will be distinctly seen by that of its Corpuscles (§ 555), which course after one another through the network of Capillaries that intervenes between the smallest Arteries and the smallest Veins: in those tubes which pass most directly from the veins to the arteries, the current is always in the same direction; but in those which pass-across between these, it may not unfrequently be seen that the direction of the movement changes from time to time. The larger vessels (Fig. 393), with which the capillaries are seen to be connected, are almost always *Veins*, as may be known from the direction of the flow of blood in them from the branches (*b, b*) towards their trunks (*a*); the *Arteries*, whose ultimate subdivisions discharge themselves into the capillary network, are for the most part restricted to the immediate borders of the toes. When a power of 200 or 250 diameters is employed, the visible area is of course greatly reduced; but the individual vessels and their contents are much more plainly seen; and it may then be observed that whilst the Red corpuscles (§ 555) flow at a very rapid rate along the centre of each tube, the Colourless corpuscles (§ 556) which are occasionally discernible, move slowly in the clear stream near its margin.

575. The Circulation may also be displayed in the *Tongue* of the Frog, by laying the animal down on its back, with its head close to the hole in the cork-plate, and, after securing the body in this

FIG. 393.

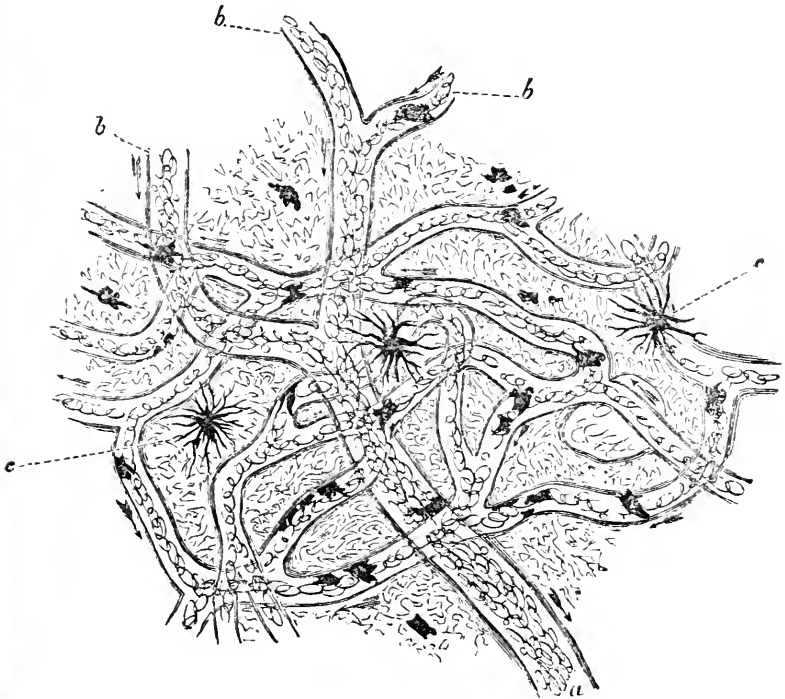

Capillary Circulation in a portion of the web of a *Frog's* foot : *a*, trunk of Vein ; *b*, *b*, its branches ; *c*, *c*, Pigment-cells.

position, drawing-out the tongue with the forceps, and fixing it on the other side of the hole with pins. This method, however, is so much more distressing to the animal, that its employment seems scarcely justifiable for the mere purpose of display : while nothing but some anticipated benefit to science can justify the laying-open of the body of the living animal, for the purpose of examining the circulation in its Lungs or Mesentery. The *Tadpole* of the Frog, when sufficiently young, furnishes a good display of the Capillary circulation in its tail ; and the difficulty of keeping it quiet during the observation may be overcome by gradually mixing some warm water with that in which it is swimming, until it becomes motion-

less; this usually happens when it has been raised to a temperature between 100° and 110° ; and notwithstanding that the muscles of the body are thrown into a state of spasmodic rigidity by this treatment, the heart continues to pulsate, and the circulation is maintained.*—The *Larva of the Water-Neut*, when it can be obtained, furnishes a most beautiful display of the Circulation, both in its external gills and in its delicate feet. It may be enclosed in a large Aquatic-box or in a shallow Cell, gentle pressure being made upon its body so as to impede its movements without stopping the heart's action.—The Circulation may also be seen in the tails of small Fish, such as the *Minnow* or the *Stickleback*, by confining these animals in tubes, or in shallow cells, or in a large Aquatic-box;† but although the extreme transparency of these parts adapts them well for this purpose in one respect, yet the comparative scantiness of their blood-vessels prevents them from being as suitable as the Frog's web in another not less important particular.—One of the most beautiful of all displays of the Circulation, however, is that which may be seen upon the *Yolk-bag* of young Fish (such as the Salmon or Trout) soon after they have been hatched; and as it is their habit to remain almost entirely motionless at this stage of their existence, the observation can be made with the greatest facility by means of the Zoophyte-trough, provided that the subject of it can be obtained. Now that the artificial breeding of these Fish is largely practised for the sake of stocking rivers and fish-ponds, there can seldom be much difficulty in procuring specimens at the proper period. The store of yolk which the yolk-bag supplies for the nutrition of the embryo, not being exhausted in the Fish (as it is in the Bird), previously to the hatching of the egg, this bag hangs-down from the belly of the little creature on its emersion; and continues to do so until its contents have been absorbed into the body, which does not happen for some little time afterwards. And the Blood is distributed over it in copious streams, partly that it may draw into itself fresh nutritive material, and partly that it may be subjected to the aerating influence of the surrounding water.

576. The Tadpole serves, moreover, for the display, under proper management, not only of the Capillary but of the *general* Circulation; and if this be studied under the Binocular Microscope, the observer not only enjoys the gratification of witnessing a most wonderful spectacle, but may also obtain a more accurate notion of the relations of the different parts of the Circulating System than was previously possible.‡ The Tadpole, as every Naturalist is

* A special form of Live-box for the observation of living Tadpoles, &c., contrived by F. E. Schultze, of Rostock, is described and figured in the "Quart. Journ. of Microsc. Science," N.S., Vol. vii. (1867), p. 261.

† A convenient Trough for this purpose is described in the "Quart. Journ. of Microsc. Science," Vol. vii. (1859), p. 113.

‡ See Mr. Whitney's account of 'The Circulation in the Tadpole,' in

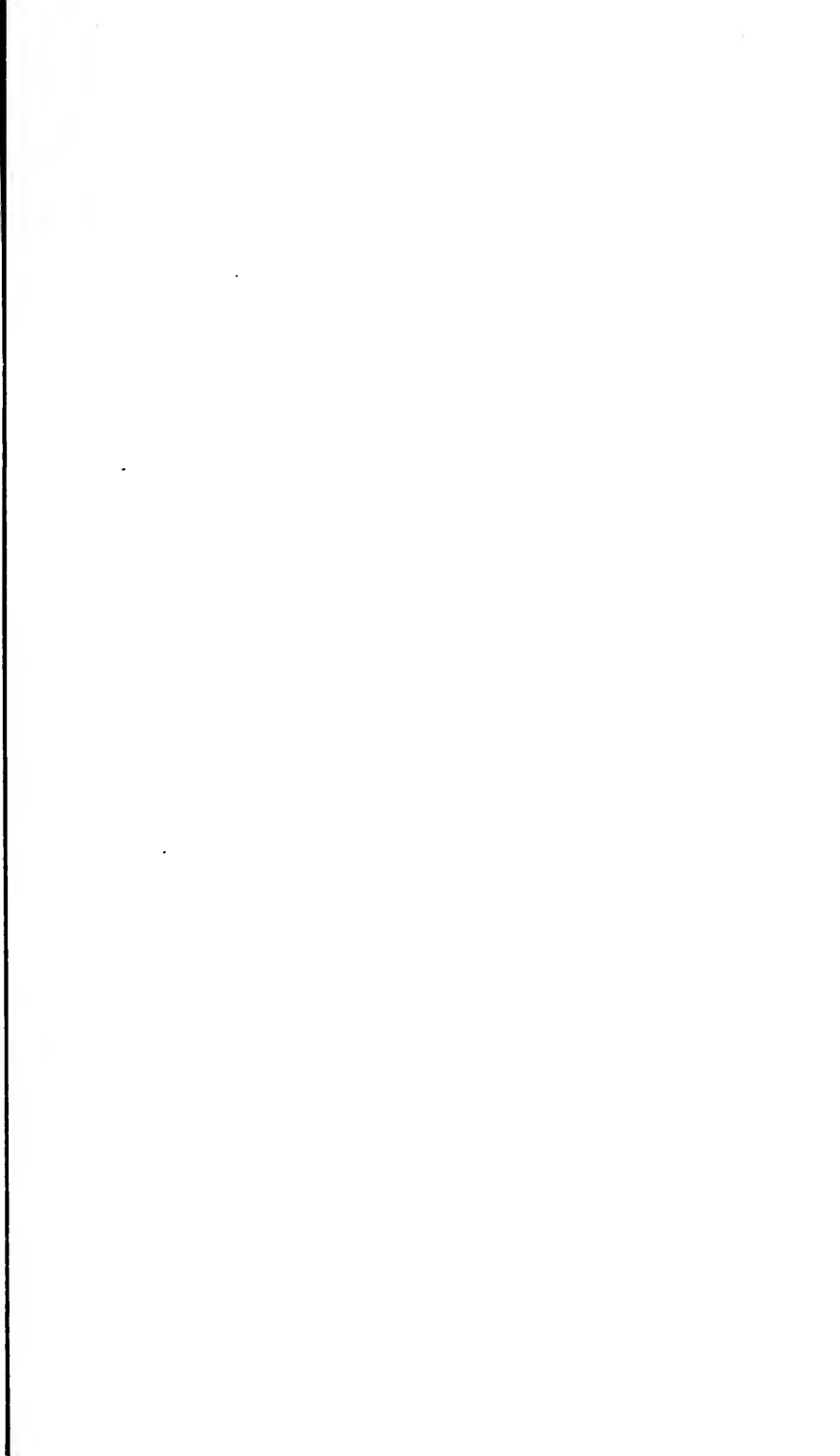

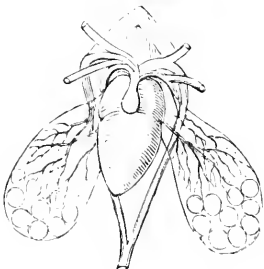
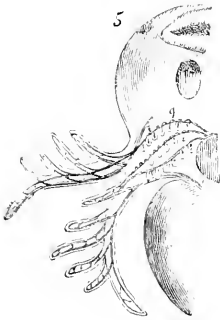
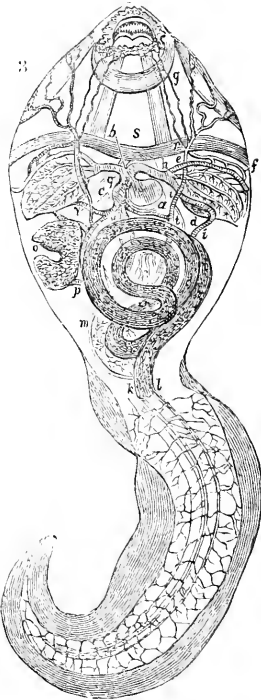
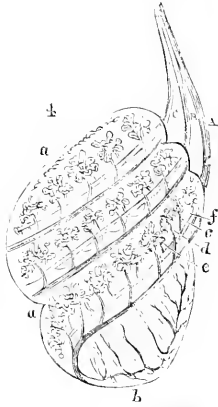
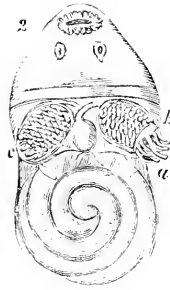

6

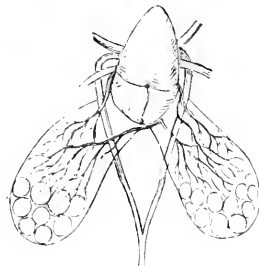

CIRCULATION IN TADPOLE.

[To face p. 737.]

aware, is essentially a Fish in the early period of its existence, breathing by Gills alone, and having its Circulating apparatus arranged accordingly : but as its limbs are developed and its tail becomes relatively shortened, its Lungs are gradually evolved in preparation for its terrestrial life, and the course of the blood is considerably changed. In the Tadpole as it comes forth from the egg, the Gills are *external*, forming a pair of fringes hanging at the sides of the head (Plate XXIV., fig. 1); and at the bases of these, concealed by Opercula or gill-flaps resembling those of Fishes, are seen the rudiments of the *internal* Gills, which soon begin to be developed in the stead of the preceding. The *external* gills reach their highest development on the fourth or fifth day after emersion ; and they then wither so rapidly, whilst at the same time being drawn-in by the growth of the animal, that by the end of the first week only a remnant of the right gill can be seen under the edge of the operculum (fig. 2, *e*), though the left gill (*b*) is somewhat later in its disappearance. Concurrently with this change, the *internal* gills are undergoing rapid development ; and the beautiful arrangement of their vascular tufts, which originate from the roots of the Arteries of the external gills, as seen at *g*, fig. 5, is shown in fig. 4. It is requisite that the Tadpole subjected to observation should not be so far advanced as to have lost its early transparence of skin ; and it is further essential to the tracing out the course of the Abdominal vessels, that the creature should have been kept without food for some days, so that the intestine may empty itself. This starving process reduces the quantity of Red corpuscles, and thus renders the Blood paler ; but this, although it makes the smaller branches less obvious, brings the circulation in the larger trunks into more distinct view. "Placing the Tadpole on his back," says Mr. Whitney, "we look, as through a pane of glass, into the chamber of the chest. Before us is the beating heart, a bulbous-looking cavity, formed of the most delicate transparent tissues, through which are seen the globules of the blood, perpetually, but alternately, entering by one orifice and leaving it by another. The Heart (Plate XXIV., fig. 3, *a*) appears to be slung, as it were, between two arms or branches, extending right and left. From these trunks (*b*) the main Arteries arise. The Heart is enclosed within an envelope or Pericardium (*c*), which is, perhaps, the most delicate, and is, certainly, the most elegant beauty in the creature's organism. Its extreme fineness makes it often elude the eye under the Single Microscope, but under the Binocular its form is distinctly revealed. Then it is seen as a canopy or tent, enclosing the heart, but of such

"Transact. of Microsc. Soc." N.S., Vol. x. (1862), p. 1, and his subsequent Paper 'On the Changes which accompany the Metamorphosis of the Tadpole' in the same Transactions. Vol. xv. p. 43.—In the first of these Memoirs, Mr. W. described the Internal Gills as Lungs ; an error which he corrected in the second.

extreme tenuity that its *folds* are really the means by which its existence is recognized. Passing along the course of the great vessels to the right and left of the heart, the eye is arrested by a large oval body (*d*) of a more complicated structure and dazzling appearance. This is the Internal Gill, which, in the Tadpole, is a cavity formed of most delicate transparent tissue, traversed by certain arteries, and lined by a crimson network of blood-vessels, the interlacing of which, with their rapid currents and dancing globules, forms one of the most beautiful and dazzling exhibitions of vitality." Of the three great arterial trunks which arise on each side from the *Truncus Arteriosus*, *b*, the first or Cephalic, *e*, is distributed entirely to the head, running first along the upper edge of the gill, and giving off a branch, *f*, to the thick fringed lip which surrounds the mouth, after which it suddenly curves upwards and backwards, so as to reach the upper surface of the head, where it dips between the eye and the brain. The second main trunk, *h*, seems to be chiefly distributed to the gill, although it freely communicates by a network of vessels both with the first or cephalic and with the third or abdominal trunk. The latter also enters the gill and gives off branches; but it continues its course as a large trunk, bending downwards and curving towards the spine, where it meets its fellow to form the Abdominal Aorta, *i*, which, after giving-off branches to the abdominal viscera, is continued as the Caudal Artery, *k*, to the extremity of the tail. The blood is returned from the tail by the Caudal Vein, *l*, which is gradually increased in size by its successive tributaries as it passes towards the abdominal cavity; here it approaches the Kidney, *m*, and sends off a branch which encloses that organ on one side, while the main trunk continues its course on the other, receiving tributaries from the kidney as it passes. (This supply of the kidney by *venous* blood is a peculiarity of the lower Vertebrata). The venous blood returned from the abdominal viscera, on the other hand, is collected into a trunk, *p*, known as the Portal Vein, which distributes it through the substance of the Liver, *o*, as in Man; and after traversing that organ it is discharged by numerous fine channels, which converge towards the great abdominal trunk, or Vena Cava, *n*, as it passes in close proximity to the liver, onwards to the *Sinus Venosus*, *q*, or rudimentary auricle of the heart. This also receives the Jugular Vein, *r*, from the head, which first, however, passes downwards in front of the gill close to its inner edge, and meets a vein, *t*, coming up from the abdomen, after which it turns abruptly in the direction of the heart. Two other Abdominal veins, *u*, meet and pour their blood direct into the Sinus Venosus; and into this cavity also is poured the aerated blood returned from the gill by the Branchial Vein, *v*, of which only the one on the right side can be distinguished.—The Lungs may be detected in a rudimentary state, even in the very young Tadpole; being in that stage a pair of minute tubular sacs, united at their upper extremities, and lying

behind the intestine and close to the spine. They may be best brought into view by immersing the Tadpole for a few days in a weak solution of Chromic acid, which renders the tissues friable, so that the parts that conceal them may be more readily peeled away. Their gradual enlargement may be traced during the period of the Tadpole's transparency; but they can only be brought into view by dissection, when the metamorphosis has been completed. The following are Mr. Whitney's directions for displaying the Circulation in these organs:—"Put the young Frog into a wine-glass, and drop on him a single drop of Chloroform. This suffices to extinguish sensibility. Then lay him on the back on a piece of cork, and fix him with small pins passed through the web of each foot. Remove the skin of the abdomen with a fine pair of sharp scissors and forceps. Turn aside the intestines from the *left* side, and thus expose the left lung, which may now be seen as a glistening transparent sac, containing air-bubbles. With a fine camel-hair pencil the lung may now be turned-out, so as to enable the operator to see a large part of it by *transmitted* light. Unpin the Frog, and place him on a slip of glass, and then transmit the light through the everted portion of lung. Remember that the lung is very elastic, and is emptied and collapsed by very slight pressure. Therefore, to succeed with this experiment, the lung should be touched as little as possible, and in the lightest manner, with the brush. If the Heart is acting feebly, you will see simply a transparent sac, shaped according to the quantity of air-bubbles it may happen to contain, but void of red vascularity and circulation. But should the operator succeed in getting the Lung well placed, full of air, and have the Heart still beating vigorously, he will see before him a brilliant picture of crimson network, alive with the dance and dazzle of blood-globules, in rapid chase of one another through the delicate and living lace-work which lines the chamber of the lung." The position of the Lungs in relation to the Heart and the great Vascular trunks, is shown in Plate xxiv., fig. 6.

577. *Injected Preparations.*—Next to the Circulation of the Blood in the living body, the varied distribution of the Capillaries in its several organs, as shown by means of 'Injections' of colouring matter thrown into their principal vessels, is one of the most interesting subjects of Microscopic examination. The art of making successful preparations of this kind is one in which perfection can usually be attained only by long practice, and by attention to a great number of minute particulars; and better specimens may be obtained, therefore, from those who have made it a business to prepare them, than are likely to be prepared by amateurs for themselves. For this reason, no more than a general account of the process will be here offered; the minute details which need to be attended-to, in order to attain successful results, being readily

accessible elsewhere to such as desire to put it in practice.* Injections may be either *Opaque* or *Transparent*, each method having its special advantages. The former is most suitable where *solid form* and *inequalities of surface* are specially to be displayed, as in Figs. 394 and 400; the latter is preferable where the injected tissue is so thin as to be transparent (as in the case of the Retina and other membranes of the Eye), or where the distribution of its blood-vessels and their relations to other parts may be displayed by Sections thin enough to be made transparent by mounting either in Canada balsam or in Glycerine medium (Plate xxv.).—The Injection is usually thrown into the vessels by means of a Brass Syringe expressly constructed for the purpose, which has several jet-pipes of different sizes, adapted to the different dimensions of the vessels to be injected; and these should either be furnished with a stopcock to prevent the return of the injection when the syringe is withdrawn, or a set of small corks of different sizes should be kept in readiness, with which they may be plugged. The pipe should be inserted into the cut end of the trunk which is to be injected, and should be tied therein by a silk thread. In injecting the vessels of Fish, Mollusks, &c., the softness of the vessels renders them liable to break in the attempt to tie them; and it is therefore better for the operator to satisfy himself with introducing a pipe as large as he can insert, and with passing it into the vessel as far as he can without violence. All the vessels from which the injection might escape should be tied, and sometimes it is better to put a ligature round a part of the organ or tissue itself; thus, for example, when a portion of the Intestinal tube is to be injected through its branch of the Mesenteric artery, not only should ligatures be put round any divided vessels of the mesentery, but the cut ends of the intestinal tube should be firmly tied.—For making those minute Injections, however, which are needed for the purposes of Anatomical investigation, rather than to furnish ‘Preparations’ to be looked-at, the Author has found the Glass-Syringe (Fig. 83), so frequently alluded-to, the most efficient instrument; since the Microscopist can himself draw its point to the utmost fineness that will admit of the passage of the injection, and can push this point without ligature, under the Simple Microscope, into the narrowest orifice, or into the substance of the part into which the injection is to be thrown.—Save in the cases in which the operation has to be practised on living animals, it should either be performed when the body or organ is as fresh as possible, or after the expiry of sufficient time to allow the *rigor mortis* to

* See especially the article ‘Injection,’ in the “Micrographic Dictionary;” M. Robin’s work, “Du Microscope et des Injections” (Paris, 1844); Prof. H. Frey’s Treatise “Das Mikroskop und die Mikroskopische Technik,” 2nd Edition (1865); and Dr. Beale’s “How to Work with the Microscope,” 4th Edition (1868).

pass-off, the presence of this being very inimical to the success of the injection. The part should be thoroughly warmed, by soaking in warm water for a time proportionate to its bulk; and the Injection, the Syringe, and the pipes should also have been subjected to a temperature sufficiently high to ensure the free flow of the liquid. The force used in pressing-down the piston should be very moderate at first; but should be gradually increased as the vessels become filled, and it is better to keep-up a steady pressure for some time, than to attempt to distend them by a more powerful pressure, which will be certain to cause extravasation. This pressure should be maintained* until the injection begins to flow from the large veins, and the tissue is thoroughly reddened; and if one syringe-ful of injection after another be required for this purpose, the return of the injection should be prevented by stopping the nozzle of the jet-pipe when the syringe is removed for re-filling. When the injection has been completed, any openings by which it can escape should be secured, and the preparation should then be placed for some hours in cold water, for the sake of causing the Size to 'set.†

578. For Opaque Injections, the best colouring-matter, when only one set of vessels is to be injected, is Chinese Vermilion. This, however, as commonly sold, contains numerous particles of far too large a size; and it is necessary first to reduce it to a greater fineness by continued trituration in a mortar (an agate or a steel mortar is the best) with a small quantity of water, and then to get-rid of the larger particles by a process of 'levigation,' exactly corresponding to that by which the particles of coarse sand, &c., are separated from the Diatomaceæ (§ 237). The fine powder thus obtained, ought not, when examined under a magnifying power of 200 diameters, to exhibit particles of any appreciable dimensions. The Size or Gelatine should be of a fine and pure quality, and should be of sufficient strength to form a tolerably firm jelly when cold, whilst quite limpid when warm. It should be strained, whilst hot, through a piece of new flannel; and great care should be taken to preserve it free from dust, which may best be done by putting it into clean jars, and covering its surface with a thin layer of alcohol. The proportion of levigated Vermilion to be mixed with it for injection, is about 2 oz. to a pint; and this is to be stirred in the melted Size, until the two are thoroughly

* A simple mechanical arrangement for this purpose, by which the fatigue of maintaining this pressure with his hand is saved to the operator, is described in the "Micrographic Dictionary," 2nd Edit., p. 383.

† The Kidney of a Sheep or Pig is a very advantageous organ for the learner to practise-on; and he should first master the filling of the vessels from the arterial trunk alone, and then, when he has succeeded in this, he should fill the tubuli uriniferi with white injection, before sending coloured injection into the renal artery. The entire Systemic Circulation of small animals, as Mice, Rats, Frogs, &c., may be injected from the Aorta; and the Pulmonary vessels from the Pulmonary Artery.

incorporated, after which the mixture should be strained through muslin.—Although no Injections look so well by reflected light as those which are made with Vermilion, yet other colouring substances may be advantageously employed for particular purposes. Thus a bright *Yellow* is given by the yellow Chromate of Lead, which is precipitated when a solution of Acetate of Lead is mixed with a solution of Chromate of Potass; this is an extremely fine powder, which ‘runs’ with great facility in an injection, and has the advantage of being very cheaply prepared. The best method of obtaining it is to dissolve 200 grains of Acetate of Lead and 105 grains of Chromate of Potass in separate quantities of water, to mix these, and then, after the subsidence of the precipitate, to pour-off the supernatant fluid so as to get-rid of the Acetate of Potash which it contains, since this is apt to corrode the walls of the vessels if the preparation be kept moist. The solutions should be mixed cold, and the precipitate should not be allowed to dry before being incorporated with the Size, four ounces of which will be the proportion appropriate to the quantity of the colouring-substance produced by the above process. The same materials may be used in such a manner that the decomposition takes-place within the vessels themselves, one of the solutions being thrown-in first, and then the other; and this process involves so little trouble or expense, that it may be considered the best for those who are novices in the operation, and who are desirous of perfecting themselves in the practice of the easier methods, before attempting the more costly. By M. Doyère, who first devised this method, it was simply recommended to throw-in saturated solutions of the two salts, one after the other; but Dr. Goadby, who had much experience in the use of it, advised that Gelatine should be employed, in the proportion of 2 oz. dissolved in 8 oz. of water, to 8 oz. of the saturated solutions of each Salt. This method answers very well for the preparations that are to be mounted dry; but for such as are to be preserved in fluid, it is subject to the disadvantage of retaining in the vessels the solution of Acetate of Potash, which exerts a gradual corrosive action upon them. Dr. Goadby has met this objection, however, by suggesting the substitution of Nitrate for Acetate of Lead; the resulting Nitrate of Potash having rather a preservative than a corrosive action on the vessels.—When it is desired to inject two or more sets of vessels (as the Arteries, Veins, and Gland-ducts) of the same preparation, different colouring substances should be employed. For a *white* injection, the Carbonate of Lead (prepared by mixing solutions of Acetate of Lead and Carbonate of Soda, and pouring-off the supernatant liquid when the precipitate has fallen) is the best material. No *blue* injections can be much recommended, as they do not reflect light well, so that the vessels filled with them seem almost black; the best is freshly precipitated Prussian Blue (formed by mixing solutions of Persulphate of Iron and Ferrocyanide of Potassium), which, to avoid the

alteration of its colour by the free alkali of the blood, should be triturated with its own weight of Oxalic acid and a little water, and the mixture should then be combined with Size, in the proportion of 146 grains of the former to 4 oz. of the latter.

579. Opaque Injections may be preserved either dry or in fluid. The former method is well suited to sections of many solid organs, in which the disposition of the vessels does not sustain much alteration by drying; for the colours of the vessels are displayed with greater brilliancy than by any other method, when such slices, after being well dried, are moistened with Turpentine and mounted in Canada balsam. But for such an Injection as that shown in Fig. 394, in which the form and disposition of the Intestinal *Villi* would be completely altered by drying, it is indispensable that the preparation should be mounted in fluid, in a Cell deep enough to prevent any pressure on its surface. Either Goadby's solution or weak Spirit answers the purpose very well; or by careful management even such may be mounted in Canada balsam (§ 160).

580. Within the last few years, the art of making Transparent Injections has been much cultivated, especially in Germany; and beautiful preparations of this description have been sent

over from that country in large numbers. The colouring-matter chiefly employed is Carmine, which is dissolved in liquid Ammonia; the solution (after careful filtration) being added in the requisite amount to liquid Gelatine. The following is given by Dr. Carter as a formula for a Carmine Injection which will run freely through the most minute capillaries, and which will not tint the tissues beyond the vessels themselves, a point of much importance:—Dissolve 60 grains of pure Carmine in 120 grains of Strong Liquor Ammonia (Pharm. Brit.), and filter if necessary; with this mix thoroughly $1\frac{1}{2}$ oz. of a hot solution of Gelatine (1 to 6 of Water); mix another $\frac{1}{2}$ oz. of the Gelatine Solution with 86 minims of Glacial Acetic Acid; and drop this, little by little, into the solution of Carmine, stirring briskly the whole time. After the part has been injected, and has been hardened either by partial drying

FIG. 394.

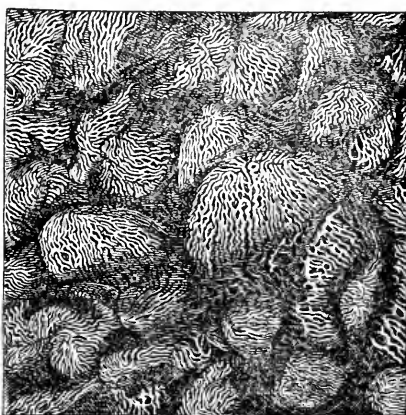
*Villi* of Small Intestine of Monkey.

or by immersion in the Chromic acid solution or in Alcohol, thin sections are cut with a sharp razor; and these are usually dried and mounted in Canada balsam. Many of these Transparent Injections (Plate XXV.) are peculiarly well seen under the Binocular Microscope; which shows the Capillary network not only in two dimensions (length and breadth), but also in its third dimension, that of its thickness. This is especially interesting in the case of injections of the Nervous Centres. The Stereoscopic effect is best seen, if the light reflected through the object be moderated by a ground-glass or even by a piece of tissue-paper placed behind it.—This method, however, does not serve to display anything *well*, save the distribution of the Capillary vessels; the structures which they traverse being so imperfectly shown, that little light is thrown on the relations of the two. For the purpose of scientific research, therefore, the method followed by Dr. Beale (for full details of which the reader is referred to his Treatise) is much to be preferred. The material recommended by him for the finest Injections is prepared as follows:—Mix 10 drops of the Tincture of Perchloride of Iron (Pharm. Brit.) with 1 oz. of Glycerine; and mix 3 grains of Ferrocyanide of Potassium, previously dissolved in a little Water, with another 1 oz. of Glycerine. Add the first solution very gradually to the second, shaking them well together; and lastly, add 1 oz. of Water, and 3 drops of strong Hydrochloric acid. This “Prussian Blue Fluid” is not a solution, the precipitate being only suspended in it; but it does not deposit the slightest sediment, even when kept for some time; and it appears like a solution even when examined under high magnifying powers, in consequence of the minuteness of the particles of the colouring matter. Where a second colour is required, a Carmine injection may be used, which is to be prepared as follows:—Mix 5 grains of Carmine with a few drops of Water, and, when they are well incorporated, add about 5 drops of Strong Liquor Ammonie. To this dark red solution add about $\frac{1}{2}$ oz. of Glycerine, shaking the bottle so as to mix the two fluids thoroughly; and then very gradually pour in another $\frac{1}{2}$ oz. of Glycerine acidulated with 8 or 10 drops of Acetic or Hydrochloric acid, frequently shaking the bottle. Test the mixture with blue Litmus paper; and mix with it another $\frac{1}{2}$ oz. of Glycerine, to which a few drops more Acid should be added, if the acid reaction of the liquid should not have previously been decided. Finally, add gradually 2 drachms of Alcohol previously well mixed with 6 drachms of Water, and incorporate the whole by thorough shaking after the addition of each successive portion.—The *Staining Process* (§ 145) may be combined with the Injecting; but Dr. Beale has now come to prefer the following method, when such a combination is desired. An Alkaline Carmine fluid rather stronger than that ordinarily employed (Carmine, 15 grs., Strong Liq. Ammon., $\frac{1}{2}$ drachm, Glycerine, 2 oz., Alcohol, 6 drachms) is first to be injected carefully

PLATE XXV.

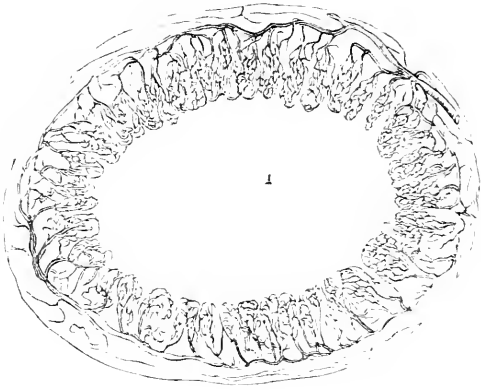

DISTRIBUTION OF CAPILLARIES.

[To face p. 744.]

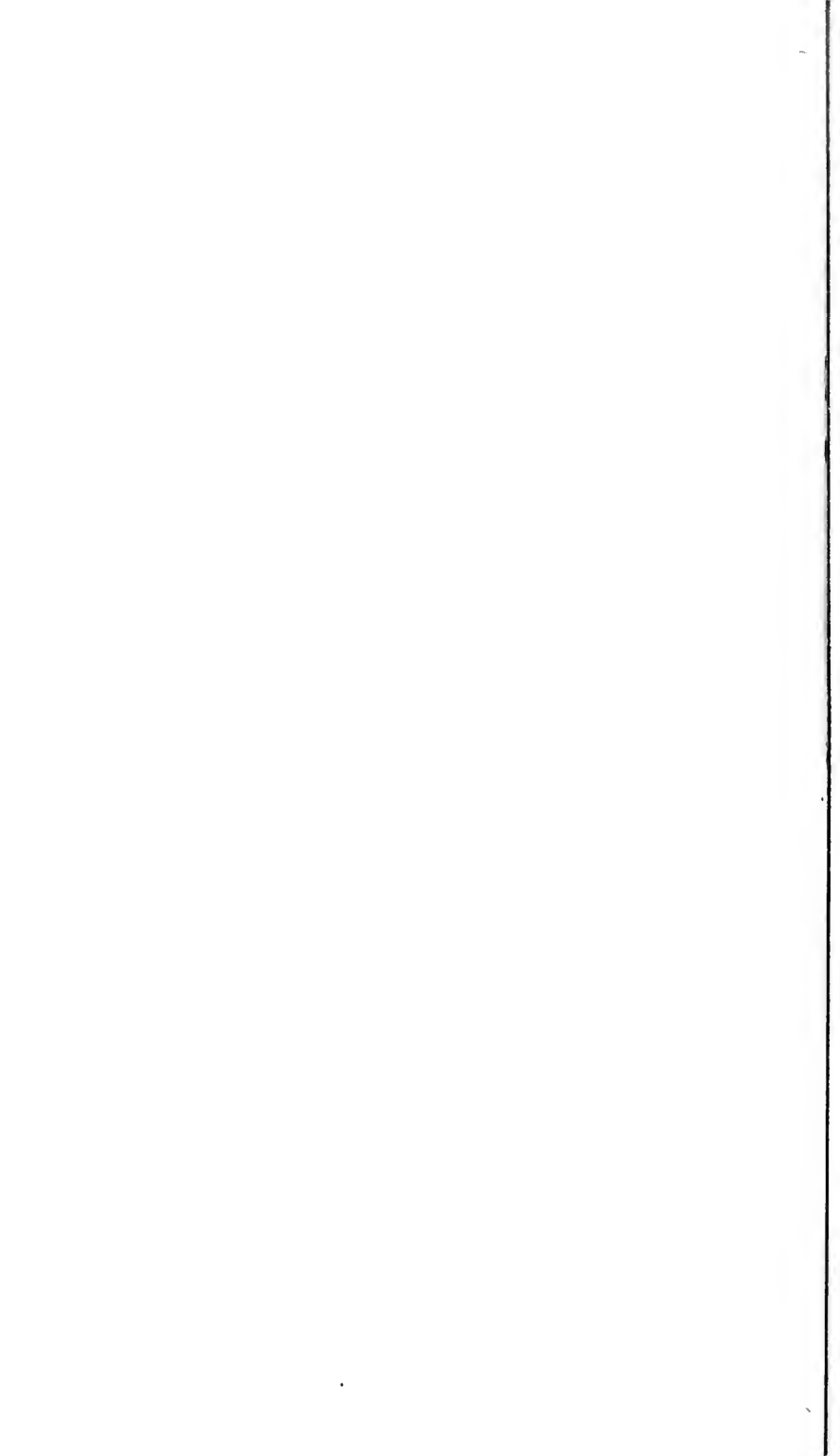

with very slight pressure ; the Ammonia having a tendency to soften the walls of the vessels. When they are fully distended, the preparation is to be left for from 12 to 24 hours, in order that time may be allowed for the Carmine liquid which has permeated the Capillaries, to soak through the different tissues and stain the germinal matters fully. Next a little pure Glycerine is to be injected, to get rid of the Carmine liquid ; and the Prussian Blue fluid is then to be injected with the utmost care. When the vessels have been fully distended, the injected preparation is to be divided into very small pieces : and these are to be soaked for an hour or two in a mixture of 2 parts of Glycerine and 1 of Water, and then for three or four days in strong Glycerine acidulated with Acetic Acid (5 drops to 1 oz.). Preparations thus made are best mounted in Glycerine Jelly ; and may then be examined with the highest powers of the Microscope.

581. A well-injected preparation should have its vessels completely filled through every part ; the particles of the colouring matter should be so closely compacted together, that they should not be distinguishable unless carefully looked-for ; and there should be no patches of pale uninjected tissue. Still, although the beauty of a specimen as a Microscopic object is much impaired by a deficiency in the filling of its vessels, yet to the Anatomist the disposition of the vessels will be as apparent when they are only filled in part, as it is when they are fully distended ; and imperfectly injected Capillaries may often be better seen in thin sections mounted as Transparent objects, than such as have been completely filled.

582. A relation may generally be traced between the disposition of the Capillary Vessels, and the functions they are destined to subserve ; but that relation is obviously (so to speak) of a mechanical kind ; the arrangement of the vessels not in any way determining the function, but merely administering to it, like the arrangement of water or gas-pipes in a manufactory. Thus in Fig. 395 we see that the Capillaries of Adipose substance are disposed in a

FIG. 395.

Capillary network around *Fat-cells*.

FIG. 396.

Capillary network of *Muscle*.

network with rounded meshes, so as to distribute the blood among the Fat-cells (§ 564) ; whilst in Fig. 396 we see the meshes enormously elongated, so as to permit the Muscular Fibres (§ 567) to lie in them. Again, in Fig. 397 we observe the disposition of the

FIG. 397.

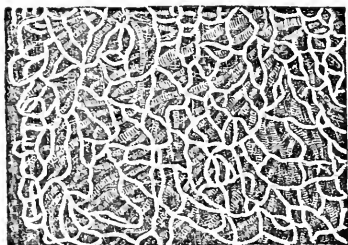
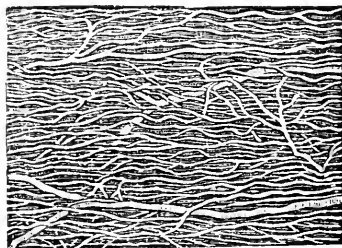
Distribution of Capillaries
in *Mucous Membrane*.

FIG. 398.

Distribution of Capillaries
in *Skin of Finger*.

Capillaries around the orifices of the Follicles of a Mucous membrane ; whilst in Fig. 398 we see the looped arrangement which exists in the Papillary surface of the Skin, and which is subservient to the nutrition of the Epidermis and to the activity of the Sensory Nerves (§ 572).

583. In no part of the Circulating apparatus, however, does the disposition of the Capillaries present more points of interest than it does in the Respiratory organs. In *Fishes* the respiratory surface is formed by an outward extension into fringes of *Gills*, each of which consists of an arch with straight laminae hanging down from it ; and every one of these laminae (Fig. 399) is furnished with a double row of leaflets, which is most minutely supplied with blood-vessels, their network (as seen at A) being so close that its meshes (indicated by the dots in the figure) cover less space than the vessels themselves. The Gills of Fish are not ciliated on their surface, like those of Mollusks and of the larva of the Water-Newt ; the necessity for such a mode of renewing the fluid in contact with them being superseded by the Muscular apparatus with which their gill-chamber is furnished.—But in *Reptiles* the Respiratory surface is formed by the walls of an internal cavity, that of the *Lungs*: these organs, however, are constructed on a plan very different from that which they present in higher Vertebrata, the great extension of surface which is effected in the latter by the minute subdivision of the cavity not being here necessary. In the *Frog* (for example) the cavity of each lung is undivided ; its walls, which are thin and membranous at the lower part, there present a simple smooth expanse ; and it is only at the upper part, where the extensions of the Tracheal cartilage form a network over

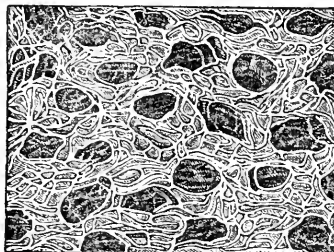
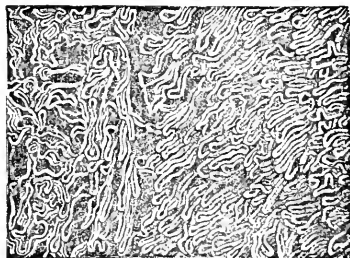
the interior, that its surface is depressed into sacculi, whose lining is crowded with blood-vessels (Fig. 400). In this manner a set of

Air-cells is formed in the thickness of the upper wall of the Lung, which communicate with the general cavity, and very much increase the surface over which the Blood comes into relation with the air; but each Air-cell has a Capillary network of its own, which lies on one side against its wall, so as only to be exposed to the air on its free surface. In the elongated Lung of the *Snake* the same general arrangement prevails; but the cartilaginous reticulation of its upper part projects much further into the cavity, and encloses in its meshes (which are usually square, or nearly so) several layers of air-cells, which communicate, one through another, with the general cavity.—The structure of the Lungs of *Birds* presents us with an arrangement of a very different kind, the purpose of which is

FIG. 399.

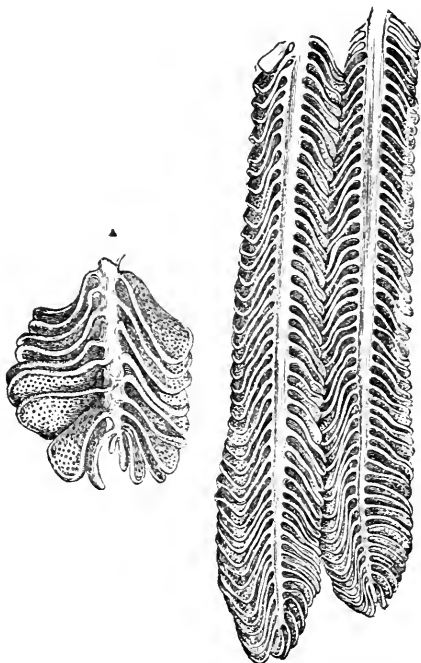

Two branchial processes of the *Gill of the Eel*, showing the branchial lamellæ:—A, portion of one of these processes enlarged, showing the capillary network of the lamellæ.

to expose a very large amount of Capillary surface to the influence of the air. The entire mass of each Lung may be considered as subdivided into an immense number of 'lobules' or 'lunglets' (Fig. 401, B), each of which has its own Bronchial tube (or subdivision of the windpipe), and its own system of blood-vessels, which have very little communication with those of other lobules. Each lobule has a central cavity, which closely resembles that of a *Frog's Lung* in miniature, having its walls strengthened by a network of Cartilage derived from the bronchial tube, in the interstices of which are openings leading to sacculi in their substance. But each of these cavities is surrounded by a solid plexus

of Blood-vessels, which does not seem to be covered by any limiting membrane, but which admits air from the central cavity freely between its meshes; and thus its Capillaries are in immediate

FIG. 400.

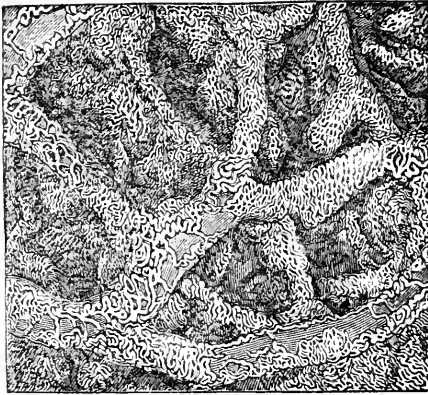
Interior of upper part of *Lung of Frog*.

relation with air on all sides, a provision that is obviously very favourable to the complete and rapid aeration of the blood they contain. — In the Lung of *Man* and *Mammals*, again, the plan of structure differs from the foregoing, though the general effect of it is the same. For its whole interior is divided up into minute Air-cells, which freely communicate with each other, and with the ultimate ramifications of the air-tubes into which the

Trachea subdivides; and the network of Blood-vessels (Fig. 402) is so disposed in the partitions between these cavities, that the

FIG. 401.

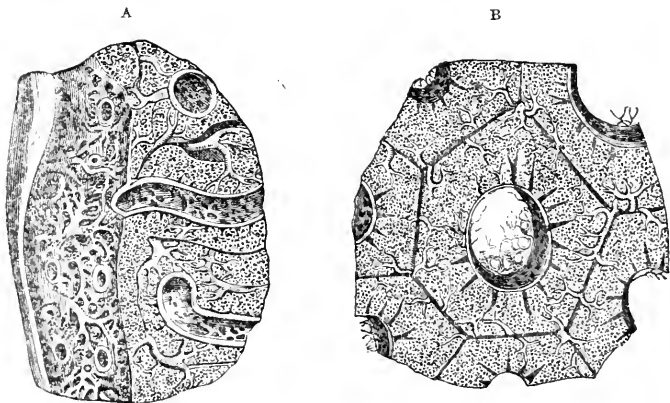

Interior structure of *Lung of Fowl*, as displayed by a section, A, passing in the direction of a bronchial tube, and by another section, B, cutting it across.

Blood is exposed to the Air on both sides. It has been calculated that the number of these Air-cells grouped around the termination of each air-tube in Man is not less than 18,000; and that the total number in the entire Lungs is *six hundred millions*.

584. The following list of the parts of the bodies of Vertebrata,

FIG. 402.

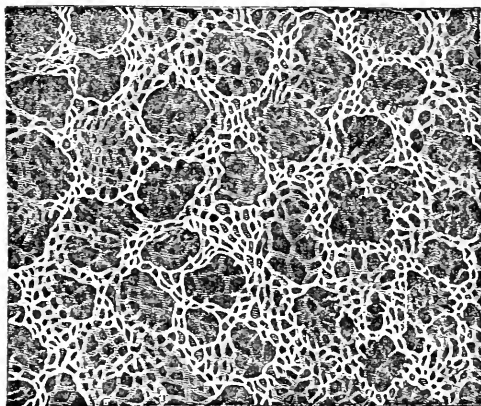

Arrangement of the Capillaries on the walls of the Air-cells of the *Human Lung*.

of which Injected preparations are most interesting as Microscopic objects, may be of service to those who may be inclined to apply themselves to their production. — *Alimentary Canal*; Stomach, showing the orifices of the Gastric Follicles, and the rudimentary Villi near the pylorus; Small Intestine, showing the Villi and the orifices of the Follicles of Lieberkühn, and at its lower part the

Peyerian glands; Large Intestine, showing the various Glandular follicles:—*Respiratory Organs*; Lungs of Mammals, Birds, and Reptiles; Gills and Swimming-bladder of Fish:—*Glandular Organs*; Liver, Gall-bladder, Kidney, Parotid:—*Generative Organs*; Ovary of Toad; Oviduct of Bird and Frog; Mammalian Placenta; Uterine and Fœtal Cotyledons of Ruminants:—*Organs of Sense*; Retina, Iris, Choroid, and Ciliary processes of Eye, Pupillary Membrane of Fœtus; Papillæ of Tongue; Mucous membrane of Nose, Papillæ of Skin of finger:—*Tegumentary Organs*; Skin of different parts, hairy and smooth, with vertical sections showing the vessels of the Hair-follicles, Sebaceous glands, and Papillæ; Matrix of nails, hoofs, &c.:—*Tissues*; Fibrous, Muscular, Adipose, Sheath of Tendon:—*Nervous Centres*; Sections of Brain and Spinal Cord.

The study of the Embryonic Development of Vertebrated animals has been pursued of late years with great zeal and success by the assistance of the Microscope; but as this is a department of inquiry which needs for its successful pursuit a thoroughly-scientific culture, and is only likely to be taken-up by a

professed Physiologist, no good purpose seems likely to be served by here giving such an imperfect outline of the process as could alone be introduced into a work like the present; and the reader who may desire information upon it will find no difficulty in obtaining this through Systematic Treatises on Physiology.*

* The admirable treatise of Prof. Kölliker "Entwicklungsgeschichte des Menschen und des höheren Thiere," is the most complete and satisfactory exposition yet given of the Developmental process in the higher Vertebrata. An excellent outline of the subject is given in Dr. Dalton's "Treatise on Human Physiology," Third Edit., Philadelphia, 1864. And the Author, in his "Manual of Physiology," Fourth Edit., 1865, has aimed to include what is most important for the Student to know.

CHAPTER XIX.

APPLICATIONS OF THE MICROSCOPE TO GEOLOGICAL INVESTIGATION.

THE utility of the Microscope is by no means limited to the determination of the structure and actions of the Organized beings at present living on the surface of the Earth ; for a vast amount of information is afforded by its means to the Geological inquirer, not only with regard to the minute characters of the many Vegetable and Animal remains that are entombed in the successive strata of which its crust is composed, but also with regard to the essential nature and composition of many of those strata themselves.—We cannot have a better example of its value in both these respects, than that which is afforded by the results of Microscopic examination of *Lignite* or Fossilized Wood, and of ordinary *Coal*, which there is every reason to regard as a product of the decay of Wood.

585. Specimens of *Fossilized Wood*, in a state of more or less complete preservation, are found in numerous Strata of very different ages,—more frequently, of course, in those whose materials were directly furnished by the dry land, and were deposited in its immediate proximity, than in those which were formed by the deposition of sediments at the bottom of a deep ocean. Generally speaking, it is only when the Wood is found to have been penetrated by *Silex*, that its organic structure is well preserved ; but instances occur every now and then, in which penetration by *Carbonate of Lime* has proved equally favourable. In either case, transparent sections are needed for the full display of the organization ; but such sections, though made with great facility when Lime is the fossilizing material, require much labour and skill when *Silex* has to be dealt-with. Occasionally, however, it has happened that the infiltration has filled the cavities of the cells and vessels, without consolidating their walls ; and as the latter have undergone decay without being replaced by any cementing material, the Lignite, thus composed of the internal ‘casts’ of the woody tissues, is very friable, its fibres separating from each other like those of *Asbestos* ; and laminæ split-asunder with a knife, or isolated fibres separated by rubbing-down between the fingers,

exhibit the characters of the woody structure extremely well, when mounted in Canada balsam.—Generally speaking, the Lignites of the Tertiary strata present a tolerably close resemblance to the Woods of the existing period ; thus the ordinary structure of *Dicotyledonous* and *Monocotyledonous* Stems may be discovered in such lignites in the utmost perfection ; and the peculiar modification presented by *Coniferous* wood is also most distinctly exhibited (Fig. 216). As we descend, however, through the strata of the Secondary period, we more and more rarely meet with the ordinary Dicotyledonous structure ; and the Lignites of the earliest deposits of these series are, almost universally, either Gymnosperms* or Palms.

586. Descending into the Palæozoic series, we are presented in the vast *Coal* formations of our own and other countries with an extraordinary proof of the prevalence of a most luxuriant Vegetation in a comparatively-early period of the world's history ; and the Microscope lends the Geologist essential assistance, not only in determining the nature of much of that vegetation, but also in demonstrating (what had been suspected on other grounds) that Coal itself is nothing else than a mass of decomposed Vegetable matter, chiefly derived from the decay of Coniferous wood. The determination of the characters of the *Ferns*, *Sigillariæ*, *Lepidodendra*, *Calamites*, and other kinds of vegetation whose forms are preserved in the Shales or Sandstones that are interposed between the strata of Coal, must be chiefly based on their external characters ; since it is very seldom that these specimens present any such traces of minute internal structure as can be subjected to Microscopic elucidation. But notwithstanding the general absence of any definite *form* in the masses of decomposed Wood of which Coal itself consists (these having apparently been reduced to a pulpy state by decay, before the process of consolidation by pressure, aided perhaps by heat, commenced), the traces of *structure* revealed by the Microscope are often sufficient—especially in the ordinary 'bituminous' Coal—not only to determine its Vegetable origin, but in some cases to justify the Botanist in assigning the characters of the vegetation from which it must have been derived. Different specimens of Coal exhibit these structural characters in very different degrees of distinctness ; but they uniformly indicate, with a clearness proportionate to their distinctness, that such vegetation must have been *Coniferous* in its nature, and that it probably approximated most nearly to that group of existing Coniferæ to which the *Araucariæ* belong. These inferences are based upon the fact that the Woody structure consists of Woody Fibres without interposed Vessels ; upon the presence of 'glandular' dots on the woody fibres ; and upon the peculiar arrangement of these dots in two or more rows, alternating one with another (§§ 294, 301).—

* Under this head are included the *Cycadææ*, along with the ordinary *Conifera* or Pine and Fir tribe.

There are certain Coals, however, especially of the kind termed 'Cannel,' in which there is no distinct indication of Organic structure; although they present appearances so closely simulating those of Vegetable tissue, as to have been mistaken for them by experienced Microscopists. These Coals are made-up of an aggregation of spherical or lenticular particles of a transparent Bituminoid substance, imbedded in an opaque matrix of black amorphous matter; the predominance of the former or of the latter constituting the difference between the 'brown' and the 'black' Cannels.*

587. In examining the structure of Coal, various methods may be followed. Of those kinds which have sufficient tenacity, thin sections may be made; but the opacity of the substance requires that such sections should be ground extremely thin before they become transparent; and its friability renders this process one of great difficulty. Any section must either cross the woody tissue transversely, so that the appearance it presents will resemble that of Fig. 215; or it must traverse it vertically, in which case the fibrous structure will be brought into view, either as in Fig. 216, or as in Fig. 217; or it must pass in an intermediate direction. The following method, which would seem not only to be more simple, but also to give more satisfactory results, is recommended by the authors of the "Micrographic Dictionary" (2nd Edit., p.164):—"The Coal is macerated for about a week in a solution of carbonate of potass; at the end of that time, it is possible to cut tolerably-thin slices with a razor. These slices are then placed in a watch-glass with strong nitric acid, covered, and gently heated; they soon turn brownish, then yellow, when the process must be arrested by dropping the whole into a saucer of cold water, or else the coal would be dissolved. The slices thus treated appear of a darkish amber-colour, very transparent, and exhibit the structure, when existing, most clearly. The specimens are best preserved in Glycerine, in cells; we find that Spirit renders them opaque, and even Canada balsam has the same effect."—When the Coal is so friable that no sections can be made of it by either of these methods, it may be ground to fine powder, and the particles may then, after being mounted in Canada balsam, be subjected to Microscopic examination: the results which this method affords are by no means satisfactory in themselves, but they will often enable the Organic structure to be sufficiently determined, by the comparison of the appearances presented by such fragments with those which are more

* This, in the opinion not only of the Author, but of his friends Dr. Hooker and Mr. G. Busk who have examined the question in concert with him, is the real nature of the much-vexed 'Torbane-hill Mineral;' which, though very different in structure and composition from the ordinary 'bituminous' Coals, has exactly the same right to be termed a Coal as have many 'cannels' whose title to that appellation no one has ever thought of disputing.

distinctly exhibited elsewhere. Valuable information may often be obtained, too, by treating the ash of an ordinary Coal-fire in the

FIG. 403.

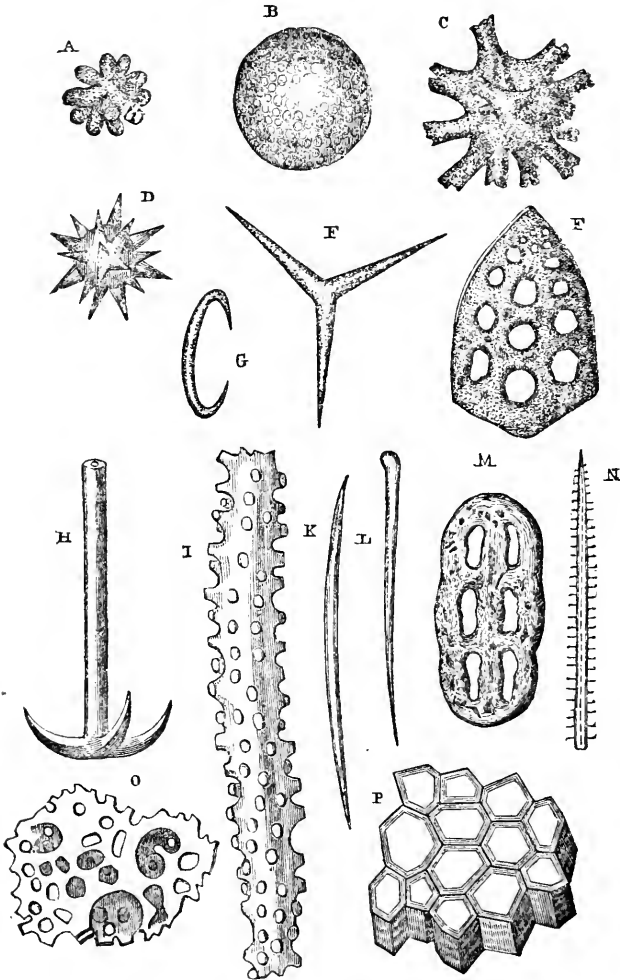

Microscopic Organisms in *Levant Mud*:—A, D, siliceous spicules of *Tethya*; B, H, spicules of *Geodia*; C, Sponge-spicule (unknown); E, calcareous spicule of *Grantia*; F, G, M, O, portions of calcareous skeleton of *Echinodermata*; H, I, calcareous spicule of *Gorgonia*; K, L, N, siliceous spicules of *Halichondria*; P, portion of prismatic layer of shell of *Pinna*.

same manner, or (still better) by burning to a white ash a specimen of Coal that has been previously boiled in nitric acid, and then carefully mounting the ash in Canada balsam; for mineral 'casts' of Vegetable Cells and Fibres may often be distinctly recognized in such ash; and such casts are not unfrequently best afforded by samples of Coal in which the method of section is least successful in bringing to light the traces of Organic structure, as is the case, for example, with the Anthracite of Wales.

588. Passing-on now to the Animal kingdom, we shall first cite some parallel cases in which the essential nature of deposits that form a very important part of the Earth's crust, has been determined by the assistance of the Microscope; and shall then select a few examples of the most important contributions which it has afforded to our acquaintance with types of Animal life long since extinct.—It is an admitted rule in Geological science, that the past history of the Earth is to be interpreted, so far as may be found possible, by the study of the changes which are still going on. Thus, when we meet with an extensive stratum of fossilized *Diatomaceæ* (§ 236) in what is now dry land, we can entertain no doubt that this Siliceous deposit originally accumulated either at the bottom of a Fresh-water lake or beneath the waters of the Ocean; just as such deposits are formed at the present time by the production and death of successive generations of these bodies, whose indestructible casings accumulate in the lapse of ages, so as to form layers whose thickness is only limited by the time during which this process has been in action (§ 235). In like manner, when we meet with a Limestone-rock entirely composed of the Calcareous shells of *Foraminifera*, some of them entire, others broken up into minute particles, we interpret the phenomenon by the fact that the dredgings obtained from certain parts of the Ocean-bottom consist almost entirely of remains of existing Foraminifera, in which entire shells, the animals of which may be yet alive, are mingled with the *débris* of others that have been reduced by the action of the waves to a fragmentary state.* Now in the fine white mud which is brought-up from almost every part of the sea-bottom of the Levant, where it forms a stratum that is continually undergoing a slow but steady increase in thickness, the Microscopic researches of Prof. Williamson† have shown that not only are there multitudes of minute remains of living organisms, both Animal and Vegetable, but that it is entirely or almost wholly composed of such remains. Amongst these were about 26 species

* Such a deposit, consisting chiefly of *Orbitolites* (§ 376), is at present in the act of formation on certain parts of the shores of Australia, as the Author is informed by Mr. J. Beete Jukes; thus affording the exact parallel to the stratum of *Orbitolites* (belonging, as the Author's investigations have led him to believe, to the very same species, that forms part of the 'Calcaire Grossier' of the Paris basin.

† "Memoirs of the Manchester Literary and Philosophical Society," Vol. viii.

of Diatomaceæ (siliceous), 8 species of Foraminifera (calcareous), and a miscellaneous group of objects (Fig. 403), consisting of calcareous and siliceous spicules of Sponges and Gorgoniae, and of fragments of the calcareous skeletons of Echinoderms and Mollusks.—The deep-sea Soundings which have been recently obtained from various parts of the Ocean-bed afford results more or less similar; the *variety* of forms, however, usually showing a diminution as the depth increases (§ 383). From an extensive comparison of the forms of *recent* Foraminifera brought-up from different depths, Messrs. Parker and Rupert Jones consider themselves able to predicate the range of depth within which any par-

FIG. 404.

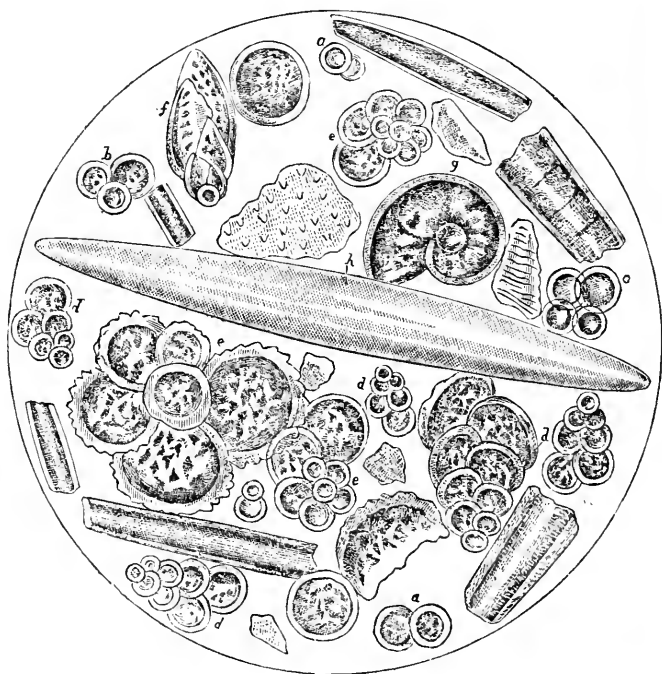

Microscopic Organisms in *Chalk* from Gravesend:—*a*, *b*, *c*, *d*, *Textularia globulosa*; *e*, *e*, *e*, *Rotalia aspera*; *f*, *Textularia aculeata*; *g*, *Planularia hexas*; *h*, *Navicula*.

ticular collection may have been taken; and thus to determine, in the case of deposits of *fossil* Foraminifera, within what range of depth they were probably formed.

589. A collection of forms strongly resembling that of the Levant

Mud, with the exception of the siliceous Diatomaceæ, is found in many parts of the 'Calcaire grossier' of the Paris basin, as well as in other extensive deposits of the same early Tertiary period. And there is little doubt that a large proportion of the great Cretaceous (Chalk) formation has a like composition; for many parts of it consist in great part of the minuter kinds of Foraminifera, whose shells are imbedded in a mass of apparently amorphous particles, many of which, nevertheless, present indications of being the worn fragments of similar shells, or of larger calcareous organisms. In the Chalk of some localities, Foraminifera constitute the principal part of the minute organisms which can be recognized with the Microscope (Figs. 404, 405); in other in-

FIG. 405.



Microscopic Organisms in *Chalk* from Meudon; seen partly as Opaque, and partly as Transparent objects.

stances, the disintegrated prisms of *Pinna* (§ 458), or other large Shells of the like structure (as *Inoceramus*) constitute the great bulk; whilst in other cases, again, the chief part is made up of

the shells of *Cytherina*, a marine form of Entomostracous Crustacean (§ 498). Different specimens of Chalk vary greatly in the proportion which the distinctly Organic remains bear to the amorphous particles, and which the different kinds of the former bear to each other; and this is quite what might be anticipated, when we bear in mind the predominance of one or another tribe of Animals or Plants in the several parts of a large area. True Chalk seems to differ from the Levant Mud in the small proportion which the siliceous remains of Diatomaceæ bear in the former, compared with that which is mingled in the latter with the calcareous shells of Foraminifera, &c.; and it seems doubtful to what extent they were present in the seas of that epoch. Such remains are found in abundance, however, forming marly strata which alternate with those of a chalky nature in the South of Europe and the North of Africa (Fig. 144); and it is surmised by Prof. Ehrenberg that the layers of *Flint* which the British Chalk contains, have been derived by some metamorphic process from similar layers of siliceous Diatomaceæ which have disappeared. It is now certain, however, that the deposits referred to by Prof. Ehrenberg are of an age later than that of the great Chalk formation; so that little support is furnished by their phenomena to his hypothesis. But whatever may have been the origin of the Siliceous material, it may be stated as a fact beyond all question that nodular Flints and other analogous concretions (such as Agates) may generally be considered as fossilized Sponges or Alcyonian Zoophytes; since not only are their external forms and their superficial markings often highly characteristic of those organisms, but, when sections of them are made sufficiently thin to be transparent, a Spongy texture may be most distinctly recognized in their interior.* It is curious that many such sections contain well-preserved specimens of *Xanthidia*, which are Sporangia of *Desmidiaceæ* (§ 206) covered with long spinous projections, often cleft, and sometimes furnished with hooks at their extremities; and we occasionally also find upon their surface, or even imbedded in their substance, Foraminiferal shells (especially *Rotalia*), in which not only the substance of the shell has undergone silification, but also that of the soft animal body, the shrunken form of which may be recognized in the dark Carbonaceous hue imparted to the central portion of the *Silex* which fills each chamber.

590. In examining Chalk or other similar mixed aggregations, whose component particles are easily separable from each other, it is desirable to separate, with as little trouble as possible, the larger and more definitely-Organized bodies from the minute amorphous particles; and the mode of doing this will depend upon whether we are operating upon the large or upon the small scale.

* See Dr. Bowerbank's Memoirs in the "Transact. of the Geolog. Society," 1840, and in the "Ann. of Nat. Hist.," 1st Ser., Vols. vii., x.

If the former, a quantity of soft Chalk should be rubbed to powder with water, by means of a soft brush; and this water should then be proceeded-with according to the method of levigation already directed for separating the Diatomaceæ (§ 237). It will usually be found that the first deposits contain the larger Foraminifera, fragments of shell, &c., and that the smaller Foraminifera and Sponge-spicules fall next; the fine amorphous particles remaining diffused through the water after it has been standing for some time, so that they may be poured-away. The organisms thus separated should be dried and mounted in Canada balsam.— If the smaller scale of preparation be preferred, as much Chalk scraped fine as will lie on the point of a knife is to be laid on a drop of water on the glass slide, and allowed to remain there for a few seconds; the water, with any particles still floating on it, should then be removed; and the sediment left on the glass should be dried and mounted in Balsam.—For examining the structure of Flints, such chips as may be obtained with a hammer will commonly serve very well: a clear translucent flint being first selected, and the chips that are obtained being soaked for a short time in Turpentine (which increases their transparency), those which show organic structure, whether Sponge-tissue or Xanthidia, are to be selected and mounted in Canada balsam. The most perfect specimens of Sponge-structure, however, are only to be obtained by slicing and polishing,—a process which is best performed by the Lapidary.

591. There are various other deposits, of less extent and importance than the great Chalk-formation, which are, like it, composed in great part of Microscopic organisms, chiefly minute Foraminifera; and the presence of animals of this group may be recognized, by the assistance of this instrument, in sections of Calcareous rocks of various dates, whose chief materials seem to have been derived from Corals, Encrinite-stems, or Molluscon shells. Thus in the 'Crag' formation (Tertiary) of the eastern coast of England, the greater portion of which is perceived by the unassisted eye to be composed of fragments of Shells, Corals (or rather Polyzoaries, § 445), and Echinodermata, the Microscope enables us to discover Foraminifera, minute fragments of Shells and Corals, and spicules of Sponges; the aggregate being such as is at present in process of formation on many parts of our shores, and having been, therefore, in all probability, a 'littoral' formation; whilst the Chalk (with other formations chiefly consisting of Foraminifera) was deposited at the bottom of deeper waters. Many parts of the Oolitic (Secondary) formation have an almost identical character, save that the forms of Organic life give evidence of a different age; and in those portions which exhibit the 'roe-stone' arrangement from which the rock derives its name (such as is beautifully displayed in many specimens of Bath-stone and Portland-stone), it is found by Microscopic examination of transparent sections, that

each rounded concretion is composed of a series of concentric spheres enclosing a central nucleus, which nucleus is often a Foraminiferal shell. In the Carboniferous (paleozoic) Limestone, again, well-preserved specimens of Foraminifera present themselves; and there are certain bands of limestone of this epoch in Russia, varying in thickness from fifteen inches to five feet, and frequently repeated through a vertical depth of two hundred feet, over very wide areas, which are almost entirely composed of the extinct genus *Fusulina* (§ 388): thus prefiguring, as it were, the vast deposit of Nummulitic limestone (§ 392) which marks the commencement of the Tertiary epoch.—Mention has already been made (§ 390, *note*) of Prof. Ehrenberg's very remarkable discovery that a large proportion (to say the least) of the *green sands* which present themselves in various stratified deposits, from the Silurian epoch to the Tertiary period, and which in certain localities constitute what is known as *the Greensand formation* (beneath the Chalk), is composed of the *casts* of the interior of minute shells of Foraminifera and Mollusca, the shells themselves having entirely disappeared. The material of these casts, which is chiefly Silice coloured by Silicate of Iron, has not merely filled the Chambers and their communicating passages (Fig. 253, A, B), but has also penetrated, even to its minutest ramifications, the Canal-system of the intermediate skeleton (Figs. 256, 260).—Even this discovery pales in interest before that more recent one to which it has led, and which may be regarded as the most remarkable achievement of Microscopic inquiry as applied to Geology; namely, the determination of the Organic nature of those Serpentine-Limestones in the Laurentian Formations of Canada and elsewhere, which are products of the growth of the gigantic Foraminiferal *Eozöon* over immense areas of the ancient Sea-bottom (§§ 396-400). This discovery is alike interesting to the Physiologist and Zoologist, on the one hand, and to the Geologist on the other. For it presents to the former the *Rhizopod* type of Animal life, than which nothing simpler can well be conceived (§ 325), in an aspect of most unexpected magnitude: whilst to the latter it affords evidence not merely of the prevalence of Animal life, but of its important share in the production of Rock-formations, in Strata so far below those in which Organic Remains had previously been detected, that, to use the words of Sir William Logan, the appearance of the so called 'Primordial Fauna' is a comparatively modern event.

592. The foregoing General Summary, taken in connection with the more detailed statements that have been made in previous parts of this work, will suffice to indicate the essential importance of Microscopic investigation, in determining, on the one hand, the real character of various Stratified deposits, and on the other, the nature of the Organic remains which these may include. The former of these lines of inquiry has not yet attracted the attention which it deserves; since, as is very natural, the greater number

of Microscopists are more attracted by those definite forms which they can distinctly recognize, than by the amorphous sediments which present no definite structural characters. Yet it is a matter of extreme interest to the Geologist, to determine how far these may have had their origin in the disintegration of Organic structures; and much light may often be thrown upon this question by careful Microscopic analysis.—Thus the Author having been requested by Mr. Chas. Darwin, more than twenty years since, to examine into the composition of the extensive Calcareous deposit which covers the surface of the Pampas region of South America, and to compare it with that of the Calcareous Tufa still in process of formation along the coast of Chili, was able to state that their constituents were in all probability essentially the same, notwithstanding the difference in their mode of aggregation. For the Chilian Tufa is obviously composed in great part of fragments of Shells, distinguishable by the naked eye; the dense matrix in which these are imbedded is chiefly made-up of minuter fragments, only distinguishable as such by the Microscope; while through the midst of these is diffused an aggregation of amorphous particles, that present every appearance of having originated in the yet finer reduction of the same Shells, either by attrition or by decomposition. In the Pampas deposit, on the other hand, the principal part was found to be composed of amorphous particles, so similar in aspect to those of the Chilian rock that their identity could scarcely be doubted; and scattered at intervals through these were particles of Shell distinctly recognizable by the Microscope, though invisible to the naked eye. Thus, although the evidence afforded by the larger fragments of shell was altogether wanting in the Pampas deposit, it could not be doubted that the materials of both were the same, those of the Pampean formation having been subjected to greater comminution than those of the Chilian; and this view served to confirm, whilst it was itself confirmed by, the idea entertained as most probable on other grounds by Mr. Darwin, that the Pampean formation had slowly accumulated at the mouth of the former estuary of the Plata, and in the sea adjoining it.*—A similar line of inquiry has been of late systematically pursued by Mr. R. C. Sorby, who has applied himself to the Microscopic study of the composition of Freshwater Marls and Limestones, by ascertaining the characters and appearances of the minute particles into which Shells resolve themselves by decay, and by estimating the relative proportions of the Organic and Inorganic ingredients of a rock, by delineating on paper (by means of the Camera Lucida) the outlines of the particles visible in thin sections, then cutting them out, and weighing the figures of each kind.†

* See Mr. C. Darwin's "Geological Observations on South America," p. 32.

† See his successive Memoirs in "Quart. Journ. of Geolog. Science," 1853, p. 344, and subsequently.

593. It is obvious that, under ordinary circumstances, only the *hard* parts of the bodies of Animals that have been entombed in the depths of the earth are likely to be preserved ; but from these a vast amount of information may be drawn ; and the inspection of a Microscopic fragment will often reveal, with the utmost certainty, the entire nature of the organism of which it formed part. In the examination of the minuter fossil Corals, and of those Polyzoaries (§ 445) which are commonly ranked with them, the assistance of the Microscope is indispensable. Minute fragments of the Tests or Spines of Echinodermata, and of all such Molluscous Shells as present distinct appearances of structure (this being especially the case with the Brachiopoda, and with the families of Lamellibranchiate Bivalves most nearly allied to them), may be unerringly identified by its means, when the external form of these fragments would give no assistance whatever. In the study of the important ancient group of *Trilobites*, not only does a Microscopic

FIG. 406.

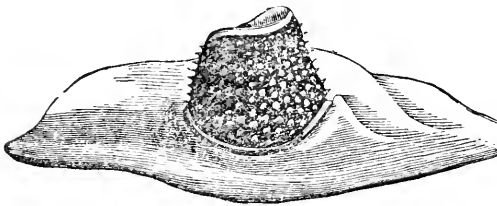
Eye of *Trilobite*.

examination of the 'casts' which have been preserved of the surface of their Eyes (Fig. 406), serve to show the entire conformity in the structure of these organs to the 'composite' type which is so remarkable a characteristic of the higher Articulata (§ 516), but it also brings to light certain peculiarities which help to determine the division of the great Crustacean series with which this group has most alliance.*

594. It is in the case of the Teeth, the Bones, and the Dermal skeleton of Vertebrated animals, however, that the value of Microscopic inquiry becomes most apparent ; since the structure of these presents so many characteristics that are subject to well marked variations in their several Classes, Orders, and Families, that a knowledge of these characters frequently enables the Microscopist to determine the nature of even the most fragmentary specimens, with a positiveness which must appear altogether misplaced to such as have not studied the evidence. It was in regard to *Teeth*, that the possibility of such determinations was first made clear by the laborious researches of Prof. Owen,† and the following may be given as examples of their value:—A Rock-forma-

* See Prof. Burmeister "On the Organization of the Trilobites," published by the Ray Society, p. 19.

† See his magnificent "Odontography."

tion extends over many parts of Russia, whose mineral characters might justify its being likened either to the *Old* or to the *New Red Sandstone* of this country, and whose position relatively to other strata is such that there is great difficulty in obtaining evidence from the usual sources as to its place in the series. Hence the only hope of settling this question (which was one of great practical importance,—since, if the formation were *New Red*, Coal might be expected to underlie it, whilst if *Old Red*, no reasonable hope of Coal could be entertained) lay in the determination of the Organic remains which this stratum might yield; but unfortunately these were few and fragmentary, consisting chiefly of Teeth which are seldom perfectly preserved. From the gigantic size of these Teeth, together with their form, it was at first inferred that they belonged to Saurian Reptiles, in which case the Sandstone must have been considered as *New Red*; but Microscopic examination of their intimate structure unmistakably proved them to belong to a genus of Fishes (*Dendrodus*) which is exclusively Palæozoic, and thus decided that the formation must be *Old Red*.—So again, the Microscopic examination of certain fragments of teeth found in a Sandstone of Warwickshire, disclosed a most remarkable type of Tooth-structure (shown in Fig. 407), which was also ascertained to

FIG. 407.

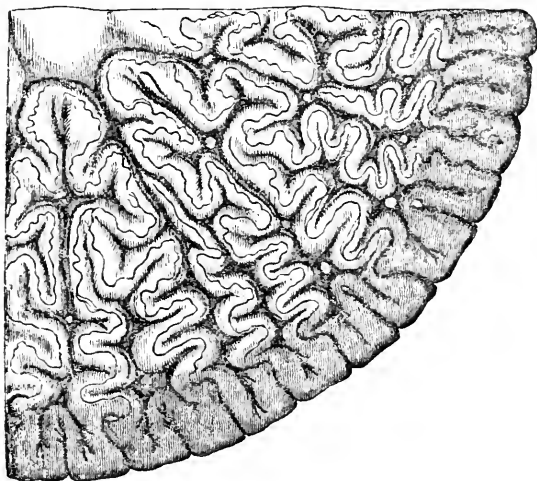
Section of Tooth of *Labyrinthodon*.

exist in certain Teeth that had been discovered in the 'Keuper-sandstein' of Wirtemberg; and the identity or close resemblance

of the animals to which these teeth belonged having been thus established, it became almost certain that the Warwickshire and Wirtemberg Sandstones were equivalent formations, a point of much Geological importance. The next question arising out of this discovery, was the nature of the Animal (provisionally termed *Labyrinthodon*, a name expressive of the most peculiar feature in its dental structure) to which these teeth belonged. They had been referred, from external characters merely, to the order of Saurian Reptiles; but these characters were by no means conclusive; and as the nearest approaches to their peculiar internal structure are presented by Fish-Lizards and Lizard-like Fish, it might be reasonably expected that the *Labyrinthodon* would combine with its Reptilian characters an affinity to Fish. This has been clearly proved to be the case, by the subsequent discovery of parts of its skeleton in which such characters are very obvious; and by a very beautiful chain of reasoning, Prof. Owen succeeded in establishing a strong probability, that the *Labyrinthodon* was a gigantic Frog-like animal five or six feet long, with some peculiar affinities to Fishes, and a certain mixture also of Crocodilian characters; and that it made the well-known foot-prints which have been brought to light, after an entombment whose duration can scarcely be conceived (much less estimated), in the Stourton quarries of Cheshire. This conclusion has been fully confirmed by subsequent discoveries.

595. The more recent researches of Prof. Quekett on the minute structure of *Bone* promise to be scarcely less fruitful in valuable results.* From the average size and form of the Lacunæ, their disposition in regard to each other and to the Haversian Canals, and the number and course of the Canaliculi (§ 543), the nature of even a minute fragment of Bone may often be determined with a considerable approach to certainty; as is shown by the following examples, among many which might be cited:—Dr. Falconer, the distinguished investigator of the fossil remains of the Himalayan region, and the discoverer of the gigantic fossil Tortoise of the Sivalik hills, having met with certain small Bones about which he was doubtful, placed them in the hands of Prof. Quekett for minute examination; and was informed, on Microscopic evidence, that they might certainly be pronounced Reptilian, and probably belonged to an animal of the Tortoise tribe; and this determination was fully borne-out by other evidence, which led Dr. Falconer to conclude that they were toe-bones of his great Tortoise.—Some fragments of Bone were found, some years since, in a Chalk-pit, which were considered by Prof. Owen to have formed part of the wing-bones of a long-winged Sea-Bird allied to the Albatross. This determination, founded solely on considerations derived from the very

* See his Memoir on the 'Comparative Structure of Bone,' in the "Transact. of the Microsc. Society," Ser. 1, Vol. ii.; and the "Catalogue of the Histological Museum of the Roy. Coll. of Surgeons," Vol. ii.

imperfectly-preserved external forms of these fragments, was called in question by some other Palæontologists; who thought it more probable that these bones belonged to a large species of the extinct genus *Pterodactylus*, a Flying Lizard whose wing was extended upon a single immensely-prolonged digit. No species of Pterodactyle, however, at all comparable to this in dimensions, was at that time known; and the characters furnished by the configuration of the bones not being in any degree decisive, the question would have long remained unsettled, had not an appeal been made to the Microscopic test. This appeal was so decisive, by showing that the minute structure of the Bone in question corresponded exactly with that of Pterodactyle bone, and differed essentially from that of every known Bird, that no one who placed much reliance upon that evidence could entertain the slightest doubt on the matter. By Prof. Owen, however, the validity of that evidence was questioned, and the bone was still maintained to be that of a Bird; until the question was finally set at rest, and the value of the Microscopic test triumphantly confirmed, by the discovery of undoubted Pterodactyle bones of corresponding and even of greater dimensions, in the same and other Chalk quarries.*

596. The application of the Microscope to Geology is not, however, limited to the determination or discovery of Organic structure; for, as has been now satisfactorily demonstrated, very important information may be acquired by its means respecting the Mineral composition of Rocks, and the mode of their formation. "As long," says Mr. David Forbes,† "as the Geologist encounters in the field only rocks of so coarse and simple a structure as to admit of being resolved by the naked eye into their constituent Mineral species, or of distinguishing the fragments of previously existing rocks of which they have been built up, he may speculate with a fair chance of success as to their probable origin or mode of formation. When, however, as is more often the rule than the exception, Rocks are everywhere met with presenting so fine-grained and apparently homogeneous a texture as to defy such attempts at ocular analysis, all speculations as to their nature and formation based merely upon observation in the field, can but be compared to groping in the dark, with the faint hope of stumbling upon the truth. In these cases the Geologist must call in the aid of Chemistry and the Microscope; by Chemical analysis he learns the per-centage composition of the rock in question; whilst the Microscopic examination informs him how the Chemical components are Mineralogically combined, and at the same time affords valuable information as to the physical structure and arrangement of the components of the

* See Prof. Owen's Monograph on "The British Fossil Reptiles of the Chalk Formation" (published by the Palæontographical Society), p. 80, *et seq.*

† 'The Microscope in Geology,' in the "Popular Science Review," October, 1867.

rock-mass, tending to elucidate its formation and origin." The mode recommended by Mr. D. Forbes of making Transparent Sections of Rocks for Microscopic examination, is essentially the same with that already described (§§ 138-140). A fragment from one quarter to three quarters of an inch square, and of convenient thickness, is chipped off the rock-specimen in the direction of the required section, and ground down upon an iron or pewter plate in a Lapidary's lathe with emery, until a perfectly flat surface is obtained. This surface is then worked down still finer upon a slab of Black Marble, with less coarse emery, then upon a Water of Ayr stone with water alone, and lastly polished with water on a slab of Black Marble. The polished surface being then cemented to a slip of Plate-glass, the other surface is to be worked down in the same manner, until the section is reduced to a sufficient thinness; when it is to be transferred to a slide, and mounted in Canada balsam in the usual mode. The examination of such a Rock-section enables a Mineralogical analysis to be made even of the most compact and apparently homogeneous rock; for even when the glassy appearance of a vitrified rock would discourage any hopes of structure being discovered, some portion may generally be found by Microscopic examination, in which the vitrification is so far from being complete as to enable the component Minerals to be distinctly recognized. Thus in a specimen of Glassy Pitchstone examined by Mr. Forbes, the Pyroxenic and Feldspathic constituents of the rock were beautifully apparent, notwithstanding that the rock itself looks like so much dirty green bottle-glass. And in many cases in which the specimens have been so perfectly vitrified as to show no trace of structure in the first instance, this may be developed by carefully acting upon the surface by gaseous or liquid Hydrochloric acid. Frequently, again, Mineral constituents are thus discovered, whose existence had been previously unsuspected from their being too minute to be recognized by the eye; and the presence of these may have a most important bearing upon the question of the mode in which the Rock-masses have originated. Thus it has been shown by Mr. Sorby that the Quartz of Granites contains Water in numerous minute cavities excavated in its solid crystals; which shows that Granites have solidified at a heat far below the fusing points of their constituent minerals, and at such a pressure as to enable them to entangle and retain a small amount of aqueous vapour. Similar cavities have been detected by Mr. Sorby not merely in the Quartz of Volcanic rocks, but also in the Felspar and Nepheline ejected from the crater of Vesuvius; and this fact renders it probable that the two classes of rocks were formed by identical agencies, as might be concluded from the general arrangement of their Mineral components. For it is affirmed by Mr. D. Forbes that "the Microscopic examination already made of many hundred sections of Eruptive rocks, differing widely in Geological age and Geographical distribution, shows that in all rocks of this

class, whether of the most compact, hard, and homogeneous appearance, or occurring in the softest and finest powder, like the ashes and dust frequently thrown out by volcanoes, a similar crystallized arrangement and structure is present and common to them all. Lavas, Trachytes, Dolerites, Diorites, Porphyrites, Syenites, Granites, &c., all possess the same general structural features, serving to distinguish the Eruptive rocks as a class from all others." Again, it has been shown by Mr. Sorby that Microscopic examination often allows the Minerals formed at the time of the solidification of the rock, to be distinguished from such as are the products of subsequent alteration by the action of water, or by atmospheric or other agencies. In the case of Sedimentary Rocks, it frequently happens that Microscopic examination affords the only means by which the problem of their origin can be resolved; the most compact and apparently homogeneous specimens being thus shown to be aggregations of more or less rounded and water-worn grains (often less than 1-1000th of an inch in diameter) of Quartz, weathered Felspar, Mica, soft and hard Clays, Clay-slate, Oxide of Iron, Iron-pyrites, Carbonate of Lime, fragments of Fossil Organisms, &c., arranged without any trace of decided structure or crystallization. And in rocks exhibiting Slaty Cleavage, this may often be clearly demonstrated to be the result of pressure applied at right angles to the structure itself, thereby causing an elongation or flattening-out of some, along with a sliding movement of other of the particles.—The foregoing examples are sufficient to indicate the value of Microscopic inquiry in that department of Geology which includes the study of the composition and origin of Rocks, and which is now known as *Petrology*. It is a study, however, which can only be profitably pursued by such as are prepared for it by a large amount of Geological and Mineralogical knowledge; and to follow it out systematically will require a large expenditure of time and patience. And as the limited scope of this Treatise forbids any more extended notice of it, the Reader who desires further information as to what has been already done, is referred to the sources mentioned below.*

* See the Memoir of Mr. Serby 'On some peculiarities in the Microscopic Structure of Crystals,' in the "Quart. Journ. of the Geolog. Society," Vol. xiv., p. 242; 'On the Microscopical Structure of Crystals, indicating the origin of Minerals and Rocks,' *Op. cit.*, p. 453; 'On the original nature and subsequent alteration of Mica-Schist,' *Op. cit.*, Vol. xix., p. 401; the Memoir by Mr. David Forbes 'The Microscope in Geology,' in the "Popular Science Review," Oct. 1867; and the Treatise of Vogelsang "Philosophie der Geologie und Mikroskopische Gesteinsstudien," Bonn, 1867.

CHAPTER XX.

INORGANIC OR MINERAL KINGDOM.—POLARIZATION.

597. ALTHOUGH by far the most numerous and most important applications of the Microscope are those by which the structure and actions of Organized beings are made known to us, yet there are many Mineral substances which constitute both interesting and beautiful objects; being remarkable either for the elegance of their forms or for the beauty of their colours, or for both combined. The natural forms of Inorganic substances, when in any way symmetrical, are so in virtue of that peculiar arrangement of their particles which is termed *Crystallization*; and each substance which crystallizes at all, does so after a certain type or plan,—the identity or difference of these types furnishing characters of primary value to the Mineralogist. It does not follow, however, that the form of the Crystal shall be constantly the same for each substance; on the contrary, the same plan of crystallization may exhibit itself under a great variety of forms; and the study of these, in such minute crystals as are appropriate subjects for observation by the Microscope, is not only a very interesting application of its powers, but is capable of affording some valuable hints to the designer. This is particularly the case with Crystals of *Snow*, which belong to the ‘hexagonal system,’ the basis of every figure being a hexagon of six rays; for these rays “become encrusted with an endless variety of secondary formations of the same kind, some consisting of thin laminae alone, others of solid but translucent prisms heaped one upon another, and others gorgeously combining laminae and prisms in the richest profusion;”* the angles by which these figures are bounded, being invariably 66° or 120° . Beautiful arborescent forms are not unfrequently produced by the peculiar mode of aggregation of individual crystals: of this we have often an example on a large scale on a frosted window; but microscopic crystallizations sometimes present the same curious phenomenon (Fig. 408).—In the following list are enumerated some of the most interesting

* See Mr. Glaisher’s Memoir on ‘Snow-Crystals in 1855,’ with numerous beautiful figures, in “Quart. Journ. of Microsc. Science,” Vol. iii. (1855), p. 179.

natural specimens which the Mineral kingdom affords as Microscopic objects ; these should be viewed by reflected light, under a very low power :—

Antimony, sulphuret	Iron, ilvaite or Elba-ore
Asbestos	— pyrites (sulphuret)
Aventurine	Lapis lazuli
Ditto, artificial	Lead, oxide (minium)
Copper, native	— sulphuret (galena)
— arseniate	Silver, crystallized
— malachite-ore	Tin, crystallized
— peacock-ore	— oxide
— pyrites (sulphuret)	— sulphuret
— ruby-ore	Zinc, crystallized.

Thin sections of Granite and other rocks of the more or less regularly-crystalline structure adverted to in the preceding paragraph, also of Agate, Arragonite, Tremolite, Zeolite, and other Minerals, are very beautiful objects for the Polariscope.

598. The actual process of the *Formation of Crystals* may be watched under the Microscope with the greatest facility ; all that is necessary being to lay

on a slip of glass, previously warmed, a saturated solution of the Salt, and to incline the Stage in a slight degree, so that the drop shall be thicker at its lower than at its upper edge. The crystallization will speedily begin at the upper edge, where the proportion of liquid to solid is most quickly reduced by evaporation, and will gradually extend downwards. If it should go on too slowly, or should cease altogether, whilst yet a large proportion of the liquid remains, the slide may be again warmed, and the part already solidified may be re-dissolved, after which the

FIG. 408.

*Crystallized Silver.*

process will recommence with increased rapidity.—This interesting spectacle may be watched under any Microscope ; and the works of Adams and others among the older observers testify to the great interest which it had for them. It becomes far more striking, however, when the crystals, as they come into being, are made to stand out bright upon a dark ground, by the use of the

Spotted Lens, the Paraboloid, or any other form of Black-ground illumination; still more beautiful is the spectacle when the Polarizing apparatus is employed, so as to invest the crystals with the most gorgeous variety of hues. Very interesting results may often be obtained from a mixture of two or more Salts, and some of the

FIG. 409.

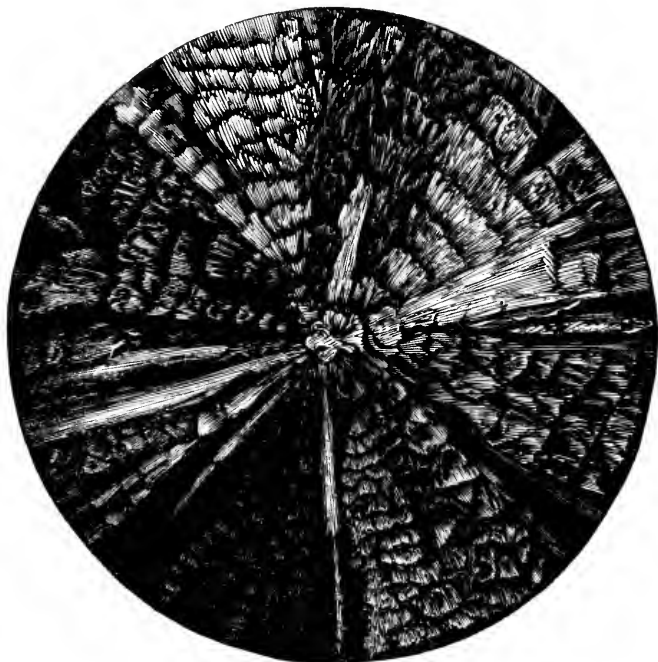

Radiating Crystallization of Santonine.

Double Salts give forms of peculiar beauty.* A further variety may be produced by *fusing* the film of the substance which has crystallized from its solution; since on the temperature of the

* The following directions have been given by Mr. Davies ("Quart. Journ. of Microsc. Science," N.S., Vol. ii., 1862, p. 128, and Vol. v., p. 205) for obtaining these. "He makes a nearly saturated solution, say of the double Sulphate of Copper and Magnesia; he drives rapidly a portion on a glass slide, allowing it to become hot so as to fuse the salt in its water of crystallization; there then remains an amorphous film on the hot glass. On allowing the slide to cool slowly, the particles of the salt will absorb moisture from the atmosphere, and begin to arrange themselves on the glass, commencing from points. If then placed under the Microscope, the points will be seen starting up here and there; and from those centres the crystals may be watched as they burst into blossom and spread their

glass slide during the solidification will depend the size and arrangement of the crystals. Thus *Santonine*, when crystallizing rapidly on a very hot plate, forms large crystals radiating from centres without any undulations; when the heat is less considerable, the crystals are smaller, and show concentric waves of very

FIG. 410.

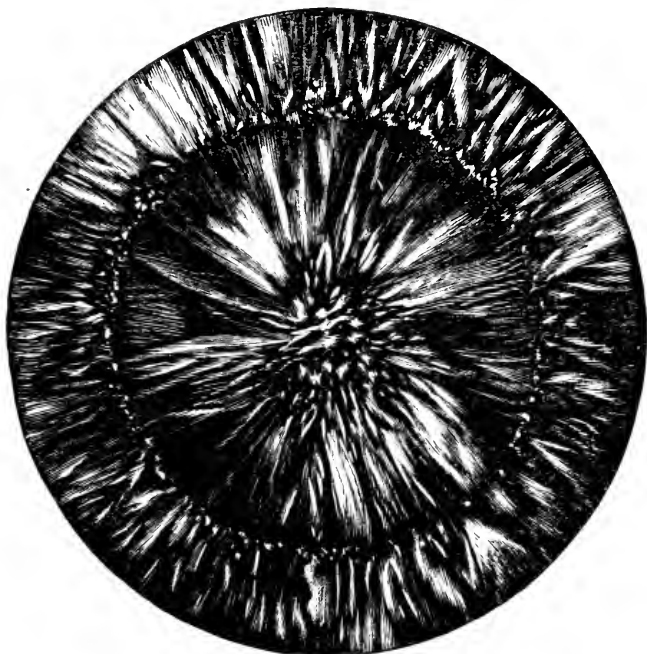

Radiating Crystallization of Sulphate of Copper and Magnesia.

decided form (Fig. 409), but when the slip of glass is cool, the crystals are exceedingly minute. It would seem as if these last results were due to interruptions in the formative process at certain points, consequent upon the hardening influence of cold, and

petals on the plate. Starting-points may be made at pleasure, by touching the film with a fine needle to enable the moisture to get under it; but this treatment renders the centres imperfect. If allowed to go on, the crystals would slowly cover the plate, or if breathed-on they form immediately; whereas if it is desired to preserve the flower-like forms on a plain ground, as soon as they are large enough development is suspended by again applying gentle heat; the crystals are then covered with *pure* Canada balsam and thin glass, to be finished off as usual. The balsam must cover the edges of the film, or moisture will probably get under it, and crystallization go creeping on."

the starting of a fresh formation at those points.* A curious example of the like kind in the crystallization of Sulphate of Copper to which a *small* quantity of Sulphate of Magnesia has been added, is shown in Fig. 410. The same principle has been carried out to a still greater extent in the case of Sulphate of Copper alone, by Mr. R. Thomas, † who has succeeded, by keeping the slide at a temperature of from 80° to 90° , in obtaining most singular and beautiful forms of *spiral* crystallization, such as that represented in Fig. 411.—The following List specifies the Salts

FIG. 411.



Spiral Crystallization of Sulphate of Copper.

and other substances whose crystalline forms are most interesting. When these are viewed with Polarized light, some of them exhibit a beautiful variety of colours of their own, whilst others require the interposition of the Selenite plate for the development of colour. The substances marked *d* are distinguished by the curious property termed *Dichroism*, which was first noticed by Dr. Wollaston, but has been specially investigated by Sir D. Brewster.‡

* See Davies on 'Crystallization and the Microscope,' in "Quart. Journ. of Microsc. Science," N.S., Vol. iv., p. 251.

† See his paper 'On the Crystallization at various Temperatures of the Double Salt, Sulphate of Magnesia and Sulphate of Zinc,' in "Quart. Journ. of Microsc. Science," N.S., Vol. vi., pp. 137, 177. See also H. N. Draper on 'Crystals for the Micro-Polariscope,' in "Intellectual Observer," Vol. vi. (1865), p. 437.

‡ "Philosophical Transactions," 1819.

This property consists in the exhibition of different colours by these crystals, according to the direction in which the light is transmitted through them; a crystal of Chloride of Platinum, for example, appearing of a deep red when the light passes along its axis, and of a vivid green when the light is transmitted in the opposite direction, with various intermediate shades. It is only possessed by Doubly-Refracting substances; and it depends on the absorption of some of the coloured rays of the light which is polarized during its passage through the crystal, so that the two pencils formed by double refraction become differently coloured,—the degree of difference being regulated by the inclination of the incident ray to the axis of double refraction.

Acetate of Copper, <i>d</i>	Nitrate of Soda
——— of Manganese	——— of Strontian
——— of Soda	——— of Uranium
——— of Zinc	Oxalic acid
Alum	Oxalate of Ammonia
Arseniate of Potass	——— of Chromium
Asparagine	——— of Chromium and Ammonia, <i>d</i>
Aspartic Acid	——— of Chromium and Potass, <i>d</i>
Bicarbonate of Potass	——— of Lime
Bichromate of Potass	——— of Potass
Bichloride of Mercury	——— of Soda
Binoxalate of Chromium and Potass	Oxalurate of Ammonia
Bitartrate of Ammonia	Phosphate of Ammonia
——— of Lime	——— Ammoniaco-Magnesian (triple, of urine)
——— of Potass	——— of Lead, <i>d</i>
Boracic acid	——— of Soda
Borate of Ammonia	Platino-chloride of Thallium
——— of Soda (borax)	Platino-cyanide of Ammonia, <i>d</i>
Carbonate of Lime (from urine of horse)	Prussiate of Potass (red)
Carbonate of Potass	Ditto ditto (yellow)
——— of Soda	Quinidine
Chlorate of Potass	Salicine
Chloride of Barium	Saliginine
——— of Cobalt	Santonine
——— of Copper and Ammonia	Stearine
——— of Palladium, <i>d</i>	Sugar
——— of Sodium	Sulphate of Ammonia
Cholesterine	——— of Cadmium
Chromate of Potass	——— of Copper
Cinchonidine	——— of Copper and Ammonia
Citric Acid	——— of Copper and Magnesia
Cyanide of Mercury	——— of Copper and Potass
Hippuric Acid	——— of Iron
Hypermanganate of Potass	——— of Iron and Cobal
Iodide of Potassium	——— of Magnesia
——— of Quinine	——— of Nickel
Mannite	——— of Potassa
Margarine	——— of Soda
Murexide	——— of Zinc
Muriate of Ammonia	Tartaric Acid
Nitrate of Ammonia	Tartrate of Soda
——— of Barytes	Uric Acid
——— of Bismuth	Urate of Ammonia
——— of Copper	——— of Soda
——— of Potass	

It not unfrequently happens that a remarkably-beautiful specimen of Crystallization develops itself, which the observer desires to keep for display. In order to do this successfully, it is necessary to exclude the air; and Mr. Warrington recommends Castor-oil as the best preservative. A small quantity of this should be poured on the crystallized surface, a gentle warmth applied, and a thin glass cover then laid upon the drop and gradually pressed down; and after the superfluous oil has been removed from the margin, a coat of Gold-size or other varnish is to be applied.—Although most of the objects furnished by Vegetable and Animal structures, which are advantageously shown by Polarized light, have been already noticed in their appropriate places, it will be useful here to recapitulate the principal, with some additions.

<i>Vegetable.</i>	
Cuticles, Hairs, and Scales, from Leaves (§§ 281, 311)	Polyzoaries (§ 445)
Fibres of Cotton and Flax	Spicules of Gorgoniæ (§ 426)
Raphides (§ 293)	Tongues (Palates) of Gasteropods, mounted in Balsam (§ 474)
Spiral cells and vessels (§§ 291, 295)	Cuttle-fish bone (§ 469)
Starch-grains (§ 292)	Scales of Fishes (§§ 547, 548)
Wood, longitudinal sections of, mounted in balsam (§ 302)	Sections of Egg-shells (§ 599)
	———— of Hairs (§§ 551, 552)
	———— of Quills (§ 553)
	———— of Horns (§ 554)
	———— of Shells (§§ 458, 467)
	———— of Skin (§ 560)
	———— of Teeth (§§ 545, 546)
	———— of Tendon, longitudinal, (§ 558)
<i>Animal.</i>	
Fibres and Spicules of Sponges (§ 406)	
Polypidoms of Hydrozoa (§ 420)	

599. *Molecular Coalescence.*—Remarkable modifications are shown in the ordinary forms of Crystallizable substances, when the aggregation of the Inorganic particles takes place in the presence of certain kinds of Organic matter; and a class of facts of great interest in their bearing upon the mode of formation of various Calcified structures in the bodies of Animals, has been brought to light by the ingenious researches of Mr. Rainey,* whose method of experimenting essentially consists in bringing-about a slow decomposition of the Salts of Lime contained in Gum-arabic, by the agency of Subcarbonate of Potash. The result is the formation of spheroidal concretions of Carbonate of Lime, which progressively increase in diameter at the expense of an amorphous deposit which at first intervenes between them; two such spherules sometimes coalescing to produce ‘dumb-bells,’ whilst the coalescence of a larger number gives rise to the mulberry-like body shown in Fig. 412, *b*. The particles of such composite spherules appear subsequently to undergo re-arrangement according to a definite plan, of which the stages are shown at *c* and *d*; and it is upon

* See his Treatise “On the Mode of Formation of the Shells of Animals, of Bone, and of several other Structures, by a process of Molecular Coalescence, demonstrable in certain artificially-formed products” (1858); and his ‘Further Experiments and Observations’ in “Quart. Journ. of Microsc. Science,” N.S., Vol. i. (1861), p. 23.

this plan that the further increase takes place, by which such larger concretions as are shown at *a, a*, are gradually produced. The structure of these, especially when examined by Polarized light, is found to correspond very closely with that of the small calcareous concretions which are common in the Urine of the Horse, and which were at one time supposed to have a matrix of cellular structure. The small calcareous concretions termed '*Otolithes*,' or ear-stones, found in the Auditory sacs of Fishes, present an arrangement of their particles essentially the same. Similar concretionary spheroids have already been mentioned (§ 507) as occurring in the Skin of the Shrimp and other imperfectly-calcified Shells of Crustacea; they occur also in certain imperfect layers of the Shells of Mollusca; and we have a very good example of them in the outer layer of the envelope of what is commonly known as a 'soft Egg,' or an 'Egg without shell,' the Calcareous deposit in the fibrous matting already described (§ 558) being here insufficient to solidify it. In the external layer of an ordinary Egg-shell, on the other hand, the concretions have enlarged themselves by the progressive accretion of Calcareous particles, so as to form a con-

FIG. 412.

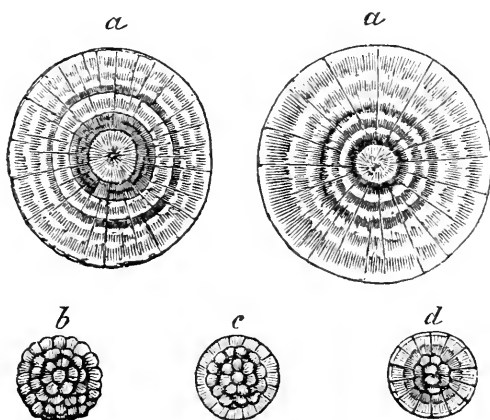

Artificial Concretions of Carbonate of Lime.

tinuous layer, which consists of a series of polygonal plates resembling those of a tessellated pavement.—In the solid 'shells' of the Eggs of the Ostrich and Cassowary, this concretionary layer is of considerable thickness; and vertical as well as horizontal sections of it are very interesting objects, showing also beautiful effects of colour under Polarized light.—From the researches of Prof. Williamson on the Scales of Fishes (§ 548), there can be no doubt that much of the Calcareous deposit which they contain is formed upon the same plan; and it is probable that by a further

study of the relations between their structure and that of true Bones and Teeth, the principle of 'molecular coalescence' will be found in some degree applicable to the explanation of the special peculiarities of the latter.—The inquiry opened-up by Mr. Rainey is one which may easily be pursued by any one who has leisure to devote to it; and will be almost certain to yield to the judicious cultivator a rich harvest of valuable results.

600. *Micro-Chemistry of Poisons*.—By a judicious combination of Microscopical with Chemical research, the application of Re-Agents may be made effectual for the detection of Poisonous or other substances, in quantities far more minute than have been previously supposed to be recognizable. Thus it is stated by Dr. Wormley* that Micro-Chemical analysis enables us by a very few minutes' labour to recognize with unerring certainty the reaction of the 100,000th part of a grain of either Hydrocyanic Acid, Mercury, or Arsenic; and that in many other instances we can easily detect by its means the presence of very minute quantities of substances, the true nature of which could only be otherwise determined in comparatively large quantity, and by considerable labour. This inquiry may be prosecuted, however, not only by the application of ordinary Chemical Tests under the Microscope, but also by the use of other means of recognition which the use of the Microscope affords. Thus it was originally shown by Dr. Guy† that by the careful sublimation of Arsenic and Arsenious Acid,—the sublimate being deposited upon small disks of thin-glass,—these are distinctly recognizable by the forms they present under the Microscope (especially the Binocular) in extremely minute quantities; and that the same method of procedure may be applied to the volatile metals, Mercury, Cadmium, Selenium, Tellurium, and some of their Salts, and to some other volatile bodies, as Sal-Ammoniac, Camphor, and Sulphur. The method of Sublimation was afterwards extended by Dr. Helwig‡ to the Vegetable Alkaloids, such as Morphine, Strychnine, Veratrine, &c. And subsequently Dr. Guy, repeating and confirming Dr. Helwig's observations, has shown that the same method may be further extended to such Animal products as the constituents of the Blood and of Urine, and to volatile and decomposable Organic substances generally.§ It may be anticipated that by the careful prosecution of Micro-Chemical inquiry, especially with the aid of the Spectroscope, the detection of Poisons and other substances in very minute quantity will come to be accomplished with such facility and certainty as have until lately been scarcely conceivable.

* "Micro-Chemistry of Poisons," New York, 1867.

† "On the Microscopic Characters of the Crystals of Arsenious Acid," in 'Trans. of Microsc. Society,' Vol. ix. (1861), p. 50.

‡ "Das Mikroskop in der Toxikologie," 1865.

§ "On Microscopic Sublimates; and especially on the Sublimates of the Alkaloids," in 'Trans. of Royal Microsc. Soc.,' Vol. xvi. (1868), p. 1; also "Pharmaceutical Journal," June to September, 1867.

INDEX.

- ABERRATION**, Chromatic, 9—11.
 ————— Spherical, 12—14.
 ————— means of reducing
 and correcting, 10—16.
Acalephs, see *Medusæ*.
Acanthometrina, 526.
Acarida, 685, 686.
Achlya prolifera, 327, 328.
Achnanthes, 304, 305.
Achromatic Condenser, 123—126 ;
 use of, 170, 171.
Achromatic Correction, principle
 of, 13, 14.
Achromatic Objectives, see **Object-
 Glasses**.
Acineta-parasitism in *Infusoria*,
 465, 466.
Acrocladia, spines of, 558, 559.
Actiniform Zoophytes, 552—554.
Actinocyclus, 298.
Actinophrys, 438—442 ; reproduc-
 tion of, 446, 447.
Actinoptychus, 299.
Actinotrocha-larva of *Sipunculus*,
 629, 630.
 Adipose tissue, 721, 722.
Adjustment of Focus, 42, 43, 146—
 149.
Adjustment of Object-glass, 16—18,
 149—152.
Æthaliium septicum, 361, 362.
 Agamic reproduction, of *Rotifera*,
 476 ; of *Entomostraca*, 643 ; of
Insecta, 684, 685.
 Agarics, generation of, 365.
 Agassiz, Prof., on scales of *Fish*,
 702.
 Agates, sponge-remains in, 758.
Agrion, circulation in larva of, 672.
 Air-bubbles, Microscopic appear-
 ances of, 167, 168 ; in Microscopic
 preparations, 233.
Air-Pump, use of in mounting ob-
 jects, 216, 235.
Albuminous substances, tests for,
 197, 198.
- Albumum**, 402, 410.
Alcyonian Zoophytes, 550—552.
Alcyonidium, 589.
ALGÆ, higher, microscopic struc-
 ture of, 343—350 ; (see **Proto-
 phyta**).
 Allman, Prof., on *Cordylophora*,
 538 ; on *Fresh-water Polyzoa*,
 582 *note* ; on *Appendicularia*, 591
note.
Alternation of Generations, 385,
 539 *note*, 547 *note*.
Alveolina, 491, 492.
Amaranthus, seeds of, 431, 432.
Amaroucium, 585—588.
 Amici, Prof., his early construction
 of **Achromatic lenses**, 14, 15 ; his
Prism for oblique illumination,
 112 ; his drawing *Camera*, 100.
Amœba, 442—445 ; reproduction of,
 446, 447.
Amœboid state of Volvox, 255—
 257 ; of protoplasm of *Chara*, 342
note ; of protoplasm of roots of
Mosses, 371 ; of *Myxogastric*
Fungi, 361 ; of colourless *Blood-
 corpuscles*, 712.
Amphistegina, 506.
Amphitetras, 302.
Anacharis alsinastrum, formation
 of cells in, 390, 391 ; cyclosis in,
 391, 392.
Anagallis, spiral vessels in petal of,
 426.
Androspores of CEdogonium, 333,
 334.
Anguillulæ, 623.
Angular Aperture of Object-glasses,
 11, 14—16 ; means of determin-
 ing, 172 *note* ; limitation of, for
Binocular, 38—40 ; real value of,
 170—175.
Angulifera, 302.
Animalcule-Cage, 130, 153.
ANIMALCULES, 451 ; see *Infusoria*,
Rhizopoda, and *Rotifera*.

- Animals, distinction of, from Plants, 239—241, 434, 435.
- ANNELIDA, 626—635; marine, circulation in, 627, 628; metamorphoses of, 628—630; remarkable forms of, 630—634; luminosity of, 634; fresh-water, 634, 635.
- Annual Layers of Wood, 409, 410.
- Annular Ducts, 403.
- ANNULOSA, 621; see Entozoa, Turbellaria, and Annelida.
- Annulus of Ferns, 377.
- Anodon*, parasitic embryo of, 610, 611; ciliary action on gills of, 618.
- Anomia*, fungi in shell of, 359.
- Ant*, Red, integument of, 655.
- Antedon*, development of, 573—575.
- Antennæ of Insects, 664—667.
- Antheridia, of *Marchantia*, 369; of Mosses, 371; of Ferns, 380; —see Antherozoids.
- Antherozoids, of *Volvox*, 258; of *Vaucheria*, 326; of *Sphaeroplea*, 332; of *Oedogonium*, 333; of *Characeæ*, 340; of *Fuci*, 347; of *Florideæ*, 349; of *Marchantia*, 369; of Mosses, 371; of Ferns, 380.
- Anthers, structure of, 426, 427.
- Anthozoa*, 350—354.
- Antirrhinum*, seeds of, 431, 432.
- Aperture, Angular, see Angular Aperture.
- Aphides*, agamic reproduction of, 684, 685.
- Aphthæ, fungus of, 358.
- Apothecia of Lichens, 351.
- Appendicularia*, 591, 592.
- Apple*, cuticle of, 417, 418.
- Aptinotychus*, 299.
- Apus*, 641, 642.
- Aquarium Microscope, 85.
- Aquatic Box, 130, 153.
- ARACHNIDA, microscopic forms of, 685, 686; eyes of, 687; respiratory organs of, 687; feet of, 687, 688; spinning apparatus of, 687, 688.
- Arachnoidiscus*, 300.
- Aralia*, cellular parenchyma of, 387.
- Arcella*, 445, 446.
- Archegonia, of *Marchantia*, 369; of Mosses, 372; of Ferns, 380—382.
- Arenicola*, 628.
- Areolar tissue, 716.
- Argulus*, 645, 646.
- Artemia*, 639, 642.
- Ascaris*, 622; fungous vegetation on, 358.
- Asci of Lichens, 351; of Fungi, 361.
- Ascidia parallelogramma*, 584, 585.
- Ascidians*, 584; Compound, 585—587; Social, 588—590; development of, 590—592.
- Asphalte-varnish, 205.
- Aspidisca*-form of *Trichoda*, 462.
- Aspidium*, fructification of, 377.
- Asplanchna*, 475, 479.
- Asteriada*, skeleton of, 562; metamorphoses of, 568—570.
- Asteroida*, 550.
- Asterolampira*, 298.
- Asteromphalus*, 298.
- Astrophyton*, 562, 563.
- Astrorhiza*, 445.
- Auditory vesicles of Mollusks, 619, 620; development of, 614, 617.
- Aulacodiscus*, 301.
- Avicula*, naere of, 598.
- Avicularia of Polyzoa, 582, 583.
- Axis-cylinder of Nerve-fibres, 730; ultimate distribution of, 731.
- Azure-blue* butterfly, scales of, 657.
- Bacillaria paradoxa*, 293, 294; movements of, 288.
- Bacteriastrium*, 303.
- Bailey, Prof., his Diatomaceous tests, 182; on siliceous cuticle, 383; on internal siliceous casts of Foraminifera, 507 *note*.
- Baker, Mr., his Travelling Microscope, 83, 84; his Air-pump, 216 *note*; his Pond-stick, 236.
- Balani*, metamorphoses of, 646—648.
- Balbani, M., on generation of Infusoria, 463—465.
- Balsam, Canada, see Canada Balsam.
- Barbadoes, Polycystina of, 525.
- Bark, structure of, 413.
- Barnacles*, metamorphoses of, 646—648.
- Basidia of Fungi, 361.
- Bat*, hair of, 704, 705; cartilage of ear of, 723.
- Batrachospermæ*, 336, 337.
- Battledoor scale of *Polyommatus*, 657.
- Beale, Prof., his Pocket Microscope, 82; his Demonstrating Microscope, 83; his preservative liquid, 220; his blue Injection, 744; his method of making thin-glass cells, 226; of making deep cells, 231; his Staining-fluid, 198, 199, 744; his views of Tissue-formation, 690—693; his mode of making minute preparations, 199, 200, 728; his observations on Blood-corpuscles, 709.

- Beck, Mr. R., his Dissecting Microscope, 53—55; his Disk-holder, 128; his Side-Reflector, 122, 123; his Vertical Illuminator, 125, 126; on scale of Podura, 658, 659; on Spider's threads, 688:—see Smith and Beck.
- Bee, eyes of, 661—663; antennæ of, 667; hairs of, 659; proboscis of, 668, 669; wings of, 678; sting of, 682; reproduction of, 685.
- Berg-mehl, 313.
- Berøe, 547, 548.
- Biddulphia*, 301; markings on, 278; self-division of, 283, 284.
- Biliary Follicles, 724.
- Biloculina*, 489.
- Binary Subdivision, of Palmogkæa, 244; of Protococcus, 247, 248; of Desmidiaceæ, 262—265; of Diatomaceæ, 282—285; of Coniferae, 330, 331; of cells of Phanerogamia, 390; of Protozoa, 446, 448; of Infusoria, 457, 458; of Cartilage-cells, 723.
- Binocular Eye-piece, 35.
- Magnifier, Nacet's, 53—55; Smith and Beck's, 186 note.
- Microscopes, Stereoscopic, principles of construction of, 27—31; advantages of, 40, 41; Objectives appropriate to, 38—40; different forms of, Compound, 31—36; Simple, 53—55; Student's, 71—76; Non-Stereoscopic, 87.
- Vision, 27—30, 40, 41.
- Bipinnaria*-larva of Star-fish, 568, 569.
- Bird, Dr. Golding, on preparation of Zoophytes, 543.
- BIRDS, bone of, 695; feathers of, 707, 708; blood of, 709—711; lungs of, 747, 748.
- Bird's-head processes of Polyzoa, 582, 583.
- Bivalve Mollusks, shells of, 593—603.
- Black-ground Illuminators, 114—117, 160.
- Black-Japan varnish, 205.
- Blenny*, viviparous, scales of, 701.
- Blight, of Corn, 362—364.
- Blood-disks of Vertebrata, 709—713; mode of examining and preserving, 713; circulation of, see Circulation.
- Blood-vessels, injection of, 740—746; disposition of, in different parts, 745—749.
- Bockett, Mr., his Lamp, 141.
- Bone, structure of, 693—696; mode of making sections of, 696, 697.
- Bones, fossil, examination of, 764.
- Botryllans*, 587, 588.
- Botrytis bassiana*, 354, 355.
- Bowerbank, Dr., his researches on Sponges, 527—531; on structure of Shells, 596, 644; on Agates, &c., 758.
- Bowerbankia*, 580.
- Brachionus*, 470, 472, 479.
- BRACHIOPODA, structure of Shell of, 601—603.
- Branchiopoda*, 639—642.
- Branchipus*, 642.
- Braun, Prof., on development of *Pediastrea*, 270—272.
- Brewster, Sir D., on single magnifiers, 21, 22; on siliceous cuticles, 283; on structure of Nacre, 598; on Dichroism, 767.
- Brightwell, Mr., on Diatomaceæ, 302 note, 303; on *Asplachna*, 475 note; on *Noctiluca*, 550 note.
- Brooke, Mr., his nose-piece, 102.
- Browning, Mr., his Spectroscope Eye-piece, 92, 93.
- Bryozoa*, see POLYZOA.
- Brunswick-black varnish, 205.
- Buccinum*, tongue of, 607, 609; egg-capsules of, 613; development of, 615.
- Bugs*, 653; wings of, 679.
- Bugula auricularia*, 582, 583.
- Built-up Cells, 230, 231.
- Bulbels of Chara, 340; of *Marchantia*, 367.
- Bulinina*, 502.
- Bull's Eye Condenser, 121, 122; use of, 161—163.
- Burdock*, stem of, 415.
- Busk, Mr. G., on *Volvox*, 252—258; on Polyzoa, 584.
- Butterflies, see Lepidoptera.
- Cabinets, Microscopic, 235.
- Cactus*, raphides of, 400.
- Calcaire Grossier, 757.
- Calcarina*, 504, 505.
- Calycanthus*, stem of, 414.
- Calyptra of Mosses, 374.
- Cambium-layer, 413.
- Camera Lucida, 98—101; use of in Micrometry, 102.
- Campanularidæ*, 540, 541.
- Campylodiscus*, 295.
- Canada Balsam, use of as Cement, 205, 206; mounting of objects in, 211—220.
- Canaliculi of Bone, 695, 696.

- Canal-system of Foraminifera, 488, 504, 505, 507—519.
- Capillaries, circulation in, 733—736; injection of, 740—745; distribution of, 746—749.
- Capsule of Mosses, 734; of Ferns, 377.
- Carminic Injections, 743, 744; Staining-liquid, 198, 744.
- Carp, scales of, 701, 702.
- Carpenteria*, 501.
- Carrot, seeds of, 433.
- Carter, Mr. H. J., on Volvox, 255, 258 *note*; on production of Rhizopods from Plants, 342 *note*; on sexes in Rhizopods, 447; on development of Sponges, 527.
- Cartilage, structure of, 722—724.
- Caryophyllia*, 552.
- Caryophyllum*, seeds of, 431, 432.
- Caterpillars, feet of, 632.
- Cells for mounting objects, of Cement, 225, 226; of Thin-glass, 226, 227; of Plate-glass, 227, 228; of Metal, 229, 230; built-up, 230, 231; mounting objects in, 231—234.
- Cells, Animal, formation of, 689—692.
- Cells, Vegetable, 386—401; nature of, 241, 245; formation of, 390, 391; cyclosis in, 391—395; thickening deposits in, 395—397; spiral deposits in, 397, 398; starch-grains in, 398—400; raphides in, 400, 401.
- Cellular Tissue, Animal, 716.
 Vegetable, ordinary form of, 387, 388; stellate, 388, 389; formation of, 390, 391.
- Cellulose, 242.
- Cements, Microscopic, 204—207.
- Cement-Cells, mode of making, 225, 226.
- Cementum of Teeth, 698—700.
- CEPHALOPODS, shell of, 605; chromatophores of, 620.
- Ceramiaceæ*, 348—350.
- Cestoid Entozoa*, 621, 622.
- Chætocerae*, 302, 303.
- Chætophoraceæ*, 336.
- Chalk, Foraminifera, &c., of, 756—759.
- Characeæ*, 338—342; cyclosis of fluid in, 338; multiplication of by gonidia, 340; sexual apparatus of, 340—342.
- Cheilostomata*, 581.
- Cherry-stone, cells of, 396.
- Chemical Re-agents, use of in Microscopic research, 195—198, 776.
- Chevalier, M., his early construction of Achromatic objectives, 15; his drawing Camera, 100, 101.
- Chilodon*, teeth of, 454; self-division of, 458.
- Chirodota*, calcareous skeleton of, 567.
- Chitine of Insects, 654.
- Chlorophyll, 242.
- Choroid, pigment of, 719.
- Chromatic Aberration, 9—11; means of reducing and correcting, 13—16.
- Chromatophores of Cephalopods, 620.
- Chyle, corpuscles of, 712.
- Cidaris*, spines of, 559.
- Ciliary action, nature of, 467, 468; in Protophytes, 241, 248, 251; in Infusoria, 453, 454; on gills of Mollusks, 618; on Epithelium of Vertebrata, 721.
- Ciliobrachiata*, 578.
- Circulation of Blood, in Vertebrata, 733—740; in Insects, 671, 672; alternating, in Tunicata, 585, 589.
- Circulation, Vegetable, see Cyclosis.
- Cirrhipeds*, metamorphoses of, 646—648.
- Cladocera*, 641.
- Claparède and Lachmann, on Lieberkühnia, 437; on Amœba, 444; on Infusoria, 481 *note*.
- Clarke, Mr. J. L., his mode of preparing sections of Spinal Cord, 733 *note*.
- Clavellinidæ*, 588—590.
- Cleanliness, importance of, to Microscope, 143, 144; in mounting objects, 234.
- Clematis*, stem of, 409.
- Closterium*, movement of fluid in, 260—262; binary subdivision of, 263, 264; multiplication of by gonidia, 265; conjugation of, 265—267.
- Clypeaster*, spines of, 559.
- Coal, nature of, 752—754.
- Coalescence, molecular, 774, 775.
- Cobweb-Michrometer, 93—95.
- Cocconeidæ*, 303, 304.
- Cockchafer*, cellular integument of, 654; eyes of, 662; antenna of, 665, 666; spiracle of larva of, 676.
- Cockle of Wheat, 623.
- Coddington lens, 21, 22.
- Cœnurus*, 622.
- Cohn, Dr., his account of various states of Protococcus, 246—251;

- his researches on Volvox, 257, 258; on Stephanosphaera, 259; on Sphaeroplea, 332, 333; on reproduction of Rotifera, 476.
- Coleoptera*, integument of, 654; antennæ of, 665, 666; mouth of, 667.
- Coleps*, voracity of, 456.
- Collection of Objects, general directions for, 235—238.
- Collins, Mr., his Harley Binocular, 74—76; his Eye-piece caps, 74; his Aquarium Microscope, 85; his Graduating Diaphragm, 107, 111; his Air-pump, 216 *note*.
- Collomia*, spiral fibres of, 398.
- Colonial nervous system of Polyzoa, 579, 580.
- Colourless corpuscles of Blood, 711, 712.
- Columella of Mosses, 375.
- Comatula*, metamorphosis of, 573—575.
- Compound Microscope, optical principles of, 23—27; mechanical construction of, 56, 57; Third-Class, 57—64; Second-Class, 64—75; First-Class, 76—82; for Special purposes, 82—88.
- Compressorium, 133—135; use of, 153, 154.
- Concave lenses, refraction by, 8.
- Conceptacles of Marchantia, 367, 368.
- Concretions, calcareous, 774, 775.
- Condenser, Achromatic, 107—111; use of, 157—160.
- Hemispherical, 113, 114.
- for Opaque objects, ordinary, 120, 121; Bull's-eye, 121, 122; mode of using, 161—163.
- Confervacæ*, 330; self-division of, 330, 331; zoospores of, 331, 332; sexual reproduction of, 332—336.
- Conifera*, peculiar woody fibre of, 402; absence of ducts in, 404, 409; fossil, 752.
- Conjugatæ*, 334, 336.
- Conjugation, of Palmoglaea, 245; of Desmidiaceæ, 265—267; of Diatomaceæ, 285—287; of Conjugatæ, 334, 335; (supposed) of Actinophrys, 447; of Gregarinida, 449; of Intusoria, 463—465.
- Connective Tissue, 716; corpuscles of, 692, 715, 716.
- Conochilus*, 475.
- Contractile vesicle, of Volvox, 252, 253; of Actinophrys, 441; of Intusoria, 457.
- Conversion of Relief, 29, 30—37.
- Convex lenses, refraction by, 4—8; formation of images by, 9.
- Copepoda*, 640.
- Coquilla-nut, cells of, 396.
- Coral, 552.
- Corallines*, true, 350; Zoophytic, 540.
- Cordylophora*, 538, 539.
- Cork, 413.
- Corn, blights of, 362, 363.
- Corn-grains, husk of, 433.
- Corns, structure of, 720.
- Cornuspira*, 489.
- Corpuscles of Blood, 709—713.
- Correction of Object-glasses, for Spherical Aberration, 10, 11; for Chromatic Aberration, 13—16; for thickness of covering glass, 16—18, 149—152.
- Corpuactis*, thread-cells of, 554.
- Corynida*, 537—539.
- Coscinodisceæ*, 297, 298.
- Cosmrium*, swarming of granules in, 262; self-division of, 263; conjugation of, 266; development of, 267.
- Crab*, shell-structure of, 648, 649; metamorphoses of, 649, 650.
- Crabro*, integument of, 655.
- Crag-Formation, 759.
- Cricket*, gastric teeth of, 671; sounds produced by, 679.
- Crinoidea*, skeleton of, 563; metamorphosis of, 573—575.
- Cristatella*, 582.
- Cristellaria*, 500.
- Crouch, Mr., his Educational Microscope, 59, 60; his Student's, 61; his Student's Binocular, 71; his Adapter for Beck's Side-Reflector, 123.
- Crusta Petrosa of Teeth, 698—700.
- CRUSTACEA, 636—651; lower forms of, 636—638; Entomostracous, 638—645; Suctorial, 645, 646; Cirrhiped, 646—648; Malacostracous, 648—650; Decapod, shell of, 648—658; metamorphoses of, 649—650.
- CRYPTOGAMIA, plan of structure of, 384, 385; see Protophyta, Algæ, Mosses, &c.
- Crystallization, Microscopic, 768—774.
- Ctenoid scales of Fish, 701, 702.
- Ctenosomata*, 581.
- Curculionida*, integument of, 655, 660; foot of, 680.
- Cuticle, of Animals, 718; of Equisetaceæ, 383; of Flowering Plants, 417—424.
- Cutis Vera, 717.

- Cuttle-fish*, shell of, 605; embryo of, 620.
- Cyanthus*, seeds of, 433.
- Cycloclypeus*, 514.
- Cycloid scales of Fish, 702.
- Cyclops*, 640, 641; fertility of, 643.
- Cyclosis, in Closterium, 260—262; in Diatomaceæ, 274, 275; in Chara, 338—340; in Cells of Phanerogamia, 391—395; in Rhizopods, 437.
- Cyclostomata*, 581.
- Cydippe*, 547, 548.
- Cymbellæ*, 306.
- Cynipidæ*, ovipositor of, 682.
- Cypris*, 639.
- Cypræa*, structure of shell of, 604.
- Cystic Entozoa*, 622.
- Cysticerus*, 622.
- Cytherina*, 639, 758.
- Dactylocalix*, 528.
- Dalrymple, Mr., on Notommata, 474.
- Dalyell, Sir J. G., on development of Medusæ, 544—547.
- Daphnia*, 641; ephippial eggs of, 643, 644; development of, 645.
- Darwin, Mr. C., on Pampean formation, 761.
- Davies, Mr., on Microscopic Crystallization, 770 note.
- Dawson, Dr., on Eozoon Canadense, 517.
- Deane's Gelatine, 221.
- De Bary, Dr., on Myxogastric Fungi, 361, 362.
- Decapod Crustacea*, shell of, 648, 649; metamorphoses of, 640, 650.
- Defining power of Object-glasses, 170, 171.
- Demodex folliculorum*, 686.
- Demonstrating Microscope, Beale's, 83.
- Dendritina*, 490.
- Dendrodus*, teeth of, 762.
- Dentine of Teeth, 697, 698.
- Depressions, distinction of, from elevations, 167.
- Dermestes*, hair of, 659.
- Desmidiaceæ*, general structure of, 259, 260; movement of fluid in, 260—262; binary subdivision of, 262—265; formation of gonidia by, 265; origination and multiplication of varieties in, 273; conjugation of, 265—267; development of, 267; classification of, 267—269; collection of, 269, 270.
- Deutzia*, stellate hairs of, 420.
- Development, of Annelida, 628—634; of Anodon, 610, 611; of Ascidians, 590; of Balanus, 647; of Cirrhipeds, 646—648; of Crab, 649; of Cyclops, 640, 641; of Daphnia, 643, 644; of Desmidiaceæ, 266, 267; of Diatomaceæ, 287; of Echinodermata, 568—575; of Embryo (Animal), 749; of Embryo (Vegetable), 429—431; of Entomostraca, 640—645; of Ferns, 376—382; of Gastropods, 611—618; of Leaves, 390, 391; of Medusæ, 544—547; of Mosses, 375, 376; of Nudibranchiata, 612—614; of Palmogloea, 245; of Pollen-grains, 427; of Protococcus, 247—249; of Purpura, 614—618; of Sponges, 531; of Tunicata, 590; of Volvox, 253—255.
- Diamond-beetle*, 655, 660; foot of, 680.
- Diaphragm Eye-piece, Slack's, 98.
- Diaphragm-Plate, 106—111.
- Diatom-finder, Tomkins's, 50 note; Stanhoscope, 22.
- Diatoma*, 292, 293.
- Diatomaceæ*, Vegetable nature of, 273—275; cohesion of frustules of, 275, 276; siliceous envelope of, 276—278; markings of, 278—282; self-division of, 282—284; gonidia of, 284; conjugation of, 285—287; limits of species of, 287; movements of, 287—289; classification of, 289, 290; general habits of, 310, 311; fossilized deposits of, 311—313, 314, 755; collection of, 316, 317; mounting of, 316, 317; their value as tests, 178—181.
- Dichroism, 772.
- Dicotyledonous Stems, structure of, 408—415.
- Dictyoloma*, seeds of, 432.
- Didemnians*, 587, 588.
- Didymoprium*, self-division of, 262; conjugation of, 266, 268.
- Differentiation, progressive, in Vegetable Cell-formation, 242, 390; in Animal Cell-formation, 691.
- Diplugia*, 445.
- Diffraction of Light, errors arising from, 165, 166.
- Diphtheria, fungus of, 358.
- Dipping-Tubes, 135.
- Diptera*, mouth of, 668; halteres of, 679; ovipositors of, 683.
- Discorbina*, 503.

- Disk-holder, Beck's, 128; Morris's, 129.
- Dispersion, chromatic, 12.
- Dissecting Microscope, Quekett's simple, 51—53; Beck's, 53—55; Nacet's, 55; Smith and Beck's Compound, 91.
- Dissection, Microscopic, 185—188.
- Distoma*, 625.
- Dobie, Dr., on ciliary action in Sponges, 527.
- Dog*, epidermis of foot of, 719.
- D'Orbigny, M., his Classification of Foraminifera, 485, 486.
- Doris*, tongue of, 608; spicular skeleton of, 604; development of, 611—613.
- Dorsal Vessel of Insects, 771, 772.
- Dotted Ducts, 403, 404.
- Double-bodied Microscope, 87.
- Doublet, Wollaston's, 21.
- Doublet-Microscope, 48—50.
- Dragon-fly*, eyes of, 662; larva of, 672, 676.
- Draw-Tube, 89, 90.
- Dropping Bottle, 224.
- Drosera*, hairs of, 419.
- Dry-mounting of objects, 208—211.
- Ducts, of Plants, 403, 404.
- Dujardin, M., on Sarcodæ, 434; on Rhizopoda, 435; on Sponges, 527; on Foraminifera, 484; on Rotifera, 477—480.
- Duramen, 402, 410.
- Dusideia*, skeleton of, 530.
- Dytiscus*, foot of, 689, 690; trachea and spiracle of, 675.
- Eagle-Ray*, teeth of, 699.
- Earwig*, wings of, 678.
- Ecremocarpus*, seeds of, 432.
- Echinida*, shell of, 555, 556; ambulacral disks of, 556, 557; spines of, 557—559, 563—565; pedicellariæ of, 569; teeth of, 560—562; metamorphosis of, 570—572.
- ECHINODERMATA, skeleton of, 555—567; metamorphoses of, 567—575.
- Ectocarpæ*, 345.
- Ectosarc of Rhizopoda, 436.
- Educational Microscopes, 58—61.
- Eel*, scales of, 701; gills of, 746, 747.
- Eels*, of Paste and Vinegar, 623.
- Eggs of Insects, 683—685; see Winter-eggs.
- Egg-shell, fibrous structure of, 714; calcareous deposit in, 774, 775.
- Ehrenberg, Prof., his researches on Infusoria, 451, 452; on Rotifera, 472, 475, 477; on Polycystina, 525, 526 *note*; on composition of Green-sands, 507 *note*.
- Elastic Ligaments, 715.
- Elaters of Marchantia, 369.
- Elementary Parts of Animal body, 690; see Tissues.
- Elevations, distinction of, from depressions, 167.
- Elytra of Beetles, 678.
- Embryo, Animal, development of, 749;—see Development.
- Vegetable, development of, 429—431.
- Embryo-cell, 369, 372.
- Enamel of Teeth, 698—700.
- Enerinites*, 563, 573.
- Encysting process of Infusoria, 458—462.
- Endoelme of Vegetable cell, 242; of Diatomaceæ, 212.
- Endogenous Stems, structure of, 406—408.
- Endosarc of Rhizopoda, 436.
- Enteroobryus*, 356—358.
- Entomostracous Crustacea*, 638; classification of, 639—642; reproduction of, 642—645.
- Eutozoa*, 621; Cystic, 622; Nematoid, 622, 623; Trematode, 625.
- Eozoic Limestones, 760.
- Eozoon Canadense*, 517—521.
- Ephemera*, larva of, 653, 654, 672.
- Ephippium of Daphnia, 643, 644.
- Epidermis of Animals, structure of, 718—720.
- of Plants, 420.
- Epithelium, 720, 724; ciliated, 721.
- Epithemia*, 290; conjugation of, 285, 286.
- Equisetaceæ*, cuticle of, 383; spores of, 383, 384.
- Erecting prism, Nacet's, 91.
- Erector, Lister's, 90.
- Errors of Interpretation, 164—170.
- Eudendrium*, 540.
- Eunoticeæ*, 290, 291.
- Euplectella*, 528, 529.
- Eupodisceæ*, 301.
- Euryale*, skeleton of, 562, 563.
- Exogenous Stems, structure and development of, 408—415.
- Eyes, care of, 142, 143.
- Eyes of Mollusks, 619; of Insects, 661—664; of Trilobite, 761, 762.
- Eye-piece, 25; Huyghenian, 25, 26; Ramsden's, 26, 27; Kellner's, 27; Binocular, 35; Erecting, 91; Spectroscope, 92; Micrometric, 93—97.
- Collins's shades for, 74.

- Falconer, Dr., on bones of fossil Tortoise, 764.
- Fallacies of Microscopists, 164—170.
- Farrants's Medium, 222.
- Farre, Dr. A., his researches on *Bowerbankia*, 580.
- Fat-cells, 721, 722; capillaries of, 745.
- Feathers, structure of, 704, 707, 708.
- Feet of Insects, 680—682; of Spiders, 687, 688.
- Fermentation, influence of vegetation on, 353.
- FERNS, 376—383; fructification of, 376—378; spores of, 379, 380; prothallium of, 380; antheridia of, 380; archegonia of, 380—382; generation and development of, 382.
- Fertilization of ovule, in Flowering plants, 429, 430.
- Fibre-cells of anthers, 427; of seeds, 397, 398.
- Fibres, Muscular, 726—729.
 ——— Nervous, 729—732.
 ——— Spiral, of Plants, 397, 398, 402, 403.
- Fibrillæ of Muscle, structure of, 727.
- Fibro-Cartilage, 724.
- Fibro-Vascular Tissue, 401, 415.
- Fibrous Tissues of Animals, 714—717; formation of, 692.
- Field's Educational Microscope, 58, 59.
 ——— Simple Microscope, 50, 51.
- Filiferous capsules of Zoophytes, 553, 554.
- Finders, 104—106.
- Fine Adjustment, 43; uses of, 148, 149.
- Pin-feet of Branchiopoda, 639, 642.
- FISHES, bone of, 693—696; teeth of, 697—700; scales of, 700—702; blood of, 709—711; circulation in, 736; gills of, 746, 747.
- Fishing-tubes, 135.
- Flatness of field of Object-glasses, 173, 174.
- Flint, organic structure in, 758; examination of, 759.
- Flint-Glass, dispersive power of, 13.
- Florideæ*, 348—350.
- Floscularians*, 477, 478.
- Flowers, small, as Microscopic objects, 425; structure of parts of, 425—431.
- Fluid, mounting objects in, 223—225; 231—234.
- Fluke*, 625.
- Flustra*, 577—581.
- Fly*, number of objects furnished by, 652; circulation in, 672; tongue of, 668; spiracle of, 675; wing of, 678; foot of, 680, 681.
- Focal Adjustment, 146; precautions in making, 147; errors arising from imperfection of, 148, 149, 166, 167.
- Focal Depth of Objectives, 171, 172; increase of with Binocular 40.
- Focke, on *Closterium*, 265; on *Diatomaceæ*, 289.
- Follicles of Glands, 724, 725.
- Foot of Fly, 680; of *Dytiscus*, 681, 682; of Spider, 687, 688.
- FORAMINIFERA, 482—523; their relation to Rhizopods, 438; to Sponges, 501; their general structure, 482—489; principal types of, 489—521; collection and mounting of, 521—523; fossil deposits of, 489, 491, 492, 498, 505, 507 note, 510, 517—521, 755—757; mode of making sections of, 192 note.
- Forbes, Mr. D., on structure of Rocks, 765—767.
- Forceps, 136; stage, 127; slider 214.
- Forficulidæ*, wings of, 678.
- Formed Material, 691—693.
- Fossil Bone, 764.
 ——— *Diatomaceæ*, 311—314, 755.
 ——— *Foraminifera*, 489, 491, 492, 498, 505, 507 note, 510, 517—521, 755—757.
 ——— *Polycystina*, 524—526.
 ——— Sponges, 758.
 ——— Teeth, 762, 763.
 ——— Wood, 751, 752.
- Fowl*, lung of, 748.
- Fragillariæ*, 293.
- Frog*, blood of, 710, 711; pigment-cells of, 719, 720; circulation in web of, 733—735; in tongue of, 735; in lung of, 739; structure of lung of, 747, 748.
- Fructification, of Fuci, 345—348; of *Florideæ*, 349, 350; of Lichens, 351, 352; of Fungi, 365; of *Marchantia*, 368, 369; of Mosses, 371—375; of Ferns, 376—379; of *Equisetaceæ*, 383.
- Frustules, of *Diatomaceæ*, 275, 276.
- Fucaceæ*, 345; sexual apparatus of, 345—348; development of, 348.
- Fungi*, simplest forms of, 352, 353; in bodies of living Animals, 353

- 360; in substance, or on surface, of Plants, 362—364; Amœboid states of, 361, 362; higher forms of, 364, 365.
- Fungia*, 552.
- Furcularians*, 479.
- Furlong, Mr., on Polycystina, 526 *note*.
- Fusulina*, 505, 506.
- Gad-flies*, ovipositor of, 683.
- Gairdner's Doublet Microscope, 48—50.
- Gall-flies*, ovipositor of, 682.
- Gallionella*, 296.
- Galls of Plants, 682.
- Ganglion-Cells, 729, 730.
- Ganoid scales of Fish, 702, 703.
- GASTEROPODA, structure of Shell of, 603, 604; tongues of, 605—610; development of, 611—618; organs of sense of, 619, 620.
- Gastric teeth of Insects, 671.
- Gelatine, Deane's, 221; see Glycerine-jelly.
- Gelatinous Nerve-fibres, 730, 731.
- Generation, distinguished from Growth, 245.
- Geology, applications of Microscope to, 751—764.
- Geranium*-petal, peculiar cells of, 425, 426.
- Germ-cells, 335.
- Germinal Matter, 690—693.
- Gills, of Mollusks, ciliary motion on, 618; of Fishes, distribution of vessels in, 746, 747; of Waternewt, circulation in, 736.
- Gillett's White-Cloud Illuminator, 118.
- Gizzard, of Bowerbankia, 578; of Insects, 671.
- Glands, structure of, 724, 725.
- Glandular woody fibre of Coniferæ, 402.
- Glass Slides, 201.
- Thin, 202—204.
- Glaucium*, cyclosis in hairs of, 394.
- Globigerina*, 501, 520.
- Globigerinida*, 500—506.
- Glochidium*, 610, 611.
- Glue, Liquid, use of, 205.
- Marine, use of, 206, 207.
- Glycerine, use of, in mounting objects, 199, 200, 220—222.
- Glycerine-Jelly, Lawrence's, 221; Rimmington's, 222 *note*.
- Glycerine-Medium, Farrants's, 222.
- Gnats*, scales of, 657; larvæ of, 672.
- Goadby's Solution, 223.
- Gold-size, use of, 205, 206.
- Goniometer, 77, 97.
- Gomphonemæ*, 306, 307.
- Gonidia, multiplication by, in Desmidiaceæ, 265; in *Pedastree*, 270; in Diatomaceæ, 284, 285; in *Hydrodictyon*, 329; in *Chara*, 340; in Lichens, 351.
- Gordius*, 623.
- Gorgonia*, spicules of, 551.
- Gosse, Mr., on masticatory apparatus of Rotifera, 472, 473; on sexes of Rotifera, 475; on *Melicerta*, 479; on the thread-cells of Zoophytes, 553, 554.
- Grammatophora*, 296; its use as test, 183.
- Grant, Prof., on *Flustra*, 580.
- Grantia*, structure of, 527, 529, 531.
- Grasses, silicified cuticle of, 420.
- Gray, Dr., on tongues of Gasteropods, 608; on development of *Buccinum*, 615.
- Green-sands, Prof. Ehrenberg on composition of, 507 *note*, 760.
- Gregarinida*, 447—449.
- Gromia*, 438, 439.
- Growing-Slide, 129, 130.
- Growth, distinguished from Generation, 244, 245.
- Guano, Diatomaceæ of, 311.
- Gümbel, Dr., on Eozoon, 520.
- Guy, Dr., on Sublimation of Alkaloids, 776.
- Haeckel, Prof., on *Thalassicolla*, 450; on Polycystina, 523.
- Hæmatococcus*, 317, 318; its relations to *Protococcus*, 247.
- Haime, M. Jules, on metamorphosis of *Trichoda*, 460—462.
- Hairs, of Insects, 659; of Mammals, 704; structure of, 704—707; mode of mounting, 707.
- of Vegetable cuticles, 419, 420; rotation of fluid in, 393—395.
- Halichondria*, spicules of, 528.
- Halifax, Dr., on making Sections of Insects, 654.
- Haliomma*, 524.
- Haliotis*, tongue of, 608.
- Halodactylus*, 580.
- Halteres of Diptera, 679.
- Hand-Magnifiers, 46.
- Harley Binocular, 74—76.
- Hartig, Prof., on production of Rhizopods from Plants, 342 *note*.
- Hartnack, M., his Immersion-lenses, 16; his diagonal Micrometer, 97; on *Surirella*, 182, 183.
- Harvest-bug*, 686.

- Harvey, Dr., on movements of Oscillatoria, 323.
- Haversian Canals of bone, 694.
- Haustellate Mouth, 670, 671.
- Helianthoida*, 550—554.
- Heliopelta*, 299, 300.
- Helix*, tongue of, 606, 607.
- Hemiptera*, wings of, 679.
- Hemispherical Condenser, Reade's, 113, 114.
- Hendry, Mr., on Diatom-tests, 181 note, 182 note.
- Henfrey, Mr., on development of Pollen-grains, 426, 427.
- Hepatica*, 365—369; see *Marchantia*.
- Herapath, Dr., on Pedicellariæ of Echinoderms, 560 note.
- Herapathite, 118, 119.
- Hepworth, Mr., on feet of Insects, 681.
- Heterostegina*, 513, 514.
- Hicks, Dr., on Amœboid state of Volvox, 255—257; on Unicellular Algae, 320; on gonidia of Lichens, 324, 351; on Amœboid production in root-fibres of Mosses, 370; on eyes of Insects, 662; on peculiar organs of sense in Insects, 667, 671, 679.
- Highley, Mr., his Demonstrating Microscope, 83; his Tow-Net, 238.
- Himantidium*, 291.
- Hippocrepian Polyzoa*, 581, 582.
- Hofmeister, Prof., on Higher Cryptogamia, 382 note; on Phanerogamia, 430 note.
- Hogg, Mr., on development of Lymnæus, 614.
- Holland, Mr., his Triplet, 21.
- Holothurida*, skeletons of, 566—568; development of, 573 note.
- Hoofs, structure of, 708, 709.
- Hooker, Dr. Jos., on Antarctic Diatomaceæ, 311.
- Hornet, wings of, 678.
- Horns, structure of, 708, 709.
- Houghton, Rev. W., on Glochidium, 610.
- Huxley, Mr., on Rotifera, 475, 476; on Thalassicolla, 449; on Sponges, 531; on Noctiluca, 550; on Shell of Mollusca, 596; on Appendicularia, 591; on Blood of Annelida, 628; on Shell of Crustacea, 649 note; on Reproduction of Aphides, 685.
- Huyghenian eye-piece, 25—27.
- Hyaline Foraminifera, 486—489.
- Hyalodiscus*, 182 note, 297.
- Hyalonema*, 529.
- Hydatina*, 476; reproduction of, 479.
- Hydra*, structure of, 533—535; multiplication of, 535—537.
- Hydrodictyon*, 329, 330.
- Hydrozoa*, 537—543; production of Medusæ from, 543—547.
- Hyla*, preparation of Nerves of, 732.
- Hymenoptera*, proboscis of, 669; wings of, 678; stings and ovipositors of, 682.
- Ice-plant*, cuticle of, 419.
- Ichneumonidæ*, ovipositor of, 682.
- Illumination of Opaque objects, 161—164; of Transparent objects, 154—160.
- Illuminator, Black-ground, 114—117, 160.
- Oblique, 112—114, 158, 159.
- Parabolic, 115, 116.
- Reade's Hemispherical, 113, 114.
- Side, 120—125.
- Vertical, 125, 126.
- Wenham's for Binocular, 114 note.
- White-Cloud, 117.
- Immersion-Lenses, 15, 16.
- Images, formation of, by convex lenses, 9.
- Indicator, Quekett's, 98.
- Indusium of Ferns, 377.
- Infandibulate Polyzoa*, 581.
- Infusorial Earths, 311—314.
- INFUSORIA, 452—468; forms of, 452—455; movements of, 455, 456; internal structure of, 456, 457; binary subdivision of, 457, 458; encysting process of, 458—463; sexual generation of, 463—465; peculiar forms of, 466, 467.
- Injections of Blood-vessels, mode of making, 739—745; mode of mounting, 743.
- Inorganic substances as Microscopic objects, 765—768.
- INSECTS, great numbers of objects furnished by, 652, 653; microscopic forms of, 653; antennæ of, 664—667; circulation of blood in, 671, 672; eggs of, 684; eyes of, 661—664; feet of, 680—682; gastric teeth of, 671; hairs of, 659; integument of, 654; mouth of, 667—671; organs of hearing in, 667; organs of smell in, 682; ovipositors of, 682, 683; scales of, 655—659; spiracles of, 675, 676; stings of, 682; tracheæ of, 673—677; wings of, 677—679.

- Intermediate Skeleton of Foraminifera, 488.
- Internal Casts of Foraminifera, 502, 507 *note*, 513, 518, 519.
- Inverted Microscope, Dr. L. Smith's, 85, 86.
- Iris, structure of leaf of, 421—424.
- Isthmia, 301, 302; markings on, 278, 279; self-division of, 284.
- Itch-Acarus, 686.
- Iulus, fungous vegetation in, 356.
- Jackson, Mr., his Eye-piece Micro-meter, 95, 96.
- Jelly-fish, development of, 544—547.
- Jewel-lenses, 21.
- Jukes, Prof., on Foraminiferal reef, 755 *note*.
- Kellner's Eye-piece, 27.
- Kidneys, structure of, 725.
- Kölliker, Prof., on Fungi in Shells, 360 *note*; on Development of Higher Animals, 750 *note*.
- Kützing, Prof., on Classification of Diatomaceæ, 289, 290.
- Labelling of Objects, 234, 235.
- Labyrinthodon, tooth of, 763, 764.
- Lachmann, Dr., on Lieberkühnia, 437; on Amœba, 444; on Infusoria, 481 *note*.
- Laciniaria, Huxley on, 475 *note*.
- Lacunæ of Bone, 695, 696.
- Ladd's Student's Microscope, 66—68.
- Lagena, 483, 500.
- Laguncula, 577—580.
- Lamelllicornes, antennæ of, 665.
- Lamps, microscope, 140, 141.
- Laurentian Formation of Canada, 517; of Europe, 520 *note*.
- Lawrance's glycerine-jelly, 221.
- Lealand, Mr., his preparations of muscular fibre, 728.
- Leaves, structure of, 417—424; mode of examining, 422, 424.
- Leech, teeth of, 635.
- Leeson, Dr., his double-refracting Goniometer, 98; his Selenite plate, 120.
- Legg, Mr., on collection of Foraminifera, 521, 522.
- Leidy, Dr., on parasitic Fungi, 356—358.
- Lenses, refraction by, 4—9.
- Lepadidæ, metamorphosis of, 647, 648.
- Lepidoptera, scales of, 655—657; proboscis of, 670, 671; wings of, 660, 678; eggs of, 683, 684.
- Lepidosteus, bony Scales of, 696, 702.
- Lepisma, scales of, 657.
- Leprælia, 577, 581.
- Lernæa, 646.
- Levant-Mud, microscopic organisms of, 754, 755.
- Lever of Contact, 203.
- Lever-Stage, 104.
- Libellula, eyes of, 662; respiration of larva of, 676.
- Liber, 413.
- Lichens, 350, 351.
- Licmophoræ, 292, 293.
- Lieberkühn, speculum of, 124, 125; mode of using, 163.
- Lieberkühnia, 437.
- Ligaments, structure of, 715, 716.
- Light, suitable for Microscope, 139—141; position of, 141, 142; arrangement of, for Transparent objects, 152—160; for Opaque objects, 160—168.
- Ligneous Tissue, 401, 402.
- Ligula of Insects, 667—670.
- Limax, tongue of, 606, 607.
- Limpet, tongue of, 607.
- Liquid Glue, use of, 205, 211.
- Lister, Mr., his improvements in Achromatic lenses, 15; his Erector, 90; his Zoophyte-trough, 131, 132; his observations on Zoophytes, 540; on Social Ascidiæ, 590, 591 *note*.
- Lituolida, 498—500.
- Liver, structure of, 724, 725.
- Liverwort, see Marchantia.
- Lobosa, 442—447.
- Logan, Sir W., on Laurentian Formation, 517 *note*.
- Lophophore of Polyzoa, 581.
- Lophyropoda, 639, 640.
- Lovén, Prof., on tongues of Gastro-pods, 608.
- Lubbock, Sir J., on Daphnia, 644.
- Luminosity of Medusæ, 549; of Annelida, 634.
- Lungs, of Reptiles, 747; of Birds, 747, 748; of Mammals, 749.
- Lymnæus, development of, 613, 614.
- Lymph, corpuscles of, 712.
- Macro-gonidia, of Volvox, 254; of Pediatstræ, 270; of Hydrodictyon, 329.
- Magnetic Stage, 66, 67.
- Magnifying power, mode of determining, 183—184; augmentation of, 145, 146; of different Objects, 176—179.
- Mahogany, section of, 412.

- Malacostracous Crustacea*, shells of, 648, 649; metamorphoses of, 649—651.
- Mallow, pollen-grains of, 428, 429.
- Malpighian bodies of Kidney, 725.
- layer of Skin, 718.
- Maltwood's Finder, 105, 106.
- MAMMALS, bone of, 693—697; teeth of, 697—700; hairs, &c., of, 704—709; blood of, 709—713; lungs of, 748, 749.
- Man*, teeth of, 698—700; hair of, 706; blood of, 709—713.
- Mandibulate mouth of Insects, 667.
- Marchantia*, general structure of, 365, 366; stomata of, 367; conceptacles of, 367, 368; sexual apparatus of, 369.
- Margaritaceæ*, shells of, 593—599.
- Marine Glue, uses of, 206, 207.
- Masticating apparatus of Rotifera, 472, 473.
- Mastogloia*, 309, 310.
- Media, Preservative, 220—223.
- Medullary Rays, 388, 410—412.
- Sheath, 402.
- Medusæ*, development of, from Zoo-phytes, 543—547.
- Medusoids of Hydroida, 538—541.
- Megalopa*-larva of Crab, 650, 651.
- Megatherium*, teeth of, 700.
- Melanospermeæ*, 345—348.
- Melicertians*, 477—479.
- Melolontha*, see Cockchafer.
- Melosira*, 296, 297; self-division of, 284; conjugation of, 286, 287.
- Menelaus*, scale of, 656, 657.
- Meniscus Lenses, refraction by, 8.
- Meridion*, 290—292.
- Mesembryanthemum*, cuticle of, 419.
- Mesocarpus*, 335.
- Mesogloia*, 343, 344.
- Metamorphosis, of Annelids, 628—630; of Cirrhipeds, 646, 647; of higher Crustacea, 649, 650; of Entomostraca, 644—646; of Echinoderms, 568—575; of Infusoria, 460—462; of Mollusks, 590, 610—618.
- Micrasterias*, binary sub-division of, 263, 264; gonidia of, 265.
- Micro-Chemistry, 776.
- Micro-gonidia, of Protococcus, 249; of Desmidiaceæ, 265; of Pediatreæ, 270 *note*; of Hydrodictyon, 329.
- Micrometer, Cobweb, 93, 94; Eye-piece, 94—97.
- Micrometry, by Micrometer, 94—97; by Camera Lucida, 102.
- Micropyle of Vegetable Ovule, 429.
- MICROSCOPE, support required for, 138, 139; care of, 143, 144; general arrangement of, 144—152; for Transparent objects, 152—160; for Opaque objects, 160—164.
- Aquarium, 85.
- Binocular, principles of construction of, 27—31; advantages of, 40, 41; different forms of, 31—36, 53—55, 71—76, 87.
- Compound, optical principles of, 23—27; mechanical construction of, 42—45; Third Class, 57—64; Second Class, 64—76; First Class, 76—82; Special, 82—88.
- Demonstrating, 83.
- Dissecting, 51—55, 91.
- Double-bodied, 86, 87.
- Doublet, 48—50.
- Educational, 58—61.
- Inverted, 85, 86.
- Pocket, 82.
- Popular, 73, 74.
- Simple, optical principles of, 18—22; different forms of, 46—55.
- Student's, 61—75.
- Travelling, 83, 84.
- Microscopic Dissection, 185—188.
- Microscopists, Fallacies of, 164—170.
- Microtome, 187.
- Mildev*, fungous vegetation of, 362.
- Miliolida*, 489—498.
- Millon's test for Albuminous substances, 198.
- Milne-Edwards, M., his researches on Compound Ascidians, 591 *note*; on Development of Annelida, 629 *note*.
- Mineral Objects, 765—769.
- Minnow*, circulation in, 736.
- Mites*, 686.
- Moderator, Rainey's, 141.
- Molecular Coalescence, 774, 775.
- Movement, 169, 170.
- MOLLUSCA, shells of, 593—606; tongues of, 606—610; development of, 610—618; ciliary motion on gills of, 618; organs of sense of, 619, 620.
- Monocotyledonous Stems, structure of, 406—408.
- Monothalamous Foraminifera, 483.
- Morris, Mr., his Disk-holder, 129; his method of mounting Zoo-phytes, 542.

- MOSSES**, structure of, 369, 370; sexual apparatus of, 371—374; urns of, 374; peristome of, 374—375; development of spores of, 375, 376.
- Mother-of-Pearl**, structure of, 598, 599.
- Moths*, see Lepidoptera.
- Mould**, fungous vegetation of, 360.
- Mounting of objects**, see Objects.
- Mounting-Instrument**, Smith's, 213, 214.
- Mounting-Plate**, 206, 207.
- Mouse*, hair of, 704; cartilage of ear of, 723.
- Mouth of Insects**, 667—671.
- Mucous Membranes**, structure of, 717; capillaries of, 746.
- Müller, Dr. Fritz**, on colonial nervous system of Polyzoa, 579, 580.
- Müller, Prof. J.**, his researches on Polycystina, 523; on Echinoderm larvæ, 568—573.
- Murray and Heath's Student's Microscope**, 62—64.
- Muscardinæ**, or Silk-worm disease, 354, 355.
- Muscular Fibre**, structure of, 726—729; value of as test-object, 195; mode of examining and preparing, 728; capillaries of, 745, 746.
- Musk-deer*, hair of, 704; minute blood-corpuscles of, 711.
- Mussel**, ciliary action on gills of, 618, 619; development of, 610, 611.
- Mya*, structure of hinge-tooth of, 598.
- Mycelium of Fungi**, 361, 365.
- Mycetozoa*, 361.
- Myliobates*, teeth of, 697, 699.
- Myriapods*, hairs of, 659.
- Myxogastric Fungi*, 361, 362.
- Nachet, M. M.**, their Stereoscopic Binocular, 31, 32; Stereo-Pseudoscopic Binocular, 35—37; Binocular Magnifier, 55; Student's Microscope, 68—70; Double-bodied Microscope, 86; Erecting Prism, 91, 92; Camera for Vertical Microscopes, 100, 101; Nose-piece, 103.
- Nacre**, structure of, 598, 599.
- Nais*, 634, 635.
- Nassula*, teeth of, 454.
- Navicellæ of Gregarinida**, 449.
- Nautilus*, shell of, 605.
- Naviculæ*, 307, 308; movements of, 288.
- Needles for Dissection**, mode of mounting, 187.
- Nematoid Entozoa*, 622, 623.
- Nemertes*, larva of, 631.
- Nepa*, tracheal system of, 674.
- Nepenthes*, spiral vessels of, 402.
- Nervous Tissue**, structure of, 729—733; mode of examining, 730—733.
- Net, Collector's**, 236—238.
- Nettle**, stings of, 419.
- Neuroptera*, circulation in, 672; wings of, 677.
- Newt*, circulation in larva of, 736.
- Nicol-Prism**, 118.
- Nidamentum of Gasteropods**, 611—613.
- Nitella*, 338.
- Nitzschia*, 293, 294.
- Nobert's Test**, 179, 180.
- Noctiluca*, 549, 550.
- Nodosaria*, 500.
- Nonionina*, 508.
- Non-striated Muscular Fibre**, 729.
- Nose-piece**, Brooke's, 102, 103.
- Nostochaceæ*, 324.
- Notommata*, 474.
- Nucleolus of Infusoria**, 463.
- Nucleus**, of Vegetable cells, 244, 274, 390, 395; of Rhizopoda, 440, 443, 444; of Infusoria, 463; of Animal cells, 691.
- Nudibranchs*, development of, 611—614.
- Nummulinida*, 487, 488, 506—521.
- Nummulite*, structure of, 487, 510—513.
- Nummulitic Limestone**, 510.
- Nuphar lutea*, parenchyma of, 389.
- Object-Finders**, 104—106.
- Object-Glasses**, Achromatic, principle of, 10—14; construction of, 14—16; adjustment of, for covering glass, 16—18, 149—152; adaptation of to Binocular, 38—40; defining power of, 170; penetrating power of, 171, 172; increase of with Binocular, 40; resolving power of, 172, 173; flatness of field of, 173, 174; comparative value of, 170—175; different powers of, 175—179; tests for, 175—183; determination of magnifying power of, 183, 184.
- Object-Marker**, 103.
- Objects**, mode of mounting, Dry, 208—211; in Canada balsam, 211—219; in preservative Media, 229—233; see Opaque and Transparent Objects.

- Objects, labelling and preserving of, 234, 235.
 ——— collection of, 235—238.
- Oblique Illuminators, 112—117, 158—160.
- Ocelli of Insects, 661—663.
- Octospores of Fuci, 347.
- Œdogonium*, zoospore of, 331; sexual reproduction of, 333, 334.
- Oersted, Prof., on sexuality of Agarics, 365.
- Oidium*, 363.
- Oil-globules, microscopic appearances of, 168, 169.
- Oleander*, cuticle of, 419; stomata of, 422.
- Oncidium*, spiral cells of, 397.
- Onion*, raphides of, 400.
- Oolite, structure of, 759.
- Oo-spores, of Volvox, 258; of Vauclheria, 326; of Sphæroplea, 332, 333; of *Œdogonium*, 333, 334.
- Opaque Objects, arrangement of Microscope for, 160—162; various modes of illuminating, 162—164; modes of mounting, 209—211.
- Opercula of Mosses, 374.
- Operculina*, 509, 510.
- Ophiocoma*, spines of, 563; tooth of, 562.
- Ophiurida*, skeleton of, 562, 563; development of, 570—572.
- Ophrydiæ*, 467.
- Orbiculina*, 491.
- Orbitoides*, structure of, 515, 516.
- Orbitolina*, 503.
- Orbitolites*, structure and development of, 492—498.
- Orbulina*, 501, 502.
- Orchideous Plants, 397, 431.
- Ornithorkyncus*, hair of, 706.
- Orthoptera, wings of, 679.
- Osmunda, prothallium of, 382.
- Oscillatoriaceæ*, 322, 323.
- Ostraceæ*, shells of, 597, 600.
- Ostracoda*, 639.
- Otolithes of Gasteropods, 619; of Fishes, 774.
- Ovipositors of Insects, 682, 683.
- Ovules of Phanerogamia, 429; fertilization of, 430; mode of studying, 431.
- Owen, Prof., on fossil teeth, 762, 763; on fossil bone, 764.
- Oxytricha*-form of Trichoda, 460—462.
- Oyster*, shell of, 597, 600.
- Pachymatisma*, spicules of, 530.
- Pæony*, starch-cells of, 398.
- Palates of Gasteropods, 606—610.
- Palm*, stem of, 406—408.
- Palmella*, 317.
- Palmellaceæ*, 317—320.
- Palmodietyon*, 319.
- Palmoplæa microcoeca*, life-history of, 244—246.
- Pampean deposit, organic composition of, 769, 761.
- Papillæ of Skin, structure of, 731, 746; of Tongue, 732.
- Parabolic Illuminator, 115, 116.
 ——— Speculum, 122, 123.
- Paramæcium*, 452; contractile vesicles of, 457; binary subdivision of, 458; sexual generation of, 463—465.
- Paraphyses of Lichens, 351; of Mosses, 372.
- Parasitic Fungi, 353—364.
- Passulus*, fungous vegetation in, 358.
- Paste, Eels of, 623.
- Pasteur, M., his researches on Fermentation, 353, 462.
- Patella*, tongue of, 607.
- Patellina*, 503, 504.
- Pearls, structure of, 599.
- Pecari*, hair of, 705.
- Pecten*, eyes of, 619; tentacles of, 620.
- Pectinibranchiata*, development of, 614—618.
- Pediastrea*, structure of, 270; multiplication and development of, 270—272; varieties of, 273.
- Pedicellariæ* of Echinoderms, 560.
- Pedicellinæ*, 581.
- Peneroplis*, 484, 489, 490.
- Penetrating power of Object-glasses, 171, 172; increase of, with Binocular, 40.
- Petargonium*, cells of petal of, 425.
- Pentacrinus*, skeleton of, 563; larval, 573—575.
- Pereunibranchiata*, bone of, 696; blood-corpuscles of, 711.
- Peristome of Mosses, 374, 375.
- Perophora*, 588—590.
- Petals of Flowers, structure of, 425, 426.
- Petrology, Microscopic, 752—767.
- Pettenkofer's test, 197.
- PHANEROGAMIA, elementary tissues of, 386—405 (see Tissues of Plants); stems and roots of, 405—417; cuticle and leaves of, 417—424; flowers of, 424—431; seeds of, 431—433.
- Phyllopora*, 641, 642.
- Phytelephas*, cells of, 397.
- Pigment-cells, 719, 720; of Cuttle-fish, 620.

- Pilidium*-larva of Nemertes, 631.
 Pillischer, Mr., his Student's Microscope, 61, 62; his Lamp, 140.
Pinna, structure of shell of, 593—596; fossil, in Chalk, 757.
Pinnularia, 308.
 Pistillidia, see Archegonia.
 Piper, Mr., his portable Object-Cabinet, 235.
 Pith, structure of, 386, 408.
 Placoid scales of Fish, 703.
Planaria, 625—627.
Planorbulina, 503.
Plantago, cyclosis in hairs of, 395.
 Plants, distinction of from Animals, 240, 241, 434, 435.
 Plate-glass Cells, 227, 228.
Pleurosigma, 308; nature of markings on, 159, 160, 279—282; value of as Tests, 178—181.
Pluteus-larva of Echinus, 570—572.
 Pocket Microscope, Beale's, 82.
Podura, scale of, 657, 658; use of, as Test-object, 151, 178.
 Poisons, detection of, 776.
 Polarization, Objects suitable for, 773, 774.
 Polarizing Apparatus, 118—120.
Polistes, fungous vegetation in, 356.
 Pollen-grains, development of, 426, 427; structure and markings of, 427, 428.
Polyclinians, 585.
Polycystina, nature of, 442, 523; distribution of, 523—526.
Polygastrica, see Infusoria.
Polymorphina, 500.
Polyommatus argus, scale of, 657.
 Polypes, see *Hydra* and *Zoophytes*.
Polypodium, fructification of, 377.
Polystomella, 506—509.
 Polythalamous Foraminifera, 482—486.
Polytrema, 504.
 POLYZOA, 576—584; general structure of, 576—581; classification of, 581, 582.
 Pond-Stick, Baker's, 236.
 Poppy, seeds of, 431, 432.
 Popular Microscope, Smith and Beck's, 73, 74.
Porcellanous Foraminifera, 486, 488—498.
 Porcellanous shells of Gasteropods, 604.
Porcupine, quill of, 705.
 PORIFERA, see Sponges.
 Potato-disease, 363.
 Powell and Lealand's Microscope, 78, 79; their large Microscope, 79, 80; their Binocular for high powers, 87, 88; their Achromatic Condenser, 109, 110; their White-cloud Illuminator, 117; their Vertical Illuminator, 126.
Prawn, shell of, 649.
 Preservative Media, 220—223.
 Primordial Cell, 245, 382.
 ——— Utricle, 241—243, 390.
 Pringsheim, Dr., his observations on *Vaucheria*, 326; on *Hydrodictyon*, 329; on *Cedogonium*, 333; on *Sphacelaria*, 360.
 Prismatic Shell-substance, 593—596.
 Prism, Amici's, 112; Nacet's Erecting, 91; Wenham's, 33; Camera Lucida, 98—102; Spectroscope, 66, 67; Polarizing, 118, 119.
 Pritchard Mr., jewel-lenses worked by, 21.
 Proboscis of Bee, 668—670; of Butterfly, 670, 671; of Fly, 668.
Proteus, blood-corpuscles of, 711.
 Prothallium of Ferns, 379—382.
Protococcus, life-history of, 246—251; conditions influencing changes of, 250, 251; its relation to Ulvaceæ, 320.
 Protoplasm of Vegetable cell, 242, 390, 391; of Animals, 689—693.
 PROTOPHYTA, general characters of, 239—246.
 PROTOZOA, 434, 435; their relations to Protophyta, 240, 435.
 Pseud-embryo of Echinoderms, 568—575.
 Pseudo-Navicellæ of Gregarinida, 449.
 Pseudopodia of Rhizopods, 435—445.
 Pseudoscope, 29.
 Pseudoscopic Microscope of MM. Nacet, 35—37.
 ——— Vision, 30.
Pteris, fructification of, 377; prothallium of, 379, 380.
Pterodactyle, bone of, 764, 765.
Puccinia, 362.
Purpura, egg-capsules of, 613; development of, 614—618.
Pycnogonida, 636—638.
 Quekett, Prof. J., his Dissecting Microscope, 51—53; his Indicator, 98; on structure of Bone, 764, 765.
Quinqueloculina, 489.
Radiolaria, 438—442, 523—526.
 Rainey, Mr., his Moderator, 141;

- his researches on Shell-structure, 597; on Molecular coalescence, 774, 775.
- Ralfs, Mr., on Desmidiaceæ, 259—273.
- Ramsden's eye-piece, 26, 27.
- Raphides, vegetable, 400, 401.
- Reade, Rev. J. B., his Hemispherical Condenser, 113, 114.
- Re-agents, Chemical, use of in Microscopic research, 197, 198.
- Receptaculites*, 498.
- Red Corpuscles of blood, 709—711.
- Red Snow*, 317.
- Reflection by Prisms, 4.
- Refraction, laws of, 1—3; by convex lenses, 3—9; by concave and meniscus lenses, 8.
- Rein-deer*, hair of, 704.
- REPTILES, bone of, 693—696; teeth of, 698; scales of, 700—703; blood of, 709—712; lungs of, 747, 748.
- Resolving power of Object-glasses, 172, 173.
- Rete Mucosum, 718.
- Reticularia*, 437, 438.
- Reticulated Ducts, 403.
- Rhinoceros*, horn of, 709.
- RHIZOPODA, 435, 436; their subdivisions, 437—445; their reproduction, 446, 447; their relation to Sponges, 527; their relation to higher Animals, 690—693.
- Rhizosolenia*, 303.
- Rhodospiræ*, 348—350.
- Rhubarb*, raphides of, 400.
- Rhynchonellida*, structure of Shell of, 602, 603.
- Rice-Paper, 387.
- Ricinia*, 686.
- Rochea falcata*, cuticle of, 419, 420.
- Ring-Cells, Metallic, 229.
- Ring-Net, 236—238.
- Rocks, structure of, 760, 761, 765—767.
- Roots, structure of, 415; mode of making sections of, 416.
- Ross, Mr., on correction of Object-glass, 16—18; his Compound Microscope, 76—78; his Achromatic Condenser, 77, 109, 110; his Simple Microscope, 46—48; his Lever of contact, 150; his Compressorium, 134, 135; his eye-piece Micrometer, 95.
- Rotalia*, 484, 504, 505.
- Rotaline* Foraminifera, 486, 487, 502—506.
- Rotifer*, anatomy of, 471—475; reproduction of, 475—477; tenacity of life of, 477; occurrence of, in leaf-cells of Sphagnum, 370, 469.
- ROTIFERA, general structure of, 469—475; reproduction of, 475—477; desiccation of, 477; classification of, 477—481.
- Rush*, stellate parenchyma of, 389.
- Rust, of Corn, 363.
- Sable*, hair of, 705.
- Salter, Mr. Jas., on teeth of Echinida, 560—562.
- Salts, crystallization of, 769—774.
- Salvia*, spiral fibres of seed of, 398.
- Sand-wasp*, integument of, 655.
- Sarcina ventriculi*, 353, 354.
- Sarcodæ, of Protozoa, 434, 435; of higher Animals, 689—693.
- Sarcoptes scabiei*, 686.
- Saw-flies*, ovipositor of, 683.
- Scalariform ducts of Ferns, 376.
- Scales, of cuticle of Plants, 419, 420.
- of Fish, 700—703, 775.
- of Insects, 655—659; their use as test-objects, 177, 178; mode of mounting, 660, 661.
- of Reptiles and Mammals, 700.
- Schizonemæ*, 308—310.
- Schultz's test, 197.
- Schulze, Prof. Max, on Nobert's test-plate, 180 *note*; on surface-markings of Diatoms, 282 *note*; on Sarcodæ in higher Animals, 690 *note*; on Foraminifera, 483.
- Schwann, doctrines of, 689.
- Scissors for microscopic dissection, 187; for cutting thin sections, 188.
- Sclerogen, deposit of, on walls of Cells, 396, 397.
- Scolopendrum*, sori of, 379.
- Sea-Anemone*, 552—554.
- Section-Instrument, 189—191.
- Sections, thin, mode of making, of soft substances, 188, 189; of substances of medium hardness, 189—191; of hard substances, 191—195; of Bones and Teeth, 696, 697; of Echinus-spines, 563—565; of Foraminifera, 192 *note*; of Hairs, 707; of Insects, 654; of Leaves, 422; of Wood, 415, 416.
- Seeds, microscopic characters of, 431—433.
- Segmentation of Yolk-mass, 613, 615.
- Selenite-Plate, 119, 120.

- Selligues, M., his early construction of Achromatic lenses, 14.
- Sepiola, eggs of, 620.
- Sepiostaire of Cuttle-fish, 605.
- Serialaria, colonial nervous system of, 580.
- Serous Membranes, structure of, 717.
- Sertularidæ, 540—543.
- Shadbolt, Mr., on Arachnoidiscus, 300; his annular Condenser, 115 note; his Turn-table, 225, 226.
- Shark, teeth of, 697, 698; scales, &c., of, 703.
- Shell of Crustacea, 648, 649; of Echinida, 555, 556; of Foraminifera, 486—489; of Mollusca, 593—606; Fungi in, 359.
- Shrimp, shell of, 649.
- Side-Illuminator, 120—122.
- Side-Reflector, Beck's, 122, 123.
- Siebold, Prof., on reproduction of Bee, 685.
- Siliceous Casts of Foraminifera, 502, 507 note, 513, 518, 519.
- Siliceous Cuticles, 383, 420.
- Silk-worm disease, 354, 355.
- Silver, crystallized, 769.
- Simple Microscope, principle of, 18—22; various forms of, 46—55.
- Siphonaceæ, 325—330.
- Sipunculus, larva of, 628, 629.
- Siricidæ, ovipositors of, 683.
- Skin, structure of, 717; papillæ of, 731, 746.
- Slider-Forceps, 214.
- Slides, Glass, 201.
- Wooden, 209.
- Slug, rudimentary shell of, 605; tongue of, 606—609; eyes of, 619.
- Smith, Mr. Jas., his Mounting Instrument, 213—216; his Selenite Stage, 120 note; his Object Cabinet, 235.
- Smith, Dr. Lawrence, his Inverted Microscope, 85, 86.
- Smith, Prof. W., on Diatomaceæ, 275 note, 181.
- Smith and Beck's Student's Microscope, 64, 66; their Popular Microscope, 73, 74; their Large Compound Microscope, 80, 81; their Achromatic Condenser, 108; their Binocular Magnifier, 186; their arrangement of Polarizing apparatus, 118, 119; see Beck, Mr. R.
- Smut of Wheat, 363.
- Squid, lungs of, 717.
- Suckers, lung of, 717.
- Snow-crystals, 768.
- Society of Arts' Microscope, Simple, 50, 51; Compound, 58, 59.
- Soemmering, his speculum, 110.
- Sole, skin and scales of, 701, 702.
- Sollitt, Mr., on Diatom-table, 180—182.
- Sorby, Mr., his Spectroscope, Eye-piece, 92, 93; his Microscopic examination of Rocks, 750, 760, 767.
- Soredia of Lichens, 351.
- Sori of Ferns, 377.
- Spatangidium, 299.
- Spatangus, spines of, 559, 560.
- Spencer, Mr., his method of making thin glass, 204.
- Spectacles, for Dissection, 115.
- Spectroscope Eye-piece, 92.
- Speculum, Parabolic, 122, 123.
- Spermatia of Lichens, 351.
- Spermogonia of Lichens, 351.
- Sphaerularia, 344, 345.
- Sphæria, development of, within Animals, 356.
- Sphaeroplea, sexual reproduction of, 332, 333.
- Spherosira volvox, 255.
- Sphærozoum, 450.
- Sphagnum, peculiar cells of, 470; occurrence of Rotifer in, 466; of, 370, 469.
- Spherical Aberration, 9; method of reducing and correcting, 10.
- Spicules, of Sponges, 520—530; preparation of, 531, 532; of Alcyonian Zoophytes, 551; of Doria, 604.
- Spiders, eyes of, 687; respiratory organs of, 687; feet of, 687; spinning apparatus of, 687, 688.
- Spinal Cord, mode of preparing sections of, 733 note.
- Spines of Echinus, &c., 557, 558; mode of making sections of, 563—565.
- Spinning-apparatus of Spiders, 687, 688.
- Spiracles of Insects, 674—676.
- Spiral Cells of Sphagnum, 470; of Orchidæ, 397.
- Fibres, 398.
- Vessels, 402, 403; in petals, 426.
- Spiriferidæ, shell-structure of, 605.
- Spirillina, 500.
- Spirogyra, 335.
- Spirulina, 490.
- Sponges, see structure of, 520—530; cellular action in, 527; of, 527.

- 530; reproduction of, 530; reproduction of, 531, 532; of Root, 415.
of Desmidiaceæ, 266, 267; of Diatomaceæ, 286, 287; of of Hepaticæ, 369.
of Algmoglaea, 245; of Conjugation, 369; of Ferns, 379, 380; of Quilisetaceæ, 383, 384.
of, 114.
of, 208.
of, 215.
of, 187.
of, 704, 705.
- Stage, Lever, 104; Magnetic, 66; Mechanical, 104.
Stage-Forceps, 94.
Stage-Plate, glass, 129, 130.
Staining Process, 198, 744; use of, 690, 691.
Stanhope Lens, 22.
Stanhoscope, 22.
Star-Anise, cells of seed-coat of, 396.
Starch-granules, in Cells, 398—400; appearance of, by Polarized light, 399.
Star6-spores, of Volvox, 255; of Hydrodictyon, 329.
Staurastrum, prominences of, 259; self-division of, 263; varieties of, 273.
Stauroneis, 308.
Stein, Dr., his doctrine of Acineta forms, 466; his researches on Infusoria, 481 *note*.
Stellaria, spiral vessels in petal of, 426.
Stellate cells of Rush, 388; of Water-lily, 389.
Stemmata of Insects, 663.
Stems, Endogenous, structure of, 406—408; Exogenous, structure and development of, 408—415; mode of making sections of, 415—417.
Stentor, 457, 466; its conjugation, 464.
Stephanoceros Eichornii, 472, 478.
Stephanosphaera pluvialis, 259.
Stereoscope, 27.
Stereoscopic Vision, principles of, 27—31; application of, to Compound Microscope, 31—41; to Simple Microscope, 53—55.
Stewart, Mr., on internal skeleton of Echinodermata, 565, 566.
Stick-net, 237.
Stigmata of Insects, 674—676.
- Stings of Plants, structure of, 419; of Insects, 682.
Stolon-processes of Foraminifera, 483—488; of Compound Ascidians, 587.
Stomata of Marchantia, 367; of Flowering Plants, 421—424.
Striatella, 295.
Strobila-larva of Medusæ, 544—546.
Stromatopora, 498.
Student's Microscopes, Crouch's, 61; Pillscher's, 61, 62; Murray and Heath's, 62—64; Smith and Beck's, 64—66; Ladd's, 66—68; Nachet's, 68—71; Crouch's Binocular, 71, 72; Harley Binocular, 74—76.
Strophomenidæ, shell-structure of, 603.
Suctorial Crustacea, 645, 646.
Sundew, hairs of, 419.
Sunk Cells, 227.
Survivella, 294; conjugation in, 286; use of as test, 183.
Swarming of granules in Desmidiaceæ, 262.
Synapta, calcareous skeleton of, 566, 567; development of, 573 *note*.
Syncrypta, 255.
Synedrea, 294.
Syringe, small glass, 136; uses of, 153, 197, 212, 216, 224, 617 *note*, 740.
- Tabanus, ovipositor of, 683.
Tadpole, pigment-cells of, 719, 720; circulation in, 736—739.
Tania, 621, 622.
Tardigrada, 480, 481; desiccation of, 477.
Teeth, of Echinida, 560—562; of Mollusks, 606—609; of Leech, 635; of Vertebrata, structure of, 697—700; fossil, 762, 763; mode of making sections of, 697.
Tendon, structure of, 715.
Teuthredinidæ, ovipositors of, 683.
Terebella, circulation and respiration in, 627, 628.
Terebratula, structure of shell of, 601, 602.
Terpsinoecæ, 296.
Test-Bottles, 196.
Test-Liquids, 197, 198.
Test-Objects, 175—183.
Tethya, sexual generation of, 531.
Tetraspores of Florideæ, 350.
Textularia, 502.
Thalassicolla, 449, 450.
Thallus of lower Cryptogamia, 343, 350.

- Thamnidias*, 543, 544.
 Thecae of Fungi, 361; of Ferns, 377—379; of Equisetaceæ, 383.
 Thin Glass, 202—204.
 Thin-Glass Cells, 226, 227.
 Thomas, Mrs. H., on Cosmarium, 263, 266.
 Thomas, Mr. R., on microscopic Crystallization, 772.
 Thompson, Mr. J. V., on Polyzoa, 576; on development of Comatula, 574; on metamorphosis of Cirripeds, 647; on metamorphosis of Crustacea, 650.
 Thomson, Prof. Wyville, on development of Echinodermata, 570 note, 573 note, 575.
 Thread-cells of Zoophytes, 553, 554.
 Thrush, fungous vegetation of, 358.
 Thwaites's fluid for Algae, 220.
 Thwaites, Mr., on conjugation of Diatoms, 286; on filamentous extensions of Palmelleæ, 318, 351.
 Ticks, 686.
Tinea favosa, fungus of, 358.
Tinoporos, 503.
Tipula, larva of, 676.
 Tissues, Elementary, of Animals, microscopic study of, 689; formation of, 690—693; see Blood, Bone, Capillaries, Cartilage, Epidermis, Epithelium, Fat, Feathers, Fibrous Tissues, Glands, Hair, Horn, Mucous Membranes, Muscle, Nervous Tissue, Pigment-cells, Scales, Serous Membranes, Teeth.
 Tissues, Elementary, of Plants, 386; Cellular, 387—389; varieties of, 395—398; formation of, 390, 391; Woody, 401, 402; Fibrovascular, 401; Vascular, 402, 403; Vasiform, 403, 404; dissection of, 404, 405.
 Tomes, Mr., his Object-marker, 103.
 Tomkins, Mr., his Diatom-finder, 50 note.
Tomopteris, 632—634.
 Tongues of Gasteropods, 606—610; of Insects, 667—670.
 Torbane-hill Mineral, 753.
Torula cerevisiæ, 352, 353.
 Tow-Net, 237, 238.
 Tracheæ of Insects, 673—675; mode of preparing, 676, 677.
Tradescantia, cyclosis in hairs of, 394.
 Transparent Objects, arrangement of Microscope for, 152, 156; various modes of illuminating, 156—160.
Trematode Entozoa, 625.
Triceratium, 302; mark of, 278, 279.
Trichoda lynceus, bristles of, metamorphosis of, 460—462.
Trilobite, eye of, 762.
Triloculina, 489.
 Triplet, Holland's, 21.
Trochammina, 499.
Trochus, tongue of, 607, 6
Trout, circulation in young of, 228
 Tube-cells, 228—230.
 Tubular Nerve-substance, 729.
Tubulariidae, 539, 540.
 Tulasne, M., on Fungi, 367.
 Tulley, Mr., his early papers, 14; of Achromatic lenses, 14.
 TUNICATA, general organization of, 584, 585; composite types of, 585—590; alternating circulation in, 585, 589; development of, 590—592.
Turbellaria, 625—627.
 Turn-table, Shadbolt's, 225, 226.
Utracæ, 320—322.
 Unicellular Plants, 243.
Unionidae, shells of, 597—600.
Uredo, 363.
 Urns of Mosses, 374.
Urella, 255.
 Vacuoles, 243, 391, 440, 457; microscopic appearances of, 168.
 Valentin's knife, 189.
Vallisneria spiralis, cyclosis in, 391, 392.
Valvulina, 499.
Vanessa, haustellium of, 670.
 Variation, tendency to, in Desmidiaceæ, 273; in Diatomaceæ, 310.
 Varnishes useful to Microscopists, 204—206.
 Vasiform Tissue, 403, 404.
Vaucheria, 325; zoospores of, 325, 326; sexual reproduction of, 326, 327.
 Vegetable Ivory, 397.
 Vermilion Injections, 741.
 VERTEBRATA, elementary structure of, 689 (see Tissues); blood of, 709—713; circulation in, 733—739; development of, 749, 750.
 Vertical Illuminator, Beck's, 125—127.
 Vesicular Nerve-substance, 729.
 Vibracula of Polyzoa, 582, 583.
 Villi of intestine, injections of, 743.
 Vine-disease, 363.
 Vinegar, Eels of, 623.

- William M. lia, Prof. Beale's use of, 459, 26.
- Willmann's Foraminifera*, 486—489.
- Wills, structure of, 251—253; development and multiplication of, 254, 255; amoeboid state of, 255—257; generation of, 257, 258.
- Wills, structure of, 455, 458, 466; encysting process in, 459.
- Wollaston, Dr., on making sections of Foraminifera, 192 *note*; on surface-markings of Diatoms, 281; on Rhizopoda, 436 *note*, 438; on Amoeba, 446 *note*; on Polycystinae, 526 *note*.
- Wollaston, structure of, 720.
- Wollaston, stellate cells of, 389; *note*, 424.
- Wollaston, circulation in larva of, 424.
- Wollaston, vascular system, of Rotifera, 444; of Entozoa, 621.
- Wollaston, Condenser, 110, 111.
- Wollaston, Prof., on distinction between elevations and depressions, 67.
- Wollaston, Mr., his Binocular Microscope, 32—34; his illuminator for the Binocular, 114 *note*; his Portable Illuminator, 115; on adjustment of Object-glasses, 116, 117; his observations on Plate-sigma, 281 *note*; on Cell-formation, 391; on cyclosis, 393—394.
- Wollaston, structure of, 709.
- Wollaston, lights of, 362, 363, 623.
- Wollaston, Sir C., his invention of the Stereoscope, 27—29; of the Pseudoscope, 29, 30.
- Wollaston, *Amatules*, see Rotifera.
- Wollaston, cloud Illuminator, 117, 118.
- Wollaston, Corpuscles of blood, 711, 712.
- Wollaston, fibrous tissue, 714, 715.
- Wollaston, Mr., on circulation in Plate, 736—739.
- Wollaston, Prof., on Volvox, 2, 258; on shells of Crustacea, 34; on scales of Fishes, 701—703, 704; Levant-mud, 755.
- Wings of Insects, 677—680; scales of, 655—658.
- Winter-Eggs of Rotifera, 476; of Hydra, 537; of Entozoa, 644.
- Wollaston, Dr., his Doubt, 21.
- Wollaston, his Camera Lucida, 98, 99.
- Wood, of Exogenous stems, 468—413.
- Woody Fibre, 401; glanular of Coniferae, 402.
- Wormley, Dr., on Micro-Chemistry, 776.
- Xanthidia* of Flints, 266 *note*, 733.
- Yeast, a Vegetable substance, 257; production of, 353.
- Yellow Fibrous tissue, 715.
- Yucca, cuticle of, 417, 418, structure of, 421, 422.
- Zenker, Dr., on contractile vesicles of Infusoria, 441, 457.
- Zooa-larva of Crab, 650.
- Zoophyte-Trough, 131, 132.
- ZOOPLANKTON, 533—554; by Infusoria, 537—543; preparation of for Microscope, 542, 543; development of Medusæ from, 543—547; Alveolian, 550—552; Actinophora, 552—554.
- Zoospores, formation of, by Pectinococcus, 247, 249; by Desmidiaceæ, 265; by Pectinococcus, 270; by Ulvaceæ, 320; by Vaucheria, 325, 326; by Achyrodium, 327, 328; by Confervaceæ, 331, 332; by Chaetophoraceæ, 336; by Fucaceæ, 348.
- Zygnema, 335.
- Zygosis of Rhizopods, 440; of Gregarinida, 449.



