

MEMOIRS

OF

THE AMERICAN ACADEMY

OF

ARTS AND SCIENCES

QK1  
.A379  
new ser.  
v.13



VOL. XIII.

CAMBRIDGE:  
PUBLISHED BY THE ACADEMY.  
JUNE, 1908.

113/16  
1910. bot. Garden  
1912

212.00



# CONTENTS.

---

	PAGE
I. BINARY FAMILIES IN A TRIPLY CONNECTED REGION, WITH ESPECIAL REFERENCE TO HYPER-GEOMETRIC FAMILIES. By D. R. CURTISS . . . . .	1
II. BRYGOS: HIS CHARACTERISTICS. By OLIVER SAMUEL TONKS . . . . .	61
III. THE SPECTRUM OF HYDROGEN IN THE REGION OF EXTREMELY SHORT WAVE-LENGTH. By THEODORE LYMAN . . . . .	121
IV. LUNAR AND HAWAIIAN PHYSICAL FEATURES COMPARED. By WILLIAM H. PICKERING	149
V. HIGH ELECTROMOTIVE FORCE. By JOHN TROWBRIDGE . . . . .	185
VI. CONTRIBUTION TOWARD A MONOGRAPH OF THE LABOULBENIACEÆ. PART II. By ROLAND THAXTER . . . . .	217



MEMOIRS  
OF  
THE AMERICAN ACADEMY  
OF  
ARTS AND SCIENCES



VOL. XIII. — No. I.

CAMBRIDGE:  
JOHN WILSON AND SON,  
University Press.  
JANUARY, 1904.



I.

BINARY FAMILIES IN A TRIPLY CONNECTED REGION, WITH ESPECIAL  
REFERENCE TO HYPERGEOMETRIC FAMILIES.

BY

D. R. CURTISS.

PRESENTED BY MAXIME BÔCHER, MAY 13, 1903.



# CONTENTS.

---

	PAGE
INTRODUCTION . . . . .	5
PART I. THE GENERAL CASE.	
A. BINARY FAMILIES IN AN $n$ -TUPLY CONNECTED REGION.	
§ 1. THE REGIONS $T_n$ AND $S$ . . . . .	7
§ 2. DEFINITION OF A BINARY FAMILY . . . . .	7
§ 3. THE GROUP OF A BINARY FAMILY . . . . .	8
§ 4. THE DOUBLY CONNECTED REGION . . . . .	9
§ 5. FUNDAMENTAL BASES FOR AN $n$ -TUPLY CONNECTED REGION. CONNECTING FORMULÆ . . . . .	11
§ 6. KINDRED FAMILIES . . . . .	13
§ 7. RELATIONS BETWEEN KINDRED BINARY FUNCTIONS . . . . .	15
B. CLASSIFICATION OF BINARY FAMILIES FOR THE CASE $n = 3$ .	
§ 1. THE PROBLEM . . . . .	17
§ 2. THE FOUR TYPES . . . . .	18
§ 3. CLASSIFICATION OF FAMILIES UNDER EACH TYPE . . . . .	20
§ 4. TABULATION OF CLASSES . . . . .	25
§ 5. THE FOUR EQUATIONS PROCEEDING FROM THE RELATION $S_c S_b S_a = 1$ . . . . .	28
PART II. HYPERGEOMETRIC FAMILIES.	
A. DEFINING PROPERTIES.	
§ 1. REGULAR SINGULAR POINTS FOR BINARY FAMILIES. EXPONENTS . . . . .	30
§ 2. THE EXPONENT SUM AND APPARENTLY SINGULAR POINTS. THE DETERMINANT $D$ . . . . .	32
§ 3. THE DIFFERENTIAL EQUATION. ACCESSORY PARAMETERS . . . . .	37



	PAGE
B. CRITERIA FOR THE CLASSES OF PART I, B.	
§ 1. NECESSARY CONDITIONS FOR EACH CLASS IN TERMS OF THE EXPONENTS ALONE	41
§ 2. SUFFICIENT AS WELL AS NECESSARY CONDITIONS . . . . .	45
C. RELATIONS BETWEEN KINDRED $Q$ FUNCTIONS.	
§ 1. GENERAL FORM OF RELATIONS . . . . .	46
§ 2. EXPRESSION OF $Q$ FUNCTIONS IN TERMS OF KINDRED $P$ FUNCTIONS . . . . .	48
D. $P$ FAMILIES.	
§ 1. CRITERIA FOR EACH CLASS OF $P$ FAMILIES . . . . .	50
§ 2. THE $P$ FAMILY DETERMINED BY ITS EXPONENTS . . . . .	51
§ 3. RELATIONS BETWEEN KINDRED $P$ FUNCTIONS . . . . .	53
§ 4. THE DIFFERENTIAL EQUATION . . . . .	54
E. $Q$ FAMILIES OF ORDER 1.	
§ 1. THE DIFFERENTIAL EQUATION. THE FAMILIES $Q$ AND $\bar{Q}$ . . . . .	54
§ 2. CLASSIFICATION CRITERIA IN THE DOUBTFUL CASES . . . . .	55
§ 3. EXPRESSION OF A $Q$ FUNCTION OF ORDER 1 AS A SUM OF TWO KINDRED $P$ FUNCTIONS . . . . .	58



# BINARY FAMILIES IN A TRIPLY CONNECTED REGION WITH ESPECIAL REFERENCE TO HYPERGEOMETRIC FAMILIES.<sup>1</sup>

## INTRODUCTION.

It was Riemann who, in his celebrated paper on hypergeometric functions,<sup>2</sup> first emphasized the importance of the group of substitutions which such a function undergoes when continued along all possible paths which do not pass through a singular point. Again, in another paper,<sup>3</sup> he discusses from this same point of view families composed of the solutions of homogeneous linear differential equations with algebraic coefficients. In the present memoir his methods are applied, and extended, where necessary, to the study of the properties of *binary families* (a term to be explained presently), particularly those whose members are analytic in a triply connected region. In Part I the properties of the most general families of this sort are discussed, while Part II is devoted to the special case of binary families whose only singularities are three *regular singular points*, i. e. *hypergeometric families*.

Since the solutions of a homogeneous linear differential equation of the second order with single valued coefficients constitute a binary family, it would, from one point of view, have been most natural to make this discussion a chapter in the theory of such equations; but we have preferred to follow the methods of Riemann. It is important, however, to note that all our work may be stated in terms of the differential equation; in particular the classification of binary families in a triply connected region given in the last half of Part I may be regarded as a classification of the sub-groups of differential equations of the above kind, obtained from the general group of the equation by so introducing cross-cuts in the region of definition of the coefficients as to make it triply connected.

<sup>1</sup> This paper was accepted in June, 1903, by the Faculty of Arts and Sciences of Harvard University in satisfaction of the requirement of a thesis for the degree of Doctor of Philosophy.

<sup>2</sup> Beiträge zur Theorie der durch die Gauss'sche Reihe  $F(\alpha, \beta, \gamma, x)$  darstellbaren Functionen. (1857). Werke, p. 67.

<sup>3</sup> Zwei allgemeine Sätze über lineare Differentialgleichungen mit algebraischen Coefficienten. (1857). Werke, p. 379.



The methods employed in this classification are believed to be entirely new, though forming a natural development of Riemann's work. Ritter's classification<sup>1</sup> of hypergeometric families without apparently singular points, which in Part II, D, we give as a corollary of our more general results, and which he obtained by a method totally different from ours, also furnished valuable suggestions. The case he treated is the most general for which such a classification has hitherto been attempted.

<sup>1</sup> In § 2 of his posthumous memoir: Ueber die hypergeometrische Function mit einem Nebenpunkt. (1896). *Math. Ann.*, vol. 48.



## PART I.

### THE GENERAL CASE.

WHILE this memoir refers primarily to families belonging to a triply connected region, there are many ideas concerned which apply equally well to regions of higher connectivity. We will develop these more general ideas in a subdivision A, following this with a subdivision B, devoted to the more special properties true for the triply connected region alone.

#### A. BINARY FAMILIES IN AN $n$ -TUPLY CONNECTED REGION.

##### § 1. THE REGIONS $T_n$ AND $S$ .

Let  $a, b, c, \dots, l$  be  $n$  simply connected perfect<sup>1</sup> regions on the complex sphere, no two of which have a point in common. The remainder of the sphere constitutes the  $n$ -tuply connected region  $T_n$  with holes  $a, b, c, \dots, l$ . These holes may be continuous open line-segments, or even points, as well as two-dimensional regions. By  $n - 1$  cross-cuts joining  $a$  to  $b$ ,  $b$  to  $c$ , etc., we can convert  $T_n$  into a simply connected region which we shall refer to as the region  $S$ .

##### § 2. DEFINITION OF A BINARY FAMILY.

In the region  $T_n$  we are to consider a family of functions which we shall call a *binary family*, defined as follows:—

(1) Every member is single valued and analytic throughout  $S$ , and can be continued over the cross-cuts, the branches thus obtained being again members of the family; i. e. we have to do with a family of function-branches analytic in  $T_n$ .

(2) There are two linearly independent branches,  $y_1, y_2$ , such that every member can be expressed in the form  $c_1 y_1 + c_2 y_2$ , where  $c_1$  and  $c_2$  are constants; and, conversely, if we give to  $c_1$  and  $c_2$  any values whatever, the function  $c_1 y_1 + c_2 y_2$  belongs to the family.

We shall call the pair  $(y_1, y_2)$  a *basis* of the family. Any pair of linearly independent branches is readily seen to constitute a basis.

<sup>1</sup> By a perfect region is understood a region which includes all of its limiting points.



## § 3. THE GROUP OF A BINARY FAMILY.

Starting from any given point of  $S$ , let us continue simultaneously a chosen basis  $(y_1, y_2)$  along a closed path which may, if we please, intersect one or more of the cross-cuts, but must lie within  $T_n$ . After making this circuit,  $y_1$  and  $y_2$  have become branches  $\bar{y}_1$  and  $\bar{y}_2$ , linearly independent, and still members of the family. Definition (2) of the preceding section gives us the equations

$$\begin{aligned}\bar{y}_1 &= \alpha y_1 + \beta y_2 \\ \bar{y}_2 &= \gamma y_1 + \delta y_2,\end{aligned}$$

where  $\alpha, \beta, \gamma, \delta$  are constants, and  $\alpha\delta - \beta\gamma \neq 0$ . The basis  $(y_1, y_2)$  has undergone the linear substitution

$$A = \begin{pmatrix} \alpha & \beta \\ \gamma & \delta \end{pmatrix};$$

symbolically

$$(\bar{y}_1, \bar{y}_2) = \begin{pmatrix} \alpha & \beta \\ \gamma & \delta \end{pmatrix} (y_1, y_2) = A (y_1, y_2).$$

If we had continued our basis along some other closed path in  $T_n$ ,  $(y_1, y_2)$  would have undergone, in general, another linear substitution

$$B = \begin{pmatrix} \alpha' & \beta' \\ \gamma' & \delta' \end{pmatrix}.$$

If we continue  $(y_1, y_2)$  along the first path, and then along the second, it undergoes the linear substitution

$$AB = \begin{pmatrix} \alpha\alpha' + \beta\gamma' & \alpha\beta' + \beta\delta' \\ \gamma\alpha' + \delta\gamma' & \gamma\beta' + \delta\delta' \end{pmatrix}.$$

For a closer treatment of this subject, one may consult Klein's *Hypergeometrische Functionen*.<sup>1</sup> The points of chief importance are these: Corresponding to the fact that all closed paths in  $T_n$  may be regarded as obtained by combination and repetition of  $n$  closed *fundamental paths*, namely single circuits about each hole alone, we have the theorem that all the substitutions which a basis  $(y_1, y_2)$  can undergo are combinations and repetitions of  $n$  *generating substitutions*, each of which corresponds to a single circuit about one, and only one, of the holes  $a, b, c, \dots, l$ , respectively.

At this point, however, we should note a matter to which Riemann alone of the writers on this subject seems to have given especial attention. This is the fact that in the above definition of a fundamental path, and hence of a generating substitution,

<sup>1</sup> Lithographed lectures 1893-94, pp. 98-101. We shall have occasion to refer to this volume several times, and, as this is the only work of Klein's here cited, we shall hereafter use merely the author's name in referring to it.



we still need to specify how such a path is to be taken relatively to the cross-cuts which change  $T_n$  into  $S$ ; this is a matter of convention, but unless we add such a specification, inconsistencies will arise in the computations which follow. The convention we here adopt is practically Riemann's.<sup>1</sup>—Given a point  $P$  from which a fundamental path about hole  $i$  is to start and to which it is to return. We divide  $S$  into two regions by joining  $l$  to  $a$  by a cross-cut such that that part of  $S$  in which  $P$  lies is to the left of a point which traces out its boundary so that it meets the holes in the order  $l, \dots, c, b, a$ . A fundamental path about  $i$  is to have the hole  $i$ , but no other hole, interior to it, and is to be deformable into a path which crosses the cross-cuts at only two points. A generating substitution corresponds to such a path traversed positively, its inverse to that path traversed negatively.

With this convention we see that a path formed of  $n$  fundamental paths about  $l, \dots, c, b, a$ , successively, each taken positively, is equivalent to a path enclosing no hole. If the  $n$  generating substitutions for a given basis are  $S_a, S_b, S_c, \dots, S_l$ , this gives the relation

$$(1) \quad S_l \dots S_c S_b S_a = 1,$$

where 1 stands for the identical substitution.

A different convention would have changed the order of the product in (1).

*The totality of substitutions which a basis undergoes when continued along all possible closed paths in  $T_n$  constitutes a group whose  $n$  generating substitutions correspond to single circuits about each of the holes.*

This group, which we call the group of the binary family, is discontinuous, and, in general, infinite. If we had used instead of  $(y_1, y_2)$  any other basis  $(y_1', y_2')$ , we should have obtained a new group simply isomorphic with the old, and therefore, as an abstract group, indistinguishable from it. In so far we are justified in speaking of the group of the *family* as we have done; if there is need of a more specific expression, we shall speak of the *group corresponding to a basis*.

#### § 4. THE DOUBLY CONNECTED REGION.

There are certain well-known facts for the case where the number of holes of  $T_n$  is two which we will deduce as briefly as possible in this section. If, in this case, we continue a basis  $(y_1, y_2)$  of a binary family along a fundamental path about the hole  $a$  in the positive direction, we shall have the generating substitution

$$(\bar{y}_1, \bar{y}_2) = \begin{pmatrix} m_1 & n_1 \\ m_2 & n_2 \end{pmatrix} (y_1, y_2),$$

<sup>1</sup> "Beitrage," etc. Werke, pp. 70-71.



where, in general, none of the coefficients vanish. But we can always choose bases which have a simpler generating substitution. Consider the *characteristic equation*

$$(2) \quad \begin{vmatrix} m_1 - \rho & n_1 \\ m_2 & n_2 - \rho \end{vmatrix} = 0.$$

This equation is readily shown to be invariant under any linear substitution that may be performed upon  $(y_1, y_2)$ , so that it is the same for every basis, and its properties are therefore characteristic of the family. Designate by  $\rho_a'$ ,  $\rho_a''$ , the roots of (2); these we call the *multipliers* of the family for the hole  $a$ , the reason for this terminology appearing presently. Neither of these multipliers can vanish, since  $m_1 n_2 - m_2 n_1 \neq 0$ .

Two cases present themselves: —

I.  $\rho_a' \neq \rho_a''$ . This we designate the *ordinary case*.

Let

$$(3) \quad \begin{aligned} y_a' &= (\rho_a' - n_2) y_1 + n_1 y_2, \\ y_a'' &= m_2 y_1 + (\rho_a'' - m_1) y_2, \end{aligned}$$

it being understood that if either  $n_1$  or  $m_2$  vanishes, we take  $\rho_a' = m_1$ ,  $\rho_a'' = n_2$ . With this convention it is easily seen that  $y_a'$ ,  $y_a''$  form a basis. It may be readily verified for this basis that its generating substitution for the hole  $a$  is

$$(\bar{y}_a', \bar{y}_a'') = \begin{pmatrix} \rho_a' & 0 \\ 0 & \rho_a'' \end{pmatrix} (y_a', y_a'').$$

Thus in this case we have always a basis  $(y_a', y_a'')$  which undergoes a *multiplicative substitution* when continued along a fundamental path about  $a$ ; hence the use of the term multipliers for  $\rho_a'$ ,  $\rho_a''$ . If  $k'$ ,  $k''$ , are any constants  $\neq 0$ , the basis  $(k' y_a', k'' y_a'')$  undergoes the same generating substitution. This, however, is true of no other bases, as may readily be deduced from the fact that the characteristic equation (2) is invariant. We shall call branches of the form  $k' y_a'$ ,  $k'' y_a''$ , *fundamental branches* for the hole  $a$ , and a basis formed from them a *fundamental basis*.

II.  $\rho_a' = \rho_a''$ . Here if  $m_2$  and  $n_1$  do not both vanish, a case to be considered presently, (3) gives but one branch and its multiples  $\neq 0$  which undergo the generating substitution for the hole  $a$ ,

$$\bar{y} = \rho_a' y'.$$

This branch we will designate by  $y_a'$ , and by  $y_a''$  we will denote any branch not a constant multiple of  $y_a'$ . Then a basis  $(y_a', y_a'')$  undergoes the generating substitution about  $a$ ,

$$(\bar{y}_a', \bar{y}_a'') = \begin{pmatrix} \rho_a' & 0 \\ m & n \end{pmatrix} (y_a', y_a'').$$



From the invariance of equation (2), it follows that  $n = \rho_a'$ .  $m$ , however, will either assume any given value except zero, according to our choice of a basis, or else vanish for all bases. If  $m \neq 0$ , we shall speak of the hole  $a$  as *logarithmic* for the family; if  $m = 0$ ,  $a$  will be called *semisingular*.<sup>1</sup>  $(y_a', y_a'')$  is again called a fundamental basis, but we should note that by this definition this term is, in the case before us, to be applied to any basis whatever in which the first member is a branch undergoing a multiplicative generating substitution about  $a$ . In case  $a$  is semisingular, all members of the family have the generating substitution about  $a$ ,

$$\bar{y} = \rho_a' y,$$

so that every basis is fundamental; but in the logarithmic case, a particular branch  $y_a'$  and its constant multiples are the only members undergoing such a substitution about  $a$ .

If  $m_2 = n_1 = 0$ , (3) is invalid, but we have evidently the semisingular case.

If  $\alpha'$  and  $\alpha''$  are any quantities that satisfy the relations

$$e^{2\pi i \alpha'} = \rho_a', \quad e^{2\pi i \alpha''} = \rho_a'',$$

while  $a_1$  is some point of the hole  $a$ , we shall have, provided  $a_1$  is not the point infinity,

$$(4) \quad \begin{aligned} y_a' &= (x - a_1)^{\alpha'} \phi_a'(x), \\ y_a'' &= (x - a_1)^{\alpha''} \phi_a''(x) + \frac{C_a}{2\pi i} y_a' \log(x - a_1), \end{aligned}$$

where  $\phi_a'(x)$  and  $\phi_a''(x)$  are single valued and analytic in  $T_2$ . If  $a_1$  is the point infinity,  $x - a_1$  is to be replaced by  $\frac{1}{x}$  in (4). Formula (4) will represent a fundamental basis in all cases; for the ordinary and semisingular cases  $C_a = 0$ , while for the logarithmic case  $C_a \neq 0$ .

In particular, the hole  $a$  may be a single point. In this case we have Laurent's developments for  $\phi_a'$  and  $\phi_a''$  in a properly chosen circle about  $a$ , and these developments may have, for certain families, only a finite number of terms with negative exponents (positive exponents if  $a$  is the point infinity).  $a$  is then said to be a *regular singular point* of the family.

#### § 5. FUNDAMENTAL BASES FOR AN $n$ -TUPLY CONNECTED REGION. CONNECTING FORMULAE.

Passing now to the general case of  $n$  holes, we see that if we join together by  $n - 2$  cross-cuts all the holes except  $i$ , leaving that hole free, we have a doubly connected region, so that from § 4 we deduce the existence of fundamental bases  $(y_i', y_i'')$

<sup>1</sup> These terms are used by Klein, as well as lengthier ones which are less convenient.



and the pair of multipliers  $\rho_i', \rho_i''$ . Proceeding in the same way for each hole, we have for  $a, b, c, \dots, l$ , fundamental bases  $(y_a', y_a''), (y_b', y_b''), (y_c', y_c''), \dots, (y_l', y_l'')$ , and corresponding pairs of multipliers  $\rho_a', \rho_a''; \rho_b', \rho_b''; \rho_c', \rho_c''; \dots; \rho_l', \rho_l''$ . A given hole may be *ordinary*, *logarithmic*, or *semisingular*; in each case there are certain degrees of freedom in the choice of a fundamental basis, as noted in § 4. Every fundamental basis for  $a$  can be put into the form (4), where  $\phi_a'(x)$  and  $\phi_a''(x)$  are single valued and analytic in any doubly connected region we may form from  $T_n$  by suitable cross-cuts which do not meet the boundary of  $a$ . Similarly for each of the other holes, with an appropriate change of notation in (4).

Let us note here an important relation between the multipliers of a family. From equation (1) we deduce at once the equation

$$\text{Det } S_a \cdot \text{Det } S_b \cdot \text{Det } S_c \dots \text{Det } S_l = 1,$$

where  $\text{Det } S$  stands for the determinant of the substitution  $S$ . But from the invariance of (2) it follows that for every generating substitution about  $a$  we have

$$\text{Det } S_a = \rho_a' \rho_a'',$$

and analogously for  $\text{Det } S_b, \text{Det } S_c, \dots, \text{Det } S_l$ . Hence we have the relation

$$(5) \quad \rho_a' \rho_a'' \rho_b' \rho_b'' \rho_c' \rho_c'' \dots \rho_l' \rho_l'' = 1.$$

By definition (2) of § 2, any set of fundamental bases is connected by a relation

$$(6) \quad \begin{aligned} y_a' &= \alpha y_b' + \beta y_b'' = \alpha_1 y_c' + \beta_1 y_c'' = \dots = \alpha_{n-2} y_l' + \beta_{n-2} y_l'', \\ y_a'' &= \gamma y_b' + \delta y_b'' = \gamma_1 y_c' + \delta_1 y_c'' = \dots = \gamma_{n-2} y_l' + \delta_{n-2} y_l''. \end{aligned}$$

This we will call a *connecting formula*.<sup>1</sup> Obviously, from the degree of arbitrariness that enters into the choice of fundamental bases, some of the coefficients in a connecting formula will be more or less at our disposal. One of the chief questions which will concern us is the determination of the remaining coefficients after those at our disposal have been fixed by a certain choice of bases in (6). As a matter of fact we shall see later that the pre-assigning of the multipliers will, in general, though not in all special cases, determine these remaining coefficients when  $n = 3$ . It is known that in general for  $n > 3$  additional conditions are needed.

The importance of the connecting formula is evident from the following theorem, which is at once seen to be true:—

*The group of a family is completely determined in case we know its multipliers, the coefficients of a connecting formula, and the constants  $C_a, C_b, C_c, \dots, C_l$ , which enter into the generating substitutions of the bases in that connecting formula.*

<sup>1</sup> Klein: Zusammenhangsformel.



## § 6. KINDRED FAMILIES.

There are two views which we may take of the group of a family; we may look upon it as an abstract group in which the members are any collection of elements obeying certain formal laws, or as a concrete group whose members are linear substitutions which a given basis undergoes, these substitutions having coefficients which are uniquely determined when the path of continuation is given. It is from this latter point of view that we proceed to study the group. We shall suppose the holes  $a, b, c, \dots, l$  always given, and limit our discussion to families having the same holes.

It is entirely conceivable that we may have two binary families with the same group; hypergeometric families, which we shall study in Part II, readily furnish us with examples of this. But first, — exactly what is meant by *families with the same group*? To answer this briefly, — *two binary families belonging to  $\Gamma_n$  are said to have the same group if it is possible to choose from the one family a basis  $(y', y'')$ , and from the other a basis  $(\bar{y}', \bar{y}'')$ ,<sup>1</sup> such that when continued together over the same path, no matter what path in  $\Gamma_n$  that may be, the latter basis undergoes always the same substitution as the former.* Such families we shall call *kindred families*;  $(y', y'')$  and  $(\bar{y}', \bar{y}'')$  are *corresponding bases*. No matter what values we give to the constants  $m_1, n_1, m_2, n_2$ , provided  $m_1 n_2 - m_2 n_1 \neq 0$ , the bases

$$\begin{pmatrix} m_1 & n_1 \\ m_2 & n_2 \end{pmatrix} (y', y'') = S (y', y''),$$

and  $S(\bar{y}', \bar{y}'')$  correspond. Hence:

I. *If two binary families are kindred, to every basis of the one corresponds a basis of the other, i. e., a necessary as well as sufficient condition that two binary families be kindred is that for every basis of the one there exist a corresponding basis of the other.*

We should note the vagueness of the word “corresponding” as used here. Obviously the same group may belong to an infinite number of bases of the same family (for example, the constant multiples of a given basis), so that this correspondence is not of a finite number of bases to a finite number.

A second theorem of great importance, whose truth is immediately obvious, is the following:

II. *A necessary and sufficient condition that a basis of one binary family correspond to a basis of another such family is that the two bases have the same generating substitutions.*

<sup>1</sup> This is not to be confused with a notation used in §§ 3 and 4.



From the theorem stated at the end of § 5, we see that Theorem II can be given in terms of the connecting formula; in fact, as we shall proceed to prove, the following gives us a criterion that two families be kindred:

III. *In order that two binary families belonging to  $T_n$  be kindred, it is both necessary and sufficient that the families have the same multipliers, and connecting formulae in which the corresponding coefficients and the associated constants  $C_a, C_b, C_c, \dots, C_l$ , are the same.*

From the preceding theorems the sufficiency of this condition is obvious. To show its necessity, we first note the fact that if a fundamental basis for a given hole with multipliers  $\rho', \rho''$ , has at that hole the generating substitution  $\begin{pmatrix} \rho' & 0 \\ \rho' C & \rho'' \end{pmatrix}$ , a corresponding basis of the other family must, by definition, have the same generating substitution at that hole. Forming the characteristic equation (2), we see that the multipliers of the second family at the given hole are also  $\rho', \rho''$ , as was to be proved. Moreover, the possession of the generating substitution  $\begin{pmatrix} \rho' & 0 \\ \rho' C & \rho'' \end{pmatrix}$  about a hole for which the multipliers are  $\rho', \rho''$ , characterizes a fundamental basis at that hole. We have thus proved that if  $(y', y'')$  is a basis of the one family fundamental for a given hole, every corresponding basis of the other family must be fundamental for the same hole, and must besides have the same associated constant  $C$  as  $(y', y'')$ .

Let  $(y'_a, y''_a)$  and  $(\bar{y}'_a, \bar{y}''_a)$  be corresponding bases of the two families; a connecting formula of the first family is

$$(7) \quad (y'_a, y''_a) = B (y'_b, y''_b) = C (y'_c, y''_c) = \dots = L (y'_i, y''_i).$$

Denoting by  $B^{-1}$  the inverse of  $B$ , we have

$$\begin{aligned} B^{-1} (y'_a, y''_a) &= (y'_b, y''_b), \\ C^{-1} (y'_a, y''_a) &= (y'_c, y''_c), \\ \cdot &\cdot \cdot \cdot \cdot \cdot \cdot \cdot \cdot \\ L^{-1} (y'_a, y''_a) &= (y'_i, y''_i). \end{aligned}$$

Since the basis  $B^{-1} (\bar{y}'_a, \bar{y}''_a)$  must correspond to the basis  $B^{-1} (y'_a, y''_a)$ , it follows from what we have just seen that  $B^{-1} (\bar{y}'_a, \bar{y}''_a)$  is a basis  $(\bar{y}'_b, \bar{y}''_b)$  fundamental at  $b$  and having the same associated constant  $C_b$  as  $(y'_b, y''_b)$ . Proceeding similarly, we have

$$\begin{aligned} C^{-1} (\bar{y}'_a, \bar{y}''_a) &= (\bar{y}'_c, \bar{y}''_c), \\ \cdot &\cdot \cdot \cdot \cdot \cdot \cdot \cdot \cdot \\ L^{-1} (\bar{y}'_a, \bar{y}''_a) &= (\bar{y}'_i, \bar{y}''_i), \end{aligned}$$

so that for the second family we have a connecting formula,



$$(8) \quad (\bar{y}'_a, \bar{y}''_a) = B (\bar{y}'_b, \bar{y}''_b) = C (\bar{y}'_c, \bar{y}''_c) = \dots = L (\bar{y}'_i, \bar{y}''_i),$$

which is the same as (6), including the associated constants  $C_a, C_b, C_c, \dots, C_i$ . Our proof is thus completed.

A generalization of this result which we shall need in the next section, and whose proof is readily supplied from the proof of Theorem III, is:

IV. *If  $(y', y'')$  and  $(\bar{y}', \bar{y}'')$  are any two corresponding bases of two kindred binary families, and if  $(y', y'')$  is related to fundamental bases of its family by the formula*

$$(y', y'') = A' (y'_a, y''_a) = B' (y'_b, y''_b) = \dots = L' (y'_i, y''_i),$$

*then  $(\bar{y}', \bar{y}'')$  is also related to properly chosen fundamental bases of its family by the formula*

$$(\bar{y}', \bar{y}'') = A' (\bar{y}'_a, \bar{y}''_a) = B' (\bar{y}'_b, \bar{y}''_b) = \dots = L' (\bar{y}'_i, \bar{y}''_i),$$

*the associated constants  $C_a, C_b, C_c, \dots, C_i$ , as well as the coefficients, being the same in both formulae.*

#### § 7. RELATIONS BETWEEN KINDRED BINARY FUNCTIONS.

Before proceeding, it will be convenient to introduce a few new terms. If  $(y', y'')$  and  $(\bar{y}', \bar{y}'')$  are corresponding bases of two kindred binary families, then we will speak of  $y'$  and  $\bar{y}'$ , and also of  $y''$  and  $\bar{y}''$ , as *corresponding branches*.

We will call functions whose branches are members of a binary family, *binary functions*; and by two *kindred binary functions*, we mean functions two of whose branches are corresponding branches of two kindred binary families.

We proceed now to develop certain relations between corresponding branches belonging to kindred binary families; but by the principle of the permanence of functional relations, the equations developed will be in fact relations between the kindred binary functions to which those branches belong.

Let  $(y', y'')$  and  $(\bar{y}', \bar{y}'')$  be corresponding bases of two kindred families; using the notation of Theorem IV, § 6, we have

$$\begin{vmatrix} y' & \bar{y}' \\ y'' & \bar{y}'' \end{vmatrix} = \text{Det } A' \cdot \begin{vmatrix} y'_a & \bar{y}'_a \\ y''_a & \bar{y}''_a \end{vmatrix} = \text{Det } B' \cdot \begin{vmatrix} y'_b & \bar{y}'_b \\ y''_b & \bar{y}''_b \end{vmatrix} = \dots = \text{Det } L' \cdot \begin{vmatrix} y'_i & \bar{y}'_i \\ y''_i & \bar{y}''_i \end{vmatrix}.$$

From these equations it follows that the determinant

$$\begin{vmatrix} y' & \bar{y}' \\ y'' & \bar{y}'' \end{vmatrix}$$

defines a function undergoing only multiplicative substitutions for every path in  $T_n$ ; for, using the notation of (4), we have



$$\begin{aligned}
& \begin{vmatrix} y_{\alpha'}' & \bar{y}_{\alpha'}' \\ y_{\alpha''}'' & \bar{y}_{\alpha''}'' \end{vmatrix} \\
= & \begin{vmatrix} (x-a_1)^{\alpha'} \phi_{\alpha'}'(x) & (x-a_1)^{\bar{\alpha}'} \bar{\phi}_{\alpha'}'(x) \\ (x-a_1)^{\alpha''} \phi_{\alpha''}''(x) + \frac{C_{\alpha}}{2\pi i} (x-a_1)^{\alpha'} \phi_{\alpha'}'(x) \log(x-a_1) & (x-a_1)^{\bar{\alpha}''} \bar{\phi}_{\alpha''}''(x) + \frac{C_{\alpha}}{2\pi i} (x-a_1)^{\bar{\alpha}'} \bar{\phi}_{\alpha'}'(x) \log(x-a_1) \end{vmatrix} \\
= & \begin{vmatrix} (x-a_1)^{\alpha'} \phi_{\alpha'}'(x) & (x-a_1)^{\bar{\alpha}'} \bar{\phi}_{\alpha'}'(x) \\ (x-a_1)^{\alpha''} \phi_{\alpha''}''(x) & (x-a_1)^{\bar{\alpha}''} \bar{\phi}_{\alpha''}''(x) \end{vmatrix}.
\end{aligned}$$

But since the multipliers of kindred families are the same,  $\alpha' - \bar{\alpha}'$  and  $\alpha'' - \bar{\alpha}''$  must both be integers, so that we may write

$$\begin{vmatrix} y_{\alpha'}' & \bar{y}_{\alpha'}' \\ y_{\alpha''}'' & \bar{y}_{\alpha''}'' \end{vmatrix} = (x-a_1)^{\alpha'+\bar{\alpha}''} \phi_{\alpha}(x),$$

where  $\phi_{\alpha}(x)$  is single valued and analytic in a ring about  $a$ ; similarly for the other holes. Hence we have the equation

$$(9) \quad \begin{vmatrix} y' & \bar{y}' \\ y'' & \bar{y}'' \end{vmatrix} = (x-a_1)^{\alpha'+\bar{\alpha}''} (x-b_1)^{\beta'+\bar{\beta}''} \dots (x-l_1)^{\lambda'+\bar{\lambda}''} \phi(x),^1$$

where  $\phi(x)$  is single valued and analytic everywhere in  $T_n$ , except possibly at the point infinity, which, in (9), is supposed not to be an isolated singular point. If it is, it is easy to see how this discussion is to be modified. Equation (5) gives the relation

$$\alpha' + \bar{\alpha}'' + \beta' + \bar{\beta}'' + \dots + \lambda' + \bar{\lambda}'' = \text{an integer},$$

so that  $\phi(x)$  has at most a pole in the point infinity, and must be single valued there. In particular, since the exponents concerned may be increased or diminished by any integers, we may so choose them that  $\phi(x)$  will be analytic in the point infinity.

Between any three kindred functions there exists a relation which we may now easily deduce. Let  $(y', y'')$ ,  $(\bar{y}', \bar{y}'')$ ,  $(\bar{\bar{y}}', \bar{\bar{y}}'')$ , be corresponding bases of three kindred binary families, and let  $y, \bar{y}, \bar{\bar{y}}$ , be any three corresponding branches of the respective families. The bases chosen may always be so taken that if  $y = \alpha y' + \beta y''$ , we shall have

$$\bar{y} = \alpha \bar{y}' + \beta \bar{y}'', \quad \bar{\bar{y}} = \alpha \bar{\bar{y}}' + \beta \bar{\bar{y}}''.$$

Having so chosen the bases that these relations hold, we obtain the equation

$$0 = \begin{vmatrix} y & \bar{y} & \bar{\bar{y}} \\ y' & \bar{y}' & \bar{\bar{y}}' \\ y'' & \bar{y}'' & \bar{\bar{y}}'' \end{vmatrix} = y \begin{vmatrix} \bar{y}' & \bar{\bar{y}}' \\ \bar{y}'' & \bar{\bar{y}}'' \end{vmatrix} - \bar{y} \begin{vmatrix} y' & \bar{\bar{y}}' \\ y'' & \bar{\bar{y}}'' \end{vmatrix} + \bar{\bar{y}} \begin{vmatrix} y' & \bar{y}' \\ y'' & \bar{y}'' \end{vmatrix}.$$

The coefficients of  $y, \bar{y}, \bar{\bar{y}}$ , here have a form analogous to (9), so that, since the multipliers of kindred families are the same, we have only to divide through by suitable powers of  $(x-a_1), (x-b_1), \dots, (x-l_1)$ , to obtain the relation

<sup>1</sup> The notation here is readily understood by comparison with that used for the hole  $a$ .



$$(10) \quad y \Phi(x) + \bar{y} \bar{\Phi}(x) + \bar{\bar{y}} \bar{\bar{\Phi}}(x) = 0,$$

where  $\Phi$ ,  $\bar{\Phi}$ ,  $\bar{\bar{\Phi}}$  are single valued and analytic throughout  $T_n$ . Hence we may state the theorem:

I. *Any three kindred binary functions are connected by a linear and homogeneous relation whose coefficients are functions of the independent variable single valued and analytic throughout  $T_n$ .*

In case all the holes are *regular singular points* (as defined in § 4),  $\Phi$ ,  $\bar{\Phi}$ ,  $\bar{\bar{\Phi}}$ , may be taken polynomials;<sup>1</sup> it will be sufficient here to refer to the more explicit formulæ of Part II for the case  $n = 3$ , from which it is easy to see how to pass to the general case  $n > 3$ .

As a particular application of Theorem I we may note that any binary function and any derivative of that function are kindred, as can easily be verified from Theorem III of § 6. Hence from Theorem I alone we can deduce the differential equation

$$(11) \quad \phi_1 \frac{d^2 y}{dx^2} + \phi_2 \frac{dy}{dx} + \phi_3 y = 0,$$

in which the coefficients are single valued and analytic throughout  $T_n$ . If all the holes are regular singular points, these coefficients will be rational, and hence can be taken polynomials. Equation (11) is satisfied by every member of the binary family to which the function  $y$  belongs. Conversely, we know from the theory of differential equations that all the solutions of such an equation constitute a binary family. Hence we have the theorem:

II. *A binary family consists of all the solutions of a differential equation (11); and every equation (11) defines a binary family.*

## B. CLASSIFICATION OF BINARY FAMILIES FOR THE CASE $n = 3$ .

### § 1. THE PROBLEM.

The question — when are two binary families kindred? — has been answered in § 6 of Part I, A, by Theorem III, and it is to be noted that this answer has two parts. The first requirement is that the two families have the same multipliers, the second that they have a common connecting formula. To be sure we shall find cases where the satisfying of the first condition entails as a necessary consequence the satisfying of the second, but this is by no means always true.

Can we so classify binary families for the case  $n = 3$  that two families belonging to the same class will have the same group when their multipliers are the same, but

<sup>1</sup> See Riemann's paper, *Zwei allgemeine Sätze*, etc. Werke, p. 379.



will always have different groups when they belong to different classes? This is the question which will now occupy us, and which will be answered affirmatively by the actual construction of such a classification.

It is instructive to observe how this may be done for the case  $n = 2$ . Here families with the same multipliers are kindred unless the two multipliers of a hole  $a$  are equal to each other; in this case both holes may be logarithmic for some families, and semisingular for others. It will readily be seen that the following is a classification of the kind desired:

$$\begin{aligned} \text{Type I. } & \rho_a' \neq \rho_a'' \\ \text{Type II. } & \rho_a' = \rho_a'' \left\{ \begin{array}{l} \text{Class 1. } C_a = 0, \\ \text{Class 2. } C_a \neq 0. \end{array} \right. \end{aligned}$$

## § 2. THE FOUR TYPES.

Obviously the study of connecting formulæ will be most essential to our work; but it is important to notice that we need concern ourselves only with the part

$$(12) \quad \begin{aligned} y_a' &= \alpha y_b' + \beta y_b'', \\ y_a'' &= \gamma y_b' + \delta y_b'', \end{aligned}$$

since the relation  $S_c S_b S_a = 1$ , noted on page 9, shows that the generating substitution for  $c$  is expressible in terms of those for  $a$  and  $b$ . But this relation  $S_c S_b S_a^1 = 1$  gives, besides the equation

$$(13) \quad \rho_a' \rho_a'' \rho_b' \rho_b'' \rho_c' \rho_c'' = 1,$$

already given for the general case on page 12, an additional equation in terms of  $\alpha, \beta, \gamma, \delta, C_a, C_b$ , and the multipliers, which is most important for our subsequent work. We obtain this as follows: If we turn back to § 4 of Part I, A, we see that  $\rho_c'$  and  $\rho_c''$  are roots of the invariant characteristic equation

$$(14) \quad \begin{vmatrix} m_1 - \rho & n_1 \\ m_2 & n_2 - \rho \end{vmatrix} = 0,$$

where  $\begin{pmatrix} m_1 & n_1 \\ m_2 & n_2 \end{pmatrix}$  is the generating substitution of any basis about  $c$ ; if the inverse of such a generating substitution, the roots are  $\frac{1}{\rho_c'}$ ,  $\frac{1}{\rho_c''}$ . On this latter hypothesis (14) gives us two invariants. The first is

$$\frac{1}{\rho_c' \rho_c''} = \begin{vmatrix} m_1 & n_1 \\ m_2 & n_2 \end{vmatrix},$$

but this is readily seen to be (13) in another form.<sup>1</sup> The other invariant is

<sup>1</sup>  $m_1 n_2 - m_2 n_1$  is in fact the product  $\text{Det } S_a \cdot \text{Det } S_b$ . But  $\text{Det } S_a = \rho_a' \rho_a''$ , and  $\text{Det } S_b = \rho_b' \rho_b''$ .



$$(15) \quad \frac{1}{\rho_c'} + \frac{1}{\rho_c''} = m_1 + n_2,$$

and this equation will be found most essential for the classification we wish to make.

To obtain the values of  $m_1$  and  $n_2$ , let us use the relation

$$S_c^{-1} = \begin{pmatrix} m_1 & n_1 \\ m_2 & n_2 \end{pmatrix} = S_b S_a.$$

From formula (12) we can easily compute  $S_b S_a$  for the basis  $(y_b', y_b'')$ , and in this way we find

$$m_1 = \rho_a' \rho_b' [\delta - C_a \beta] \frac{a}{\Delta} - \rho_a'' \rho_b' \frac{\beta \gamma}{\Delta},$$

$$n_2 = [\rho_a' \rho_b'' (-\gamma + C_a a) + \rho_a' \rho_b' C_b (\delta - C_a \beta)] \frac{\beta}{\Delta} + [\rho_a'' \rho_b'' a - \rho_a'' \rho_b' C_b \beta] \frac{\delta}{\Delta},$$

where  $\Delta$  stands for the non-vanishing determinant  $a\delta - \beta\gamma$ . If we multiply both sides of (15) by  $\Delta$ , and perform a few simple transformations, we obtain the equation

$$(16) \quad a\delta \frac{1}{\rho_a' \rho_b' \rho_c' \rho_c''} (\rho_a' \rho_b' \rho_c' - 1) (\rho_a' \rho_b' \rho_c'' - 1) - C_a a \beta \rho_a' (\rho_b' - \rho_b'') \\ + \beta \gamma \frac{1}{\rho_c'} (\rho_a'' \rho_b' \rho_c' - 1) (\rho_a' \rho_b'' \rho_c' - 1) + C_b \beta \delta \rho_b' (\rho_a' - \rho_a'') + C_a C_b \beta^2 \rho_a' \rho_b' = 0.$$

The presence of products of multipliers  $\rho_a' \rho_b' \rho_c'$ ,  $\rho_a' \rho_b' \rho_c''$ , etc., in this equation gives us a hint that an important principle of classification is introduced when we state, for a given family, whether such a product is, or is not, equal to unity; such knowledge is, in fact, essential for the discussion of (16). That this has a deeper significance will be manifest when we have observed subsequently that whenever such a product is equal to unity, there exists a member of the family which undergoes only multiplicative substitutions when continued along any closed path in  $T_3$ . Accordingly, we divide all binary families having the same three holes into four *types*, characterized as follows:

$$\begin{array}{ll} \text{Type I.} & \rho_a' \rho_b' \rho_c' \neq 1, \quad \rho_a'' \rho_b' \rho_c' \neq 1, \quad \rho_a' \rho_b'' \rho_c' \neq 1, \quad \rho_a' \rho_b' \rho_c'' \neq 1. \\ \text{" II.} & \rho_a' \rho_b' \rho_c' = 1, \quad \rho_a'' \rho_b' \rho_c' \neq 1, \quad \rho_a' \rho_b'' \rho_c' \neq 1, \quad \rho_a' \rho_b' \rho_c'' \neq 1. \\ \text{" III.} & \rho_a' \rho_b' \rho_c' = 1, \quad \rho_a'' \rho_b' \rho_c' = 1, \quad \rho_a' \rho_b'' \rho_c' \neq 1, \quad \rho_a' \rho_b' \rho_c'' \neq 1. \\ \text{" IV.} & \rho_a' \rho_b' \rho_c' = 1, \quad \rho_a'' \rho_b' \rho_c' = 1, \quad \rho_a' \rho_b'' \rho_c' = 1, \quad \rho_a' \rho_b' \rho_c'' = 1. \end{array}$$

In each type the behavior of the remaining four products of multipliers is determined by (13). It might seem at first glance that there should be another type characterized by the relations



$$\rho_a' \rho_b' \rho_c' = 1, \quad \rho_a'' \rho_b' \rho_c' = 1, \quad \rho_a' \rho_b'' \rho_c' = 1, \quad \rho_a' \rho_b' \rho_c'' \neq 1;$$

but these four equations are inconsistent, since from the first three follows

$$\rho_a' \rho_b' \rho_c'' = 1.$$

*By a proper choice of notation every binary family in  $T_3$  can be brought under one, and but one, of the above four types.*

### § 3. CLASSIFICATION OF FAMILIES UNDER EACH TYPE.

The types have been determined by means of characteristic relations among the multipliers. In classifying under the types we make use also of the second condition that two families be kindred, namely, the requirement that they have a common connecting formula. As we have already remarked, we need use only the part (12) in this discussion. We proceed as follows:

Suppose we are given a formula (12) for a given family; and suppose also we are given a second family with the same multipliers, and belonging to it a formula

$$(17) \quad \begin{aligned} Y_a' &= \bar{\alpha} Y_b' + \bar{\beta} Y_b'', \\ Y_a'' &= \bar{\gamma} Y_b' + \bar{\delta} Y_b''; \end{aligned}$$

then, according to our criterion, *the two families are kindred when and only when, by a new choice of fundamental bases in the second family, (17) may be changed to*

$$(18) \quad \begin{aligned} \bar{y}_a' &= \alpha \bar{y}_b' + \beta \bar{y}_b'', \\ \bar{y}_a'' &= \gamma \bar{y}_b' + \delta \bar{y}_b'', \end{aligned}$$

*where the associated constants  $C$ , as well as the coefficients, have the same value as in (12). If this can be done, the two families, which are of the same type since they have the same multipliers, will belong to the same CLASS; if not, to different classes.* Here, then, is given the basis of our further classification. Let us observe that this is a classification of families by means of their groups, but it affords a classification of the groups as well.

To see how a formula (17) may be changed, let us recollect the degree of arbitrariness which enters into our choice of fundamental bases; we may multiply each member of a fundamental basis by any constant  $\neq 0$ , and still have a fundamental basis; moreover, if the hole is ordinary, this is the only way in which we can pass from one such basis to another.

We may illustrate our course of procedure by considering the case where both  $a$  and  $b$  are ordinary, while none of the coefficients in (12) and (17) vanish. We can here write, instead of (17), the new formula



$$\begin{aligned}(p Y_a') &= \frac{\bar{a} p}{r} (r Y_b') + \frac{\bar{\beta} p}{s} (s Y_b''), \\(q Y_a'') &= \frac{\bar{\gamma} q}{r} (r Y_b') + \frac{\bar{\delta} q}{s} (s Y_b'').\end{aligned}$$

We can always choose the constants  $p, q, r, s$ , so as to satisfy the equations

$$\frac{\bar{a} p}{r} = a, \quad \frac{\bar{\beta} p}{s} = \beta, \quad \frac{\bar{\delta} q}{s} = \delta,$$

and we shall then have

$$\frac{q}{r} = \frac{\delta a \bar{\beta}}{\bar{\delta} a \beta}.$$

Our new formula which we now substitute for (17) is

$$\begin{aligned}\bar{y}_a &= a \bar{y}_b' + \beta \bar{y}_b'', \\ \bar{y}_a'' &= \bar{\gamma} \frac{\delta a \bar{\beta}}{\bar{\delta} a \beta} \bar{y}_b' + \delta \bar{y}_b'',\end{aligned}$$

where  $(\bar{y}_a', \bar{y}_a'')$ ,  $(\bar{y}_b', \bar{y}_b'')$ , stand for the fundamental bases  $(p Y_a', q Y_a'')$ ,  $(r Y_b', s Y_b'')$ , respectively. Obviously a necessary and sufficient condition that the two families (which have the same multipliers, and for both of which  $C_a = C_b = 0$ ) be kindred is

$$\bar{\gamma} \frac{\delta a \bar{\beta}}{\bar{\delta} a \beta} = \gamma.$$

And to find out whether this is true, we need only make use of equation (16); but this we defer for the present.

The work in this case has been given at some length in order to make the plan of procedure clear. If a hole is semisingular, we must remember that any basis whatever is fundamental at that hole; if logarithmic, we may change from one fundamental basis to another by taking any multiple of the first member of the old for the first member of the new, the second member of the new basis being any linearly independent member of the family; but the associated constant  $C$  will in general suffer a change.

So much, by way of generalities, will suffice. The method of classification will become clearer as we proceed, case by case, in the following pages. The general procedure is to observe for each type the possible forms of (12), for families with the same multipliers, which cannot be carried over into each other by a change of fundamental bases; to each such form will belong a *class* of families. Such a plan of classification is evidently of the sort we wish; for families with the same multipliers will be kindred when, and only when, they belong to the same class.

We now proceed to an examination of each type.



Type I.  $\rho_a' \rho_b' \rho_c' \neq 1$ ,  $\rho_a'' \rho_b' \rho_c' \neq 1$ ,  $\rho_a' \rho_b'' \rho_c' \neq 1$ ,  $\rho_a' \rho_b' \rho_c'' \neq 1$ .

We observe first that the coefficient  $\beta$  in (12) cannot vanish for this type; for if  $\beta = 0$ , all the terms of (16) vanish except the first, which cannot vanish, since no product of multipliers in it = 1, and  $\alpha\delta - \beta\gamma \neq 0$ , so that  $\alpha\delta \neq 0$ . As a consequence, we see that neither  $a$  nor  $b$  can be semisingular, for any basis is fundamental for a semisingular hole, so that if  $a$  or  $b$  were semisingular we could write  $y_a' = y_b'$ , and this would be the first line of a possible formula (12); but here  $\beta = 0$ , and this we have seen to be impossible. Whether we use  $b$  or  $c$  in this work is only a matter of notation, so that it is true for this type that no hole is semisingular. Three possibilities now present themselves.

If the two holes  $a$  and  $b$  are ordinary, we have  $C_a = C_b = 0$ , and, using the two facts that  $\alpha\delta - \beta\gamma \neq 0$ , and that no product of multipliers = 1, we may easily assure ourselves, from (16), that  $\alpha, \beta, \gamma, \delta$  can none of them vanish. On page 21 we have seen that  $\alpha, \beta, \delta$  can be taken at pleasure, but  $\neq 0$ ; (16) then uniquely determines  $\gamma$ . Hence in this case all families having the same multipliers have a common formula (12), and hence are kindred.

If  $a$  is logarithmic, while  $b$  is ordinary, we have  $\rho_a' = \rho_a''$ ,  $C_a \neq 0$ ,  $C_b = 0$ . Using again the fact that  $\alpha\delta - \beta\gamma \neq 0$ , so that if  $\alpha$  were to vanish  $\gamma$  could not, we deduce from (16) that  $\alpha$  cannot vanish. We see here, as on page 21, that  $\alpha$  and  $\beta$  are at our choice, except that neither can vanish. Fixing  $y_a'$ , we can choose  $y_a''$  so that  $C_a$  has any preassigned value  $\neq 0$ . Form now a new  $y_a''$ , by adding to the old such a multiple of  $y_a'$  that in the new formula  $\delta = 0$ ;  $C_a$  remains unaltered. In this new formula, then,  $C_a, \alpha$ , and  $\beta$  are arbitrary, while  $\delta = 0$ ;  $\gamma$  is uniquely determined by (16). Hence all families here have a common formula (12), providing they have the same multipliers.

If both  $a$  and  $b$  are logarithmic, we may proceed as follows: Choose bases  $(y_a', y_a'')$ ,  $(y_b', y_b'')$ , so that  $C_a$  and  $C_b$  have any preassigned values  $\neq 0$ . Take a new  $y_b''$ , by adding to the old such a multiple of  $y_b'$  that  $\alpha = 0$ ; take as a new  $y_a'$  and  $y_a''$  such a multiple of the old pair that  $\beta$  will take on an arbitrary value  $\neq 0$ ,  $C_a$  and  $C_b$  retaining their former values. Finally, for a last  $y_a''$ , add to the former such a multiple of  $y_a'$  that the new  $\delta = 0$ . These changes leave  $C_a$  and  $C_b$  still unaltered. Then  $\gamma$ , for this new formula, is uniquely determined by (16). Again we have, for this case, a formula possessed by every family with the same multipliers.

We have thus exhausted all cases; a family with given multipliers belongs under one and only one of these cases, under each of which families with the same multipliers



are always kindred. Hence *Type I* furnishes but one class. Stated in other words: *under Type I the group is always completely determined by the multipliers.*

$$\text{Type II. } \rho_a' \rho_b' \rho_c' = 1, \quad \rho_a'' \rho_b' \rho_c' \neq 1, \quad \rho_a' \rho_b'' \rho_c' \neq 1, \quad \rho_a' \rho_b' \rho_c'' \neq 1.$$

Every hole is here ordinary; if, for instance,  $\rho_a' = \rho_a''$ , we should have  $\rho_a'' \rho_b' \rho_c' = 1$ , contrary to hypothesis. Equation (16) reduces to  $\beta\gamma = 0$ . We have, then, the following three cases:

1.  $\beta = 0, \quad \gamma \neq 0.$
2.  $\beta \neq 0, \quad \gamma = 0.$
3.  $\beta = 0, \quad \gamma = 0.$

In all these cases neither  $\alpha$  nor  $\delta$  can vanish, since  $\alpha\delta - \beta\gamma \neq 0$ . In each case the coefficients of (12) that do not vanish can take on any value  $\neq 0$  by an appropriate choice of fundamental bases, but it is impossible to prevent the specified coefficients from vanishing, or to make any others vanish. Every connecting formula can be reduced to one of *three* special ones, marked by the respective cases, but these three cannot be carried over into each other. Families of *Type II*, with the same multipliers, may fall under any one of these three cases, so that we have here three classes; these we will designate *Classes 1, 2, 3*, respectively.

$$\text{Type III. } \rho_a' \rho_b' \rho_c' = 1, \quad \rho_a'' \rho_b' \rho_c' = 1, \quad \rho_a' \rho_b'' \rho_c' \neq 1, \quad \rho_a' \rho_b' \rho_c'' \neq 1.$$

Here  $\rho_a' = \rho_a''$ , but  $\rho_b' \neq \rho_b''$ ,  $\rho_c' \neq \rho_c''$ ; hence  $C_b$  vanishes, and (16) reduces to  $C_a \alpha \beta = 0$ . Since  $\alpha$  and  $\beta$  cannot both vanish, on account of the relation  $\alpha\delta - \beta\gamma \neq 0$ , and since when  $C_a = 0$  we can always take  $\beta = 0$ , on account of the fact that  $(y_b', y_b'')$  is then fundamental at  $a$ , we have only the following three cases to consider:

1.  $C_a \neq 0, \alpha \neq 0$ . Here  $\beta$  always vanishes, from (16), while  $\delta$  never vanishes, since  $\alpha\delta - \beta\gamma \neq 0$ . Given a formula (12), we may first so change it by a new choice of  $y_b'$  and  $y_b''$  that  $\alpha$  and  $\delta$  have any values  $\neq 0$  that we please. The resulting formula we can again change by using as a new  $y_a''$  the old  $y_a''$  (which we can suppose to have been so chosen that  $C_a$  has any value we please  $\neq 0$ ), plus any multiple we please of  $y_a'$ . This leaves  $C_a, \alpha, \delta$  unchanged, but we can make the new  $\gamma$  anything we please, including zero. Hence the formulæ (12) of all families with the same multipliers under this case can be taken the same (including  $C_a$ ).

2.  $C_a \neq 0, \alpha = 0$ . The discussion here is much the same as for the previous case.  $\beta$  can never vanish, nor can  $\gamma$ ; we can take  $\beta, \gamma, C_a$  anything we please except zero, while to  $\delta$  we can give any value including zero, so that the formulæ (12) of all families under this case can be taken the same.



3.  $C_a = 0$ . Since every basis is fundamental at  $a$ , we can here always take for (12)

$$\begin{aligned} y_a' &= y_b', \\ y_a'' &= y_b''. \end{aligned}$$

A family of Type III, with given multipliers, may belong to any one of these three cases, and the formulæ of different cases (including the values of  $C_a$ ) can obviously not be carried over into each other. Hence we have here three classes which we number in correspondence with the above three cases.

$$\text{Type IV. } \rho_a' \rho_b' \rho_c' = 1, \quad \rho_a'' \rho_b' \rho_c' = 1, \quad \rho_a' \rho_b'' \rho_c' = 1, \quad \rho_a' \rho_b' \rho_c'' = 1.$$

We may deduce from the relations characterizing this type the equations  $\rho_a' = \rho_a''$ ,  $\rho_b' = \rho_b''$ ,  $\rho_c' = \rho_c''$ . Equation (16) reduces to  $C_a C_b \beta = 0$ .

It will be convenient, though not necessary, to make use of  $C_c$  here; we may then consider the following five cases:

1.  $C_a = 0, C_b \neq 0, C_c \neq 0$ .
2.  $C_a \neq 0, C_b = 0, C_c \neq 0$ .
3.  $C_a \neq 0, C_b \neq 0, C_c = 0$ .
4.  $C_a = 0, C_b = 0, C_c = 0$ .
5.  $C_a \neq 0, C_b \neq 0, C_c \neq 0$ .

These exhaust all possible cases, for if two holes are semisingular, it is obvious that the third will also be semisingular. The groups corresponding to each case are evidently different. In all cases we may take for (12)

$$(19) \quad \begin{aligned} y_a' &= y_b', \\ y_a'' &= y_b''; \end{aligned}$$

for in cases 1, 2, 4 every basis is fundamental either at  $a$  or  $b$ , while in cases 3 and 5 equation (16) gives  $\beta = 0$ , and since  $b$  is logarithmic and  $\delta \neq 0$ ,  $a \neq 0$  (on account of the relation  $a\delta - \beta\gamma \neq 0$ ), we are at liberty to rename  $a y_b'$  and  $\gamma y_b' + \delta y_b''$ , which are fundamental bases for  $b$ ,  $y_b'$ , and  $y_b''$  respectively. To find whether there is but one class under each case, we must see whether in (19)  $C_a$  and  $C_b$  can be given the same set of values for every family under each case.

1.  $C_a = 0$ .  $C_b$  can always be given any value we please  $\neq 0$ , since  $y_b''$  is at our choice. There is but one class here.

2, 3. There can obviously be but one class in each of these cases, from their resemblance to Case 1.

4.  $C_a = C_b = 0$ , always, in this case. There is but one class here.

5. We shall find an infinite number of classes under this case, for when we have chosen our bases in (19) so that one of the two quantities  $C_a, C_b$  is fixed, the other is



not at our disposal. To show this, let us introduce in place of the old bases  $(y_a', y_a'')$ ,  $(y_b', y_b'')$ , new bases  $(Y_a', Y_a'')$ ,  $(Y_b', Y_b'')$ , satisfying the equations

$$\begin{aligned} Y_a' &= Y_b', \\ Y_a'' &= Y_b'', \end{aligned}$$

the associated constants  $C$  having the values  $\bar{C}_a, \bar{C}_b$ . We must have

$$\begin{aligned} Y_a' &= \lambda_1 y_a', \\ Y_a'' &= \mu_1 y_a' + \nu_1 y_a'', \\ Y_b' &= \lambda_2 y_b', \\ Y_b'' &= \mu_2 y_b' + \nu_2 y_b''. \end{aligned}$$

By comparing with (19) we easily deduce the equations

$$\lambda_1 = \lambda_2, \quad \mu_1 = \mu_2, \quad \nu_1 = \nu_2; \quad \lambda_1 \neq 0, \quad \nu_1 \neq 0;$$

$$\frac{\bar{C}_a}{C_a} = \frac{\nu_1}{\lambda_1}, \quad \frac{\bar{C}_b}{C_b} = \frac{\nu_2}{\lambda_2},$$

giving the equation,

$$\frac{\bar{C}_a}{C_b} = \frac{C_a}{C_b} = \kappa.$$

Hence no matter what basis we use in (19),  $\kappa = \frac{C_a}{C_b}$  is the same for a given family; *i. e.*  $\kappa$  is an invariant of a family belonging to this case. Accordingly all families here with the same multipliers, *and for which  $\kappa$  is the same*, and only such families, have the same group. But is  $\kappa$  capable of taking on an infinite number of values for families with the same multipliers? We can at least see no restrictions on its value here (except that we are to avoid cases 1, 2, 3, 4), and in the last subdivision of Part II we shall give an example where  $\kappa$  can assume an infinite number of values. Each value of  $\kappa$ , then, gives a class. We get cases 1, 2, 3, by putting  $\kappa = 0, \infty, -1$ , respectively. In Case 4,  $\kappa$  has no meaning. Cases 1, 2, 3, 4 give each a class, which we number correspondingly, and we have besides these an infinite number of classes corresponding each to a different value of  $\kappa$ .

#### § 4. TABULATION OF CLASSES.

It is for many purposes useful to know the characteristics of the complete connecting formula

$$(20) \quad \begin{aligned} y_a' &= \alpha y_b' + \beta y_b'' = \alpha_1 y_c' + \beta_1 y_c'', \\ y_a'' &= \gamma y_b' + \delta y_b'' = \gamma_1 y_c' + \delta_1 y_c'', \end{aligned}$$



for each class. We have already discussed the determination of  $C_a, C_b, \alpha, \beta, \gamma, \delta$ . To find  $C_c, \alpha_1, \beta_1, \gamma_1, \delta_1$ , or rather those which depend upon the others after we have given particular values to those at our choice, we use the four equations furnished by

$$S_c S_b S_a = 1,^1$$

which we shall give in the next section. At present it is enough for our purposes to find which of the coefficients in the complete connecting formula of a family vanish, and this can easily be done with the aid of the results of the preceding section; either the symmetry of conditions at  $b$  and  $c$ , or else the relations characterizing the type, will tell us which of the coefficients  $\alpha_1, \beta_1, \gamma_1, \delta_1$  *must* vanish, and which may be made to vanish by a proper choice of bases in (20). We already know that it must be possible to reduce all complete formulæ (20) of families of the same class with the same multipliers to one and the same formula (see Theorem III of Part I, A, § 6). In the following table we briefly characterize each class.

Type I.  $\rho_a' \rho_b' \rho_c' \neq 1, \rho_a'' \rho_b' \rho_c' \neq 1, \rho_a' \rho_b'' \rho_c' \neq 1, \rho_a' \rho_b' \rho_c'' \neq 1$ .

There is but one class under this type. It is always possible to take a formula (20) in which no coefficients vanish. No hole is semisingular. Using the term *everywhere fundamental branch* to designate a member of a binary family which undergoes multiplicative substitutions only for all paths in  $T_3$ , we deduce from the behavior of the connecting formulæ the fact that there can be no everywhere fundamental branches belonging to families of this type.

Type II.  $\rho_a' \rho_b' \rho_c' = 1, \rho_a'' \rho_b' \rho_c' \neq 1, \rho_a' \rho_b'' \rho_c' \neq 1, \rho_a' \rho_b' \rho_c'' \neq 1$ .

In every family under this and the two remaining types there is an everywhere fundamental branch. For this type all holes are ordinary.

CLASS 1.  $\beta = \beta_1 = 0$ , while the other coefficients in (20) can never vanish. Only a branch  $y_a'$ , and its constant multiples, is everywhere fundamental, its multipliers being  $\rho_a', \rho_b', \rho_c'$ .

CLASS 2.  $\gamma = \gamma_1 = 0$ ; no other coefficients in (20) can vanish. Only a branch  $y_a''$ , and its constant multiples, is everywhere fundamental, its multipliers being  $\rho_a'', \rho_b'', \rho_c''$ .

CLASS 3.  $\beta = \beta_1 = \gamma = \gamma_1 = 0$ ; no other coefficient in (20) can vanish. Only two linearly independent branches,  $y_a'$  and  $y_a''$ , and their constant multiples, are everywhere fundamental, their multipliers being  $\rho_a', \rho_b', \rho_c'$ , and  $\rho_a'', \rho_b'', \rho_c''$ , respectively.

<sup>1</sup> Equivalent to only three besides (13).



Type III.  $\rho_a' \rho_b' \rho_c' = 1$ ,  $\rho_a'' \rho_b' \rho_c' = 1$ ,  $\rho_a' \rho_b'' \rho_c' \neq 1$ ,  $\rho_a' \rho_b' \rho_c'' \neq 1$ .

Here  $\rho_a' = \rho_a''$ , but  $b$  and  $c$  are ordinary.

CLASS 1.  $\beta$  and  $\beta_1$  must vanish, and  $\gamma$  can always be made to vanish, in which case none of the other coefficients in (20) = 0.  $a$  is logarithmic. There is but one branch  $y_a'$ , and its constant multiples, everywhere fundamental, its multipliers being  $\rho_a'$ ,  $\rho_b'$ ,  $\rho_c'$ .

CLASS 2.  $\alpha$  and  $\alpha_1$  must vanish, and  $\delta$  can always be made to vanish, in which case none of the other coefficients in (20) = 0.  $a$  is logarithmic. Only a branch  $y_a'$ , and its constant multiples, is everywhere fundamental, its multipliers being  $\rho_a'$ ,  $\rho_b''$ ,  $\rho_c''$ .

CLASS 3. We may take none of coefficients in (20) zero, or as many as four; for instance  $\beta$ ,  $\beta_1$ ,  $\gamma$ ,  $\gamma_1$ .  $a$  is semisingular. Only two linearly independent branches,  $y_a'$  and  $y_a''$ , and their constant multiples, are everywhere fundamental, their multipliers being  $\rho_a'$ ,  $\rho_b'$ ,  $\rho_c'$ , and  $\rho_a'$ ,  $\rho_b''$ ,  $\rho_c''$ , respectively.

Type IV.  $\rho_a' \rho_b' \rho_c' = 1$ ,  $\rho_a'' \rho_b' \rho_c' = 1$ ,  $\rho_a' \rho_b'' \rho_c' = 1$ ,  $\rho_a' \rho_b' \rho_c'' = 1$ .

No holes are ordinary. Every family under this type has a formula

$$\begin{aligned} y_a' &= y_b' = y_c', \\ y_a'' &= y_b'' = y_c''. \end{aligned}$$

This type has its classes characterized by the invariant

$$\kappa = \frac{C_a}{C_b},$$

or, to put it as an equation in homogeneous form, the invariant equation

$$(21) \quad \kappa' C_a - \kappa'' C_b = 0,$$

where  $\kappa'$  and  $\kappa''$  are never both zero. Each value of  $\frac{\kappa''}{\kappa'}$  (or  $\frac{\kappa'}{\kappa''}$ ) gives a class, if we except the possibility of  $C_a$  and  $C_b$  both vanishing, which gives an additional class. There are an infinite number of classes under this type.

CLASS 1.  $\kappa'' = 0$ .  $a$  is semisingular,  $b$  and  $c$  logarithmic. In this class, as well as in all other classes under this type except Class 4, there is but one branch, and its constant multiples, everywhere fundamental.

CLASS 2.  $\kappa' = 0$ .  $b$  is semisingular,  $a$  and  $c$  logarithmic.

CLASS 3.  $\kappa' + \kappa'' = 0$ .  $c$  is semisingular,  $a$  and  $b$  logarithmic.

CLASS 4. (21) is identically satisfied. All holes are semisingular. All members are everywhere fundamental.



The remaining classes are infinite in number, each corresponding to a value of  $\frac{\kappa''}{\kappa'}$  other than 0,  $\infty$ ,  $-1$ . In all of them all holes are logarithmic.

In conclusion, we deduce from this table the following theorems:

I. *The condition that some product  $\rho_a \rho_b \rho_c = 1$  is sufficient, as well as necessary, that a family have an everywhere fundamental branch.*

II. *A necessary, but obviously not a sufficient condition that a hole be semisingular is that at least four products  $\rho_a \rho_b \rho_c = 1$ .* Theorem I shows that a family which has a semisingular hole must have an everywhere fundamental branch.

III. *The classes of Types II and III are completely characterized by the multipliers belonging to their everywhere fundamental branches.* With Type IV this is no longer true.

§ 5. THE FOUR EQUATIONS PROCEEDING FROM THE RELATION  $S_c S_b S_a = 1$ .

Let  $S_c S_b S_a = \begin{pmatrix} m_1 & n_1 \\ m_2 & n_2 \end{pmatrix}$ . Then the equation  $S_c S_b S_a = 1$  is readily seen to be in reality equivalent to the four

$$m_1 = 1, \quad n_1 = 0, \quad m_2 = 0, \quad n_2 = 1.$$

The constants  $m_1, n_1, m_2, n_2$ , may be obtained directly in terms of the coefficients of a connecting formula, the associated constants  $C$ , and the multipliers, by performing the substitutions indicated. We are thus led to four equations connecting these latter quantities, which will be found equivalent to three such equations besides the relation  $\rho_a' \rho_a'' \rho_b' \rho_b'' \rho_c' \rho_c'' = 1$ . Other methods more convenient than using the substitution product  $S_c S_b S_a$  suggest themselves; for instance, to use the equation in the form  $S_b S_a = S_c^{-1}$ . Without going into the details of this computation, we here append, under four cases, the system of equations sought for, giving them in as simple and symmetrical form as possible. With the first set it will be interesting to compare the equations given by Riemann for the class of hypergeometric families which he considers.<sup>1</sup>

1.  $\rho_a' \neq \rho_a'', \rho_b' \neq \rho_b'', \rho_c' \neq \rho_c''$ .  
 $(\rho_a' \rho_b' \rho_c' - 1) a_1 \delta = (\rho_a'' \rho_b' \rho_c' - 1) \beta \gamma_1$ ,  
 $(\rho_a' \rho_b'' \rho_c' - 1) a_1 \gamma = (\rho_a'' \rho_b'' \rho_c' - 1) a \gamma_1$ ,  
 $(\rho_a' \rho_b' \rho_c'' - 1) \beta_1 \delta = (\rho_a'' \rho_b' \rho_c'' - 1) \beta \delta_1$ ,  
 $(\rho_a' \rho_b'' \rho_c'' - 1) \beta_1 \gamma = (\rho_a'' \rho_b'' \rho_c'' - 1) a \delta_1$ .
2.  $\rho_a' = \rho_a'', \rho_b' \neq \rho_b'', \rho_c' \neq \rho_c''$ .  
 $(\rho_a' \rho_b' \rho_c' - 1) (a_1 \delta - \beta \gamma_1) = C_a a_1 \beta \rho_a' \rho_b' \rho_c'$ ,  
 $(\rho_a' \rho_b'' \rho_c' - 1) (a_1 \gamma - a \gamma_1) = C_a a_1 a \rho_a' \rho_b'' \rho_c'$ ,  
 $(\rho_a' \rho_b' \rho_c'' - 1) (\beta_1 \delta - \beta \delta_1) = C_a \beta_1 \beta \rho_a' \rho_b' \rho_c''$ ,  
 $(\rho_a' \rho_b'' \rho_c'' - 1) (\beta_1 \gamma - a \delta_1) = C_a a \beta_1 \rho_a' \rho_b'' \rho_c''$ .

<sup>1</sup> Werke, p. 73.



$$3. \rho_a' = \rho_a'', \rho_b' \neq \rho_b'', \rho_c' = \rho_c''.$$

$$(\rho_a' \rho_b' \rho_c' - 1) (a_1 \delta - \beta \gamma_1) = \rho_a' \rho_b' \rho_c' [C_c (\beta \delta_1 - \beta_1 \delta) + \beta C_a (a_1 + C_c \beta_1)],$$

$$(\rho_a' \rho_b'' \rho_c' - 1) (a_1 \gamma - a \gamma_1) = \rho_a' \rho_b'' \rho_c' [C_c (a \delta_1 - \beta_1 \gamma) + a C_a (a_1 + C_c \beta_1)],$$

$$(\rho_a' \rho_b' \rho_c' - 1) (\beta_1 \delta - \beta \delta_1) = \rho_a' \rho_b' \rho_c' C_a \beta_1 \beta,$$

$$(\rho_a' \rho_b'' \rho_c' - 1) (\beta_1 \gamma - a \delta_1) = \rho_a' \rho_b'' \rho_c' C_a a \beta_1.$$

$$4. \rho_a' = \rho_a'', \rho_b' = \rho_b'', \rho_c' = \rho_c''.$$

$$(\rho_a' \rho_b' \rho_c' - 1) (a_1 \delta - \beta \gamma_1) = \rho_a' \rho_b' \rho_c' [C_c (\beta \delta_1 - \beta_1 \delta) + \beta C_a (a_1 + C_c \beta_1)],$$

$$(\rho_a' \rho_b' \rho_c' - 1) (a_1 \gamma - a \gamma_1) = \rho_a' \rho_b' \rho_c' [C_c (a \delta_1 - \beta_1 \gamma) + a C_a (a_1 + C_c \beta_1)] + C_b (a_1 \delta - \beta \gamma_1),$$

$$(\rho_a' \rho_b' \rho_c' - 1) (\beta_1 \delta - \beta \delta_1) = \rho_a' \rho_b' \rho_c' C_a \beta_1 \beta,$$

$$(\rho_a' \rho_b' \rho_c' - 1) (\beta_1 \gamma - a \delta_1) = \rho_a' \rho_b' \rho_c' C_a a \beta_1 + C_b (\beta_1 \delta - \beta \delta_1).$$



## PART II.

### HYPERGEOMETRIC FAMILIES.

#### A. DEFINING PROPERTIES.

##### § 1. REGULAR SINGULAR POINTS FOR BINARY FAMILIES. EXPONENTS.

In Part I, A, § 4, we have shown that if the hole  $a$  is a point, a basis  $(y_a', y_a'')$  has, in a properly chosen circle about  $a$ , the Laurent's developments

$$(22) \quad \begin{aligned} y_a' &= (x - a)^{\alpha'} \sum_{\nu=-\infty}^{+\infty} g_\nu' (x - a)^\nu, \\ y_a'' &= (x - a)^{\alpha''} \sum_{\nu=-\infty}^{+\infty} g_\nu'' (x - a)^\nu + \frac{C_a}{2\pi i} y_a' \log(x - a), \end{aligned}$$

provided  $a$  is finite; if  $a$  is the point infinity, we need only substitute  $\frac{1}{x}$  for  $(x-a)$  in (22), and this remark will apply throughout the subsequent work where we explicitly consider only the case where  $a$  is finite.

In the above-mentioned section, we have called  $a$  a *regular singular point* when the developments in (22) contain only a finite number of terms with negative values of  $\nu$ ; this is readily seen to be equivalent to the definition: *A finite regular singular point  $a$  of a binary family is an isolated singular point such that, if  $(y', y'')$  is some basis of the family, there exists a constant  $\alpha$  for which the equations*

$$\begin{aligned} \lim_{x \rightarrow a} (x - a)^\alpha y' &= 0, \\ \lim_{x \rightarrow a} (x - a)^\alpha y'' &= 0, \end{aligned}$$

*are always satisfied.* These equations will then be true for *every* basis. We now examine in detail the fundamental bases of binary families for a regular singular point  $a$ .

If  $a$  is ordinary, a fundamental basis for that point always has the developments

$$(23) \quad \begin{aligned} y_a' &= (x - a)^{\kappa'} \sum_{\nu=0}^{+\infty} g_\nu' (x - a)^\nu, & g_0' &\neq 0, \\ y_a'' &= (x - a)^{\kappa''} \sum_{\nu=0}^{+\infty} g_\nu'' (x - a)^\nu, & g_0'' &\neq 0. \end{aligned}$$



Since  $\rho_a' = e^{2\pi i \kappa'}$ ,  $\rho_a'' = e^{2\pi i \kappa''}$ , the difference  $\kappa' - \kappa''$  cannot be an integer or zero, from our definition of the term ordinary.

If  $a$  is semisingular, formula (23) still holds for a fundamental basis  $(y_a', y_a'')$ . Here we have  $\kappa' - \kappa'' =$  an integer or zero, but evidently, since every basis is here fundamental for  $a$ , we can choose a basis for which  $\kappa' \neq \kappa''$ .

If  $a$  is logarithmic we have

$$(24) \quad y_a' = (x-a)^{\kappa'} \sum_{\nu=0}^{\nu=+\infty} g_{\nu}' (x-a)^{\nu}, \quad g_0' \neq 0.$$

$$y_a'' = (x-a)^{\kappa''} \sum_{\nu=0}^{\nu=+\infty} g_{\nu}'' (x-a)^{\nu} + \frac{C_a}{2\pi i} y_a' \log(x-a).$$

Here  $\kappa' - \kappa'' =$  an integer or zero, but we must note the possibility of all the coefficients  $g_{\nu}''$  vanishing, in which case  $\kappa''$  has no meaning. Provided there is some  $g_{\nu}'' \neq 0$  we suppose the notation so chosen in (24) that  $g_0'' \neq 0$ .

In all these cases we may observe a property of the branches in a fundamental basis which is most important, namely that expressed by the equation

$$\lim_{x \rightarrow a} (x-a)^{-\lambda} [\log(x-a)]^{-k} y = g_0, \quad g_0 \neq 0,$$

a notation which covers all cases, if  $k$  is either 0 or 1. When such an equation is satisfied,  $y$  is said to have the exponent  $\lambda$  at  $a$ .<sup>1</sup>

In the ordinary case,  $y_a'$  and  $y_a''$  have the exponents  $\kappa'$  and  $\kappa''$  respectively at  $a$ . These we rename  $\lambda'$  and  $\lambda''$ . For a semisingular point  $a$ ,  $y_a'$  and  $y_a''$  again have the exponents  $\kappa'$  and  $\kappa''$ . When  $y_a'$  and  $y_a''$  are so chosen that  $\kappa' - \kappa'' > 0$ , we rename these exponents  $\lambda'$  and  $\lambda''$ , respectively. When  $a$  is logarithmic, the exponent of  $y_a'$  at  $a$  is  $\kappa'$ ; if  $\kappa' - \kappa'' > 0$ , the exponent of  $y_a''$  is  $\kappa''$ , if  $\kappa' - \kappa'' \leq 0$ , the exponent of  $y_a''$  is  $\kappa'$ . Again we rename the exponents  $\lambda'$  and  $\lambda''$ ,  $\lambda'$  being the exponent of  $y_a'$  and  $\lambda''$  the exponent of  $y_a''$ . In all cases the general member of the family,  $c_1 y_a' + c_2 y_a''$ , can have for its exponent at  $a$  but one of the two quantities  $\lambda'$  and  $\lambda''$ . It will be natural, then, to speak of  $\lambda'$  and  $\lambda''$  as the *exponents of the family at a*. Let us remember that

<sup>1</sup> We may consider this definition as a particular case of the following: A function  $\phi(x)$  is said to have the exponent  $\lambda$  at the point  $a$ , if there exists some positive integer  $k$  (including  $k=0$ ), such that no matter how  $x$  approaches  $a$ , being confined, however, to the neighborhood of  $a$ , we always have

$$\lim_{x \rightarrow a} (x-a)^{-\lambda} [\log(x-a)]^{-k} \phi(x) = M,$$

where  $M$  is some constant  $\neq 0$ . This seemingly arbitrary definition is nevertheless one which applies to all solutions of homogeneous linear differential equations of any order at a regular point. Students of that subject will readily satisfy themselves that  $\lambda$  is one of the *exponents of a* in the sense in which that term is used for such differential equations.



when  $a$  is semisingular, our notation is so chosen that  $\lambda' - \lambda'' > 0$ , while, for  $a$  logarithmic,  $\lambda' - \lambda'' \geq 0$ . Equal exponents, then, occur only when  $a$  is logarithmic.

A new notation will be found useful to indicate a basis fundamental at  $a$  with exponents  $\lambda', \lambda''$ ; such a basis we designate by  $(y^{(\lambda')}, y^{(\lambda'')})$ . This coincides with the notation  $(y_a', y_a'')$  except in the case of a semisingular point. We have, then, the formula applicable to all cases

$$(25) \quad \begin{aligned} y^{(\lambda')} &= (x-a)^{\lambda'} \sum_{\nu=0}^{+\infty} g_{\nu}' (x-a)^{\nu}, \\ y^{(\lambda'')} &= (x-a)^{\lambda''} \sum_{\nu=0}^{+\infty} g_{\nu}'' (x-a)^{\nu} + \frac{C_a}{2\pi i} y^{(\lambda')} \log(x-a), \end{aligned}$$

where  $g_0' \neq 0$ ;  $g_0'' \neq 0$  when  $\lambda' \neq \lambda''$ , but we may have  $g_0'' = 0$  when  $\lambda' = \lambda''$ , in which case  $a$  is logarithmic and  $C_a \neq 0$ .

It is also true that a binary family has two exponents at every point in  $T_n$ ; the family being analytic at such points, these exponents must be positive integers.

The cases where the holes for a family are regular singular points, one or two in number, are of comparatively little interest, for the functions there involved are of a very elementary form. We shall be concerned hereafter with the special class of binary families whose holes are all regular singular points, *three* in number. Such families we call *Hypergeometric Families*.<sup>1</sup> At the three regular singular points  $a, b, c$ , such a family will have exponents  $\lambda', \lambda''$ ;  $\mu', \mu''$ ;  $\nu', \nu''$ , respectively, and formulæ analogous to (25) will exist for each point.

## § 2. THE EXPONENT SUM AND APPARENTLY SINGULAR POINTS. THE DETERMINANT $D$ .

The exponents are a first essential in the definition of a hypergeometric family; they are, however, not entirely independent of each other, since they are subject to the relation

$$\lambda' + \lambda'' + \mu' + \mu'' + \nu' + \nu'' = \text{an integer.}$$

The positions of the regular singular points  $a, b, c$  are, from one point of view, non-essential, since they can be carried over by a linear transformation into any other three without changing the exponents, but we must remember that we have then a new independent variable. In particular,  $a, b, c$  can be carried over into  $0, \infty, 1$  respectively, by the transformation

$$(26) \quad x' = \frac{(x-a)(b-c)}{(x-b)(a-c)}.$$

<sup>1</sup> Cf. Klein's term "Hypergeometrische Functionen," which he ultimately extends to all cases here considered. We shall find (in C, § 2) that all members of such families are expressible in terms of elementary functions and hypergeometric series.



We have seen that the exponent sum must be an integer; we may go further and state that this integer must be 1, 0, or negative. This result is obtained from a study of the functional determinant

$$D = \begin{vmatrix} y' & \frac{dy'}{dx} \\ y'' & \frac{dy''}{dx} \end{vmatrix}$$

If we compute  $\frac{dy^{(\lambda')}}{dx}$  and  $\frac{dy^{(\lambda'')}}{dx}$  from (25), we have

$$\begin{aligned} \frac{dy^{(\lambda')}}{dx} &= (x-a)^{\lambda'-1} [g_0' \lambda' + g_1' (\lambda' + 1) (x-a) + \dots], \\ \frac{dy^{(\lambda'')}}{dx} &= (x-a)^{\lambda''-1} [g_0'' \lambda'' + g_1'' (\lambda'' + 1) (x-a) + \dots] \\ &\quad + \frac{C_a}{2\pi i} \left[ (x-a)^{\lambda'-1} \sum_{\nu=0}^{+\infty} g_\nu' (x-a)^\nu + \frac{dy^{(\lambda')}}{dx} \log(x-a) \right]. \end{aligned}$$

As we have already remarked, p. 17, a binary function and its derivative are always kindred. Accordingly we have, using the relation of page 15,

$$D = \text{Det } A \cdot \begin{vmatrix} y^{(\lambda')} & \frac{dy^{(\lambda')}}{dx} \\ y^{(\lambda'')} & \frac{dy^{(\lambda'')}}{dx} \end{vmatrix} = \text{Det } A \cdot \left[ (x-a)^{\lambda'+\lambda''-1} \{g_0' g_0'' (\lambda'' - \lambda') + g_1 (x-a) + \dots\} + \frac{C_a}{2\pi i} (x-a)^{2\lambda'-1} \{g_0'^2 + \bar{g}_1 (x-a) + \dots\} \right].$$

Hence  $D$  can have no logarithmic terms. If  $a$  is not logarithmic,  $C_a = 0$  and  $g_0' g_0'' (\lambda'' - \lambda') \neq 0$ , so that we have the development about  $a$ <sup>1</sup>

$$(27) \quad D = (x-a)^{\lambda'+\lambda''-1} \sum_{\nu=0}^{+\infty} g_\nu (x-a)^\nu, \quad g_0 \neq 0.$$

If  $a$  is logarithmic, and  $\lambda' \neq \lambda''$ , the same formula holds, since  $\lambda' - \lambda''$  is an integer. If  $\lambda' = \lambda''$ , then  $g_0' g_0'' (\lambda'' - \lambda') = 0$ , but  $g_0'^2 C_a / 2\pi i \neq 0$ , while  $2\lambda' - 1 = \lambda' + \lambda'' - 1$ , so that (27) still holds. In all cases, therefore, (27) gives the development of  $D$  about  $a$  when  $a$  is finite. If  $a$  is the point infinity, the reader may easily verify the development

$$(28) \quad D = \left(\frac{1}{x}\right)^{\lambda'+\lambda''+1} \sum_{\nu=0}^{+\infty} g_\nu \left(\frac{1}{x}\right)^\nu, \quad g_0 \neq 0.$$

In the preceding paragraph we have discussed only the case of a regular singular point, but obviously analogous developments must hold at non-singular points; in fact

<sup>1</sup> See Klein, p. 222 *et seq.*, where only ordinary singular points are considered.



if  $t$  denotes such a point, with exponents  $\tau', \tau''$  (which must be positive integers or zero, and unequal), we have about  $t$  the developments analogous to (27)

$$(29) \quad D = (x - t)^{\tau' + \tau'' - 1} \sum_{\nu=0}^{\nu=+\infty} g_{\nu} (x - t)^{\nu}, \quad g_0 \neq 0.$$

If  $t$  is the point infinity, we have about it a development analogous to (28).

Let us now take our regular singular points at  $0, \infty, 1$ , as we may always do by means of transformation (26). We have the equation

$$(30) \quad D = x^{\lambda' + \lambda'' - 1} (x - 1)^{\nu' + \nu'' - 1} \phi(x),$$

where the function  $\phi(x)$  has obviously no singularities in the finite region of the plane, since the only singular points of  $D$  are  $0, \infty, 1$ , at which developments (27) and (28) hold. At the point  $\infty$ ,  $\phi(x)$  has the exponent of  $D$  in that point increased by  $(\lambda' + \lambda'' - 1) + (\nu' + \nu'' - 1)$ ; *i. e.* the exponent

$$(\lambda' + \lambda'' - 1) + (\mu' + \mu'' + 1) + (\nu' + \nu'' - 1).$$

Since the exponent sum  $\lambda' + \lambda'' + \mu' + \mu'' + \nu' + \nu''$  is always an integer, we see that  $\phi(x)$  can have at most a pole in the point infinity. Hence  $\phi(x)$  must be a polynomial<sup>1</sup> and its degree is obviously the negative of its exponent at infinity; *i. e.*, it is

$$1 - (\lambda' + \lambda'' + \mu' + \mu'' + \nu' + \nu'').$$

This number, therefore, must be a positive integer or zero. Hence *the exponent sum can have only the following values:*

$$+ 1, 0, -1, -2, \dots$$

In particular  $\phi$  is a constant when, and only when, the exponent sum is  $+ 1$ . (Cf. Klein, p. 224.)

Families whose exponent sum is  $+ 1$  we shall call *P families*, using the notation which Riemann adopted in his celebrated paper, in which, however, his discussion is limited to families for which  $a, b, c$  are all ordinary. A family whose exponent sum is  $1 - n$ , we will call a *Q family* of order  $n$ , *Q* being again a notation used by Riemann.<sup>2</sup> Functions belonging to these families we designate *P functions* and *Q functions* respectively. We may, if we please, regard *P families* as special *Q families*, namely those of order zero.

The distinction between *P* and *Q* families can be given in another way: *No branch of a P family vanishes to an order higher than the first in any point other than 0,*

<sup>1</sup> We should observe here that  $\phi(x) \equiv 0$  is impossible, since this would make  $D$  vanish identically, — an absurdity, for  $y'$  and  $y''$  are linearly independent. See § 4 of the first-mentioned paper of Riemann.

<sup>2</sup> In the paper: Ueber die Fläche vom kleinsten Inhalt, etc., for a family of order 2. Werke, p. 323.



$\infty, 1$ , when these are the regular singular points. In other words, every non-singular point of a  $P$  family has the exponents 0, 1. Every  $Q$  family (of order  $> 0$ ) has at least one branch which vanishes to an order higher than the first in some non-singular point. This we may show by an examination of the polynomial  $\phi(x)$ , which enters in (30). We have

$$(31) \quad \phi(x) = k(x - s_1)^{\sigma_1}(x - s_2)^{\sigma_2} \dots (x - s_\kappa)^{\sigma_\kappa},$$

where  $k$  is a constant  $\neq 0$ , and each of the exponents  $\sigma$  is a positive integer, their sum, the degree of  $\phi(x)$ , being  $n$  for a family of order  $n$ . The points  $s_1, s_2, \dots, s_\kappa$  are here all different from 0,  $\infty, 1$ ; each is a vanishing point of  $D$ , and in fact these are the only such points other than 0,  $\infty, 1$ . We will call them *apparently singular points*<sup>1</sup> (Poincaré); in particular, referring to (31), we shall call  $s_i$  a  $\sigma_i$ -fold apparently singular point. From (29) we see that  $t$  is an apparently singular point when, and only when,  $\tau' + \tau'' > 1$ , *i. e.* when at least one exponent of  $t$  is greater than 1. Hence, an *apparently singular point* is one at which some branch of the family vanishes to an order higher than 1. Since  $\phi(x)$  is a constant for  $P$  families, they can have no apparently singular points.

Let us designate the exponents of  $s_i$  ( $i = 1, 2, \dots, \kappa$ ) by  $\sigma_i', \sigma_i''$ . Referring to (29) we may then say: *To a  $\sigma_i$ -fold apparently singular point belong two positive integral exponents  $\sigma_i'$  and  $\sigma_i''$  whose sum is  $\sigma_i + 1$ .*

Each point  $s_i$  introduces a new parameter into the family; it will turn out that only the groups of  $P$  families are in all cases completely determined by the exponents and the regular singular points.<sup>2</sup>

It will be useful to introduce here a notation analogous to that used by Riemann for  $P$  functions. Accordingly we will designate by the symbol

$$(32) \quad Q \left( \begin{array}{ccc} \overset{a}{\lambda'} & \overset{b}{\mu'} & \overset{c}{\nu'} \\ \lambda'' & \mu'' & \nu'' x \end{array} \right),$$

any  $Q$  family with the regular singular points and exponents indicated. If we wish to specialize still further by indicating the apparently singular points and their exponents, we will use the symbol

$$(33) \quad Q \left( \begin{array}{ccc} \overset{a}{\lambda'} & \overset{b}{\mu'} & \overset{c}{\nu'} \\ \lambda'' & \mu'' & \nu'' x \end{array} \parallel \begin{array}{cccc} s_1 & s_2 & \dots & s_\kappa \\ \sigma_1' & \sigma_2' & \dots & \sigma_\kappa' \\ \sigma_1'' & \sigma_2'' & \dots & \sigma_\kappa'' \end{array} x \right).$$

<sup>1</sup> Cf. Klein's term "Nebenpunkte," p. 225.

<sup>2</sup> It is to be remembered here that to determine the *concrete* group, we must know the regular singular points. To be sure we may carry these into any other three by a suitable linear transformation, but this gives us a new independent variable, and we can make no direct comparisons with the groups of functions of the old variable. In order that we may compare groups of families, the families must have the same regular singular points when expressed as functions of the same variable. That this is the case we assume throughout this paper.



As it is merely a matter of notation, we can interchange arbitrarily amongst each other in this symbol the columns to the right of the vertical bars, and those to the left. To the right, the exponents  $\sigma_i'$ ,  $\sigma_i''$  are interchangeable; to the left, a similar remark holds when  $a, b, c$  are ordinary, but is no longer true for a semisingular or logarithmic point (except, of course, in the case of equal exponents), since, by the notation already adopted in such a case, the upper exponent in the symbol must be the larger.

Let us note here an extension of a property observed by Riemann for  $P$  functions: If  $Q$  is a family with the symbol (32), then

$$\left(\frac{x-a}{x-b}\right)^\delta Q$$

is a  $Q$  family with the symbol

$$\bar{Q} \begin{pmatrix} \lambda' + \delta & \mu' - \delta & \nu' \\ \lambda'' + \delta & \mu'' - \delta & \nu'' x \end{pmatrix}.$$

Further,  $\bar{Q}$  will evidently have the same apparently singular points with the same exponents as  $Q$ . But a  $Q$  family is by no means completely defined, in general, even by (33), so that we must still calculate the relations between the remaining constants required to define  $Q$  and  $\bar{Q}$ ; this we will carry out at the end of the next section for a very general class of  $Q$  families. In particular we have the relation

$$(34) \quad x^\delta (x-1)^\epsilon Q \begin{pmatrix} \lambda' & \mu' & \nu' \\ \lambda'' & \mu'' & \nu'' x \end{pmatrix} = \bar{Q} \begin{pmatrix} \lambda' + \delta & \mu' - \delta - \epsilon & \nu' + \epsilon \\ \lambda'' + \delta & \mu'' - \delta - \epsilon & \nu'' + \epsilon x \end{pmatrix},$$

$\delta$  and  $\epsilon$  being any numbers we please; and  $\bar{Q}$  will have the same apparently singular points with the same exponents as  $Q$ .

We need not here repeat this work for the apparently singular points, but one case is of especial interest. If both  $\sigma_i'$  and  $\sigma_i''$  are different from zero, and  $\sigma_i' > \sigma_i''$ , we obtain, by dividing every member by  $(x-s_i)^{\sigma_i''}$ , from our  $Q$  family with its regular singular points at 0,  $\infty$ , 1, a new one in which the exponents of  $s_i$  are  $\sigma_i' - \sigma_i''$ , 0, nothing else being changed in its symbol (33) except the exponents of the point infinity. In our subsequent work, therefore, we shall discuss only families all of whose apparently singular points have zero for one exponent. A  $\sigma$ -fold apparently singular point has, for such a family, exponents  $\sigma + 1$ , 0, and may be regarded as  $\sigma$  coincident apparently singular points, each of which is simple, *i. e.* has exponents 2, 0. Using this convention, we may state, following Klein (*cf.* pp. 226, 227), the theorem: *The order,  $n$ , of a  $Q$  family is equal to the number of its simple apparently singular points.*



## § 3. THE DIFFERENTIAL EQUATION. ACCESSORY PARAMETERS.

To complete the data necessary to determine a  $Q$  family, we turn to the differential equation of the family. We have seen in Part I,  $A$ , § 7, that if  $(y', y'')$  is any basis of a binary family, every member of that family satisfies a differential equation of the form

$$\frac{d^2 y}{dx^2} + p \frac{dy}{dx} + q y = 0;$$

and from the work given in that section we easily obtain the equations

$$p = -\frac{\frac{d}{dx} D}{D} = -\frac{d}{dx} \log D,$$

$$q = \frac{D'}{D},$$

where  $D$  denotes the functional determinant

$$\begin{vmatrix} y' & \frac{dy'}{dx} \\ y'' & \frac{dy''}{dx} \end{vmatrix},$$

and  $D'$  the determinant

$$\begin{vmatrix} \frac{dy'}{dx} & \frac{d^2 y'}{dx^2} \\ \frac{dy''}{dx} & \frac{d^2 y''}{dx^2} \end{vmatrix}.$$

For a  $Q$  family of order  $n$  whose symbol is

$$(35) \quad Q \left( \begin{array}{ccc|cccc} \overset{0}{\lambda'} & \overset{\infty}{\mu'} & \overset{1}{\nu'} & \overset{s_1}{\sigma_1 + 1} & \overset{s_2}{\sigma_2 + 1} & \dots & \overset{s_\kappa}{\sigma_\kappa + 1} & x \\ \lambda'' & \mu'' & \nu'' & 0 & 0 & \dots & 0 & \end{array} \right),$$

we have, using the notation of the preceding section,

$$(36) \quad p = \frac{1 - \lambda' - \lambda''}{x} + \frac{1 - \nu' - \nu''}{x - 1} - \frac{\sigma_1}{x - s_1} - \frac{\sigma_2}{x - s_2} - \dots - \frac{\sigma_\kappa}{x - s_\kappa}.$$

The calculation of  $q$  for such a family is, perhaps, best performed as follows:

Obviously the derivatives of the members of the family whose symbol is (35) themselves constitute a  $Q$  family<sup>1</sup> for which  $D'$  is the functional determinant.  $D'$

<sup>1</sup> We must note one exception, namely where one branch of the family whose symbol is (35) is a constant. Here the family  $\frac{dQ}{dx}$  is not a binary family, but  $q \equiv 0$ , a result which agrees with our subsequent formulæ.



has, then, no logarithmic terms. Further, it is easy to see that the exponent of  $D'$  at 0 is equal to or greater than  $\lambda' + \lambda'' - 3$ ; similarly, at  $\infty$ , its exponent is as large as  $\mu' + \mu'' + 3$ , and at 1, as large as  $\nu' + \nu'' - 3$ . By a course of reasoning analogous to that used for the determinant  $D$ , we conclude that  $D'$  is of the form

$$x^{\lambda'+\lambda''-3} (x-1)^{\nu'+\nu''-3} \phi'(x),$$

where  $\phi'(x)$ , which may have roots at 0 and 1, is a polynomial whose degree we denote by  $m$ ; the exponent of  $D'$  at  $\infty$  is therefore

$$-(\lambda' + \lambda'' - 3 + \nu' + \nu'' - 3 + m).$$

But we have seen that this exponent is as large as  $\mu' + \mu'' + 3$ , so that we have

$$m \leq n + 2.$$

We have, therefore, for  $q$  the value

$$q = \frac{1}{x(x-1)} \left[ \frac{\phi'(x)}{kx(x-1)(x-s_1)^{\sigma_1}(x-s_2)^{\sigma_2}\cdots(x-s_\kappa)^{\sigma_\kappa}} \right].$$

But, if  $\sigma_i > 1$ , we may easily show that  $\phi'(x)$  has a factor  $(x-s_i)^r$  where  $r \geq \sigma_i - 1$ , by differentiating twice the branches

$$(x-s_i)^{\sigma_i+1} [1 + c_1'(x-s_i) + \cdots],$$

$$1 + c_1''(x-s_i) + \cdots,$$

and substituting the results in  $D'$ . Hence we may write

$$q = \frac{1}{x(x-1)} \left[ \frac{\psi(x)}{x(x-1)(x-s_1)(x-s_2)\cdots(x-s_\kappa)} \right],$$

where  $\psi(x)$  is a polynomial of degree  $\leq \kappa + 2$ . This, again, may be put into the form

$$(37) \quad q = \frac{1}{x(x-1)} \left[ \frac{M_1}{x} + M_2 + \frac{M_3}{x-1} + \frac{A_1}{x-s_1} + \frac{A_2}{x-s_2} + \cdots + \frac{A_\kappa}{x-s_\kappa} \right],$$

where  $M_1, M_2, M_3, A_1, A_2, \dots, A_\kappa$  are constant with respect to  $x$ , but are as yet undetermined functions of the exponents and apparently singular points.

We may at once find  $M_1$  by substituting a branch  $Q^{(\lambda')}$  in the differential equation of the family, thus obtaining a set of equations which must be satisfied. The first of these is  $M_1 = -\lambda'\lambda''$ . By similarly substituting  $Q^{(\mu')}$  and  $Q^{(\nu')}$ , respectively, we obtain the equations

$$M_2 = \mu'\mu'', \quad M_3 = \nu'\nu''.$$



The differential equation of every  $Q$  family whose symbol is (35) is, therefore,

$$(38) \quad \frac{d^2 Q}{dx^2} + \left[ \frac{1 - \lambda' - \lambda''}{x} + \frac{1 - \nu' - \nu''}{x-1} - \sum_{i=1}^{\kappa} \frac{\sigma_i}{x-s_i} \right] \frac{dQ}{dx} \\ + \left[ -\frac{\lambda' \lambda''}{x} + \mu' \mu'' + \frac{\nu' \nu''}{x-1} + \sum_{i=1}^{\kappa} \frac{A_i}{x-s_i} \right] \frac{Q}{x(x-1)} = 0,$$

where the *accessory parameters*<sup>1</sup>  $A_i$  must satisfy a system of  $\kappa$  equations which we obtain from the conditions that (38) be satisfied by the  $\kappa$  branches

$$1 + c_1^{(i)}(x-s_i) + c_2^{(i)}(x-s_i)^2 + \dots, \quad (i=1, 2, \dots, \kappa).$$

These equations we will not here develop for the general case, but will content ourselves with deducing them for families all of whose apparently singular points are simple; *i. e.* where  $\sigma_i = 1$  ( $i=1, 2, \dots, \kappa=n$ ). The differential equation of such a family, its regular singular points being at  $0, \infty, 1$ , may be written

$$(39) \quad \frac{d^2 Q}{dx^2} + \left[ \frac{1 - \lambda' - \lambda''}{x} + \frac{1 - \nu' - \nu''}{x-1} - \sum_{i=1}^n \frac{1}{x-s_i} \right] \frac{dQ}{dx} \\ + \left[ -\frac{\lambda' \lambda''}{x} + \mu' \mu'' + \frac{\nu' \nu''}{x-1} + \sum_{i=1}^n \frac{A_i}{x-s_i} \right] \frac{Q}{x(x-1)} = 0.$$

This is to be satisfied by a branch whose development about  $s_i$  is

$$(40) \quad 1 + a_1(x-s_i) + a_2(x-s_i)^2 + \dots;$$

substituting this in (39) we obtain a system of equations to be satisfied by the coefficients of (40). Of these, however, only the following two impose any condition on the accessory parameters:

$$\frac{A_i}{s_i(s_i-1)} - a_1 = 0,$$

$$2a_2 - 2a_1 + \frac{a_1 A_i}{s_i(s_i-1)} - \frac{A_i}{s_i(s_i-1)} \left( \frac{1}{s_i} + \frac{1}{s_i-1} \right) + a_1 \left[ \frac{1 - \lambda' - \lambda''}{s_i} + \frac{1 - \nu' - \nu''}{s_i-1} - \sum_{j=1}^{j \neq i} \frac{1}{s_i-s_j} \right] \\ + \frac{1}{s_i(s_i-1)} \left[ -\frac{\lambda' \lambda''}{s_i} + \mu' \mu'' + \frac{\nu' \nu''}{s_i-1} + \sum_{j=1}^{j \neq i} \frac{A_j}{s_i-s_j} \right] = 0,$$

where the symbol  $\sum_{j=1}^{j \neq i}$  indicates a sum in which  $j$  is to assume all integral values from 1 to  $n$  inclusive, except the value  $i$ . These equations impose one condition on the accessory parameters  $A$ . Giving to  $i$ , successively, the values 1, 2,  $\dots$ ,  $n$ , we have the  $n$  equations

$$(41) \quad A_i^2 - A_i s_i (s_i - 1) \left[ \frac{\lambda' + \lambda''}{s_i} + \frac{\nu' + \nu''}{s_i - 1} + \sum_{j=1}^{j \neq i} \frac{1}{s_i - s_j} \right] \\ + s_i (s_i - 1) \left[ -\frac{\lambda' \lambda''}{s_i} + \mu' \mu'' + \frac{\nu' \nu''}{s_i - 1} + \sum_{j=1}^{j \neq i} \frac{A_j}{s_i - s_j} \right] = 0.$$

<sup>1</sup> A term used by Klein in his lectures since 1890.



When the accessory parameters are given a set of values satisfying (41), the solutions of (39) constitute a  $Q$  family which is completely determined and whose symbol is

$$(42) \quad Q \left( \begin{array}{ccc|ccc} 0 & \infty & 1 & s_1 & s_2 & \dots & s_n \\ \lambda' & \mu' & \nu' & 2 & 2 & \dots & 2 \\ \lambda'' & \mu'' & \nu'' & 0 & 0 & \dots & 0 \end{array} \right)^x.$$

Each set of solutions of (41) defines a  $Q$  family with the symbol (42). Hence  $P$  families only are in all cases completely determined by the exponents and the regular singular points.

A  $Q$  family of order  $n \geq 1$  is completely determined when, and only when, we know in addition to its symbol (35) the values of its accessory parameters.

We are now in a position to note the relation between the accessory parameters of the families  $Q$  and  $\bar{Q}$  in (34) (see p. 36). This we may easily do by remembering that to obtain the differential equation of  $\bar{Q}$  we have only to substitute in (38) for  $Q$  the expression

$$x^{-\delta}(x-1)^{-\epsilon}\bar{Q}.$$

If  $A_1, A_2, \dots, A_\kappa$  are the accessory parameters of  $Q$ , the accessory parameters  $\bar{A}_1, \bar{A}_2, \dots, \bar{A}_\kappa$  of  $\bar{Q}$  are given by the equations

$$(43) \quad \bar{A}_i = A_i + \sigma_i [\delta(s_i - 1) + \epsilon s_i] \quad (i = 1, 2, \dots, \kappa).$$

We have given at some length the work of deducing the differential equation when the regular singular points are at  $0, \infty, 1$ ; if they are at  $a, b, c$ , we may either use transformation (26) or proceed directly as in the previous case. We give here only the result; the equation is

$$(44) \quad \frac{d^2 Q}{dx^2} + \left[ \frac{1 - \lambda' - \lambda''}{x - a} + \frac{1 - \mu' - \mu''}{x - b} + \frac{1 - \nu' - \nu''}{x - c} - \sum_{i=1}^{\kappa} \frac{\sigma_i}{x - s_i} \right] \frac{dQ}{dx} \\ + \left[ \frac{\lambda' \lambda'' (a-b)(a-c)}{x - a} + \frac{\mu' \mu'' (b-a)(b-c)}{x - b} + \frac{\nu' \nu'' (c-a)(c-b)}{x - c} + \sum_{i=1}^{\kappa} \frac{B_i}{x - s_i} \right] \frac{Q}{(x-a)(x-b)(x-c)} = 0,$$

the accessory parameters being designated by  $B_i$  ( $i = 1, 2, \dots, \kappa$ ).

In this section is the answer to Klein's<sup>1</sup> question as to the appearance of the differential equation of a  $Q$  family. Besides showing the complete data necessary to determine a  $Q$  family, the differential equations here developed afford an existence proof for families of arbitrary order  $n$ , with an exponent scheme arbitrarily given (subject to the condition that the exponent sum is  $1 - n$ ). We shall also make use of this section in discussing the classification of  $Q$  families according to the scheme of Part I, B.

<sup>1</sup> P. 234.



## B. CRITERIA FOR THE CLASSES OF PART I, B.

 § 1. NECESSARY CONDITIONS FOR EACH CLASS IN TERMS OF THE EXPONENTS ALONE.<sup>1</sup>

In Part I, B, we first divided all possible binary families in a triply connected region into four types by means of characteristic relations amongst the multipliers. Remembering the connection between multipliers and exponents, we may write these criteria for  $Q$  families of any order, as follows:

- Type I.  $\lambda' + \mu' + \nu'$ ,  $\lambda'' + \mu' + \nu'$ ,  $\lambda' + \mu'' + \nu'$ ,  $\lambda' + \mu' + \nu''$ , are none of them integers.  
 “ II.  $\lambda' + \mu' + \nu'$  is an integer;  $\lambda'' + \mu' + \nu'$ ,  $\lambda' + \mu'' + \nu'$ ,  $\lambda' + \mu' + \nu''$ , are not integers.  
 “ III.  $\lambda' + \mu' + \nu'$ ,  $\lambda'' + \mu' + \nu'$ , are integers;  $\lambda' + \mu'' + \nu'$ ,  $\lambda' + \mu' + \nu''$ , are not integers.  
 “ IV.  $\lambda' + \mu' + \nu'$ ,  $\lambda'' + \mu' + \nu'$ ,  $\lambda' + \mu'' + \nu'$ ,  $\lambda' + \mu' + \nu''$ , are all of them integers.

We hardly need repeat here what we have already noted for the more general case, that by a proper choice of notation every  $Q$  family will come under one, and but one, of these types. The conditions given are sufficient as well as necessary for each type.

We have seen in Part I, B, § 4, that in every class other than the one of Type I each family has an everywhere fundamental branch. Let us now examine the form of such a branch with exponents  $\lambda$ ,  $\mu$ ,  $\nu$ , corresponding to multipliers  $\rho_a$ ,  $\rho_b$ ,  $\rho_c$ , for a  $Q$  family of order  $n$  whose regular singular points we take at  $0$ ,  $\infty$ ,  $1$ . *Such a fundamental branch has, in fact, the form*

$$(45) \quad Q^{(\lambda)} = x^\lambda (x-1)^\nu G(x),$$

where  $\lambda$  stands for either  $\lambda'$  or  $\lambda''$ ,  $\nu$  for either  $\nu'$  or  $\nu''$ , and  $G(x)$  is a polynomial. For  $G(x)$  is single valued, and is analytic, except in the point  $\infty$ , where it has the exponent  $\lambda + \mu + \nu$ , which must be an integer, since  $\infty$  is not a branch point. Hence the only singularity of  $G(x)$  is a possible pole at infinity, and  $G(x)$  must therefore be a polynomial whose degree, the negative of its exponent at  $\infty$ , is  $-(\lambda + \mu + \nu)$ . We have, then, the necessary relation

$$\lambda + \mu + \nu = \text{either zero or a negative integer.}$$

From this result, combined with the table of Part I, B, § 4, which gives us the multipliers of the everywhere fundamental branches, and hence their exponents, we are enabled to give certain relations among the exponents of the regular singular points which must hold for the families of each class. We proceed to take these up in order.

Type I. There is but one class here, characterized in terms of the exponents above.

<sup>1</sup> Compare Ritter's classification of  $P$  families in § 2 of his paper already cited. His numbering of classes differs from our scheme, though his types are the same. His criteria are easily reduced to ours.



Type II.  $\lambda' + \mu' + \nu'$  an integer.

CLASS 1. The everywhere fundamental branch is

$$x^{\lambda'}(x-1)^{\nu'} G(x),$$

where  $G(x)$ , as in the remainder of this section, stands for some polynomial. Here  $\lambda' + \mu' + \nu'$  is zero or a negative integer, its negative being the degree of  $G(x)$ .

CLASS 2. The everywhere fundamental branch is

$$x^{\lambda''}(x-1)^{\nu''} G(x).$$

$\lambda'' + \mu'' + \nu''$  is zero or a negative integer, its negative being the degree of  $G(x)$ . Since

$$\lambda' + \lambda'' + \mu' + \mu'' + \nu' + \nu'' = 1 - n,$$

we have here

$$\lambda' + \mu' + \nu' > -n.$$

CLASS 3. The two everywhere fundamental branches are

$$\begin{aligned} x^{\lambda'}(x-1)^{\nu'} G'(x), \\ x^{\lambda''}(x-1)^{\nu''} G''(x), \end{aligned}$$

where the degrees of  $G'(x)$ ,  $G''(x)$  are  $-(\lambda' + \mu' + \nu')$ ,  $-(\lambda'' + \mu'' + \nu'')$ , respectively. We have here

$$0 \geq \lambda' + \mu' + \nu' < -n.$$

Type III.  $\lambda' + \mu' + \nu'$ ,  $\lambda'' + \mu' + \nu'$  are integers;  $\lambda' - \lambda''$  is a positive integer or zero.

CLASS 1. The everywhere fundamental branch is

$$x^{\lambda'}(x-1)^{\nu'} G(x).$$

$G(x)$  is of degree  $-(\lambda' + \mu' + \nu')$ . We have here

$$\lambda' + \mu' + \nu' \leq 0.$$

CLASS 2. The everywhere fundamental branch is

$$x^{\lambda'}(x-1)^{\nu''} G(x).$$

$G(x)$  is of degree  $-(\lambda' + \mu'' + \nu'')$ . We have

$$\lambda' + \mu'' + \nu'' \leq 0,$$

which is equivalent to

$$\lambda' + \mu' + \nu' > \lambda' - \lambda'' - n.$$



CLASS 3. The two everywhere fundamental branches are

$$\begin{aligned} x^{\lambda''} (x-1)^{\nu'} G'(x), \\ x^{\lambda''} (x-1)^{\nu''} G''(x); \end{aligned}$$

for this notation obviously includes the cases where the exponent of either branch at the point 0 is  $\lambda'$ , when  $G'(x)$ , or  $G''(x)$ , has a factor  $x^{\lambda'-\lambda''}$ . A similar remark applies in the first four classes of Type IV. The degrees of  $G'(x)$  and  $G''(x)$  are  $-(\lambda'' + \mu' + \nu')$  and  $-(\lambda'' + \mu'' + \nu'')$  respectively. We have here

$$\lambda'' + \mu' + \nu' \leq 0, \quad \lambda'' + \mu'' + \nu'' \leq 0.$$

These two conditions are equivalent to

$$\lambda' - \lambda'' \geq \lambda' + \mu' + \nu' > -n.$$

Type IV. All exponent sums  $\lambda + \mu + \nu$  are integers.  $\lambda' - \lambda''$ ,  $\mu' - \mu''$ ,  $\nu' - \nu''$  are all positive integers or zero, so that we have always

$$\lambda' + \mu' + \nu' > -\frac{n}{2}.$$

CLASS 1. The everywhere fundamental branch is

$$x^{\lambda''} (x-1)^{\nu'} G(x),$$

where  $G(x)$  is of degree  $-(\lambda'' + \mu' + \nu')$ . We have

$$\lambda'' + \mu' + \nu' \leq 0,$$

which is equivalent to

$$\lambda' - \lambda'' \geq \lambda' + \mu' + \nu'.$$

This carries as a necessary consequence the relation

$$\lambda' + \mu' + \nu' > \mu' - \mu'' + \nu' - \nu'' - n.$$

CLASS 2. The everywhere fundamental branch is

$$x^{\lambda'} (x-1)^{\nu'} G(x),$$

where  $G(x)$  is of degree  $-(\lambda' + \mu'' + \nu')$ . Hence we have

$$\lambda' + \mu'' + \nu' \leq 0,$$

which is equivalent to

$$\mu' - \mu'' \geq \lambda' + \mu' + \nu'.$$

This necessitates the relation

$$\lambda' + \mu' + \nu' > \lambda' - \lambda'' + \nu' - \nu'' - n.$$



CLASS 3. The everywhere fundamental branch is

$$x^{\lambda'}(x-1)^{\nu''}G(x),$$

where  $G(x)$  is of degree  $-(\lambda' + \mu' + \nu'')$ . Hence we have

$$\lambda' + \mu' + \nu'' \leq 0,$$

which is equivalent to

$$\nu' - \nu'' \geq \lambda' + \mu' + \nu'.$$

This necessitates the relation

$$\lambda' + \mu' + \nu' > \lambda' - \lambda'' + \mu' - \mu'' - n.$$

CLASS 4. Every branch is here everywhere fundamental. We have

$$Q^{(\lambda')} = x^{\lambda'}(x-1)^{\nu''}G(x),$$

where  $G(x)$  is of degree  $\leq -(\lambda' + \mu'' + \nu'')$ . Similarly considering  $Q^{(\mu')}$  and  $Q^{(\nu')}$ , we have

$$\lambda' + \mu'' + \nu'' \leq 0, \quad \lambda'' + \mu' + \nu'' \leq 0, \quad \lambda'' + \mu'' + \nu' \leq 0.$$

These conditions are equivalent to

$$\lambda' + \mu' + \nu' > \begin{cases} \lambda' - \lambda'' - n, \\ \mu' - \mu'' - n, \\ \nu' - \nu'' - n. \end{cases}$$

REMAINING CLASSES. The everywhere fundamental branch is

$$x^{\lambda'}(x-1)^{\nu'}G(x),$$

where  $G(x)$  is of degree  $-(\lambda' + \mu' + \nu')$ . Hence we have

$$\lambda' + \mu' + \nu' \leq 0.$$

These necessary conditions we now give in the following condensed form:—

Type II. Class 1.  $\lambda' + \mu' + \nu' \leq 0$ .

“ 2.  $\lambda' + \mu' + \nu' > -n$ .

“ 3.  $0 \geq \lambda' + \mu' + \nu' > -n$ .

Type III. Class 1.  $\lambda' + \mu' + \nu' \leq 0$ .

“ 2.  $\lambda' + \mu' + \nu' > \lambda' - \lambda'' - n$ .

“ 3.  $\lambda' - \lambda'' \geq \lambda' + \mu' + \nu' > -n$ .

Type IV. Class 1.  $\lambda' - \lambda'' \geq \lambda' + \mu' + \nu' (> \mu' - \mu'' + \nu' - \nu'' - n)$ .

“ 2.  $\mu' - \mu'' \geq \lambda' + \mu' + \nu' (> \lambda' - \lambda'' + \nu' - \nu'' - n)$ .

“ 3.  $\nu' - \nu'' \geq \lambda' + \mu' + \nu' (> \lambda' - \lambda'' + \mu' - \mu'' - n)$ .

“ 4.  $\lambda' + \mu' + \nu' > \begin{cases} \lambda' - \lambda'' - n, \\ \mu' - \mu'' - n, \\ \nu' - \nu'' - n. \end{cases}$

Remaining classes.  $\lambda' + \mu' + \nu' \leq 0$ .



## § 2. SUFFICIENT AS WELL AS NECESSARY CONDITIONS.

In the case of  $P$  families (where  $n = 0$ ), the necessary conditions of the preceding section are also sufficient that a family be of the designated class, but this is no longer true when  $n > 0$ . To be sure we can in many cases give sufficient conditions; thus, in Type II, the exponent sums determine the class of a family, if  $\lambda' + \mu' + \nu'$  does not lie between 0 and  $1 - n$  inclusive; in Type III, the same is true, if  $\lambda' + \mu' + \nu'$  does not lie between  $\lambda' - \lambda''$  and  $1 - n$  inclusive; and we might also name cases where the class is determined by the exponent sums in Type IV. The cases where these means for determining the class of a family fail, we may conveniently refer to as the *doubtful cases*. In these doubtful cases we must refer to the differential equation of the family for sufficient conditions for the classes in terms of the constants which define a family, — *i. e.*, the exponents, the apparently singular points, and the accessory parameters.

It will be useful in this connection to obtain a general expression for a basis in Types II, III, IV. Let an everywhere fundamental branch (there must always be at least one for families of these types) be

$$(46) \quad Q' = x^\lambda (x - 1)^\nu G(x),$$

where  $G(x)$  is of degree  $-(\lambda + \mu + \nu)$ . We have

$$D = \begin{vmatrix} Q' & \frac{dQ'}{dx} \\ Q'' & \frac{dQ''}{dx} \end{vmatrix} = x^{\lambda'+\lambda''-1} (x-1)^{\nu'+\nu''-1} \phi(x),$$

where  $\phi(x)$  has the value given by (31). This gives for  $Q''$  the expression

$$(47) \quad Q'' = Q' \left[ \int \frac{D}{[Q']^2} dx + k_1 \right] \\ = x^\lambda (x-1)^\nu G(x) \left[ \int x^{\lambda'+\lambda''-2\lambda-1} (x-1)^{\nu'+\nu''-2\nu-1} \cdot \frac{\phi(x)}{[G(x)]^2} dx + k_1 \right].$$

Types II and III have their classes characterized by the everywhere fundamental branches which have been given in the preceding section for each class. We get a necessary and sufficient condition that a family have an everywhere fundamental branch (46), with exponents  $\lambda, \mu, \nu$ , by substituting (46), the coefficients of  $G(x)$  being undetermined, in the differential equation (38) of the family. In addition to equations determining the coefficients of  $G(x)$ , we shall in this way also obtain a system



of relations between the exponents of the regular and apparently singular points, these points themselves, and the accessory parameters, which will give necessary and sufficient conditions that (46) satisfy (38),—*i. e.* that the family have a branch (46). The necessary and sufficient condition that the family have a second everywhere fundamental branch not a constant multiple of the first can be obtained in the same way, or, having found the coefficients of  $G(x)$ , we may find this condition from the expression (47). We will satisfy ourselves here with merely indicating the plan of attack; in subdivision E we will carry the work through for families of order 1.

The above-indicated method fails in Type IV, since the classes here cannot always be distinguished by means of the everywhere fundamental branches, except Class 4, which is the only one with two such branches linearly independent. But in every class there is an everywhere fundamental branch

$$Q' = x^{\lambda''} (x-1)^{\nu''} G'(x).$$

Remembering that  $\lambda' - \lambda''$ ,  $\mu' - \mu''$ ,  $\nu' - \nu''$  are all integers, we see that the integrand of (47) is here a rational function, so that we obtain  $Q''$  by a mere quadrature of a simple kind. Since  $0, \infty, 1$  are the only regular singular points of our family, it is easy to see that we must have

$$(48) \quad Q'' = x^{\lambda''} (x-1)^{\nu''} G''(x) + Q' [\kappa'' \log x + \kappa' \log (x-1)],$$

where  $G''(x)$  is of degree not greater than  $-(\lambda'' + \mu'' + \nu'')$ , and  $\kappa', \kappa''$  are not functions of  $x$ . These numbers,  $\kappa'$  and  $\kappa''$ , can be used, as we have seen in Part I, B, § 4, to characterize by their ratio each class.<sup>1</sup> Substituting in (38) the form of (48) which characterizes each class, we shall come out with the conditions we desire.

### C. RELATIONS BETWEEN KINDRED $Q$ FUNCTIONS.

#### § 1. GENERAL FORM OF RELATIONS.<sup>2</sup>

We have already noted, in that section, that the relations of Part I, A, § 7, take on a comparatively simple form for families having only regular singular points. We now proceed to examine these relations in detail for hypergeometric families; and we shall here not limit our considerations to families all of whose apparently singular points have zero for one exponent; our remarks apply equally to cases where the exponents of the apparently singular points are any pairs of (unequal) positive integers.

<sup>1</sup> In fact we have so chosen our notation that  $\frac{\kappa''}{\kappa'}$  has precisely the meaning here that it has on page 27 of Part I.

<sup>2</sup> See § 6 of Riemann's paper IV, for his treatment of this subject for the classes of  $P$  families there considered.



We shall find a slight complication of our results possible for families having a semisingular point; accordingly we will at first confine ourselves to families of the classes where a semisingular point is impossible. Here we have  $Q^{(\lambda')} = Q_{a'}$ ,  $Q^{(\lambda'')} = Q_{a''}$ .

Let  $(Q', Q'')$ ,  $(\bar{Q}', \bar{Q}'')$ , denote any pair of corresponding bases of any two kindred  $Q$  families which belong to one of the classes above indicated. Let the two families have the notation schemes

$$Q \begin{pmatrix} \overset{0}{\lambda'} & \overset{\infty}{\mu'} & \overset{1}{\nu'} \\ \lambda'' & \mu'' & \nu'' \end{pmatrix} x \text{ and } \bar{Q} \begin{pmatrix} \overset{0}{\bar{\lambda}'} & \overset{\infty}{\bar{\mu}'} & \overset{1}{\bar{\nu}'} \\ \bar{\lambda}'' & \bar{\mu}'' & \bar{\nu}'' \end{pmatrix} x,$$

and let  $Q$  be of order  $n$ ,  $\bar{Q}$  of order  $\bar{n}$ . Corresponding exponents of the two families (and these are to be the ones similarly situated in the two symbols) differ by integers, since corresponding multipliers must be equal (see Theorem III, Part I, A, § 6). If we designate by  $\lambda + \bar{\lambda}$ , the smaller in real part of the two sums,  $\lambda' + \bar{\lambda}''$  and  $\bar{\lambda}' + \lambda''$ , using a similar notation with the other pairs of exponents, we obtain, by a process so close in details to the work of page 16 of Part I that the result can easily be written at once by comparison with equation (9), the relation: —

$$(48') \quad \begin{vmatrix} Q' & \bar{Q}' \\ Q'' & \bar{Q}'' \end{vmatrix} = x^{\lambda + \bar{\lambda}} (x - 1)^{\nu + \bar{\nu}} \phi(x),$$

$\phi(x)$  being single valued and analytic everywhere except in the point  $\infty$ , where it has a pole of order

$$(49) \quad -(\overline{\lambda + \bar{\lambda}} + \overline{\mu + \bar{\mu}} + \overline{\nu + \bar{\nu}}),$$

and is therefore a polynomial of degree given by (49).

If we write, using the ordinary notation for the absolute value of a number,

$$\begin{aligned} \Delta \lambda &= |(\lambda' - \lambda'') - (\bar{\lambda}' - \bar{\lambda}'')|, \\ \Delta \mu &= |(\mu' - \mu'') - (\bar{\mu}' - \bar{\mu}'')|, \\ \Delta \nu &= |(\nu' - \nu'') - (\bar{\nu}' - \bar{\nu}'')|, \end{aligned}$$

we have the equations

$$\begin{aligned} -(\overline{\lambda + \bar{\lambda}}) &= \frac{\Delta \lambda}{2} - \frac{\lambda' + \lambda'' + \bar{\lambda}' + \bar{\lambda}''}{2}, \\ -(\overline{\mu + \bar{\mu}}) &= \frac{\Delta \mu}{2} - \frac{\mu' + \mu'' + \bar{\mu}' + \bar{\mu}''}{2}, \\ -(\overline{\nu + \bar{\nu}}) &= \frac{\Delta \nu}{2} - \frac{\nu' + \nu'' + \bar{\nu}' + \bar{\nu}''}{2}, \end{aligned}$$

so that the degree of  $\phi(x)$  is

$$(50) \quad \frac{\Delta \lambda + \Delta \mu + \Delta \nu + n + \bar{n}}{2} - 1.$$



Hence if  $Q, \bar{Q}, \bar{\bar{Q}}$  are any three kindred  $Q$  functions with regular singular points  $0, \infty, 1$ , none of which are semisingular, relation (10) is, for these functions,

$$(51) \quad Q \Phi(x) + \bar{Q} \bar{\Phi}(x) + \bar{\bar{Q}} \bar{\bar{\Phi}}(x) = 0,$$

where, after all common factors are divided out,  $\Phi(x), \bar{\Phi}(x), \bar{\bar{\Phi}}(x)$ , are polynomials of degrees not higher than the numbers given by formulæ analogous to (50).

In classes where semisingular points occur, every basis is fundamental at such a point, so that although two kindred families have the same connecting formulæ, it is possible in some cases that they may have no common connecting formula in which the fundamental bases have exponents  $\lambda', \lambda; \mu', \mu''; \nu', \nu''$ ; respectively. The only new possibility here is that in such a case we must substitute in (48) and (49), if  $a$  is semisingular,  $\lambda'' + \bar{\lambda}''$  for  $\lambda + \bar{\lambda}$ , and similarly if other points are semisingular. This merely increases the number given by (49) and (50) by an integer. The form of (51) is unchanged in that the coefficients are still polynomials, but the degrees of one or more of these polynomials may be larger than the limit (50) would give. But even this exception to the general rule can occur only in a comparatively limited range of cases under the classes where semisingular points enter, namely, where two of the three families to which the functions in (51) belong have no common connecting formula in which bases having exponents  $\lambda', \lambda'', \mu', \mu'', \nu', \nu''$  enter.

## § 2. EXPRESSION OF $Q$ FUNCTIONS IN TERMS OF KINDRED $P$ FUNCTIONS.

We may apply the results of the preceding section in many ways. Thus, the differential equations (38) and (39) are special cases of relation (51): Again, Riemann, in his paper, "Ueber die Fläche vom kleinsten Inhalt, etc.,"<sup>1</sup> has given a formula connecting a special  $Q$  function of order 2 with a kindred  $P$  function and its derivative. But an especially important application is the expression of  $Q$  functions in terms of  $P$  functions and rational functions only. We shall find that no  $P$  family can be of Class 3 of Type I, and that the classes of Type IV, other than 1, 2, 3, 4, are likewise impossible for  $P$  families, but that in all other classes there are  $P$  families kindred to any  $Q$  families of those classes. From (51) we have the theorem: *A  $Q$  function whose family belongs to the classes possible for  $P$  families is expressible as a sum of terms each consisting of a kindred  $P$  function multiplied by a rational function of the independent variable.* (51) would, of course, give directly but two such terms, but each of these is expressible in terms of other  $P$  functions by means of similar formulæ.

We may note that in the cases where this representation fails, the families are composed of elementary functions. Thus in Type I, Class 3, the family is

<sup>1</sup> Werke, p. 324.



$$c_1 x^{\lambda'} (x-1)^{\nu'} G'(x) + c_2 x^{\lambda''} (x-1)^{\nu''} G''(x);$$

in the classes of Type IV, other than 1, 2, 3, 4, the family is

$$c_1 x^{\lambda'} (x-1)^{\nu'} G'(x) + c_2 \{x^{\lambda''} (x-1)^{\nu''} G''(x) + x^{\lambda'} (x-1)^{\nu'} G'(x) [\kappa'' \log x + \kappa' \log (x-1)]\};$$

where, in both cases,  $G'(x)$ ,  $G''(x)$ , are polynomials, while  $\kappa''$  and  $\kappa'$  are non-vanishing constants.<sup>1</sup> It is a familiar fact that  $P$  functions are expressible in terms of elementary functions and hypergeometric series, so that we have established the result mentioned in the footnote to page 32: *All members of hypergeometric families are expressible in terms of elementary functions and hypergeometric series.*

The question naturally arises as to how simply a  $Q$  function can be expressed in terms of  $P$  functions. Thus Klein,<sup>2</sup> after showing that we can form a  $Q$  function of any order  $\kappa$  by taking a linear combination of suitable  $P$  functions, says: "Um eine  $Q$  Function in allgemeinsten Weise zu bilden, bei der  $\kappa$  irgend einen vorgeschriebenen Wert hat, muss ich  $\kappa - 1$  verwandte  $P$  Functionen . . . mit Hilfe constanter Coefficienten linear zusammensetzen." Whether this means that every  $Q$  function of order  $\kappa$  is so expressible is not clear. We must certainly except functions belonging to classes impossible for  $P$  families. From relation (50) we have no clue to this result; as we proceed step by step from a  $Q$  function to its expression in terms of the  $P$  functions indicated, the degrees of the coefficients would seem to increase, but common factors may, of course, occur. Looking at the question from another point of view, we have at our disposal the  $\kappa$  ratios of the undetermined coefficients of the expression Klein mentions, with which we may hope to form a  $Q$  function with the desired apparently singular points; but can we also so determine the  $Q$  function we have formed that it will have any of the possible sets of accessory parameters? This question the writer has not been able to answer, in general; in the case of  $Q$  functions of order 1, we shall see that, with the exceptions noted, the answer to the above question is affirmative.

#### D. $P$ FAMILIES.

We are now in a position to develop the properties of  $P$  families as a corollary of the more general results of the preceding sections. Riemann, in his celebrated paper, confined himself to the case where the difference of no exponent pair is an integer; we shall here be able to extend his results to all cases.

<sup>1</sup> In a footnote on pages 30 and 31 of Ritter's paper (Math. Ann., Vol. 48, 1896), Schilling has shown how we may pass from a  $Q$  function expressed in terms of  $P$  functions of Type I, Class 2, to a  $Q$  function of Class 3, all of order 1, by allowing coefficients to approach certain limits, and it seems likely that this process can be used in other cases.

<sup>2</sup> Page 229.



§ 1. CRITERIA FOR EACH CLASS OF  $P$  FAMILIES.

Riemann's definition of a  $P$  function includes Type II as well as part of Type I, but he seems to have overlooked the former in discussing the group. Miss Winston,<sup>1</sup> following out a suggestion of Klein's,<sup>2</sup> first supplied this deficiency by noting from the development in series of the fundamental branches the difference between families of Classes 1 and 2 of Type II. Ritter<sup>3</sup> and Schilling<sup>4</sup> have since obtained essentially the criteria which follow for all classes, the latter by geometrical methods, the former analytically, but starting from an artificial definition of kindred functions which he has not shown to be equivalent to the requirement that they have the same group. Our method has its chief claim to interest from the fact that it is a natural extension of Riemann's.

The criteria for the types are given on page 41. For the classes under them the necessary relations of page 44, when we put  $n = 0$ , become:

- Type II. Class 1.  $\lambda' + \mu' + \nu' \leq 0$ .
- " 2.  $\lambda' + \mu' + \nu' > 0$ .
- " 3. Impossible.
- Type III. Class 1.  $\lambda' + \mu' + \nu' \leq 0$ .
- " 2.  $\lambda' + \mu' + \nu' > \lambda' - \lambda''$ .
- " 3.  $\lambda' - \lambda'' \geq \lambda' + \mu' + \nu' > 0$ .
- Type IV. Class 1.  $\lambda' - \lambda'' \geq \lambda' + \mu' + \nu' (> \mu' - \mu'' + \nu' - \nu'')$ .
- " 2.  $\mu' - \mu'' \geq \lambda' + \mu' + \nu' (> \lambda' - \lambda'' + \nu' - \nu'')$ .
- " 3.  $\nu' - \nu'' \geq \lambda' + \mu' + \nu' (> \lambda' - \lambda'' + \mu' - \mu'')$ .
- " 4.  $\lambda' + \mu' + \nu' > \begin{cases} \lambda' - \lambda'', \\ \mu' - \mu'', \\ \nu' - \nu''. \end{cases}$

The necessary relation  $\lambda' + \mu' + \nu' > -\frac{n}{2}$  makes it impossible, in Type IV, that  $\lambda' + \mu' + \nu'$  be equal to or less than zero, so that the remaining classes are impossible.

But these relations include all possible values of  $\lambda' + \mu' + \nu'$ , and in each type they are mutually exclusive. Hence, *the above relations are, for each class of any type, a necessary and sufficient condition that a family of that type belong to that class.*

The point  $a$  is semisingular in Class 3 of Type III, and in Classes 1 and 4 of Type IV, and in no other classes. By combining the criteria for these classes, we obtain a necessary and sufficient condition that  $a$  be semisingular. This condition is: *either  $\lambda' + \mu' + \nu'$  or  $\lambda' + \mu' + \nu''$  is an integer of the sequence 1, 2, . . . ,  $\lambda' - \lambda''$ .*<sup>5</sup>

<sup>1</sup> Math. Ann., Vol. 46, p. 157, 1895.

<sup>2</sup> Pages 413-415.

<sup>3</sup> In § 2 of his paper. Math. Ann., Vol. 48, 1896.

<sup>4</sup> Math. Ann., Vol. 46, p. 538, 1895.

<sup>5</sup> Compare the conditions given in Schwarz's paper, Ueber diejenigen Fälle in welchen die Gaussische hypergeometrische Reihe eine algebraische Function ihres vierten Elementes darstellt. Crelle, Vol. 75, pp. 292-335, 1873.



Since our criteria, both for types and classes, are entirely in terms of the exponents, *P families with the same exponents at the same points are kindred*. So much we conclude from this section; in the next section we show that a *P* family is in fact determined by its exponents.

§ 2. THE *P* FAMILY DETERMINED BY ITS EXPONENTS.

From the differential equation of the *P* family, we could infer that its only parameters are the exponents, but it will be interesting to follow Riemann here. We wish to prove that but one *P* family, with given singular points, can have a given set of exponents.

We shall need here the following lemma, which is true for *P* families but not for all *Q* families:

*If two P families are kindred, they have a common connecting formula (including the associated constants C) in which the fundamental bases have exponents  $\lambda', \lambda''$ ;  $\mu', \mu''$ ;  $\nu', \nu''$ , respectively.*

This follows, as a matter of course, from Theorem III of Part I, A, § 6, when *a, b, c* are none of them semisingular. But when, for instance, *a* is semisingular, every basis is fundamental at *a*, and hence the two branches of a basis may both have exponents  $\lambda''$ . We proceed, therefore, to show the truth of our lemma for each class where semisingular points enter.

Type III, Class 3. We have, from Part I, B, § 4,

$$\begin{aligned} P_a' &= \alpha P_b' = \alpha_1 P_c', \\ P_a'' &= \delta P_b'' = \delta_1 P_c''. \end{aligned}$$

The exponents of  $P_a'$  and  $P_a''$  must both be  $\lambda''$ , since the fact that the sum of the three exponents of an everywhere fundamental branch must be less than or equal to zero is readily seen to bar out any other possibilities. Hence we have

$$\begin{aligned} P^{(\lambda')} &= \alpha P^{(\mu')} + \beta P^{(\mu'')} = \alpha_1 P^{(\nu')} + \beta_1 P^{(\nu'')}, \\ P^{(\lambda'')} &= \delta P^{(\mu')} = \delta_1 P^{(\nu'')}. \end{aligned}$$

Here none of the coefficients can vanish, and in any two families of this class we can take  $\alpha, \beta, \delta$  the same; then if one family has the above formula, any kindred family must have the same formula, since a basis  $(P^{(\lambda')}, P^{(\lambda'')})$  of the first family corresponds to a basis  $(\bar{P}^{(\lambda')}, \bar{P}^{(\lambda'')})$  of the kindred family; for connecting formulæ involving these bases must exist which are the same for the two families; and to complete our proof



we need only observe that  $P_b', P_b''$  have exponents  $\mu'$  and  $\mu''$ , respectively, and  $P_c', P_c''$ , exponents  $\nu', \nu''$ .

Type IV, Class 1. We easily see that the connecting formulæ can always be taken

$$\begin{aligned} P^{(\lambda')} &= \beta P^{(\mu'')} = \beta_1 P^{(\nu')}, \\ P^{(\lambda'')} &= \gamma P^{(\mu')} = \gamma_1 P^{(\nu)}. \end{aligned}$$

Having chosen  $P^{(\mu')}$  and  $P^{(\mu'')}$ , so that  $C_b$  has any preassigned value  $\neq 0$ , we may, by our choice of  $P^{(\lambda')}, P^{(\lambda'')}$ , give  $\beta$  and  $\gamma$  any values we please  $\neq 0$ . We complete our proof here as for Class 3 of Type III. Classes 2 and 3 may be discussed in the same way.

Type IV, Class 4. We have

$$\begin{aligned} P_a' &= a P_b' = a_1 P_c', \\ P_a'' &= \delta P_b'' = \delta_1 P_c''. \end{aligned}$$

Every basis is here fundamental at every hole. Taking  $P_a'$  and  $P_a''$  as  $P^{(\lambda')}$  and  $P^{(\lambda'')}$ , respectively, we may easily assure ourselves that the only possible exponents for  $P_b', P_c'$ , are  $\mu'', \nu''$ , and that we have always a formula

$$\begin{aligned} P^{(\lambda')} &= \beta P^{(\mu'')} = \beta_1 P^{(\nu')}, \\ P^{(\lambda'')} &= \gamma P^{(\mu')} = \gamma_1 P^{(\nu')} + \delta_1 P^{(\nu'')}, \end{aligned}$$

where none of the coefficients vanish, but are otherwise arbitrary.

The proof of our lemma being thus completed, we now proceed to the proof of the theorem:

*Only one P family with given singular points can have a given set of exponents.*

Take the given singular points at 0,  $\infty$ , 1 by means of transformation (26) and let the given set of exponents be  $\lambda', \lambda'', \mu', \mu'', \nu', \nu''$  for a family  $P$ . Let  $(P^{(\lambda')}, P^{(\lambda'')})$ ,  $(P^{(\mu')}, P^{(\mu'')})$ ,  $(P^{(\nu')}, P^{(\nu'')})$  be fundamental bases of this family, with the exponents indicated, and suppose we are given a connecting formula in which all of them enter. Then by our lemma, since families with the same exponents and singular points are always kindred (see preceding section), a second family  $\bar{P}$  with the same exponents and singular points must have the same connecting formula in terms of corresponding bases  $(\bar{P}^{(\lambda')}, \bar{P}^{(\lambda'')})$ ,  $(\bar{P}^{(\mu')}, \bar{P}^{(\mu'')})$ ,  $(\bar{P}^{(\nu')}, \bar{P}^{(\nu'')})$ . This is the point on which Riemann's work rests; his proof may now be easily applied to our more general problem. In fact we have only to follow the work of Part I, A, § 7, to see that here, as well as in the case Riemann considers, the determinant

$$\begin{vmatrix} P^{(\lambda')} & \bar{P}^{(\lambda')} \\ P^{(\lambda'')} & \bar{P}^{(\lambda'')} \end{vmatrix}$$

is equal to the function

$$x^{\lambda'+\lambda''} (x-1)^{\nu'+\nu''} \bar{\phi}(x),$$



where  $\bar{\phi}(x)$  is everywhere on the sphere a single valued analytic function, and hence is a constant. Further, since the exponent at  $\infty$  of  $\bar{\phi}(x)$  is

$$\lambda' + \lambda'' + \mu' + \mu'' + \nu' + \nu'' = 1,$$

$\bar{\phi}(x)$  vanishes at  $\infty$ , and therefore is identically zero. From this result, and the common connecting formula of the two families, we deduce, with Riemann, the equations

$$(52) \quad \frac{\bar{P}^{(\lambda')}}{P^{(\lambda')}} = \frac{\bar{P}^{(\lambda'')}}{P^{(\lambda'')}} = \frac{\bar{P}^{(\mu')}}{P^{(\mu')}} = \frac{\bar{P}^{(\nu')}}{P^{(\nu')}}.$$

Now  $\frac{\bar{P}^{(\lambda')}}{P^{(\lambda')}}$  is clearly single valued in the neighborhood of the point 0, and similarly for  $\frac{\bar{P}^{(\mu')}}{P^{(\mu')}}$ ,  $\frac{\bar{P}^{(\nu')}}{P^{(\nu')}}$ , in the neighborhood of  $\infty$ , 1, respectively. Hence from equations (52) we see that  $\frac{\bar{P}^{(\lambda')}}{P^{(\lambda')}}$  is single valued and analytic on the entire sphere, provided that  $P^{(\lambda')}$  and  $P^{(\lambda'')}$  do not both vanish at any point other than 0,  $\infty$ , 1. To prove that this is the case, we need only remember that the functional determinant

$$D = \begin{vmatrix} P^{(\lambda')} & \frac{d P^{(\lambda')}}{d x} \\ P^{(\lambda'')} & \frac{d P^{(\lambda'')}}{d x} \end{vmatrix}$$

is equal to  $x^{\lambda'+\lambda''-1} (x-1)^{\nu'+\nu''-1} \phi(x)$  (see page 34),  $\phi(x)$  being for  $P$  families a constant, and as observed in the footnote to page 34,  $\phi(x) \neq 0$ . From this it is obvious that  $P^{(\lambda')}$ ,  $P^{(\lambda'')}$  cannot vanish together in any point other than 0,  $\infty$ , 1.

It is evident, therefore, that  $\frac{\bar{P}^{(\lambda')}}{P^{(\lambda')}} = \frac{\bar{P}^{(\lambda'')}}{P^{(\lambda'')}}$ , being single valued and analytic over the entire sphere, must be a constant. In consequence, the families

$$c_1 P^{(\lambda')} + c_2 P^{(\lambda'')} \text{ and } \bar{c}_1 \bar{P}^{(\lambda')} + \bar{c}_2 \bar{P}^{(\lambda'')},$$

must be identical, and this establishes our theorem.

Note that this proof fails for  $Q$  families of order  $> 0$ ; in fact the theorem itself is not true.

### § 3. RELATIONS BETWEEN KINDRED $P$ FUNCTIONS.

We may take our formulæ here bodily from Part II, C, § 1. We have

$$\begin{vmatrix} P^I & \bar{P}^I \\ P^{II} & \bar{P}^{II} \end{vmatrix} = x^{\lambda+\lambda'} (x-1)^{\nu+\nu'} \phi(x),$$



and here  $\phi(x)$  is always of degree

$$\frac{\Delta \lambda + \Delta \mu + \Delta \nu}{2} - 1,$$

on account of the lemma of the preceding section. Formula (51) we can use with merely a change of notation.

#### § 4. THE DIFFERENTIAL EQUATION.

The differential equation of a  $P$  family is easily written down from the more general equations of Part II, A, § 3. Putting  $n = 0$ , we have from (39), if the regular singular points of our family are  $0, \infty, 1$ ,

$$\frac{d^2 P}{dx^2} + \left[ \frac{1 - \lambda' - \lambda''}{x} + \frac{1 - \nu' - \nu''}{x - 1} \right] \frac{dP}{dx} + \left[ -\frac{\lambda' \lambda''}{x} + \mu' \mu'' + \frac{\nu' \nu''}{x - 1} \right] \frac{P}{x(x - 1)} = 0;$$

and from (44) we obtain for the case where the singular points are  $a, b, c$  the equation first given by Papperitz,<sup>1</sup>

$$(53) \quad \frac{d^2 P}{dx^2} + \left[ \frac{1 - \lambda' - \lambda''}{x - a} + \frac{1 - \mu' - \mu''}{x - b} + \frac{1 - \nu' - \nu''}{x - c} \right] \frac{dP}{dx} \\ + \left[ \frac{\lambda' \lambda'' (a - b)(a - c)}{x - a} + \frac{\mu' \mu'' (b - a)(b - c)}{x - b} + \frac{\nu' \nu'' (c - a)(c - b)}{x - c} \right] \frac{P}{(x - a)(x - b)(x - c)} = 0.$$

The differential equation (53) affords an existence proof for a  $P$  family with any three singular points and any exponents whose sum is 1. It therefore gives an existence proof for all the classes we have characterized in terms of the exponents on page 50.

#### E. $Q$ FAMILIES OF ORDER 1.

##### § 1. THE DIFFERENTIAL EQUATION. THE FAMILIES $Q$ AND $\bar{Q}$ .

In the first three sections of the paper of Ritter which we have so often cited, are given a discussion of the differential equation of the general  $Q$  family of order 1, applications to a classification of  $P$  families according to their groups, and an example of the expression of a  $Q$  function linearly in terms of  $P$  functions. For many points of interest the reader may refer to that paper; here we shall only treat the problem of classifying  $Q$  families of order 1, and add a few remarks about the expression of  $Q$  functions of order 1 in terms of  $P$  functions. For our purposes, it is sufficient to take the regular singular points at  $0, \infty, 1$ . The apparently singular point  $s$  (which must be simple) is not to coincide with any of these.

<sup>1</sup> Math. Ann., Vol. 25, 1885.



The differential equation may be read off directly from (39); it is

$$(54) \quad \frac{d^2 Q}{dx^2} + \left[ \frac{1 - \lambda' - \lambda''}{x} + \frac{1 - \nu' - \nu''}{x-1} - \frac{1}{x-s} \right] \frac{dQ}{dx} + \left[ -\frac{\lambda' \lambda''}{x} + \mu' \mu'' + \frac{\nu' \nu''}{x-1} + \frac{A}{x-s} \right] \frac{Q}{x(x-1)} = 0,$$

and is thus given on page 6 of Ritter's paper. From (41) we see that  $A$  must be a solution of the equation,

$$(55) \quad A^2 - A s(s-1) \left( \frac{\lambda' + \lambda''}{s} + \frac{\nu' + \nu''}{s-1} \right) + s(s-1) \left( -\frac{\lambda' \lambda''}{s} + \mu' \mu'' + \frac{\nu' \nu''}{s-1} \right) = 0.$$

If  $Q$  denotes a family which satisfies (54), having one of the solutions,  $A_1$ , of (55) for its accessory parameter, the results noted in sections 2 and 3 of Part II, A, show us that the family

$$(56) \quad \bar{Q} = x^\delta (x-1)^\epsilon Q,$$

consists of the solutions of the differential equation

$$(57) \quad \frac{d^2 \bar{Q}}{dx^2} + \left[ \frac{1 - \lambda' - \lambda'' - 2\delta}{x} + \frac{1 - \nu' - \nu'' - 2\epsilon}{x-1} - \frac{1}{x-s} \right] \frac{d\bar{Q}}{dx} + \left[ -\frac{(\lambda' + \delta)(\lambda'' + \delta)}{x} + (\mu' - \delta - \epsilon)(\mu'' - \delta - \epsilon) + \frac{(\nu' + \epsilon)(\nu'' + \epsilon)}{x-1} + \frac{A_1 + \delta(s-1) + \epsilon s}{x-s} \right] \frac{\bar{Q}}{x(x-1)} = 0.$$

We shall find this result of considerable use in the problem of characterizing our classification of  $Q$  families of order 1.

## § 2. CLASSIFICATION CRITERIA IN THE DOUBTFUL CASES.

In § 2 of Part II, B, we have seen that the relations in terms of the exponents alone, there given, completely determine the class of a family except in cases which we have termed *doubtful*. These we now investigate.

Type I. No doubtful case, as there is only one class.

Type II. The only doubtful cases are for families whose exponents satisfy the relation  $\lambda' + \mu' + \nu' = 0$ . In this case the fact that the exponent sum  $\lambda' + \lambda'' + \mu' + \mu'' + \nu' + \nu''$  is zero gives us also  $\lambda'' + \mu'' + \nu'' = 0$ . For these cases we will deduce relations between the parameters of the family which we first show to be necessary for each class, and then to be sufficient.

The two roots of (55) will be found to be  $-\lambda' - \mu' s$  and  $-\lambda'' - \mu'' s$  in these doubtful cases.

CLASS 1. One member of the family must be  $k x^{\lambda'} (x-1)^{\nu'}$ , where  $k$  is a constant. (See page 42. The degree of  $G(x)$  is  $-(\lambda' + \mu' + \nu')$ , which is here zero. Similarly refer to the work of pages 42-44 throughout the rest of this section.)



Hence if we put  $\delta = -\lambda'$ ,  $\epsilon = -\nu'$ , a constant must satisfy (57). This gives the condition, necessary and sufficient, that  $kx^{\lambda'}(x-1)^{\nu'}$  be a member of the family,

$$(58) \quad A = \lambda'(s-1) + \nu's = -\lambda' - \mu's.$$

CLASS 2. Proceeding similarly, we see that a necessary and sufficient condition that  $kx^{\lambda''}(x-1)^{\nu''}$  be a member of the family is

$$(59) \quad A = \lambda''(s-1) + \nu''s = -\lambda'' - \mu''s.$$

CLASS 3. Here  $A$  must have both values (58) and (59) since both  $kx^{\lambda'}(x-1)^{\nu'}$  and  $kx^{\lambda''}(x-1)^{\nu''}$  are members of the family. A necessary result is

$$(60) \quad s = -\frac{\lambda' - \lambda''}{\mu' - \mu''}.$$

But if (60) is satisfied, our family must be of Class 3; for the only solutions of (55) in the doubtful cases are, as we have noted, either (58) or (59); but (60) combined with either gives the other, so that if (60) is satisfied, our family must in fact have two members  $kx^{\lambda'}(x-1)^{\nu'}$  and  $kx^{\lambda''}(x-1)^{\nu''}$ , and must therefore be of Class 3.

From the foregoing we easily see that the following relations are necessary and sufficient, for each class, that a family under the doubtful cases belong to the class designated:

$$\begin{aligned} \text{Class 1. } & A = -\lambda' - \mu's, \quad s \neq -\frac{\lambda' - \lambda''}{\mu' - \mu''}. \\ \text{" 2. } & A = -\lambda'' - \mu''s, \quad s \neq -\frac{\lambda' - \lambda''}{\mu' - \mu''}. \\ \text{" 3. } & s = -\frac{\lambda' - \lambda''}{\mu' - \mu''}. \end{aligned}$$

Type III. The doubtful cases here belong under two headings characterized by the relations  $\lambda' + \mu' + \nu' = 0$ , and  $\lambda' + \mu' + \nu' = \lambda' - \lambda''$ , respectively.

When  $\lambda' + \mu' + \nu' = 0$ , the two roots of (55) are  $-\lambda' - \mu's$  and  $-\lambda'' - \mu''s$ . As noted in the discussion for Type II, the relation  $A = -\lambda' - \mu's$  is a necessary and sufficient condition that  $kx^{\lambda'}(x-1)^{\nu'}$  be a member of the family, and  $A = -\lambda'' - \mu''s$  is a necessary and sufficient condition that  $kx^{\lambda''}(x-1)^{\nu''}$  be a member of the family. These two are, then, the only possible everywhere fundamental branches; if a family is of Class 1, it has the former branch; if of Class 2, the latter; if of Class 3, the latter. The necessary and sufficient conditions for each class are:

$$\begin{aligned} \text{Class 1. } & A = -\lambda' - \mu's, \quad s \neq -\frac{\lambda' - \lambda''}{\mu' - \mu''}. \\ \text{" 2. } & A = -\lambda'' - \mu''s, \quad \lambda' = \lambda''. \\ \text{" 3. } & A = -\lambda'' - \mu''s, \quad \lambda' \neq \lambda''. \end{aligned}$$

Since  $s \neq 0, \infty, 1$ , we omit for Class 2 the condition  $s \neq -\frac{\lambda' - \lambda''}{\mu' - \mu''}$ . Similarly hereafter.



If  $\lambda' + \mu' + \nu' = \lambda' - \lambda''$ , *i. e.*,  $\lambda'' + \mu' + \nu' = 0$ , the two roots of (55) are  $-\lambda'' - \mu' s$  and  $-\lambda' - \mu'' s$ . For a given family here,  $A = -\lambda'' - \mu' s$  is necessary and sufficient that  $k x^{\lambda''} (x-1)^{\nu'}$  be a member, while  $A = -\lambda' - \mu'' s$  is necessary and sufficient that  $k x^{\lambda'} (x-1)^{\nu''}$  be a member. Of these two, which are the only possible everywhere fundamental branches, families of Class 1 have the former, those of Class 2 the latter, and those of Class 3 the former. We may, then, characterize the classes as follows:

$$\begin{aligned} \text{Class 1. } & A = -\lambda'' - \mu' s, \quad \lambda' = \lambda''. \\ \text{" 2. } & A = -\lambda' - \mu'' s, \quad s \neq \frac{\lambda' - \lambda''}{\mu' - \mu''}. \\ \text{" 3. } & A = -\lambda'' - \mu' s, \quad \lambda' \neq \lambda''. \end{aligned}$$

Type IV. The doubtful cases come under four heads, namely: (a)  $\lambda' + \mu' + \nu' = 0$ , (b)  $\lambda' + \mu' + \nu' = \lambda' - \lambda'' \neq 0$ , (c)  $\lambda' + \mu' + \nu' = \mu' - \mu'' \neq 0$ , (d)  $\lambda' + \mu' + \nu' = \nu' - \nu'' \neq 0$ . These we take up in order.

(a)  $\lambda' + \mu' + \nu' = 0$ . Here  $\lambda'' + \mu'' + \nu'' = 0$ , and since  $\lambda' - \lambda''$ ,  $\mu' - \mu''$ ,  $\nu' - \nu''$  are positive integers or zero, they must in this case all be zero. The three regular singular points are each logarithmic, so that we have to do here with only the classes other than 1, 2, 3, 4; and only when  $\lambda'' + \mu' + \nu' = 0$  is such a class possible. We have fundamental branches

$$\begin{aligned} & x^{\lambda'} (x-1)^{\nu'}, \\ & x^{\lambda'} (x-1)^{\nu'} [\kappa'' \log x + \kappa' \log (x-1)], \end{aligned}$$

(see page 46), where  $\kappa' \neq 0$ ,  $\kappa'' \neq 0$ , and  $\kappa' + \kappa'' \neq 0$ . Each class here is characterized by the ratio  $\frac{\kappa''}{\kappa'}$ . This ratio we can find in terms of  $s$  by substituting branches 1 and  $\kappa'' \log x + \kappa' \log (x-1)$  in the functional determinant of the family  $x^{-\lambda'} (x-1)^{-\nu'} Q$ , thus obtaining the identity

$$\begin{vmatrix} 1 & 0 \\ \kappa'' \log x + \kappa' \log (x-1) & \frac{\kappa''}{x} + \frac{\kappa'}{x-1} \end{vmatrix} \equiv k x^{\lambda'+\lambda''-2\lambda'-1} (x-1)^{\nu'+\nu''-2\nu'-1} (x-s) \equiv k \frac{x-s}{x(x-1)}.$$

Hence we have

$$\frac{\kappa''}{\kappa'} = -\frac{s}{s-1}.$$

*Each value of  $s$  (other than 0, 1,  $\infty$ ) gives a class.* For all these classes the accessory parameter  $A$  has the value  $-\lambda' - \mu' s$ . We see here that *classes actually exist corresponding to every value of  $\frac{\kappa''}{\kappa'}$ .*



(b) If  $\lambda' + \mu' + \nu' = \lambda' - \lambda'' \neq 0$ , *i. e.*,  $\lambda'' + \mu' + \nu' = 0$ ,  $\lambda' + \mu' + \nu' \neq 0$ , the two roots of (55) are  $-\lambda'' - \mu' s$  and  $-\lambda' - \mu'' s$ . We hardly need give here the details of a discussion which will be so similar to that given for Type III. The criteria are:

- Class 1.  $A = -\lambda'' - \mu' s$ ,  $s \neq \frac{\lambda' - \lambda''}{\mu' - \mu''}$ .  
 “ 2.  $A = -\lambda' - \mu'' s$ ,  $\mu' \neq \mu''$ ,  $\nu' = \nu''$ .  
 “ 3.  $A = -\lambda' - \mu'' s$ ,  $\mu' = \mu''$ ,  $\nu' \neq \nu''$ .  
 “ 4.  $A = -\lambda' - \mu'' s$ ,  $\mu' \neq \mu''$ ,  $\nu' \neq \nu''$ .

No other classes possible.

(c)  $\lambda' + \mu' + \nu' = \mu' - \mu'' \neq 0$ . The two roots of (55) are  $-\lambda'' - \mu' s$  and  $-\lambda' - \mu'' s$ . The criteria are:

- Class 1.  $A = -\lambda'' - \mu' s$ ,  $\lambda' \neq \lambda''$ ,  $\nu' = \nu''$ .  
 “ 2.  $A = -\lambda' - \mu'' s$ ,  $s \neq \frac{\lambda' - \lambda''}{\mu' - \mu''}$ .  
 “ 3.  $A = -\lambda'' - \mu' s$ ,  $\lambda' = \lambda''$ ,  $\nu' \neq \nu''$ .  
 “ 4.  $A = -\lambda'' - \mu' s$ ,  $\lambda' \neq \lambda''$ ,  $\nu' \neq \nu''$ .

(d)  $\lambda' + \mu' + \nu' = \nu' - \nu'' \neq 0$ . The two roots of (55) are  $-\lambda' - \mu' s$  and  $-\lambda'' - \mu'' s$ . The criteria are:

- Class 1.  $A = -\lambda'' - \mu'' s$ ,  $\lambda' \neq \lambda''$ ,  $\mu' = \mu''$ .  
 “ 2.  $A = -\lambda'' - \mu'' s$ ,  $\lambda' = \lambda''$ ,  $\mu' \neq \mu''$ .  
 “ 3.  $A = -\lambda' - \mu' s$ ,  $s \neq -\frac{\lambda' - \lambda''}{\mu' - \mu''}$ .  
 “ 4.  $A = -\lambda'' - \mu'' s$ ,  $\lambda' \neq \lambda''$ ,  $\mu' \neq \mu''$ .

### § 3. EXPRESSION OF A $Q$ FUNCTION OF ORDER 1 AS A SUM OF TWO KINDRED $P$ FUNCTIONS.

The exponent scheme of a  $Q$  family of order 1 being

$$(61) \quad Q \begin{pmatrix} 0 & \infty & 1 \\ \lambda' & \mu' & \nu' \\ \lambda'' & \mu'' & \nu'' x \end{pmatrix},$$

Ritter states that a function belonging to this family is in general expressible linearly in terms of two kindred  $P$  functions chosen from one of the following triples of  $P$  families: In the first triple, the three families have the same notation scheme for the exponents as  $Q$ , except that the first family has  $\lambda' + 1$  in place of  $\lambda'$ , the second  $\mu' + 1$  in place of  $\mu'$ , and the third  $\nu' + 1$  in place of  $\nu'$ ; in the second triple, there are similar changes in the second row of exponents in (61). This representation he does not



prove to hold for all cases, but merely gives an example for a family all of whose points are ordinary. Our formulæ of Part II, C, show that this expression is valid, provided (1) that we can choose two such  $P$  families kindred to  $Q$ , and (2) that the two  $P$  families chosen, and  $Q$ , have a common connecting formula (including the associated constants  $C$ ) in which no two members of any basis have the same exponent (except in the case of equal exponents). The reason for this last condition is obvious from the remarks of page 48.

The first condition is violated by  $Q$  functions of Type II, Class 3, and of the classes of Type IV other than 1, 2, 3, 4, since  $P$  families cannot belong to those classes. Both conditions are always satisfied for Type I; and an inspection of each class for which  $P$  families are possible under Types II, III, IV will show that the first condition can always be satisfied for a  $Q$  family of any of those classes. Formula (50) shows that the degrees of the coefficients in (51) taken for functions of the  $Q$  family and two kindred  $P$  families chosen as above indicated, must be zero, provided the second condition above is satisfied. The reader may assure himself by an examination of each class that this second condition is also satisfied except in the *doubtful cases* noted in the preceding section; and that here the only violation is in Class 3 of Type III, and Class 4 of Type IV, when the two values of  $A$  coincide, the family being then completely determined by its exponent scheme and apparently singular point. Here the formulæ of Part II, C, fail to give the desired representation, which nevertheless exists. In fact if  $P'$  and  $P''$  be two functions chosen as above indicated, it is easy to show that constants  $\alpha$  and  $\beta$  always exist such that the function

$$Q = \alpha P' + \beta P'',$$

which evidently has the desired exponent scheme, has also the characteristic apparently singular point.

*A  $Q$  function of order 1 of any class possible for  $P$  families can always be expressed linearly in terms of kindred  $P$  functions.*

We have thus illustrated some of the difficulties that arise in a first generalization from  $P$  families. Our methods are sufficient for the discussion of further cases, but conditions become so complicated that a similar treatment of  $Q$  families of order 2, or of higher order, will not be attempted here.



# PUBLICATIONS

OF THE

## AMERICAN ACADEMY OF ARTS AND SCIENCES.

---

MEMOIRS. OLD SERIES, Vols. I.-IV.; NEW SERIES, Vols. I.-XII.  
 16 volumes, \$10 each. Half volumes, \$5 each. 25% discount  
 to booksellers; 50% to members.

Vol. X.	Part II. <i>bis</i> . . . . .	\$1.75
" XI.	" I. . . . .	2.00
" XI.	" II. No. I. . . . .	3.00
" XI.	" III. " II.-III. . . . .	1.00
" XI.	" IV. " IV. . . . .	1.00
" XI.	" IV. " V. . . . .	.75
" XI.	" V. " VI. . . . .	.25
" XI.	" VI. " VII. . . . .	2.00
" XII.	No. I. . . . .	1.50
" XII.	" II. . . . .	2.00
" XII.	" III. . . . .	6.00
" XII.	" IV. . . . .	1.25
" XII.	" V. . . . .	2.50

PROCEEDINGS. Vols. I.-XXXVIII., \$5 each. 25% discount to  
 booksellers; 50% discount to members.

The individual articles may be obtained separately. A price list of recent  
 articles is printed on the third page of this cover.

---

Complete sets of the MEMOIRS, 16 vols., for \$112.50, to members, \$60;  
 of the PROCEEDINGS, 38 vols. for \$145, to members, \$78.

---

Complete Works of Count Rumford. 4 vols., \$5.00 each.  
 Memoir of Sir Benjamin Thompson, Count Rumford, with Notices of  
 his Daughter. By George E. Ellis. \$5.00.

---

Complete sets of the Life and Works of Rumford. 5 vols., \$25.00;  
 to members, \$5.00.

---

For sale at the Library of THE AMERICAN ACADEMY OF ARTS AND  
 SCIENCES, Corner of Boylston Street (No. 1154) and The Fenway,  
 Boston, Massachusetts.



MEMOIRS  
OF  
THE AMERICAN ACADEMY  
OF  
ARTS AND SCIENCES



VOL. XIII. — No. II.

CAMBRIDGE:  
JOHN WILSON AND SON.  
University Press.  
NOVEMBER, 1904.



BRYGOS.—HIS CHARACTERISTICS.

BY

OLIVER SAMUEL TONKS.

PRESENTED BY J. H. WRIGHT, JUNE 17, 1903. RECEIVED MARCH 11, 1904.







## CONTENTS.

	PAGES
INTRODUCTION . . . . .	65-66
DISCUSSION OF CHARACTERISTICS THAT HAVE BEEN ASSIGNED TO BRYGOS	66-79
FIVE NEW CHARACTERISTICS . . . . .	79-80
CHARACTERISTICS BELONGING ONLY TO BRYGOS . . . . .	80-81
IDENTIFICATION OF VASES BY BRYGOS . . . . .	81-92
IDENTIFICATION OF GROUPS OF CHARACTERISTICS BELONGING TO BRYGOS	92-95
RELATION OF BRYGOS TO OTHER ARTISTS . . . . .	95-96
CO-PARTNERSHIP WITH OTHER ARTISTS . . . . .	96-97
BRYGOS' SIGNATURE . . . . .	98
NATIVE COUNTRY OF BRYGOS . . . . .	98-100
GROUPS OF CHARACTERISTICS (see pp. 92-95) . . . . .	101
LIST OF VASES . . . . .	101-117



## BRYGOS. — HIS CHARACTERISTICS.<sup>1</sup>

UNTIL within a comparatively few years archaeologists have been content to treat Greek vase paintings from the point of view mainly of mythology. Only the signed vases were recognized as belonging to different artists. Now, however, it has become evident that each artist possesses individual stylistic qualities, by the recognition of which even his unsigned works can be gathered together. Every artist, by dint of long practice and the dexterity resulting therefrom, is bound to develop certain idiosyncrasies that will recur again and again on his works. It is for these peculiarities, these personal touches, that the student of ceramics looks to-day in order to differentiate the works of one artist from those of others of the same period and — one might even say — of the same school.

Hartwig has followed this line of investigation in his *Meisterschalen*, and among the Athenian artists of the red-figured period treated by him is Brygos. Hartwig's results, however, are indefinite; for while one is led to assent to the characteristics pointed out as our author passes from one vase to another, there is a feeling at the conclusion that nothing tangible has been given by which one can identify our artist. To say that such and such a characteristic, as for instance the custom of covering the reclining figures up to the waist with an himation,<sup>2</sup> is very common with Brygos is of little value to a student taking up the study of that artist, if he finds that the same characteristic is as common with other contemporary artists. There must be something peculiar to Brygos, as there is to other artists, by which he can be distinguished from others. If this were not so, the great number of unsigned vases and fragments which, wrongly or rightly, have been classed as his could not have been

<sup>1</sup> A portion of this monograph was submitted in competition for the Charles Eliot Norton Fellowship of Harvard University. Completed it was offered for the degree of Doctor of Philosophy at Harvard, as also in fulfillment of the requirements imposed upon the holder of the Norton Fellowship.

I wish to express my thanks to Professor Tarbell, and the authorities of the University of Chicago Press for permission to use two plates (PLATES I and II) which originally appeared in the *Decennial Publications*, Vol. VI, 1902.

<sup>2</sup> *Meisterschalen*, p. 350.



associated with him. Inasmuch as Hartwig is in most cases correct in his assignment of vases (I have found instances, I think, where he is wrong),<sup>1</sup> I have been led to believe that it is rather his wide experience and intimate knowledge of ceramics that has enabled him to collect the works of Brygos, than the characteristics that he has enumerated in his treatment of the works of that artist.

It will, then, be my purpose to endeavor to discover, first, the characteristics that are peculiar to Brygos alone. The identification of these will be by a process of elimination. For it is evident that any trait occurring as well in the works of other artists as in those of Brygos cannot be used as a sure means of identification, and for that reason must be discarded from our list of personal peculiarities. My treatment of these peculiarities, furthermore, will concern itself at first only with the vases signed by Brygos, because manifestly only the characteristics that are found on these can be vouched for as belonging to Brygos; and it is only by the recognition of these characteristics on unsigned vases that we are able with certainty to assemble such vases as products of our artist.<sup>2</sup> These individual peculiarities of style established, I next propose to determine groups of characteristics which, while they may, or may not, be individually peculiar to Brygos, yet may be considered, when found together on a vase, as an index that the vase possessing them should find a place in our category. I wish, then, to consider the relation of Brygos to other contemporary artists; to discuss his possible copartnership with any other artist; to consider the probable chronological sequence of his works; and, finally, to discover, if possible, his native country.

Let us begin by looking for characteristics which occur on vases signed by Brygos, but on the works of no other artist. By using these characteristics we shall be able to move with safety from the signed to the unsigned vases<sup>3</sup> of our artist, and, by enlarging the circle, to construct groups of characteristics which, while they are not infallible, are fairly safe means of identification. In the chapter of his *Meisterschalen* that is devoted to Brygos, Hartwig gives thirty-eight characteristics by which he maintains it is possible to recognize the style of our artist. Some of these, as will be seen later, he admits are present on the vases of other artists; but others, if we are to judge from the omission of parallel instances, he gives as belonging to Brygos

<sup>1</sup> *E. g.*, No. 25 of our list (p. 109) is assigned by Hartwig to Apollodoros.

<sup>2</sup> It is understood, of course, that any new characteristic found on an unsigned vase that, by these old characteristics, has been identified as a work by Brygos, is to be accepted as a new characteristic belonging to Brygos.

<sup>3</sup> On p. 364 of his *Meisterschalen*, Hartwig says that there are more than forty vases that have been assigned to Brygos; and Robert (Pauly-Wissowa, *Real-Lex.*, V, p. 923) says that there are fifty vases that, with more or less certainty, have been attributed to him. Counting vases and fragments as well (related fragments considered as one), and not counting five doubtful cases, I have collected seventy-six vases in the list appended to this monograph.



alone. I have already shown how valueless, for one wishing to do accurate work, are peculiarities that can be duplicated elsewhere. Our first duty is to ascertain how far the characteristics, as given by Hartwig, are peculiar to our artist. In doing this I shall show in each case, first, whether the characteristic under consideration is to be found on the signed works of Brygos, and, secondly, whether it appears on the vases of other artists. In many cases I shall be able to employ Hartwig's own book, the *Meisterschalen*, as proof against himself.

The characteristics assigned by Hartwig to Brygos are these:

1. *The meander is the double, interlocking variety.* For an illustration of it, see Hartwig's *Meisterschalen*, pl. XXXIII. This meander (Fig. 1) does not occur on the signed vases.

The meanders, and other borders, that do appear on the signed vases of Brygos are —

*a* (Fig. 2). One in which the meanders are interrupted at intervals of two or three by crossed squares. A variation (Fig. 3) appears on the same vase with it. For illustration see *Wiener Vorlegebl.* VIII, 2.

*b* (Fig. 4). One in which the meanders are in groups of three. For this see *Wiener Vorlegebl.* VIII, 3.<sup>1</sup>

*c* (Fig. 5). One in which the meanders are interrupted at irregular intervals. This is illustrated in the *Wiener Vorlegebl.* VIII, 5.

*d* (Fig. 7). One in which the meanders are interrupted at intervals of three or more. This meander is given in the *Wiener Vorlegebl.* VIII, 4.

*e* (Fig. 8). One which is found on a vase given in the *Wiener Vorlegebl.* VIII, 6.

*f* A palmette scroll. This occurs on one of the fragments illustrated in the *Wiener Vorlegebl.* C, VII.

In many cases these styles of meanders (*a-f*) are to be found elsewhere. Thus the one given in the *Wiener Vorlegebl.* VIII, 2 (*a* of our list), occurs on two vases illustrated in *Vases of the Ashmolean Museum*, pls. 10 and 11. All these meanders appear as well on a number of vases illustrated in the *Meisterschalen*, pls. VIII, XI, XII, XIII,

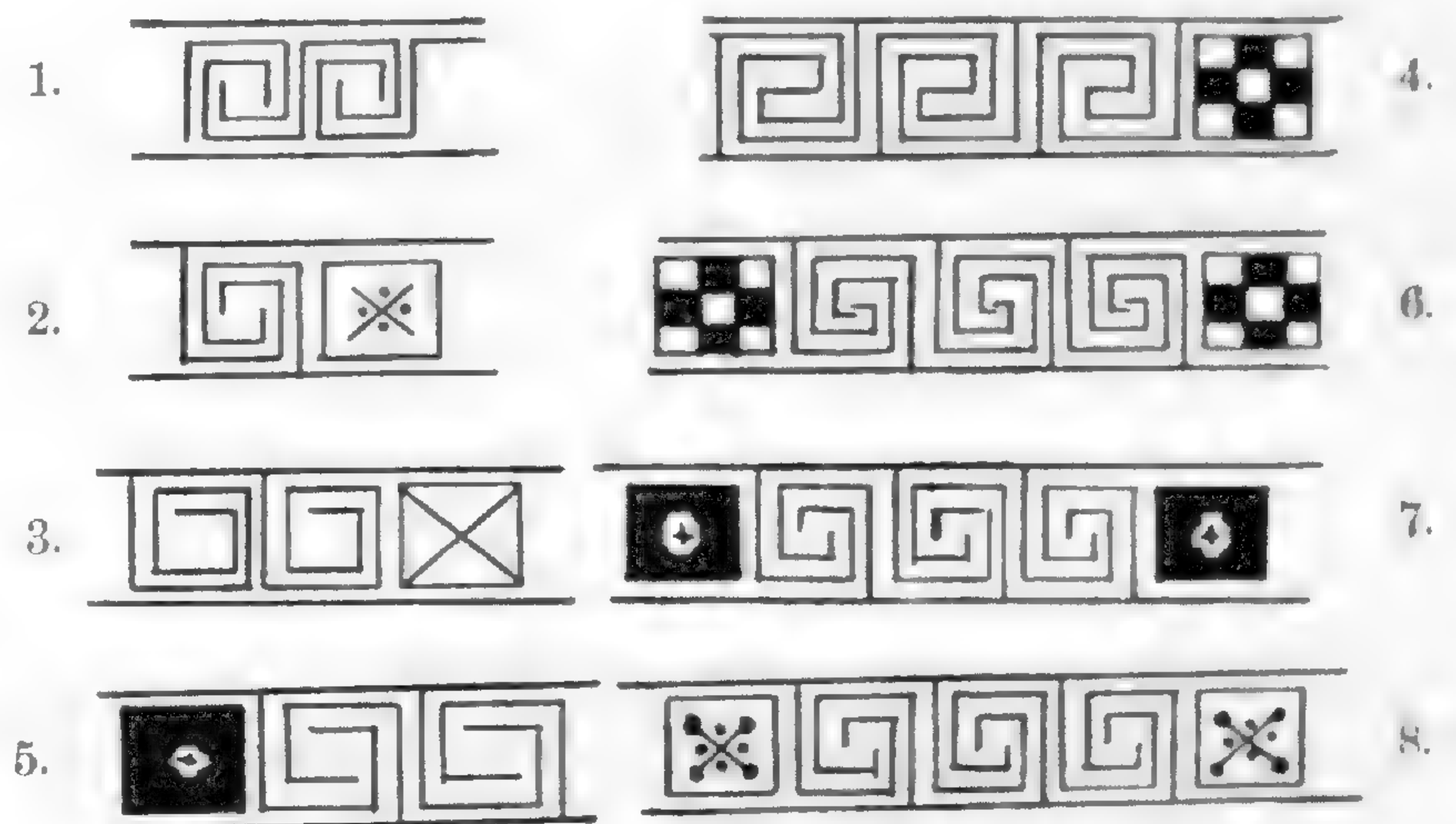

FIGURES 1-8. — MEANDER DESIGNS.

<sup>1</sup> A variety of this occurs on a kylix (p. 114) in the Museum of Fine Arts, Boston, No. 9023. It is not mentioned by Hartwig. The meander is that shown in Fig. 6.



XIV, XV, XVI, XLIV, 2; XLV; and XLVI. The bands are interrupted, however, so that the similarity is to be understood to exist only in the matter of the meanders themselves. A meander border with both the meanders and the interrupting squares like those shown under *d* of our list, appears on a vase by Duris, illustrated in the *Meisterschalen*, pl. LXV. Here the square occurs after every second meander, instead



FIGURES 9-16. — ILLUSTRATIONS SHOWING CHARACTERISTIC TREATMENT OF FIGURES AND DRAPERY.

9. *Mon. d. Inst.* VIII, 46; 10. Heydemann, *Hipersis*, pl. I; 11. *id.* pl. I; 12. *Meisterschalen*, pl. XXXIV; 14. *id.* pl. XXXIV; 15. Furtwängler and Reichhold, *Griech. Vasenmal.* pl. 25; 16. *Mon. d. Inst.* 1856, pl. XIV.

of every third or fourth one, as on the works of Brygos. The meander shown as the second example, under *a* of our list, is to be seen on vases done by Duris, illustrated *op. cit.*, pls. XIX, XX, and XXII, 2; and that given under *b* (*Wiener Vorlegebl.* VIII, 3) occurs on a vase illustrated in Gerhard's *Aus. Vasenb.* pl. CCXCVII, 3. The meander scheme that is shown under *e* of our list is duplicated on vases illustrated in Murray's *Designs from Greek Vases*, etc., pls. XIV, 56, and XV, 59. Of the squares that interrupt the meanders, the one given as the first under *a* (which is in fact but a simpler form of that shown under *e*) finds a parallel on a vase given in the *Catalogue of the Vases in the Ashmolean Museum*, pl. 11; those described under *c* and *d* are duplicated on vases engraved in the *Meisterschalen*, pls. LXV, LXVII, 1, 2, 4 (these are by Duris); XLII, 1 and 2 (by the so-called "Master with the Bald Head"); and LXXII, LXXIII, and LXXIV (by the so-called "Master with the Twig").<sup>1</sup> The same variety of square that appears on these vases is seen also on others illustrated in Gerhard's *Aus. Vasenb.* pl. CCXCVII, 3, in the *Catalogue of Vases in the Ashmolean Museum*, pl. X, and in *Designs from Greek Vases in the British Museum*, pl. XIV, 56. The palmette that takes the place of the meander border on the vase given under *f* is like that on a vase by Duris, illustrated in the *Meisterschalen*, pl. XXII, 1.

The only noteworthy feature, then, of the meander border as used by Brygos is that the individual groups of meanders which go to make it are interrupted at certain

<sup>1</sup> This last vase I have described in the *Annual Report for 1900 of the Museum of Fine Arts, Boston*, No. 12.



intervals (commonly after the third or fourth meander) by squares with various ornamentations. This peculiarity, however, is not the sole property of Brygos, but appears, as we have seen, on vases by the "Master with the Bald Head" and the "Master with the Twig."

2. *The satyrs are lively, and have small heads and short noses.* According to Hartwig, satyrs of this type are very characteristic of Brygos. But on the only signed vase that has a picture showing satyrs, illustrated in the *Wiener Vorlegebl.* VIII, 6, the heads are not small. They are perhaps not so large as those of the satyrs done by Euphronios, but, as compared with the Hieronic satyr heads, they could not be described as small. Hartwig is inaccurate, moreover, in calling the noses of the satyrs short. The shape of them is rather such as would be obtained by placing a finger under the end of the nose and pressing it upward. The characteristic satyr nose<sup>1</sup> on the Brygos vase appears in Fig. 9. The lively satyr is not peculiar to Brygos. Hieron and Euphronios both represent their satyr figures with considerable action. The only characteristic that can truly be said to belong to the Brygos satyrs, and to no others, is the turned-up nose.

3. *A black stripe, with dots along one edge, serving as a border for garments* (Fig. 10). This, as Hartwig notes, is very common. It occurs nine times on the vase illustrated in the *Wiener Vorlegebl.* VIII, 4, three times on the one illustrated *id.* VIII, 5, and three times on the one illustrated on VIII, 6. It is not confined to Brygos, however, for Duris, Hieron, and Onesimos have it (*Meisterschalen*, pls. XXVIII, LIV, and LXV), and it is found on a vase illustrated on Gerhard's *Aus. Vasenb.* pl. CCXXXIX. The decoration was passed on to the fine red-figured style (see Millingen, *Peintures antiques de Vases Grecs*, pl. XI).

4 (Fig. 11). *The garments are ornamented with dots.* Hartwig remarks that this form of decoration occurs also on works of Euphronios. Of the signed vases of Brygos, it is found on those given in the *Wiener Vorlegebl.* pls. VIII, 2, 3, 4, 5, and 6. It occurs once on the vase shown on pl. VIII, 2, once on that shown on VIII, 3, four times on that illustrated on VIII, 4, ten times on that on VIII, 5, and twice on the vase shown on VIII, 6. The same decoration is found also on a vase by Onesimos, *Meisterschalen*, LXII, 2; on an amphora of the severe red-figured style by Duris (?), Gerhard, *Aus. Vasenb.* pl. CCLXXXIII (this also has the dotted stripe); on a vase given on pl. XVIII, *op. cit.*, and, finally, on another illustrated in the *Arch. Zeit.* 1883, pl. 4. This ornament was possibly borrowed from the black-figured style, for it occurs on vases of that period. For illustration, see Gerhard, *Aus. Vasenb.* pl. CXXX.

<sup>1</sup> Cf. All the satyrs but Styon on No. 8 of the list of signed vases (p. 104).



5. *The head is often thrown far back.* This is given by Hartwig as a favorite motive of our artist, and is illustrated by him in his *Meisterschalen*, pl. XXXIII (Fig. 13). This feature occurs on three of the signed vases, namely, those shown in the *Vorlegebl.* VIII, 3, 4, and 5. Duris, however, uses it (*Meisterschalen*, pl. XIX, interior picture), as well as Euphronios (*id.* pls. XLIV, 1, and XI), the "Master with the Bald Head" (*id.* pl. XLIII, A), and the "Master with the Twig" (*id.* pl. LXXIII, A). Among the artists of the earlier period Epiktetos makes use of it (*Designs from Greek Vases*, pl. VI, 22).

6. *The body is often tilted backward.* It is to be associated, says Hartwig, with the thrown-back head. This motive occurs twice on the vase given in the *Wiener Vorlegebl.* VIII, 6, and five times on that shown on *id.* VIII, 5, but it appears on none of the other signed vases. Hartwig is correct in noting that Hieron uses it, as will be seen from pl. XXIX of the *Meisterschalen*. But it is to be found as well on a vase by the "Master with the Bald Head" (*id.* pl. XLIII), on one by Euphronios (*id.* pl. XLVII), on one by Oltos (*Meisterschalen*, pl. VI, B), on two by Onesimos (*id.* pls. LVII, B, and LX), and on one by the "Master with the Twig" (*id.* pl. LXXIII).

7. *The ears of the satyrs occur in various positions.* As we have already seen, only one of the signed vases has a satyr picture, and on this there is hardly any difference in the positions of the various ears. This motive does occur, however, on a vase by Duris (*Meisterschalen*, pl. XXIII), where the greatest variety is introduced. The "Master with the Twig" (*id.* pls. LXXIII and LXXIV, the Boston kylix) also uses this motive. In the last mentioned vase the artist has gone even to the extent of bending the ears so that they hang like the flapping ears of a dog. The appearance of these ears is somewhat like Fig. 14.<sup>1</sup>

8. *Maenads dancing with their arms covered by sleeves in imitation of wings.* This motive, asserts Hartwig, is common with Brygos. It occurs, as a fact, on none of his signed works. It appears twice on a vase, illustrated on pl. XXXII of the *Meisterschalen*, which, though unsigned, undoubtedly belongs to Brygos. The "Master with the Bald Head" has this feature five times on a vase given by Hartwig on pl. XLIII of his *Meisterschalen*.

9. *The thyrsoi have dots about the heads.* This distinguishes them, says Hartwig, from those of Hieron. No thyrsoi occur on the signed vases of Brygos. If we had such dotted thyrsoi on Brygos' works, they could well serve as a means of identification, for they do not appear on the vases of any other artists.

10. *An intense expression in the face.* This is quite the opposite of the expression

<sup>1</sup> Hartwig, *Meisterschalen*, pl. LXXIV.

<sup>2</sup> See also Furtwängler and Reichhold, pl. 49.



found in the Hieronic faces, maintains Hartwig, and is only paralleled in the works of Euphronios, and in the best heads of Duris. This expression appears on the faces shown in the *Wiener Vorlegebl.* VIII, pls. 2, 4, 5, and 6, and *id.* C, pl. 7, and is due not so much to the parted lips, as Hartwig believes, or the beady eyes as to the extremely delicate nostril. To make this clear, — a vase by Peithinos (*Meisterschalen*, pl. XXVI) has figures with narrow, beady eyes, but with no intensity of expression; while another vase, from the hand of Euphronios (*id.* pl. XI, B, first figure at the right), shows a figure with a beady eye and parted lips, but still lacking the Brygos intensity. In the latter example the mouth does not give the impression of drawing in the breath as do those of the figures done by Brygos. The vase by the “Master with the Twig” (now in Boston) exhibits the narrow eye in the third figure from the right on side B. But the lips are not parted, nor the nostril dilated, so that here, too, the Brygos intensity of expression is absent. Two faces that bear a very close resemblance to the Brygos type are to be found on a kylix by Onesimos (*id.* pl. LIV), and on another vase, given in Gerhard, *Aus. Vasenb.* pl. XCLVI. In the latter vase the interior picture shows a bearded man with a very narrow eye, parted lips, and a fine nostril. Another example is to be seen in the *Arch. Zeit.* 1883, pl. 4, where the figure at the left, on side A, has the narrow eye and the fine nostril. The faces of these figures, however, lack intensity, owing, as I said above, to the fact that the nostril is not dilated. This peculiar intensity is due almost entirely to the manner of drawing the nostril. The line from the tip of the nose to the lip curves downward, and then upward to meet the lip, and the line of the nostril, which is a double curve, crosses the point of meeting. The nose thus drawn appears somewhat as in Fig. 12.<sup>1</sup> It is to be noted, finally, that the corner of the mouth never turns upward. This fact, combined with the narrow eyes, and particularly the dilated nostril, give to the Brygos faces their peculiar intensity. This is best seen, on the signed works, in the face of the figure named Chrysippos, on the vase illustrated in the *Wiener Vorlegebl.* VIII, 6.<sup>2</sup>

**11.** *The bodies of the satyrs are hairy.* None of the satyrs on the vase given in the *Wiener Vorlegebl.* VIII, 6, present this peculiarity. Such a feature does appear, however, on a vase by the “Master with the Bald Head” (*Meisterschalen*, pl. XLIII, side A). Here the satyr has a hairy chest and abdomen. This treatment appears also in the case of the second satyr from the left on side B. The “Master with the Twig” uses the same motive on a kylix in the Vatican (*id.* pl. LXXIII).

**12.** *The figures have small heads.* This criterion is hardly more trustworthy here than it was in the case of the satyr heads (No. 2). Thus, on the vase illustrated in the

<sup>1</sup> Hartwig, *Meisterschalen*, pl. XXXIV.

<sup>2</sup> See Fig. 25 (p. 80).



*Wiener Vorlegebl.* VIII, 3, Apollo has a large head, as well as Andromache on the vase shown in the *Vorlegebl.* VIII, 4, and the third figure from the left on side B of the vase given in the *Vorlegebl.* VIII, 5. The fragment, No. 2 b, of the vase given in the *Vorlegebl.* C, 7, shows a large head. These are all on the signed vases. But to show that, where small heads do occur, the feature is not peculiar to Brygos, it is only necessary to cite a vase by Hieron (*Meisterschalen*, pl. XXX, 2) the interior figure of which, Dionysos, has a small head, to mention a vase of the "Master with the Twig" (Boston), which has many small heads, and, finally, a kylix by Duris, which I have described in the *Annual Report* for 1900 of the Museum of Fine Arts, Boston.

**13.** *Food baskets hang in the field.* This motive is found on none of the signed vases. It does occur on two kylikes by Euphronios, and on one by Duris (*Meisterschalen*, pls. XV, XLVIII, 2, and XX, side B). A third example of this characteristic is seen on a vase illustrated in Millingen, *Peintures antiques de Vases Grecs*, pl. VIII.

**14.** *The arrangement and the decoration of the pillows.* By these characteristics I take Hartwig to mean, in the former case, the placing of the pillow on the couch so that part of it projects over the end, and, in the latter, the decoration of the pillow by stripes. These two features do not occur on the signed works of Brygos, but they are found on the vases given by Hartwig in his *Meisterschalen*. The pillow so placed that it projects beyond the end of the couch occurs on a vase by the "Master with the favorite Lysis" (*id.* pl. LXX, 2), while an instance of the striped pillow is to be found in Millingen, *Peintures antiques de Vases Grecs*, pl. VIII, and in the *Arch. Zeit.* 1883, pl. 4, in the interior picture.

**15.** *Disproportionately long legs and arms of figures reclining on couches.* As an illustration, Hartwig cites pl. XXXV of his *Meisterschalen*, where, as a fact, this manner of drawing the figures is to be seen. But no such lack of proportion occurs on the signed vases of Brygos. A kylix by Apollodoros (*Meisterschalen*, pl. LXIX) does, however, exhibit this peculiarity. Hence, had we found it even on a signed vase of Brygos, it would have been impossible to assert it to be peculiar to Brygos.

**16.** *Representation of adolescent female figures.* This is well shown on the vase illustrated in the *Wiener Vorlegebl.* VIII, 5, where, on side A, the girl who plays the flute is represented as about fifteen years old. In the interior picture appears a girl of the same age. Both wear short hair, and this, along with the care which Brygos takes to represent immature development, makes the figures easily recognized as those of young girls. But this care to show youthfulness in girls is not exercised only by Brygos. Hieron, as well, on a vase signed by him (*Designs from Greek Vases*, pl. X, 40), has a girl, dancing to music, drawn with as much care to show her youth as Brygos shows in his youthful figures.



17. *The figures have a less strongly marked chin than do those of Hieron.* This will not hold; for in many cases the chins of the figures drawn by Brygos are fully as strong as those by Hieron. For proof of this, we have the seated figure, at the left, on side A of the vase illustrated in the *Wiener Vorlegebl.* VIII, 2, and the third from the left on B. Other figures showing the same characteristics are the girl on the interior of the vase given in the *Vorlegebl.* VIII, 5, Orsimenes on the Iliupersis kylix (*id.* VIII, 4), Hera on the vase given in the *Vorlegebl.* VIII, 6, and Iris on a vase illustrated in Series VIII, 6, of the same publication. If the chins of the figures on the vases just cited are compared with those on a vase by Hieron (*Meisterschalen*, pl. XXIX), the difference will appear to be not so much in the chin itself as in the less hanging lip. In certain cases, the chins of the figures done by Brygos are shorter; but these are exceptions.

18. *Variety in the garments of women.* On the vase given in the *Wiener Vorlegebl.* VIII, 4, three out of the four women have their garments arranged differently. The figures on the vase given in the *Vorlegebl.* VIII, 6, also differ in the arrangement of their drapery, and on the vase shown in the *Vorlegebl.* VIII, 3, five out of the seven vary, while on the vase illustrated in the *Vorlegebl.* VIII, 2, four out of seven show variation. The flute-player on the exterior of the vase given in the *Vorlegebl.* VIII, 5, is clad the same as the girl of the interior picture. It will be seen that the female costumes on the vases of Brygos do show a great variety of treatment. As great a difference is to be seen, however, on a vase by Hieron (*Meisterschalen*, pl. XXXI, side A), where four out of five vary in the matter of dress, while on another vase of his (*id.* pl. XXIX), the two women are differently draped.

19. *The eyes are narrow.* This characteristic is connected by Hartwig with No. 20. The combination gives a cunning expression most peculiar to Brygos; the expression, however, is due not to the snub nose but to the narrow eye. We have considered this latter feature to some extent under No. 10 — “the tense expression.” We have now to treat it more closely, and to see to what extent it appears on the signed works of Brygos, and then whether it is common with other artists of the same period. That it is common on the signed vases of Brygos is clear from the following. In the vase shown in the *Wiener Vorlegebl.* VIII, 2, eight of the fifteen figures have it, on that given in the *Vorlegebl.* VIII, 3, one out of thirteen (showing that it does not always predominate), on that given in the *Vorlegebl.* VIII, 4, six out of twelve, on that given in the *Vorlegebl.* VIII, 5, eight out of fifteen, on that given in the *Vorlegebl.* VIII, 6, two out of fourteen, and on that shown in the *Vorlegebl.* C, 7, none have it. By a reference to No. 10 of our list it will be seen that the narrow eye is present also on



the vases of Peithinos, Euphronios, the "Master with the Twig," the "Master with the favorite Lysis," Apollodoros, Duris, and Onesimos.

In the case of boys and girls, the characteristic of the narrow eye is correctly stated by Hartwig to be peculiar to Brygos, if we understand him to mean that the eye is very long, as well as exceedingly narrow. Unless these two peculiarities are combined, the characteristic is of no use, inasmuch as the narrow eye occurs, as we have seen, on vases by other artists.

20. *The boys and the girls are characterized by small, snub noses.* This, we have seen, Hartwig associates with the narrow eye. The small nose is not necessarily a companion of the narrow eye, as will be clear from the instances cited under No. 19. It is well illustrated in the figure of Astyanax on the Iliupersis kylix (*Wiener Vorlegebl.* VIII, 4). It occurs also on a figure on a vase by the "Master with the Twig" (*Meisterschalen*, pl. LXXII, 1, the winged boy), on a vase by Peithinos (*id.* pl. XXVI, A, the second and third figures from the right), and on a vase by Duris (*id.* pl. XXII, 1). The small snub nose is seen also on two other vases, one of which is signed by Duris, the other done in his style (*Designs from Greek Vases*, pls. VI, 24, and IX, 35).

21. *The lyre is long and slender.* For an example, Hartwig cites pl. XXXIV of his *Meisterschalen*. On the signed vases of Brygos there is but one instance of the lyre (*Wiener Vorlegebl.* VIII, 5, side B), and here the form is not slender. The slender lyre appears, however, on a vase by Hieron (*Meisterschalen*, pl. XXIX, B, the second from the right), on one by Duris (*id.* XIX, 2), and finally on a fragment of a vase by Phintias,<sup>1</sup> where the form is almost identical with that given by Hartwig.

22. *Figures reclining on couches are covered to the waist with the himation.* Hartwig illustrates this by pl. XXXV of his *Meisterschalen*. No instance of this feature occurs on the signed vases. It appears on the interior of a kylix by the "Master with the favorite Lysis" (*id.* pl. LXX, 2), on fragments of a kylix by Apollodoros (*id.* LXIX, fragments 2 *c* and *d*), and on a work of Duris (*id.* LXVII, 4).

23. *A nude boy as a wine-pourer.* For Hartwig's example, see pl. XXXIV of his *Meisterschalen*. No such figure occurs on the signed vases of Brygos, nor are there, to my knowledge, any on the works of other artists. But a figure standing in the same attitude, except that the right hand clasps the column, instead of resting against it, is to be seen in Gerhard's *Aus. Vasenb.* pl. CCXCI, 2. The figure differs from the one shown by Hartwig on pl. XXXIV in that it is clad in an himation.

<sup>1</sup> Hartwig, *Meisterschalen*, pl. XVII, 2.



24. *Some of the figures are represented with blond hair.* No such treatment occurs on the signed vases. It appears on a vase by the "Master with the Twig" (*Meisterschalen*, pl. LXXIII, interior, and all satyrs on B), and on another by the same artist (the Boston kylix), where all the figures but one on B have blond hair.

25. *A flute player looks back, playing the flutes, as he moves forward.*<sup>1</sup> Hartwig's example is found on pl. XXXII, B, of his *Meisterschalen*. This pose appears on side B of the vase illustrated in the *Wiener Vorlegebl.* VIII, 5. Hartwig is right in designating this motive as the property of Brygos alone, for it does not occur on the works of

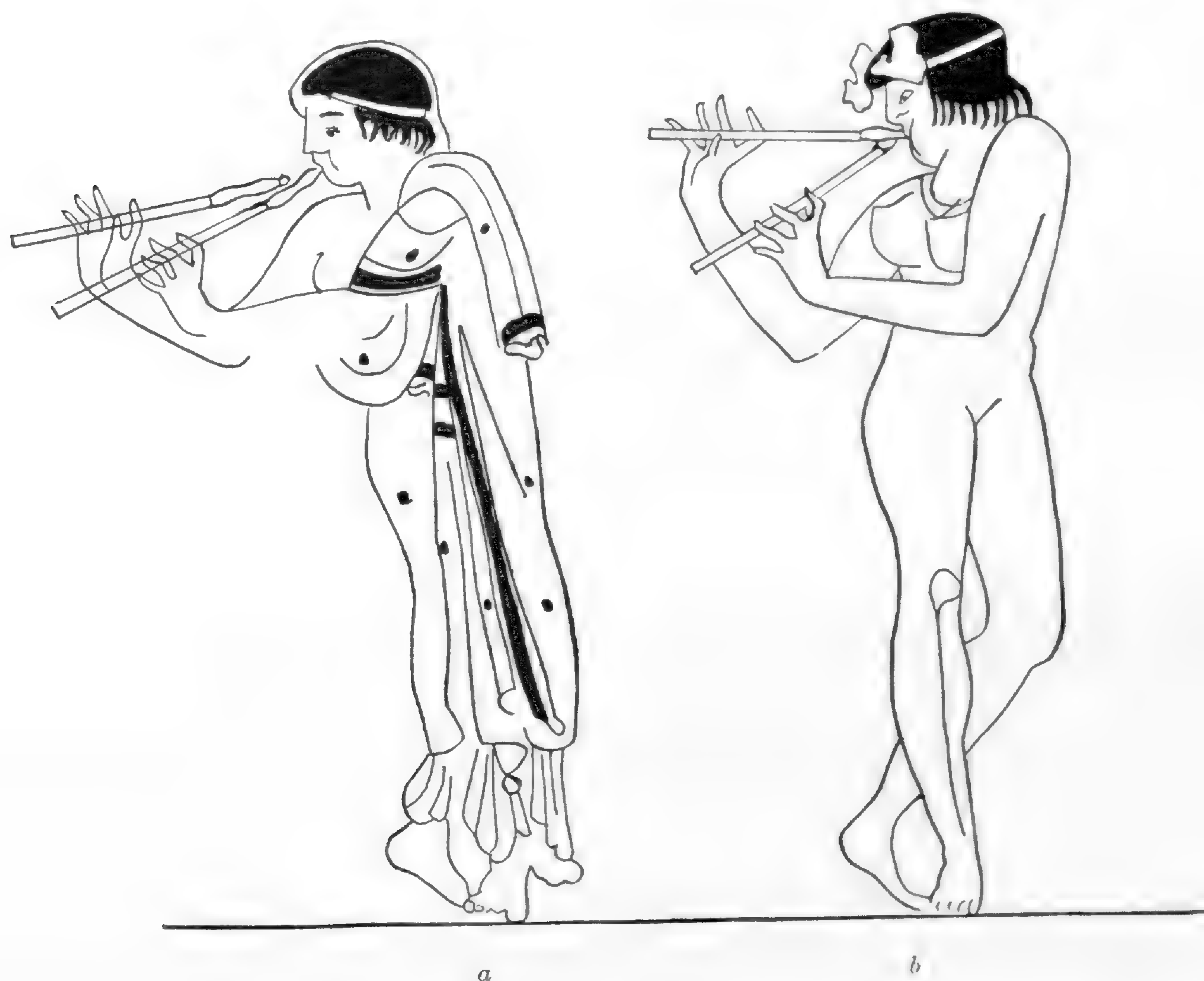

FIGURE 17. — CHARACTERISTIC POSES OF FIGURES BY BRYGOS.

any other artist. The idea with Brygos seems to have been that of representing his flute-player as turning around to encourage those who follow him. The other artists, as the "Master with the Bald Head" (*Meisterschalen*, pl. XLIII) and Oltos (*id.* pl. VI, B), were content to have their musician so absorbed in his own playing as to move straight ahead, paying no attention to those that followed.

26. *One of the shoulders of the female flute-players is left bare, so that the breast is*

<sup>1</sup> See also p. 333, Fig. 44 b, of the *Meisterschalen*



*exposed.* This motive appears on none of the signed vases of Brygos, nor, to my knowledge, on any vase of any other artist (Fig. 17).<sup>1</sup>

27. *A staff, with a robe draped on it, leans against some object.* Hartwig illustrates this with pl. XXXVI, 2, of his *Meisterschalen*. It is not to be found on the signed vases of Brygos. Hartwig notes that it appears on works of Peithinos, a fact which emphasizes the need of excluding it from the characteristics peculiar to Brygos.

28. *A girl playing a flute stands before a couch on which reclines a man.* This motive is common to Brygos, says Hartwig, who illustrates it by pl. XXXIV of his *Meisterschalen*. The signed works give no example of such a figure. It is not on works of other artists.<sup>2</sup>

29. *Details are introduced to show locality.* For illustration of this, Hartwig refers to pls. XXXIV and XXXVI, 3, of his *Meisterschalen*, as well as to Gerhard, *Trinksch. u. Gef.* pl. VIII. On the vase given in the *Wiener Vorlegebl.* VIII, 2, a column and its architrave are introduced to suggest a house, and the same motive is found on VIII, 3. On side B of the last vase, which shows the "Judgment of Paris," is a tree to indicate that the scene is out of doors. The use of such details, however, is not an original idea with Brygos, as will be seen from what follows. In the interior of a kylix (*Meisterschalen*, pl. III), Charchrylion shows an altar to be in the open air by the introduction of a tree. The same detail is used by the "Master with the Bald Head" (Boston). On the exterior of a kylix in the British Museum (*id.* pl. XLI) are shown canopies, as Hartwig rightly says, to suggest the tent of Achilles from which Briseis is being led away. In the interior of a kylix, also in the British Museum (*id.* pl. XLII, 2), is drawn a door to show a house. Euphronios uses a tree for a detail in the St. Petersburg kylix (*id.* pl. XLIX), and introduces a column and a post in a scene where boys are riding horses — possibly to suggest a hippodrome (*id.* pl. LII). Onesimos, as well, uses the column on the exterior of a kylix in the Louvre (*id.* pl. LIII), and on another of the Castellani collection (*id.* pl. LIV). On a fragment (*id.* pl. LVIII) he introduces a tree. The "Master with the favorite Lysis" (*id.* pl. LXX, 3 b) uses a column as a detail to suggest a palaestra. The same feature is present on a vase given in the *Arch. Zeit.* 1878, pl. 2, and in the *Jb. d. Arch. Inst.* 1889, p. 29.

30. *Shadows are represented on columns by means of diluted glaze.* This feature does not occur on the only signed vases that have columns, namely, those illustrated in the *Wiener Vorlegebl.* VIII, 2 and 3. It does not occur on the works of other artists.

<sup>1</sup> For an example on an unsigned vase by Brygos, see Fig. 17. Figure a, *Meisterschalen*, pl. XXXVI; Figure b, *Lecuger Coll.* E. 5.

<sup>2</sup> See Fig. 17, both figures.



**31.** *The sceptres are wound with a fillet.* This decoration, which is applied in the manner that a stripe is painted about a barber's pole, occurs on four of the signed vases of Brygos. They are illustrated in the *Wiener Vorlegebl.* VIII, 2, 3, 4, and 6. It is found also on a vase given in Gerhard, *Aus. Vasenb.* pl. CCXCII, 3.

The following seven characteristics which are given by Hartwig deal only with the treatment of the hair. They are:

**1 (32).** *The hair is rolled at the back of the head.* Hartwig mentions this as common with Brygos, and to illustrate it cites pl. XXXIII, 2, of his *Meisterschalen*. This style of dressing the hair appears on none of the signed vases, and on only two given by Hartwig on pls. XXXII and XXXIII, 2. The same manner of treating the hair is employed by Peithinos on a vase in Berlin (*id.* pl. XXVII, side A). Here the roll is a trifle more elaborate. It appears on another kylix of Peithinos in Berlin (*id.* pl. XXIV, 1) and is used by Duris on the youth on the interior of the Boston kylix (*id.* pl. XXI).

**2 (33).** *The hair is gathered in a single roll at the neck.* This is shown on pl. XXXIII, 2, of the *Meisterschalen*. The figure at the extreme left of side B of the vase given in the *Wiener Vorlegebl.* VIII, 4, has his hair done up in this way. Peithinos uses this mode of doing the hair (*Meisterschalen*, pl. XXVII), and Duris uses the same feature on a kylix of the Louvre (*id.* pl. LXV). This also appears on a stamnos of the severe, red-figured style, illustrated in Gerhard, *Aus. Vasenb.* pl. XLIV, 2. See our PLATES I, II.

**3 (34).** *The hair is arranged in a series of egg-shaped rolls.* This mode of dressing the hair<sup>1</sup> (Fig. 15, p. 8) appears on the Iliupersis kylix, on the figure that has fallen before Orsimenes. The characteristic is not confined to Brygos, but is used by the "Master with the Twig" (*Meisterschalen*, pl. LXXV) on all the six figures on side A, and on the first and the fourth from the left on side B.

**4 (35).** *The hair hangs in a knot tied once or twice on the neck.*<sup>2</sup> This feature appears on none of the signed vases, nor on the plates given by Hartwig in his *Meisterschalen* to show the style of Brygos. Hieron, however, uses it on the Baltimore kylix (*id.* pl. XXX, 3). Here the girl in the interior picture has the hair done up in a cue, and tied with one knot. The "Master with the Twig" also employs this scheme for the hair of the girl at the right on side B (*id.* pl. LXXV).

**5 (36).** *The hair is drawn as a double row of egg-shaped rolls on the neck.* This is illustrated on a kylix, probably by Brygos, that is given in Gerhard, *Aus. Vasenb.* pls. CCLXXVIII and CCLXXIX, 3. It occurs on no signed vase of Brygos, and no other artist uses this method of drawing the hair.

<sup>1</sup> No. 4 of list of signed vases (p. 102).

<sup>2</sup> See Plate II.



6 (37). *The hetairae are represented with short hair.*<sup>1</sup> The flute-player on side A, and the girl on the interior of the vase illustrated in the *Wiener Vorlegebl.* VIII, 5, have the hair drawn in this way. This is not the invariable manner of drawing the hair of hetairae, as is shown by the fact that Nikophile on the kylix rightly assigned by Hartwig to Brygos, and illustrated in the *Meisterschalen*, pl. XXIV, has long hair. No other artist makes use of short hair in representing the hetairae class.

7 (38). *By the use of dilute glaze Brygos loosened the hair of his figures more than did his contemporaries.* This can hardly be of use in identifying the works of Brygos, inasmuch as the same means is employed to a greater or a less extent by other artists. In the matter of identifying a new vase, or a fragment, it would do no good to know that diluted glaze was more freely employed by Brygos than by his brother artists. The fact that they used it at all would make it possible — other proof being absent — to assign the newly found vase to another artist as well as to Brygos. The use of diluted glaze in the treatment of the hair is, as a matter of fact, found on a vase by Peithinos (*Meisterschalen*, pl. XXVII, interior), on a kylix by the “Master with the Twig” (*id.* LXXII), where all the ten heads seem to illustrate this practice, and, finally, on the Boston kylix by the same artist. Here the satyr in the centre of the interior picture and all the figures on side A, and figures 1, 3, 4, 5, and 6 on side B, have hair drawn with dilute glaze.

These then are the thirty-eight characteristics associated by Hartwig, more or less closely, with Brygos. But in the study of a vase-painter his signed works alone can be used as the starting-point for the determination of his style, and only the characteristics that appear on these vases, and on the works of no other artists, can strictly be called the characteristics of that artist. It is only by such features of style as are unique with him that we can safely identify his works. Now, in assigning vases to Brygos, Hartwig, and those who were before him, must have had some infallible peculiarities of style that appear in the works of Brygos by which his unsigned vases have been from time to time rightly or wrongly identified. Manifestly, the thirty-eight characteristics enumerated by Hartwig, and occurring to a greater or a less degree on the works of other contemporary artists, would not have yielded accurate results. If we are to hold to the signed vases as the safest ground for ascertaining the peculiarities of Brygos, only five of the long list of characteristics given by Hartwig can be said to belong to that artist alone. These are, first, the turned-up nose of the satyrs (given under No. 2, and inaccurately described by Hartwig); second, the “intense expression” (given under No. 10); third, the narrow eye of the boys and girls (only, however,

<sup>1</sup> See Fig. 17 (p. 75).



when the eyes are long as well as narrow, in No. 19); fourth, the motive of the flute-player turning to look back as he moves forward (in No. 25); and, finally, the representation of the hetairae with short hair (in No. 37), if in the last instance we are to understand that long-haired hetairae may also appear on the works of Brygos.

I can add five new characteristics by which vases of Brygos may be identified. None of these, so far as my knowledge extends, occur on the works of other artists. They are:

**1 (39).** A peculiar form of fillet that appears on the head of Apollo, on the interior picture of the vase illustrated in the *Wiener Vorlegebl.* VIII, 3. It consists of a broad band, ornamented with vertical bars, that passes around the head, and ends in two string-ends, which themselves terminate in two, three-stranded tassels. It looks much like that in Fig. 16. Hieron employs a somewhat similar one (*Meisterschalen*, pl. XXX, 3), but in the Hieronic fillet the loose ends are absent.

**2 (40).** A fillet looped behind, and having in place of the simple, three-stranded ends, three strings starting from a ball and ending each in a ball. The appearance is much like that of three cherries in a cluster. This fillet is found on the vase given in the *Wiener Vorlegebl.* VIII, 6. It looks like that in Fig. 18.

**3 (41).** A type of kerykeion that occurs in three varieties. These are shown on the vase illustrated in the *Wiener Vorlegebl.* VIII, 3, 6, and C, 7. They are given in Fig. 19.

The "Master with the Bald Head" has one somewhat like *a*, except that the top is closed. For this, see the *Meisterschalen*, pl. XLI. A still closer example is used by Pamphaios, illustrated in Gerhard, *Aus. Vasenb.* pl. CCXXI, but this varies in lacking the circle, that appears on *a*, at the junction of head with staff. This is shown in our Fig. 20.

**4 (42).** The sceptre has for a head two leaf-like objects springing from the base of a knob. For this form, see *Wiener Vorlegebl.* VIII, 2 and 3.

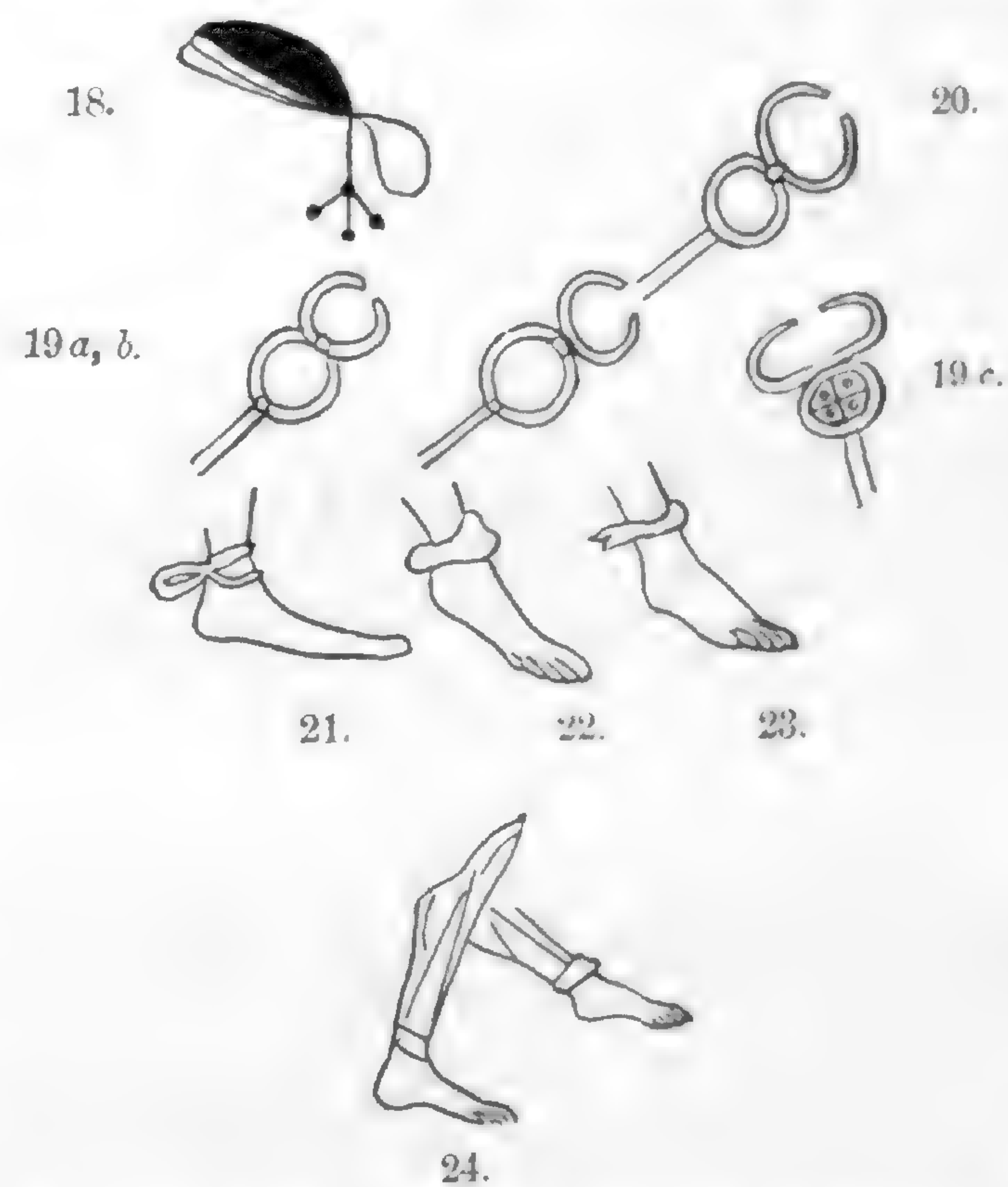

FIGURES 18-24. — CHARACTERISTICS OF BRYGOS.  
22. *Meisterschalen*, pl. LVIII; 23. *Aus. Vasenb.* pl. CCXXVI.



5 (43). A band tied about the ankles of warriors, and looped behind, just below the greaves. The object is to prevent the metal greave from chafing the flesh. An example is given in the *Wiener Vorlegebl.* VIII, 6 (Fig. 21). Other artists employ the band about the ankle. Thus it occurs on a vase by Onesimos (*Meisterschalen*, pl. LVIII, our Fig. 22), and on a vase by Euphronios (Gerhard, *Aus. Vasenb.* pl. CCXXVI, our Fig. 23 and pl. CXXIV, our Fig. 24). But in none of these instances is the band looped behind, as is the case on the vases by Brygos.

We have now, by a process of elimination, obtained a list of *characteristics which occur on the works of Brygos, and on those of no other artists.* These characteristics are as follows :

1. The characteristic satyr nose on the vases of Brygos is such as would be obtained by placing a finger under the end of the nose and pressing upward (see Fig. 9).<sup>1</sup>

2. The eyes of boys and girls are long and narrow.

3. An intense expression due to the delicate nostril, and the drooping of the corners of the mouth (Fig. 25).

4. A flute-player looks back, playing the (double) flute as he moves forward.

5. The hetairæ are shown with short hair.

6. A fillet consisting of a broad band, ornamented with vertical bars, that passes around the head and ends in two string-ends, which themselves end in a three-stranded tassel (see Fig. 16).<sup>2</sup>

7. A fillet, looped behind, ending in a ball from which start three strings also ending in a ball (Fig. 18).<sup>3</sup>

8. A type of kerykeion that occurs in three varieties<sup>4</sup> (Fig. 19).

9. The sceptre has for a head two leaf-like objects springing from the base of a knob.<sup>5</sup>

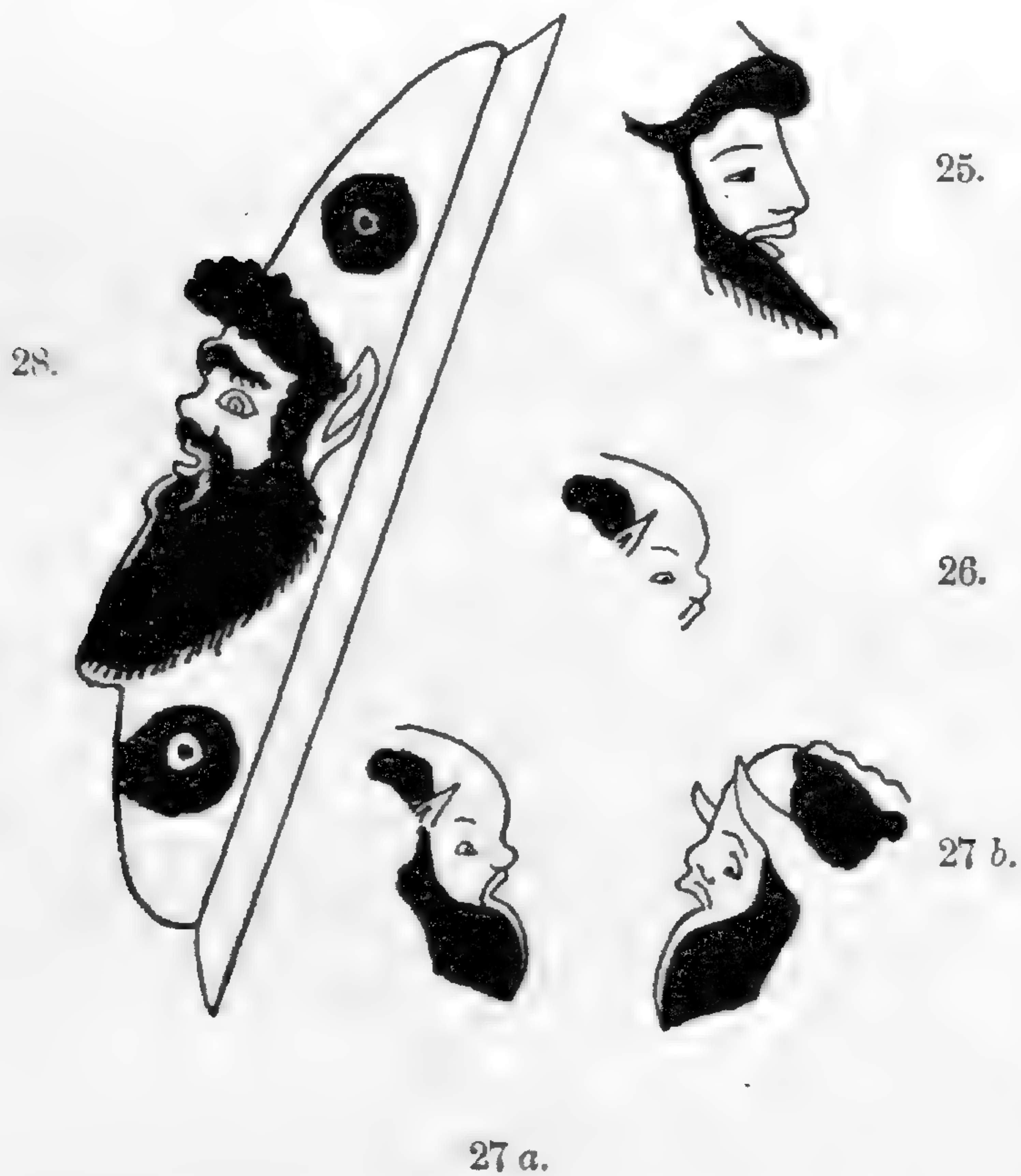

FIGURES 25-28. — TYPES OF HEADS.

25. Furtwängler and Reichhold, *Griech. Vasenm.*, pl. 47.

26. *Meisterschalen*, pl. LXIX, 1; 27 b. *id.* pl. XXXII.

28. Furtwängler and Reichhold, *Griech. Vasenm.*, pl. 14.

<sup>1</sup> *Mon. d. Inst.* VIII, 46.

<sup>2</sup> *Mon. d. Inst.* 1856, pl. XIV. Gerhard, *Trinksch. u. Gef.* IX, 5.

<sup>3</sup> *Wiener Vorlegebl.* VIII, 6.

<sup>4</sup> *Id.* VIII, 3, 6; C, 7.

<sup>5</sup> *Id.* VIII, 6.



10. A band tied about the ankles of warriors, and looped behind just below the greaves (Fig. 21).<sup>1</sup>

Since these ten<sup>2</sup> peculiarities of style appear on the works signed by Brygos, and on none of the vases by other artists, they afford an absolutely sure means of recognizing vases which, though unsigned, belong to our artist. The unsigned vases (below, pp. 105–106), which exhibit one or more of these stylistic peculiarities are the following:<sup>3</sup>

No. 1. The Brygos peculiarities on this vase are the snub noses of the satyrs, and the motive of the flute-player moving forward, but turning around to blow. This time the player is a satyr, showing that the turning motive is applied to other than symposium figures.

Beside these two motives, occur other characteristics which appear at times on the works of other artists. They are the black stripe, dotted on one edge, used as a border for himatia; dots used as ornaments for garments;<sup>4</sup> the thrown-back head; the body tilted backward; satyrs with ears in various positions; Maenads dancing with sleeves held like wings; thyrsos with dots around the heads; and the hair rolled at the back of the head. The dotted thyrsos do not occur on the works of other artists. So another means of identification is added.

No. 4. It is possible to bring this vase into the group of vases assigned to Brygos by the appearance on it of the girl playing a flute and standing before a couch on which reclines a man. This characteristic appears on a vase by our artist, — No. 19 of the appended list (p. 109).

Another characteristic (not the sole property of Brygos) is that of the thrown-back head. A variant of a characteristic is the representation of men with hairy bodies.

No. 5. It is by the means of the new characteristic found on vase No. 1, namely, the dotted thyrsos, that this vase is added to the works of Brygos; for three Maenads appear on it bearing in their hands thyrsos with dots distributed about the heads.

It is to be noted that the eye of the interior figure is represented as very narrow and beady. This we have seen (when considering the “narrow eye”) was not the sole property of Brygos, and could not be used as an unmistakable earmark of his style. But it is so frequent an occurrence in his work that it is worth while to mention it here. Another feature present on this vase is the loosened hair. This, too, is not the sole property of our artist. One might also mention the dotted robe (three instances), the hairy satyr-body, the delicate nostril, and the parted lips.

<sup>1</sup> *Wiener Vorlegebl.* VIII, 6, interior.

<sup>2</sup> For eleven additional groups of characteristics, see p. 95.

<sup>3</sup> The numbers used are those of the list appended to this monograph (pp. 105 ff.).

<sup>4</sup> It is to be remembered that this decoration rarely appears on chitones.



No. 6. The distinguishing feature of this vase is the "intense expression" appearing in the faces of the extreme figures at the left and the right on the exterior, side A.

Locality is designated by the tree on the exterior, side A, and the rock on side B.

No. 7. A characteristic not found on the works of other artists, but belonging to solely Brygos, is the representation of the hetairae with short hair. Another Brygos peculiarity, not found on his signed vases,<sup>1</sup> is the use of dilute glaze to show shadows on columns.

Seven figures show the stripe with dots on one edge, used as a border for garments; the thrown-back head occurs;<sup>2</sup> food-baskets hang on the wall; a girl on the exterior is drawn with a youthful figure, and has blond hair; there is a staff draped with a garment, and leaning against something; and a column is introduced to locate the scene. A characteristic not found on other artists' works is the drawing of a female flute-player with one shoulder left bare, so that the breast is exposed.<sup>3</sup>

No. 8. On this vase four out of the ten figures show the "intense expression." Four out of a possible eight have the garments ornamented with dots. Other characteristics occurring are the body tilted backward, and the use of details to show locality. Examples of the latter characteristic are a rabbit, aryballoi, javelins, implements hanging on the wall, and columns to designate a building. The narrow eye makes its appearance on one figure.

No. 10. The figure of Selene in the interior picture of this kylix shows the "intense expression"; and the use of the looped band about the ankles of warriors appears in both exterior pictures.

The garments are dotted, and here we may see that these dots may be of two sorts: the first variety rather large, — either solid or circles; the second evidently to imitate stitching. The latter occur in parallel rows. Details are used to indicate locality. Thus, on the exterior appears a column; while, more realistically, in the interior picture the moon and the waves are shown. The figure of Zeus shows the hair done in a series of egg-shaped rolls. The eyes of Athena and her opponent are narrow.

No. 11. In the centre of side A stands a female, with short hair, blowing a flute. The short hair marks her as a type belonging to Brygos alone. Her hair is blond.

No. 12. The fillet ornamented with bars, and ending in three-stringed tassels (characteristic No. 6, p. 80, of list of Brygos' characteristics) mark this vase as a work of our artist.

<sup>1</sup> See vase No. 19 (p. 109).

<sup>2</sup> Bearded figures of interior picture.

<sup>3</sup> See Fig. 17 (p. 75).



The only detail introduced to show the place of action is the chest,<sup>1</sup> from which Thoas, or Kypselos, emerges. The grain of the wood of the chest is shown by dilute glaze.

No. 13. Eight figures have the intense expression. Another Brygos characteristic is the looped band tied around the ankles of warriors. It appears on the youth arming in the interior picture. Three figures have garments with the dotted border, and four have the garments sprinkled with dots. One figure leans back — in this case to lift a large round shield. One of the boys has the snub nose. Details are used to indicate the locality. Thus the bags hang on the wall; and a helmet rests on a bracket secured to the wall. A stool shows the scene to be indoors. The “narrow eye” occurs once.

No. 15. The figure of Apollo, as he appears on exterior B, has the “intense expression.”

Beside this characteristic appear the “pearled” border for garments, the dotted garments (which appear in both the possible instances), the narrow boyish eye,<sup>2</sup> and the use of details to indicate locality.<sup>3</sup> It may be noted that, while here there is no opportunity for variety in women’s dress, Apollo appears differently clad on the two sides of the vase. The sceptre that Apollo bears on side B is striped.

No. 16. By means of two characteristics one recognizes this vase to be a work by Brygos. Thus one figure possesses the “intense expression,” while the girl on the exterior has the narrow, beady eye.

The other characteristics appearing are the dotted garments (there are four instances of this motive out of a possible five), food-baskets hanging on the wall, the representation of an adolescent female figure, the portrayal of the girl’s nose as snub, the covering of a reclining figure to the waist, the introduction of a staff, with a robe draped on it, leaning against some object, and the indication of the locality by means of various objects.<sup>4</sup>

No. 17. This vase is shown to be a work by Brygos by the occurrence of the motive of the “intense expression.”

Other characteristics<sup>5</sup> appearing are as follows:

The “pearled-edge” border (occurring thirteen times out of sixteen); the dotted garments (five instances); three male figures, not satyrs, have hairy bodies; the repre-

<sup>1</sup> For other instances of the introduction of a chest, *cf.* vases Nos. 56 and 59 (p. 115).

<sup>2</sup> Hermes, in the cradle.

<sup>3</sup> On exterior B, appears a tree; on exterior A, Hermes in his cradle in a cave into which comes a steer, half visible, to show the entrance to the cave.

<sup>4</sup> By means of couches, baskets, flute-cases, and a vase.

<sup>5</sup> These characteristics are not the sole property of Brygos.



sentation of an adolescent female figure (interior picture); the narrow eye; the introduction of details to show locality;<sup>1</sup> the hair done in a single roll at the back of neck (four instances); the hair done in a series of egg-shaped rolls; and the hair done in a double row of egg-shaped rolls. This last motive, not appearing on the works of other artists, is to be added as a new Brygos characteristic.

No. 18. On this vase appear the "intense expression" (both interior figures), the narrow, beady eye (both girls and the two boys), and the short-haired hetairae.

In addition to these motives are to be noted<sup>2</sup> the "pearled-edge" border; the dotted garments; food-baskets hanging on the wall; pillows striped and hanging over the edge; disproportionately long legs and arms of reclining figures (figure of interior picture); variety in women's dresses; small snub noses on boys and girls; the lyre, drawn long and slender (the short stubby variety also occurs); figures reclining on couches are covered to waist with himatia; some figures are represented with blond hair; details are introduced to show place; the hair is represented as loose (five instances); a nude boy appears as a wine-pourer; a girl playing a flute stands before a couch on which reclines a man; and shadows are shown on columns by dilute glaze. The last three characteristics appear on the works of no other vase painters, and so are to be classed as the property of Brygos.

No. 19. On this vase occurs the "intense expression,"<sup>3</sup> and the narrow, boyish eye.<sup>4</sup>

Other characteristics that occur are the thrown-back head; the tilted-back body; the short snub nose on boys; and the introduction of details to indicate locality. Three of the men are represented with hairy bodies. This is a variant of the hairy satyr-bodies.

No. 20. Three Brygos characteristics appear on this vase. They are the "intense expression" (seen in the youth at the right of the interior picture); the narrow, beady, boyish eye (in the boy of the interior picture); and the nude boy as a wine-pourer.

Beside these peculiarities are those of the dotted garments (here both varieties of dots, namely, the "stitches," and the large ones); the striped pillows hung over the edge; the snub nose on the boys and girls (here a boy); the draping of reclining figures up to the waist with himatia; and the use of details to show locality.

No. 21. This vase is marked as the work of our artist by the presence of the "intense expression" (in the trainer of the interior picture), and the beady eye in the boy with boxing thong.

<sup>1</sup> Athena and altar on A.

<sup>2</sup> The man at right end on A has hairy breast, — a common variation with Brygos from the hairy satyr-body.

<sup>3</sup> The end figure at left on A and B.

<sup>4</sup> At right end, each side of vase.



In addition to these peculiarities are those of the "pearled-edge" border for garments; the snub nose of the boy with the boxing thong; and the introduction of details to indicate locality. The narrow eye also appears in the figure of the trainer on the exterior of the vase.

No. 22. The "intense expression" appears in the figure on each side of this rhyton.

Other characteristics present are the long, slender lyre (side A), and the draping of both reclining figures to the waist with himatia. The narrow eye is present in both figures.

No. 23. The motive of the nude boy as wine-pourer<sup>1</sup> marks this as a Brygos vase.

Other characteristics on the vase are the thrown-back head;<sup>2</sup> food-baskets on the wall; striped pillows; the long, slender lyre; the draping of reclining figures to the waist with himatia; and the use of details to indicate the place.<sup>3</sup>

No. 25. These fragments are identified by the snub nose of the satyr on the fragment given by Hartwig, *Meisterschalen*, LXIX, 1.<sup>4</sup>

No. 26. On this vase are two instances of the narrow boyish eye.

Both of the boys show the snub nose. A column is introduced to locate the scene.

No. 28. On this vase appear the "intense expression";<sup>5</sup> the youthful, narrow, beady eye;<sup>6</sup> and the hair drawn as a double row of egg-shaped rolls.<sup>7</sup>

The other peculiarities appearing are the garment border with dots on one edge;<sup>8</sup> the dotted decoration on the garments;<sup>9</sup> the youthful, snub nose;<sup>10</sup> and the use of details to show locality. Three men have hairy bodies, and one (on exterior) has the narrow eye. Brygos' love of realism is well shown in the little dog on the exterior, side B, which jumps up against a boy, who holds out his hand.

<sup>1</sup> Exterior, side B.

<sup>2</sup> End figure, exterior, side A.

<sup>3</sup> Vases, etc., below the exterior pictures.

<sup>4</sup> Unfortunately, my personal acquaintance with the fragments is confined to the illustration given by Hartwig on pl. LXIX, 1, of his *Meisterschalen*. Here, because of the signature, it is given to Apollodorus. This does not preclude its being classed among the works of Brygos, — if the style warrants it. And to judge from the satyr-head, such seems to be the case. The break in the fragment has left the head as appears in Fig. 26, and even in this state the nose and mouth seem to me those of the Brygos satyr. If, however, the face is completed, the type is strongly that of our artist. See Fig. 27. (The lower half of *a* is completed from a tracing of a Brygos satyr-head, Hartwig, *op. cit.* pl. XXXII, which is reproduced as Fig. 27 *b*). It will be remembered that the satyr-head of our fragment appeared as a shield device represented in relief. The same motive appears on a vase by Euthymedes, given in Gerhard, *Aus. Vasenb.* pl. CLXXXVIII (Fig. 28). For another instance, see *J. H. S.* 1892/3 (Vol. XIII), p. 117.

<sup>5</sup> Three instances.

<sup>6</sup> Boy of interior picture.

<sup>7</sup> Youth of interior picture.

<sup>8</sup> Ten out of fifteen have it.

<sup>9</sup> Seven are solid dots; five are the "stitches."

<sup>10</sup> Four instances.



No. 29. This fragment is shown to be a work of Brygos by the "intense expression" exhibited by the youth at the right.

United with this peculiarity are two more general ones, namely, the narrow eye, and the representation of the hair as blond. At the left of the fragment is a female hand with a spindle. The motive of the spinning woman seems to have been a favorite one with Brygos, for it appears on two other vases of his.<sup>1</sup>

No. 30. The Brygos peculiarities presenting themselves on this vase are the "intense expression" (shown by the figure at the right, on side A), and the youthful, narrow, beady eye (present in the boy at the left, on side B).

Other characteristics shown by the vase are as follows: the thrown-back head (the figure on the exterior, side B); food-baskets hung on the wall; striped pillows hanging over the edge; figures, with disproportionately long legs, reclining on couches (man of the interior picture); the long slender lyre (but along with it are short stubby ones); figures, reclining on couches, covered to the waist with himatia; and details introduced to indicate the locality. As recurring variants of general<sup>2</sup> Brygos characteristics are to be noted the representation of one man, on side A, with a hairy body, and the drawing of the narrow eye on the youth, and the man at the right on side A, and the man at the right on side B.

No. 31. The distinguishing marks appearing here are the youthful, narrow, beady eye (boy of interior picture), and the use of dilute glaze to show shadows on columns (seen on exterior, side A).

The "pearled-edge" border appears only once out of nine possibilities. The boy of the interior picture has a snub nose. A building is designated by the use of columns. The motive of the spinning woman, noted in the consideration of vase No. 29, reappears on this vase.<sup>3</sup>

No. 32. This vase is shown to be a work of Brygos by the presence of the "intense expression" (figure at right on side A); the youthful, narrow, beady eye (on boy of interior picture); the motive of the girl standing and playing a flute before a couch on which reclines a man; and the representation of hetairae with short hair.<sup>4</sup>

The other peculiarities making their appearance are the stripe ornamented on one edge with dots, and used as a border for garments ("pearled-edge" border); disproportionately long legs and arms of figures reclining on couches (man of interior

<sup>1</sup> Vases Nos. 31 and 51.

<sup>2</sup> By "general" I mean such characteristics as are not the sole property of our artist.

<sup>3</sup> Exterior, side A.

<sup>4</sup> The character and pose of the hetaira of this vase is identical (except that the one here is undraped) with one on vase No. 7. See Fig. 17 (p. 75).



picture); the long, slender lyre; and the covering of figures, reclining on couches, with himatia draped as high as the waist.

No. 33. The thyrsos with dots around the head, which appears on this fragment, marks it as a work of Brygos.

It is to be noted that, in addition to this feature of our artist's style, there appears the motive of bending the satyr-ear out of the usual position (here it turns forward), and the representation of the hair in a loose mass.

No. 34. The Brygos characteristic appearing here is that of the "intense expression," which manifests itself in the face of Nereus.

That the episode takes place in the palace of Nereus is shown by the overturned chairs and vases. These are the details to indicate the place of action.

No. 35. The distinguishing characteristics appearing on this vase are the "intense expression" (seen in the bearded figure on side B),<sup>1</sup> and the narrow eye shown on the girl of the interior picture. The looped ankle-band appears on side A.

Other general characteristics present are the dotted stripe for the border of garments (this occurs twice on exterior, side B, and twice on the interior of the vase); the dotted ornament for garments (twice on exterior, side B, and twice in the interior); the representation of adolescent female figures (the girl of the interior picture); variety in the garments of women; the representation of some figures with blond hair (the youth on exterior, side B); the use of details to indicate locality;<sup>2</sup> the drawing of the hair in a series of egg-shaped rolls; and the loosening of the hair (shown on the female figure of the interior and the youth on exterior, side B).

No. 36. The earmarks of the work of our artist appearing on this vase are the "intense expression," and the narrow, beady, boyish eye. The first characteristic is present in six out of the eight possible instances, and the second occurs on the boy of the interior picture.

Other characteristics, of a more general nature,<sup>3</sup> are the thrown-back head (seen on the figure on side A playing the lyre); the body tilted backward (figure with lyre, on side A); the drawing of the boy's nose as snub; the long slender lyre; and details introduced to indicate locality. A variant of the hairy satyr-body appears in the case of two men who have hairy bodies.

No. 38. The interior picture of this vase shows a boy whose face has the "intense expression."

The eye is narrow and beady, and the nose is snub.

<sup>1</sup> It is not so strongly marked here as on other works of Brygos.

<sup>2</sup> Column and architrave on exterior, side A; column in the interior picture; shield and sword hung on the wall.

<sup>3</sup> That is, not confined to Brygos.



No. 39. The "intense expression" appears on the figure on this vase.

The dotted decoration for garments is used here, and details are introduced that should designate the place. But inasmuch as here the picture shows a nude woman placing her himation on a stool, the showing of a strigil and an aryballos on the wall seems to have been a bit of carelessness, or indifference, on the part of Brygos; for one would hardly look for a nude woman in a palaestra, — if such the implements are to be taken to signify. It may be, however, that they simply represent these objects as hung in a room of a house. The woman has a narrow eye.

No. 40. On side A of the exterior is drawn a girl playing a flute and looking back as she moves forward. This attitude we saw to be the sole property of Brygos. The girl who dances in the interior picture is represented with short hair. The short-haired hetaira is also a peculiarity of our artist.

On the exterior, side B, appears a youth leaning backward as he dances. In the interior picture appears a basket and a flute-case, pointing to a house scene.

No. 41. These fragments are shown to belong to a vase by Brygos through the occurrence of a nude boy wine-pourer on one of them.

Other characteristics are the snub nose, and the reclining figures draped to the waist.

No. 42. On the only figure preserved on this phiale the "intense expression" is exhibited.

The eye of the figure is narrow, and the body hairy.

No. 43. The "intense expression" makes its appearance in the figure of Priam, on side A, and particularly in the figure which is second from the left on side B. Another Brygos characteristic occurring here is the introduction of a nude boy as a wine-pourer.

Along with these peculiarities come less personal ones. They are the representation of figures, reclining on couches, as having disproportionately long legs (figure at the left on side A); the drawing of some figures with blond hair (Achilles on side A); the introduction of details to locate the scene;<sup>1</sup> the doing of the hair in a single roll at the back of the neck (the fourth figure from the left on side A); the doing of the hair in a series of egg-shaped rolls (the second figure from the left on side B); the loosening of the hair; the use of the stripe with dots on one side as a border for garments (five cases out of twelve); and the use of dots as decorations for garments. One male figure (fourth from the left on side B) is shown with a hairy body. The use of stripes to decorate pillows appears on this vase.

<sup>1</sup> Achilles reclines on a couch, before which is a table spread with dishes, while a sword, garments, and greaves hang on the wall; on side B is a column, while shields and a helmet hang on the wall.



No. 47. The figure of Hermes and the bearded figure of the interior picture exhibit the "intense expression," and Menelaus wears about his ankles, below his greaves, the looped band already mentioned.

Other characteristics are the stripe, with dots along one edge, as a border for garments (one instance); variety in garments of women; the portrayal of boyish faces with snub noses (Eros of the Ariadne picture); and the introduction of details to indicate locality.<sup>1</sup> The female, and the bearded, figures of the interior picture show the narrow eye.

No. 49. The head on fragment No. 5 shows the intense expression.

Fragments Nos. 4 and 5 show the motive of the dotted garments. Variants of characteristics appear in the representation of the pillows as striped, and the use of dilute glaze on the end of the tree on fragment No. 2.

No. 50. This vase is characterized as a work of Brygos by the "intense expression" exhibited by the bearded head on fragment 1 *b*.

No. 51. The "intense expression" of the boy marks this as a work of Brygos.

The boy is also represented with a snub nose, and both he and the girl have the narrow, beady eye. The lips of the boy are parted.

No. 52. Two Brygos characteristics appearing on this vase are the "intense expression" shown by the figure at the right on the exterior, side A, and the introduction of the nude boy as a wine-pourer. As an exception in this case two such boys as wine-pourers appear on side A, exterior.

Other characteristics are as follows: food-baskets hung on the wall (two in each exterior picture); the representation of reclining figures with very long legs and arms (the figure at the right on side A); the drawing of the boys' noses as snub; the draping of reclining figures to the waist with himatia (both interior figures, two on side A, and three on side B); the showing of both boys with blond hair; and the use of details to show locality.<sup>2</sup>

It will be noticed by consulting the vase that the end figure at the left on the exterior, side B, is so posed that one of his legs hangs over the end of the couch. This is illustrated in Fig. 29. This pose is almost duplicated on the vase given as No. 32 is illustrated in Fig. 29. This pose is almost duplicated on the vase given as No. 32 of the list appended to this monograph (p. 51). It appears in the figure next to the girl

<sup>1</sup> Column, architrave, and edge of roof on A, and the altar before the building. In the interior the rock on which Ariadne sleeps, and a tree.

<sup>2</sup> Couches, tables, skyphos on the floor, baskets on the wall.

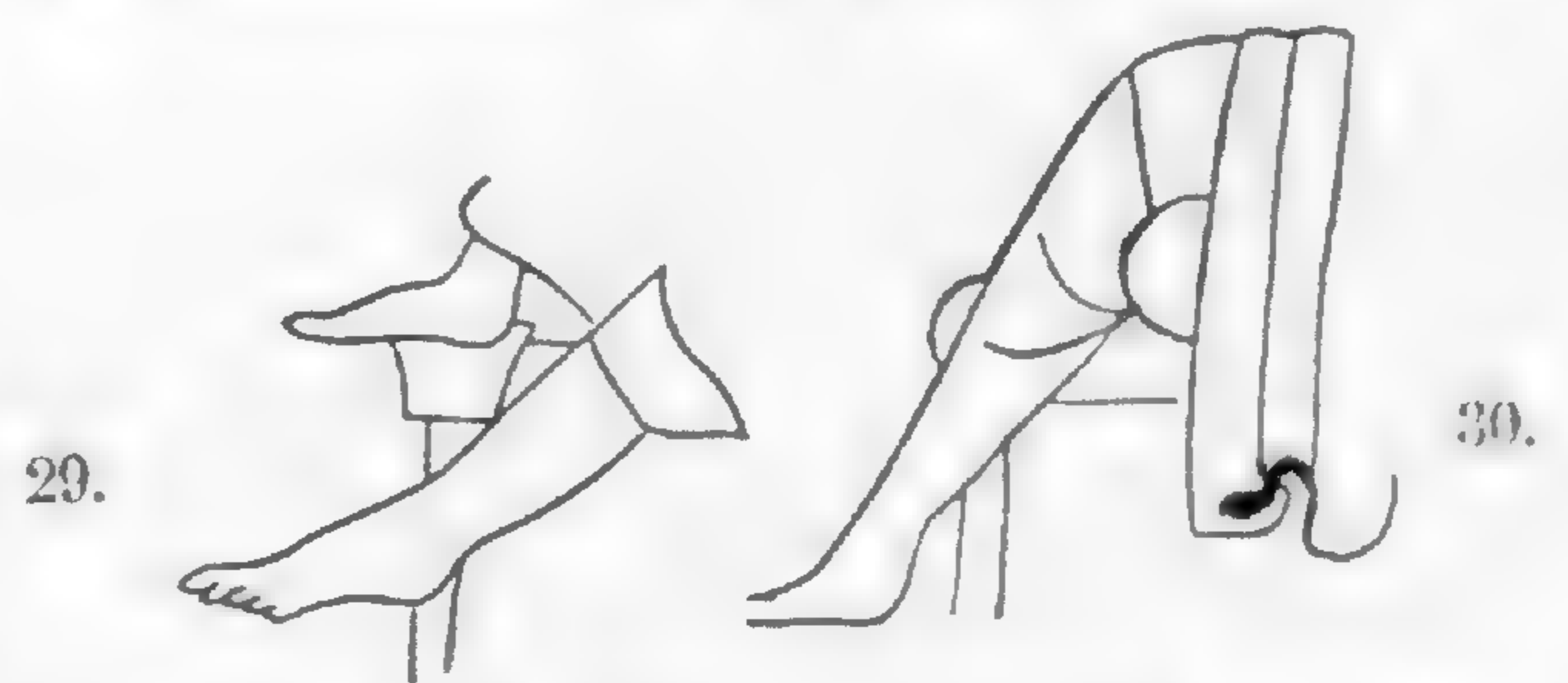

FIGURES 29-30.--CHARACTERISTICS BELONGING TO BRYGOS.

30. Lecuyer, E 5.



on side A. The position of the other leg is different; but this easy attitude is the same in both cases. It appears as given in Fig. 30.

No. 53. This vase, which is a fine example of the style of Brygos, shows the "intense expression" in every one of the four figures. As proof that the drawing of the eye is not the sole cause of it, but merely a contribution, it is to be noted that the female figure on side B shows this expression in spite of the fact that the upper part of the face is destroyed by a break.

Other characteristics occurring are the stripe, with dots on one edge, used as a border for garments;<sup>1</sup> the dotted ornamentation for garments;<sup>2</sup> the drawing of the hair as blond;<sup>3</sup> the introduction of details to show locality;<sup>4</sup> the striped sceptre;<sup>5</sup> and the hair done in a single roll at the back of neck.<sup>6</sup> As variants it may be well to note that the body of Zeus in each picture is represented as hairy, and that the hair of the woman on side B is done in a knot low on the neck.<sup>7</sup>

No. 54. There is but one figure on this vase, and the face shows the "intense expression," peculiar to Brygos, arising from the delicately drawn nostril and the drooping corner of the mouth. The narrow eye also contributes to it. The motive of the spinning woman appeared on the vases numbered 29 and 31 of the appended list.<sup>8</sup> The use of the dotted stripe for a border, and the dotted ornamentation (here fine dots) make their appearance on this vase.

No. 55. The appearance of the "intense expression," and the motive of the female flute-player standing before reclining men mark this as a vase by Brygos. The youthful wine-pourer, making his appearance as a nude boy, is also present. But in this case he does not hold a jug, kyathos, or strainer, but is busy with a large amphora which rests on the ground.

Other motives occurring are the thrown-back head; the food-baskets hanging on the wall; the drawing of reclining figures with disproportionately long legs and arms; the long slender lyre; the draping of reclining figures to the waist with himatia; and the introduction of details to show the place. The pillows are striped, but they do not hang over the edge, — for the reason that the figures recline on the ground.

<sup>1</sup> On the himation of Zeus on side A.

<sup>2</sup> As heavy dots on the himation of Zeus on side A, and that of the female on side B; as "stitches" on himation of boy on A, and on that of Zeus on B.

<sup>3</sup> Female on side B.

<sup>4</sup> On side B an altar and a palm-tree.

<sup>5</sup> Held by Zeus on side A.

<sup>6</sup> On the figure of Zeus on each side.

<sup>7</sup> See p. 77, characteristic No. 4.

<sup>8</sup> Mr. Cecil Smith notes, in describing this vase (B. M. D 13), that "the type of face is very similar to that of Hera" on vase No. 8 of our list of signed vases.



No. 56. This vase is proved to be a work of our artist by the "intense expression" conspicuous in the figure of the maker of the chest.

The characteristic of the hair done in a series of egg-shaped rolls is present in the figure of Perseus.

No. 57. Although only the end of the nose, with the nostril, and the lips of the figure of Achilles are preserved, yet the expression is so "intense" that there seems to be no question that this vase is a work of Brygos.

Other characteristics appearing are the use of dots as ornaments for garments<sup>1</sup> (this time as circles); the use of details to indicate the locality;<sup>2</sup> and the drawing of the hair in a series of egg-shaped rolls.<sup>3</sup> The meander around the interior picture is the same that appears on No. 1 of our list. The eye of Hekabe seems to have been narrow, but the vase has been so badly weathered that it is impossible to be certain.

No. 58. This vase is identified by the "intense expression," and narrow eye of the boy.

Another characteristic appearing is the snub nose.

No. 60. The vase is shown to have been done by Brygos by the dotted thyrsos that the Maenad carries.

The satyr that pursues the Maenad has a hairy body. The motive of the thrown-back head appears on the figures of both satyrs. The spirit of the composition is very lively. The scene finds a very close analogy in the London kylix, where the satyrs attack Hera and Iris. The racing, and the crouching satyr both appear there—as here. The Maenad, and the pursuing satyr, on our vase have the parted lips, which is a favorite trait of Brygos' figures.

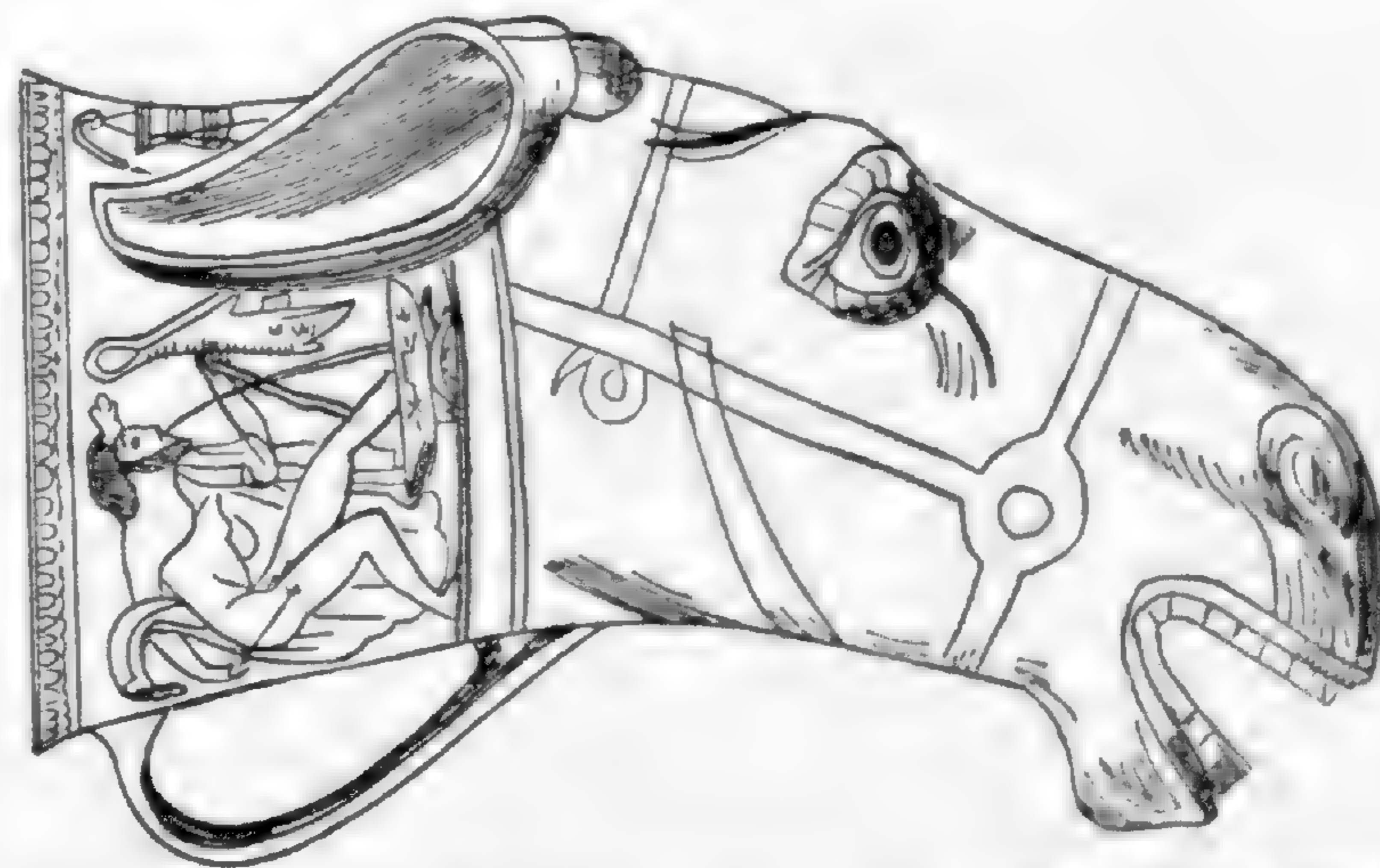

FIGURE 31. — VASE ILLUSTRATED IN THE *Compte-Rendu*, 1881 (TITLEPAGE).

By means of this vase I am able to attribute to Brygos a vase which, to my knowledge, has not yet been assigned to him. It is illustrated in the *Compte-Rendu*, 1881 (titlepage): See Fig. 31. The form of the vase is the same as that of No. 61 (in Boston), both being rhyta in the form of horses' (or mules') heads. A comparison of the two shows striking likenesses in the matter of decoration. Thus both have the same strap passing around the muzzle of the horse, and secured to a ring from which another strap is carried back along the side

<sup>1</sup> On the figure of Hekabe.

<sup>2</sup> The walls of Troy, with the gates, are shown, and by one gate a tree—showing the Skaean Gate (?).

<sup>3</sup> To be seen in the figures of Priam, Hekabe, and Empedion.



of the head. The strap that comes from underneath the head overlaps this first strap in the same manner on both vases. Furthermore, both horses have a foretop, and there is a tongue-pattern around the lip of both vases. The picture decoration of the St. Petersburg vase, like that of the Boston rhyton, is on the bell mouth growing out of the horse's head. The subject is a symposium scene. A bearded man, holding a straw in his right hand, vomits into a basin which rests on the ground before him, while a beardless youth (nude) kneels, playing a flute, and another nude youth dances, balancing a skyphos on his foot. On both vases the handle and the horse's ears divide the picture into three sections. The kneeling youth has the narrow beady eye, and the delicate nostril. The eye of the other youth is not so markedly narrow. Behind the fluting boy is a leaning staff from which hangs a basket. There is a strong resemblance between the basin with its tripodic support and that on the kotyle illustrated in the *Mon. d. Inst.* VIII, pl. XXVII. However, until I may see the vase itself, or an accurate photograph of it, I hesitate to list it with the other vases by Brygos.

No. 62. The "intense expression" and the narrow beady eye of the girl of the interior picture mark this vase as a work by Brygos.

On three other vases by Brygos (Nos. 16, 58, and 62) appear kettles with handles and bails similar to the one on this vase.

No. 62. This vase is to be assigned to Brygos by means of the characteristic of the short hair.

Other characteristics appearing on the vase are the beady eye, the fine nostril, and the somewhat adolescent appearance of the figure. It is interesting to note that the motive of the nude woman about to lay down her clothes appears on vase No. 39, and that the pail with the peculiar form of bail is found on vases 16, 58, and 61. A basin somewhat like that on this vase occurs on the rhyton illustrated in Fig. 30.

By means of the ten characteristics<sup>1</sup> found on the works signed by Brygos, but on those of no other artist, and by the use of new Brygos peculiarities, discovered on some of the vases assembled, through the original ten means of identification, fifty-two vases have been added to the list of Brygos' works. It now remains to gather together into groups motives which, individually, not the sole property of our artist, by frequent repetition as groups form as it were new characteristics.

The motive of the figure shown with loosened hair appeared, as we have seen, on the vases numbered 1, 3, 4, 5, 7, and 8 of the signed vases, and on 18, 24, 33, 35, 43, and 48 of the unsigned vases; the representation of the hair in a series of egg-shaped rolls appeared on vases numbered 10, 17, 43, 48, 56, and 57; the hair drawn as a single roll at the back of the neck occurred on vases numbered 1 and 53. The narrow eye, including its occurrence on mature as well as youthful figures, manifested itself as a motive on thirty-five vases attributed to Brygos. The combination of the three motives of the loosened hair, the hair shown in a series of egg-shaped rolls, and

<sup>1</sup> Pp. 80, 81.



the narrow eye is to be found on No. 35 of the list of vases. Now these last mentioned characteristics are all present on vase No. 2. The fact that one of them, namely, the loosened hair appeared on thirteen of Brygos' vases, the hair in egg-shaped rolls on four, and the hair in a single roll on the neck on two vases, points strongly to Brygos as the maker of the vase. The combination of the motives of the narrow eye, the hair in a series of egg-shaped rolls, and the loosened hair occurred, as we saw, on vases Nos. 2 and 35. So we may consider this group as constituting one of the means of identifying vases to be classed as those of Brygos.

Next to the characteristic of the narrow eye, Brygos showed his love for the "intense expression," and the introduction of details to designate locality. The former of these characteristics appears on thirty-four of his vases, the latter on thirty-five vases attributed to him. The motive of the head thrown far back, and the representation of the hair as blond recur many times, — the former being found on nine vases, the latter on eleven vases assigned to our artist. The combination of the motives of the head thrown far back, the representation of the hair as blond, and the use of details to show locality makes its appearance on vase No. 7; that of the thrown-back head, and the blond hair on vases numbered 5 in the list of signed works, and on 7 and 19 of the unsigned; that of the blond hair, and the use of details to show locality on Nos. 8 (signed vases); and 7, 19, 34, 35, 46 of the unsigned. The group of the motives of the blond hair, the thrown-back head, and the use of details to show locality all occur on vase No. 3 of the list. The fact that the same group appears on vase No. 7, and that the individual members of the group appear on so many vases of our artist would point to this group as another means of recognizing a vase by our artist.

Vase numbered 44 of the list shows a large number of characteristics appearing on various vases of Brygos. These characteristics are the use of dots to ornament garments; the motive of the head bent far back; the hanging of food-baskets on the wall; the drawing of the pillows as striped and hanging over the edge; the draping of reclining figures to the waist with himatia; and the use of details to indicate the locality. Of these the group made up of the first, fourth, fifth, and sixth characteristics occurs on vases numbered 18, and 20; the group made up of the second, third, fourth, fifth, and sixth on Nos. 30 and 55. We have seen that the second, namely, the motive of the thrown-back head, occurred on eleven vases by our artist; the use of details to indicate locality on thirty-five vases. The use of dots as an ornament for garments appears on twenty-two vases; the food-baskets hanging on the wall on seven; the striped pillows on five, and the covering of reclining figures to the



waist with himatia on eight. The presence on the vase No. 44 of characteristics which appear individually on many vases of Brygos, and as groups on six works warrant using these groups as means of identifying Brygos' vases.

The combination of the narrow eye (mature as well as youthful), the introduction of details showing locality, and the representation of the hair as loosened, appears on Nos. 4, 5, and 8 of the signed vases, and on 18 and 35 of the unsigned. The same group appears on vase No. 46, and on the strength of its presence on vases ascertained to be by Brygos, this vase, too, is to be assigned to him.

Vase No. 48 shows, for characteristics, the dotted stripe as a border for garments;<sup>1</sup> the dotted ornament for garments;<sup>2</sup> the use of details to indicate locality;<sup>3</sup> the sceptre wound with a fillet;<sup>4</sup> the hair done in a series of egg-shaped rolls;<sup>5</sup> and the motive of the loosened hair.<sup>6</sup> The combination of the first, second, and fifth of these characteristics appears on vases Nos. 17 and 35; the second and fifth on vases Nos. 10 and 57; the first, second, and fourth on Nos. 4 and 8 of the signed vases, and No. 53 of the unsigned; the second and fourth on Nos. 1, 3, 4, and 8 of the signed vases, and No. 53 of the unsigned.

The group of motives made up of the head thrown far back, the long slender lyre, and the use of details to indicate locality, appears on vases Nos. 30, 36, and 55. The repetition of this group on vases known to be Brygos' justifies the assignment of this vase to our artist.

Vase No. 59 shows the characteristics of the stripe with dots on one edge as a border for garments; variety in women's garments; of details to indicate locality; and the sceptre bound with a fillet.

All of these peculiarities appear on No. 4 of the signed vases, and Nos. 15 and 48 of the unsigned. The combination of variety in women's garments, details to indicate locality, and the sceptre with a fillet bound around it, occurs on No. 1 of the signed, and No. 35 of the unsigned; that of the border dotted on one edge, variety in women's garments, and the sceptre bound with a fillet, on No. 18; that of the dotted border, variety in women's garments, and the use of details to indicate locality, on No. 47; that of the dotted border, the use of details to show locality, and the filleted sceptre, on No. 8 of the signed vases. The vase seems, then, to be Brygos'.

<sup>1</sup> On girl of interior picture.

<sup>2</sup> Male figure of interior picture, and two figures on the exterior, side B.

<sup>3</sup> Column in interior picture, and on exterior, side B.

<sup>4</sup> Two on exterior, side B.

<sup>5</sup> Youth on exterior, side B.

<sup>6</sup> Two figures on side A, two on B, and female of interior.



To summarize, then: the *groups* of additional characteristics so far established, by which five new vases have been added to the list of Brygos' works, are as follows:<sup>1</sup>

1. The hair is drawn in a series of egg-shaped rolls, the eye is narrow, and the hair is loosened.
2. The head is thrown far back, the hair is blond, and details show the place represented.
3. The head is thrown far back, and the hair is blond.<sup>2</sup>
4. The hair is blond, and details show the place represented.
5. The garments are ornamented with dots, pillows are striped and hang over the edge, figures reclining on couches are draped to the waist with himatia, and details show the place represented.
6. The head is thrown far back, food-baskets hang on the wall, the pillows are striped and hang over the edge, figures reclining on couches are draped to the waist with himatia, and details show the place represented.
7. The eye is narrow, the hair is loosened, and details show the place represented.
8. The stripe dotted along one edge is used as a border for garments, the garments are decorated with dots, and the hair is drawn in a series of egg-shaped rolls.
9. The garments are dotted and the hair is drawn in a series of egg-shaped rolls.
10. The stripe dotted along one edge is used as a border for garments, the garments are decorated with dots, and the sceptres are wound with a fillet.
11. The head is thrown far back, the lyre is long and slender, and details show the place represented.

During the investigation of the characteristics of Brygos it must have become evident that the artist was bound to his contemporaries by many stylistic peculiarities. Dümmler (*Bonner Stud.* p. 70) notes the connection of Brygos with Hieron, and

<sup>1</sup> It would be possible, of course, to go on multiplying almost to infinity the possible combinations of characteristics that might be compiled from the list of peculiarities assigned to Brygos. A comparatively extended list of combinations — which does not by any means pretend to be complete — is given on later page (p. 101). It is not claimed that the groups of characteristics given in this list are the sole property of Brygos. They may, or they may not, be so; for in order to verify each group there would be the necessity of taking it through the works of all the vase painters contemporary with Brygos, to see if it appeared on the works of any of these artists. That would mean the consideration of each artist as carefully as Brygos has been treated, and, were this done, the present monograph would be not a treatise on the style of Brygos, but a minute handbook of all the painters of the period, which is beyond the plan laid out here. I have, therefore, confined my attention to such groups as appear on vases that from time to time have been attributed to Brygos, vases that possessed no individual characteristics of his. These groups have been shown to be present on vases known to have been done by our artist. They do not, to my knowledge, appear on the works of other artists.

<sup>2</sup> This is a variant of No. 2. It is to be understood that while made up of characteristics found in No. 2, it appears on vases that the larger group No. 2 does not fit.



Wernicke, in his *Griechische Vasen mit Lieblingsnamen*, p. 15, recognizing the resemblance between the styles of these artists gives our vase, No. 19 to Hieron. It is likewise noted by Reisch in the *Führer öffentl. Samml. Rom.* p. 231, that Hieron, Duris, Euphronios, and Brygos are intimately related in matters of style. This same opinion is to be found in Harrison and MacCall, *Greek Vase Paintings*, p. 23. But in none of these instances is the relation extended to the "Master with the Twig" and the "Master with the Bald Head" as our investigation warrants.

These associations would fix the approximate date of Brygos between 500 B. C., the probable earlier date of Euphronios, and 480 B. C. That Brygos was active before the latter date is proved by the discovery of fragments of his vases in the débris of the Acropolis occasioned by the Persians when they pillaged Athens. The fragments are those given by Winter<sup>1</sup> in the *Jb. d. Arch. Inst.* 1887, pp. 230 and 231, and the so-called Ross fragment (Ross, *Archäol. Aufs.* pl. X).<sup>2</sup> It is possible to date Brygos even more closely, if we associate the name Orsimenes, which appears on the Iliupersis kylix, with the one occurring on a vase by Euthymides (Munich, No. 374, Klein, *Meistersig.* p. 195, 3, and Hoppin, *Euthymides*, pl. 2). Kretschmer (*Die Griechischen Vaseninschriften*, p. 180), in considering this name as it appears on the Iliupersis kylix, leaves the choice open. It may be, he says, either 'Οψιμί[δων], 'Οψιμέ[νης], or 'Ορσιμέ[νης]. The second name does not appear in literature (Urlichs, *Beiträge zur Kunstgeschichte*, p. 65). The first, which is the name of the brother of Akamas, might stand. But the letters, as they appear on the vase, point to the third reading, and, inasmuch as this name does occur on a vase by Euthymides, it seems reasonable to choose this reading. Klein accepts this form of the word in his *Meistersignaturen*, p. 175. Hoppin places the date of the florescence of the style of Euthymides at 500 B. C. If then we look on the name Orsimenes as a *καλός* name, and accept ten or twelve years as the period covered by the *καλός* name, Brygos would be dated in the neighborhood of 490 B. C. — probably between 490 and 485 B. C. His more developed style would demand that he should be placed somewhat later than Euthymides, and so we set him at the outer limit of the period covered by the "love name."

The question now arises whether Brygos worked entirely alone, or in conjunction with another artist. It is to be noted that on all of his signed vases his signature is invariably with *ἐποίησεν*. If now we are to distinguish between the words *ἔγραψεν* and *ἐποίησεν*, — as is now the tendency among archaeologists, — it would mean that Brygos was a maker, a potter, and not a painter. If this is so, we might expect the name of a co-worker to appear on some of his vases. Such a signature does appear on a frag-

<sup>1</sup> Wrongly assigned by him to Duris (*op. cit.* p. 229). Cf. *J. H. S.* 1891, p. 335 (Hartwig).

<sup>2</sup> *Erste Sammlung*, 1855.



ment done in the style which we recognize as that of Brygos. The fragment is now in Ashby Castle, England. It is cited in the *Arch. Zeit.* 1846, p. 342, and the inscription, which is incomplete, reads *οδωρος ἔγραψε*. Klein describes the fragment in his *Meistersignaturen*, pp. 218 and 219, where he gives the signature as shown in our Fig. 32, and suggests the restoration of the name as Theodoros. Furtwängler, in discussing it in the *Arch. Zeit.* 1881, pp. 302 and 303, asserts that the style of the drawing is most closely allied to that of Brygos. His reading is given in Fig. 33. Were it not that the style of Apollodoros differs from that which we know as the style of Brygos, there would be a temptation to restore the name as Apollodoros, the vase painter of the severe red-figured style.<sup>1</sup>

Attempts have been made to arrange the signed works of Brygos chronologically. Klein (*op. cit.* pp. 175–184) places the Wurzburg kylix<sup>2</sup> (given in the *Weiner Vorlegebl.* VIII, 5) as the earliest of his vases, and the London kylix<sup>3</sup> (*Mon. d. Inst.* VIII, pl. XLVI) as the latest. In the former, says Klein, the wavy outline of the hair goes back to the wavy, incised outline of the black-figured style. Such a means for distinguishing the earlier from the later works will not do, for on other vases signed by Brygos the later method of outlining the hair by dots occurs on the same vase with the wavy outline. The use of the four-barred sigma would tend, as Klein well says, to put the vase late in the list of the works of Brygos. The great freedom in the use of gold would seem to point toward the height of his mastercraftmanship. The employment of gold is less conspicuous on the Iliupersis kylix,<sup>4</sup> and the fewer number of four-barred sigmas coupled with this fact, while placing the vase toward the end of his career, would date it somewhat before the London kylix. The four-barred sigma

32. ... ΔΟΡΟΣ ΕΛΡΑΦΙΣΕΜ  
 33. ΘΔΟΡΟΣ ΕΛΡΑΦΙΣΕΜ  
 34. ΠΙΠΠΟΣ ΚΑΛΙΣΤΟ  
 35. ΠΙΠΠΟΣ ΚΑΛΟΣ  
 36. ΔΕΜΟΜΙΧΟΣ  
 37. ΑΡΙΣΤΟΚΡΑΤΗΣ  
 38. ΝΙΚΟΠΙΛΕΚΑΙΕ  
 39. ΔΙΠΙΠΟΣ ΚΑΛΟΣ  
 40. ΗΟ ΓΑΙΣ ΚΑΛΟΣ  
 41. (  
 42. ΒΔΒΔΚΧΟΣ  
 43. ΟΓΣΙΜΕ...  
 44. Α.ΥΜΑΧΟΣ  
 45. ΔΝΡΟΜΑΤΕ

FIGURES 32–59. — INSCRIPTIONS (EXCEPT 41) ON VASES BY BRYGOS.

<sup>1</sup> Hartwig, *Meisterschalen*, pl. LXIX, assembles this fragment with others that he assigns to Apollodoros, but the style is different. If they are works of the same artist, they belong to different dates.

<sup>2</sup> Our list No. 5 (signed).

<sup>3</sup> Our list No. 8 (signed).

<sup>4</sup> No. 4 of the signed vases.



does not occur on monuments much earlier than 460 B. C. But this would militate little against its frequency in handwriting and in such inscriptions as appear on vases. Its occurrence on the Iliupersis kylix would have a tendency, of course, to draw it away from 490 B. C.

Of the signed vases, five have the signature on the handle, two are signed on the edge of the foot, and in one case the place of signature is uncertain. In the early part of this century the spelling of the name of our artist troubled archaeologists. Thus in the *Arch. Zeit.* 1843, p. 141, the name is read as Prylos, and in the *Bull. d. Inst.* for the year 1843, on p. 71, we find a discussion of the Iliupersis wherein the name is given as Brylos. The latter reading appears also in 1856 in an article by De Witte in the *Ann. d. Inst.* p. 81. Here, in treating of the kylix with the Judgment of Paris<sup>1</sup> (*Mon. d. Inst.* 1856, pl. 14), he says that the vases with the signature of Brylos are rare. In speaking of another vase, in the collection of the Duc de Luynes, he suggests the possibility of restoring the incomplete name on the handle as Bryaxis. On p. 86 of the *Ann. d. Inst.* for 1856, De Witte rightly recognizes the name to be Brygos.<sup>2</sup>

From the name Brygos itself attempts have been made to locate the home of the artist. Kretschmer (*Griech. Vaseninsch.* p. 75) says that Brygos probably came of the Thracian stock of the Brigoi. Strabo (XII, 550) gives Brygoi, Bryges, and Phryges as equivalent one to the other,<sup>3</sup> and Hesychius (*s. Βρύγες*) states that according to some the Bryges are the same as Phryges. The fact that the name Brygos is similar to Bryges may point to a northern origin for our artist. But nothing more definite than this can be drawn from the resemblance of the two names.

Not only from the spelling of the name does it appear that Brygos was not an Athenian, but certain peculiarities also of orthography occurring on a vase,<sup>4</sup> which, though unsigned, belongs to him, point to a non-Attic origin. The vase is of exquisite technique, and belongs well in the best period of the career of Brygos. The decorations are as follows: On the interior is represented a girl dancing before a youth who reclines on a couch. In the field is an inscription (Fig. 34. *Pilipos* should be retrograde). On the exterior, side A, are represented a bearded man and a youth, reclining on couches. Before the man stands a girl playing a flute, and at the foot of the couch of the youth sits a woman. At the left near a column stands a boy with a lyre. In the field before the boy is an inscription (Fig. 35), over the youth is another (Fig. 36), and above the man is still another (Fig. 37). On side B is a similar scene with a nude

<sup>1</sup> No. 3 of our list (p. 102). Gerhard, *Aus. Vasenb.* I, p. 217, reads Brylos on our vase No. 2.

<sup>2</sup> This is the first recognition of the correct spelling of the name.

<sup>3</sup> ὁμοίως δὲ καὶ Βρύγοι καὶ Βρύγες καὶ Φρύγες οἱ αὐτοί.

<sup>4</sup> No. 18 of our list of unsigned vases.



boy as a wine-pourer at the left, instead of the boy with the lyre. He leans with his right hand against a column. Over the woman on the couch of the youth is an inscription (Fig. 38), over the bearded man is another (Fig. 39), and before the pourer yet another (Fig. 40).<sup>1</sup>

A point of interest to us lies in the use of  $\pi$  for  $\phi$  in the words Philippos, Philon, Nikophile, and Diphilos. The lack of aspiration points to a non-Attic mode of speech. Dümmler (*Berlin Philol. Woch.*, 1888, p. 20) says that "this  $\psi\iota\lambda\omega\tau\eta\varsigma$  is certainly not an Athenian," and, because of the substitution of  $\pi$  for  $\phi$  gives Macedonia as Brygos' native country. But in making this choice he is bound to account for the fact that Brygos, being a Macedonian, used  $\pi$  instead of  $\beta$ ; for Eustathius (*on the Odyssey*, 1618, 43) says that in Macedonia  $\Phi\acute{\iota}\lambda\iota\pi\pi\omicron\varsigma$  was written  $\text{B}\acute{\iota}\lambda\iota\pi\pi\omicron\varsigma$ , and  $\text{P}\alpha\lambda\lambda\eta\gamma\eta\nu\iota\kappa\acute{\omicron}\nu$  occurred as  $\text{B}\alpha\lambda\lambda\eta\gamma\eta\nu\iota\kappa\acute{\omicron}\nu$ .<sup>2</sup> Dümmler meets this difficulty by suggesting that Brygos, through his stay at Athens, came to recognize the Athenian practice of aspirating, but, being unable to drop the plain Macedonian pronunciation with  $\beta$  in the place of  $\phi$ , tried to compromise by using the midway letter  $\pi$ . This is, of course, purely theoretical on the part of Dümmler, and is recognized as such by Kretschmer on p. 81 of his *Die Griechischen Vaseninschriften*.

Kretschmer ventures another solution which is as impossible as that of Dümmler. Brygos, he maintains, may have come from Crete, where, in want of a special letter, the sound of  $\phi$  was expressed by  $\pi$ . This view that  $\pi$  took the place of  $\phi$  is held also by G. Meyer (*Griechische Grammatik*<sup>3</sup>, pp. 280–281), who says that in the Gortyn inscription  $\pi$  stands in place of the lacking  $\phi$ . Ernst Herforth as well (*De Dialecto Cretica*, pp. 237–238) holds that  $\pi$  filled the place of  $\phi$  in this inscription, and Cauer (*Delectus Inscriptionum Graecarum*, p. 68) agrees with him. An opposite stand is taken by H. Helbig (*De Dialecto Cretica Quaestiones Grammaticae*, p. 13), who says, "Cretas amantissimos fuisse aspirationis haud paucae voces e titulis non minus quam ex Hesychi imprimis glossario sumendae edocent," and, on p. 16, he goes on to say that it is a mistake to think that aspiration was lacking at the time of the Gortyn inscription. For, says he, the letter  $\theta$  occurs in the inscription, and, while the form  $\phi$  is absent, a form (Fig. 41) does occur which must be read as  $\phi$ , unless instead of  $\text{F}\alpha\iota\sigma\tau\iota\acute{\alpha}\omega\nu$  we wish to read  $\text{P}\alpha\iota\sigma\tau\iota\acute{\alpha}\omega\nu$ , which is wrong. Moreover, by the acceptance of this

<sup>1</sup> In the *Arch. Zeit.* 1851, p. 367, Birch makes an attempt to associate some of the names on this vase with historical characters. According to him, Diphilos is to be connected with the comic poet of that name (320 B. C.), and Demonikos with another comic poet whose date is unknown. O. Jahn (*Dichter auf Vasenbildern*, p. 749; *Abhandl. der Sachs. Gesellschaft*, 1861) has shown the futility of such an attempt. The relative dates of the poet Diphilos and the known date of Brygos make such an association, of course, impossible.

<sup>2</sup> Hoffmann, *Griechische Dialekte*, II, p. 508. "The name (Thess.)  $\text{B}\epsilon\rho\acute{\epsilon}\kappa\kappa\alpha\varsigma$ , Aeol.  $\text{B}\epsilon\rho\epsilon\nu\acute{\iota}\kappa\alpha$ , belongs to the Macedonian dialect, which changed the middle aspirate ( $\phi\epsilon\rho\epsilon$  = ssk. bhara) to the medial."



letter as  $\phi$ , such words as  $\acute{\alpha}\nu\kappa\alpha\nu\acute{\alpha}\mu\epsilon\nu\omicron\varsigma$  and  $\acute{\alpha}\nu\kappa\alpha\nu\tau\acute{\omicron}\varsigma$ , which occur in the Gortyn inscription, become intelligible in the forms  $\acute{\alpha}\nu\phi\eta\nu\acute{\alpha}\mu\epsilon\nu\omicron\varsigma$  and  $\acute{\alpha}\nu\phi\alpha\nu\tau\acute{\omicron}\varsigma$ . This view that  $\phi$  was present in the Cretan dialect is upheld by M. Kleemann (*Reliquiarum Dialecti Creticae — Pars Prior; Glossae Creticae*), who quotes on p. 24, from Athenaeus (XI, 783 E)  $\acute{\alpha}\nu\acute{\alpha}\phi\alpha\iota\alpha \cdot \eta \theta\epsilon\rho\mu\omicron\pi\omicron\tau\iota\varsigma \pi\alpha\rho\acute{\alpha} \text{Κρησίν}$ , on p. 25,  $\acute{\alpha}\pi\omicron\phi\lambda\acute{\alpha}\sigma\alpha\iota \cdot \rho\omicron\chi\acute{\alpha}\sigma\alpha\iota \cdot \text{Κρηήτες καὶ Σάμιοι}$ , and on p. 44,  $\phi\iota\lambda\acute{\eta}\tau\omega\rho \cdot \acute{\epsilon}\rho\alpha\sigma\tau\acute{\eta}\varsigma$ . Even if we lacked this proof it would be very unlikely that at so late a date as that of our vase, when the Greek dialects had become nearly crystallized, the Cretan alphabet should lack the Ionic aspirate.

In the *Bull. d. Inst.* 1858, p. 180, 27, Conze gives an Attic grave inscription with the spelling  $\text{Εὐποροσύνη}$ , which Roscher (*De Aspiratione Vulgari*, p. 88) wrongly quotes as  $\text{Εὐπροσύνη}$ . We might be tempted to use this as evidence that at Athens the letter  $\pi$  was sometimes substituted by an illiterate stone-cutter for the correct form  $\phi$ . Granting this, it would be easy to carry our argument a step further, and claim that the use of  $\pi$  for  $\phi$  on the London kylix was due to ignorance on the part of Brygos. Such is not likely the case, however, for the absence of misspelling (*i. e.*, the wrong use of  $\pi$  and  $\phi$ , etc.) on other vases of Brygos precludes this possibility.<sup>1</sup> It is an instance of misspelling in the sense that our artist clung to the orthography of his native tongue instead of adopting that of Athens. That foreigners at Athens experienced difficulty with the aspirates, and not only left them out, as we learn from Aristophanes,<sup>2</sup> but introduced them where they did not belong, is shown by Plato (*Cratylus*, 406 A), who has Socrates, in speaking of the character of Leto, say,  $\acute{\iota}\sigma\omega\varsigma \delta\acute{\epsilon} \acute{\omega}\varsigma \omicron\acute{\iota} \xi\acute{\epsilon}\nu\omicron\iota \kappa\alpha\lambda\omicron\upsilon\sigma\iota \cdot \pi\omicron\lambda\lambda\omicron\iota \gamma\acute{\alpha}\rho \text{Ληθῶ} \kappa\alpha\lambda\omicron\upsilon\sigma\iota\nu$ .

The solution of the question of the native country is yet to be discovered. It would seem that Brygos was a foreigner, and that he came from some country that lacked the aspirate. But barring the possibility that the form of his name may point to a northern origin, it is impossible to name his country.<sup>3</sup>

<sup>1</sup> On the interior picture of No. 57 of our list occur the names Empedion and Phanas. Here, if anywhere, it seems to me, was a chance for Brygos to confuse the use of  $\pi$  and  $\phi$ .

<sup>2</sup> The use of  $\pi$  for  $\phi$ , and of  $\tau$  for  $\theta$ , seems to have been the means employed by Aristophanes in designating any "barbarian." Thus Triballos (*Birds*, 1679) says  $\theta\rho\iota\tau\omicron$ , and the Scythian in the *Thesmophoriazusae* (1001 and 1007) uses  $\acute{\alpha}\iota\tau\rho\acute{\iota}\alpha\nu$  and  $\pi\acute{\omicron}\lambda\acute{\alpha}\xi$ .

<sup>3</sup> On vase No. 8 appears a satyr with the name Babakchos. The reading of this name given in the *Mon. d. Inst.* VIII, 46, is shown in Fig. 42. Had this been correct, there might have been some reason for associating it with the name Sabazios, which is Phrygian. This would have fitted nicely with the name Brygos, which seems connected with Bryges or Phrygos. But a personal study of the vase showed the first letter to be B (as the *Brit. Mus. Cat.* notes) and not  $\Sigma$ . This leaves two possible explanations: first, that the spelling is due to dittography, or that the word is to be associated with  $\beta\alpha\beta\acute{\alpha}\kappa\tau\eta\varsigma$  (Hesychius, *s.*  $\beta\alpha\beta\acute{\alpha}\kappa\tau\eta\varsigma \cdot \acute{\omicron}\rho\chi\eta\sigma\tau\acute{\eta}\varsigma, \acute{\upsilon}\mu\nu\omega\delta\acute{\omicron}\varsigma, \mu\iota\tau\iota\acute{\omega}\delta\eta\varsigma, \kappa\rho\acute{\alpha}\upsilon\gamma\alpha\sigma\omicron\varsigma \cdot \acute{\omicron}\theta\epsilon\nu \kappa\alpha\acute{\iota} \text{Βάκχος}$ ; and *Etym. Mag.* p. 183, 45,  $\beta\alpha\beta\acute{\alpha}\kappa\tau\eta\varsigma \cdot \acute{\omicron}\rho\chi\eta\sigma\tau\acute{\eta}\varsigma$ , etc.). But neither of these throw any light on the birthplace of Brygos. Nor does the Doric spelling Phanas on vase No. 58, for this use of  $\alpha$  is not confined to one place, but spreads through all the places of Aeolic or Dorian stock.



Some combinations of characteristics appearing on the works of Brygos:<sup>1</sup>

- Combination 4, 10, 19, 29. Vases 1, 4, 8 signed; 8, 13, 16, 17, 20, 26, 27, 28, 30, 35, 39 unsigned.
- “ 4, 10, 19. Vases 1, 4, 5, 8 signed; 8, 13, 16, 17, 20, 26, 27, 35, 39 unsigned.
- “ 10, 19, 20. Vase 5 signed; 8, 13, 16, 19, 20, 21, 27, 28, 36, 38, 47 unsigned.
- “ 19, 20, 29. Vases 8, 13, 16, 19, 20, 21, 26, 27, 28, 36, 38, 47 unsigned.
- “ 3, 10, 19. Vases 4, 5 signed; 8, 13, 17, 27, 31, 35, 47 unsigned.
- “ 10, 20, 29. Vases 8, 13, 16, 19, 20, 21, 27, 28, 36, 47 unsigned.
- “ 3, 10, 29. Vases 5, 8 signed; 13, 17, 21, 26, 27, 28, 31, 35, 47 unsigned.
- “ 4, 10, 20. Vase 5 signed; 8, 13, 16, 20, 27, 31, 39 unsigned.
- “ 3, 4, 10. Vases 4, 5, 8 signed; 13, 17, 26, 27, 28, 35 unsigned.
- “ 10, 19, 29. Vases 19, 21, 31, 34, 36, 38, 47 unsigned.
- “ 4, 10, 19, 20, 29. Vases 8, 13, 16, 20, 27, 28 unsigned.
- “ 3, 4, 10, 19, 29. Vases 4, 8 signed; 13, 17, 27, 28, 35 unsigned.
- “ 10, 19, 24. Vases 5, 8 signed; 19, 27, 29, 34, 35 unsigned.
- “ 3, 10, 20. Vase 5 signed; 13, 21, 27, 28, 47 unsigned.
- “ 3, 20, 29. Vases 13, 21, 27, 28, 31, 47 unsigned.
- “ 19, 24, 29. Vase 8 signed; 7, 19, 34, 35, 46 unsigned.
- “ 4, 10, 15, 19, 20, 29. Vases 8, 13, 16, 27 unsigned.
- “ 6, 10, 19, 20, 29. Vases 8, 13, 19, 28, 36 unsigned.
- “ 3, 10, 16, 18, 19, 38. Vase 5 signed; 17, 27, 35, 47 unsigned.
- “ 3, 4, 10, 19, 29, 38. Vases 4, 5, 8 signed; 27, 35 unsigned.
- “ 10, 24, 29. Vases 8 signed; 19, 27, 34, 35 unsigned.
- “ 4, 10, 24. Vases 5, 8 signed; 27, 35 unsigned.
- “ 10, 16, 19, 20. Vase 5 signed; 16, 27, 47 unsigned.
- “ 3, 4, 10, 18, 19, 38. Vases 4, 5 signed; 27, 35 unsigned.
- “ 4, 10, 19, 24, 38. Vases 5, 8 signed; 27, 35 unsigned.
- “ 4, 16, 19, 24. Vase 5 signed; 7, 27, 35 unsigned.
- “ 3, 4, 10, 20, 29. Vases 13, 17, 27, 28 unsigned.
- “ 3, 4, 20. Vase 5 signed; 13, 27, 28 unsigned.
- “ 19, 24, 37. Vase 5 signed; 7, 27 unsigned.

#### VASES SIGNED BY BRYGOS.

1. Kylix: Stadel'sches Institut, Frankfurt. From Vulci. Gerhard, *Trinksch. u. Gef.* pl. A, B; Urlichs, *Beiträge*, p. 75; *Wiener Vorlegebl.* VIII, 2; Klein, *Meistersig.* No. 1. Signed on the handle.

<sup>1</sup> For the sake of brevity, I have numbered the characteristics 1-31 (pp. 67-77), the sequent 1-7 (pp. 77-79) that deal with the hair, and 1-5 (pp. 79-80) the new characteristics, consecutively from 1-43.



Subject: Interior. Poseidon, carrying a trident, pursues a woman (Aithra?) to right. Exterior, A. The departure of Triptolemos. In the centre sits Triptolemos on a winged car, holding in his right hand a phiale, in his left a bunch of plants. From a house, represented by two columns, two women approach him. The first carries a flower; the second a torch. In the house a bearded man sits on a throne, holding in his left hand a sceptre, in his right a phiale. Behind the car stands a woman who reaches out a phiale to a winged female figure that carries a jug. Toward these turns a woman with torches, who stands before a full-armed warrior with a phiale in his right hand. Exterior, B. From the right, where a huge serpent emerges from a bush (the tail of the serpent extends into side A), rush two girls with flowers in their hands. From a house at the left comes a woman with outstretched arms to meet them. Behind her sits a bearded man, and a youth. The latter holds a phiale in his hand.

2. Kylix: Gerhard, *Aus. Vasenb.* p. 217. Klein, No. 2.<sup>1</sup> The place of signature is uncertain, as the vase is known only from this mention of Gerhard.

Subject: Interior. An Amazon picture. Exterior, A. A scene from the Triptolemos myth. Exterior, B. Menelaus and Helen.

3. Kylix: Louvre. *Mon. d. Inst.* 1856, pl. 14; De Witte, *Annali*, 1856, p. 81 ff.; Harrison and MacCall, *Greek Vases*, pl. XXVI; *Wiener Vorlegebl.* VIII, pl. 3; Klein, *Meistersig.* No. 3. Signed on the handle.

Subject: Interior. Apollo, with a sceptre in his left hand, stands talking to Artemis, who also stands with a bow and a quiver. Near Apollo stands a fawn. Exterior, A. The Judgment of Paris. At the right upon a rock sits Paris, singing to his own accompaniment upon the lyre. His staff leans against the rock. Near by is a palm-tree. From the left Hermes, with his kerykeion, approaches Paris leading in this order, Hera, Athena, and Aphrodite. Exterior, B.<sup>2</sup> Two youths with sceptres enter a hall, suggested by a column, where they are welcomed by a woman. Behind her is a bearded man, who points to the left to two women, one of whom is seated spinning, while the other, just about to go away, has turned toward the youths with an earnest gesture. At the right of this group is a column.

4. Kylix: Louvre. Heydemann, *Iliupersis*, pl. 1; Urlichs, *Beiträge*, pp. 61–74; Kretschmer, *Vaseninschr.* p. 180; *Bull. d. Inst.* 1843, p. 71; *Wiener Vorlegebl.* VIII, 4; Furtwängler and Reichhold, *Griech. Vasenm.* pl. 25. Klein, No 4.

<sup>1</sup> Robert (Pauly-Wissowa, *Real-Lex.* III, p. 922) says that this vase is the same as No. 1. This cannot be, because the subjects are not the same, except on the exterior side A.

<sup>2</sup> Robert (Pauly-Wissowa, III, pp. 922–925) says that the subject on side B is the return of Paris to Priam's palace. So too Engelmann (*Roscher, Lex.* I, 1968).



Subject: Interior. Briseis stands with an oenochoe before a seated, white-haired man, who reaches out a phiale to her. Exterior, A. In the centre, a youthful warrior, Orsimenes (Fig. 43), who wears a helmet, cuirass, and a sword-sheath ornamented with gold, is about to thrust his sword into a fallen, bleeding Trojan (Fig. 44), who wears only a chlamys, and has dropped his sword. To his aid rushes Andromache (Fig. 45) with a pestle raised over her head; while behind her Astyanax (Fig. 46), represented as a boy about thirteen years old, rushes to right, looking back. Behind Orsimenes, a woman rushes to left, looking back over her shoulder and crying out. Before her is a group of fighters similar to that in the centre. Before the standing warrior, according to Klein, are the letters shown in Fig. 47. These do not appear in Heydemann's plate (*Iliupersis*, pl. 1). Exterior, B. Neoptolemos (Fig. 48), full-armed<sup>1</sup> (shield device a crouching lion), has seized a boy<sup>2</sup> by the ankle and is about to dash him against Priam (Fig. 49), who is represented as a white-haired man, seated with outstretched hands on an altar. Behind the altar is a large tripod. At the left of this Akamas (Fig. 50) leads Polyxena (Fig. 51) away to the left. The latter looks back at Priam and Neoptolemos.

46. ΔΣΤΥΑΜΔΧΣ

47. ΝΚΑΞ

48. ΜΕΟΡΤΩΛ

49. ΠΡΙΑΜΟ

50. ΑΚΑΜΑ

51. ΠΟΛΥΞΕΝΕ

52. ΒΡΥ

53. ΒΡΥ

54. ΧΡΥΣΙΠΡΟΣ

55. ΙΕΥΧΞΟ

56. ΕΤΟΝ

57. ΝΕΦΞΙΣ

58. ΙΙΙΝ

59. ΑΙΟΝΥΙΟΙ

5. Kylix: Wurzburg. *Cat.* No. 346;<sup>3</sup> Hartwig, *Meisterschalen*, p. 331; Harrison and MacCall, *Greek Vases*, pls. XXV, XXVI; *Wiener Vorlegebl.* VIII, 5; Furtwängler and Reichhold, pl. 50; Klein, No. 5. Signed on the handle.

Subject: Interior. A youthful hetaira holds the head of a youth who vomits. Exterior, A. A Komos. Between a youth who strides forward, playing a lyre from which hangs a basket, and a flute-player who turns about as he plays, dance two bearded men. One of them sings. A bearded man, dancing and singing, and a youth, also dancing, follow. Exterior, B. A dancing youth looks back at his companions on side A. Before him moves to right a bearded man, who has seized by the arm an hetaira, who precedes him, and tries to take a kylix from her. In front of these is a bearded man with a stick, who hastens to a female flute-player, who, in turn, has seized the robe of a bearded man who dances before her to the right.

<sup>1</sup> On the cuirass are two gold studs.

<sup>2</sup> The boy wears a gold earring.

<sup>3</sup> I have not seen this catalogue.



6. Kylix (obscene): Florence.<sup>1</sup> Heydemann, *Dritte Hall. Winckelmannsprogramm*, p. 94, No. 43; Hartwig, *Meisterschalen*, p. 345; Klein, *Meistersig.* p. 182, No. 6. Signed on the handle.

Subject: Interior. A woman, wearing a chiton and a mantle, moves to right blowing a double flute. At her left side goes a bearded man who carries a knotted staff in his left hand, and has thrown his right arm about the woman's neck. He looks back at the woman. Exterior, A. An indecent picture containing eight men. One of them strikes his "liebling" with a slipper. Exterior, B. A similar scene between men and women.

7. Fragments of a kylix. Cabinet des Médailles, Paris. Urlichs, *Beiträge*, p. 61; *Wiener Vorlegebl.* C, 7; Klein, *Meistersig.* No. 7. Signed (Fig. 52) on the edge of the foot.

Subject: Fragment 2 *a*. The head and shoulders of a bearded figure, profile to right. A trident is held in the right hand; the left hand is raised. An himation is draped over the shoulders. Fragment 2 *b*. A winged, female figure standing to left. The figure ends at the waist. A palmette scroll appears as a border. Fragment 2 *c*. A bearded head, profile to right, looking slightly downward. Fragment 2 *d*. A female head, profile to left. Fragment 2 *e*. A stool with a cushion on it, and remains of feet in front of the stool. A scroll pattern. Fragment 2 *f*. The tip of a wing, and a small, winged figure. Fragment 2 *g*. A foot. Fragment 2 *h*. An outstretched arm, and, below it, a draped shoulder. In the field the fragmentary inscription  $\epsilon\lambda$ . Fragment 2 *i*. A scroll with the letter  $\beta$ . Fragment 2 *k*. A kerykeion. Fragment 2 *l*. A fragment with the letters (Fig. 53).

8. Kylix: British Museum. *Cat.* E, 65; Murray, *Designs from Greek Vases*, XI, 43; *Wiener Vorlegebl.* VIII, 6; Furtwängler and Reichhold, pl. 47; *Annali*, 1872, pp. 294-308; *Mon. dell' Inst.*, VIII, pl. XLVI; Klein, No. 8. Signed on the foot.

Subject: Interior. At the left sits a warrior, Chrysippos (Fig. 54), profile to right, holding a phiale out to a woman, Zeuxo (Fig. 55), who has taken his shield and fills the phiale from a kyathos. Exterior, A. Two ithyphallic satyrs (Figs. 56 and 57) have attacked Iris (Fig. 58), who flees to right, trying to free herself; one of these, Echon, has leaped upon an altar which stands in the centre, and tries to draw her to him. At the left of the altar stands Dionysos (Fig. 59), wearing an himation, a chiton, and a nebris; he watches the scene. He has a sceptre and a kantharos. A

<sup>1</sup> There are two vases, according to Hartwig, not publishable, in the Museo Tarquiniese of Corneto; he also says that in 1886, Studniczka saw an indecent kylix of Brygos in Trieste. Three other kylikes given by him are a fragment belonging to Hauser, a kylix in the Museo Corneto, and one preserved in a drawing in the Berlin Museum. For the last, see Hartwig, *Meisterschalen*, pp. 350-351.



satyr (Fig. 60) rushes by him toward the centre. Exterior, B. Four satyrs (Fig. 61) wish to seize Hera (Fig. 62), but are prevented by Hermes (Fig. 63), who stands near the centre, profile to left, and Herakles (Fig. 64), who rushes from the right to protect the goddess.

9. Handle of a kylix: Museum of Fine Arts, Boston, Van Branteghem Collection, *Sale Cat.* No. 74. Hartwig, *Meisterschalen*, p. 372.

VASES NOT SIGNED BY BRYGOS, BUT ASSIGNED TO HIM ON  
TECHNICAL GROUNDS.

1. Kylix: Cabinet des Médailles, Paris. Hartwig, *Meisterschalen*, pls. XXXII, XXXIII, 1.

Subject: Interior. Draped, bearded Dionysos, to right, playing a lyre. Two dancing satyrs, one with a grape-vine and krotala, the other with krotala in each hand. Exterior, A. Dionysos walks to right beside a mule. Before him is a satyr holding up a panther by the tail, following him is a satyr playing a lyre, and a Maenad with a thyrsos and a serpent. Exterior, B. In the centre a satyr has seized a Maenad who holds a snake and a thyrsos. A satyr with a lyre, and a Maenad precede; a Maenad, and a satyr with a flute follow.

2. Kylix: Cabinet des Médailles, Paris. *De Luynes Vases*, pls. XIX,<sup>1</sup> XX; Overbeck, *Kunstmythologie*, Atlas, pl. V, 1 a, b, c.

Subject: Interior. Poseidon attacks a fallen giant. Exterior, A. Dionysos and two youthful gods fighting with giants. Exterior, B. Poseidon, Hephaistos, and a youthful god fighting with giants. In interior (Fig. 65).

3. Skyphos: Louvre, No. 1061; Hartwig, *Meisterschalen*, p. 338.<sup>2</sup>

Subject: Symposium.

60.	ΑΡΟΜΙΙ	ΗΟΓΑΙΣΚΑΙΟΣ	68.
61.	{ΤΥΟΝ ΝΥΔΡΙΙ ΒΑΒΑΚΧΟΣ ΤΕΡΓΟΝ		
62.	ΑΡΗΗ	ΗΕΓΛΙ ΙΑ ΚΑΙΟΣ	69.
63.	{ΕΜΡΕΗ	ΓΟΕΣ ΑΑΦΛΙ	70.
64.	{ΡΗΑΡΗΗ	ΣΔ ΝΟΜ	71.
65.	ΗΟ ΑΣ {ΚΑ	ΙΣΔ ΝΟΜΟ ΚΑΙΟΣ	72.
66.	ΗΟ Γ ^ ^	ΛΕΑΡΑΣ	73.
67.	ΥΓΑΙΙΙΙ ΝΥΟΙ ΑΙΣΚΑ		74.

FIGURES 60-74.—INSCRIPTIONS ON VASES BY BRYGOS.

<sup>1</sup> The illustrations in this publication and in the *Kunstmyth.* are unsatisfactory.

<sup>2</sup> I have not seen this illustrated; my knowledge of it is derived from Hartwig's text.



4. Fragment of a kylix: Magazine of the Louvre. Hartwig, *Meisterschalen*, p. 337.

Subject: Interior. Female flute-player stands before a man on a couch. The man raises his hand over his head. Exterior, A. A man in an himation, holding a kylix; another man, and a female flute-player; remains of a third man; under the handle a slim dog.

5. Kylix: Munich. O. Jahn, *Vasensammlung zu München*, p. 98, No. 332; Thiersch, *Hell. bem. Vasen*, pl. 4;<sup>1</sup> Baumeister, *Denk.* fig. 28 (wrong colors); *Athen. Mitth.* 1881, p. 113, note; Harrison and MacCall, *Greek Vases*, pl. 15; Müller (Oesterley), *Denkmäler der Kunst*, II, 45, 573; Furtwängler and Reichhold, pl. 49.

Subject: Interior. Maenad holding panther by the leg with left hand, and holding a thyrsos in the right. Exterior, A. Bearded Dionysos, wreathed and draped, sits holding kantharos and vine. Behind him a Maenad, before him a satyr blowing flutes, followed by a Maenad. Exterior, B. Three Maenads and an ithyphallic satyr. In field (A and B) senseless inscriptions.

6. Kylix: Munich. O. Jahn, *Vasensammlung zu München*, p. 132, No. 400. Gerhard, *Aus. Vasenb.* pls. CCXXIX-CCXXX.

Subject: Interior. Two bearded men, one seated, in conversation. Exterior, A. The building of the wooden horse. In the centre, Epeios and the horse; at right, a bearded figure seated under a tree; behind Epeios is Athena; at the left, a standing, bearded figure. Exterior, B. Conversation between men and youths. On side A is the inscription, Fig. 66. On side B is the inscription, Fig. 67.

7. Kylix: Cardella. *Museo Faina*, p. 41 (No. 37); Körte, *Annali*, 1877, p. 142; Hartwig, *Meisterschalen*, pl. XXXVI.

Subject: Interior. Nude, standing, bearded man singing to music of a flute played by a girl. Table with kylix; stick with basket on it. Exterior, A. Two youths, and a bearded man singing and dancing to the bearded man's fluting. Exterior, B. Incomplete. Two youths dancing to music of a standing girl who plays a flute; lower part of a draped figure with a staff; table, column, and basket on wall.

8. Kylix: Copenhagen. Thorwaldsen Museum, No. 112;<sup>2</sup> Gerhard, *Aus. Vasenb.* pl. CCLXXXI.

Subject: Interior. Draped, seated youth looking into a kylix; standing, draped, bearded man singing. Exterior, A. Palaestic. Seated youth with standing, bearded man before him; behind him, two nude youths, one using strigil, the other putting on

<sup>1</sup> I have been unable to see this publication.

<sup>2</sup> I have not seen this catalogue.



his mantle. Exterior, B. Palaestic. Draped, bearded man dancing in presence of two youths, and a bearded man.

9. Alabastron (white ground): Berlin. *Cat. No. 2258.*

Subject: Youthful standing victor binding taenia on his head. Before him is Nike.

10. Kylix: Berlin. *Cat. No. 2293*; *El. Céram. II*, pl. CXVII, p. 388; Overbeck, *Kunstmythologie*, Atlas, pl. IV, 12 *a, b*; Daremberg et Saglio, *Dict. d. Ant.*, p. 1388, Fig. 4651;<sup>1</sup> Duruy, *Histoire des Grecs*, Vol. I, p. 761.

Subject: Interior. Selene driving biga into sea. Exterior, A. Zeus, in quadriga, with thunderbolt, and Athena and a fallen giant. Exterior, B. Hephaistos, Poseidon, and Hermes versus three giants. On side A is Fig. 68; on B is Fig. 69.

11. Kylix: Berlin. *Cat. No. 2309*; Hartwig, *Meisterschalen*, p. 372.

Subject: Interior. An old man vomiting with the help of a boy. Exterior, A. In centre, a blond, short-haired hetaira blowing a flute. At the right dances a bearded man to left, while behind him a bearded man lifts a pointed amphora. At left are two youths and a huge krater. Exterior, B. Three groups (seven figures in all) of bearded men and youths. Some dance. In the interior picture are small signs (like letters), and the letter A twice. On B a senseless inscription occurs frequently.

12. Kylix: Berlin. *Cat. No. 2300*; Gerhard, *Trinksch. u. Gef. IX*, 5; *Annali*, 1847, pl. M, p. 225.<sup>2</sup>

Subject: King Thoas, or Kypselos, appearing from a large chest, the cover of which is hinged on the right side. In the field is a senseless inscription.

13. Kylix: Vatican. From Vulci. Dümmler, *Bonner Studien*, p. 76; Reisch, *Führer öffentl. Samml. Rom. II*, p. 286; Gerhard, *Aus. Vasenb.* pl. CCLXIX–CCLXX.

Subject: Interior. Youth arming before a bearded, white-haired man. Exterior, A. Two bearded men and a youth arming in the presence of two youths and a boy. Exterior, B. Three youths and a bearded man arming; two boys helping. On the interior and exterior are senseless inscriptions.

14. Kylix: *Museo Gregoriano*, II, 80, 3 (?); Reisch, in Helbig's *Führer öffentl. Samml. Rom. II*, p. 289.

Subject: Interior picture cannot be made out; is on white ground. Exterior. Men and boys in conversation.

15. Kylix: in the Vatican. *Museo Gregoriano*, II, LXXXIII, 1 (?); *El. Céram. III*, 86; Dümmler, *Bonner Stud.* p. 73; *Arch. Zeit.* 1844, pp. 321 ff. pl. 20.

<sup>1</sup> For further references see *Berlin Cat. No. 2293.*

<sup>2</sup> Furtwängler (*Berlin Cat. 2300*) says that it is probably in style of Duris. Hartwig, *Meisterschalen*, p. 373, says that it is an abbreviation of the scene of Danaë and Akrisios on St. Petersburg krater.



Subject: <sup>1</sup> Exterior, A. Theft of Apollo's herd by Hermes. Interior of a cave, where Hermes, wearing a petasos, is represented as a child in a cradle. Apollo stands in an attitude of surprise. Cattle standing around; one entering cave, and sniffing Hermes' cradle. Exterior, B. Same subject. Apollo is represented driving away his herd.

16. Kylix: British Museum. *Cat. E*, 71; Murray, *Designs from Greek Vases*, pl. XIII, 49; *Arch. Zeit.* 1870, pl. 39, p. 106 (from a drawing found among Gerhard's Collection: at that time the surface was much repainted and restored: since cleaned). See *Brit. Mus. Cat.* Hartwig, *Meisterschalen*, pp. 238 and 327.

Subject: Interior. Youth dancing and playing flute. Exterior, A. Revelry. A girl playing a flute; two youths, one on a couch. Exterior, B. Revelry. Three youths, one playing flute, one dancing, and one on couch. In field is the inscription shown in Fig. 71.<sup>2</sup>

17. Kylix: British Museum. *Cat. E*, 69; *Archaeologia*, XXXII, pls. 8, 9, 11; *Wiener Vorlegebl.* VI, 2; Klein, *Euphronios*,<sup>2</sup> p. 238, note; Dümmler, *Bonner Stud.* p. 76; Robert, *Bild und Lied*, pp. 213, 214; Murray, *Designs from Greek Vases*, pl. XII, 47; Birch, *Ancient Pottery*,<sup>2</sup> p. 201, fig. 136; *Annali*, 1867, p. 153; Overbeck, *Her. Bildw.* p. 382; Hartwig, *Meisterschalen*, p. 359, fig. 49.

Subject: Interior. A draped, bearded figure in chiton and himation, wearing petasos and carrying spear, leads to right by the wrist a draped and veiled female. Exterior, A. Ajax and Odysseus represented as quarrelling over the arms of Achilles. Exterior, B. The Greeks voting concerning the arms of Achilles in the presence of Athena.

18. Kylix: British Museum.<sup>3</sup> *Cat. E*, 68; Hartwig, *Meisterschalen*, pls. XXXIV, XXXV; Dümmler, *Bonner Stud.* p. 74; Jahn, *Dichter auf Vasenbildern*, pp. 744-752; *Arch. Zeit.* 1851, p. 367. Murray, *Designs from Greek Vases*, No. 46, and p. 16, fig. 9; Harrison and MacCall, *Greek Vase Paintings*, pl. XXXVII; Klein, *Lieblingsinschriften*, p. 61; Wernicke, *Lieblingsnamen*, p. 15; Kretschmer, *Griechische Vaseninschriften*, pp. 81, 154.

Subject: Interior. A girl dances before a youth who reclines on a couch. In the field, an inscription (Fig. 34), with the first word retrograde. Exterior, A. Symposium. A bearded man, a youth, an hetaira, a flute-girl, and a boy as a wine-pourer (?). He holds a lyre. In the field are inscriptions (Figs. 35, 36, and 37). Exterior, B. Similar scene with a nude boy at left as wine-pourer. In the field are inscriptions (Figs. 38, 39, and 40).

<sup>1</sup> Exterior, A. Fig. 70. This is possibly  $\gamma\omicron[\acute{\alpha}]\epsilon\iota\varsigma \acute{\alpha}\gamma\acute{\epsilon}\lambda\eta\nu$ , "you bewail your herd." Exterior, B. Seemingly a senseless inscription.

<sup>2</sup> Other inscriptions on the vase are Fig. 72 and  $\kappa\alpha\lambda\acute{o}\varsigma$ .

<sup>3</sup> For other references see *B. M. Cat.*



19. Kylix: Berlin (Inv. 3198). *Jb. d. Arch. Inst.* 1892, Anz. p. 101.

Subject: Interior. A bearded man relieving himself into a jug. In field, an inscription (Fig. 40). Exterior, A. Bearded man and two youths dancing, preceded by a boy with basket, staff, and phiale (Fig. 40). Exterior, B. In centre sits a nude, bearded man, on a wine-skin, fluting. Before him stands a bearded man singing. Behind him, a figure similar to that on interior of vase (Fig. 40).

20. Kylix: British Museum. *Cat. E*, 70; Murray, *Designs from Greek Vases*, pl. XII, 48; Hartwig, *Meisterschalen*, p. 330; Jahn, *Philologus*, Vol. XXVI, p. 228.

Subject: Interior. "Two youths on a couch, waited on by a boy. Exterior, A and B. Eight youths, and two bearded men reclining on couches and drinking; below these is a narrow band on which are painted pairs of boots, or vases in form of boots, and various drinking vessels."

21. Kylix: British Museum. *Cat. E*, 78; Murray, *Designs from Greek Vases*, pl. XIV, 55; Hartwig, *Meisterschalen*, p. 392.

Subject:<sup>1</sup> Interior. Youth binding on boxing thongs, in presence of a bearded, draped trainer. Exterior, A. "Contest of pancratiasts, and a trainer." Exterior, B. "A runner in the armed foot-race, a trainer, and a jumper (?)."

22. Rhyton: British Museum. *Cat. E*, 784.

Subject: Side A. A youth, draped to waist with himation, reclines to right on a pillow or wine-skin, looking down and holding a lyre in his left hand. In field, a basket and Fig. 74 (*παῖς καλός*). Side B. A bearded man, also draped about the legs with himation, reclines to right, looking down, and holding a skyphos in his left hand. Like the figure on A, he reclines on a wine-skin. In field, an inscription (Fig. 40).

23. Kylix: British Museum. *Cat. E*, 64; *Mon. dell' Inst.* III, pl. 12. From Vulci.

Subject: Interior. Apollo pursuing a female to right. Exterior, A. Three bearded men on couch; one singing, with head thrown back, one playing flute, and third with lyre. Exterior, B. Three bearded men on couch; nude boy as wine-pourer. Below the pictures, a band of shoes, etc.

24. Kylix: St. Petersburg, Museum of the Hermitage. Stephani, *Die Vasensammlung der Kais. Ermitage*, No. 1723;<sup>2</sup> Wieseler, *Antike Denkmäler zur Griech. Götterlehre*, pl. VI; Welcker, *Alte Denkmäler*, V, pl. 16; Overbeck, *Kunstmythologie*, Atlas, pl. VI, 2; *Bull. dell' Inst.* 1845, p. 214 ff.; Harrison and MacCall, *Greek Vases*, pl. XXXIV, 1.

Subject: Danaë, on a couch, receiving the shower of gold.

25. Fragments of a kylix in Ashby Castle, Northampton, England. *Arch. Zeit.* 1846, p. 342; 1881, pp. 302–303, No. 7; Klein, *Meistersig.* pp. 218–219, No. 8; Brunn,

<sup>1</sup> In the field a senseless inscription.

<sup>2</sup> I have not seen this catalogue.



*Kunstlergeschichte*, II, p. 743. Hartwig, *Meisterschalen* (given as Apollodoros' work), pl. LXIX, 1.

Subject: Fragment 1. Bearded Dionysos sits with kantharos and vine. Ithyphallic satyr approaches with wine-skin; a Maenad with snake ( $\mu\alpha\iota$ ). Behind Dionysos, a satyr playing flute, and remains of an ecstatic Maenad. Fragment 2. Upper part of a youth (?), in Attic helmet, chiton, and mantle. On the outstretched arm, a shield with satyr-head in relief. The figure rushes at a fallen opponent, the tip of whose spear appears. In the field is an inscription (Fig. 33).

26. Kylix: Count Bruschi, Corneto. *Meisterschalen*, p. 343.

Subject: Interior. Bearded man on a stool; boy at his knee with rabbit. Exterior, A. Incomplete. Centre. Muffled youth seated on stool; at right, standing,

75. ΕΙΜΙ·ΚΟΙΟΝΗ·ΓΑΥ     Ι Ξ     82.

76. ΛΟΙΤ     ΑΚΡΙΣΙΟΣ     83.

77. ΗΟΓΑΙ ΚΑΙΟΞ ΜΑΙΗΙ     ΘΑΝΑΣ     84.

78. ΞΤΙΛΛΑΞ ΝΟΔΙΑΓΟ     ΕΜΓΕΔΙΟΝ     85.

79. ΕΝΔΟΤΟΙΔΑΙΜΟΜΙΤΟΙΑΛΛΑΘ     Γ Ρ Ι · Μ     86.

80. ΙΨΤΟΙ ΨΞΙ     .. Θ Ε Ν Δ ..     87.

81. ΚΥΛ     ---ΒΕ     88.

muffled youth leaning on a staff; at left, lower part of similar figure.

Exterior, B. Muffled boy in chair to right; before him, a bearded man with tablet (?); behind boy, a youth holding the back of chair.

27. Kylix: Bourguignon Collection. Hartwig, *Meisterschalen*, pp. 256-257.

Subject: Interior. Ephebos stands holding a lyre and kylix, and singing. In the field Fig. 75.<sup>1</sup>

Exterior (A and B). Remains of three, dancing, male figures, ivy-wreathed krater, and skyphos.

28. Kylix: Bassegio, Rome. Gerhard, *Aus. Vasenb.* pl. CCLXXVIII-CCLXXIX. *Wiener Vorlegebl.* VI, 2; Baumeister, *Denk.* fig. 765.

Subject: Interior. Bearded man and a boy standing face to face, each holding back a dog by a string. Exterior, A. Three bearded men, a youth, and three boys in conversation. One man holds a rabbit, and a purse. Exterior, B. Similar scene. Four bearded men, and two youths.

29. Fragment of a kylix: Van Branteghem Collection, *Sale Cat.* No. 75. Hartwig, *Meisterschalen*, pl. XXXVI, 5.

Subject: Head and part of body of youth leaning forward and talking to a woman spinning. All that remains of woman is left forearm with spindle. Between the figures, a wing.

<sup>1</sup> Hartwig suggests  $\epsilon\acute{\iota}\mu$  or  $\epsilon\acute{\iota}\mu\acute{\iota}$   $\kappa\omega\mu\acute{\alpha}\zeta\omega\nu$   $\acute{\iota}\pi'$   $\alpha\acute{\iota}\lambda\omega\nu$ , or  $\alpha\acute{\iota}\lambda\omicron\upsilon$ .



30. Kylix: Van Branteghem Collection, *Sale Cat.* No. 76, pls. 24–27. Hartwig, *Meisterschalen*, pp. 332–333.

Subject: Interior. Bearded man on couch vomiting with help of a nude boy. In field, Fig. 76. Exterior, A. Four bearded men and a youth dancing and singing to music of a flute played by a youth, and of a lyre played by a bearded man. Exterior, B. Two youths, and two bearded men dancing and singing to music of a lyre played by one of the bearded men.

31. Kylix: Van Branteghem Collection, *Sale Cat.* No. 168. Hartwig, *Meisterschalen*, p. 372 (white kylikes, No. 1), and pp. 373–374.

Subject: Interior. Draped youth and a boy in conversation, with a dog between them. Exterior, A. Seated woman spinning in the presence of three standing, draped, male figures. Two columns in background. Exterior, B. Standing, draped female in the presence of three standing, draped, male figures. Two columns. In interior picture, and on the exterior, are senseless inscriptions.

32. Kylix: *Lecuyer Collection*, No. E 5. *Arch. Anz.* 1889, p. 149.

Subject: Interior. Man on couch blowing a flute, with nude boy before him. Exterior, A.<sup>1</sup> Nude hetaira, playing flute, stands in presence of four bearded men on couches. Exterior, B. Similar scene. One man vomits.

33. Small fragment of a kylix: Hauser. Hartwig, *Meisterschalen*, p. 318.

Subject: Remains of a dancing satyr.<sup>2</sup>

34. Fragment of a kylix. *Meisterschalen*, p. 360; *Bull. d. Inst.* 1862, p. 40; *Annali*, 1878, pl. E, and pp. 38 ff.

Subject:<sup>3</sup> Herakles, profile to right, and beardless, threatens Nereus (white-haired) with the trident which he has wrested from him. Nereus, extending his right hand, rushes toward Herakles. Four overturned vases, and two overturned stools. In field,  $\acute{\omicron}$  παῖς καλός,  $\acute{\omicron}$  παῖς; on one vase, a senseless inscription; on another, καλός.

35. Kylix. *Mon. d. Inst.* XI, 33; *Wiener Vorlegebl.* D, VIII; 1890–91, VIII, 2; Dümmler, *Bonner Stud.* p. 73.

Subject: Interior. Seated, white-haired man holding a phiale, into which a standing girl pours an oenochoe. Exterior, A. Contest of Achilles and Memnon in presence of Thetis and Eos.<sup>4</sup> Exterior, B. Departure of Meleager<sup>5</sup> (?). Youth in centre, with

<sup>1</sup> See p. 75, Fig. 17 b.

<sup>2</sup> In the field is E.

<sup>3</sup> Robert (Pauly-Wissowa, V. pp. 922–925) says the scene represents Herakles and Syleus.

<sup>4</sup> For same subject, see vase No. 49.

<sup>5</sup> Engelmann (*Arch. Zeit.* 1884, p. 72, cf. Robert in Pauly-Wissowa, V. 922–925) says that the subject is the departure of Neoptolemos from Skyros. In proof he cites *Ann. d. Inst.* 1860, Tav. J, where appear Lykomedes, Neoptolemos, and Deidameia. The only resemblance is that a youth takes leave of an older man.



high boots and spear, embraced by a woman, while he extends hand to grasp that of a standing, bearded man. At left stand two women gesturing. At right is Artemis (?) or Atalante (?); at extreme right, a seated, white-haired man. Elaborate palmettes under handles.

36. Kylix: in Leyden. *Jb. d. Arch. Inst.* 1889, p. 26; Hartwig, *Meisterschalen*, p. 372.

Subject: Interior. Nude boy stands before a seated youth who plays a flute. Exterior, A. Three bearded men, dancing, one plays lyre. Exterior, B. Two men, about to fight, separated by a third. Palmettes under handles.

37. Kylix: in Brussel. *Meisterschalen*, p. 373.<sup>1</sup>

Subject: Interior. Ephebos leaning on stick. Exterior, A, B. Trainer and boxers.

38. Kylix: Hartwig, *Meisterschalen*, p. 373; Micali, *Storia*, pl. XCVII, 3; Panofka, *Bild. Antiken Lebens*, XV, 5.

Subject: Interior. Boy holding before him a staff, from each end of which hangs a basket. In field, strigil, aryballos, and staff. Figure 77.

39. Kylix: Berlin. *Jb. d. Arch. Inst.* 1893, Anz. p. 89, No. 36.

Subject: Nude woman, wearing sakkos, placing drapery, and boots on a stool. ὁ παῖς καλός.

40. Kylix; Berlin. *Jb. d. Arch. Inst.* 1893, Anz. p. 89, No. 37.

Subject: Interior. Female playing flute and dancing before a table. Exterior, A. Female playing a flute, and looking back as she hastens along. Exterior, B. An ecstatic youth. Interior, ὁ παῖς καλός. Exterior, καλός.

41. Fragments of a kylix. Hartwig, *Meisterschalen*, pl. XXXV, 4, a, b. (Hartwig gives but two fragments. There are more than a dozen.)

Subject: Interior. Man on couch with youthful wine-pourer before him. On the exterior are fragments of men on couches.

42. Fragment of a phiale. Ross, *Archäol. Aufs.* Vol. 1, pl. X; Klein, *Euphronios*, p. 52.

Subject: Interior. Remains of a bearded man, who leans backward, with right hand behind head, supported by a staff which rests under his armpit.

43. Kotyle. *Mon. d. Inst.* VIII, pl. XXVII; *Ann. d. Inst.* 1866, pp. 241 ff.

Subject: Ransom of Hektor. Side A. Priam and attendants with gifts visiting Achilles in his tent. Hektor's body lies beneath the couch of Achilles. Side B. Conversation of six bearded, standing and seated men.

<sup>1</sup> I have seen this vase neither in the original nor in illustration.



44. Kylix: Athens. *Athen. Mitth.* 1884, pl. 1; *Cat. des Vases Peints du Musée National d'Athènes*, Collignon et Couve, p. 358 (this gives bibliography); Duruy, *Histoire des Grecs*, Vol. I, p. 525.

Subject: Interior. Bearded man on a couch, singing, and playing with a rabbit which is on the ground at his side. In field is Fig. 78. Cf. Theognis, 1365, 1366.

ὦ παίδων κάλλιστε καὶ ἡμεροέστατε πάντων  
στῆθ' αὐτοῦ καί μου παῦρ' ἐπάκουσον ἔπη.

45. Kylix: Berlin. *Wochenschrift für Klass. Philologie*, 1884, p. 283. From Capua.<sup>1</sup>

Subject: Interior. Man vomiting, while boy holds his head. Exterior. Ten men fighting around a female flute-player.

46. Interior of a kylix. *Arch. Zeit.* 1854, pl. LXVI, 2.

Subject: Klytaimestra, armed with an axe, rushes toward a closed door. In field, ο παῖς καλός.

47. Kylix. *Mon. d. Inst.* XI, pl. 20.

Subject: Interior. Bearded, draped man, carrying spear, leads a girl by wrist. ὁ παῖς καλός. Exterior, A. Menelaus pursues Helen toward a house in which sits a draped female. Exterior, B. Theseus deserts Ariadne, who sleeps on a rock under a tree. Hermes hastens away in surprise. Eros flies with wreath to Ariadne.

48. Kylix: British Museum. *Cat. E*, 67; Gerhard, *Trinksch. u. Gef.* pl. D; *Designs from Greek Vases*, pl. XII, 45; *Ann. d. Inst.* 1881, p. 171; Hartwig, *Meisterschalen*, p. 361.

Subject: Interior. Bearded figure seated with phiale into which a draped female, moving away, turns to pour from an oenochoe. In background, a column and an architrave. Exterior, A. Achilles and Memnon fight between Eos and Thetis.<sup>2</sup> Exterior, B. Five figures. At left, Zeus seated, waited on by Ganymedes (?); at right, Hera, waited on by Iris. In centre, an armed, bearded, male figure (Ares?). Under handle behind Zeus, a panther.

49. Fragments of a kylix: *Jb. d. Arch. Inst.* 1887, pp. 230-231;<sup>3</sup> *J. H. S.* 1891, p. 335.

Subject: Fragment No. 1. Herakles, with a bow and quiver, hastens to left, looking back at a draped female. In field, a senseless inscription. No. 2. Remains of a male figure (Herakles?). No. 3. One foot, and parts of two others. No. 4. Two figures (one bearded) hastening to right. No. 5. Bearded head, and part of left

<sup>1</sup> I have seen this vase neither in the original nor in illustration.

<sup>2</sup> For same subject, see vase No. 36.

<sup>3</sup> Assigned by Winter to Duris, *loc. cit.*



arm; parts of two staffs. In field, a senseless inscription. No. 6. End of a club. No. 7. Part of a couch-leg and pillow, with mattress; end of staff. No. 8. Nude foot, and part of leg; part of staff and twigs.

50. Fragments of a kylix. Benndorf, *Griech. u. Sicil. Vasenb.* pl. XXVIII, 1 a, 1 b.

Subject: Fragment 1 a. An outstretched hand holding a kantharos. In field the words in Fig. 79.<sup>1</sup> Fragment 1 b. A bearded head, to left, with shoulders and arm stretched to left, with bowl in hand. A spear against the left shoulder. From the mouth of figure proceeds Fig. 80.<sup>2</sup> At the left of fragment is Fig. 82.<sup>3</sup>

51. Mug: Boston. Museum of Fine Arts. *Annual Report*, 1900, No. 13.

Subject: Genre scene. A nude youth dances to the music furnished by a draped girl.

52. Kylix: Boston. Museum of Fine Arts, No. 9023.

Subject: Interior. Bearded man, and a youth on a couch. The youth plays a flute. In field, ὁ παῖς καλὸς καλός. Exterior, A. Youth and a bearded man on couches, with a nude boy as wine-pourer at the foot of each couch. In field, ὁ παῖς καλός. Exterior, B. Bearded man, and two youths on couches. In field, ὁ παῖς καλός. There seems to be a Λ in the field at the left of basket.

53. Kantharos: Boston. Museum of Fine Arts, No. 6533, *Annual Report*, 1895, No. 24, p. 20;<sup>4</sup> Tarbell,<sup>5</sup> *A Cantharus from the Factory of Brygos (The Decennial Publications of the University of Chicago, 1902)*; *Arch. Anz.* 1896, p. 96, 24.

Subject: Side A. Zeus, with himation and sceptre, pursues a boy with himation, hoop, and stick. Side B. Zeus, with himation and sceptre, pursues a draped female.

54. Oenochoe (white ground): British Museum. *Cat. D* 13.<sup>6</sup>

Subject: A woman stands to left, holding a distaff before her while she spins. In the field is ἡ παῖς καλή.

55. Kylix: Vatican. *Museo Gregoriano*, II, pl. LXXXV, 1; Helbig, *Führer öffentl. Samml. Rom.* II, p. 291, No. 225.<sup>7</sup>

Subject: Interior. A man vomits with the help of a girl. Exterior, side A. Three men on couches, one singing and playing lyre. Exterior, side B. Two men on couches, a standing girl flute-player, and a boy with a large amphora. Under the exterior pictures is a frieze of vases.

<sup>1</sup> σπ]ένδω τῷ δαίμονι τῷ ἀγα[θῷ.

<sup>2</sup> Ζεῦ σῶτερ.

<sup>3</sup> Benndorf remarks in regard to this: "In der Liste der Vasenmaler ist freilich ein mit (Fig. 81) beginnender Name noch nicht zu finden." The explanation seems to me to be καλὸς ὁ παῖς.

<sup>4</sup> See PLATES I, II.

<sup>5</sup> Cf. *Berl. Philol. Woch.* 1903, p. 916 (Körte).

<sup>6</sup> The catalogue says: "The type of face is very similar to that of the Hera on the Brygos cup, E 65. The dotted dress would also suit the style of this artist."

<sup>7</sup> Cf. Klein, *Euphronios* <sup>2</sup>, p. 311; *Bull. d. Inst.* 1884, p. 45 (Meier); *Bonner Stud.* p. 74 (Dümmler).



56. Kylix: Overbeck, *Kunstmythologie, Atlas*, pl. VI, 3.

Subject: Danaë with Perseus, Akrisios, and maker of the chest, around the chest. In the field Fig. 83 and ὁ παῖς καλός.

57. Kylix: Museum of Fine Arts, Boston, No. 7927.<sup>1</sup> Exterior. Gerhard, *Aus. Vasenb.* pl. CCIII (poorly given); and Overbeck, *Galerie Heroischer Bildwerke*, pl. 19, No. 1.

Subject: Interior. A youth (Fig. 84) seated on a rock. Facing him stands a bearded man (Fig. 85)<sup>2</sup> armed with sword and spear. Exterior, side A. Hektor pursued by Achilles; only the lower part of Achilles, and a small part of his face, remain. At either side of picture, a gateway of the walls of Troy, in which stands a Scythian. Exterior, side B. In the centre, a gateway, in front of which Priam (Fig. 86) advances toward Athena (Fig. 87). Hekabe (Fig. 88) follows him.

58. Fragment of a kylix:<sup>3</sup> Berlin. *Cat. No. 2297*; Hartwig, *Meisterschalen*, p. 325, Fig. 43, and pl. XXXV, 3.

Subject: Interior. Remains of a picture showing a draped boy, to right, helping a drunken man to rise. Exterior, side A. Two men and boy. Exterior, side B. A youth, and remains of two other figures. On the exterior is incised a senseless inscription.

59. Kylix: Overbeck, *Kunstmythologie, Atlas*, pl. VI, 4.

Subject: Interior. Episode of Danaë myth. At the left of the chest stands the youthful maker of it, opening it, while Akrisios stands at the left, to right, raising his hand toward Danaë, who stands behind the chest supplicating Akrisios. At extreme right is nurse with Perseus in her arms.

60. Rhyton: Boston. Museum of Fine Arts.

Subject (the picture is confined to a broad band just below the lip): On the front kneels a satyr, to left, waiting to surprise a Maenad who rushes toward him, to right, pursued by a satyr. The last two figures are separated by the handle of the vase. In the field is a senseless inscription.<sup>4</sup> The vase is in the form of a horse's or mule's head.

61. Kylix: Univ. of Vienna. *Jb. d. Kunsthist. Samml. d. allerh. Kaiserh.*, 1889, p. 113.

Subject: Interior. A girl, clad in a deep, undergirdled chiton, stands to right, looking to left, before a large amphora set in the ground, holding before her in her

<sup>1</sup> A tracing is in the Apparat of the Berlin Museum (see Kretschmer, *Vaseninschriften*, p. 186, Note 2). Cf. Pollak, *Zwei Vasen aus der Werkstatt Hierons*, pp. 21 ff. and pl. VIII.

<sup>2</sup> For the motive of the petasos tilted forward, cf. Hermes, on vase No. 46.

<sup>3</sup> Hauser, *Jb. d. Arch. Inst.* 1895, pp. 161-164, unites the piece given by Hartwig with a fragment in Munich. They evidently belong together. He says that the style of the drawing is that of the "Meister mit dem Liebling Lysis" or the "Meister mit dem Liebling Laches."

<sup>4</sup> For the same inscription, cf. vases Nos. 31 and 49.



left hand a kettle, in her right a coil of rope. In the field at the left of the girl is  $\acute{o}$   $\pi\alpha\acute{\iota}\varsigma$ ; on the kettle,  $\kappa\alpha\lambda$ ; on lip of amphora, remains of  $\acute{o}$   $\pi\alpha\acute{\iota}\varsigma$ .

62. Kylix: Van Brantegehm Collection, *Sale Cat.* No. 77 (pl. 28).

Subject: Interior. A nude girl stands profile to right before a basin, holding a pail behind her in her right hand, and supporting a bundle of clothes on her left arm. On the pail,  $\kappa\alpha\lambda\acute{\eta}$ ; in the field,  $\acute{\eta}$   $\pi\alpha\acute{\iota}\varsigma$   $\kappa\alpha\lambda\acute{o}\varsigma$  (*sic*).

The following is a list of the vases which have been ascribed to Brygos, but of which I have been unable to learn the characteristics:

1. Kylix: Munich. *Cat.* No. 596; Hartwig, *Meisterschalen*, p. 372.

2. Kylix (unpublishable): Brussels, *Cat.* No. 263; Hartwig, *Meisterschalen*, p. 328.

3. Kylix: Berlin. *Cat.* No. 2295.

Subject: Interior. Standing hoplite, and kneeling bowman. Exterior, sides A and B. Hoplites and light-armed warriors. The latter on horseback.<sup>1</sup>

The assignment to Brygos of the following vases seems to me open to argument.

1. Kylix: British Museum. *Cat.* E, 66; Murray, *Designs from Greek Vases*, No. 44;<sup>2</sup> Hartwig, *Meisterschalen*, p. 443, Note 1 (says that the vase is by the "Master with the Bald Head"); Furtwängler (Roscher, II, 2162 and 2217, and *Berlin Phil. Woch.* 1894, p. 145) assigns it to Brygos. Robert (*Pauly-Wissowa*, V, 924) gives the vase to Brygos. Furtwängler and Reichhold, pl. 47.

Subject: Interior. Standing, bearded, bald man. Exterior, side A. Dionysos and Herakles, feasting, attended by satyrs. Exterior, side B. Dionysos reclining, while a satyr dances to the flute-playing of another.

2. Kylix: Berlin. *Cat.* No. 2296; *Arch. Zeit.* 1880, pl. 15, p. 177 ff.

Subject: Interior. Oriental beside a horse. Exterior, sides A and B. Youths, in chlamydes and petasoi, with horses.<sup>3</sup>

<sup>1</sup> Furtwängler says, "Der Styl ist im Ganzen wie in Detail der des Brygos."

<sup>2</sup> The exterior is given in a plate of the Brit. Mus. *Cat.* Vol. III, pl. IV. From this it seems unlike the work of Brygos.

<sup>3</sup> But two of the characteristics occurring on Brygos' works appear here, — the garment border consisting of a



FIGURE 89.—(*Arch. Zeit.* pl. 15, Side A).

stripe with dots on one edge, and the introduction of details to show locality. The high boots worn by the youth on exterior, side A, are similar to those of the satyr on the vase given by Hartwig, *Meisterschalen*, pl. XXXII. But the same style occurs on vases by Onesimos, *Meisterschalen*, pls. LIV (interior) and LIII (exterior). The horse, however, on side A of our vase, resembles the mule on the vase already cited, *Meisterschalen*, pl. XXXII (by Brygos). It is to be noted that on none of the vases by Onesimos do the horses have the mane, or "foretop" cut in "bangs" on the forehead, as is done on this vase. Besides this Onesimos, almost invariably, never brings the nostril of the horse to the end of the nose. See Fig. 89.



NOTE 1. — Through the kindness of the late Dr. A. S. Murray, who allowed me to have photographs made, personally supervising their making, I am able to reject a vase that Hartwig assigned to Brygos. The vase is Brit. Mus. E, 100 (Hartwig's E, 108), and is a kylix.

The decorations are as follows: Interior. Draped woman, wearing sakkos, stands to right holding a phiale over an altar partly visible at right. Exterior, A. Bearded man, and two youths, reclining. B. Three reclining youths. Below A and B is a band of vases, shoes, etc.

The vase possesses none of the ten individual characteristics peculiar to Brygos, and only parts of the eleven groups by which five vases were added to the list of his works. The drawing, moreover, is so hasty, notably in the interior picture, that there is little reason to consider the vase as one of Brygos'. There are, to be sure, certain echoes of his style, such as the motive of the arm thrown over the head (side B), which appears on No. 44, and that of the flute-player (here reclining) who turns to play. But these slight resemblances to Brygos' style do not warrant assigning the vase to him. One need but glance at the faces to be convinced of this.

NOTE 2. — Under *Berlin Cat.* No. 2326, Furtwängler describes an aryballos which he says is allied in style to Brygos. It seems closer to the style of the "Master with the Bald Head." Thus the eyes are staring, and the figure of Achilles is the same as on a vase by that master. Hartwig, *Meisterschalen*, pl. XLI.

ADDENDUM. — A fragment of a kylix that should have been incorporated in the list of the vases by Brygos is to be found illustrated in Hartwig, *Meisterschalen*, pl. XXXVI, 4. See also Van Branteghem Collection, *Sale Cat.* No. 75.

The fragment shows on the interior parts of the torso, head and legs of a draped woman, seated to right, holding in her hands an object (now gone) at which she looks intently. The fragment is shown to be a work of Brygos by the "intense" expression of her face.







# INDEX.

The references are to the numbers in the List of Vases, pp. 101-117.

## NAMES (INSCRIBED).

Akama[s], 4, signed.	Chrysippos, 8, signed.	Herakles, 8, signed.	Phanas, 57.
Akrisios, 56.	Demonichos, 18.	Hermes, 8, signed.	Polyxene, 4, signed.
An[d]romache, 4, signed.	Dionysos, 8, signed.	Iris, 8, signed.	Pri[a]m, 4, signed; 57.
An[ti]machos (?), 4, signed.	Dromis, 8, signed.	Mai[nad] (?), 25.	Styon, 8, signed.
Aristokrates, 18.	Echon, 8, signed.	Neoptol[emos], 4, signed.	Terpon, 8, signed.
Astyanax, 4, signed.	Empedion, 57.	Nephsis, 8, signed.	Zeus Soter, 50.
Ath]ena[ia], 57.	Heka[be], 57.	Nydris, 8, signed.	Zeuxo, 8, signed.
Babakchos, 8, signed.	Hera, 8, signed.	Orsime[nes], 4, signed.	

## "LOVE" NAMES.<sup>1</sup>

Dipilos, καλός.	Pilipos, κάλλιστο.
Nikopile, καλή.	Pilon, καλός.

## WORDS, PHRASES, AND SENTENCES.

γο[ά]εις ἀγέλην (possibly), 15.	ὁ παῖς καλός, 10; 18; 19 (three times); 22; 34; 39; 40; 46; 47; 52; 56.
εἶμι οἱ εἶμι κωμάζων ὑπ' αὐλοῦ οἱ αὐλῶν, 27.	ὁ παῖς καλὸς καλός, 52.
ἡ παῖς, 10.	ὁ παῖς καλὸς ναιχί, 38.
ἡ παῖς καλή, 54.	παῖς καλός (?), 22.
καλή, 61.	σπ]ένδω τῷ δαίμονι τῷ ἀγα[θῷ], 50.
καλός, 10; 16; 34; 40.	ὁ παῖδων κάλλιστε κτλ, 44.
καλὸς ὁ παῖς (probably), 50.	
ὁ παῖς, 6; 34; 61 (bis).	

## SUBJECTS REPRESENTED.

Arming or battle scenes: 8, signed; 13, 25.	Satyr drama: 8, signed.
Daily life: 6, 14, 26, 28, 29, 51, 54, 61.	Symposium scenes: 5, 6, signed; 3, 4, 7, 8, 11, 16, 18, 19, 20, 22, 23, 27, 30, 32, 36, 40, 41, 42, 44, 45, 50, 52, 56, 59. Nos. 6, signed (see note for three more), and 19 are obscene.
Mythologic: 1, 2, 3, 7, signed; 1, 2, 5, 10, 12, 15, 23, 24, 25, 33, 48, 53, 56, 59, 60.	Trojan war cycle: 2, 3, 4, signed; 6, 17, 35, 43, 46, 47, 48, 57.
Heroic: 34, 35, 47, 49, 57.	
Palaestric: 8, 9, 21, 37.	

<sup>1</sup> See p. 97.





SCENE FROM A KANTHAROS BY BRYGOS: A.

(CF. LIST OF VASES, NO. 54.)

*From the Decennial Publications of the University of Chicago, Vol. VI.*





SCENE FROM A KANTHAROS BY BRYGOS: B.

(CP. LIST OF VASES, NO. 54.)

*From the Decennial Publications of the University of Chicago, Vol. VI.*



# PUBLICATIONS

OF THE

## AMERICAN ACADEMY OF ARTS AND SCIENCES.

---

MEMOIRS. OLD SERIES, Vols. I.-IV.; NEW SERIES, Vols. I.-XII.  
 16 volumes, \$10 each. Half volumes, \$5 each. 25% discount  
 to booksellers; 50% to members.

Vol.	X.	Part II.	bis	. . . . .	\$1.75
"	XI.	"	I.	. . . . .	2.00
"	XI.	"	II. No. I.	. . . . .	3.00
"	XI.	"	III. " II.-III.	. . . . .	1.00
"	XI.	"	IV. " IV.	. . . . .	1.00
"	XI.	"	IV. " V.	. . . . .	.75
"	XI.	"	V. " VI.	. . . . .	.25
"	XI.	"	VI. " VII.	. . . . .	2.00
"	XII.	No. I.		. . . . .	1.50
"	XII.	"	II.	. . . . .	2.00
"	XII.	"	III.	. . . . .	6.00
"	XII.	"	IV.	. . . . .	1.25
"	XII.	"	V.	. . . . .	2.50
"	XIII.	"	I.	. . . . .	.90
"	XIII.	"	II.	. . . . .	1.25

PROCEEDINGS. Vols. I.-XXXVIII., \$5 each. 25% discount to  
 booksellers; 50% discount to members.

The individual articles may be obtained separately. A price list of recent  
 articles is printed on the third page of this cover.

---

Complete sets of the MEMOIRS, 16 vols., for \$112.50, to members, \$60;  
 of the PROCEEDINGS, 38 vols. for \$145, to members, \$78.

---

Complete Works of Count Rumford. 4 vols., \$5.00 each.

Memoir of Sir Benjamin Thompson, Count Rumford, with Notices of  
 his Daughter. By George E. Ellis. \$5.00.

---

Complete sets of the Life and Works of Rumford. 5 vols., \$25.00;  
 to members, \$5.00.

---

For sale at the Library of THE AMERICAN ACADEMY OF ARTS AND  
 SCIENCES, Corner of Boylston Street (No. 1154) and The Fenway,  
 Boston, Massachusetts.



MEMOIRS  
OF  
THE AMERICAN ACADEMY  
OF  
ARTS AND SCIENCES



VOL. XIII. — No. III.

CAMBRIDGE:  
JOHN WILSON AND SON  
University Press.  
FEBRUARY, 1906.



III.

THE SPECTRUM OF HYDROGEN IN THE REGION OF EXTREMELY  
SHORT WAVE-LENGTH.

BY

THEODORE LYMAN.

---

WITH SIX PLATES.

---

PRESENTED DECEMBER 13, 1905. RECEIVED DECEMBER 28, 1905.



# CONTENTS.

---

	PAGE
INTRODUCTION . . . . .	125
THE SPECTROSCOPE . . . . .	127
ADJUSTMENT . . . . .	130
DRY PLATES . . . . .	133
ELECTRIC APPARATUS . . . . .	134
METHOD OF TESTING FLUORITE . . . . .	134
ABSORPTION OF THE AIR . . . . .	135
PURITY OF THE SPECTRUM . . . . .	136
EFFECT OF CAPACITY ON THE SPECTRA . . . . .	138
METHODS OF MEASUREMENT . . . . .	140
SCHUMANN'S SPECTRUM . . . . .	142
LIMIT OF THE SPECTRUM . . . . .	143
RESULTS . . . . .	144
TABLES . . . . .	145







# THE SPECTRUM OF HYDROGEN IN THE REGION OF EXTREMELY SHORT WAVE-LENGTH.

## INTRODUCTION.

IN a preliminary paper<sup>1</sup> the author has given the wave-length of more than one hundred and thirty lines in the region of the spectrum lying between the values 1850 and 1030 tenth metres. It is the object of the present paper to compare the results obtained by the author with those given by Schumann; to describe the apparatus used in this research and to call attention to some new facts which have come to light since the publication of the first notice. The description has been made with some minuteness in the hope that an exact knowledge of the conditions necessary to success may prove of value to investigators who work in this field. Some attention has also been given to earlier and imperfect forms of the apparatus. For the author wishes, by flagging the pits into which he has fallen, to prevent other investigators from similar accidents.

The improvement over the method of Schumann which characterizes this research consists in the introduction of a concave diffraction grating in place of fluorite prism and lenses, thus permitting the measurement of wave-lengths. The object of continuing the work has been to improve the accuracy of the measurements and to eliminate from the radiation obtained from a hydrogen tube those frequencies which were due to impurities.

As it is unsafe to rely upon a process of extrapolation even with a grating spectrum, the two-slit method described in a previous paper<sup>2</sup> was employed. The spectroscope has been altered in construction to permit of all the adjustments required for this method and finally the photographic plate itself has been bent to agree in curvature with the arc of the circle on which the spectrum is in theory formed. Very considerable increase in accuracy has thus been gained. The grating with which the work has been done possesses one extremely strong first

<sup>1</sup> Astrophysical Journal, Vol. XIX, No. 4, 1904.

<sup>2</sup> Physical Review, Vol. XVI, No. 5, 1903.



spectrum, in fact it is to its brilliancy that the success of the research is due. In spite of the feebleness of the other spectra, however, it has been found possible to obtain many of the stronger lines between  $\lambda 1550$  and  $\lambda 1250$  in the second spectrum. Their measurement therefore forms a valuable check on the numbers obtained by the two-slit method.

The elimination of the lines due to impurities from the spectrum of hydrogen necessitates the study of the spectrum of air. As has been set forth in the earlier paper it is found most convenient to fill the spectroscopie itself with pure hydrogen; in fact if the lines of the shortest wave-length are to be obtained the light-path must be entirely in this medium. No window between discharge tube and spectroscopie is permissible. When, however, the spectrum of a gas other than hydrogen is to be studied a window of fluorite must separate the discharge tube from the spectroscopie. The extent of the spectrum is limited, therefore, by the transparency of colorless fluorite and the absorption of this substance has formed a necessary part of this research. As a matter of fact even fluorite of the best quality was found to absorb all light below wave-length  $\lambda 1200$ ; the study of the spectra of gases other than hydrogen therefore terminates with this value.

In view of the fact that Schumann made use of two fluorite lenses and a fluorite prism it seemed extremely probable that his spectrum does not extend below wave-length  $\lambda 1200$ . To test the matter the plates published in the Smithsonian Contributions to Knowledge No. 1413, have been compared with the normal spectrum obtained during this research, and it has been found possible to identify a great majority of the hydrogen lines in this prism spectrum with lines measured by the author. Two important results follow. First, a scale of wave-lengths has been attached to the Schumann spectrum, as shown in the half-tone reproductions at the end of this memoir. Second, as the line of lowest wave-length visible in Schumann's plates has the value  $\lambda 1267$ , the present limit  $\lambda 1030$  establishes a considerable extension of the spectrum.

Since the effect of change in the electrical conditions under which a spectrum is produced is extremely important, the question of the existence of a secondary spectrum of hydrogen in the region of short wave-lengths has been examined. No such spectrum appears to exist; that is to say, there is but one hydrogen spectrum between  $\lambda 2000$  and  $\lambda 1200$ .

The following pages contain a detailed account of the work of which the foregoing paragraphs may serve as an outline.



## THE SPECTROSCOPE.

The apparatus consists of two parts, the spectroscope itself and the vacuum receiver in which it is enclosed. The spectroscope is formed of a drawn brass tube 9.1 cm. in internal diameter, 96 cm. long, and 1.5 mm. thick, one end of which is provided with an arrangement for holding the grating while the other end carries the plate-holder and slits. The grating mounting consists of a square brass plate pivoted to turn about a vertical axis. The grating is held against this plate by springs, while screws through the back of the plate permit of the necessary adjustment about a horizontal axis. At the end not occupied by the grating a draw tube fits into the large tube. Upon the end of this draw tube are mounted the slits and plate-holder in a manner shown in Plate VI, figs. 1, 2, and 4, and which may be described as follows: A circular brass disc closes the end of the draw tube and is pivoted about the points *A A*, fig. 4. The motion of this disc is regulated by the screws *X X*. Upon the disc are mounted the two slits *S S*. The width of the slits is controlled by the usual screw adjustment. In order to be able to adjust the slits parallel to each other one of them is mounted in a tube which turns in the disc; the amount of this twist is regulated by the lever *L*.

The plate-holder *C* is so constructed that several photographs may be taken without withdrawing it from the apparatus. To this end the disc carries two ways *D D* in which the plate-holder slides. The position of the holder in the ways is controlled by the lever *E*, pivoted about the point *F*. One end of this lever carries the pin *G*, while the other end is provided with an iron armature *H*. The pin *G* engages one of the horizontal rods, *I*, and thus holds the plate-holder in position. To shift this position it is only necessary to swing the lever about *F* by means of a magnet exterior to the apparatus, the pin *G* then slips past one of the rods, *I*, and the plate-holder falls by an amount corresponding to the distance between two rods. The plate-holder is designed to permit the plate to be bent to the arc of a circle of given curvature. To this end it is constructed in two parts, the outside case *C* and the movable form *M*. The form (shown withdrawn from the case, fig. 3) carries two strips *N N*, whose under sides are cut to the desired curvature, the ends of these strips project beyond the main body of the form. The plate *P* is slipped into the form and is tangent, when unbent, to the curved strips at their middle point. The form is then drawn into the case by means of the screws *O O*, the ends of the plate come up against the shoulders *R R*, and as the screws are tightened the plate is bent to coincide with the strips *N N*.



The apparatus is so constructed that the curve to which the plate is bent passes through the slits. Light has access to the plate through a slot *T* cut in the disc, which slot also serves as a diaphragm for the spectrum. A sleeve, *U*, shields the plate from scattered light; and to reduce the reflection from the walls of the tube a set of circular diaphragms are provided. The whole system, draw tube and large tube, are blackened inside by the usual process. In the early work it was proposed to enclose the spectroscopist as above described in a large glass tube, but owing to the difficulty of closing such a receiver air-tight, and owing to the great liability of tubes of this size to break, the plan was abandoned. The receiver at present in use consists of a drawn brass tube 11.3 cm. in diameter, 110 cm. long, and 1.8 mm. thick. It is provided with two flanges, one at each end, cut from sheet brass and soldered to the tube. The flange at the end destined to be nearest the grating is closed by a circular brass plate, ground true, some 17 cm. in diameter. Plates of two kinds have been used to close the other end of the receiver. In the simpler form shown in Plate VII, fig. 2, a circular brass disc was only pierced by the two holes destined to admit light to the slits of the spectroscopist. In the more complex form, fig. 4, a hand hole is also provided through which the plate-holder may be introduced. This hole is 6.2 cm. in diameter and is closed air-tight by a conical plug. In order to give this plug a sufficient bearing, a sleeve some 4.5 cm. high is attached to the face plate. An inlet tube inserted about midway down the length of the receiver serves to exhaust the air; a wooden frame holds the apparatus horizontal. To facilitate the handling and development of the dry plates the end of the receiver is inserted in a small dark room. Plate VII, fig. 1, shows the appearance of this arrangement. Into the receiver thus described the spectroscopist is slipped, small hard rubber-legs hold it in a central position. Plate VII, fig. 3, shows the end of the apparatus with the face plate removed.

The concave grating with which the work has been done was ruled in 1903 on the improved engine at Johns Hopkins University. The material is the usual speculum metal, the radius 97 cm.; there are 15,028 lines to the inch. The diamond point was selected with the object of throwing as much of the light as possible into one spectrum. To the great success which attended this effort the results of the work are due, for the instrument possesses one first spectrum of extreme brilliancy.

As the experiment is carried on in an atmosphere of hydrogen the preparation of the gas is an important factor. Zinc and hydrochloric acid of the greatest commercial purity obtainable are used. The gas is passed over potassium hydrate and collected over distilled water. Before the gas is admitted to the spectroscopist it is dried over calcium chloride and phosphorous pentoxide. The drying tubes are protected at



each end by a stop-cock, thus the gas does not flow through the system directly but stands over the material for some minutes before entering the spectroscope. The perfect dryness of the gas is necessary for the success of the work. All connections between hydrogen apparatus, tubes, and spectroscope are of glass. The exhaustion is effected by a "Geryk" oil pump driven by an electric motor, the pressure is read by a McLeod gauge properly protected by drying tubes. Here again all connections are of glass. All air admitted to the spectroscope is passed through a separate set of drying tubes. These precautions have been found necessary to prevent the appearance of absorption bands. The joint between the brass receiver and the system of glass tubing is made by a glass sleeve sealed with De Kotenski cement. Though this form of joint leaves something to be desired, nothing better has as yet been devised.

The use of a discharge tube separated from the receiver by a fluorite window necessitates a separate pumping system, for the tube must be exhausted apart from the receiver and filled with the gas to be studied. For this purpose a mercury pump by Kiss of Buda-Pesth has been used. The hydrogen is made electrolytically from a solution of barium hydrate and is dried over phosphorous pentoxide.

The form of the discharge tube depends upon the manner of making the experiment. If the tube is to communicate directly with the receiver so that the whole apparatus is filled from the receiver with hydrogen, the usual form of capillary tube with ring electrodes is employed. The dimensions in a typical case were as follows: Length of capillary 6.4 cm., internal diameter 2.5 mm., diameter of electrodes 1.6 cm., distance of mouth of tube to electrode 4.5 cm. This last dimension is of special importance, since if it be made too small the discharge from the tube spreads into the receiver and produces fog, and if it be made too large intensity of illumination is sacrificed.

If the tube is to be separated from the receiver by a window and is to be separately exhausted, a special form is used. (Fig. 1.) Here the end of the internal capillary is brought as near the fluorite window as may be without undue heating. A device of this type not only brings the source of light near to the slit of the spectroscope but reduces the absorption in the tube itself to a minimum. The last advantage is a most important one in dealing with gases such as air which absorb strongly. The electrodes in both forms of tube were usually of aluminum, but iron and copper have also been tried.

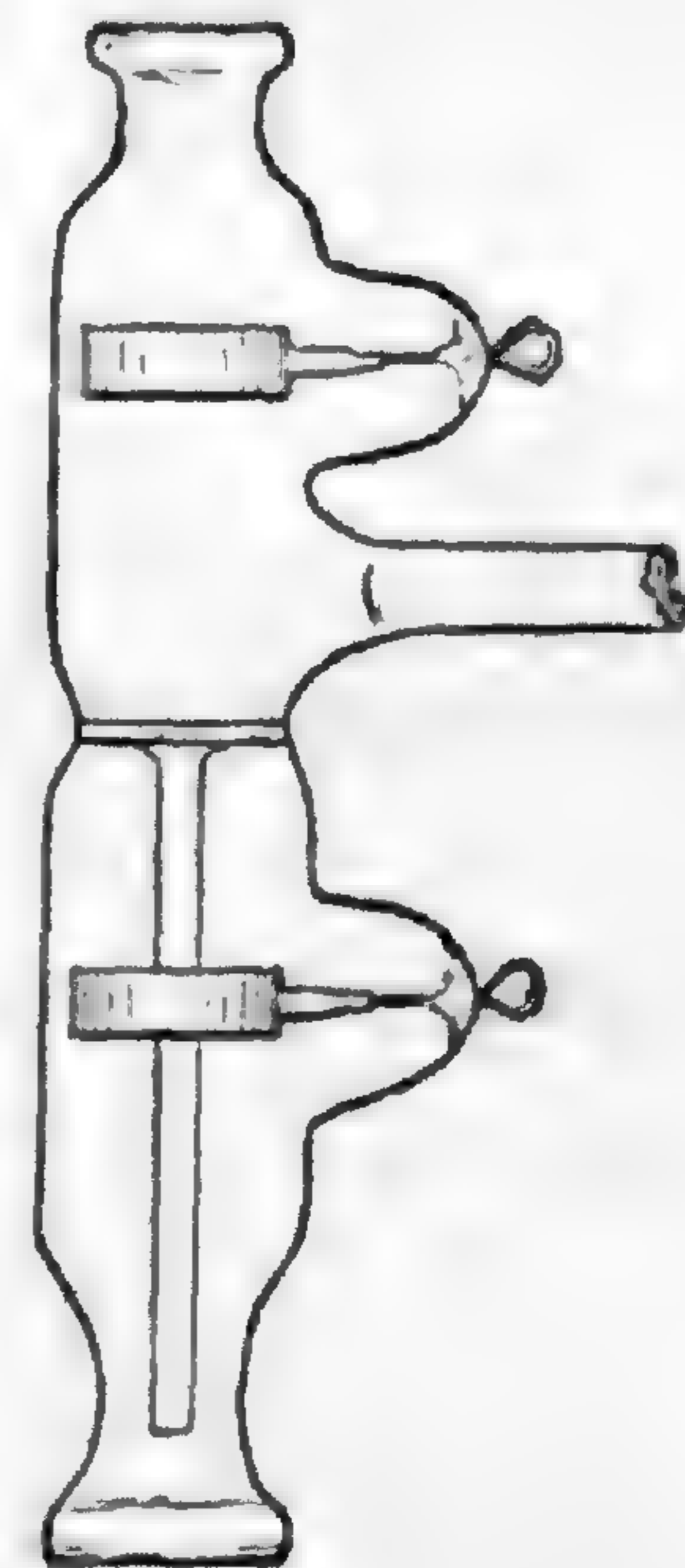

FIG. 1.



## ADJUSTMENT.

After the spectroscope is placed in the receiver the grating is turned until that part of the first spectrum to be investigated falls on the photographic plate. The arrangement of two slits serves a double purpose, as by it either the method of shifted spectra or the second spectrum comparison method may be used, without altering the position of the grating. For no matter which method is to be employed the grating is so placed that light from the right hand slit gives the region of short wave-length in the first spectrum, while by illuminating the left hand slit a shifted first spectrum is obtained superposed upon a shifted second spectrum. The dimensions of the apparatus are such that when the longest wave-length which falls on the plate from the right hand slit lies in the region of 1900 Ångströms, the longest wave-length in the shifted first spectrum has a value of about 3100 Ångströms. Observation of lines in the shifted spectrum serves, therefore, as a simple test of the exact position of the grating. When this position has once been reached the grating end of the receiver is closed, a very little vaseline being used in the joint, and the edge is looted with shellac or De Kotenski cement of the softer kind. It next becomes necessary to prepare the other face plate. If the shifted spectrum method is to be employed, this process consists in covering that hole which is to admit light to the left hand slit with a quartz window and to seal the discharge tube over the right hand opening. This last adjustment is a tedious one, for the mouth of the discharge tube must be ground at such an angle that the capillary lies in the line determined by the slit and the grating centre. This can only be done by trial. When the correct angle has been arrived at the tube is fastened to the face plate with De Kotenski cement. To insure a strong joint the brass surface must be heated during the operation. The face plate with the tube thus attached is rubbed evenly with a little white vaseline and applied to the flange of the receiver. Here great care must of course be used that the tube is in line with the slit. To facilitate this operation, tubes of both forms are made double ended, that is, they have a quartz window by means of which it is possible to look through the capillary to the slit and thus assure correct alinement. Once in position the plate is clamped and the edge looted with cement. Plate VII, fig. 4, illustrates the appearance of the more improved form of plate and discharge tube in position.

The fact that the end of the receiver is in a dark closet permits the plate-holder to be placed in the ways of the spectroscope through the hand-hole without danger of fog. The hand-hole is next closed by the conical plug and around the edge of the joint a little shellac is spread. The apparatus is now ready to exhaust. If no window



is used between discharge tube and spectroscope both parts of the apparatus are of course exhausted together and both are filled with hydrogen together. If a window separates the two, the tube must be exhausted by the mercury pump and filled from the separate supply of hydrogen. In either case the most laborious part of the adjustment lies still ahead, for the spectra from both slits must be in focus at the same time and the position of the plate-holder can only be determined by trial. It is therefore necessary to take a series of spectrographs, removing the face plate after every trial in order to change the adjustment of the spectroscope, and replacing the plate on each occasion air-tight in order to exhaust and fill with hydrogen. As can be easily understood from the figure, that the conditions of adjustment should be fulfilled both slits must lie on the circle whose diameter is the grating's radius of curvature and the plate must form a part of the arc of this circle. By construction, the curve to which the plate is bent passes through the slits. There are then two degrees of freedom of adjustment, the draw tube can be run in and out and the disc can be turned about the axis  $AA$ ; these two motions will suffice to bring the slits and plate into their correct theoretical positions.

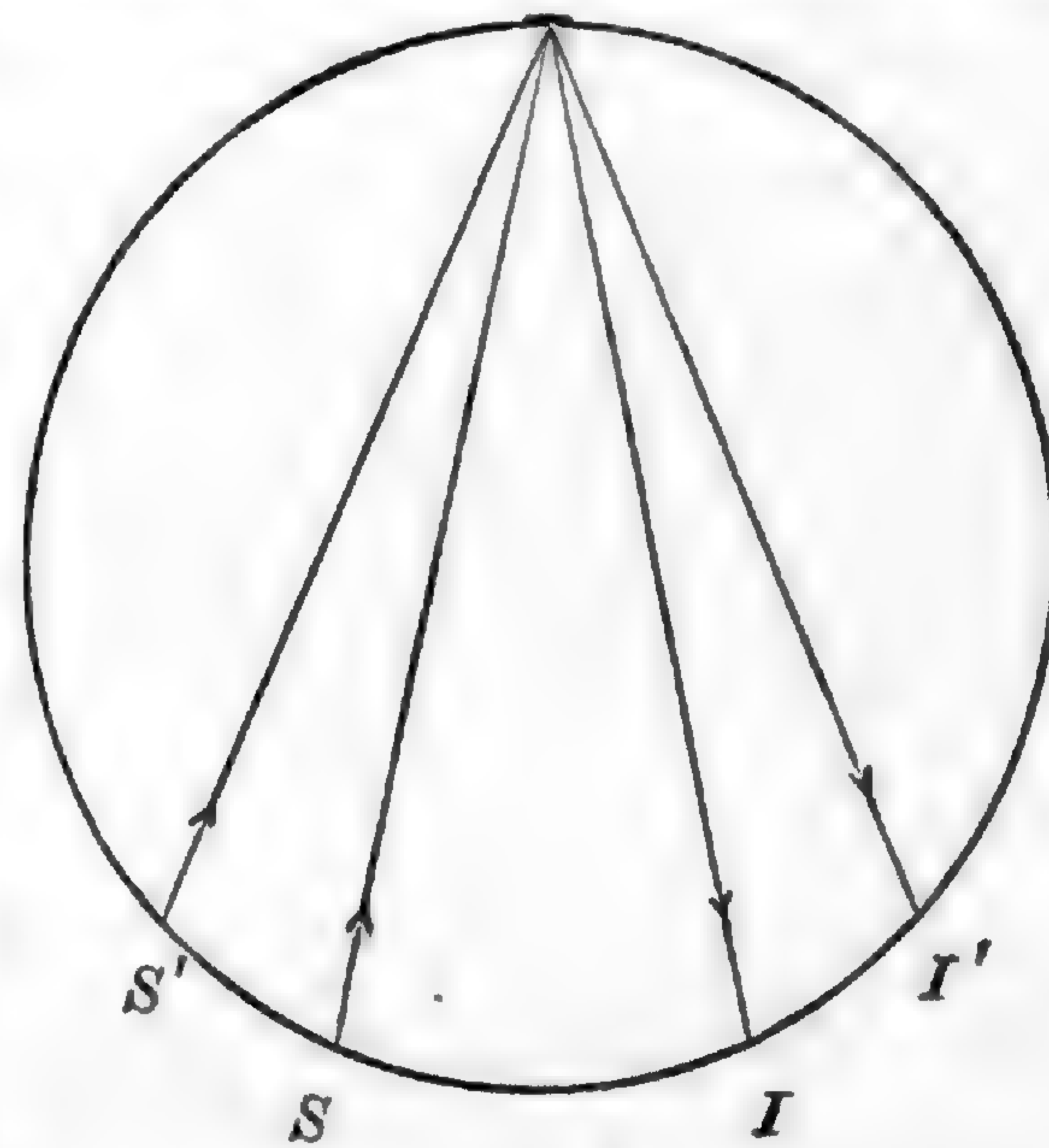

FIG. 2.

Tedious as is the method of trial above described it has seemed better to adopt it rather than to complicate the apparatus by the introduction of devices to regulate the focus from outside the receiver. Such devices might permit the focus to be changed without admitting the air, but the author is not at present prepared to face the problem of moving joints which must be maintained air-tight. Once the spectroscope is in adjustment the face plate, if it is of the improved form, can remain permanently in place.

As regards pumping the apparatus, and as to the extent to which it is necessary to wash with hydrogen with a direct connected discharge tube, the following example may be of interest. The receiver and drying tubes were first exhausted to .7 mm. of mercury. The tubes were then shut off and filled with hydrogen; after the gas had stood over the drying material for two or three minutes it was admitted to the receiver. A second filling of hydrogen was let into the drying tubes and in turn run into the receiver. The tubes are of such a capacity that two fillings raise the pressure by about 15 cm. of mercury. The pump was then applied and the pressure reduced to .45 mm.; hydrogen was admitted, the pump again applied until the pressure again



reached about .45 mm. and an equal amount of hydrogen was for the third time admitted. It was usual to repeat this process of washing at least four times before a photograph was tried.

In making the exposure the end on tube was excited by the transformer described in the previous paper. For the best results that pressure was chosen which gave a brilliant discharge in the tube without being so low as to permit the glow to spread from the tube into the spectroscop. The best value for the pressure under the conditions was in the neighborhood of 1.5 mm. The receiver was generally pumped to this pressure before the tube was excited.

In a plate such as that previously published, where several spectra appear upon one negative, it was usual to allow a fresh supply of hydrogen to enter the receiver between each exposure. Thus after the plate-holder has been lowered by the magnetic device the receiver is repumped. It is just to suppose that the gas in the apparatus is much purer during the last exposure than during the first. The effect of this increased purity upon the nature of the spectra themselves has been noted in the former article, unfortunately the reproduction did not show the effect at all well, though it was extremely clear upon the original negative.

The process of washing, pumping, and rewashing is of necessity a tedious one and generally occupied the better part of a day. Schumann has observed that the appearance of the hydrogen spectrum in its visible part was no criterion of its purity as observed in the region of short wave-length. It may be of interest to add, nevertheless, that the discharge tube when properly washed with hydrogen showed the many line spectrum of that gas in a state of considerable purity. The appearance of air lines was always a sure warning, if a discharge tube without a window was used, that the spectrum on the photographic plate would be extremely feeble.

In work of this kind it is found almost impossible to make the receiver absolutely air-tight. In fact some of the most successful of the early plates were obtained in the presence of a slight leak. Under the circumstances the magnitude of this leak becomes of importance. For example, the plate of the previous article was obtained with the surprisingly large leak of 0.2 mm. in an hour, showing that perfect tightness of the apparatus was not necessary when proper attention was given to washing with hydrogen. If, however, the receiver was to be exhausted below .1 mm. the leak must be very much reduced. Practice and care in setting the face plate secured this result and work has been done where the leak in 24 hours was less than .02 mm.

In those cases where the discharge tube is separated from the spectroscop by a fluorite window what has been said about the purity of the gas in the receiver and the



amount of washing necessary to secure it remains of course true. To this is now added the trouble of pumping and filling the discharge tube with whatever gas may be under examination. The gas in the discharge tube, however, may be used over a considerable range of pressure, for the presence of the fluorite window prevents the discharge from spreading into the spectroscop. In practice the pressures varied in different experiments from 2 mm. to .5 mm. The pressure in the receiver was usually reduced to 0.1 mm., though if the hydrogen be pure so low a pressure is not at all necessary. The width of slit used varied from .09 mm. in the case of the crude plate published in a former article to about .025 mm. in the case of the fine plates from which measurements have been made.

The time of exposure for the hydrogen spectrum varies between five and thirty minutes according to the width of slit and the sensitiveness of the plate.

#### DRY PLATES.

Little can be added to Schumann's description<sup>3</sup> of the manufacture of the special dry plates necessary in this work. The first part of the research was carried on with plates prepared from glass 1.5 to 2 mm. in thickness. When the form of the spectroscop was improved and it became necessary to bend the plates to the arc of a circle special sheets of thin glass were required. In order that the emulsion may flow evenly the plates must be very flat. This necessity of flatness together with the mechanical difficulties of grinding put a limit to the thinness of the sheets. In practice plates  $8.8 \times 13$  cm. and between .4 and .5 mm. thick are flowed and when dry are cut into small pieces  $2.6 \times 4.4$  cm.

One slight departure from the method of Schumann has been found advisable; each plate was separately supported on legs during the process of flowing. In this way if the emulsion run over the edge of one plate, only that plate is spoiled; while if all the plates are on one levelling table a disaster to one may result in the overflow of all.

In development the author has used ortol with good results. Here, as has been remarked by Schumann, the strength of the developer must be regulated by the age of the plate. The addition of ice is a very necessary part of the process. The following proportions are suitable to plates six months to a year in age: Ortol A, 1 part, B 2 parts, Water 2 parts, ice about 1 part.<sup>4</sup>

<sup>3</sup> Ann. der Physik. Vol. 5, p. 349. 1901.

<sup>4</sup> A. Water . . . . . 1000 cc.	B. Water . . . . . 2000 cc.
Metabisulphate of Potash 7.5 gr.	Pot. Carb. 120 grs.
Ortol . . . . . 15 gr.	Sod. Sulphite 360 grs.
	Hypo. 1 to 20 20 cc.



## ELECTRIC APPARATUS.

The electric apparatus used to excite the discharge tube has in almost all cases consisted of a transformer run from the 60 cycle 110 volt alternating circuit and provided with a suitable rheostat in the primary. When such a transformer is used with a discharge tube containing gas at pressures from 1 to .1 mm. the addition of capacity across the terminals of the tube produces — with most gases — very little effect on the nature of the discharge because the low resistance of the tube after the current has once begun to pass does not permit the condensers to charge. If a spark gap be introduced in series with the tube this difficulty is of course obviated. In all the earlier work no gap was used so the spectra obtained were due to a discharge practically without capacity. The capacity when introduced consists of glass plates coated with tin-foil and has a value of perhaps .005 microfarads. In some of the work a coil with a mechanical break taking 12 volts and 5 amperes in the primary has been substituted for the transformer. In the case of the metallic spectra used for comparison the spark has of course been brightened by the use of capacity.

## METHOD OF TESTING FLUORITE.

In order to provide a window of the greatest possible transparency for the discharge tube, in those cases where the spectra of gases other than hydrogen were to be examined, it was necessary to test various specimens of fluorite which the author had at his disposal. The method was as follows: The piece under trial was attached to the plate-holder at the end of an arm in such a way that it projected to the right of the ways in which the holder moves. The length and shape of the arm was so adjusted that when the plate-holder was at its highest position the fluorite was just above the right hand slit, but when the holder had been allowed to fall the fluorite slab fell with it and came between the slit and the mouth of the discharge tube. The receiver was exhausted and filled with hydrogen in the usual way, rather a wide slit was used. A photograph was then taken with the plate-holder at its highest position, thus the light path lay entirely in hydrogen. Next, by means of the magnetic device, the plate-holder was allowed to fall until the specimen of fluorite came in front of the slit, the light from the tube now passed through the fluorite before reaching the slit. By comparing the two spectra, obtained one below the other on the same plate, the point in the spectrum at which the specimen cut off the light could be easily determined.



Six circular plates of white fluorite 3 mm. thick and 2.5 cm. in diameter, and two plates 2 mm. thick — all from Zeiss of Jena — have been tested, with the result that, while none of them are absolutely opaque to light below  $\lambda$  1600, their transparency varies very much. In no case, however, was any line of wave-length shorter than  $\lambda$  1200 obtained, and of the eight pieces but two showed this transparency. The abrupt nature of the absorption at this point is well shown by spectra II and III in Plate VIII. II was taken with the internal capillary discharge tube and fluorite window, III with no window between tube and slit. The author is not of course prepared to say that no fluorite does exist transparent to light below  $\lambda$  1200, he can only say that of the best specimens obtainable up to the present, but two show even this limited transparency. The discovery of some substance transparent to light of the very shortest wave-length known to exist would be an important step. For our knowledge of the spectra of gases other than hydrogen is at present limited by the transparency of fluorite.

The effect of the thickness of the fluorite window was tested by taking a series of spectrographs through one of the two best specimens and then reducing the thickness of the piece from 3 to 0.9 mm. A second series taken through this thinner window showed no extension of the spectrum whatsoever. This is a result which might have been expected from the work of Schumann and which confirms, for this region, that slow increase of absorption with thickness which has been observed in other parts of the spectrum.

#### ABSORPTION OF THE AIR.

The absorption of the air is the important factor in all investigations which have to do with radiations of short wave-length. Cornu was the first to investigate the matter systematically, but Schumann has vastly extended the work and has given data on the relation of length of air path to the limit of the spectrum. His method was to interpose a cell whose thickness could be varied between his source of light and the slit of his spectroscope. This cell was filled with air at atmospheric pressure.

There is not much to add. The method here employed was as follows: The discharge tube was separated from the spectroscope by a fluorite window and spectrographs were taken with air in the receiver. Thus the light from the discharge tube traversed a layer of fluorite and then passed through air to the grating and back to the photographic plate — a distance of about 200 cm. By taking a series of spectrographs at different pressures the variation of the absorption with pressure could be



observed. At the very beginning of the investigation the author was confronted by a puzzling and persistent phenomenon—the absorption of the air appeared to be selective, not total. For a broad absorption band appeared between  $\lambda 1790$  and  $\lambda 1550$  and remained undisturbed even when the pressure had been reduced to .17 mm. At this point the air permitted the remainder of the spectrum to pass nearly down to the limit of transparency of the fluorite window. It was only after the receiver had been frequently washed with carefully dried air that the absorption band disappeared. The phenomenon is therefore due to some impurity—possibly something which comes from the brass of which the receiver is made, and which only persistent pumping will remove.

It is not perfectly satisfactory to compare the values obtained by Schumann, which are given in terms of the absorption of a column of air at atmospheric pressure, with those obtained by the author. It may be of some interest to point out, however, that, if the lengths of two equivalent air paths are to each other inversely as their corresponding pressures, the column of air in the receiver at .17 mm. pressure 200 cm. long is about equivalent to a column at atmospheric pressure 0.4 mm. in length. Now, when the receiver was at this low pressure, light of wave-length a trifle below  $\lambda 1400$  was recorded on the photographic plate. It appears, therefore, that a column of air 0.4 mm. long will permit light of this short wave-length to pass in sufficient intensity to affect a photographic plate under the conditions of the experiment.

The expression of the absorption of the air in anything like an absolute system is a very difficult matter. The point of practical interest in this part of the research is the advantage of an atmosphere of hydrogen in the receiver. It is not easy to exhaust the apparatus to a sufficient degree of transparency, but by successive washings with hydrogen the last traces of air can be removed and its absorption very largely eliminated.

#### PURITY OF THE SPECTRUM.

The spectra of hydrogen, from which the wave-lengths recorded in the following tables were measured, have been obtained under some variety of condition, but they all show considerable uniformity of appearance. The greatest difference occurs between those spectra obtained from an internal capillary discharge tube closed by a window and those where the tube communicated directly with the receiver. Contrary to expectation the spectra obtained under the latter condition are much purer than those which the first method yields. No matter with what care the closed discharge



tube is pumped and repeatedly washed with hydrogen, certain characteristic bands are bound to make their appearance to a greater or less degree. The nature of these bands is unfortunately only too clearly seen in spectrum II of Plate VIII. If, however, the tube communicates directly with the receiver and is filled with hydrogen along with it, these bands may be totally absent. Schumann has observed their presence and ascribes them to carbon monoxide. On this point the author cannot yet be sure; certain it is, however, that they occur strongly in the spectrum of the air. (Compare spectra I and II, plate VIII.)

The means used to produce the hydrogen for the discharge tube have been varied. Zinc and hydrochloric acid, and electrolytic action in both dilute sulphuric acid and on barium hydrate solution have served as sources for the gas. Various shapes of discharge tube have been tried, both closed and communicating directly with the receiver. Aluminum, copper, and iron have been used as the material of the electrodes which in turn have been of various dimensions. The comparison of the plates taken under the above conditions serves as an excellent test of the true source of the radiations supposed to be due to hydrogen.

In addition, the spectra obtained by exciting the discharge tube when filled with air at pressures between 2 and .5 mm. have been compared with the spectra obtained when the same tube was filled with hydrogen. The lines found to be common to the two spectra have been eliminated as due to the air itself or to some impurity. Such a process may result in the loss of a few true hydrogen lines but what remain can be safely attributed to that gas. Finally, this matter has been checked by a study of the behavior of suspected lines as the purity of the hydrogen in the discharge tube is increased. It must be remembered that the elimination of lines due to impurities by comparison of the air and hydrogen spectra can only be applied to those radiations which lie in that region for which fluorite is transparent. The results are to be found in the table of wave-lengths given at the end of this paper.

The general appearance of the spectrum may be described as follows: Between  $\lambda$  2000 and  $\lambda$  1675 the author can find no trace of radiation due to hydrogen, but he is not prepared to assert that a faint continuous spectrum may not exist. From  $\lambda$  1675, however, the spectrum consists of a multitude of very fine lines with a maximum of intensity near  $\lambda$  1600. Near  $\lambda$  1300 something very like an absorption band occurs, due, perhaps, to some slight trace of impurity in the gas, but always present no matter under what conditions the gas may be produced or examined. Lines are visible in this band but they are very feeble. The lines beyond the region limited by the absorption of fluorite are some of them as strong as any in the spectrum. The lowest



measured wave-length has the value  $\lambda 1030.8$  but beyond this there are some very faint lines whose wave-length must be between  $\lambda 1000$  and  $\lambda 1010$ . At present these lines form the limit of the spectrum.

The nitrogen-like appearance of the spectrum of air shown in fig. 1, Plate VIII deserves attention. The fluted bands are beautifully clear in the original negative and their general character can even be seen in the reproduction.

#### EFFECT OF CAPACITY ON THE SPECTRA.

The spectra both of air and hydrogen were obtained with no capacity in circuit with the discharge tube beyond that afforded by the connections of the apparatus. The effect of capacity on the spectrum of both gases in the visible is so striking, however, that it seemed worth while to study the phenomenon in this new region of short wave-length. Moreover, the recent attempts which have been made to extract from the change in spectrum with change in condition some evidence as to the nature of the vibrating system of electrons, make such experiments doubly interesting. For in this new region we are dealing with vibrations more than three times as rapid as those studied in the visible spectrum. This difference in rapidity might well be expected to differentiate the effect produced by a given change of condition on the visible spectrum from the effect produced by the same change on the region between  $\lambda 2000$  and  $\lambda 1030$ . It is even possible to conceive that this differentiation might throw some light on the vibrating system itself.

The research is unfortunately beset with mechanical difficulties. Reference has already been made to the trouble experienced from the spreading of the discharge into the spectroscop and the resulting fog produced on the photographic plate. This difficulty is increased a hundred fold if a disruptive discharge is sent through the tube, for in this case the whole interior of the spectroscop seems to become luminous and a total fogging of the plate results. With great care as to regulation of pressure some spectrographs have been obtained, but they have never been perfectly satisfactory, since even if but a single spectrograph is taken on a plate the time of exposure must be short. When the investigator turns from the direct connected discharge tube to one closed from the receiver by a fluorite plate he is confronted by a new difficulty. The fog indeed is prevented, but after a short time the violence of the disruptive discharge deposits a thin film on the fluorite window and renders it totally opaque. This film need be hardly visible by transmitted light and yet it will be thick enough to absorb all wave-lengths below  $\lambda 1800$ . The material of the electrode exercises of course a pronounced influence, but even with aluminum, which shows the effect the least, the



result is as above described. The annoyance of disconnecting the discharge tube from its pump, removing the face plate from the receiver, detaching the discharge tube from the face plate and cleaning the window, followed by the same set of operations in the inverse order, must be experienced to be thoroughly appreciated. When it is remembered that with a disruptive discharge this process must be gone through after about four exposures the difficulty of this part of the research will be understood.

In practice the discharge tube was filled with hydrogen and a spectrograph taken without capacity, next a spark gap was introduced in series with the tube, and capacity was put in parallel until the gas showed the four line spectrum clearly. The appearance of the tube was constantly watched with a direct vision spectroscope.

A similar set of experiments were tried for air. In both cases the material of the electrodes was altered in various experiments. It is important to observe that the nature of the electrode does not seem to affect the nature of the phenomena.

The effect of the introduction of capacity with hydrogen is to introduce five sets of new lines. These lines lie between  $\lambda$  1900 and  $\lambda$  1400; under favorable circumstances they are strong and characteristic. The appearance of the principal spectrum remains unaltered, except for a very slight weakening.

The effect of capacity on the spectrum of air is very different. The band spectrum is weakened to such an extent as to be almost wholly destroyed and five sets of new lines are introduced. These new or secondary lines are identical with those which appear in hydrogen. Though some of these lines are always present both in hydrogen and in air, with the disruptive discharge, they vary very much in intensity from experiment to experiment. This variation with the condition of the research, added to the fact that the secondary lines appear both in hydrogen and in air make it almost certain that they owe their origin to some impurity common to both gases. The nature of this impurity can only be decided after the spectra of the other principal gases have been examined. At present it seems safe to state that (1) there is no secondary spectrum of hydrogen in the region below  $\lambda$  2000; (2) that the introduction of capacity almost totally destroys even the primary spectrum of air; (3) that new and characteristic lines do come into existence, in both air and hydrogen, and that these lines are probably due to some impurity. In weighing the evidence here presented it must be remembered that these results have been checked by experiments performed under very varying conditions. The pressure and purity of the gases, the shape and character of the discharge tube, the material of the electrodes, and the time of exposure are all factors which have undergone investigation.



## METHODS OF MEASUREMENT.

The methods used were two in number. The values of all the lines were first obtained by the two-slit method and these values were then checked by obtaining the stronger lines in the second spectrum and comparing their positions with known iron lines in the first spectrum. For this last purpose the first and second spectra obtained from the left hand slit were employed.

The two-slit method has been described elsewhere, but a brief account of its theory and its limitations may not be out of place here. If two slits,  $S$  and  $S'$ , be placed on that circle whose diameter is the grating's radius of curvature, the illumination of these

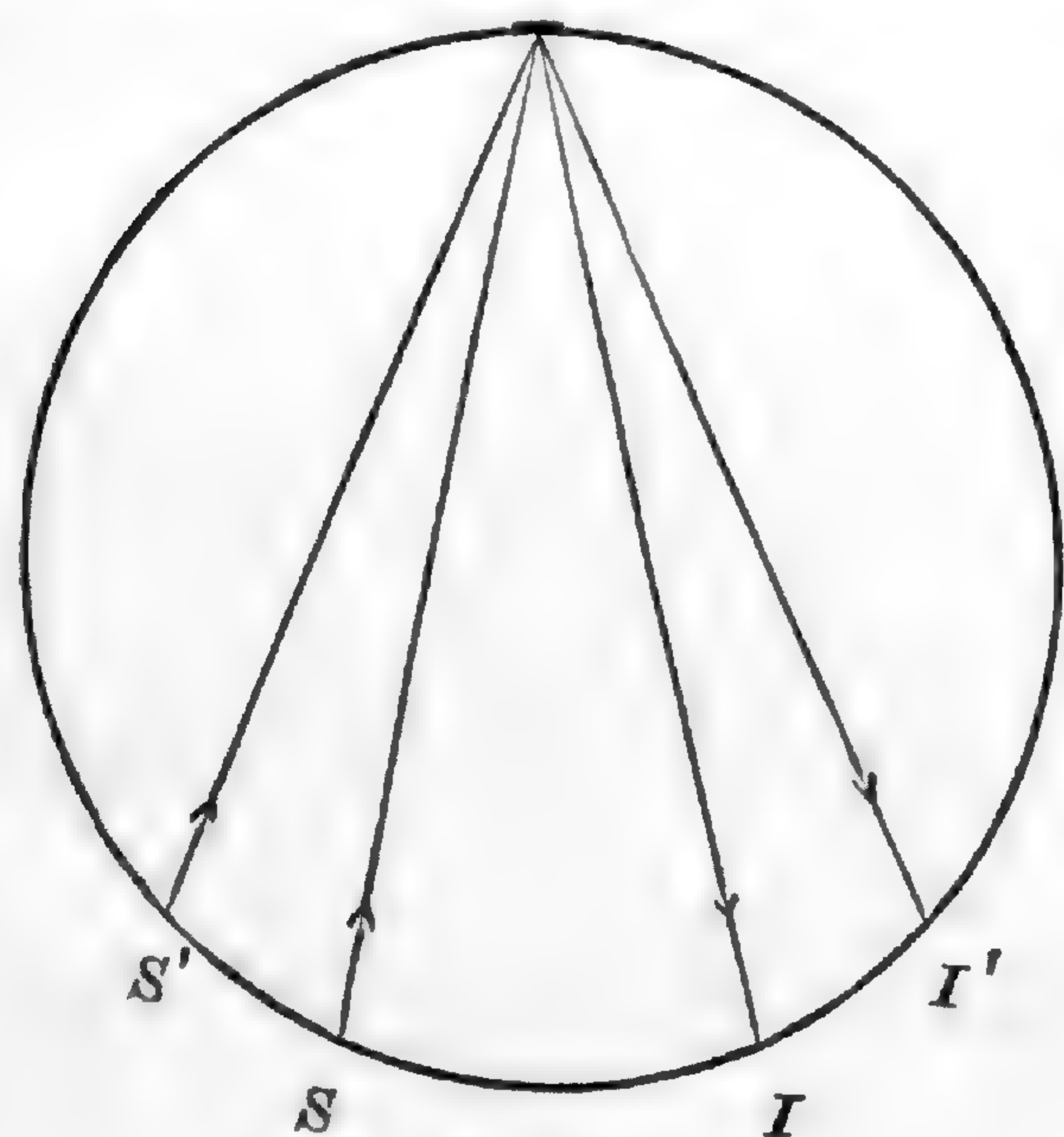

FIG. 3.

slits by white light will give rise to the images  $I$  and  $I'$ . To each of these images a set of spectra will correspond. For the present purpose it is sufficient to concentrate the attention on the two first spectra. It is evident that these two spectra will be shifted with respect to each other by an amount depending on the distance between the slits. If a photographic plate be placed between  $S$  and  $S'$ , and if the height of these slits be properly adjusted, one of these spectra will be superposed upon the other. At a given point,  $P$  on the plate, the light brought to focus from  $S$  will be of a shorter wave-length than that from  $S'$ . If the sources of light be so selected that the wave-lengths in both spectra arriving at  $P$  have known values, then the shift of one spectrum with respect to the other may be determined by comparison of these values. If the apparatus is in adjustment both spectra are in focus upon the same circle and the amount by which one spectrum is shifted over the other is a constant quantity; that is to say, if the shift is determined by comparing known lines at one end of the plate, it must have the same value at the other end. It is upon this property that success in the use of method depends.

It next becomes of importance to inquire to what extent small errors of adjustment will influence the constancy of the shift. Here the nature of the method upon which the observer must rely in determining the perfection of this adjustment must be remembered. The only practical test consists in the sharpness of focus of the two spectra. It is the object then to so manage matters that both spectra shall be in perfect focus throughout the plate's length and at the same time. The vital question at



once suggests itself: Is this test sufficiently delicate for the present purpose? If very accurate results are required the question must be answered in the negative. A little consideration makes it obvious that the relative position of the images  $I$  and  $I'$ , and hence the shift, changes with the focus more rapidly than can usually be detected by the change in sharpness of the lines. In other words, if the shift were given, the proper focus could be accurately determined, but if the sharpness of focus must be relied on, then the true shift can only be approximately inferred. Or again, for practical purposes, the apparent shift varies slightly more rapidly with variation in adjustment than does the sharpness of the spectral lines. The foregoing is, of course, somewhat dependent on the manner in which the adjustment is made. In the apparatus in question the slits and the photographic plate are rigidly fixed on the arc of a circle. This arc is capable of being thrust in or out parallel to itself along a line connecting the centre of the grating and the centre of the photographic plate; it is also capable of rotation about its middle point. By these two movements perfect adjustment can be attained, but the test of this adjustment is not absolutely adequate.

The practical application of the method is as follows: The spectrum of iron was selected for comparison work. The grating was so turned that known lines in the spectrum of aluminum fell upon one end of the plate when the right hand or direct slit was illuminated by light from a spark between terminals of the metal. The shift of the principal spectrum with respect to the comparison spectrum was then determined by comparing the positions of these lines in aluminum with known lines in the spectrum of iron. In order to insure accuracy this shift determination was recorded on the same plate as the spectrum of hydrogen whose lines were to be measured. This was conveniently brought about by admitting the light from the aluminum spark directly through the discharge tube, for which purpose the tube was fitted with a window of quartz at the end not attached to the face plate. Upon the spectrum to be measured was superposed the comparison spectrum of iron, and in this spectrum fiducial lines were selected. The relative value of these lines was then obtained by subtracting the shift from their real value, previously corrected to vacuum. These relative values were then used as points of departure to determine the wave-lengths of the unknown gas spectrum. In practice the shift was 1180 Ångström units so that the point in the iron spectrum falling on say  $\lambda$  1400 of the gas spectrum has a value of  $1400 + 1180 = 2580$  Ångströms.

Owing to the dimensions of the plate only a region of about 760 tenth metres can be photographed at one time. Thus if the aluminum line 1935.29 falls upon one extreme of the plate the other end corresponds to wave-length  $\lambda$  1175. In order to



investigate light of shorter wave-length than this value it is necessary to turn the grating, a process which necessitates a slight change in the adjustment of slits and plate.

To check the values obtained in the above manner lines of short wave-length were obtained in the second spectrum. For this purpose the left hand slit was covered by a discharge tube without a window and the whole apparatus was filled with hydrogen exactly as usual. Owing to the feeble character of the second spectrum only the stronger lines between  $\lambda 1550$  and  $\lambda 1200$  could be photographed. Their position was determined by comparison with first spectrum iron lines obtained from light which had passed directly through the discharge tube. The average difference between the values obtained by the two methods is 0.3 Ångström unit.

The plates have been measured on an engine made by Wolz of Bonn after the design by Kayser. The screw has been calibrated and proves to be of an accuracy far greater than this work demands. The intensities of the lines have been estimated, first, by observations made under the reading microscope, and, second, by projecting the spectrum on a screen. The latter method has the advantage that the whole spectrum is before the observer at one time. The values were estimated from plates taken without a fluorite window. The tables are divided into two parts. In the first are given 310 lines lying in that region from which it has been possible to eliminate the lines due to impurities. The error should not be greater than 0.3 Ångström. In the second are lines in that region beyond the transparency of fluorite; their origin is not absolutely known, but they are probably due to hydrogen, since they were obtained when the discharge tube was connected directly with the spectroscope, a condition under which air lines rarely occur. The error in these values should not be greater than one unit. The values of the iron lines are from the measurements of Exner and Haschek as given in Watts' Tables;<sup>5</sup> the correction to vacuum came from the same source. The wave-lengths of the aluminum lines are from the measurements of Eder and Valenta.<sup>6</sup>

The agreement between the tables and the numbers given in the "Preliminary Measurements" is well within the accuracy claimed for the earlier values.

#### SCHUMANN'S SPECTRUM.

In order to compare the prismatic spectrum obtained by Schumann with the values of the table the twelve plates published in the Smithsonian Memoir<sup>7</sup> were cut out and pasted together. The resulting spectrum, some 127 cm. long was placed upon a

<sup>5</sup> Index of Spectra, W. M. Watts, Appendix J.

<sup>6</sup> Beiträge zur Photochemie, p. 388.

<sup>7</sup> Smithsonian Contributions, No. 1413.



movable stand and the grating spectrum was projected upon it by means of a lens. By changing the magnification so as to keep step with the dispersion the strong lines on the one spectrum were identified with those in the other from  $\lambda$  1674 to  $\lambda$  1269 without the least difficulty. From the values thus obtained interpolation curves were drawn for each one of the twelve plates separately and by means of these curves a scale of Ångström units was attached to each of the twelve illustrations. By the permission of Dr. Schumann and through the kindness of Professor Langley of the Smithsonian Institution the half-tone reproductions which appear at the end of this memoir were then made from these illustrations. They by no means do justice to the fine originals, but considering the difficulty of the process they may be considered fairly satisfactory.

The agreement between the author's measured values and the prismatic lines is extremely gratifying. Of the two hundred and eighty-five lines given in the tables all but three or four are found in Schumann's plates. There are, however, a considerable number of fainter lines in the prismatic spectrum not visible in the plates obtained with the grating. Moreover, owing to the fineness of the slit, and the great dispersion used by Schumann some of the single lines of the table are seen by comparison with the prismatic spectrum, to consist of doublets or triplets.

The excellent agreement between these two spectra obtained under such different conditions makes the existence of any chance impurity very improbable.

The extreme line in Schumann's map has the value  $\lambda$  1266.9. That author has stated that he obtained some lines too faint to reproduce; from the angles given<sup>8</sup> it is difficult to calculate their exact wave-length, but it seems improbable that they should have a value much below  $\lambda$  1230. In this connection it is interesting to note that the calculation of Martins<sup>9</sup> from the Kettler-Helmholtz formula for fluorite was not far wrong.

#### LIMIT OF THE SPECTRUM.

It may well be asked, — to what is the present limit of the spectrum due? There are several causes which go to make up an answer to this question.

A much longer exposure might result in the discovery of new lines; unluckily there are difficulties in the way of this seemingly simple step. For, as has been previously stated, with a windowless tube there is a great tendency for the discharge to spread into the receiver and cause fatal fogging of the plate. No plan has so far been devised to obviate this difficulty and up to the present the length of exposure has

<sup>8</sup> Smithsonian Contributions, 1413, p. 24.

<sup>9</sup> F. F. Martins Ann. der Physik, 1901. Heft II., p. 619.



been limited by it. Besides this mechanical difficulty several other possible agents may exert an influence. Speculum metal may cease to reflect in the region near  $\lambda 1000$ ; that it reflects so well down to this point is surprising. The Schumann plates may cease to be sensitive. Small impurities in the hydrogen may exercise considerable absorption. Only experiments on metallic reflection, on the manufacture of plates and on the purification of gases can answer these questions. The author sees no insurmountable difficulty, however, to the still further extension of the spectrum.

#### RESULTS.

The results arrived at in this memoir may be set forth as follows:

I. The spectrum has been extended from the limit obtained by Schumann to the value  $\lambda 1030$ .

II. The lines in the spectrum of hydrogen have been measured accurately from  $\lambda 2000$  to  $\lambda 1228$ , and the values of the principal lines to  $\lambda 1030$  have been determined.

III. The nature of the spectrum of air has been investigated.

IV. The limit of transparency of certain specimens of white fluorite has been obtained.

V. The effect of the disruptive discharge on the spectra of hydrogen and air has been studied, and the absence of a secondary spectrum of hydrogen established in the region below  $\lambda 2000$ .

VI. Wave-lengths have been attached to the spectrographs obtained by Schumann.

Much of this research has been carried on with the help of a grant from the Bache Fund. The permission to reproduce the plates from the Smithsonian Contributions is due to the kindness of the Secretary of that Institution.

It is impossible to conclude this memoir without some tribute to the man whose name will be always associated with the region of short wave-lengths which he discovered, and it is with the greatest pleasure that the author acknowledges the help and inspiration he has received from the friendship of Dr. Victor Schumann.

JEFFERSON PHYSICAL LABORATORY,  
HARVARD UNIVERSITY, Dec. 27, 1905.



SPECTRUM OF HYDROGEN.

MEASURED BY A DIFFRACTION GRATING.

Wave- Length.	Intensity.	Character.	Wave- Length.	Intensity.	Character.	Wave- Length.	Intensity.	Character.	Wave- Length.	Intensity.	Character.
1228.3	8		1302.5	2	double	1380.2	5		1452.0	3	
1230.1	8		1307.5	2		1380.8	1		1452.5	1	
1231.0	1		1311.1	2		1382.9	1		1454.3	1	
1232.1	5		1312.9	2		1383.0	1		1455.1	7	double
1234.3	4		1314.7	1		1384.2	1		1456.3	4	
1235.8	6		1315.6	1	double	1385.6	2		1457.4	6	
1239.6	3		1319.2	4		1386.3	3		1458.4	6	
1241.5	2		1323.4	5		1387.7	4		1460.1	5	double
1246.1	4		1325.0	5	double	1390.0	1	double	1461.0	4	
1247.2	4		1327.1	3		1391.2	1		1462.0	3	
1248.0	2		1327.5	2		1393.2	3		1462.9	4	
1249.8	3		1329.3	1		1394.0	7	double	1463.9	8	
1251.2	3		1331.3	6		1395.2	2		1465.2	3	
1253.2	6		1333.9	8	double	1396.4	7		1467.2	6	double
1253.9	5		1335.3	2		1397.5	6		1468.6	6	
1255.5	4		1336.1	8	double	1398.0	1		1471.0	3	
1257.1	4		1337.6	6		1399.0	7		1472.5	3	
1258.2	4		1338.7	7	double	1400.6	1		1473.9	5	
1259.9	4		1340.9	1	double	1402.0	4		1474.9	4	
1261.9	8		1342.4	8		1402.8	8		1476.4	4	
1264.0	1		1343.6	1		1404.3	5		1477.3	3	
1264.6	5		1345.4	8	double	1405.5	2		1478.9	2	
1265.8	4		1347.2	9	double	1407.3	7		1479.7	4	
1267.3	1		1349.1	2		1408.6	3		1480.4	4	
1268.3	1		1350.2	3		1410.5	8	triple	1481.7	5	
1269.1	3		1350.8	3		1411.8	1		1482.1	1	
1269.9	1		1352.5	8		1413.0	8		1483.7	3	
1270.7	4		1353.6	8		1414.9	2		1486.1	1	
1271.5	4		1355.5	7		1416.4	3		1486.9	9	
1272.0	1		1357.3	6		1419.5	2		1487.8	1	
1273.3	3		1358.2	4		1420.3	3		1489.3	6	
1274.2	1		1359.2	5		1426.8	3		1489.9	3	
1275.0	3		1360.1	5		1427.8	7	double	1491.9	7	
1276.1	1		1362.4	1		1429.0	3		1492.7	1	
1277.1	6	double	1363.4	8		1430.1	7		1494.1	3	
1279.0	1		1364.3	3		1431.1	3		1495.5	10	double
1279.8	5		1365.8	5		1433.0	8	double	1499.8	8	
1281.2	4		1366.5	1		1434.3	3		1502.2	2	
1282.6	1		1367.6	3	double	1435.2	4		1503.9	1	
1283.4	6		1368.0	3		1436.3	7	double	1505.0	8	
1284.5	5	double	1369.1	1	double	1438.0	4		1505.9	1	
1286.9	5	double	1370.4	2		1439.1	1		1506.6	1	
1288.1	4		1371.3	6		1441.0	8		1511.5	8	
1289.4	3		1372.1	1		1442.8	1		1513.6	7	
1290.4	5		1372.9	3		1443.6	7		1515.0	6	
1291.3	2		1374.0	1		1445.2	4		1516.4	5	
1293.6	6	double	1374.5	2		1446.2	6		1517.5	6	double
1295.7	2	double	1375.5	1		1447.4	2	?	1519.0	6	
1297.4	5		1376.1	1		1449.2	2		1520.1	5	
1299.5	1		1377.2	6	double	1450.3	5		1521.7	2	
1300.0	3	double	1378.0	1	double	1451.0	1		1522.5	2	



SPECTRUM OF HYDROGEN. — *Continued.*

Wave-Length.	Intensity.	Character.	Wave-Length.	Intensity.	Character.	Wave-Length.	Intensity.	Character.	Wave-Length.	Intensity.	Character.
1523.4	8		1556.4	2		1599.4	6		1625.8	4	
1525.4	5		1557.4	1		1602.0	8		1627.6	1	
1526.6	2		1558.7	1		1602.8	1		1628.5	8	
1527.5	4		1560.0	1		1603.8	1		1631.7	2	
1529.7	3		1561.1	2		1604.6	6		1633.7	6	
1530.9	6		1562.2	4		1605.3	5		1634.1	4	
1532.1	6		1563.0	1		1606.3	5		1635.3	3	
1533.2	6		1564.0	1		1607.7	10		1636.5	7	
1535.0	6	double	1565.1	3	double	1608.2	6		1638.2	4	
1536.7	1		1567.1	5	double	1608.6	10		1639.1	5	
1537.5	7	double	1569.2	6		1609.2	3		1639.7	1	
1539.2	5		1569.7	1		1610.1	2	triple	1640.5	6	
1539.9	2		1571.3	1		1610.5	7		1641.6	5	
1540.6	2		1571.7	7		1611.2	1		1643.0	5	
1541.6	7		1574.3	5		1611.8	3		1644.6	7	
1543.9	2		1577.2	8		1612.5	1		1645.7	2	
1544.7	8		1579.2	4		1613.3	7		1646.0	1	
1545.5	2	double	1581.0	7	double	1614.3	4		1647.8	1	
1546.4	6		1584.1	7		1615.0	3		1651.8	1	
1547.4	7	double	1585.7	7	double	1616.7	6		1654.2	2	
1548.3	1		1587.6	3		1617.9	1		1662.9	1	
1549.9	7	double	1589.0	8	triple	1619.9	2	double	1667.4	2	
1550.6	7	double	1590.9	4		1621.1	7	double	1670.2	1	
1551.5	2		1591.5	8		1622.1	3		1671.6	2	
1553.3	10		1593.6	7		1623.2	2		1672.4	2	
1554.9	3		1595.2	1		1623.8	7		1674.6	1	
1555.6	1		1596.2	10							

## LINES OF UNCERTAIN ORIGIN.

## PROBABLY DUE TO HYDROGEN.

Wave-Length.	Intensity.	Character.	Wave-Length.	Intensity.	Character.	Wave-Length.	Intensity.	Character.	Wave-Length.	Intensity.	Character.
1030.8	1		1104.8	6		1176.2	5	double	1209.2	6	
1031.2	2		1107.5	6		1178.5	3	double	1209.7	1	
1045.2	4		1110.5	3		1180.8	7		1210.8	2	
1047.5	5		1119.4	4		1182.7	4		1211.7	3	
1062.1	1		1145.5	8	double	1185.0	2		1215.0	2	
1065.6	3		1148.8	2		1189.0	7	double	1216.0	8	
1070.0	1		1151.2	2		1198.6	2		1217.6	3	
1080.0	1		1160.9	10	double	1200.2	2		1219.1	1	
1082.1	1		1164.0	6		1201.8	3		1221.5	1	
1094.9	2		1166.5	6		1202.8	1		1223.7	3	
1098.0	2		1169.2	1		1205.2	6		1225.2	1	
1100.0	3		1172.6	1		1206.9	6		1225.9	7	
1102.2	4		1174.9	1		1207.8	2		1227.5	1	



PLATE **III.**

Reproduction of Schumann's hydrogen spectrum from the Smithsonian Contributions to Knowledge  
No. 1413, with a scale of wave-lengths from the author's measurements.



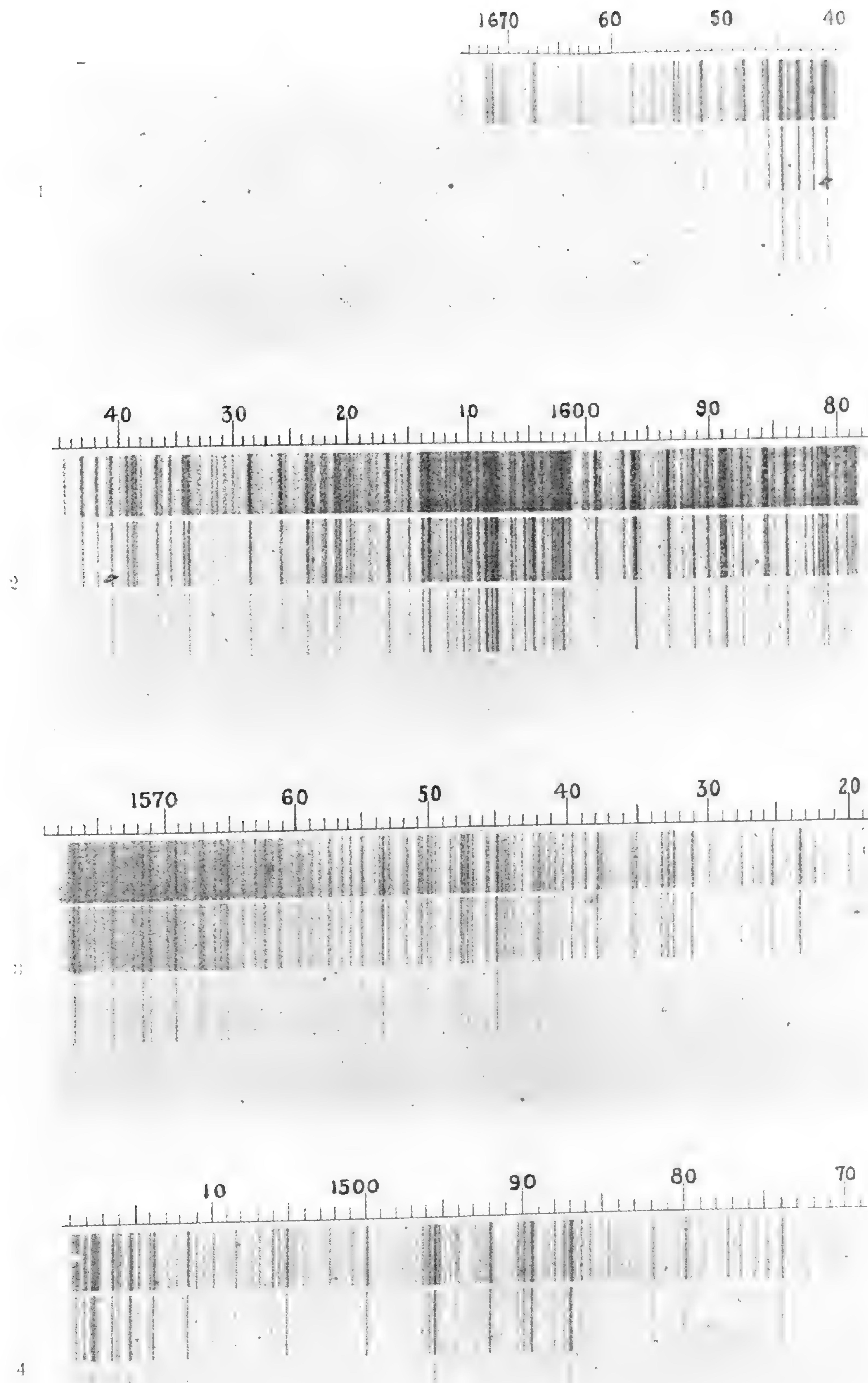



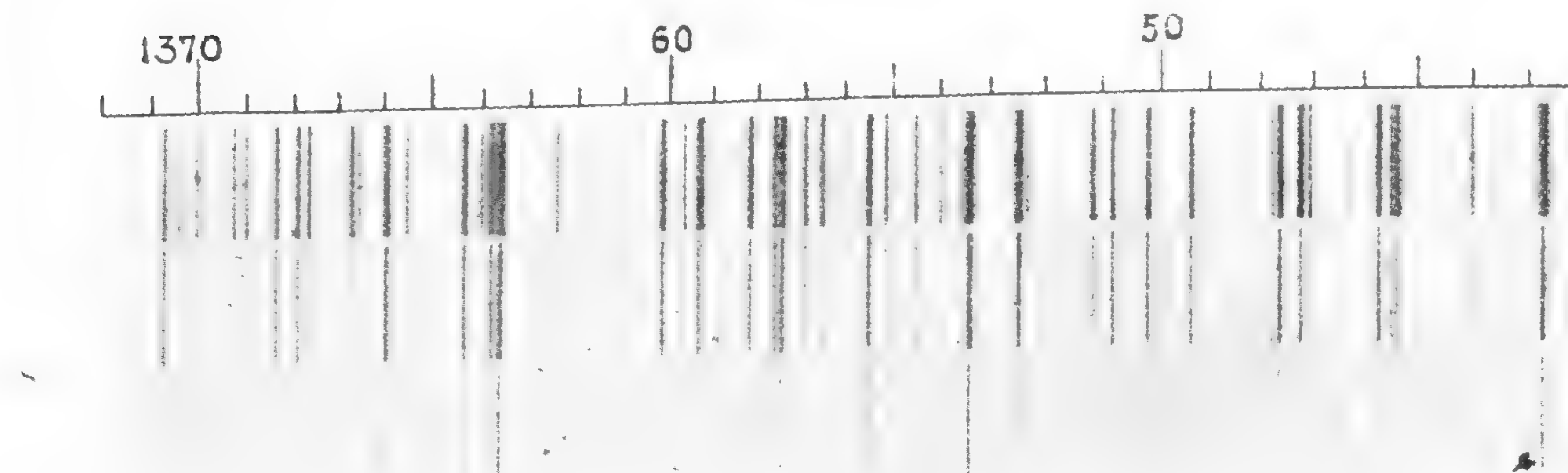
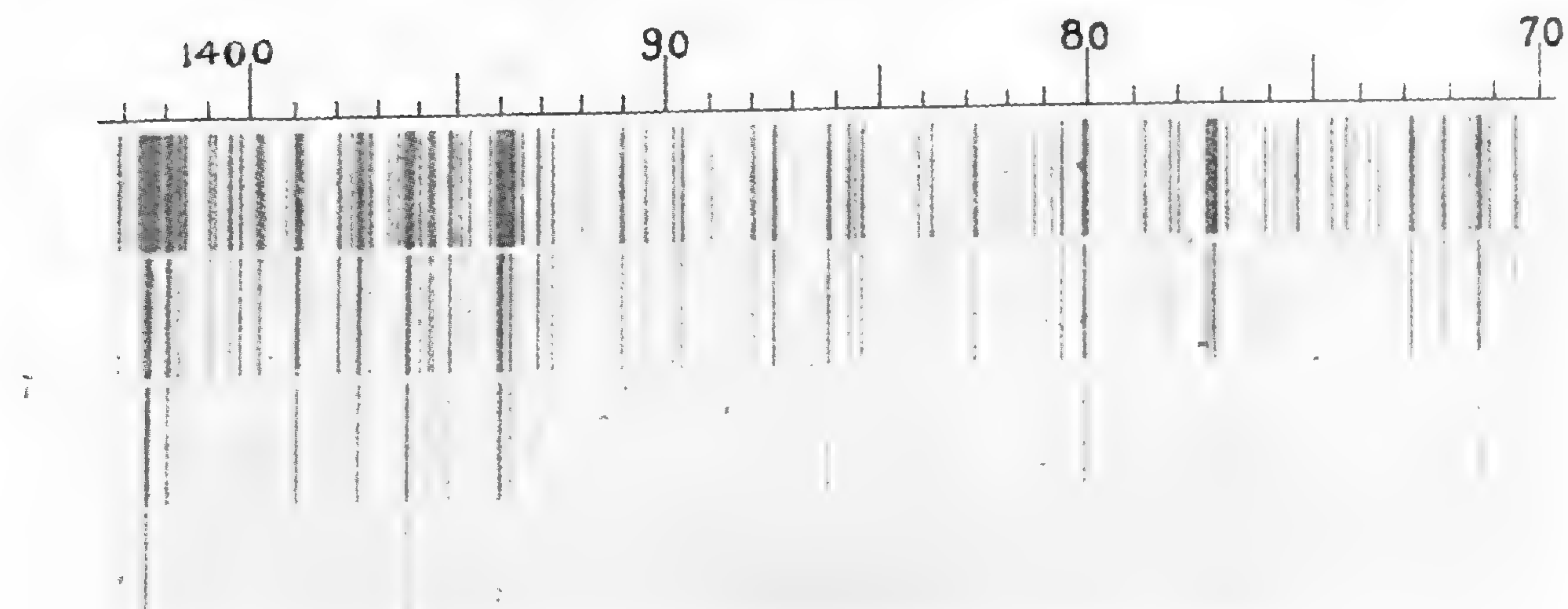
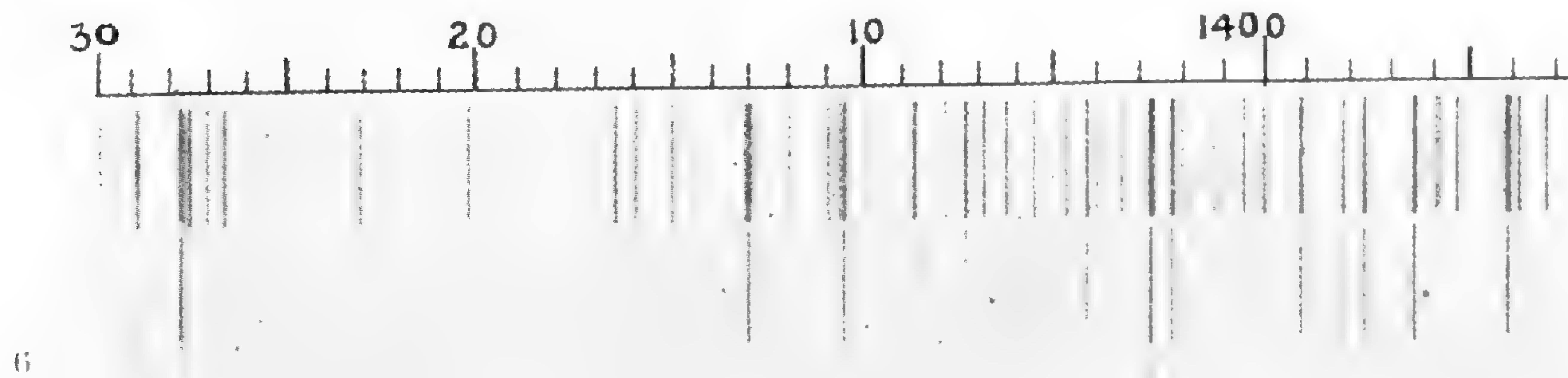
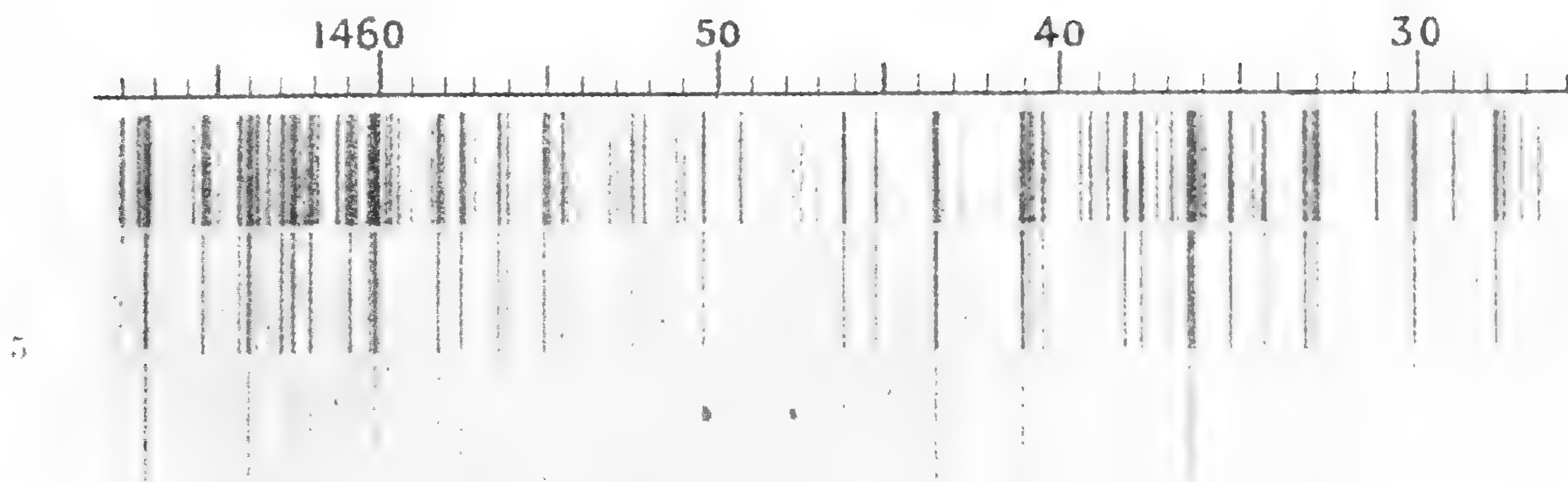



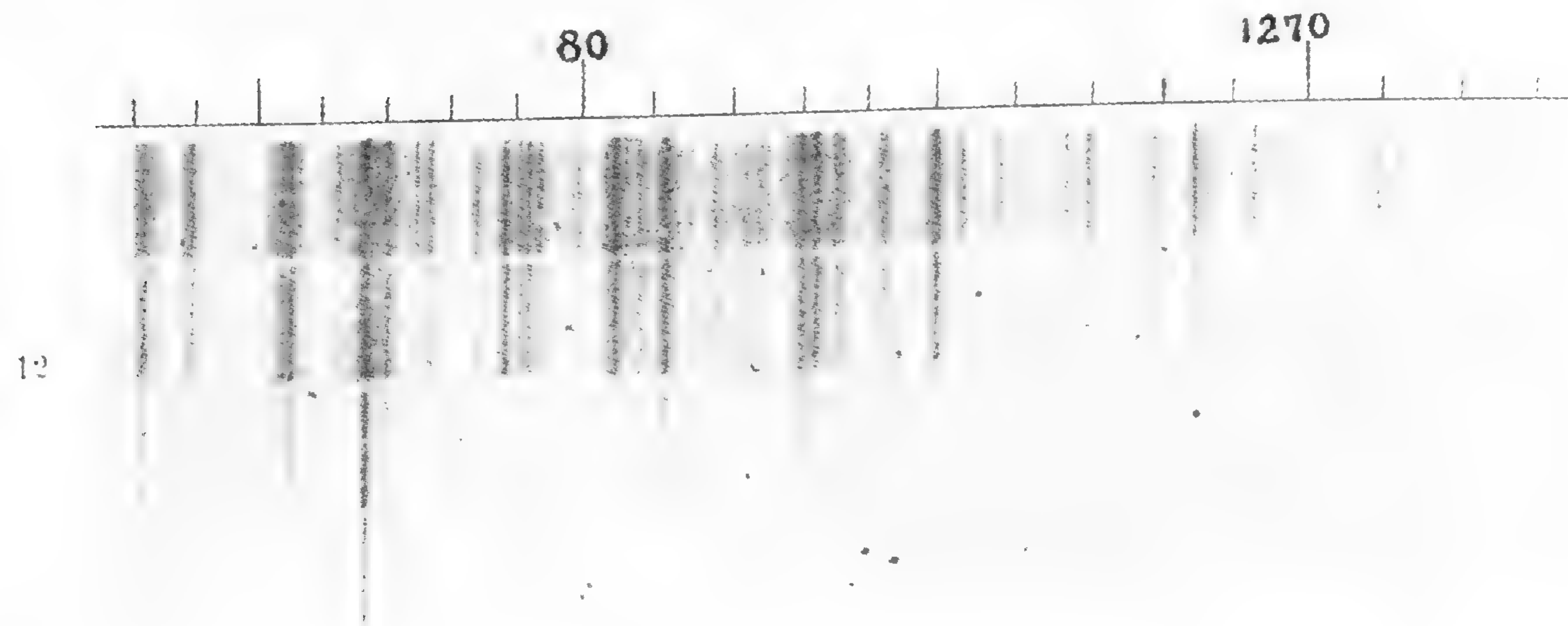
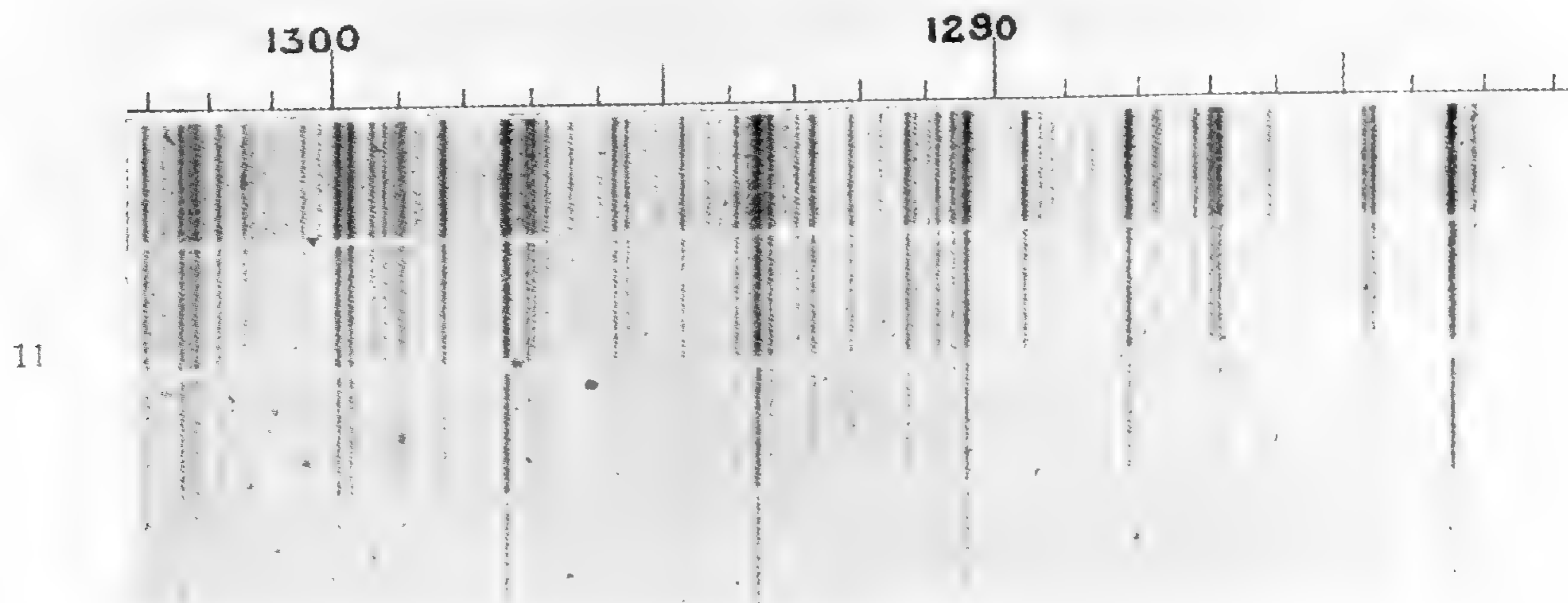
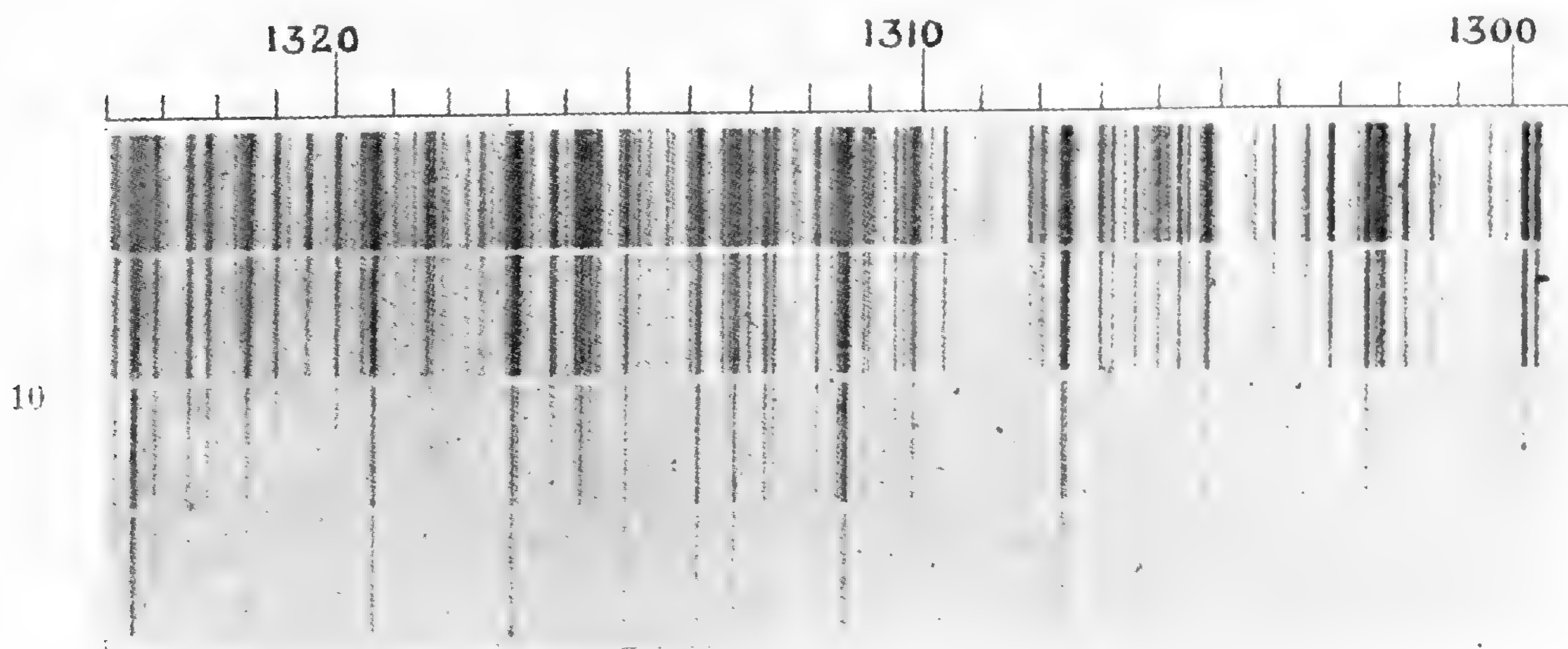
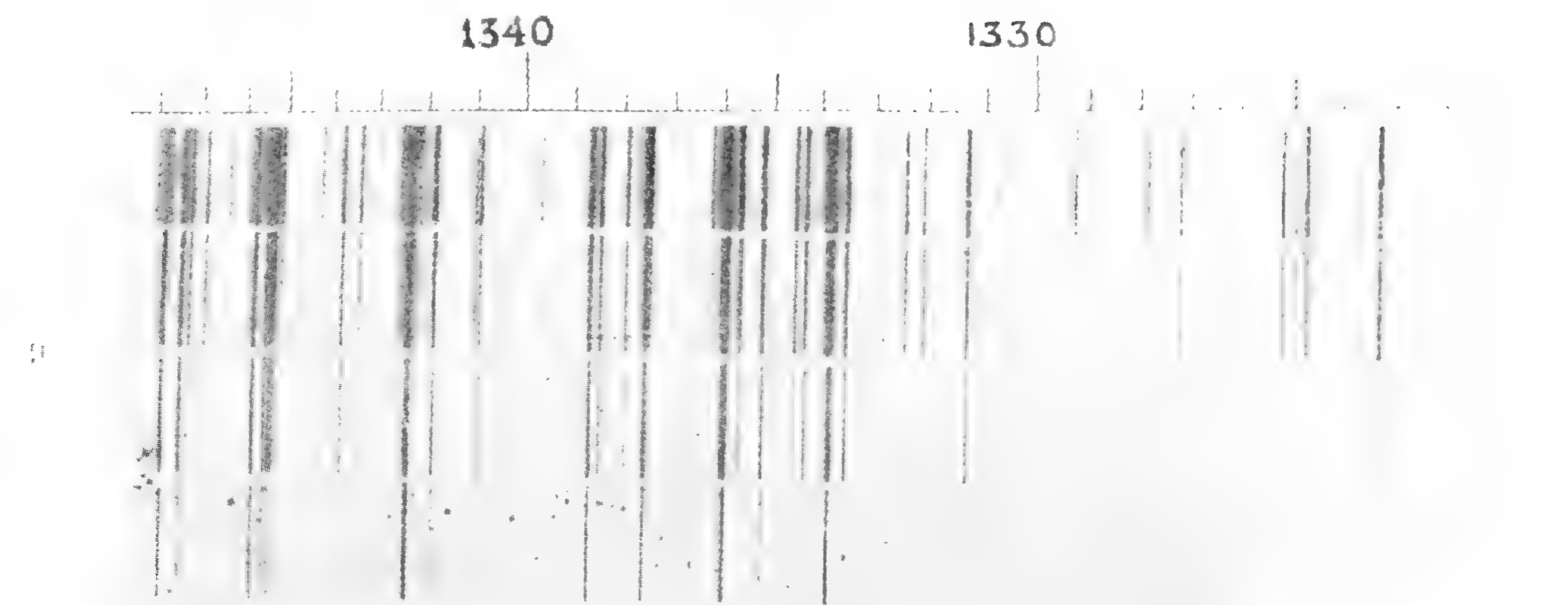



FIG. 1

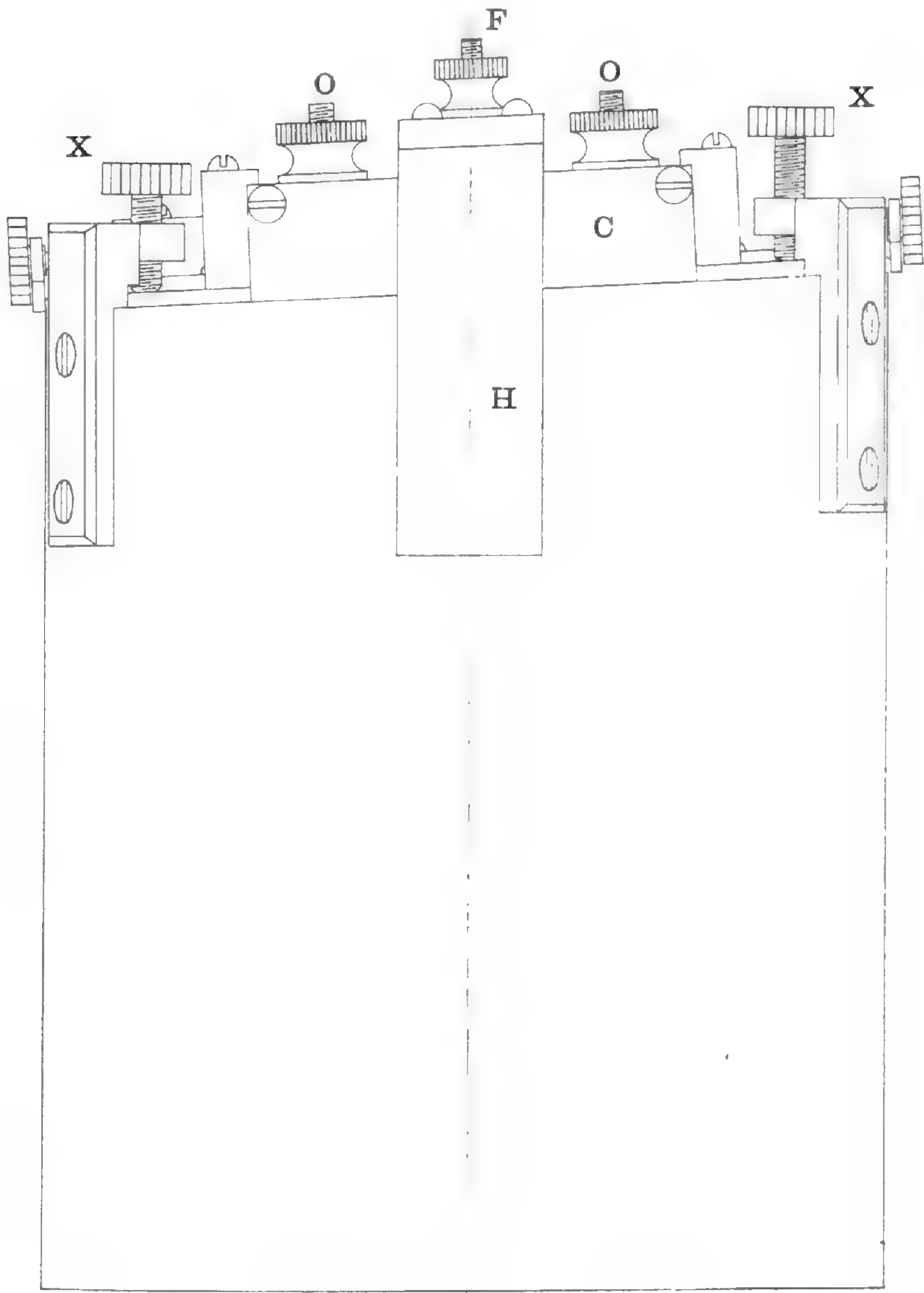

FIG. 2.

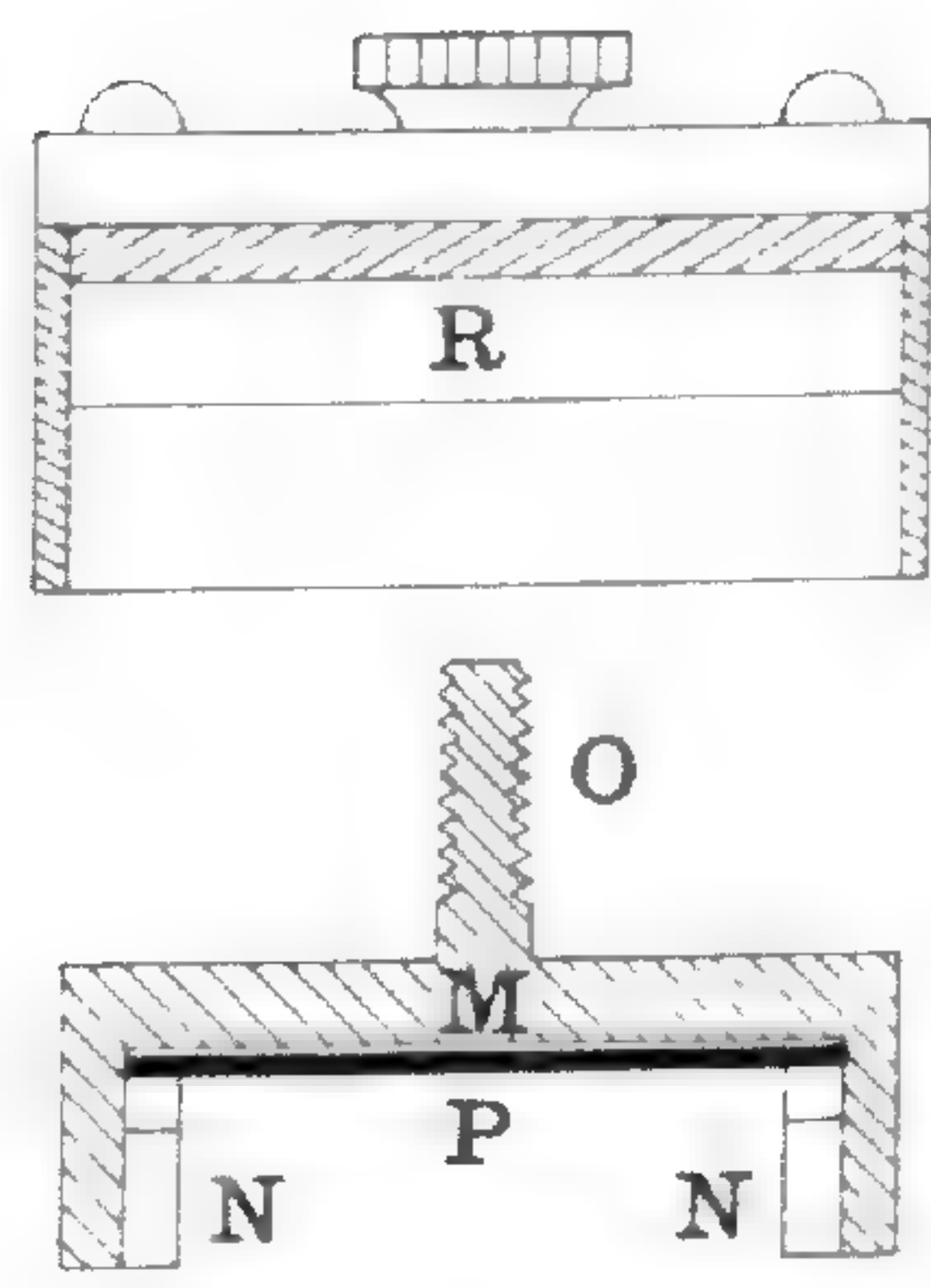
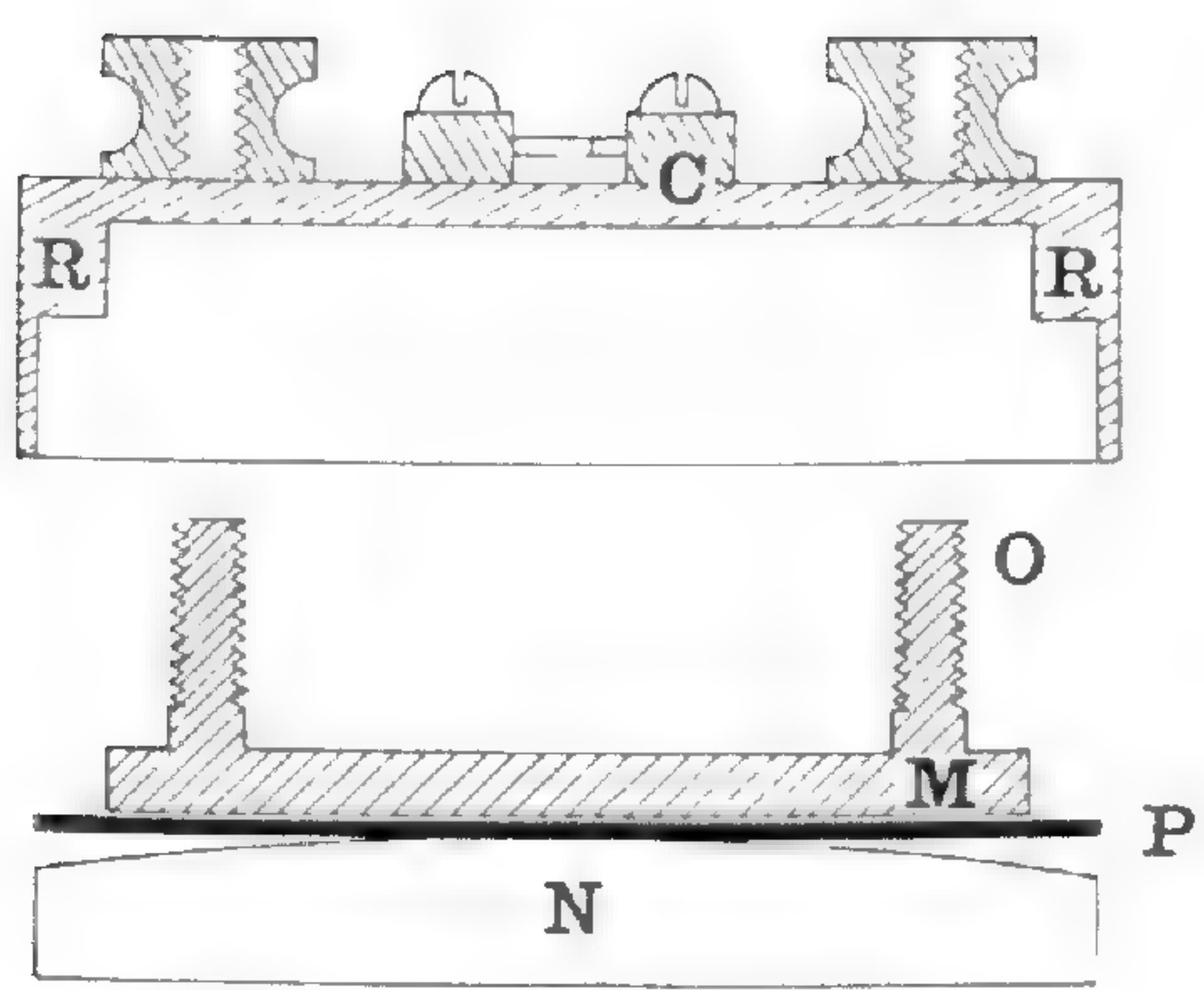
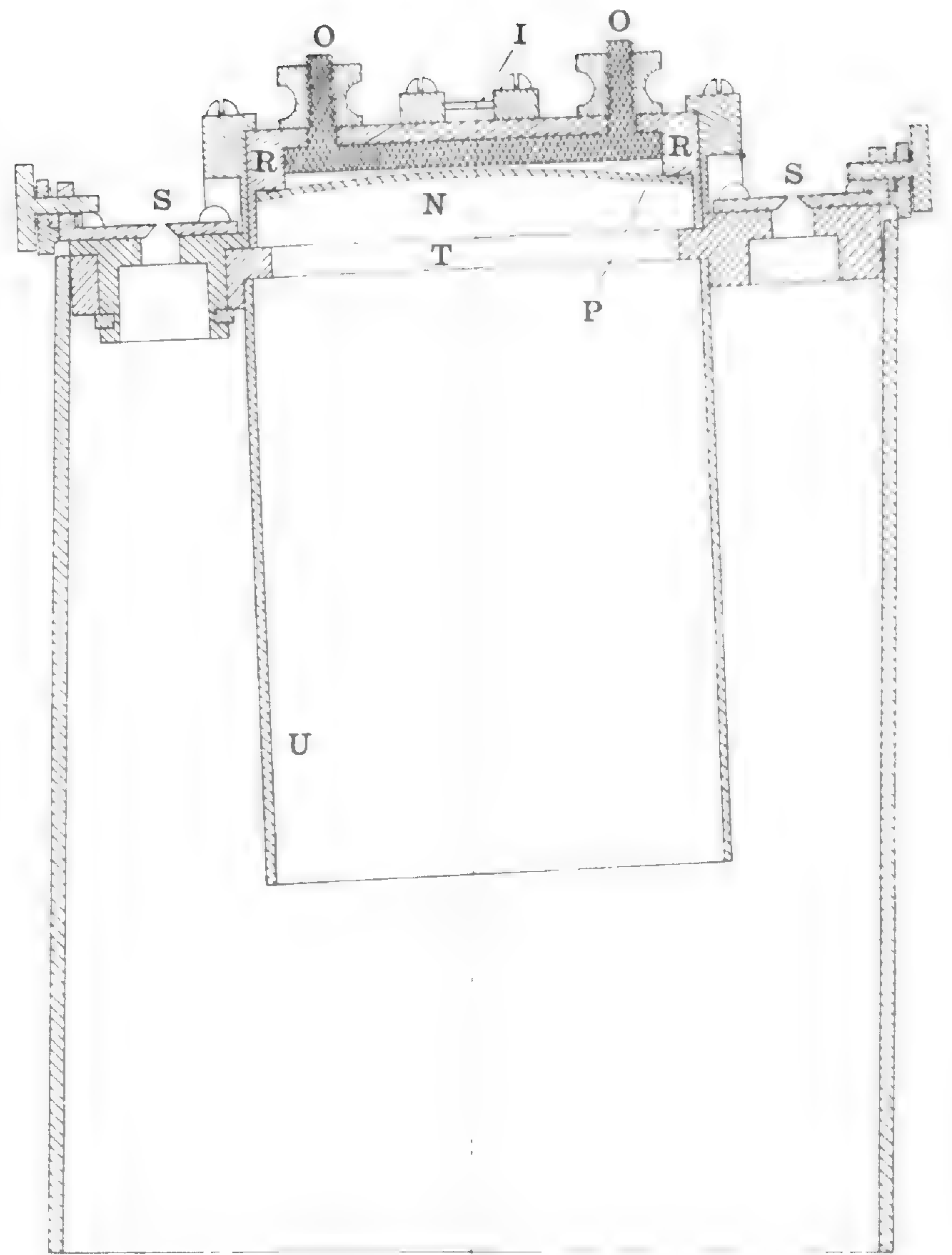

FIG. 3

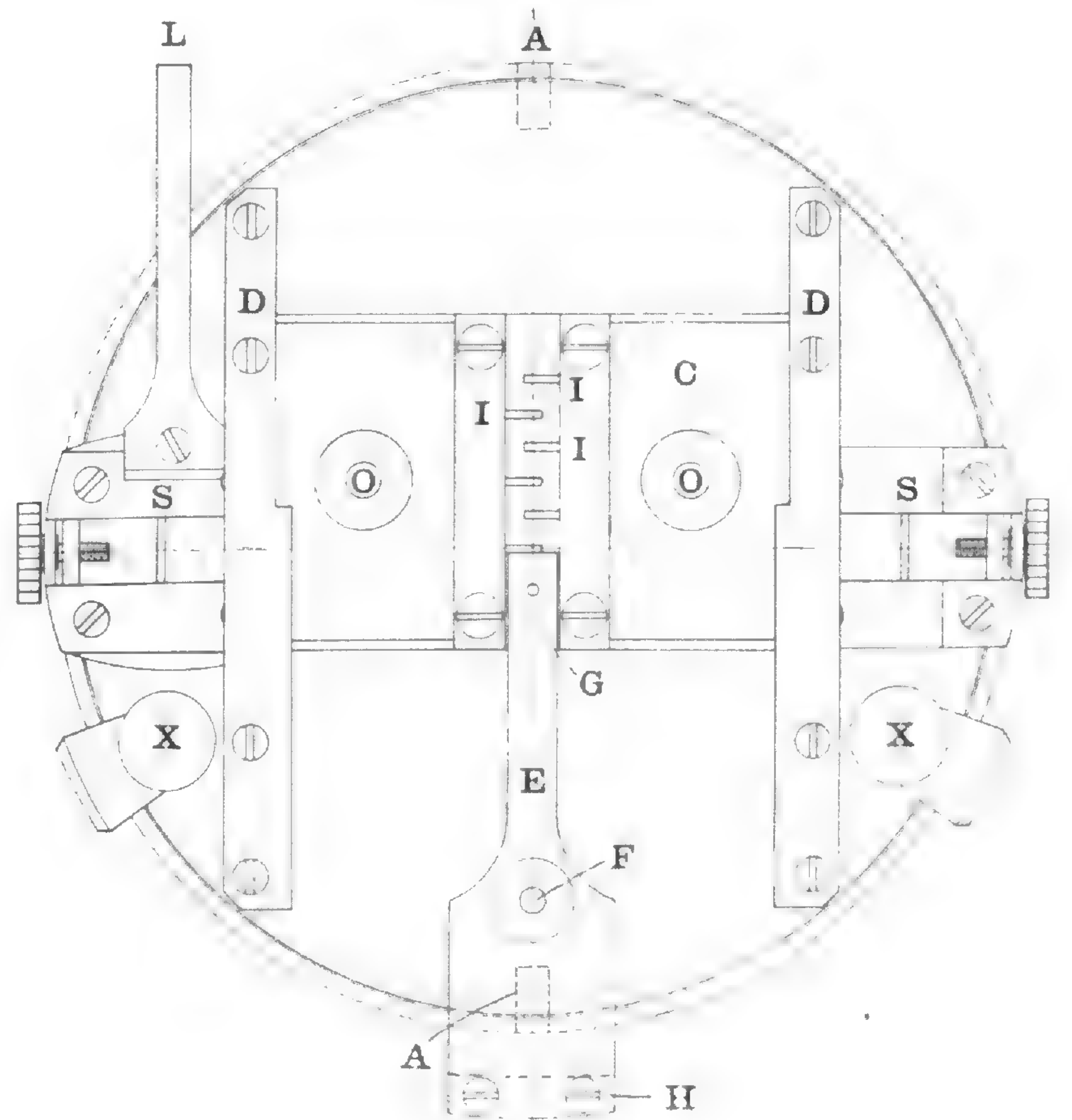
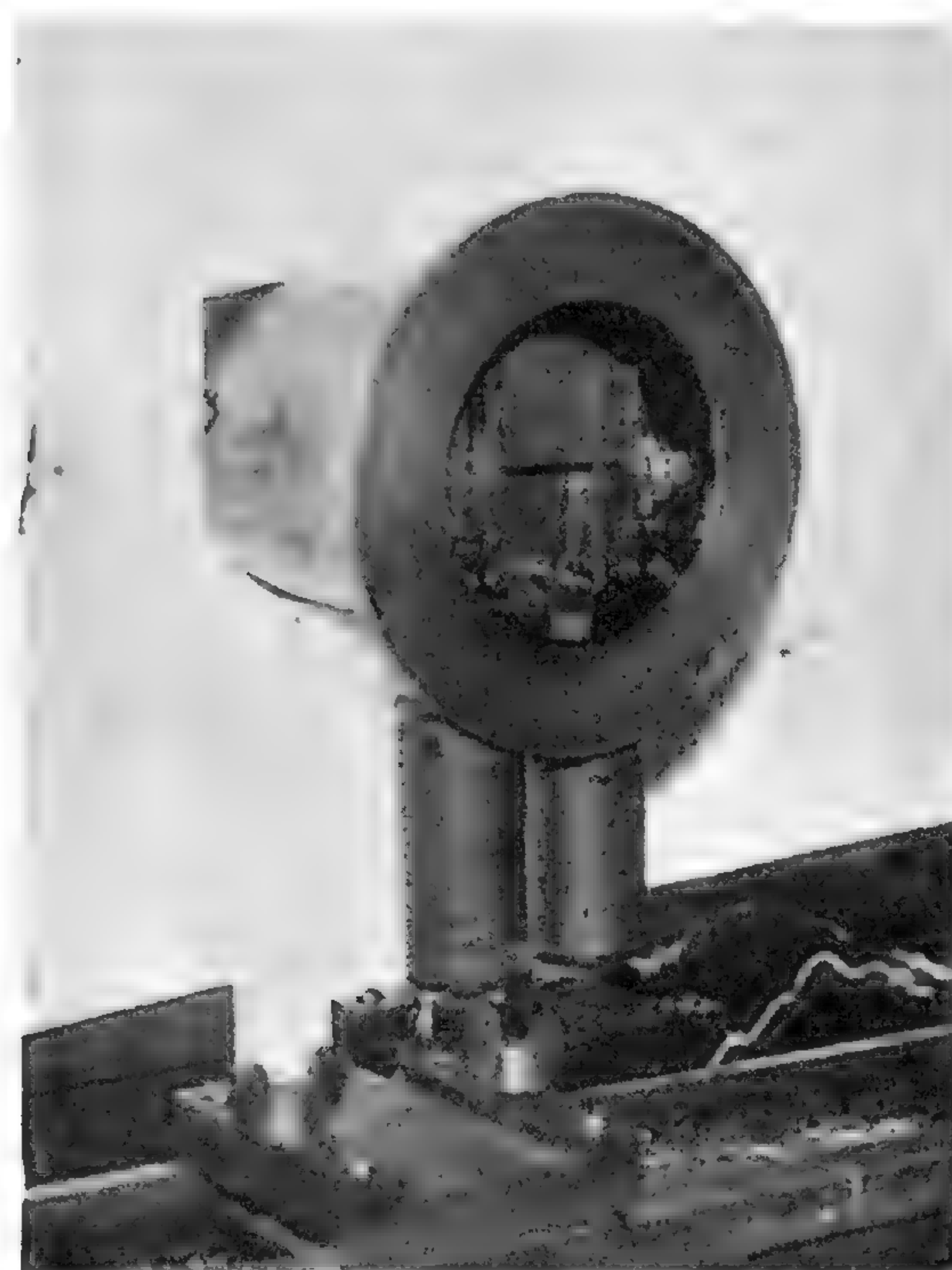
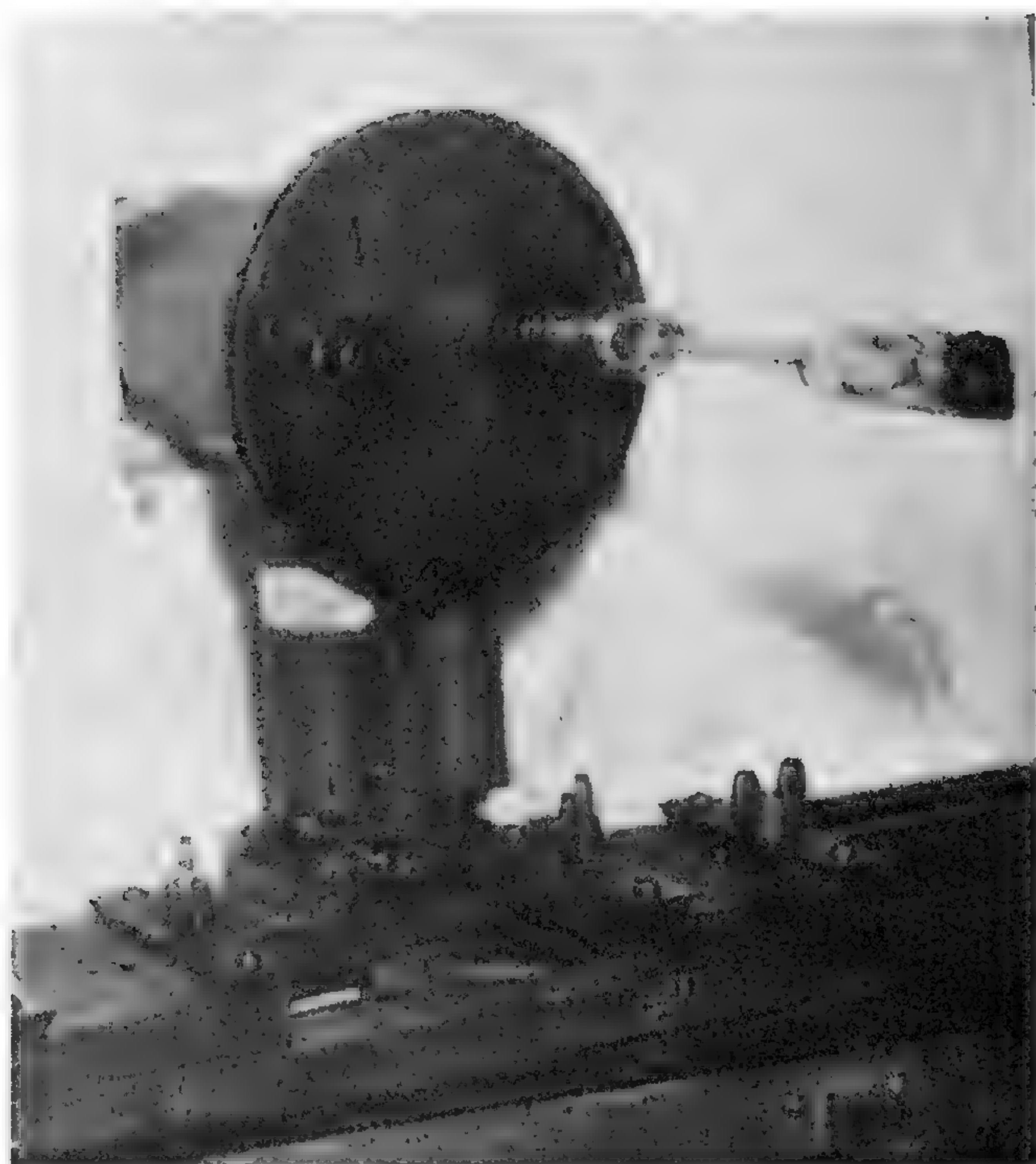
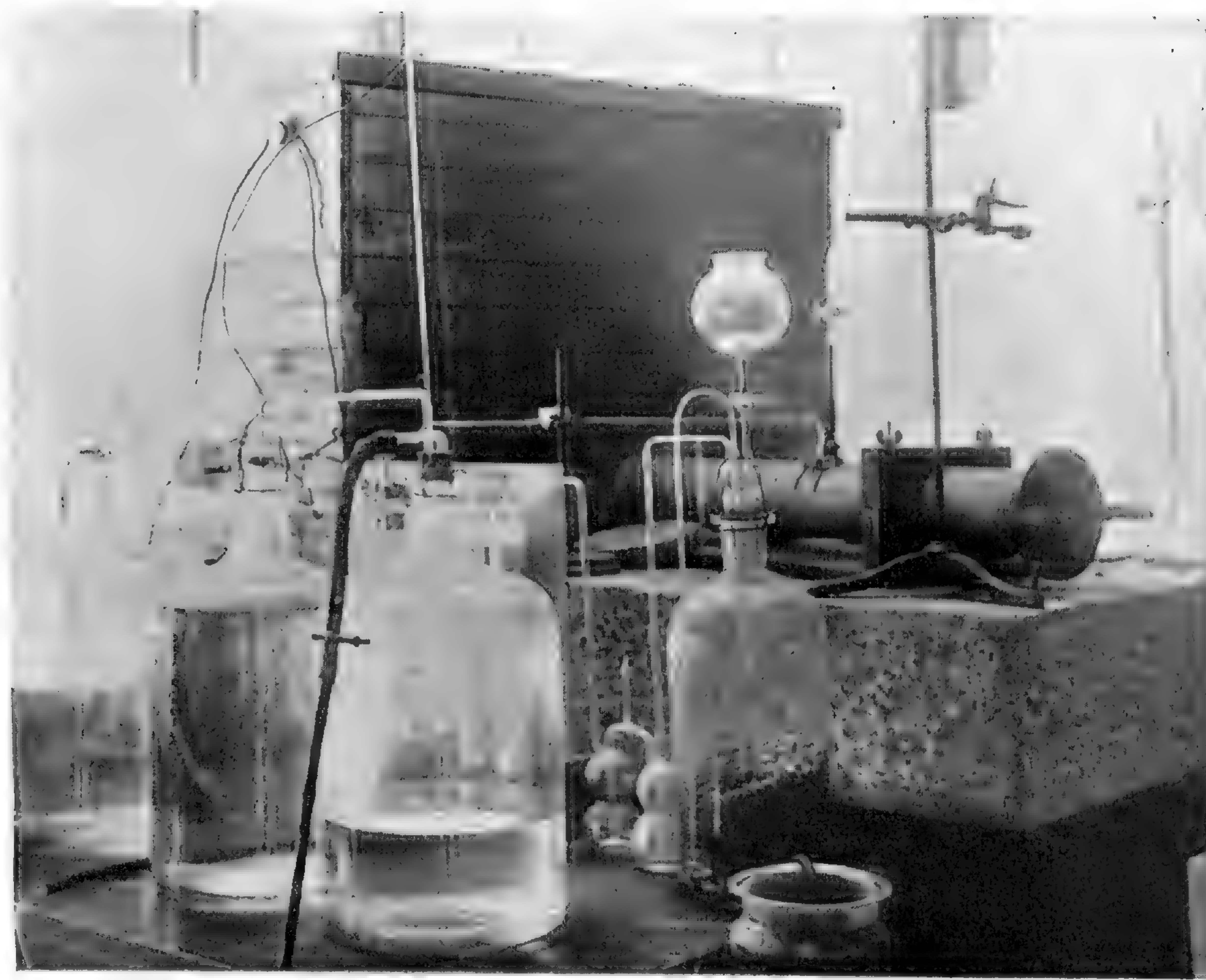




FIG. 1.







ABSORPTION OF FLUORITE.



**PUBLICATIONS**  
OF THE  
**AMERICAN ACADEMY OF ARTS AND SCIENCES.**

---

**MEMOIRS. OLD SERIES, Vols. 1-4; NEW SERIES, Vols. 1-12.**  
16 volumes, \$10 each. Half volumes, \$5 each. Discount to  
booksellers 25% ; to members 50% , or for whole sets 60% .

- Vol. 11.** PART 1. Centennial Celebration. 1880. pp. 1-104. 1882. \$2.00.  
PART 2. No. 1. Agassiz, A. — The Tortugas and Florida Reefs. pp. 105-134.  
12 pls. June, 1885. (Author's copies, June, 1883.) \$3.00.  
PART 3. Nos. 2-3. Searle, A. — The Apparent Position of the Zodiacal Light.  
pp. 135-157 and Chandler, S. C. — On the Square Bar Micrometer. pp. 158-178.  
October, 1885. \$1.00.  
PART 4. No. 4. Pickering, E. C. — Stellar Photography. pp. 179-226. 2 pls.  
March, 1886. \$1.00.  
PART 4. No. 5. Rogers, W. A., and Winlock, Anna. — A Catalogue of 130 Polar  
Stars for the Epoch of 1875.0, resulting from the available Observations made  
between 1860 and 1885, and reduced to the System of the Catalogue of Publi-  
cation XIV of the Astronomische Gesellschaft. pp. 227-300. June, 1886. 75c.  
PART 5. No. 6. Langley, S. P., Young, C. A., and Pickering, E. C. — Pritchard's  
Wedge Photometer. pp. 301-324. November, 1886. 25c.  
PART 6. No. 7. Wyman, M. — Memoir of Daniel Treadwell. pp. 325-523.  
October, 1887. \$2.00.

- Vol. 12.** 1. Sawyer, E. F. — Catalogue of the Magnitudes of Southern Stars  
from 0° to -30° Declination, to the Magnitude 7.0 inclusive. pp. 1-100. May,  
1892. \$1.50.  
2. Rowland, H. A. — On a Table of Standard Wave Lengths of the Spectral  
Lines. pp. 101-186. December, 1896. \$2.00.  
3. Thaxter, R. — Contribution towards a Monograph of the Laboulbeniaceæ.  
pp. 187-430. 26 pls. December, 1896. \$6.00.  
4. Lowell, P. — New Observations of the Planet Mercury. pp. 431-466. 8 pls.  
June, 1898. \$1.25.  
5. Sedgwick, W. T., and Winslow, C. E. A. — (I) Experiments on the Effect of  
Freezing and other low Temperatures upon the Viability of the Bacillus of  
Typhoid Fever, with Considerations regarding Ice as a Vehicle of Infectious  
Disease. (II) Statistical Studies on the Seasonal Prevalence of Typhoid  
Fever in various Countries and its Relation to Seasonal Temperature. pp. 467-  
579. 8 pls. August, 1902. \$2.50.

- Vol. 13.** 1. Curtiss, D. R. — Binary Families in a Triply connected Region,  
with Especial Reference to Hypergeometric Families. pp. 1-60. January, 1904.  
90c.  
2. Tonks, O. S. — Brygos: his Characteristics. pp. 61-119. 2 pls. November,  
1904. \$1.25.

**PROCEEDINGS. Vols. 1-40, \$5 each.** Discount to booksellers  
25% ; to members 50% , or for whole sets 60% .  
The individual articles may be obtained separately. A price list of recent  
articles is printed on the third page of this cover.

Complete Works of Count Rumford. 4 vols., \$5.00 each.  
Memoir of Sir Benjamin Thompson, Count Rumford, with Notices of  
his Daughter. By George E. Ellis. \$5.00.

Complete sets of the Life and Works of Rumford. 5 vols., \$25.00 ;  
to members, \$5.00.

For sale at the Library of THE AMERICAN ACADEMY OF ARTS AND  
SCIENCES, Corner of Boylston Street (No. 1154) and The Fenway,  
Boston, Massachusetts.



MEMOIRS  
OF  
THE AMERICAN ACADEMY  
OF  
ARTS AND SCIENCES



VOL. XIII. — No. IV.

CAMBRIDGE:  
JOHN WILSON AND SON,  
University Press.  
NOVEMBER, 1906.



IV.

LUNAR AND HAWAIIAN PHYSICAL FEATURES COMPARED.

BY

WILLIAM H. PICKERING.

---

WITH SIXTEEN PLATES.

---

PRESENTED FEBRUARY 9, 1906. RECEIVED APRIL 7, 1906.



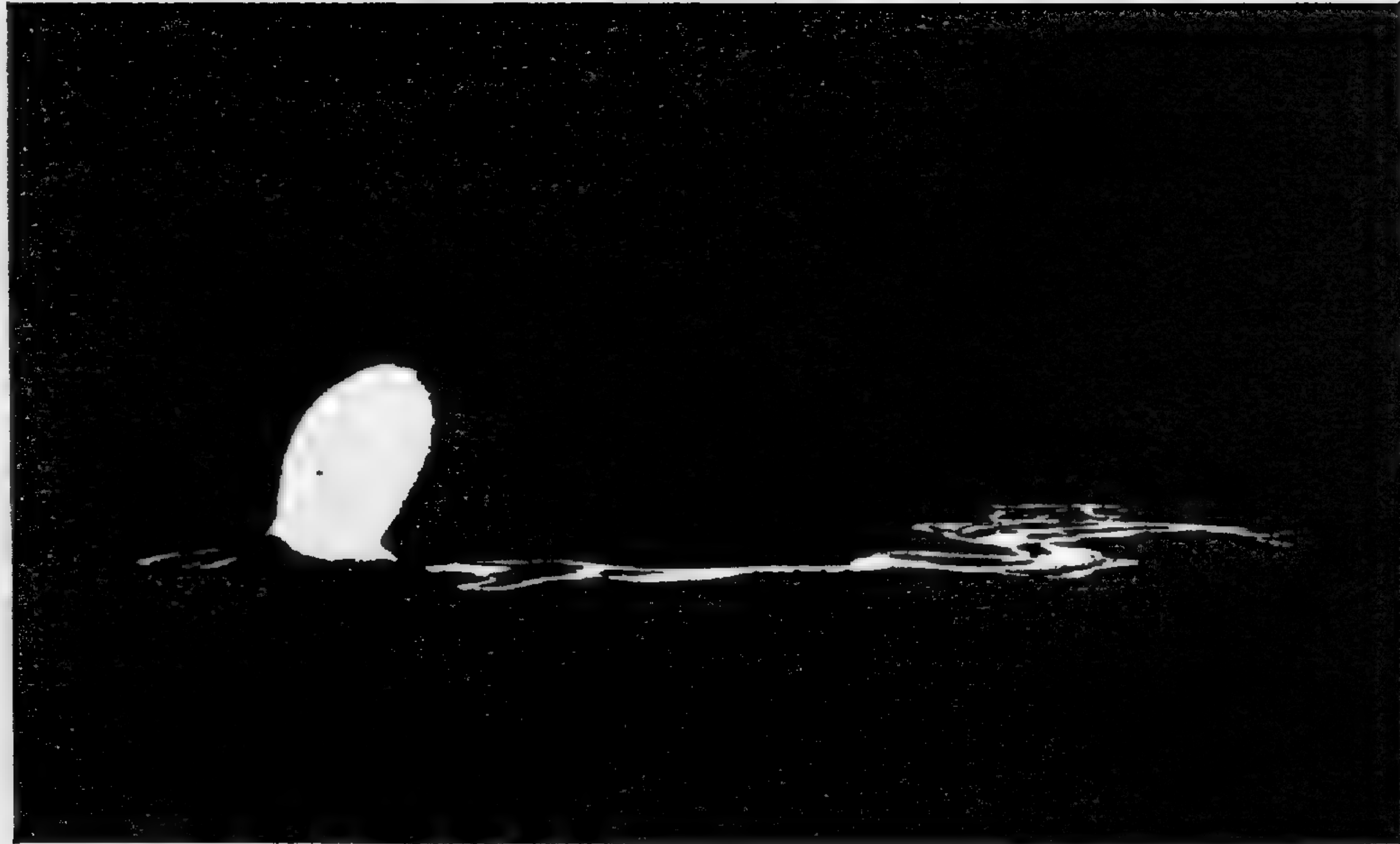

MOKUAWEOUEO AT NIGHT.

Compare with Figure 18 taken at about the same date.



## LUNAR AND HAWAIIAN PHYSICAL FEATURES COMPARED.

THE lunar surface presents such a strong contrast to the more thickly populated portions of the Earth, that little resemblance between them can be traced. It has therefore naturally proved very difficult to explain the nature and origin of many of the features of our satellite. Even those of our volcanic regions which have been most extensively studied, show little analogy to the Moon. There are other regions, however, notably in the Hawaiian Islands, where an entirely different class of volcanic phenomena are exhibited. These it is now found bear a striking resemblance in some respects to what we find upon our satellite. Although the Hawaiian craters are mostly extinct, or at present inactive, yet they are the only ones known of this type exhibiting any activity whatever.

In view of these facts the writer determined to visit the Hawaiian Islands in the summer of 1905, and study their volcanic features with especial reference to those found upon the Moon. In Hawaii a considerable number of the craters are of the engulfment type, as distinguished from those of the explosive type, so well developed in southern Europe. In the latter class a high truncated cone is built up by mild eruptions of steam and cinders, sometimes alternating with lava. At long intervals violent explosions occur, which sometimes blow away a large portion of the summit, thus entirely changing the shape of the mountain. Such an explosion of steam occurred in Vesuvius at the time of the destruction of Pompeii, and a still more violent one in Krakatoa in 1883. Nothing whatever of this sort is found upon the Moon. In volcanoes of the engulfment type on the other hand, comparatively little steam is evolved, often there is no exterior cone, and the craters enlarge quietly by the cracking off and falling in of their walls.

The Hawaiian structures, although similar to those of the Moon, are comparatively on a very small scale, and their dimensions must often be multiplied by a factor of from 100 in the case of the older craters, to 300 in the case of the more recent ones, in order to equal the dimensions of the similar formations found upon our satellite. This applies especially to horizontal distances, — vertically a factor of from 10 to 20 more nearly represents the proper proportion.



The force of gravitation at the surface of the Moon is but one-sixth as great as it is upon the Earth, and this difference is usually given as the cause of the great comparative size of the lunar formations. On the old theory that the lunar craters were due to explosions of steam, like our explosive volcanoes, it was evident that matter expelled from a crater vent could be thrown six times as far as upon the Earth. Although this theory is now practically abandoned, gravitation would still have an influence on the relative size, since a cliff or pinnacle upon the Moon could be six times the height of one upon the Earth, and yet exert no greater crushing force on the material beneath it. Still it is very evident that this explanation alone is inadequate to account for the great difference in size actually observed.

The facts seem to be that we are really trying to compare objects formed under entirely different conditions. The larger craters on the Moon came into existence when the thin, solid crust covering the molten interior was, owing to the solidification and contraction of the crust, much too small to contain the liquid material. The craters were therefore formed by the lava bursting through the crust, and so relieving the pressure.

Later, after this relief had been found, and the crust had thickened, the interior regions by cooling shrank away from the solid shell which was now too large, and being insufficiently supported caved in, permitting the great fissure eruptions which produced the *maria*. These extensive outflows of lava dissolved the original solid shell wherever they came in contact with it much as they do at the present day in Hawaii. Had the Moon been much smaller, these extensive eruptions would not have attained such relatively great size, or might even not have occurred at all. On the other hand, had the Moon been larger, their relative size would have been greater, since the volume of the sphere would have been larger in proportion to its surface and would therefore have shrunk more in proportion. This was precisely what took place upon the Earth in all probability: our original gigantic craters were destroyed by the outflow of the earlier archaic rocks, which completely submerged and dissolved them. Our present Hawaiian craters must therefore be compared, not with the primary formations still left upon our Moon, but rather with the secondary ones formed later upon the surface of its *maria*. Of these Bessel, twelve miles in diameter, is a large and well known example. From this size down countless craterlets are known.

Three craters are found upon the Earth measuring about fifteen miles in diameter. They occur in Kamchatka, in Japan, and in the Philippines, but are all of the explosive type, and therefore not comparable to those found on the Moon. It is possible



that a large engulfment crater formerly existed upon Kauai, and another in southern Hawaii, near the coast, south of Mauna Loa, but the writer was unable to examine either of these regions during his recent visit. The latter crater must have been about five miles in diameter, the former perhaps much larger. The largest engulfment crater known is Crater Lake, Oregon, measuring five by six miles in diameter, with a depth of about 3,000 feet. Next to it comes Haleakala in the Island of Maui, Hawaii, measuring seven miles in length by two in width. It is about 2,000 feet deep.

The secondary craters found upon the lunar *maria* are so small that it is impossible to study their interiors to advantage; we shall therefore content ourselves with comparing the Hawaiian formations, as far as possible with the large primary formations of the Moon, without regard to the great discrepancy in their relative size.

On the Hawaiian Islands with the exception of the three great craters of Haleakala, Mokuaweoweo, and Kilauea, few of the crater pits exceed half a mile in diameter, measured on their crater floors, or former free liquid lava surfaces, although there are probably several hundred pits over 200 feet in diameter. In addition to these are countless cinder cones, spiracles, etc. On the Earth at present the cooling process always intervenes before great size is attained. Doubtless formerly the lava was hotter when it first issued from the interior than it is now, also the solid crust resting on the liquid mass was thinner, so that the channel communicating with the interior was shorter and of greater diameter, thus offering a freer passage to the liquid flow.

Terrestrial craters may be divided into three classes, according to the materials of which they are composed. These are (a) tuff or tufa cones, which are made of hardened volcanic mud, (b) cinder cones, made of scoria, lapilli, or sand, that is, lava broken up into masses of varying size, by the action of steam, from stones several inches or even feet in diameter to fine powder, and (c) lava craters, where the lava occurs in unbroken masses. It is this third class, where less water is involved in the eruption, which most resembles what we find upon the Moon. Representatives of all three classes are to be found in Hawaii. Many volcanoes like Vesuvius eject both cinders and lava.

The third class may again be divided into four subdivisions according to the shape of the craters, namely: lava cones, lava pits, lava rings, and lava bowls. Although sometimes of small size, the lava cones often emit vast volumes of lava, which taking the form of broad streams may extend for many miles. The lava pits are by far the



most numerous group, and most widely distributed throughout the islands. They have no outer slopes whatever, consisting simply of a pit sunk in the ground. Their walls are sometimes vertical, descending without talus to a flat floor; sometimes the talus is present, and may cover the whole floor, leaving the bottom as a conical pit. Sometimes the walls are inclined, descending at a uniform slope to a flat floor. The slope in this case is usually steep, — perhaps  $45^{\circ}$ . The crater rings are the rarest type, and resemble the larger craters found upon the Moon. They have flat floors and sloping inner and outer walls. The crater bowls differ from them in that the bottom instead of presenting a well-defined flattened floor is concave, the curvature being continuous with that of the walls. They are identical in appearance with most of the smaller lunar craters. Section drawings illustrating these different forms will be found on p. 171, and will be described when the various types are reached. Photographs of many of them are also given at the end of this memoir.

In addition to the craters, there are found numerous other interesting formations, such as lava caves, channels, cracks, spiracles, pinnacles, ridges, etc. A spiracle is literally a blow hole, but in this paper, for lack of a better name, I have used the word to indicate the solid formation surrounding the hole. In dealing with these various objects it has been thought best to describe each class by itself, stating where the best specimens of each may be seen.

The visitor to Hawaii, on entering the harbor of Honolulu, is at once struck with two very conspicuous volcanic formations, known as Diamond Head and the Punchbowl. Other smaller and less conspicuous craters, of the same general type, will be found in the immediate vicinity. The Punchbowl, *a*, p. 171, reaches an altitude of 498 feet, and is situated within the city limits. The crater is but slightly concave, being filled nearly to the brim, and has a diameter of 2500 feet. The writer did not have an opportunity to examine it carefully, but as it was evidently similar to Diamond Head, *b*, p. 171, which was larger, and apparently better preserved, this was not greatly regretted.

From every direction Diamond Head, Figure 1, presents an appearance similar to a lunar crater. Its highest point reaches an altitude of only 761 feet above the sea, while the diameter of the crater rim measures 3200 by 3700 feet. An ascent of the rim on foot is easily made from a point on the road just beyond the terminus of the electric car line. The rim at this point has an altitude of 450 feet. In the interior of the crater, somewhat to one side of the centre, is located a shallow lake, sometimes dry, whose bed measures 220 feet below the rim where we crossed it. It is surrounded by a very dense growth of thorny shrubs. Within the crater was found



a specimen containing a fossil shell, which was doubtless brought up from the ocean bed by the erupted material when the crater was active. A branching system of cracks, none of them exceeding three inches in width, was found in one place. The inner slopes of the crater range from  $20^{\circ}$  to  $45^{\circ}$ , the outer from  $30^{\circ}$  to  $70^{\circ}$ . Clearly the walls were formerly somewhat higher, and the interior and exterior of the crater about on a level. The edge of the rim is extremely sharp in places. The material is composed of a hardened volcanic mud or tuff, and while the crater somewhat resembles numerous of the smaller lunar craterlets, yet their interiors are always at a lower level than the exterior plane on which they are situated, and their inner slopes are steeper than their outer ones. The crater seems to offer little analogy therefore to the formations upon the Moon.

Cinder cones, *c p.* 171, form the most numerous class of craters in Hawaii. They are found scattered over the summit of Mauna Kea, in the valley between Mauna Kea and Mauna Loa, in the interior of Haleakala, along the southern and northwestern coasts of Hawaii, and in many other places. A group situated near the summit of Mauna Kea is shown in Figure 2. They have all the characteristics of explosive volcanoes like Vesuvius, although their craters are larger in proportion to the height of their cones. So far as is known they bear no analogy to anything found upon the Moon.

The third class, or lava craters, on the other hand, present a close resemblance in many respects to some of the lunar formations, and we shall therefore describe them in detail. The first subdivision, the lava cones, are most strikingly represented by Mauna Loa, by far the world's largest volcano. It and Mauna Kea are also our highest mountains if we measure in every case from the mountain's base. For the Hawaiian volcanoes the base lies 15,000 feet below the level of the sea. Nevertheless, the summit crater of Mauna Loa is so large in proportion to its depth that it was thought best to select a small lava cone in Haleakala as the typical example of this form of crater. This cone is shown in the right foreground of Figure 3, and its section at *e* on p. 171. The outer slopes of a lava cone are often covered by loose cinders, as in the present case, and the inner slopes may be inclined like those of a cinder cone, although they are generally much steeper, but if the inner walls are of lava its classification is assured. Lava sometimes issues from the summits of these cones, but sometimes it comes directly out of the ground, as in Kilauea Iki and at Huehue, — no trace of a cone being found.

Lava has not been known within historic times to overflow the summit crater of Mauna Loa, but it escapes from just below the summit, outside the crater walls, in



enormous quantities, especially upon the northeastern side. The vast bulk of the mountain seems to have been built up largely from these emissions, and the same is true also of Mt. Etna in Sicily. It is characteristic of these mountains that their slopes are much more gentle than those of cinder cones, and this is especially true of Mauna Loa, Figure 4. The summit of this mountain is 13,675 feet in elevation. The view was taken from the north, and represents the upper 7000 feet of the mountain. The summit is very difficult of access on account of the exceedingly rough nature of the ground, the total absence of water, and on account of its flatness of the long distance of the summit from a base of supplies. It is probably best reached from the Kona, or western side, by way of Kealakekua Bay.

The slopes of Etna are heavily buttressed by ridges, formed each of a separate lava stream, which has flowed from the small lava cones upon the flanks of the mountain. This structure is also well shown in the lunar crater Bullialdus, Figure 5. The diameter of this crater is 38 miles. Since these streams sometimes cross one another, leaving diamond-shaped hollows between them, it is obvious that the formation cannot be due to the grooving of a smooth surface by erosion, but must really be formed by projecting ridges. We shall refer again to this matter in connection with Clavius and Kilauea Iki. We thus have indirect evidence of the existence of lava cones upon the Moon, as the source of these streams.

Until recently this was all the evidence we had. The tall volcanic cone with the comparatively minute crater at its summit, so characteristic of the typical terrestrial volcano, was supposed to be absent from the Moon. In the terrestrial volcano the floor of the crater is always higher than its base; on the Moon the reverse is true. A recent examination of a lunar photograph taken at the Yerkes Observatory by Professor Ritchey has shown, however, that the terrestrial type of volcano is not wholly absent from the Moon. Craters of this type have not been found before, merely because, like those on the Earth, they are very small. Figure 6 represents the two craters Kies and Mercator. Between them is seen a comparatively small cone with a minute crater upon its summit. It proves to be nine miles in diameter at its base, and 2000 feet in height, while the crater itself measures half a mile in diameter. For purposes of comparison we may say that the diameter of the base of Vesuvius, including Monte Somma, is eight miles, and its height 4000 feet. The diameter of its crater, which varies with every eruption, rarely exceeds one quarter of a mile, and is sometimes but a few hundred feet. The mean angle of the slope of Vesuvius is  $10.7^\circ$ , that of Etna  $7.6^\circ$ , of Mauna Loa  $5.1^\circ$ , and of the lunar cone  $4.8^\circ$ . Vesuvius is partly a lava and partly a cinder cone, which accounts for its steepness. If it were



purely a cinder cone its angle might rise to  $20^\circ$  or even  $30^\circ$ . Etna and Mauna Loa are both lava cones, the lava of the latter being more fusible. We may infer that the lunar cone is composed of similar material. It is probable that other similar lava cones exist upon the Moon, and one is suspected lying six-tenths way from Copernicus to Kepler, and a little to the north.

Lunar photographs are usually oriented with south at the top. The right hand side is called east. Figures 14, 15, 31, and 35 were taken with a telescope of long focus, using an aperture of six inches, at the Harvard Station in the Island of Jamaica. The remaining lunar photographs were copied from lantern slides from photographs made by Professor Ritchey at the Yerkes Observatory. In Figure 5, one diameter to the south, and a little to the east of Bullialdus is a pair of coneless lava pits, the southwestern one being much the larger of the two. A few other very minute pits are shown upon the photograph, but all the larger ones have cones. In Figure 29, in the upper left-hand corner, five small craters are shown in a line running north and south. The northern one, which is also the smallest, is coneless. One slightly larger than this, also coneless, is shown just above the centre of the picture, on the southern side of the great rill. It measures five miles in diameter. These seem to be true engulfment craters, as distinguished from the expulsion craters hitherto described. Similar lava pits are found to the west and northwest of Copernicus, and also upon the Oceanus Procellarum. In general they are very minute objects. No large crater pits are known.

In Figure 7 we have a small terrestrial crater of this type. It is known as Kauhaku, and is found on the island of Molokai. It has no exterior cone whatever, and is merely a hole in the ground. Even explosive craters start in this form, the cone being formed immediately of materials ejected from the hole. Coneless engulfment craters abound on the slopes of Hualalai. See *k*, *l*, *m*, and *p*, p. 171. Many are also found to the southeast and east of Kilauea, but the best known of all is Halemaumau, on the floor of Kilauea itself, *d*, p. 171. Figure 8 is known as Kuuohi, or more familiarly as the sixth crater, and is situated six miles to the southeast of Kilauea. See also *f*, p. 171. The floor of the main crater pit measures about 6,000 feet in length by 2,000 in breadth. Its depth below the surrounding surface is 400 feet. At its eastern end a second crater pit has formed. This measures 2,000 feet in diameter, and has an additional depth of 600 feet. It furnishes a vertical section, 150 feet in depth of the primary floor, below which the walls form an inverted truncated cone to a small floor a few hundred feet in diameter. The lava of the upper twenty-five feet of the vertical section has a horizontal stratification, and is clearly distinguished from the portion below it.



Of the three great Hawaiian representatives of the engulfment type, Mokuaweoweo, the summit crater of Mauna Loa, Figure 9, and Kilauea, Figure 10, are coneless, while Haleakala, Figure 3, has in places a well-defined outer slope. This might lead us to suspect that it was of composite origin, an impression that is further confirmed by the fact that both its inner and outer slopes are made up in part of lava, and in part of scoria and sand. It seems to have originated partly by the engulfment process and partly by explosions of steam.

No evidence of the great crater of Mokuaweoweo is to be seen until just before we reach its rim. It measures 3.7 by 1.7 miles in diameter, and is 300 to 400 feet in depth. It is composed of three confluent craters, of which the middle one is much the largest. A portion of the two northern ones is shown in the figure, the view being taken in a direction nearly due south. The crater floor corresponds very closely in its nature to a lunar *mare*.

Kilauea is much more accessible than Mokuaweoweo. Twenty-two miles in the train from Hilo, and nine miles by stage brings us to the Volcano House, situated upon its brink. Kilauea consists of a black lava plain measuring two miles by three, bounded on all sides by precipices, often vertical, ranging from 200 to 500 feet in height. The view, Figure 10, was taken from its southeastern rim looking north. It is a curious fact that the black lava usually shows in the photographs to be much lighter colored than the gray cliffs surrounding it. Since the whole lava surface is very irregular, the fact that it is shiny and therefore bright in spots, cannot be given as an explanation of this fact. The surface is distinctly convex, *d* p. 171, as is the case with the smooth crater floors upon the Moon, and is not unlike in shape and curvature to the flattened summit of Mauna Loa, Figure 4. *A* in the section indicates the location of the Volcano House. The line *B* is on a level with it. The highest part of the floor is near Halemaumau, and in 1905 measured 230 feet above the edge where the Volcano House trail strikes it. The edge is 410 feet below the Volcano House at this point.

Halemaumau, "the house of eternal fire," is situated three-quarters way across the crater from the Volcano House. It is at present a nearly circular pit, 2,000 feet in diameter, with practically vertical sides, and when the writer was there early in August its depth was estimated at 500 feet. Its floor consisted of a comparatively smooth lava surface, crossed here and there by narrow cracks, which at night showed bright red. That it was liquid only a few inches below the surface was shown by an occasional outbreak, when a flow of lava 5 to 10 feet broad by 20 to 50 feet in length would sluggishly stretch itself across the floor, glow for a few minutes, and then cool



and solidify. From a height of 500 feet the phenomenon presented little of interest compared to what had been seen in the last century. The crater is gradually filling up from a subterranean inlet. The depth of the pit in 1902 was estimated at 1,000 feet. The lower portion, which has now been filled was then conical in shape.

Turning now to the third subdivision of the lava craters, the crater rings, we will begin by a study of what is believed to be their internal structure, as exhibited in Figure 11. This photograph represents a vertical section of a small ring crater formed naturally in cooling iron slag. When the slag is drawn off from the furnace it is allowed to solidify in conical moulds four or five feet in diameter, and about a foot in depth at the centre. Unless interfered with, a crater three or four inches in diameter is invariably formed as soon as the surface has fairly hardened. On breaking up the slag considerable cavities are always found beneath the crater. These are well shown in the figure, as are also the cracks connecting them with one another and with the central peak, which it will be noted is also hollow. The large pear-shaped cavity beneath the peak was in the present instance filled up from below with melted iron. It will be noted that the inner walls are very steep, while the outer ones slope more gradually. During the process of formation the crater sometimes fills to the brim and overflows, building up the walls; later the interior fluid withdraws, forming the crater floor.

Besides these larger craters other ones are often formed, which, while retaining a base of perhaps two inches in diameter, frequently build up to the height of several inches, forming vertical tubes or spiracles. Sometimes these tubes are closed at the top and sometimes they are left open. For these facts, and for the specimen from which Figure 11 is taken, I am indebted to Mr. J. A. Brashear.

Halemaumau, known also as "the pit," is the centre of volcanic activity in Kilauea. No eruption has ever been known to overflow the walls of the latter, although lava has sometimes been emitted from cracks located high up on its sides. When the pit of Halemaumau is emptied, it is always through some subterranean passage, occasionally reaching the surface, but usually either filling some subterranean cavity, or else discharging beneath the sea. These eruptions, though often accompanied by slight earthquake shocks, have in only one instance caused serious damage and loss of life. In this case it is thought that the active agency was really Mauna Loa, whose eruption took place at the same time.

When Halemaumau is really active the sight is said to be grand beyond description, especially at night. Lakes of liquid lava occur both within and without it. Numerous fire fountains from ten to fifty feet in height play over the surface of these lakes.



At times the surface solidifies, then suddenly a crack will run across it, and in a few minutes the whole solid material will break up into separate cakes which will presently turn on edge and sink beneath the surface of the lake. This again solidifies, and in a few hours the process is repeated. See report of the United States Geological Survey for 1883, p. 106, Major C. E. Dutton.

These lakes are especially interesting to the selenographer, since about them are formed crater rings, which seem to be analogous in appearance to the larger crater formations upon the Moon. During the past forty years, since the construction of the hotel upon the rim of Kilauea, they have been very carefully observed, and it will therefore be well in this place to deal with the subject, briefly, from the chronological standpoint. All the earlier descriptions which follow are condensed from the writings of the Rev. Titus Coan. The references given refer to the *American Journal of Science*.

On April 2, 1868, a severe earthquake shook the southern coast of Hawaii, and for the next five days a subterranean discharge of lava took place from Kilauea. As a result of this discharge the central area to the northeast of Halemaumau sank about 300 feet, carrying with it the vegetation still growing on its surface. The walls of this new pit were inclined from  $30^{\circ}$  to  $60^{\circ}$ . The lava also flowed out of Halemaumau, leaving a circular pit 3000 feet in diameter at the top, 1500 feet at the bottom, and 500 feet deep. Its walls were in some places vertical, and in some slightly overhanging. *A. J. S.*, XCVII, 96. In *A. J. S.*, CXVIII, 227, it is stated that the depth was 400 feet and that the distance across the bottom was one mile less one hundred feet. It is also stated that the pit had formerly been filled up not only from the bottom, but by lateral discharges from the walls.

A year later Halemaumau had filled to within 100 feet of the top, the level area within it showing eight small apertures within which the liquid lava could be seen boiling fiercely 50 to 100 feet below the surface. A few months later the lava was within 25 feet of the rim, and the diameter of the pit was said to have enlarged to over a mile. *A. J. S.*, XCIX, 393.

In 1870 the pit overflowed, the lava pouring down and partly filling the northeastern depression. At the time of an eruption such as this, the lava rises, overflows and cools, thus forming a raised rim or circular dam. Such a rim is shown on a small scale in the slag crater, Figure 11, and on a much larger scale in the photographs of Halemaumau, Figures 12 and 13, the cakes of lava there represented appearing much like broken cakes of ice. In Figure 14 is shown a portion of the Moon near the limb, so as to present the craters obliquely. It will be noted that the



two large craters there represented, named Schickard and Phocylides, both present a form similar to the crater rings of Halemaumau. The chief one, Schickard, measures 134 miles in diameter. All of the larger craters on the Moon are of this type. When seen towards the centre of the disc, however, their depth appears by an optical illusion greatly exaggerated. Thus Clavius, the largest crater shown in Figure 16 measures 143 miles in diameter, and judging by appearances only might be 15 to 20 miles in depth. Its depth actually measures two and a half miles, or about the same as the diameter of one of the most minute craterlets visible in its interior. The slope of its eastern inner wall is about  $10^{\circ}$ .

There is another crater known as Wargentín, lying between Schickard and Phocylides and the limb, Figure 14. It is not shown in the photograph because it is a very difficult object. This is not on account of its size, since it measures fifty-four miles in diameter, but because it has no interior depression. In this respect it has heretofore been thought to be unique upon the Moon. That such is not the case, however, an inspection of Figure 32 will show. Near the upper edge of the figure a large low nameless crater is to be seen whose interior is obviously at a greater elevation than its exterior, although the difference is not as great as in the case of Wargentín. It measures about fifteen miles in diameter. In each of these cases the lava passage leading to the interior of the crater evidently became choked while the crater was still brimful of molten matter, thus preventing the withdrawal of the lava, and preserving the crater as a permanent illustration of the method by which these formations are produced.

The outside height of the crater rings in Halemaumau rarely exceeds 15 to 25 feet. The inside height is constantly varying with the fluctuating level of the surface of the lava lake. When the outside height becomes too great to withstand the internal pressure, the rim gives way, and the lava breaks through and floods the surrounding regions. By means of this successive building up and flooding, the whole region around Halemaumau was elevated, until the walls became too high and too thick for the floods to escape over or through them. The pit at this time measured a mile by a mile and a half, and was 700 feet in depth. Since the lava could not now overflow the rim, it escaped by subterranean passages, and thus flooded the other portions of the floor of Kilauea. A. J. S., CII, 454.

It is doubtful if the walls of the pit were raised exclusively by the process thus explained by Mr. Coan. It is probable that the whole of this portion of the floor was also elevated as one piece by the pressure of the subterranean lava, as occurred in the later eruptions.



On the Moon the height of the outer wall is roughly proportional to the diameter of the crater. For a crater whose diameter measures 30 to 40 miles, the height of the outer wall is usually about one mile. For a crater a mile in diameter its height would be 150 feet. Dividing this figure by 6, the correction for gravity mentioned at the beginning of this paper, we find 25 feet to be the theoretical height for a terrestrial crater a mile in diameter, thus agreeing with the figure above given.

In April, 1879 a silent discharge from the crater occurred, the lava apparently making its escape out at sea. A few months later activity was again resumed, the crater becoming extremely active in 1880. A. J. S., CXVIII, 227; CXX, 72.

On March 6, 1886, Halemaumau was again emptied. It was a silent discharge like its predecessor. For several days the surrounding walls continued to fall into the pit. A month later the deepest portion had the shape of an inverted cone, whose apex was 570 feet below the floor of Kilauea. Three months after an erect cone was found formed of loose blocks, and measuring 150 feet in height. During the next two years this cone gradually floated upwards, no additions being made to its summit. This action seems to have been due to the pressure of the lava beneath it. The rate of elevation was about three inches per day. A. J. S., CXXXI, 397; CXXXVII, 48.

The next discharge of Halemaumau occurred on March 6, 1891. It was accompanied and followed by a series of light earthquake shocks, but otherwise it was a quiet discharge. Prior to this date the pit contained a central cone with three lakes surrounding it, one east, one west, and one south. The direction of the current on the surface of these lakes in each case was away from the cone. The cone which consisted in part of several peaks rose to a height of at least 200 feet above the lakes. As seen from the Volcano House about one-third of its height was above the western wall of Kilauea. The structure of these peaks was loose, and sulphurous vapors escaped from their whole surface. The fire fountains on the lakes sometimes played obliquely, and without the emission of steam. On the evening of March 6, at 9:30, a light earthquake shock was felt, and the peaks settled slightly; the next morning they were out of sight. A month later in place of the peaks and lakes an empty pit was seen, measuring half a mile in diameter. The walls were vertical and 500 feet in depth. Soon after this the lava reappeared in the bottom of the pit, and by the end of April a lava lake 100 to 200 feet in diameter had formed. A year later the diameter of the lake was a little over 800 feet. It was then very active, as many as fifteen fire fountains having been counted at one time. It was probably at about this time that



the photographs shown in Figures 12 and 13 were taken. A. J. S., CXLI, 336, 507; CXLII, 77; CXLV, 241.

The next discharge was on July 11, 1894. In August, 1892, the edge of the pit of Halemaumau was 282 feet below the level of the Volcano House. The surface of

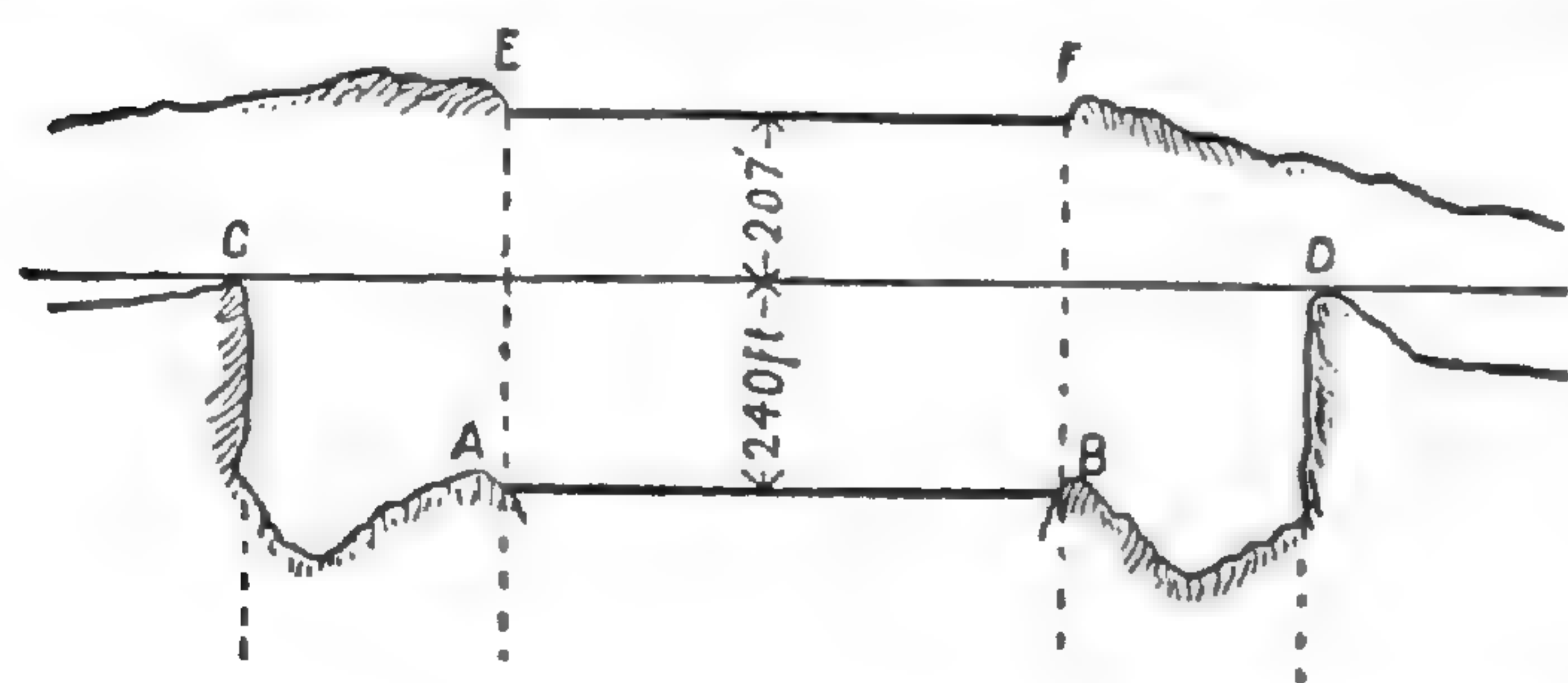

the lake was 240 feet below the edge, 522 feet in all. (See cut.) In March, 1894, the surface of the lake was 75 feet below the Volcano House, making a total rise of 447 feet in nineteen months, or about ten inches per day. In 1892 the lake was in the bottom of the pit.

In 1894 the pit was filled, and the lake was on the top of a flat hill covering the pit and situated 207 feet above its former rim. The pit was filled partly by overflows from the lake, and partly by a rise of the whole bottom of the pit. The lake now measured 800 by 1200 feet.

On March 21 an area measuring 400 by 800 feet, situated on the northern bank of the lake, was suddenly elevated eighty feet above the other banks. The raised area was much shattered. It subsequently sank gradually, until on July 11 it again reached its former level. On that date the lava in the lake began rapidly to sink, and the walls about the lake to crack off and fall into it. The lava sank at the rate of twenty feet an hour until eight that evening. From noon till eight there was scarcely a moment when the crash of the falling blocks was not heard. A number of times a section 200 to 500 feet long, 100 to 200 feet high, and 20 to 30 feet thick would drop with a tremendous roar into the boiling lava. Such a section would form for a time a floating island in the lake, but would subsequently dissolve and sink. The grandeur and magnificence of the scene at night were indescribable. Meanwhile the fountains in the lake continued to play as if nothing unusual were happening. Only a few slight earthquakes accompanied this discharge. A. J. S., CXLVIII, 338.

Since this time for an interval of over twelve years the volcanic forces in Kilauea have been practically quiescent. There was a slight display of activity in 1896, and again in 1897, but the pit remained empty, and no activity whatever has been seen since then, except for the gradual and uneventful filling of the pit which seems now to be taking place. No such protracted interval of quiet has been known heretofore, the longest previous period amounting to only a few months. It is of interest to note that of the five recorded discharges, four occurred during the rainy months of March and April.

From these descriptions we can obtain an idea of how the lunar craters were formed, and can also account for the flat-topped vertical cliffs that we find about



some of the *maria*, as in the case of Sinus Iridum, Figure 15. The walls of Mokuaweo-weo or of Kilauea, Figures 9 and 10, furnish excellent illustrations of these formations. Examples of the crater rings themselves, however, are rare. The best preserved one that we were able to visit was found on Hualalai, at an elevation of 400 feet below the summit of the mountain, and was reached a few minutes after passing the so-called Bottomless Pit. It was located on the floor of a crater some 500 feet in diameter by 100 feet in depth, *g* p. 171. The diameter of the crater ring was 120 feet, its internal depth was six feet and the height of its outside wall twelve to sixteen feet. It is shown upon a larger scale at *h* p. 171. Near the centre of the outer crater, and outside of the crater ring, was a low peak. What appeared to be another crater ring was seen from the distance of a mile on the northern slopes of Mauna Loa, and will be described later. A portion of one of the crater rings formed by Halemaumau is still to be seen on the rim near the view-point where visitors look down into the interior.

The reason that these crater rings are so numerous upon the Moon and so rare upon the Earth is apparently that the terrestrial ones are not generally permanent. The smaller craters on the Moon do not take this form, and if some of them did exist formerly they have since been destroyed. The reason of this is that when the lava recedes into the bottom of the pit, the depth is so great in proportion to the diameter, that the walls cave in, destroying the ring,—as usually happens at Halemaumau. On the Moon no crater is known whose depth exceeds five miles, and two miles is the usual depth for large craters. This distance compared to a diameter of twenty to sixty miles is so slight that the ring remains uninjured. The outer walls of Haleakala may in part be the remains of an old crater ring of very elliptical shape. They have been breached and totally destroyed in two places.

The floors of the craters on the Moon are of three kinds, either they are furnished with a central peak, like Tycho, the large crater in the lower left hand corner of Figure 16, or they contain one or more smaller craters, in general not central, like Clavius, in the same figure; or they are without conspicuous detail, like Kies, Figure 6. In the last two cases the floor is often of a later origin than the walls, as indicated by its color and smoothness, the original floor having been melted by a flood of dark colored lava from below, which dissolved all the lowermost portions of the solid crust with which it came in contact. This seems to be the case with Longomontanus, the large crater northeast of Clavius. Its diameter is ninety-one miles. Often, however, the floor is bright, and not perfectly smooth, as in Tycho, showing it to be part of the original formation. Central peaks are occasionally, but by no means universally,



found upon these original floors. Indeed they rarely occur in craters of less than four miles in diameter. Longomontanus and another crater known as Pitatus present the very unusual phenomena of eccentric internal peaks. Equally striking is the fact that in each case the peak is found in connection with a dark floor. The explanation in both cases is probably that the lava, after dissolving the original floor, had begun to dissolve the peaks, which were pushed by the lava currents to one side, where cooling and solidification set in before the process was completed. In both these cases the peaks are unusually small in proportion to the size of the craters, as would naturally be the case if they had been floating partially submerged in the lava.

Central peaks are seldom found in the Hawaiian craters, probably because the latter are so small. The best illustration seen was that of the small crater already mentioned at the northern base of Mauna Loa, about eight miles west of the Humuula sheep ranch, *i* p. 171. Unfortunately we could not get within a mile of it, but it seemed to be well defined. Its diameter was thought to be about 450 feet. The walls were red, and the central peak dark brown. The height of the peak was the same as that of the walls. Another small crater two or three hundred yards back of Mr. Maguire's at Huehue in Kona showed a smooth central peak 15 feet in height. It was completely grass grown. One or two of the small craters on Hualalai, *k* p. 171, showed the same formation. The peaks were never pointed, but sandy and rounded as in the slag crater shown in Figure 11. A crater containing a central peak or craterlet is said to exist half a mile beyond the sixth crater near Kilauea. Near the centre of Haleakala is found a straight, narrow ridge, 150 feet in height by 400 feet in length, along its crest. Its sides slope at an angle of about  $30^\circ$  and it is composed apparently of gravel and scoria. At its eastern base is the cave where parties sometimes pass the night. Although not especially conspicuous among the crater cones which dot the floor, some of which are 500 feet in height (see Figure 3), it seems to be unique in shape, running lengthwise of the crater. It is also almost exactly central in position. In passing it may be stated that the maps of Haleakala give a very erroneous impression of the shape of its floor. The floor at the Koolau and Kaupo gaps falls off sharply, showing the outline of the true floor to be not S-shaped, but elliptical, and extending nearly due east and west. It is an ellipse of great eccentricity, the length of the floor being about four times its breadth.

Figure 18 represents a portion of the middle crater of Mokuaweoweo. Somewhat nearer than the centre is shown an active cinder cone composed apparently of a medium-sized crater and two or three smaller ones upon its rim. We were not able to visit it. Like the craterlets found in Haleakala, it reminds us of those found in



Clavius. The photograph was taken in 1903 by Mr. C. W. Baldwin, and was forwarded to me through the kindness of Professor W. D. Alexander.

One of the most interesting craters that we visited was Kilauea Iki, or little Kilauea. It is situated about a mile from the Volcano House. The floor is level, one-quarter of a mile in diameter and 750 feet below the rim. The walls are very steep, but can be descended in certain places with care. Numerous small craterlets are scattered irregularly over the floor. The most complete of these is shown in Figure 19. Its height was 15 feet, and the diameter of the rim, which was composed of lava of a somewhat ropy appearance, 25 feet. A stream of lava had poured from the summit, but did not get far beyond the rim. There may have been as many as fifty rudimentary craterlets scattered over the floor, in all stages of growth, from a hardly noticeable elevation to the complete craterlet shown in the figure.

The process of construction was clearly shown, and was probably identical with that which produced Halemaumau, and Kilauea itself in the first place. In Figure 20 the top of one of the other craterlets is represented in the foreground. It was taken near at hand from the summit of the first one, and its development is clearly incomplete. The surface of the crater floor of Kilauea Iki seems to have solidified into a layer six to ten inches in depth and distinct from the portions below it, much as in the case of the sixth crater, Figure 8. A liquid core forced up from below raised this surface layer locally, and shattered it into separate pieces like cakes of ice. This core in the case of some of the smaller craterlets was sometimes only two or three feet in diameter, and could be seen beneath the shattered surface. In one instance its summit seemed to have an almost globular form, five feet in diameter.

If the volcanic forces beneath these craterlets had been more intense, it is probable that the issuing lava would have completely destroyed them, forming a series of crater pits, into which the lava would have subsequently retreated. In the southeastern part of the floor two such pits were found, perhaps 15 feet in depth by 30 in diameter, down into which a stream of lava had poured, but had solidified without filling them up. One of these pits is shown in Figure 21. Figures 20 and 19 therefore illustrate the earliest stages of formation of a lunar crater. No other example in Hawaii is known to the writer which shows as satisfactorily as this the irregular distribution of craterlets over a crater floor.

A low ridge due to compression, caused by the sinking of the convex surface crosses the eastern end of the crater floor. Similar ridges are seen on some of the lunar *maria*, notably on Serenitatis, Figure 17. Two short, clearly marked ridges project onto the southern side of the floor of Kilauea Iki, caused by lava streams which had



descended from the crater wall. They resemble similarly located formations found in the lunar crater Plato. In Clavius, Figure 16, similar ridges are seen projecting from the outer slopes of the two chief craterlets upon the northern and southern walls. Similar ridges, although much more complicated in structure on account of their numbers, have already been described in Bullialdus, Figure 5.

Leaving the craterlets and ridges of Kilauea Iki, and proceeding along a defile towards Kilauea itself, three successive lava dams were reached, each of which had served to hold back a small lava lake. In construction they were similar to the circular one represented in Figure 12, except that they were straight, and merely stretched across the defile. The first lake measured 400 feet in length by 150 in breadth. The second dam rose eight feet above its surface, and three feet above that of the second lake. By the side of this lake a core of lava of the most brilliant colors — red, yellow, brown, and purple — had escaped from the ground, and from it a black lava stream had descended to the surface of Kilauea Iki, 200 feet below. A similar core but without the colors was seen at Huehue. Both these flows occurred during the last century. Both were small, and in neither case did a cone appear, the lava issuing directly from the ground.

The fourth subdivision of the lava craters, described earlier as crater bowls, is illustrated in Hawaii by what is known as Aloi, or the Third Crater, near Kilauea. Other illustrations are found on the slopes of Hualalai. A crater near the summit, *j*, p. 171, was estimated at 800 feet in diameter by 200 in depth. The sloping walls were of lava, and the bottom of sand. The comparatively shelving outer walls probably did not exceed 100 feet in height. A portion of the interior of this crater is shown in Figure 22. A somewhat larger crater bowl with much steeper walls is found on the summit. With favorable definition such a crater would be readily seen upon the Moon, and could not be distinguished in any way from many others found there.

The largest craters on Hualalai occurred near the summit, and shortly before reaching the top we crossed a lava field strongly resembling a small lunar *mare*. A far larger number of craters are found on this mountain than on any of the others, more perhaps than on all the others combined. The three types, of cinder cones, pits, and bowls, are each represented by numerous examples. One of the craters that we passed after leaving the summit, *k*, p. 171, had sloping walls and a flat floor with sand hills on the bottom. One of these was twenty feet in height. Near the base of the walls was an inner terrace extending all around the crater. This feature of a single, well marked, inner terrace is conspicuous in a considerable



number of the lunar craters, such as Fabricius, Hercules, Manilius, Reinhold, and Bullialdus (see Figure 5).

Some of the lava pits occur very near together, the intermediate wall being only a few yards in thickness, but we saw none which actually intersected. When the large summit crater was formed a smaller one near it was partially destroyed, and filled by the erupted material from the larger crater.

We have no description of the method of formation of a crater bowl, but a study of the various sections on p. 171 will show how they have probably been formed. Starting with a crater ring such as is shown in Figure 19, and in section at *h*, p. 171, when the lava retreats a crater pit will be formed within it. If the pit is very deep relatively to the diameter of the ring, the latter will be destroyed, and we shall have simply an ordinary pit, *l*. If the pit is not so deep relatively to the diameter of the rim the latter may be preserved, *n*. The floor of the pit may be flat, or it may sink towards the centre, *m*. If the pit is on a large scale the sides are less liable to be vertical, and moreover a talus will collect at their base, *o*. This will gradually become rounded as at *p*, or if the crater ring is still left, as at *j*. The flattened floors of the larger craters on the Moon are illustrated by *g*, while the terrace and central peak are shown at *k*.

With the exception of the crater pits, nearly all the smaller depressions upon the Moon are crater bowls, and they outnumber at least ten times all the other depressions put together. The smallest crater rings are about five miles in diameter. One of the largest and best situated crater bowls is Triesnecker, 14 miles in diameter. It has an inconspicuous central peak. In the smaller bowls this feature seems to be lacking. A well-graduated series of bowls is shown in the interior of Clavius, Figure 16. The process which converts a pit *l* into a bowl *p* upon the Earth is due chiefly to the action of water. Upon the Moon, even in former times, water was probably scarce, but owing to the extremely rarefied atmosphere the extremes of temperature are excessive. A range of 300° C. or 540° F. occurs every fortnight, and it seems likely that a considerable destruction of ridges and filling of hollows would be due to this cause by itself.

Another explanation of crater bowls is given by Gilbert in his dissertation on "The Moon's Face," Philosophical Society of Washington, Bulletin XII, 251, where he suggests that they may be due to a single explosion of steam, like the terrestrial "maars." This seems improbable, since volcanic features due to steam are notably absent from the Moon. On Hualalai the crater bowls have smooth lava walls which are not at all fragmentary, as would be the case were they due to an explosion.



In drawing the sections on p. 171, it was necessary to represent them on several different scales. The smallest scale adopted was  $\frac{1}{48000}$  or a quarter of an inch to 1000 feet. The dimensions of all save *a*, *b*, and *d* are based only on estimates, but these were made on the spot with all possible care, excepting *c* and *e*, where the estimates were based on photographs, and *o*, for which I had to depend on my memory. All the sketches were either made on the spot or were taken from photographs. The craters on Hualalai are designated for lack of a better system of nomenclature in the order in which we visited them from Huehue. Number 8 is the summit crater. In the description which follows, the length of 1000 feet is given in each case in inches as measured on the section.

- a* Tuff cone. Punch Bowl,  $\frac{1}{4}$  inch.
- b* Tuff cone. Diamond Head,  $\frac{1}{4}$  inch.
- c* Cinder cone on Mauna Kea, 1 inch.
- d* Lava pit. Kilauea,  $\frac{1}{4}$  inch.
- e* Lava cone in Haleakala, 1 inch.
- f* Lava pit. Kauohi or Sixth Crater near Kilauea,  $\frac{1}{4}$  inch.
- g* Lava cone and ring. Crater number 10 on Hualalai, 2 inches.
- h* Lava ring. On floor of crater number 10 on Hualalai, 8 inches.
- i* Lava ring on Mauna Loa, 2 inches.
- j* Lava bowl. Crater number 9 on Hualalai, 1 inch.
- k* Lava pit. Crater number 11 on Hualalai, 2 inches.
- l* Lava pit. Crater number 3 on Hualalai, 2 inches.
- m* Lava pit. Crater number 6 on Hualalai, 2 inches.
- n* Lava pit. Crater number 12 on Hualalai, 1 inch.
- o* Lava pit. Alealea or Fourth Crater near Kilauea,  $\frac{1}{4}$  inch.
- p* Lava pit. Crater number 7 on Hualalai, 4 inches.

After the craters, among the most important features of the lava flows are the elevated formations, — the spiracles, pinnacles, and ridges. When the gases work their way up to the surface from a subterranean cavity they escape by little apertures called blow holes. In so doing they often carry small quantities of lava along with them. This lava quickly hardens on reaching the surface and builds up a tube around the aperture which we have called a spiracle. Sometimes it is closed at the top by the last escaping lava, and sometimes it is left open. These spiracles are found of all sizes, from one measuring three or four inches in diameter, up to another measuring one hundred feet. The former, found in Kilauea, was twelve inches in height, and contained a hole one inch in diameter running its whole length, except where it was closed at the top. The latter was found on Hualalai, and will be described presently.



Figure 23 represents a spiracle fourteen feet in height by six feet in diameter at its base, found in Kilauea near Halemaumau. It is built up of what may be described as great drops of solidified lava. The interior tube is open at the top and measures a foot in diameter. Another somewhat smaller spiracle is seen in the background. Often several spiracles occur side by side with confluent bases, as in Figure 24. This object is also located in Kilauea, near the corral where the horses are left. It closely resembles the central peak or range of peaks so often found in the lunar craters, and is doubtless due to the same cause. See Tycho and Longomontanus, Figure 16. It is ten feet in height. Several of the spiracles forming it are open, and several are closed. There are a number of large cavities in the interior, in some of which were found some very slender lava stalactites. No lava flow had escaped from any of the craters, but two outbursts had occurred upon the side, and may be seen about half way down the slope, below the right-hand summit of the ridge.

Figure 25 shows a much larger row of spiracles found on Hualalai. They measure about a thousand feet in height above their base. Midway between the two highest summits are two smaller ones. The left hand of these is known as the Bottomless Pit. The little cone measures one hundred feet in diameter at its base by sixty feet in height. A narrow tube a few yards in diameter opens at the summit, and it is said that it has been sounded for 1400 feet without reaching bottom. Whether this figure is correct or not, doubtless the tube is very deep, and no bottom is visible. These spiracles equal in height many of the central peaks found upon the Moon.

Sometimes a row of small conical elevations, about equally spaced, occurs upon the Moon. Such a row is found in the eastern part of the floor of Wilhelm I, the large crater shown in the lower right-hand corner of Figure 16. The illustration is on too small a scale to show them to advantage, however. A row of still larger cones is found just outside and northeast of the crater. They seem like spiracles thrown up along the course of a steam crack.

Sometimes the lava slabs pile up on one another in horizontal layers, as in Figure 26, and sometimes much more irregular blocks occur, without any apparent order. These form pinnacles with very steep sides and ends. Their origin seems to be due to recent flows of lava which have transported and piled up the fragments formed from the earlier flows, somewhat as the ice pack is transported by the winds and currents in the far north. This object was found in Kilauea.

Another type of pinnacle consists of a single block of lava which may rise as high as sixty feet above the surrounding plain. The sides are often precipitous, and there



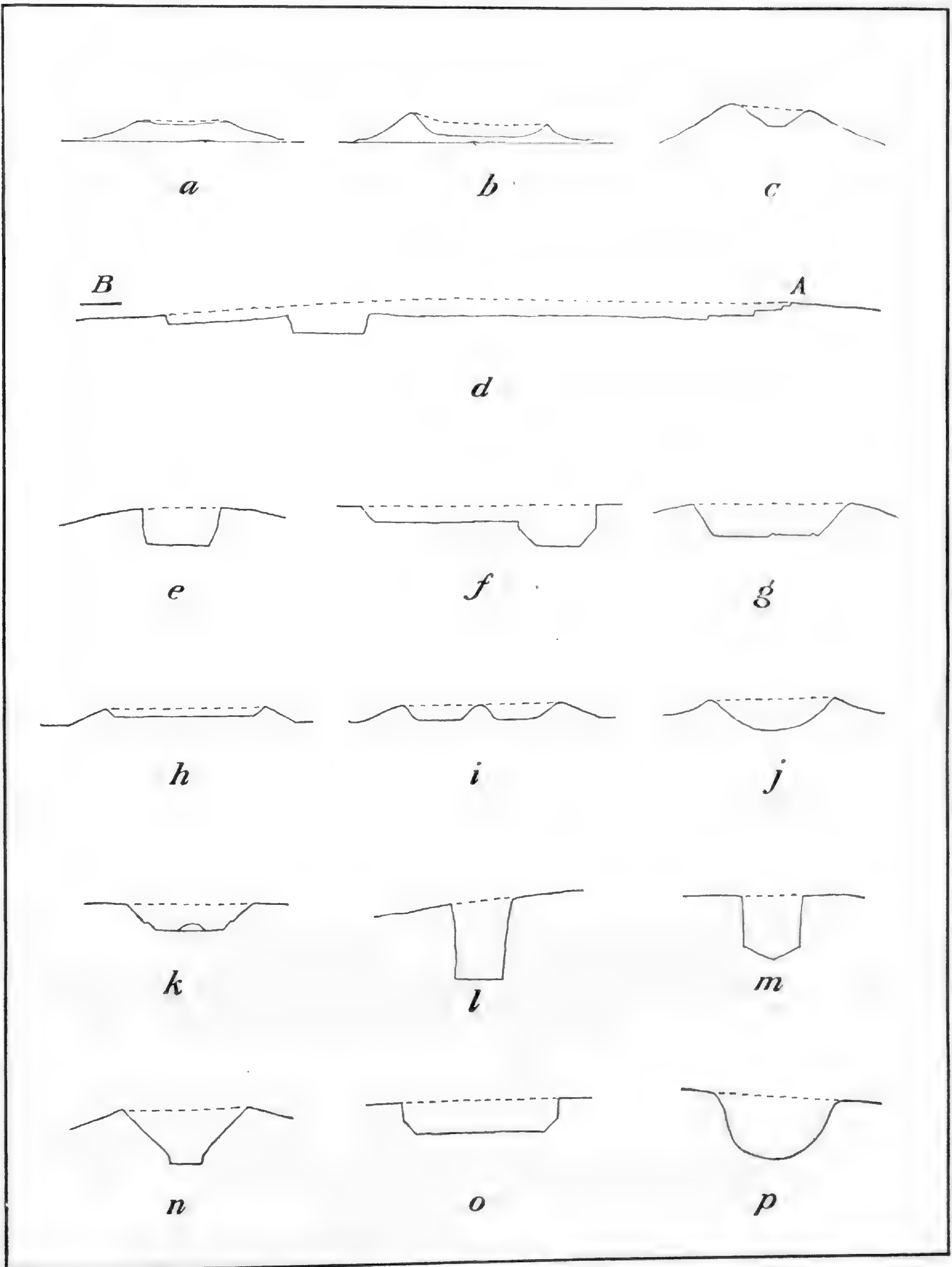

SECTIONS OF CRATERS.



is no summit crater. It is probably a solid block fallen from a neighboring cliff, that had been undermined by the liquid flow, and after floating awhile and being transported, was now frozen in, in its present position. Such a block is shown in Figure 27. It is twenty-five feet in height, and was found upon the floor of Haleakala. A second one is shown in the distance. Similar objects are of frequent occurrence upon the various *maria* of the Moon. Doubtless they are often formed as above described, but in many instances it is evident that they have been left in their original positions, while the objects formerly surrounding them have been destroyed by the flood of molten lava. Innumerable pinnacles are found upon the Mare Imbrium. A number of them are shown in Figure 28. The large crater in the photograph, near the left-hand edge, is Euler. Its diameter is nineteen miles.

A curious feature in Hawaii is the very extensive series of caves that penetrate the lava, especially the flows from Mauna Loa. Indeed, so many of them have been found that it has been suggested that they make up an appreciable part of the bulk of the mountain. A very accessible cave is situated a few miles above the town of Hilo. It is said to extend two miles up and two miles down the mountain from the entrance, which is a place where the roof happened to fall in, disclosing the cavity. The breadth of the cave is about thirty feet. Its height varies in the portion that we traversed from three to ten feet. Larger caves are found in other places, sometimes, according to Dutton, being as much as sixty or eighty feet in height, and wide in proportion. Their origin is due to the fact that the surface of the lava hardens first, and that the lower portions meanwhile flow away, leaving the cavity. Small caves occur on the floors of Kilauea and Haleakala where, since the floors are level, the formation seems to be due to the collecting of gases under sufficient pressure to hold back the lava until it has had time to solidify. Sometimes lava channels form without any roof. Some well marked channels and caves are found two or three miles north of Huehue on the Kona coast. A lava channel was noted not far from the summit of Hualalai, where the path crosses an open lava field. Another channel was found in Kilauea near Halemaumau.

At first it was thought that these lava channels were analogous to the broad grooves found upon the Moon, of which the valleys of the Alps and of Rheita are the most conspicuous examples. The Valley of Rheita is shown in Figure 31. It is 190 miles long by 15 miles wide. Several parallel valleys similar to these are found to the southwest of Pallas, and a less well marked series to the southeast of Sinus Iridum. The great range of the Altai Mountains in the southwestern quadrant of the Moon seems to form one side of such a valley constructed upon a very large



scale. If so, the other side must have been destroyed by a subsequent melting, leaving an unusually smooth, light-colored surface in its place.

It was later concluded that these valleys were produced by a continuous faulting along a line of volcanic weakness, and were therefore analogous to the craters, where instead the faulting extends in all directions from a volcanic centre. The best Hawaiian representative of these grooved valleys is therefore probably the great crater of Haleakala (Figure 3), whose length measures seven miles and its breadth two. These are about the relative proportions found in many of the valleys southwest of Pallas,—nor are their dimensions so very different. The line of six small craters found in the bottom of Haleakala corresponds to the similar line of small craters found along the minute rill in the bottom of the Valley of the Alps.

The fact that often one and sometimes both ends of the lunar valleys are closed by high walls, as is the case with Haleakala, strengthens the second explanation of their origin as opposed to the earlier one. Elongated craters forming an intermediate step between the ordinary craters and the grooved valleys are of frequent occurrence upon the Moon. The largest of these is Schiller, in the southeastern quadrant. A nameless one is shown in the lower left-hand corner of Figure 31, and another in the lower right-hand corner of Figure 29. Others are shown on the border of the *mare* in the same figure.

The lunar rills may be divided into two classes,—rills and crater rills. The rills proper are extremely numerous upon the Moon. About a thousand are already known. The Ariadæus rill, shown in Figure 29, is the widest and most conspicuous of them. It measures three miles in breadth by a little over half a mile in depth, as determined by the shadows of the ridges that cross it in various places. Like all true rills its course is approximately straight, or made up of curves of long radius. In its bottom are several minute craterlets not shown in the photograph. Evidently like our dikes and mineral veins it has been partially filled from below. Other narrower rills, apparently bottomless, are found on the Moon. Two much smaller parallel rills with a north and south direction are found upon the *mare* to the left. One of these is faintly shown in the photograph. The general view that the rills are simply cracks in the lunar surface is undoubtedly correct. They occur most frequently in formations of the secondary period, that is in the dark surfaces, or if found in the primary formations, it is where the surface has apparently been softened and partially flattened out by the application of heat, as in the present instance. Rills are frequently found at the edges of the *maria* and running parallel to them, as in *Serenitatis* and *Humorum*.



A large crack is found in Kilauea in precisely this position, Figure 30. It is from 6 to 8 feet wide and from 20 to 30 feet deep near the bridge. It is said to be about a mile in length. A crack 5 to 20 feet in breadth, and 40 to 200 in depth, by 16 miles in length is located southwest of the crater, and a similar one parallel to it is found near by. Several cinder cones occur upon these cracks much as crater pits do upon the Moon. The cracks themselves have been partly filled up, but one said to be 1500 feet in depth and 5 to 15 in width is situated not far from the Sixth Crater near Kilauea.

Keanakakoi is a small crater one and a half miles southwest of Kilauea Iki. Its floor measures 500 feet in diameter and is 300 feet below the rim. It illustrates the craters having smooth floors upon the Moon. The lava surface itself is wonderfully smooth, but a close inspection shows that it has a convex surface, rising from 10 to 15 feet higher at the centre than at the edges. In this respect it also resembles what we find upon the Moon. The surface is slightly undulating, the hillocks measuring perhaps two feet in height above the depressions, thus indicating compression of the floor. The surface is also everywhere seamed with cracks, from one to three inches in breadth, and running in all directions. This indicates subsequent contraction. As often occurs upon the Moon, a crack was found running parallel to the edge of the floor, and not far from the walls. Seven prominent radial cracks were counted. The arrangement strikingly resembled that of the rills in Gassendi. A good map of this crater is given in "The Moon," by Neison, p. 337. In no place did the cracks exceed eight inches in breadth. Ferns are beginning to grow in these here and there.

A very different type of crack is sometimes produced where the surface is forced open by a subterranean lava flow, and small craters and blow holes are formed along its length. Such a one is found at Huehue, due to an eruption on the slopes of Hualalai in 1801, Figure 33. A ridge 50 feet in height in some places, and carrying on its summit a crack 30 feet wide by 40 feet deep, and extending for perhaps a mile has been produced. It is very irregular in outline.

Such a crack is represented upon the Moon in Figure 32. It is a good illustration of the crater rills so called, and is known as Bullialdus  $\phi$ . The straight portion measures 40 miles in length by perhaps one and a half in breadth. Its edges are elevated as in its Hawaiian representative, and are quite as irregular in outline in proportion to its size. The distinction between these two types of rills is not sharply drawn upon the Moon, and the same rill sometimes exhibits both types in different portions of its length, as is the case with three small rills located on the northeastern



and southeastern flanks of Copernicus, within one diameter of the crater rim. A much larger and more conspicuous crater rill occurs one and a half diameters to the northwest of Copernicus. The craterlets in this case are so distinct, however that the rill-like character is not so well marked.

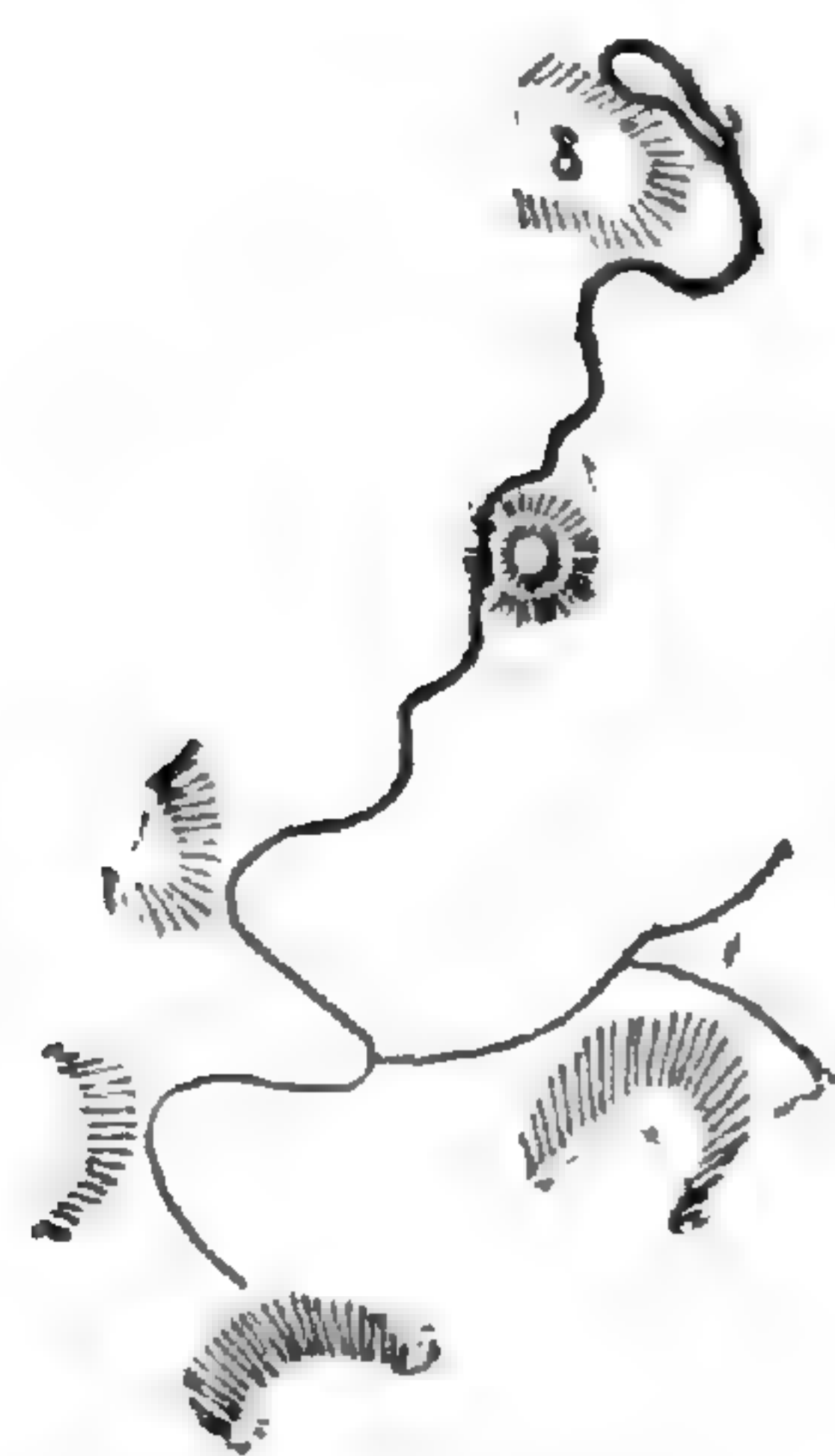

Another type of depression that is found upon the Moon is known as a river-bed from its resemblance to its terrestrial analogue. Thirty-four of them have been catalogued. They have been so fully described elsewhere, *Annals of the Harvard College Observatory*, XXXII, 84, that it is unnecessary to more than refer to them here. The figure represents one of the larger ones. It is found on the slopes of Mt. Hadley. Its length in a straight line is 50 miles, and its maximum breadth 2000 feet. It tapers uniformly from one end to the other. In Figure 6 a marking is found closely resembling one of these riverbeds. It is situated due south of Kies and west of Mercator. Its true character can only be ascertained by visual observations made under exceptionally favorable atmospheric conditions.

A favorite argument of those who deny that water ever existed upon the Moon is the statement that if such were the case, signs of erosion would be found upon its surface. In the case of the Earth, where vast bodies of water are present, these signs are very pronounced in the eroded valleys of mountain regions, and the alluvial plains of the more open country. When we search the coarser detail upon the Moon no such signs are to be found. This makes it certain that large quantities of water could never have been found upon its surface, nor indeed should we expect such to be the case considering the small value of the force of gravitation existing there. If the Moon ever possessed any water at all, it must have been in comparatively small quantities, and we should accordingly look among its finer detail for any evidence of its former existence.

Figure 34 represents Theophilus, a crater some 64 miles in diameter. The central peaks rise 5000 to 6000 feet above the crater floor, and are indented by numerous deep valleys, four being clearly shown in the photograph. It is believed that these valleys are due to erosion, and are analogous to those shown in Figure 36. This figure represents a mountain ridge just back of Honolulu, and was taken from another ridge called Tantalus. Similar valleys occur on the central peak of Eratosthenes. In the case of Copernicus they have cut so deeply that they have actually divided the central mass into three distinct mountains. The precipitation cannot have come from a general atmospheric circulation, but more likely from steam



expelled from the openings of the spiracles in the central peaks themselves. The valleys seem to be flat bottomed, which would imply the action of ice rather than water. Indeed, at the present time the central peaks of Theophilus are of a dazzling brilliancy as compared with their surroundings. This, it is believed, is due to ice. The floors of both Theophilus and Copernicus show ridges that may be lateral moraines.

What we ordinarily speak of as the lunar day is twenty-nine and a half terrestrial days in length. From the standpoint of climate it may quite as properly be called the lunar year. In the latter case sunrise corresponds to spring, and sunset to autumn. The interval between them is very nearly fifteen of our days. Using the terms in this sense, we find that there are numerous spots scattered over the surface of the Moon which as the season progresses gradually darken. They reach their maximum development about or soon after midsummer, and from thence on slowly fade out and disappear with the approach of autumn. They are widely distributed over the surface, excepting near the poles, but develop most rapidly in the equatorial regions. It is believed that these variable dark spots are due to vegetation.

One of them is seen in the northern part of Julius Cæsar, the large crater just north of the Ariadæus rill, Figure 29. Others are found to the north and east of it. The summer temperature on the Moon is about that of our desert regions at midday. The winter temperature approaches absolute zero, but since grain and other seeds have been exposed without injury to the temperature of liquid air, it seems clear that even terrestrial vegetation can stand a range of temperature quite comparable to that found upon the Moon.

The central area of Figure 35 represents the crater Eratosthenes taken at the time of full moon. On the photograph it measures an inch and a quarter in diameter, and is on a scale of  $\frac{1}{32}$  inch to the inch, or thirty-two miles to the inch. The central peaks are pure white, and cover an area about one quarter of an inch in diameter. Northeast and northwest of them are two dark spots upon the floor, and southeast of the peaks is a very dark area lying partly on the floor and partly on the inside wall. These spots go through various interesting changes in density as the season progresses, at times entirely disappearing. In one place a slow movement of progression at the rate of four feet per hour has been noted. Outside of the crater, large dark areas are seen, which do not, however, lend themselves so readily to measurement as do those within it. Two dark lines lead away from each of the spots at the base of the central peaks. These lines are believed to be analogous to the so-called canals of Mars.



Drawings of the Moon and planets show much finer detail than it is possible to obtain by any photographs. Figure 37 is a drawing of Eratosthenes made thirty-eight hours later in the lunation than the photograph. Few changes have taken place in the meantime, and the three dark areas within the crater can be readily recognized. It will be noticed that numerous fine canals not at all visible in the photograph appear in the drawing. A much more detailed account of this crater will be found in the *Annals of Harvard College Observatory*, LIII, 75.

Since different observers sometimes represent the same detail by different methods of shading, and since to some eyes fine markings, like canals, appear of much less breadth than to others, it is very desirable where two drawings are to be compared, that they should both be, if possible, by the same observer. The sketch of Mars, Figure 38, was made by the writer when at the Lowell Observatory in Arizona. The similarity in appearance of the canals in these two figures, together with their variability under similar conditions, leads one to believe that they are due to the same cause, namely, vegetation.

During the summer of 1904 the writer was able to spend eight weeks at the Lowe Observatory in southern California. A considerable portion of his time was devoted to a study of Eratosthenes. The interior was found to be seamed by numerous fine cracks. Watching some of these cracks soon after the sun rose upon them, he was able to see them broaden out and change gradually into canals. It is his belief that the cracks gave out water vapor, which fertilized the vegetation along their sides and in their vicinity, and that it was the growth of this vegetation that produced the appearance of a canal.

The canals of Mars are on a much larger scale than those of the Moon; one of them indeed reaches the enormous length of 3500 miles. If they are produced naturally, the surface of the planet must be cracked in many places. It is generally thought that terrestrial volcanoes lie along subterranean cracks that do not reach the surface. The volcanoes of the great chain of the Andes lie along a straight crack reaching from southern Peru to Terra del Fuego, 2500 miles in length. The volcanoes of the Aleutian Islands lie along a curved crack equally long. Since other shorter lines of volcanoes are very numerous upon the Earth, and since countless others existed in former times, the cracks in the Earth's crust must be exceedingly numerous. Every dike and mineral vein indeed bears witness to this fact. There is no reason why terrestrial cracks should not be as numerous as those upon the Moon. In the case of the Earth they have usually been closed, sometimes by liquid matter from below, and sometimes by surface denudation. There is one



crack, however, which comes to the surface in various places in eastern Asia and western Africa, and stretching from the Dead Sea to Lake Nyassa, reaches the enormous length of 3500 miles. The longest known crack upon the Moon, that of Sirsalis, measures about 400 miles.

It does not necessarily follow, however, even if both the Martian and lunar canals are due to vegetation, that the vegetation is watered in the same manner. There is certainly an atmospheric circulation upon Mars, giving rise to clouds, that might aid materially any subterranean forces. *Annals of Harvard College Observatory*, LIII, 155. Whether these forces could be directed intelligently by assumed intelligent inhabitants of the planet we do not know. The only argument in favor of the existence of such inhabitants is the artificial appearance of the canals. The four canals radiating from the little lake just above the centre of Figure 37 will appear to some minds quite as artificial in appearance as the four canals radiating from the elongated lake to the right of the centre of Figure 38.

To the southeast and southwest of Kilauea lies a desert region crossed in places by steam cracks. One of the first questions that I asked my guide on reaching the Volcano House was if any of these cracks were still active. He assured me that such was the case, and the next day we visited some that were near Keanakakoi. The desert was found to be absolutely barren except for certain long, narrow strips of vegetation. These consisted chiefly of ferns, some bushes, and a few trees. It was found that they grew over the steam cracks, one of which is shown in Figure 39. This particular crack was a yard in width, over two yards in depth, and about thirty yards long. If the region could have been viewed from a slight elevation we should have found a system of canals crossing the desert, these canals being due to vegetation, and differing in appearance from those found upon the Moon and Mars in no respect save size.



REFERENCE INDEX TO DESCRIPTIONS OF THE ILLUSTRATIONS.

SECTIONAL DRAWINGS ON PAGE 171.

Fig. <i>a.</i>	154, 169, 169.	Fig. <i>i.</i>	165, 169.
“ <i>b.</i>	154, 169, 169.	“ <i>j.</i>	167, 168, 169.
“ <i>c.</i>	155, 169, 169.	“ <i>k.</i>	157, 165, 167, 168, 169.
“ <i>d.</i>	157, 158, 169, 169.	“ <i>l.</i>	157, 168, 168, 169.
“ <i>e.</i>	155, 169, 169.	“ <i>m.</i>	157, 168, 169.
“ <i>f.</i>	157, 169.	“ <i>n.</i>	168, 169.
“ <i>g.</i>	164, 168, 169.	“ <i>o.</i>	168, 169, 169.
“ <i>h.</i>	164, 168, 169.	“ <i>p.</i>	157, 168, 168, 169.

PHOTOGRAPHS.

Fig. 1.	154.	Fig. 21.	166.
“ 2.	155.	“ 22.	167.
“ 3.	155, 158, 165, 173.	“ 23.	170.
“ 4.	156, 158.	“ 24.	170.
“ 5.	156, 157, 167, 168.	“ 25.	170.
“ 6.	156, 164, 175.	“ 26.	170.
“ 7.	157.	“ 27.	172.
“ 8.	157, 166.	“ 28.	172.
“ 9.	158, 164.	“ 29.	157, 173, 173, 176.
“ 10.	158, 158, 164.	“ 30.	174.
“ 11.	159, 159, 160, 165.	“ 31.	157, 172, 173.
“ 12.	160, 163, 167.	“ 32.	161, 174.
“ 13.	160, 163.	“ 33.	174.
“ 14.	157, 160, 161.	“ 34.	175.
“ 15.	157, 164.	“ 35.	157, 176.
“ 16.	161, 164, 167, 168, 170, 170.	“ 36.	175.
“ 17.	166.	“ 37.	177, 178.
“ 18.	165.	“ 38.	177, 178.
“ 19.	166, 166, 168.	“ 39.	178.
“ 20.	166, 166.		





FIG. 1. DIAMOND HEAD



FIG. 2. CINDER CONES ON MAUNA KEA



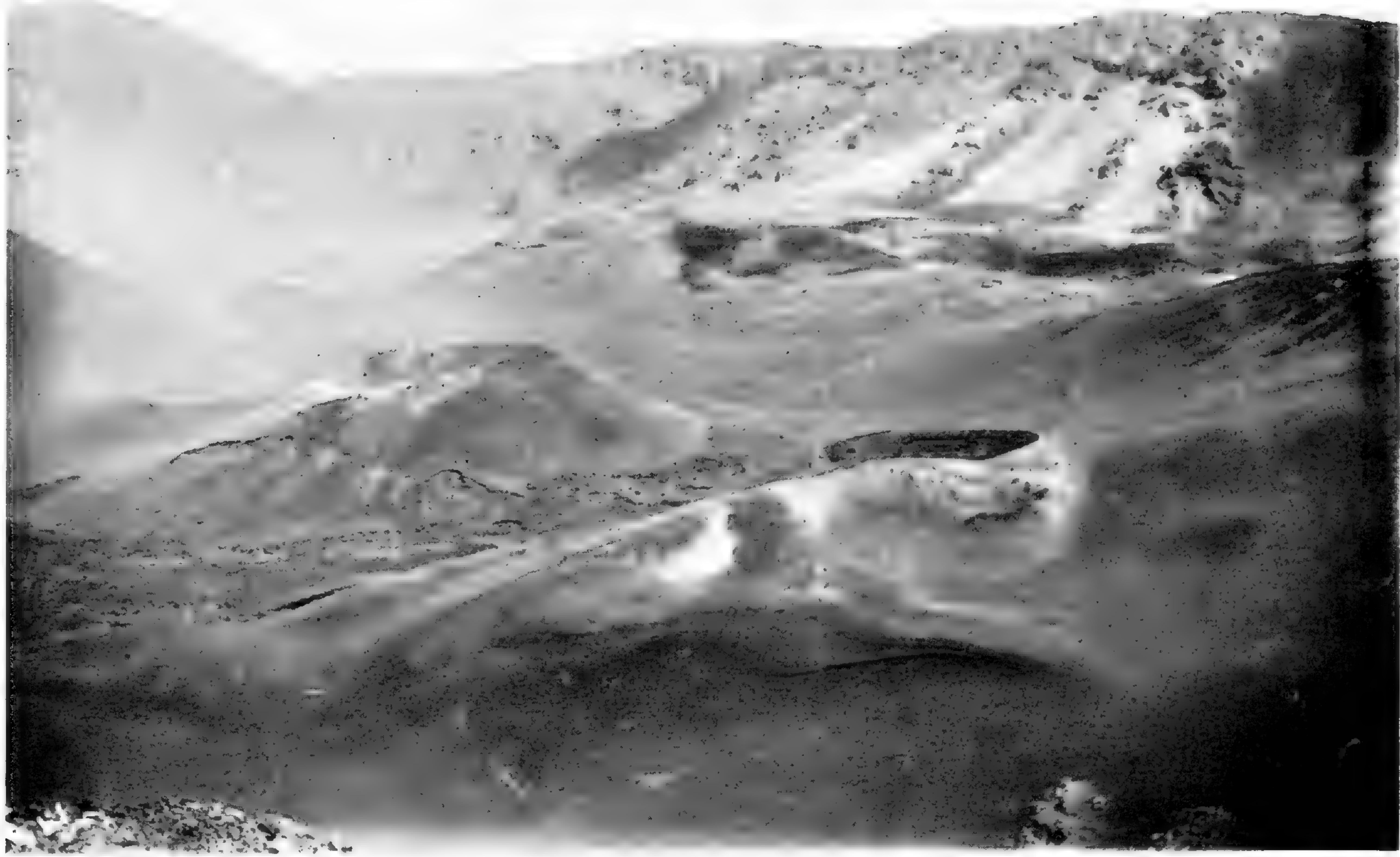

FIG. 3. INTERIOR OF HALEAKALA



FIG. 4. MAUNA LOA





FIG. 5. BULLIALDUS



FIG. 6. KIES AND MERCATOR



FIG. 7. KAUHAKU MOLOKAI





FIG. 8. SIXTH CRATER NEAR KILAUEA



FIG. 9. MOKUAWEOWEO. MAUNA LOA





FIG. 10. KILAUEA FROM WALDRON'S LEDGE



FIG. 11. SLAG SECTION





FIG. 12. LAVA LAKE IN KILAUEA



FIG. 13. LAVA LAKE IN KILAUEA





FIG. 14. SCHICKARD. PHOCLIDES



FIG. 15. SINUS IRIDUM

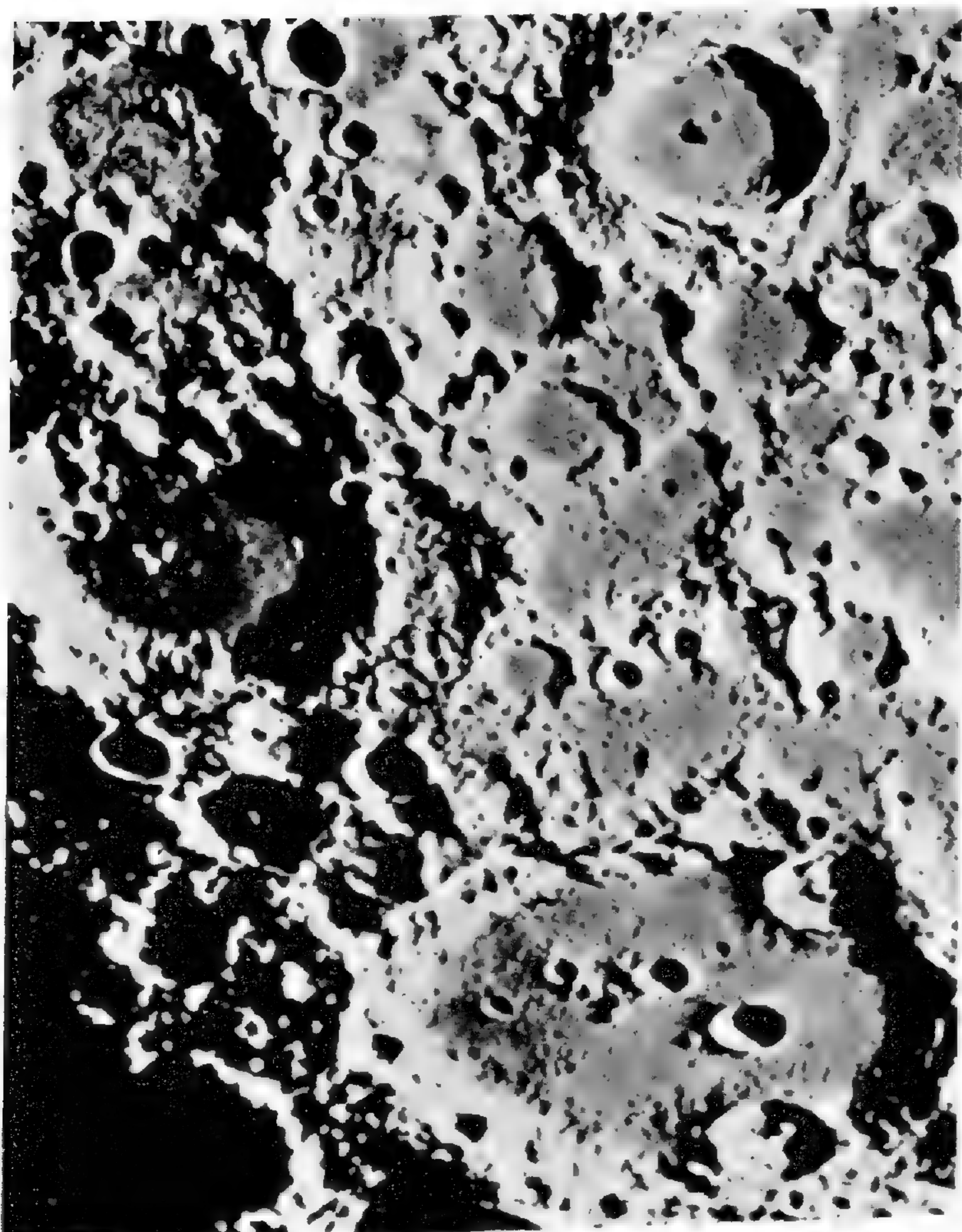

FIG. 16. CLAVIUS. LONGOMONTANUS. TYCHO

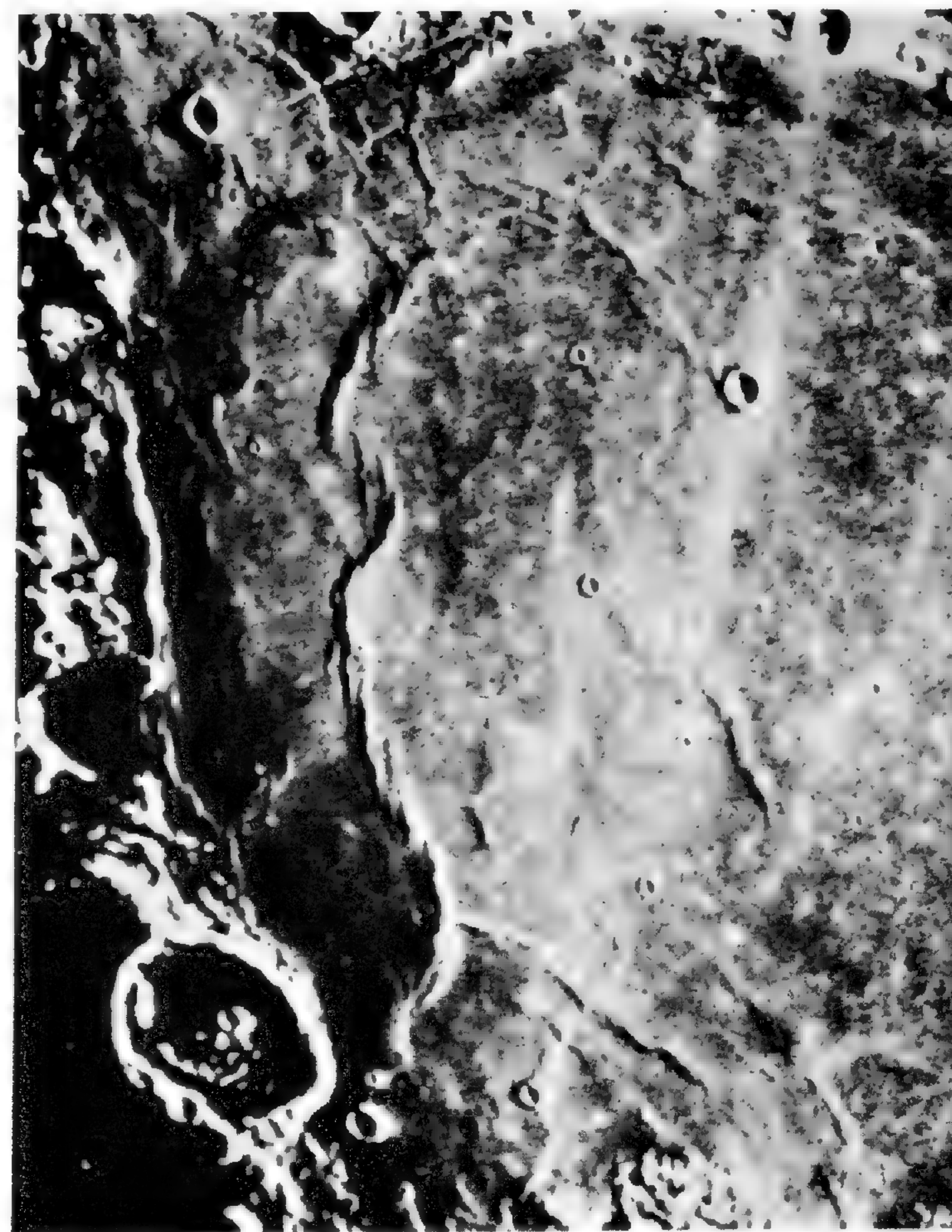

FIG. 17. RIDGES. MARE SERENITATIS





FIG. 18. MOKUAWEOWEO. MAUNA LOA



FIG. 19. CRATERLETS KILAUEA IKI





FIG. 21. TOP OF CRATERLET. KILAUEA IKI



FIG. 22. CRATER PIT. KILAUEA IKI





FIG. 22. PART OF CRATER BOWL. HUALALAI



FIG. 23. SPIRACLES. KILAUEA





FIG. 24. SPIRACLES. KILAUEA



FIG. 25. SPIRACLES. HUALALAI





FIG. 26. PINNACLE. KILAUEA



FIG. 27. PINNACLE. HALEAKALA





FIG. 28. PINACLES. MARE IMBRIUM

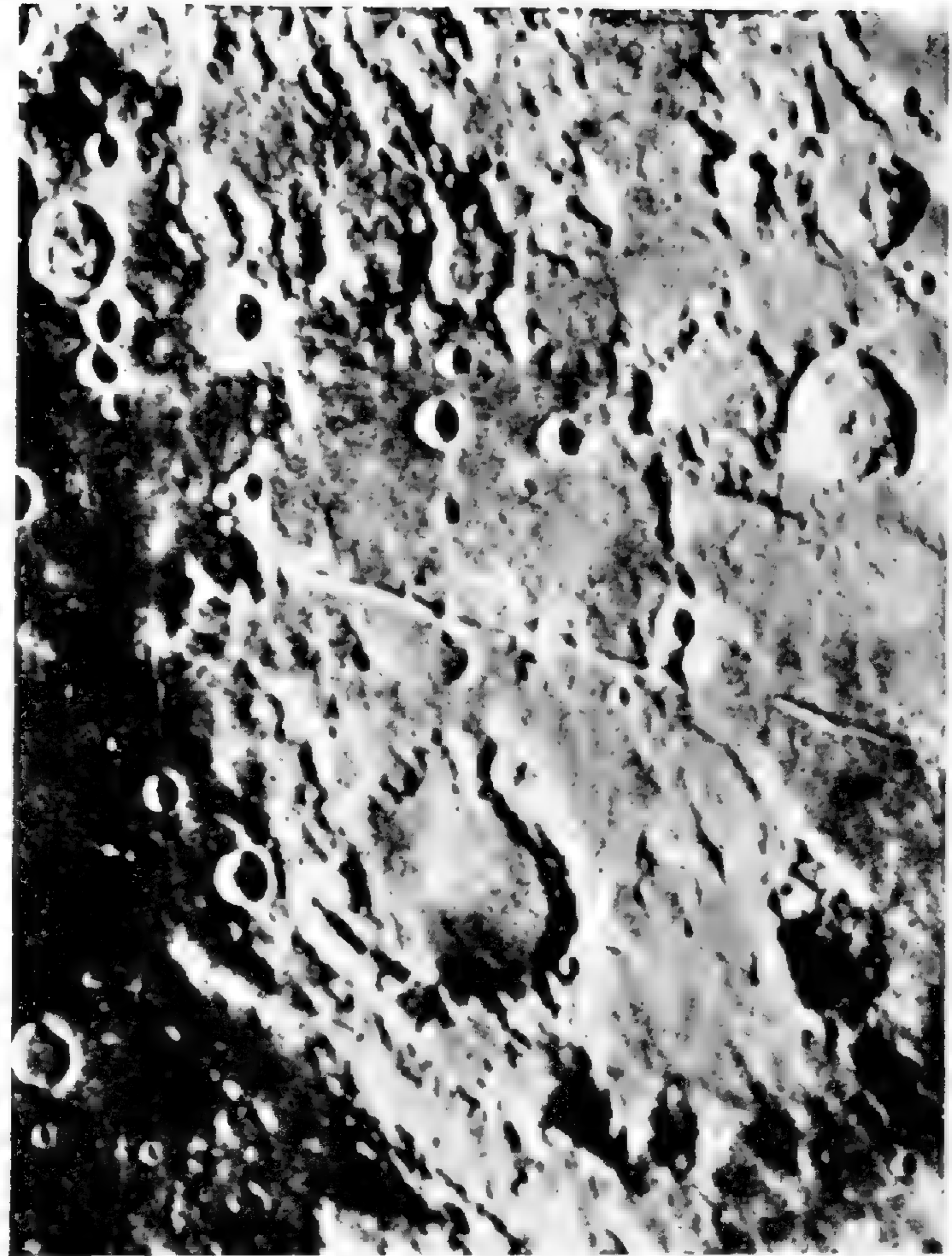

FIG. 29. ARIADAEUS RILL



FIG. 30. CRACK. KILAUEA





FIG. 31. VALLEY OF RHEITA



FIG. 32. BULLIALDUS  $\zeta$



FIG. 33. CRACK, HUEHUE



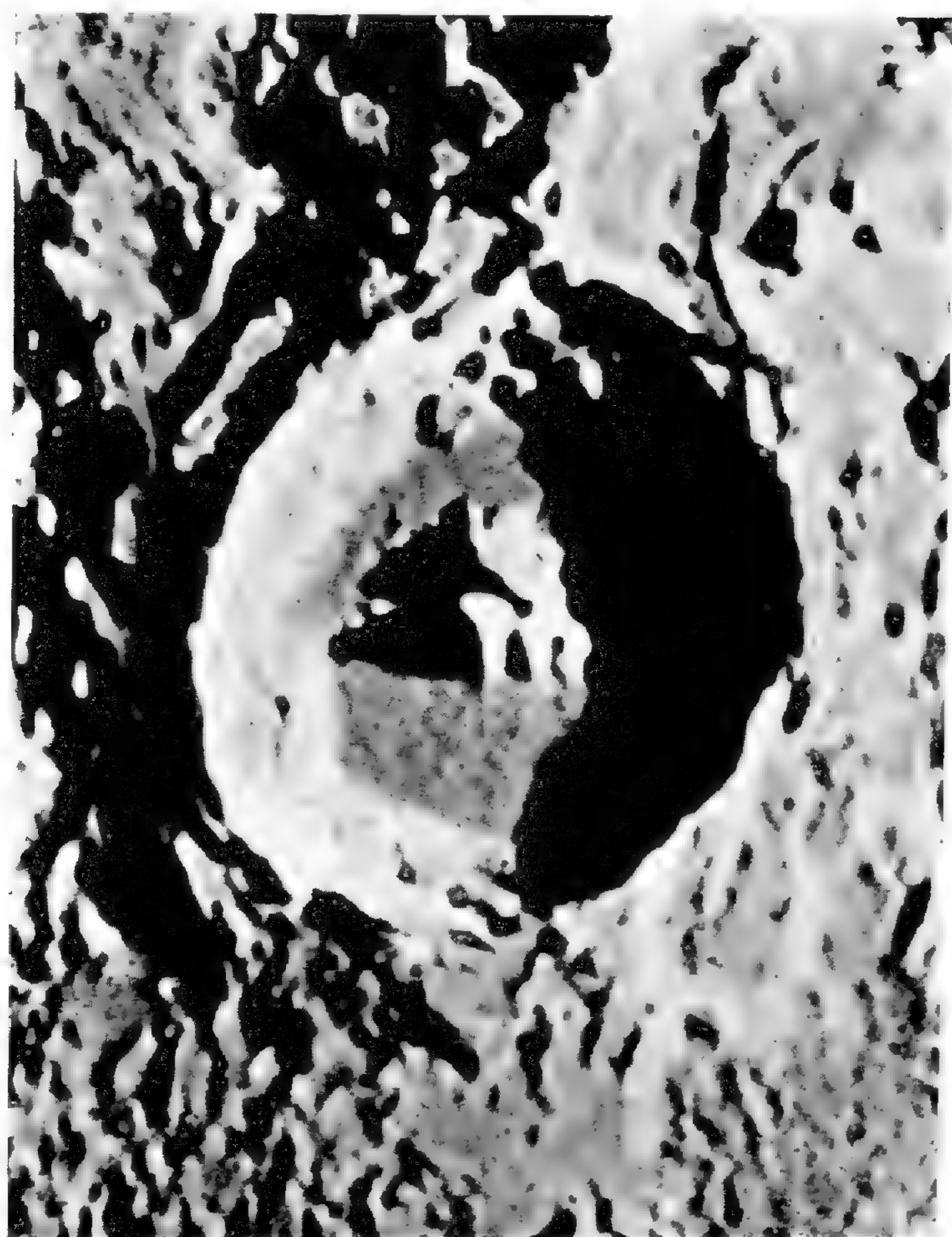

FIG. 34. THEOPHILUS

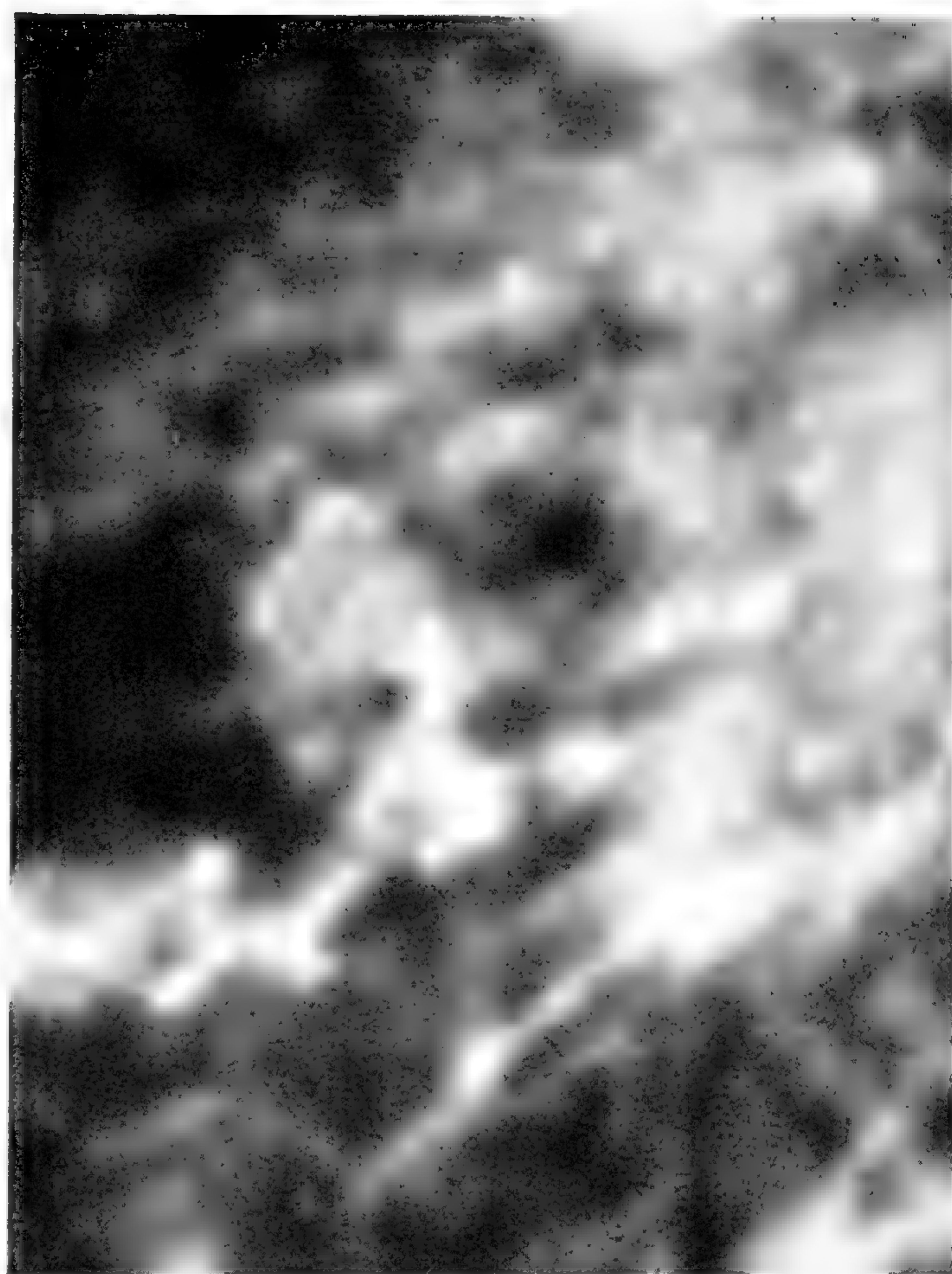

FIG. 35. ERATOSTHENES



FIG. 36. EROSION VALLEYS FROM TANTALUS. OAHU





FIG. 37. LUNAR CANALS

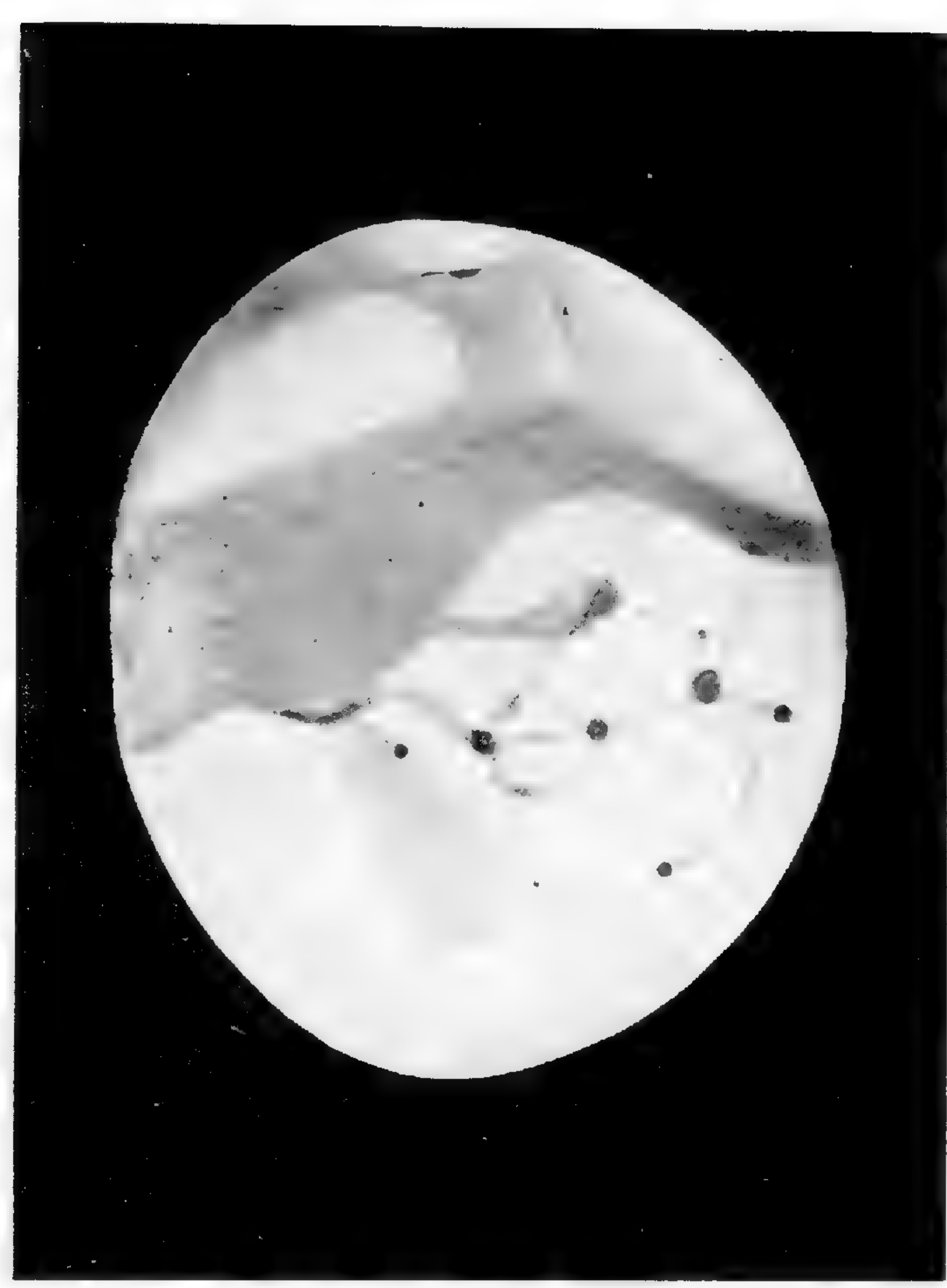

FIG. 38. MARTIAN CANALS



FIG. 39. TERRESTRIAL CANAL NEAR KILAUEA



**PUBLICATIONS**  
OF THE  
**AMERICAN ACADEMY OF ARTS AND SCIENCES.**

---

**MEMOIRS.** OLD SERIES, Vols. 1-4; NEW SERIES, Vols. 1-12.  
16 volumes, \$10 each. Half volumes, \$5 each. Discount to  
booksellers 25% ; to members 50%, or for whole sets 60%.

- Vol. 11.** PART 1. Centennial Celebration. 1880. pp. 1-104. 1882. \$2.00.  
PART 2. No. 1. Agassiz, A. — The Tortugas and Florida Reefs. pp. 105-134.  
12 pls. June, 1885. (Author's copies, June, 1883.) \$3.00.  
PART 3. Nos. 2-3. Searle, A. — The Apparent Position of the Zodiacal Light.  
pp. 135-157 and Chandler, S. C. — On the Square Bar Micrometer. pp. 158-178.  
October, 1885. \$1.00.  
PART 4. No. 4. Pickering, E. C. — Stellar Photography. pp. 179-226. 2 pls.  
March, 1886. \$1.00.  
PART 4. No. 5. Rogers, W. A., and Winlock, Anna. — A Catalogue of 130 Polar  
Stars for the Epoch of 1875.0, resulting from the available Observations made  
between 1860 and 1885, and reduced to the System of the Catalogue of Publi-  
cation XIV of the Astronomische Gesellschaft. pp. 227-300. June, 1886. 75c.  
PART 5. No. 6. Langley, S. P., Young, C. A., and Pickering, E. C. — Pritchard's  
Wedge Photometer. pp. 301-324. November, 1886. 25c.  
PART 6. No. 7. Wyman, M. — Memoir of Daniel Treadwell. pp. 325-523.  
October, 1887. \$2.00.

- Vol. 12.** 1. Sawyer, E. F. — Catalogue of the Magnitudes of Southern Stars  
from 0° to -30° Declination, to the Magnitude 7.0 inclusive. pp. 1-100. May,  
1892. \$1.50.  
2. Rowland, H. A. — On a Table of Standard Wave Lengths of the Spectral  
Lines. pp. 101-186. December, 1896. \$2.00.  
3. Thaxter, R. — Contribution towards a Monograph of the Laboulbeniaceæ.  
pp. 187-430. 26 pls. December, 1896. \$6.00.  
4. Lowell, P. — New Observations of the Planet Mercury. pp. 431-466. 8 pls.  
June, 1898. \$1.25.  
5. Sedgwick, W. T., and Winslow, C. E. A. — (I.) Experiments on the Effect of  
Freezing and other low Temperatures upon the Viability of the Bacillus of  
Typhoid Fever, with Considerations regarding Ice as a Vehicle of Infectious  
Disease. (II.) Statistical Studies on the Seasonal Prevalence of Typhoid  
Fever in various Countries and its Relation to Seasonal Temperature. pp. 467-  
579. 8 pls. August, 1902. \$2.50.

- Vol. 13.** 1. Curtiss, D. R. — Binary Families in a Triply connected Region,  
with Especial Reference to Hypergeometric Families. pp. 1-60. January, 1904.  
\$1.00.  
2. Tonks, O. S. — Bryozoa: his Characteristics. pp. 61-119. 2 pls. November,  
1904. \$1.50.  
3. Lyman, T. — The Spectrum of Hydrogen in the Region of Extremely Short  
Wave-Length. pp. 121-148. pls. iii-viii. February, 1906. 75c.

**PROCEEDINGS.** Vols. 1-40, \$5 each. Discount to booksellers  
25% ; to members 50%, or for whole sets 60%.

The individual articles may be obtained separately. A price list of recent  
articles is printed on the inside pages of the cover of the Proceedings.

---

Complete Works of Count Rumford. 4 vols., \$5.00 each.  
Memoir of Sir Benjamin Thompson, Count Rumford, with Notices of  
his Daughter. By George E. Ellis. \$5.00.

---

Complete sets of the Life and Works of Rumford. 5 vols., \$25.00 ;  
to members, \$5.00.

---

For sale at the Library of THE AMERICAN ACADEMY OF ARTS AND  
SCIENCES, 28 Newbury Street, Boston, Massachusetts.



MEMOIRS  
OF  
THE AMERICAN ACADEMY  
OF  
ARTS AND SCIENCES



VOL. XIII. — No. V.

CAMBRIDGE:  
JOHN WILSON AND SON,  
University Press.

MAY, 1907.







V.

HIGH ELECTROMOTIVE FORCE

ITS APPLICATION TO THE STUDY OF POWERFUL ELECTRICAL DISCHARGES  
AND TO SPECTRUM ANALYSIS.

BY

JOHN TROWBRIDGE.

---

WITH PLATES XXV - XXVII

---

PRESENTED MARCH 13, 1907. RECEIVED MARCH 5, 1907.

INVESTIGATIONS ON LIGHT AND HEAT MADE OR PUBLISHED, WHOLLY OR IN PART, WITH APPROPRIATIONS  
FROM THE RUMFORD FUND







## CONTENTS.

---

	PAGES
DESCRIPTION OF THE BATTERY . . . . .	185-190
LEAKAGE TO GROUND AND SIDE DISCHARGES . . . . .	190, 191
FLAME IONIZATION AND ELECTRICAL WIND . . . . .	191-193
CHARGING CONDENSERS . . . . .	193-197
OSCILLATION OR PULSATION OF THE CELLS . . . . .	197-199
POWERFUL DISCHARGES OF ELECTRICITY AND A METHOD OF PHOTO- GRAPHIC INTENSIFICATION OF THEIR IMAGES . . . . .	199-204
SPECTRUM ANALYSIS WITH CURRENTS OF HIGH ELECTROMOTIVE FORCE AND STRONG CURRENTS . . . . .	204-207
REVERSAL OF METALLIC LINES . . . . .	207-214
RESULTS . . . . .	214, 215







## HIGH ELECTROMOTIVE FORCE.

### DESCRIPTION OF THE BATTERY.

THE appliances for research have greatly increased since the time of Faraday; but it is significant that the wealth of means has not contributed much to our knowledge of the science of electricity. The advances have come from workers who have not had at their command very powerful electrical currents, such as are used in commercial applications; and I am led to conclude that the best equipment of a physical laboratory resides in good minds and not in elaborate installations and large collections of physical apparatus.

Nevertheless a step is made when the limits of application of the present powerful sources of electricity can be shown in such a subject, for instance, as Spectrum Analysis.

Thirty years ago investigators depended upon voltaic batteries for their source of electric currents. The limits of electromotive force were necessarily low, on account of the expense involved in a plant of a large number of cells, and the labor of setting up the cells was very great. In the literature of electricity and magnetism one finds a full account of the large experimental battery of de la Rue and Müller. This consisted of 8040 elements of amalgamated zinc and chloride of silver in a salt or sal ammoniac solution. Each cell consisted of a glass tube 15.23 cm. long and 1.9 cm. in diameter. The tube was closed by a rubber stopper to avoid evaporation: the chloride of silver paste and a strip of silver constituted the positive pole of the cell. This silver strip was carefully protected from the sulphur of the rubber stopper by suitable insulation. The electromotive force of each element was 1.03 volts and the internal resistance of each cell 38.5 ohms. The total electromotive force of the battery was approximately 8281.2 volts. De la Rue and Müller recommend such an installation for use in spectrum analysis.

Before entering upon a more detailed account of a much larger installation I will give here, for comparison, similar data in regard to this installation.

The cells of the battery in the Jefferson Physical Laboratory number 20,000; the glass tubes of each cell are 14 cm. long, 1.9 cm. in diameter, — not differing therefore much in size from the de la Rue and Müller battery. The electromotive force of



each cell is approximately 2 volts and the internal resistance 1.50 volts; the total electromotive force of the battery is 40,000 volts. It can produce in air an initial spark of 3.5 cm. to 4 cm., and when the terminals are quickly drawn apart, a flaming discharge of 60 cm.

This modern large installation has been made possible by the discovery of the Planté accumulator, which enables one to utilize the powerful currents generated by the dynamo machine to polarize lead plates and thus to dispense with voltaic cells. The latter have entirely disappeared from physical laboratories except for minor purposes, such as call bells; and the three or four hundred Bunsen or Grove cells which were once used in lectures on physics have been thrown into the scrap heap.

I published in the Proceedings of the American Academy, Vol. XXXII, p. 253, also Vol. XXXIII, p. 435, a description of this battery, which I had constructed for the purpose of studying the spectra of hydrogen, especially the new series of hydrogen lines discovered by Professor E. C. Pickering in the spectrum of certain stars. It was hoped that under conditions of high electromotive force and strong currents this new series might be reproduced in a laboratory. Although this hope was found to be fallacious, the installation of such a large plant has proved extremely useful where a steady electric field is necessary.<sup>1</sup> It has shown that spectrum analysis of rarefied gases is practically limited to comparatively small electromotive forces and weak currents. An experience of twelve years in the use of the battery impels me to gather in a memoir the results of my experience. The life of the battery as it was originally constructed has been ten years, and the improvements I shall describe in this memoir will, I believe, greatly extend its life.

The form of cells which I adopted, consisting of test tubes enclosing strips of lead formed by the Planté method, is undoubtedly the cheapest and most compact form that can be selected. A less number of cells, of larger size and of the pasted type, might be more enduring; but they would occupy a much greater space and would be far more expensive.

The battery with which I have experimented requires a room 20 × 30 × 14 feet. It is contained in eight cabinets or cases. The space occupied by the battery could be lessened by a more compact arrangement of the trays which hold the cells.

Each of the unit trays consists of three compartments (Figure 1, Plate XXV), and holds sixty cells. The supports of the test tubes are made of kiln-dried whitewood soaked in paraffine. The tubes rest on a lower shelf, and are held upright in holes in an upper shelf. The individual trays, comprising together what I have termed a unit,

<sup>1</sup> H. L. Blackwell, Proc. Am. Acad., Vol. XLI, No. 32.



are placed side by side with an air space between them, and are kept apart by glass or porcelain tubes.

It is necessary that the cells of each tray should be connected with lead wire, and that the connection between these lead wires and the switches, together with the copper conductors of the exterior circuit, should be far removed from the cells. When the battery was first installed, these connecting lead wires were led through glass tubes in the wood partitions separating the trays. It was soon found, however, that the sulphuric acid crept along the lead connecting wires, a distance of eight to ten inches from the cells, covering the glass conduits and soaking into the wood partitions, thus short-circuiting the cells. Accordingly the glass tubes were removed and the lead wires were led through air spaces. This disposition remedied the difficulty. My experience with various insulating material has taught me that dry air is the best insulator that one can obtain at moderate expense; and next to it is kiln-dried wood soaked in paraffine. The latter, however, must not be exposed to acid fumes.

The scheme of electrical switches for this experimental plant has been the subject of much thought. It was desirable that a range of voltage extending from the contents of one of the unit trays — 60 cells, approximately 120 volts — through all the multiples of this unit up to 40,000 volts, could be obtained. At first the cells were charged in multiple with a current of 60 volts, the cells being arranged in multiple, 20 cells in each derived circuit, the charging current through each cell being one-thirtieth of an ampere.

The switchboards are placed on the back of each of the unit cabinets, there being eight of these cabinets. The switches are three point switches (Figure 2, Plate XXV). When they are thrown to the right, the batteries are in multiple for charging; when thrown to the left, the cells are in series. An entirely similar switchboard serves to throw each cabinet into multiple or tandem.

It is evident that with a charging current of only 60 volts a large number of switches are necessary. The following arrangement, suggested to me by Dr. H. W. Blackwell, who has studied the disposition of the cells for use in his work on electric double refraction, has greatly simplified the arrangement of switches, and lessened the work of throwing the cells from multiple to series:

A charging current of 500 volts is now used. The cells in each cabinet are arranged in multiple, 60 in each shelf,  $3\frac{1}{2}$  shelves, or 420 volts. This change merely requires throwing a one point switch on the switchboard, the cells remaining in series, and being divided at a middle point, giving 210 cells in each derived branch. With a suitable transformer and a mercury rectifier it is evident that the number of switches



and switchboards could be further reduced. The danger in using the batteries evidently increases with the number of switches which must be manipulated. This danger is very great, for 20,000 cells, even of the small test tube type, can yield for a few seconds a current of eight amperes at 40,000 volts. In using the batteries one is speedily convinced that a steady current of large amperage at voltages as low as 200 can be dangerous to life. The amperage is just as important a factor as electromotive force in considering this danger.

Figure 2, Plate XXV, shows the arrangement of connections and switches on the back of each compartment of the battery. There are 48 compartments. In each compartment there are 7 shelves, 60 cells to each shelf; thus 420 cells, or 820 volts, to a compartment. These cells are connected to the line for charging or discharging by the switches *S*. When these switches are thrown to the right hand of one facing the switchboard, the cells of each shelf are connected in series up to switches  $S_4 S_4$ . At this point  $3\frac{1}{2}$  shelves are put in multiple; that is, 210 cells, or 420 volts. The charging current of 500 volts thus has to overcome this difference of potential. All of the switches *S* to  $S_4 S_4$  are thrown to the right, both in charging and discharging. To discharge it is only necessary to throw switch  $S_5$  to the left, thus putting all the cells in series. The time necessary to throw the cells from charging to discharging is ten minutes. From two to three hours of charging with a voltage of 500 and a current of two amperes is generally necessary to bring the cells up to working voltage. As in the case of all lead accumulators or storage batteries, a transient or pseudo voltage, if the cells are not fully charged, is shown, which quickly disappears in connecting the terminals of the cells.

One of the chief causes of the deterioration of an accumulator is the buckling of the plates due to overdischarging. This buckling causes the positive and negative plates to touch, and thus to short-circuit the cells. This buckling can readily happen unless the plates are massive, or held apart rigidly. Massive plates add much to the weight of the cells, and when a large number are needed for great electromotive force the weight is prohibitive. The plates are 1.2 cm. broad, 14 cm. long, and are approximately 1 mm. thick, weighing approximately one-sixteenth of a pound. They are roughened deeply by a suitable die.

At first I adopted the expedient of keeping the plates apart by means of rubber bands. Experience, however, has shown that this is a very temporary expedient, for the rubber disintegrates, and also becomes covered in time with the active material which falls from the plates; they then serve as conductors to short-circuit the cells. In a new arrangement of the cells I have dispensed with the rubber separators and



use wood separators; these wood separators are somewhat broader than the lead plates and a centimeter longer. They reach to the bottom of the glass containing tube, while the lead plates are lifted from the bottom of these tubes about a centimeter. The active material, therefore, which might fall to the bottom of the cells cannot short-circuit the cells. The separators consist of strips of wood 1 mm. thick. When they are saturated with the dilute acid, they do not oppose any appreciable resistance. The use of wood separators in storage cells was discovered by Mr. E. P. Usher in a remarkable installation at Milford, Mass., which served as the source of electric power for trolley cars on the route between Milford and Hopedale. Mr. Usher was the first to show that they did not oppose any appreciable resistance, and that they prevented the trouble of buckling. With the employment of these wood separators the experimental battery which I describe in this memoir can be short-circuited without danger to the battery.

Figure 1, Plate XXV, shows one tray of the battery with wood separators extending to the bottom of the tubes. Lead wires connect the plates of the cells to the switches on the back of the compartments which hold the cells. These wires extend from each row of cells to the switches connecting the rows of cells, a distance of, approximately, 50 cm. It was found necessary that these lead wires should rise vertically from the cells through a distance of 4 or 5 cm., in order that the acid solution in the cells which creeps up the wire should drain back into the cells instead of dripping upon the wooden supports of the cells. These lead wires do not touch the woodwork at any point, and do not rest upon any insulators save two porcelain insulators which are directly above the end cells on each shelf. It was found, as I have said, that if they were led through glass tubes inserted in wood, the glass in time became covered with an acid solution which was communicated to the wood in which the glass tubes were inserted, and the wood thus became conducting. The liquid in the cells, dilute sulphuric acid, is covered with a thin layer of paraffine oil to prevent evaporation. The acid solution is renewed about once in three months to replace the loss due to this evaporation. The lead plates in the course of two or three years become friable, having become almost entirely converted into active material, and therefore need to be replaced. This replacement, of course, depends upon the use of the battery. Thicker plates would lengthen the life of the cells, but would also lead to greater weight.

An open construction of each compartment of the battery is desirable, in order that the condition of the cells can be easily seen by passing an incandescent lamp behind the rows of cells. This open construction is shown in Figure 3, Plate XXV. It



will be seen from Figure 1, Plate XXV, that each tray of cells rests upon porcelain insulators at their ends and at their middle. The wood between the rows of cells is removed, leaving a slot; the only wood connection is therefore at the ends of the trays.

#### LEAKAGE TO GROUND AND SIDE DISCHARGES.

The installation of such a large storage battery as I describe in this memoir presents many interesting problems of insulation, and it is probable that with the most perfect insulation possible there is an invisible ionization between the cells and the earth.

Such ionization becomes visible in the form of the Geissler tube shown in Figure A. The terminal A is connected permanently with the pole of the battery through a large running water resistance of several megohms; the terminal B is connected to the negative pole by a spark gap. EE are condensers connected to the earth. At the instant the spark occurs, a brilliant side discharge occurs between E and A. At the same time that these side discharges take place, a discharge passes between A and B. It is evident that the capacity of the region outside the battery, the room and building, charges up under the difference of potential between it and the poles of the battery, a difference of potential which is greater than that between A and B which are connected by the small resistance of the rarefied gas.

This phenomenon suggests a photometric method of comparing the capacity of

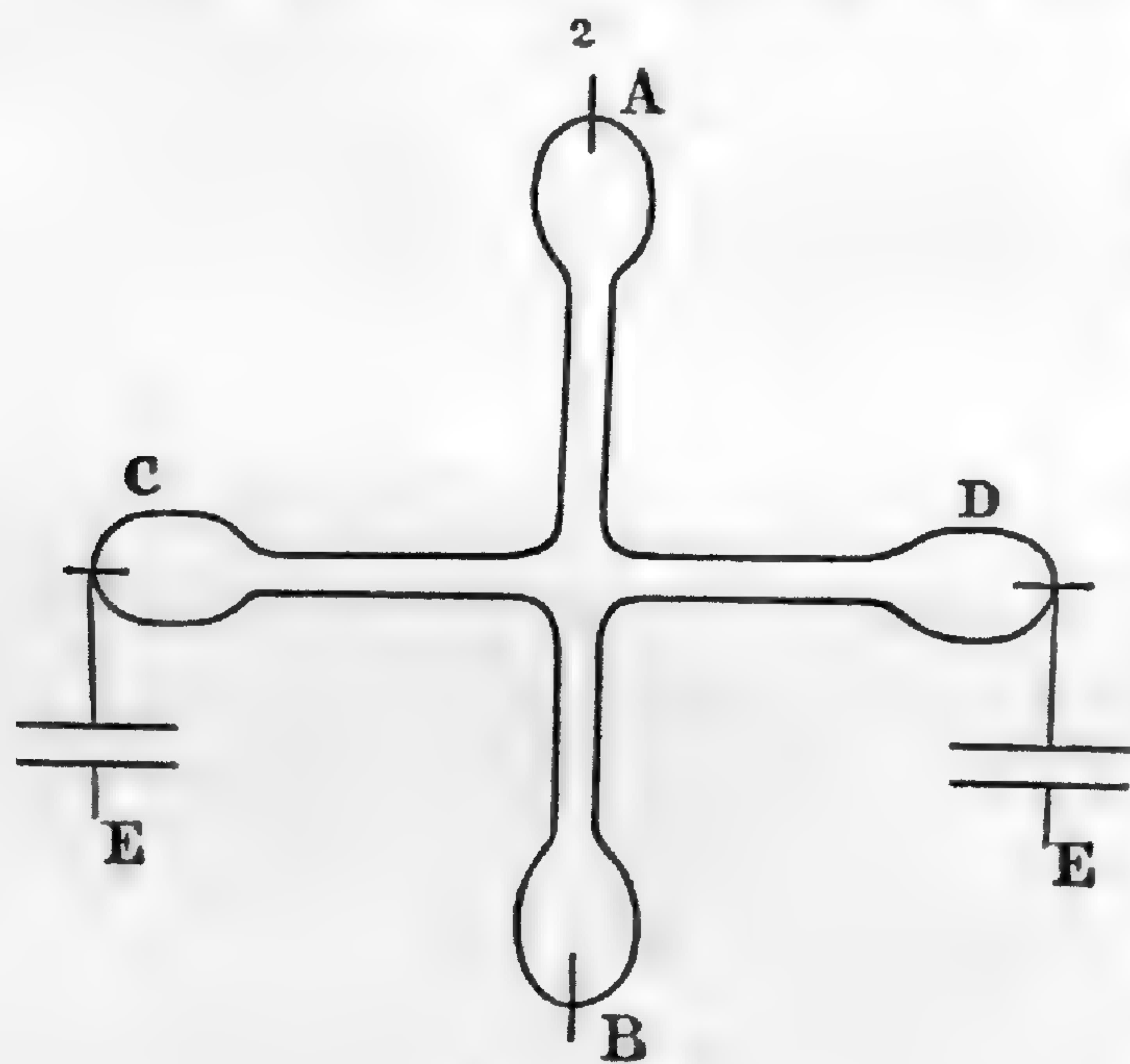

FIGURE A.

large condensers and also of obtaining the capacity of the surrounding space. To the arms C and D of the cross are attached the condensers to be compared. At the instant of completion of the circuit with the storage battery under the conditions mentioned above, two side discharges take place from C and D, either to A or B. By bringing the light of these two simultaneous discharges into a suitable photometric arrangement, one can compare the capacities of the condensers to the degree of accuracy obtainable by ordinary photometric observations. Since it is difficult

to obtain an estimate of the capacity of large bodies of irregular shape and of large extent, this method may be of use. By a suitable vacuum tube and proper exhaustion the method does not require a large number of cells.



It was noticeable that when a stratified discharge was established between A and B, there being no spark gap in the circuit except that of the rarefied space between A and B, fluctuating feeble discharges took place to earth through E. This phenomenon seems to indicate a discontinuity in the stratified discharge.

When the small spark gap, either at the positive or negative pole, is of a suitable length, the discharges between either pole of the battery succeed each other so rapidly that the side discharges to earth appear continuous. If a large condenser is substituted for the earth at E, one plate of the condenser being connected to earth, the time between each discharge is lengthened.

It is probable that in the case of lightning side discharges to the earth take place in the manner indicated by this method; the potential between the positively and negatively charged clouds rising to a higher value than that between the clouds, the earth space beneath the clouds acting as a localized capacity.

#### FLAME IONIZATION AND ELECTRICAL WIND.

By the use of the wooden separators, as I have said, one can short-circuit the cells without fear of permanent injury. In doing this, several interesting phenomena appear. In a dark room a faint glow is always seen on the negative terminal of ten thousand cells. This glow is independent of the position of the positive terminal, and is an evidence of a silent discharge or ionization. On the other hand, a glow at the positive terminal does not appear (with a difference of potential of 20,000 volts) until this terminal approaches to a distance of 17.5 cm. from the negative terminal, both terminals being pointed. After the positive terminal is brought to a distance of 4 or 5 cm. from the negative terminal, — that is, to near the striking distance, — and is then drawn away, the glow on the positive terminal persists to a greater distance than that at which it is just discernible. This is shown in the accompanying table.

First appearance of the glow on the positive terminal.	Glow can be drawn to
17.5 cm.	20.5 cm.
16	20
17.5	20

This phenomenon is analogous to the persistence of the flaring discharge which occurs when the terminals are brought within striking distance and then are drawn apart. This flaring discharge extends to a distance of 60 cm. (with 40,000 volts). I then endeavored to see whether in an unsymmetrical field in air one finds a phenomenon analogous to the Faraday column which extends in the similar unsymmetrical



field of Geisler tubes from the positive terminal to approximately two-thirds of the distance between the pointed terminals in the tube.

A candle flame, therefore, was placed on the line between pointed terminals. These terminals were then moved toward each other until the effect upon the flame was symmetrical; that is, when the flame assumed a flattened shape somewhat like an egg resting on its smaller end. It was then found that the distance of the negative terminal from the centre of the flame was 5 cm., and the distance of the positive terminal 10 cm. It seems, therefore, that even at atmospheric pressure something analogous to the Faraday column begins to manifest itself. In a Geisler tube at suitable pressure, as is well known, this column is steadily driven back from the cathode space as the vacuum rises.

In general experiments on the effect of an electrical field on the flame of a candle with a symmetrical field, I obtain with the terminals of an accumulator of 20,000 volts the results of previous observers who worked with electrical machines.<sup>1</sup>

With pointed terminals it is very evident that the outer mantle of the flame is repelled by the positive terminal of the battery. When the flame is close to this terminal, and is attracted by the negative terminal, the candle is close to the latter. When the negative terminal is in the form of a blunt point, a wing of the outer envelope of the flame is attracted to the surface of the blunt terminal and revolves around the point, sometimes touching the sharp point and then curving away from the point. This action seems to be due to the deposition of soot on the point.

I have spoken of the egg shape of the flame when it is apparently acted upon equally by the positive and negative terminals; and perhaps this remark requires further elucidation. When, for instance, the negative terminal is brought close to the edge of the luminous part of the flame, not touching it, and the positive terminal is moved toward the negative terminal, the flame shortens and spreads out laterally. When, however, the negative terminal touches the outer mantle of the flame, the effect of attraction to it becomes more marked. In these cases it would be difficult to distinguish the negative terminal from the positive by the actions on the flame. When, however, the terminals are approximately twice the striking distance of the battery, the flame of the candle is a ready indicator of the nature of the poles of the battery, being repelled by the positive pole and attracted by the negative.

When the positive terminal is a small sphere, the repulsive effect seems more marked than the flattening effect. When the terminals are slowly brought near each

<sup>1</sup> Neureneuf, *Annales de Chemie et de Physique*, Vol. II, p. 473, 1874; Holtz, Carl: *Répert*, Vol. XVII, p. 269, 1881; Pouillet, *Ann. de Chemie et de Phys.*, Vol. XXXV, p. 490, 1827.



other, the singing of the non-luminous discharge is very distinct. Then a bright white, threadlike discharge occurs, which is immediately followed by a flaring yellow discharge, which, as I have said, can be drawn out 50 to 60 cm. with a difference of potential of 40,000 volts. These experiments illustrate forcibly the modern idea of ionization. The glow at the negative terminal shows that the entire air of the room between this terminal and the positive terminal of the battery participates in this ionization. It would probably be impossible by any method of insulation of the accumulator cells to insulate the positive pole of the battery so that this silent discharge would not manifest itself by this negative glow; for a large surface of any insulator, however perfect, in a limited form, becomes a conductor on account of its extended surface.

#### CHARGING CONDENSERS.

The form of condensers I have adopted is that of the so-called Franklin plate. These plates are  $30 \times 40$  cm. The glass is 3 mm. thick for an accumulator of 10,000 cells, and 5 mm. for 20,000 cells. It is evident from the action of this large accumulator that the strength of current which the accumulator can deliver on a short circuit influences to a marked degree the insulating strength of the condenser which the accumulator charges.

The plates of the condensers are arranged in wooden trays with suitable switches, which enabled me to vary the number of plates. They were also arranged so that they could be charged in multiple and then discharged in series (Proceedings of the American Academy of Arts and Sciences, Vol. XXXIII, No. 24).

This form of condenser, namely the Franklin plate form, does not withstand the potential of the battery so well as the jar form of Leyden jar: a thickness of glass in jar form which will perfectly insulate the terminals of the 20,000 cells when charged to a difference of potential of 40,000 volts would break down when Franklin plates were used of the same thickness. I found that such plates could not be less than one-eighth of an inch, approximately 3 mm., in thickness to withstand constant use of the battery of 40,000 volts. The large storage battery illustrated in an interesting manner the time necessary to charge condensers to a definite potential. When the inner coating of a Leyden jar of about 10,000 electrostatic units is connected with one pole of the battery, and the other terminal rests upon a wooden table upon which the jar is placed, this jar will discharge through a small spark gap once in about ten seconds. When this latter terminal is connected directly with the outer coating of the jar, the rapidity of discharge increases to at least one hundred a second and appears continu-



ous. I was interested to ascertain whether the capacity at the terminals affected the breaking down effect in air and in oil. Without the external capacity, boiled linseed oil broke down between two small spheres one millimeter apart, under a difference of potential of 20,000 volts. A sheet of microscopic cover glass  $\frac{1}{250}$  of an inch in thickness, however, was not perforated, and a sheet of mica  $\frac{1}{1000}$  of an inch also withstood this difference of potential. When a capacity of 10,000 electrostatic units was connected to the terminals of the battery, no difference in the breaking down effect could be detected.

If, instead of the high resistance of the wooden table, a water resistance is intercalated between the poles of the battery and the Leyden jars, the same phenomenon is observed. The jars charge slowly to a sufficient potential, then discharge, and this discharge takes place with remarkable regularity; the smaller the resistance interposed, the more rapid the rate of discharge. The time of discharge can be regulated at pleasure by means of the water resistance, and the battery serves as a species of electrical clock.

The problem of a practical form of resistance early became an important one. I have used cadmium iodide resistances recommended by Hittorf. This form of resistance is useful for weak currents, but it heats under powerful currents. At one time it was thought that graphite resistances might be useful; accordingly a bank of graphite cylinders, made of compressed powdered graphite, were mounted on quartz columnar crystals. It was speedily found that these resistances had a large temperature coefficient, and moreover developed a large back electromotive force amounting to 500 or 800 volts when a difference of 20,000 volts was applied to the bank of resistances. I accordingly adopted a resistance of running water, which was very constant, having no temperature coefficient.

At the base of a large reservoir the water flowed out through a long horizontal tube. A wire introduced into this tube could be pushed in or out of it, and could thus modify the resistance in the circuit. A milliamperemeter introduced in the circuit with the water resistance gave perfectly steady readings.

The periodicity exhibited by the battery in charging condensers through large resistances is analogous to the periodicity shown by the battery in the recovery of the cells after each momentary short circuit. When the short circuits are repeated in regular succession, the striking distance of course diminishes, and also the distance to which the flaming discharge can be extended; finally, such a point is reached that the flaming discharge disappears, and the battery proceeds to discharge by means of bright white sparks resembling condenser discharges. This phenomenon is due to a



diffusion in the cells. Each period of exhaustion is followed by a period of recuperation; and one is strongly reminded of the action of the electrical eel, or the recuperation of human nervous force.

My experience with the mechanism necessary to charge and discharge storage cells leads me to remark that to the electrician the physiological theory of electrical currents in muscles and nerves is incomprehensible and not in touch with any phenomena exhibited by voltaic batteries or electrical machines; for a collection of muscles or nerves, which are apparently homogeneous in matter, or at least do not show marked differences in chemical constitution, can produce, it is said, an electric spark and shocks of considerable severity. If there exists in the separate muscles a source of electricity, in other words a difference of potential, what is the mechanism by means of which the muscles can be discharged in series? for the electromotive force of each muscle must be exceedingly low, and the high electromotive force of the electrical eel must be obtained by some mechanism which enables the animal to throw the effect of each muscle in series with the neighboring muscles. We cannot suppose that we have in these animals, which exhibit such marked electrical energy, a phenomenon like that shown in a thunder cloud. Meteorological observations lead us to conclude that the lightning discharge is not produced like the discharge from a great number of storage cells arranged in series, — that is, from one charged vesicle of water vapor to another, — but rather from the accumulation in series of such charges at some point on the surface of the cloud, the cloud thus acting like a charged condenser. We can thus suppose that the outer layer of vesicles of water are more heavily charged than those in the interior of the cloud. To suppose that there is any discharge in the heavens analogous to the discharge of a storage battery arranged in series, or, to go to physiology for a parallel, to suppose that there is a mechanism in the clouds similar to the arrangement of muscles or nerves in the electrical eel which permits by means of insulating sheaths the accumulation of charges, is to suppose something beyond the experience of the electrician. In short, the theory of animal electricity, in order to be accepted by the electrician, — a theory which supposes that each muscle is like a unit of a storage battery, and that these units are thrown into series in the case of the electrical fishes, — must show how, by an arrangement of nerves and circulation, such a coupling is possible.

The electrician too notices, even in recent books on the nervous system, an account of experiments to detect the induction of a stimulated nerve on a neighboring nerve. The account of such endeavors often immediately follows statements that the velocity of the nerve action is hardly one hundred feet per second. The



electrician knows that no inductive effect between one storage cell of much higher voltage than that of any nerve or muscle can be detected, even when the velocity of the electrical action in the inducing cell is many times that of the nerve action. To the electrician the supposed electrical condition of human muscles and nerves resembles that of a number of suburban towns, each with individual electrical plants not connected to any central station; and the physiologist who can show any ramifications which are analogous to those by means of which electrical energy is transmitted by inorganic machines would overcome much scepticism among physicists in regard to the real existence of electrical currents in human muscles and nerve.

There is, however, one analogy between the action of a storage cell and that of a nerve. This analogy can be found in the phenomenon of electrical diffusion. We recognize this diffusion in the ordinary voltaic cell, which is so universally used in ringing call bells and door bells. These cells discharge, so to speak, their electrical energy with a resultant fatigue, and, after a rest, are capable of exhibiting energy again. The electrical fish, it is said, recuperates after giving a shock. This recovery of a cell source of electricity is shown on a comparatively great scale by a large storage battery. This phenomenon is painfully apparent to the automobilist who drives an electric automobile; for it is an evidence of fatigue in his battery, and it gives an elusive hope of recovery. Have we not seen such an automobilist suddenly coming to a stop, and rest a moment, until by the phenomenon of diffusion in the battery the electromotive force rises sufficiently for him to proceed? An elusive hope, I have said, for another period of fatigue will soon set in, and the periods of necessary rest become longer and longer. In the rise and fall of electromotive force, due to diffusion, we have something very analogous to the recuperation and fatigue of nervous energy; and it is through the study of this phenomenon, I believe, that we shall gain some insight into the mysteries of what is called animal electricity.

The large storage battery of the Jefferson Physical Laboratory exhibits the periodic rise and fall of electrical energy in a manner most suggestive to one who thinks of the analogies between such a collection of units of electrical energy and the supposed collection of similar units in the electrical fish. When the battery is suitably connected to a reservoir like a Leyden jar, this reservoir rises to a definite electromotive force, and then discharges by means of a spark. The curve of rise and fall reminds one of the curves obtained by physiologists, denoting action and fatigue in the electrical conditions of muscles. The discharges of the battery can be so closely regulated that these discharges can be made as regular as the beating of the human heart. If



the novel of "Frankenstein" had been written in this century, the authoress would undoubtedly have equipped her automaton with a storage battery.

If a milliamperemeter is interposed between one terminal of the battery and one coating of the Leyden jar, the current rises to a definite value and remains stationary until the jar discharges. At the moment of discharge the reading of the ampere-meter rises suddenly, and then falls to its steady value, — a value which depends upon the resistance interposed in the circuit. The rise in reading is evidently due to the diminished air resistance at the spark gap. The resistance of the spark is less than an ohm, or at least does not exceed two or three ohms. We can therefore form an idea of the magnitude of the resistance of the air in the case of the silent discharge, and indeed of the brush discharge.

The resistance of the silent discharge estimated in this way, — that is, by the fall in resistance when the spark passes between pointed terminals 2 cm. apart with a difference of potential of 20,000 volts, — is what is usually taken as the electric strength of the interposed layer of air. It depends upon the electric density, which, in turn, is a direct function of the voltage and amperage of the battery. The apparent resistance of the silent discharge thus depends upon the energy of ionization, and the latter is so much the greater, the greater the coated surface of the battery and the voltage and charge.

#### OSCILLATION OR PULSATION OF THE CELLS.

The discharge from a large number of storage cells, like that from a high-tension transformer giving a large amperage, is characterized by a sibilant flame which under a difference of potential of 40,000 volts can be drawn out to more than thirty inches. When a photograph of such a discharge is examined, it is seen to have a brilliant white spark as a nucleus. On account of the flaming nature of the envelope of this central discharge it is difficult to examine its character by means of a revolving mirror. By employing, however, two spark gaps, and maintaining fixed the terminals in the narrow gap, one can photograph the pulsations across this gap. Photographs obtained of the phenomena at this gap observed in a revolving mirror showed very regular pulsations or oscillations.

I have described elsewhere an apparatus for charging condensers in multiple and then discharging them in series.<sup>1</sup> Since writing this paper I have constructed a larger apparatus capable of giving sparks seven feet in length in air at atmospheric pressure. Up to one million and a half volts the length of the discharge is closely

<sup>1</sup> Proc. Am. Acad. of Arts and Sciences, Vol. XXXIII, No. 21, June, 1896.



proportional to the voltage; beyond this point leakage and electrostatic induction prevent accurate measurements. In order to study high voltage the apparatus should be lifted outside a building and placed high above the ground.

It seemed evident from observation of the phenomena that air at atmospheric pressure breaks down with great facility under high voltage combined with large amperage. The resistance of the electric spark varies greatly with the amount of current carried by the spark; and the non-concordant results obtained by different observers for this resistance can be explained by this fact. In one case I found that under a difference of potential of three million volts the spark passed through five centimeters of air in preference to a circuit through a solution of sulphate of copper of one thousand ohms resistance.

One is impressed in studying high voltage combined with large amperage that the study of electrical discharges by means of Holtz machines or other forms of glass inductors leads to limited conceptions of the amount of energy in lightning discharges. If Benjamin Franklin had worked with a high-tension storage battery, he probably never would have dared to try his celebrated kite experiment. Experience has shown that even five hundred volts combined with large current is sufficient to cause death.

The apparent diameter of the electric spark and its apparent direction are determined largely by physiological considerations.

To the eye, sparks of six or seven feet in length appear of at least a tenth of an inch in diameter. To obtain an idea of the size of the thread of luminosity, the discharge was passed through the finest needle hole in a plate of glass five feet square. This hole was made by plugging a much larger hole bored in the glass with paraffine and piercing the paraffine with a needle. When the spark terminals were opposite the hole, each one a foot and a half from it, the spark sought the hole and passed through it. A photograph shows an apparent breadth of spark much greater than the diameter of the hole. Possibly only a portion of the spark passed through the hole, for a surface ionization may have taken place over the surface of the glass.

In regard to the apparent direction of a lightning discharge I tried the following experiment. One observer changed the poles of the apparatus for discharging the condensers, while another, looking through an opening which concealed the spark terminals and only revealed the middle portion of the discharge, noted down his impressions of direction. On comparing the notes of the two experimenters, no agreement was found in regard to direction. This was also true when the discharge was made non-oscillatory.

Considerations of direction may arise from difference of luminosity and difference



of branching at the positive and negative terminals, for this difference exhibited by the two poles of discharge is very marked.

POWERFUL DISCHARGES OF ELECTRICITY AND A METHOD OF  
PHOTOGRAPHIC INTENSIFICATION OF THEIR IMAGES.

The discharges from a large number of condensers, charged in multiple and discharged in series, are probably more nearly identical with lightning discharges than any other forms of discharges within our experimental means; and the photographs of such discharges reveal details which do not appear in the discharges from Ruhmkorff coils or Tesla coils.

With a large portrait lens many of such details appear which are not shown by small lenses. These details, however, are difficult to reproduce. Indeed it often happens in scientific investigation that one obtains faint images which cannot be reproduced by any process of printing, and which do not give satisfactory results with ordinary processes of intensification or methods of repeated printing from quick plates to slow plates.

I have found the following method of obtaining strong contrasts in photography of electric sparks very useful in those cases where there is no general fog over the surface of the negative.

The negative is first intensified by iodide of mercury. The formula is given in most books on photography, and is as follows: Dissolve 14 grs. of bichloride of mercury in 700 c.c. of water and 42 grs. of iodide of potassium in 300 c.c. of water; pour the iodide solution into the mercury till the red precipitate formed is completely dissolved. For use, dilute with water and flow over the negative till the proper density is reached. When the negative is washed, it will turn yellow. I do not remove this yellow by hypo, for it is necessary to the complete success of the method of intensification.

When the negative is dry, it is placed in full sunlight in the morning, when the beams of the sun are nearly horizontal. By suitably inclining the negative one can obtain, in a portrait camera provided with a small stop, an image of the silver deposit, which appears white on a yellow ground. The resulting photograph is therefore also a negative. The faintest silver deposit is reproduced in marked contrast to the background, which has reflected a non-actinic yellow light, or at least a light less actinic than that reflected from the silver image.

I believe that this process of intensification is valuable in the large number of cases in which feeble images are obtained which do not lend themselves to the usual



process of printing by transmitted light. In many cases one can rest content with under exposures, feeling confident that good reproductions can be obtained by this method. Of course there is a certain amount of distortion on account of the angle of reflection, but this can be reduced to a minimum along certain lines which contain the part of the image which is the chief characteristic one seeks to show.

By suitably staining the plate with a yellow dye one can also place the negative in such a position in intense sunlight that the silver deposit, instead of reflecting a brighter image than the background or rest of the plate which contains no fog or image, reflects less light, and therefore appears black in sunlight. In this case one obtains in the camera a positive. This positive often reveals details which are not seen by transmitted light, and moreover gives them in strong contrast with the background or remainder of the plate.

Figure 8, Plate XXVI, shows two striking phenomena. The first is this: at every fork or zigzag along the path of the discharge there is a side discharge. These side discharges are directed toward the cathode. Moreover, each of these side discharges forks or bifurcates in the same manner; that is, they arise at the forks.

In the case of very long sparks, six feet or more, the bifurcations are generally directed to neighboring conducting masses, and are not directed to the cathode. In the case of lightning, masses of clouds at a low potential, not lying along the main direction of discharge, are indicated by these side forking discharges.

The second marked phenomenon is a brush discharge, exactly similar to the brush discharge at the anode before the disruptive spark occurs, at every fork or change of direction of this disruptive discharge.

Thus the peculiarities of the positive pole or anode are seen at every point of the disruptive discharge, especially when there is a choice between many cathodes. This choice can occur when the anode is a point and the cathode is an arc of a circle struck from the point of the anode as a centre, the arc being provided with several spurs or points. This bifurcation is seen in almost every lightning discharge, and it leads the observer to think that he can determine the direction of the lightning discharge, stretching out as it does like the fingers of a pointing hand.

Since the characteristics of the positive pole are so predominant in the disruptive discharge, one cannot help thinking that these characteristics show, so to speak, the superior momentum of the positive electron. In general the positive electron plays a minor rôle in electrical phenomena; but in the disruptive spark there is something characteristic of the positive pole — shall we call it the positive electron? — which completely overshadows the manifestation of the negative electron. We can consider that



in air with disruptive discharges at atmospheric pressure the Faraday column extends to the cathode, leaving no interval for a cathode space.

In air, however, at atmospheric pressure, as I have said, the negative glow at the cathode is far more noticeable than the positive glow when the terminals are far apart. For instance, the negative glow can be detected several hundred feet away from the positive terminal of the battery of 20,000 cells; while the positive glow only appears when the positive terminal is brought within two feet of the negative terminal. One marvels at the extent of invisible ionization extending from the cathode.

The characteristic brush discharge at the positive pole, a characteristic discharge which we see from Figure 8 is reproduced at every fork or bifurcation of the disruptive discharge, is shown in Figure 6. It is seen to consist of bifurcating discharges together with a flaming discharge. Turning to the negative pole (Figure 4) we find the brush discharges are straight, as if drawn in pencil with a ruler, except at their termini, where they end in a diffuse brush.

If the two discharge terminals are in the form of Neptune's tridents, the discharge often separates near the positive terminal, and the two portions appear at first to be undecided which of the points on the negative pole they will select. Finally they decide to unite. This phenomenon is evidently an evidence of the oscillatory nature of the discharge, for it shows that there are points of varying potential along the line of discharge.

Some years ago I showed that an explosion occurs whenever powerful sparks change their direction in zigzags, such as are evident in Figure 8. The spark passed between a plate of glass and a sheet of paraffined paper, and it was found that the paper was perforated at each forking of the discharge. This is shown in Figure 5, in which the spark negative is placed alongside of the negative of the perforations. Possibly these explosions occurring along an extended lightning discharge may be an important element in the phenomenon of the rolling of thunder, for the sound of such explosions would arrive at considerable intervals apart.

An interesting account of the explosive effect at each turning point of a lightning discharge has been given me by Mr. Harvey N. Davis, an instructor in the Jefferson Physical Laboratory, and I give it here, since it is an account by a skilled observer of both the above explosive effects and ball lightning.

“During the 27th of August, 1906, a large boarding-house on the side of Mount Moosilauke, in the town of Warren, N. H., was struck by lightning in an unusually sudden and severe thunder storm. The path of at least three independent discharges could be traced, but they must have been practically simultaneous, for those



who had been caught by the rain half a mile from the house, heard only one sharp report. One of the discharges struck the end of the ridgepole of the barn, and came down the wall to a very obvious ground; and two others landed halfway up the sloping roof of the nearest part of the house, one of them near, but not on a dormer window, and the other at some distance from any sort of a projection such as would ordinarily be expected to 'draw lightning.' In each place there was a spot about a foot across where the shingles had been forced outwards, as though by an explosion just under them, while inside there were two round holes four or five inches in diameter where the plaster had been blown into the room, leaving the laths completely bare. The first of these discharges travelled down the roof to the eaves, and jumped to the telephone wires, bursting out the shingles again as it left the roof. It happened that one of the young women of the house had just closed the dormer window, and was in the middle of the room with her head close to that part of the sloping ceiling where the second of the holes was found. It is possible that this was merely chance, or, on the other hand, her presence may have had some influence on the direction of the original discharge; at any rate, the discharge jumped to her right shoulder, and passed through or over the surface of her body to her left foot, then ran along the floor to the wall, leaving a mark such as might be made with a hot poker, and finally reached earth through the side of the house. The young woman was, of course, completely stunned, but was fortunate enough to escape serious injury. An interesting feature of this discharge was the regularity with which it seemed to explode every time it turned a corner. The explosions between the ceiling and the roof have already been mentioned; the next occurred when the discharge reached the woman's foot. Her shoe and stocking were blown completely off, so that only the left half of the upper of the shoe remained attached to the sole. From her foot it ran along the floor to a tin pail, which was standing on a piece of linoleum, and here it exploded again, overturning the pail, and demolishing the linoleum, some of which was found inside a water pitcher on a stand near by, while one or two shreds reached an adjacent windowpane with force enough to stick between the glass and the sash. Finally, the point where the lightning reached the wall and started down between the sheathing and the plaster was very plainly marked on the outside of the house, a couple of clapboards being forced out several inches. In the room below, the plaster was loosened from the laths all the way down, probably by the pressure of the heated air, but the appearance was quite different from that of the ceiling in the room above. Fortunately nothing took fire.

“At the time of the discharge the guests were in the dining-room at the other side



of the house, and several of those who turned most quickly saw slow moving ball discharges just outside the window. One of those with whom I talked, a trained scientist, was sitting with his back partly turned, and saw only one ball of fire, 'like a glowing coal'; but others said that it had been preceded by one rather larger, perhaps as large as a baseball. When he first saw the second ball, it was three or four feet from the ground, and was falling obliquely, as though it had rolled off the roof of a low ell near by, and its velocity was only a few feet per second, — certainly not enough to leave a streak on his retina, as he noticed at the time. We searched that night, and again carefully the next day, for traces of these discharges in the ground, but could find none. Whether they were independent discharges from the main cloud, or were secondary effect, due to the electrification of the wet roof, I do not know. At any rate, they were not immediately connected with either of the three main discharges, for two of these went to obvious grounds, as has been indicated; and the telephone wires, which carried off the third, were nowhere near the part of the house where these balls were seen."

In long discharges of lightning these explosions, directed at varied angles, could give rise to sound waves, which, starting practically at the same instant, nevertheless, by different angles and degrees of reflection, could arrive at the ear of the listener at considerable intervals, and produce the rolling of thunder.

What, then, are the conclusions that can be drawn from the foregoing manifestations of electric discharges which can be produced by a large number of storage cells? The first fact which impresses one is the importance of the consideration of amperage as well as electromotive force. Throughout scientific literature, and in popular conception, electromotive force has received the chief consideration in discussing the phenomena of lightning. Experiments in laboratories have been conducted with electrical machines which are generally incapable of affording much current. Franklin's experiment with the aid of a kite illustrates an underestimate of the current in a lightning discharge. Even to-day no one would think of repeating Franklin's celebrated experiment, largely from a dread of voltage, but with little conception of the possibility of danger from small voltage and large current. We are beginning to realize, however, that 500 volts, accompanied by a current of from 10 to 20 amperes, is sufficient to destroy human life. One compartment of the storage battery which I have described in this memoir, — a compartment affording something over 800 volts, — short-circuited through the body of the janitor of the laboratory, was sufficient to knock him senseless.

The most powerful electric discharge which we can produce by modern appliances



is a faint shadow of lightning, — so faint that it fails to reproduce in most essential respects the phenomena in the heavens. I have never been able, by the use of resonant tubes or other arrangements, to cause reverberations to reproduce in the slightest degree, even with sparks six feet in length, the rolling of thunder. The energy of an ordinary lightning discharge must be enormous.

The forms of lightning discharges are very varied, and when one asks whether lightning is oscillatory, one should specify the kind of discharge.

#### SPECTRUM ANALYSIS WITH CURRENTS OF HIGH ELECTROMOTIVE FORCE AND STRONG CURRENTS.

For several years I have been endeavoring to obtain new series of hydrogen lines which might presumably manifest themselves at very high temperatures. In the progress of this work I have obtained a number of interesting facts, but I have failed to find a new series of hydrogen lines; possibly the reactions both in glass and quartz vessels mask the series. It seems impossible to experiment at a higher temperature than I have obtained, certainly if one employs such vessels as I have mentioned.

The advantages in using a storage battery for experiments in spectrum analysis are well recognized. These advantages are especially seen in the employment of condenser discharges. When the condensers are charged through a large liquid resistance, they charge to the same potential each time, and then discharge, without the intervention of a discharger, through the Geissler tube. The number of discharges can be closely regulated by the amount of liquid resistance which connects the poles of the condensers to the battery. The regularity of such discharges through the Geissler tubes is remarkable. In popular language one can call the arrangement an electric clock, for the discharges follow each other at regular intervals. In this way one avoids the spark at a discharger and is sure of always obtaining the same difference of potential at the ends of the Geissler tube.

The highest temperature to which one can submit a gas is presumably that of the electric discharge from a condenser; opinions differ in regard to the degree of heat which one can obtain by such a discharge. The limit I have reached is the volatilization of silica, — perhaps 1800 degrees. At this temperature the spectrum shown by all gases in narrow capillary tubes consists of a continuous spectrum crossed by broad bands due to silica or to an oxide of silica; the gaseous spectra are completely masked. This masking seems to be due to the greater conductivity of the volatilization products from the walls of the tubes and from the metallic terminals. It seems to me



that this variation in conductivity is sufficient to account for the phenomena of masking without recourse to a theory of electrons which provides for suitable damping of electrical oscillations. The electron theory may be an ultimate explanation, however, of electrical conduction.

I speedily found that the limit of resistance of glass tubes enclosing rarefied gases was low, and that it was impossible to utilize to its full extent the amount of energy which was at my command. Geissler tubes filled with oxygen, hydrogen, and nitrogen all gave the same spectrum when sufficiently strong discharges were passed through the tubes. This is also the case with quartz tubes. It seems to be impossible to so exhaust tubes and cleanse them to such a degree that high electromotive force and strong heating effect will not drive off occluded gases or closely adhering layers of gases. It is not impossible, moreover, even if the surface layer of adhering gas is removed, that it is replaced by gases coming from the interior of the glass. It is well known that glass holds water vapor in its mass, and quartz permits the passage of hydrogen when the quartz is incandescent.

On account of the difficulty of leading platinum wires, air tight, into quartz vessels, the ends of the quartz tubes which had been blown out into bulbs were carefully ground and were luted to glass bulbs by means of silicate of soda. The electrodes were led into the quartz bulbs as far as possible to avoid the volatilization of the silicate of soda; or at least to prevent the result of this volatilization from reaching the capillary. One of the most striking facts which the investigator in spectrum analysis meets in the study of electric discharges through exhausted tubes is the difficulty of getting rid of impurities which arise from the methods of exhaustion. The mercury used in the process of exhaustion provides mercury vapor, — which, however, is the least source of trouble, for it can be frozen out by liquid air. A more serious trouble arises from the lubrication of the valves of the pump. This lubrication is a large source of carbon monoxide, traces of which are rarely absent if strong discharges are employed. Moreover, the substances used by chemists to dry gases are an unfailing source of impurities, which are revealed by the astonishing delicacy of spectrum analysis.

The student who endeavors to obtain a spectrum of hydrogen with strong discharges is apt to become sceptical of conclusions based upon this delicate method of analysis, for he must confine his study to comparatively weak excitation of the rarefied hydrogen. The moment he employs a powerful discharge all trace of hydrogen disappears, and he must conclude that there is some phenomenon of occlusion of chemical combination or masking. What astonishes one most, perhaps, is the



occurrence of what is ordinarily called the four-line spectrum of hydrogen when an exhausted tube is filled with water vapor. The readiness with which this four-line spectrum can be obtained in water vapor, and the comparative difficulty of obtaining it in dry rarefied hydrogen with powerful discharges, leads to much reflection. Is it not possible that the common occurrence of this spectrum of hydrogen among the stars, and especially in the atmosphere of the sun, is an evidence of the prevalence of water vapor and consequently of oxygen?

The following experiment is of interest in this connection. The object of the experiment was to determine whether the mass law of physical chemistry applies to a mixture of hydrogen and oxygen.

An end-on Geissler tube T was connected to a mercury pump which was provided with a McCleod gauge, and also with a tube of ignition tubing in which oxygen could

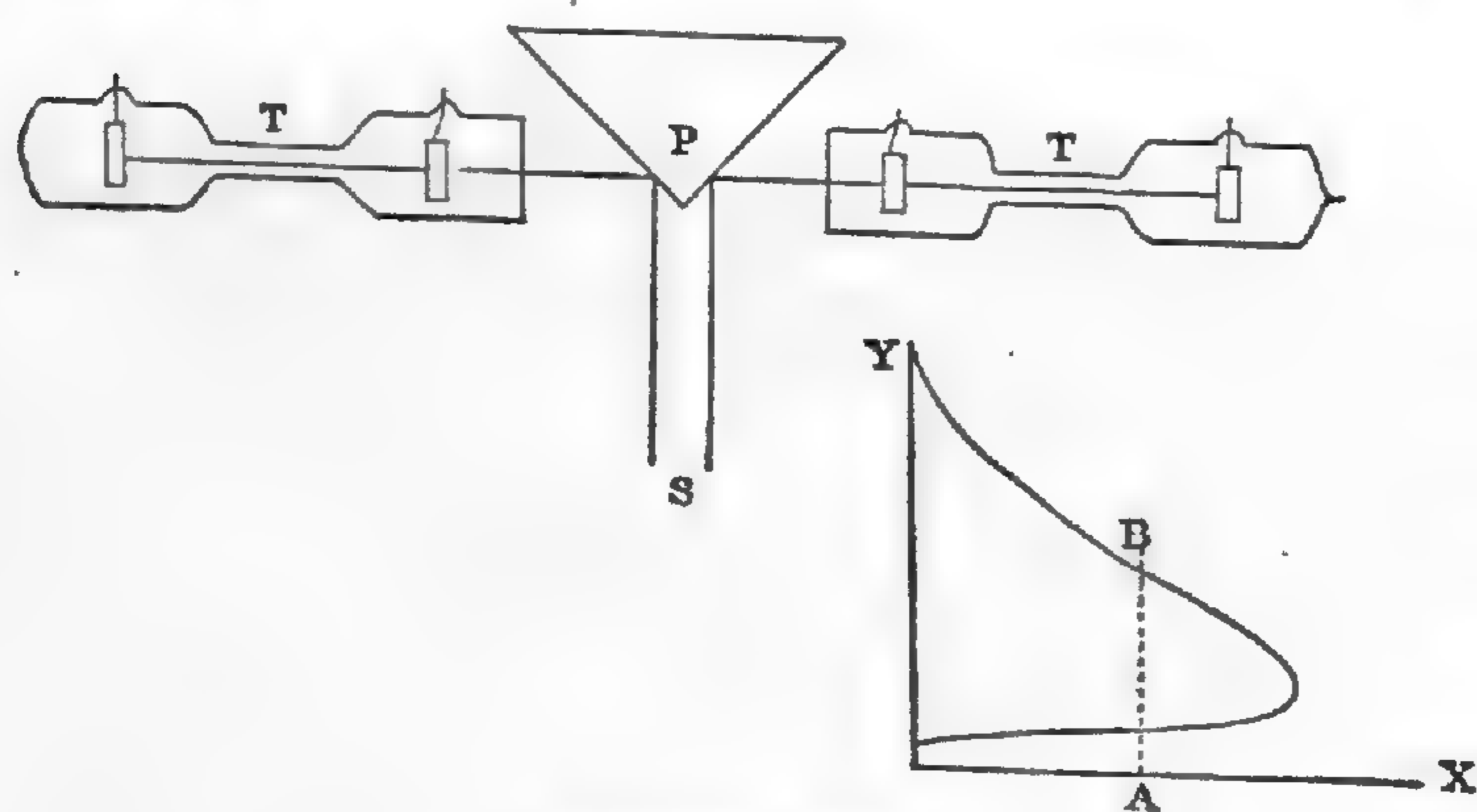

FIGURE B.

be generated by heating the enclosed peroxide. Close to the Geissler tube was a bulb filled with distilled water. By opening a valve the Geissler tube could be filled with steam from the heated bulb, or with water vapor at a lower temperature than steam. Another end-on tube filled with hydrogen at a definite pressure was separated from the pump and served as a comparison tube.

The same current from the storage battery was led through both the tube connected to the pump and this comparison tube. A prism provided with silvered mirrors on its sides received the light from the two end-on tubes and a straight vision spectroscope gave a spectrum line from each tube side by side. I selected the red line of hydrogen for comparison, and moved the end-on tube which was not connected to the pump to and fro until the lines seen in the spectroscope appeared to be of equal brilliancy. This method of observation seemed to be sufficiently exact for the purpose of the experiment. At one time a spectrophotometer consisting of the well-known arrangement of two nicol prisms in connection with a straight vision spectroscope, was tried; but it was not found necessary to proceed to the degree of refinement offered by such an instrument.

The tube containing water vapor was exhausted to a certain pressure, and the separated tube was adjusted until the brilliancy of the red lines in the two tubes appeared to be equal under the same current; then varying amounts of oxygen were admitted to the tube connected to the pump, and the brilliancy again compared after



the tube in each case had been exhausted to the same degree. It was speedily seen that a great excess of oxygen did not result in dimming or decreasing the brilliancy of the red line of hydrogen. On the contrary, up to a certain point the addition of an excess of oxygen increased the brilliancy of the hydrogen line. The mass law of physical chemistry, therefore, does not seem to apply in the spectrum analysis of water vapor and oxygen. If one plots the intensity of the hydrogen red line as an abscissa and the pressure of the exhausted tube as an ordinate, one can represent the changes in intensity of the line by a curve. The intensity increases as the exhaustion proceeds, until, the current being kept constant, when a certain pressure is reached the brilliancy of the red line in the tube connected to the pump begins to diminish. The curve representing the run of intensity has a point of inflexion and returns to the axis of Y; thus between the origin and this point of inflexion there are two values of pressure giving the same intensity. The hydrogen line diminishes in intensity as the amount of water vapor diminishes, the strength of exciting current remaining constant.

This experiment illustrates the fact that oxygen can be present with an excess of water vapor and yet does not manifest itself spectroscopically. One should not, therefore, conclude from the absence of oxygen lines in the solar protuberances and in the hydrogen types of stars that oxygen is not present. It is maintained by some that hydrogen in such a mixture and water vapor and oxygen carries the current, and that the oxygen, on account of its resistance, does not participate in this electrical action. However this may be, we still cannot conclude from the absence of oxygen lines in the spectrum of the solar protuberance that oxygen is not present.

#### REVERSALS OF METALLIC LINES.

The discharge of powerful condenser sparks between metallic terminals 1 cm. apart, in glass or quartz tubes of 1.2 mm. diameter, filled with rarefied gases, affords interesting spectra. In general, the strongest lines of the metals employed as terminals are reversed. These reversals (dark lines on the positives) coincide in position with that of the same lines in air, while the general broadening of the line is toward the red. This fact is clearly seen in the spectrum of the line of silicon wave length 2881 (Figure 9, Plate XXVII). Thus we have the effect noticed in the spectrum of certain variable stars, — a line dark on one side and bright on the other. A slight reversal, not sharply evident, might lead one to conclude that there had been a shift on the whole of the line in question toward the red. A changing thickness, or



density of vapor, together with a Doppler effect, might be important elements in producing small displacements.

It is only when the metallic terminals are close together — three to four centimeters or less — that these phenomena are observed. Indeed, even with sparks of six feet in length in air, thus indicating a very high electromotive force, no spectroscopic evidence of the metals of the spark terminals can be obtained at a distance of three inches from such terminals. The particles of the metals are apparently too heavy to be projected to any considerable distance, and the spectrum obtained is that of heated air.

In the study of displacements seen in comparison of spark and arc spectra, the phenomenon I have observed may have importance; for, by changes in position of the metallic electrodes and change in pressure of the rarefied gas, one can vary the conditions over a wider range than when the study is made in atmospheric air at atmospheric pressure. It is evident that when the terminals are within 1 cm. apart, powerful condenser discharges approach the condition of the voltaic arc. The pressure produced by powerful condenser discharges in capillary tubes is perhaps an element in producing the broadening of the lines toward the red.

In Professor J. J. Thomson's "Conduction of Electricity through Gases," 1906, p. 516, the subject of pressure in the spark is considered from the point of view of the kinetic energy given to the ions, and the author calculates that this energy of a spark 1 cm. long in air at atmospheric pressure, from a condenser of 1000 cm. capacity charged to 30,000 volts, if distributed throughout 1 c.c. of gas, would increase the pressure by 6.6 atmospheres. When confined to the very much smaller volume traversed by the spark, the pressure would rise to enormous values. To take  $\frac{1}{100}$  of 1 c.c. as the volume of gas traversed by the gas, which would be a large overestimate, the initial pressure along the path of the spark would be 660 atmospheres.

When terminals of different metals are employed in capillary tubes of glass or quartz, and are separated four or five millimeters, complicated phenomena result from powerful condenser discharges through the rarefied gases contained in these tubes.

All specimens of glass which I have tried — soft German glass, lead glass, Borsilicon glass, or Jena glass — give broad bands due to silica; lead glass gives, in addition, lead lines. Jena glass gives a very strong line of boron at wave-length, 3451.49. These lines and bands are obscured by a continuous spectrum.

The narrow capillaries with metallic terminals which I have used may be called electric furnaces, in which there is no permanent product or permanent decomposition; moreover, the spectra which we observe do not reveal all that the capillaries



contain. Hydrogen may be present, but it is concealed. Oxygen shows its presence only by probable oxides; the constituents of rarefied air are undoubtedly always there. The conditions which prevail in the case of discharges in such narrow capillaries seem to be analogous to those in the case of discharges under liquids. In this latter case we also have reversals of metallic lines; and, moreover, certain characteristic lines of metals are wanting. See "Spectra from the Wehnelt Interrupter," Harry W. Morse, Proceedings American Academy of Sciences, May, 1904.

These results make one doubtful in regard to the entire subject of spark spectra which are observed between metallic terminals in ordinary air; and we are forced to ask, what influence does the environment have upon the character of these spectra, — to what must we attribute the absence of oxygen lines? And even if we take spark spectra between metallic terminals in an atmosphere of hydrogen or nitrogen, we are not sure that the results are not modified by the gases which are occluded in the metallic terminals.

Are we sure that, even in electrodeless tubes, helium is a product of disintegration of radium, a transmutation, so to speak, and is not a result of the electrical stimulus in the environment of glass or quartz, — a stimulus which may bring to light the helium which has refused to manifest itself by chemical analysis?

In general it may be said that the conductivity of the volatilization products, either from the walls of the tubes or from the metallic terminals, determine the occurrence of the spectral lines or bands. The spectrum, for instance, of silica completely masks the spectrum of the iron terminals when the latter are placed not more than five millimeters apart. When the terminals are of different metals, the spectrum of the more volatilizable metal predominates; or, more strictly, the spectrum of the better conducting vapor.

Another striking fact brought to light by such discharges in capillaries is the reversal of many of the spectral lines on broad bands. The broadening of the lines of the metals is generally toward the red end of the spectrum. The quantity of the discharge appears to be the important factor in determining the character of the spectra; electromotive force, *per se*, does not give new lines which can be detected by photography. The effect of high electromotive force begins to be evident at high exhaustions, and then only in producing cathode and X rays.

This latter fact can be well shown by a Tesla coil, actuated by a Cooper-Hewitt mercury interrupter, such as was employed by Dr. G. W. Pierce, Proc. Amer. Acad., 1904. With a suitable step-up transformer, in connection with such an interrupter, I have studied the spectrum of hydrogen, and have not obtained a spectrum which



differed from the one obtained by the same amount of energy with lower voltage. The high voltage ranged from 100,000 volts to 3,000,000.

The broadening of metallic lines seems to indicate an oxidization. One can conceive of a loading of the metallic molecule by various degrees of oxidization which leads to a broadening toward the red end of the spectrum; or, in other words, to longer wave-lengths, and an unloading due to dissociation, which leaves the molecule free to emit shorter wave-lengths. That an oxidization results from a discharge of electricity in glass or quartz tubes, filled even with apparently pure hydrogen, seems to me to be evident from my experiments. The unavoidable presence of water-vapor in glass and, I may add, in quartz tubes, lends color to the oxidization theory; this vapor is dissociated by the electric current, the oxygen set free combines with the molecules of the metals, or with the molecules of silica and its metallic impurities.

The following experiment illustrates this oxidization. A Geissler tube (Figure *C*), with an internal diameter of one inch, was provided with an inner capillary, one end

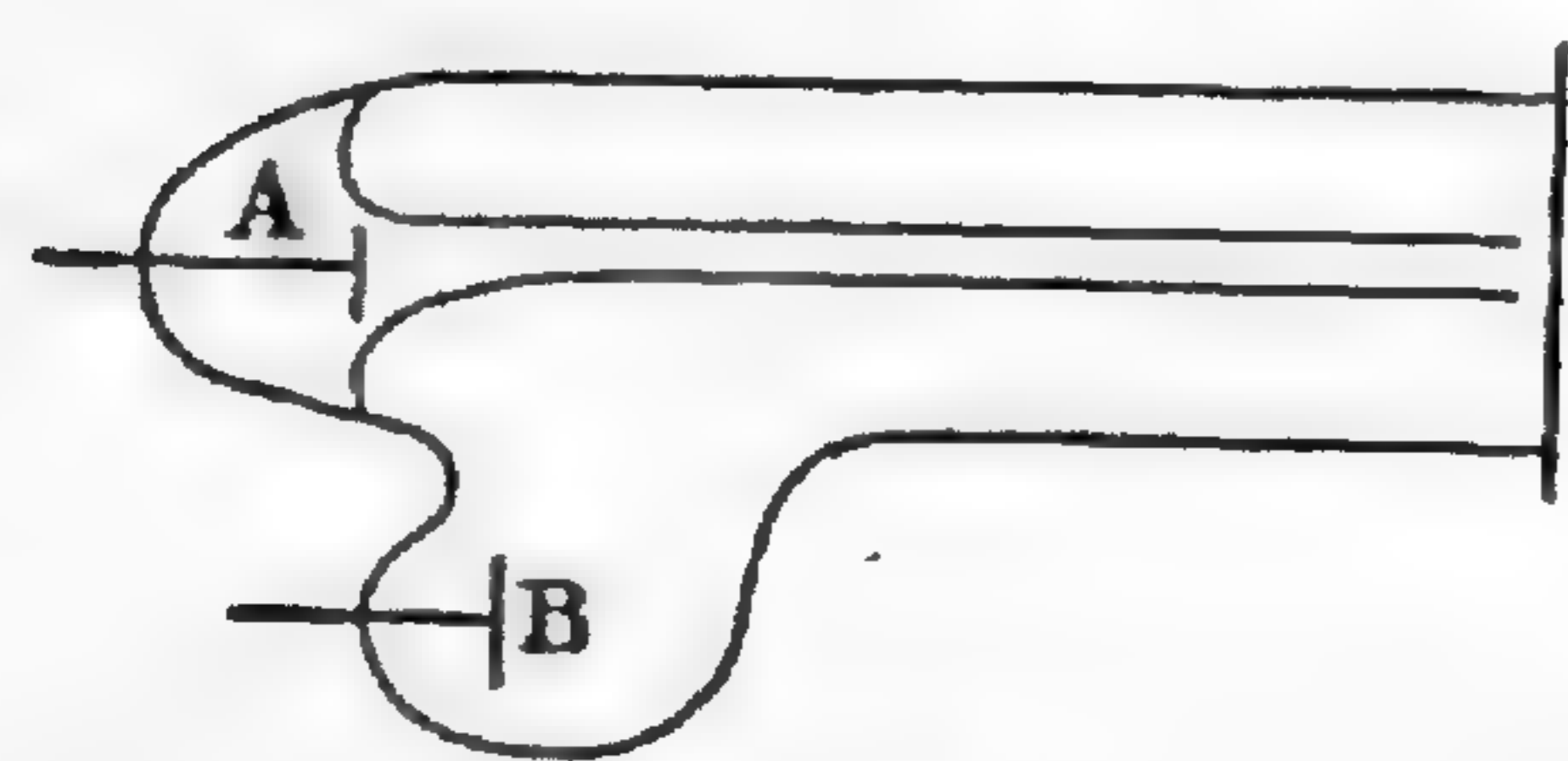

FIGURE *C*.

of which was blown to the walls of the larger tube; the other end was free inside this larger tube. An electric discharge passed between two ring electrodes A and B, which were placed in the larger tube. The discharge therefore started, so to speak, in the larger tube, passed through the narrow channel of the capillary, and emerged to the cathode. The tube was filled with pure hydrogen, dried by phosphoric pentoxide. Under the effect of powerful condenser discharges, the four-line spectrum was much enfeebled in the capillary; the red color, characteristic of condenser discharges in hydrogen, gave place to a brilliant white light, and when the capillary was viewed end on, a continuous spectrum was seen. When, however, the discharge issued from the capillary, a brilliant aureole was seen around the end of the capillary; this aureole gave a much enhanced four-line spectrum. The temperature inside the capillary was sufficient to volatilize the walls of the capillary, and therefore was competent to decompose the water-vapor into oxygen and hydrogen. Just outside the capillary the temperature fell to the point of recombination of these gases to water-vapor, and the enhancing of the red hydrogen line which is always observed in water-vapor.

In another experiment the Geissler tube (*G*, Figure *D*) was placed between two manometer gauges, and was exhausted to such a degree that the electric discharge failed to pass. One end of the Geissler tube, that nearest to the pump, was shut off



by means of a stop-cock B; and dry oxygen was admitted to the pump until the manometer gauge connected with the pump indicated two centimeters pressure. The stop-cock was then opened so as to admit the gas to the Geissler tube. The corresponding manometer gauge at the opposite end of the Geissler failed to register the requisite equalization of pressure, there having arisen an oxidization of the mercury meniscus by means of which the capillary constant between it and the glass had been changed. This holding of the mercury meniscus was large and had to be overcome

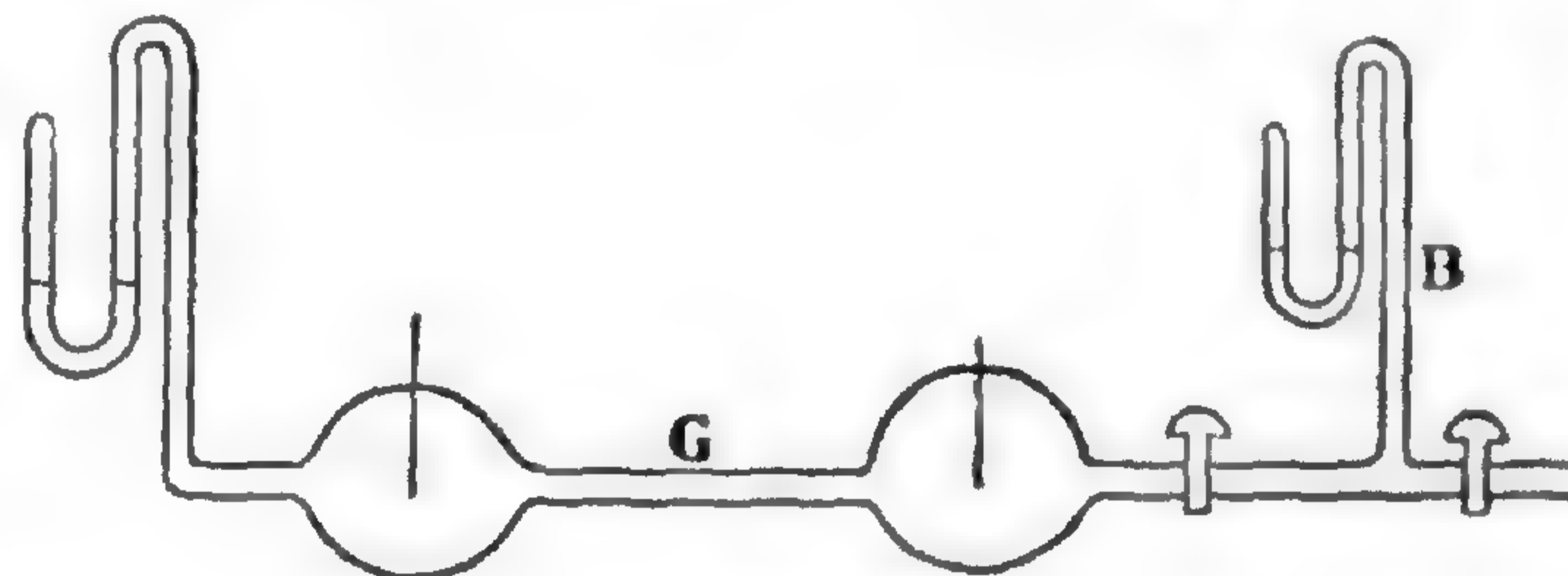

FIGURE D.

by vigorous tapping of the tube. An analogous effect was obtained when the Geissler tube was filled with rarefied air, and also when it was filled with nitrogen. When, however, it was filled with dry hydrogen, the holding effect was comparatively inappreciable. The oxygen produced by the dissociative effect of the electric discharge combined with the hydrogen and no longer oxidized the surface of the mercury. In this connection it may be observed that the mercury meniscus in the Lippman electrometer is affected principally when it is made the positive pole, and therefore oxygen is liberated.

Perhaps the most striking experiment in this connection can be made with the steady current from a large storage battery. When Geissler tubes, preferably of half a centimeter internal diameter, are provided with copper terminals, and are filled with dry hydrogen at pressures of one millimeter to one-tenth of a millimeter, a steady diminution in the pressure of the gas results from the application of the discharge; the light of the spectrum grows dimmer and dimmer, then the cathode rays appear, finally the X rays, and then no discharge can be forced through the tube until a much higher electromotive force is employed, or heat is applied to the tube. This heat evidently drives off water-vapor from the walls of the tube together with air; a fresh application of the steady current again diminishes the pressure in the tube to an apparent vacuum. Thus one can exhaust, so to speak, a Geissler tube by employing a steady current of electricity to dissociate the ever present water-vapor. With copper electrodes, the oxidization produced by this dissociation is more evident than with other metals; although I have observed it with magnesium terminals, with iron terminals, and with other metals.

These experiments lead me to believe that, just as in chemical reactions, a certain amount of water-vapor or humidity is essential to conduction in gases whether brought about by what is called chemical affinity or electrolytic action.



I have dwelt upon the broadening of the lines of metals in capillary tubes. This phenomenon is also observed with hydrogen lines, and was first noticed by Liveing and Dewar, *Chem. News*, XLVII, p. 122, 1883. These authors attributed the broadening to compression of the gas in the narrow capillary under the effect of a powerful condenser discharge. Their method of experiment was as follows: The tube was exhausted only to perhaps five or six centimeters pressure, so that a white discharge of a spark nature passed through the capillary and then spread out to electrodes placed in the large ends of the tube. When the tube was viewed end-on, a continuous spectrum was seen in the capillary; moreover, this continuous spectrum was crossed by a dark line which resulted from the absorption of heat in the colder layers of gas in the larger portions of the tube.

The broadening of the spectra of the vapors of metals which I have observed in capillary tubes has thus its analogy in the case of gaseous spectra.

Having obtained reversals of the spectra of metallic vapors under new conditions, I was naturally interested in the experiment of Liveing and Dewar, especially since a controversy had arisen between M. Cantor and E. Pringsheim in regard to the possibility of the reversal of gaseous lines in Geissler tubes. M. Cantor<sup>1</sup> concluded from his experiments that such reversals do not occur in the phenomena of luminescence, such as one obtains by the discharges of electricity in Geissler tubes. Pringsheim objected to these conclusions on the ground that Cantor did not observe a sufficiently narrow portion of the spectrum of the gas and did not use sufficient dispersion. Pringsheim<sup>2</sup> quotes the result of Liveing and Dewar in support of his position.

In repeating Liveing and Dewar's experiment, it occurred to me that objection might be brought against it on the ground that it was a spark discharge and not

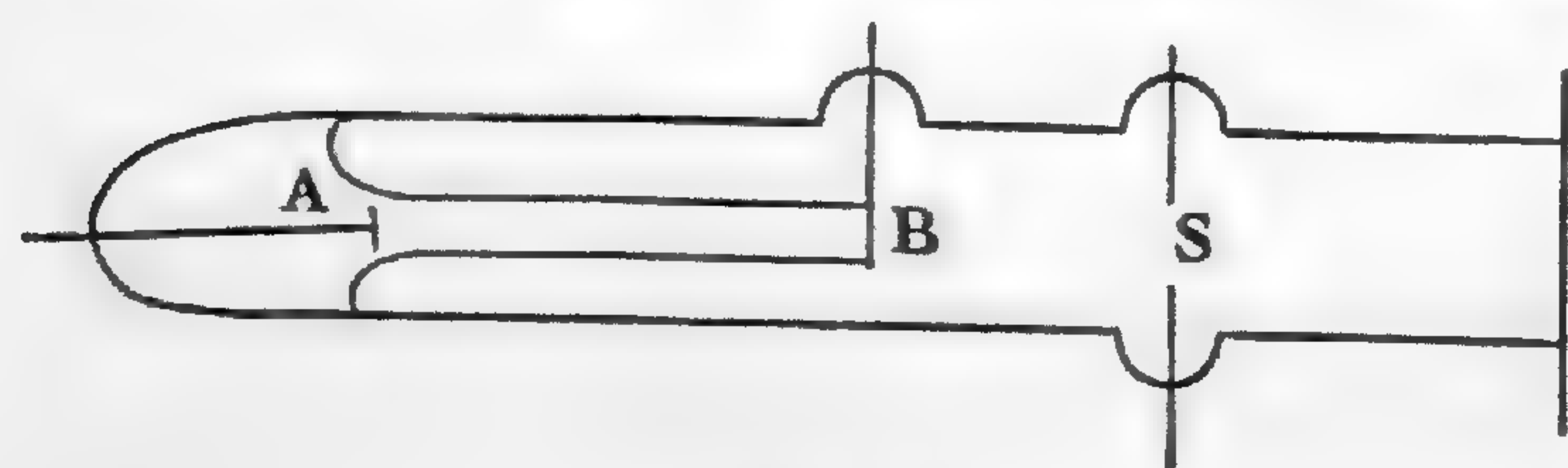

FIGURE E

a clearly marked glow or luminescent discharge such as Cantor evidently had in mind. I therefore placed a second spark gap (S, Figure *E*) just outside the inner capillary of the large Geissler tube provided with an inner capillary, as I have

previously described in speaking of the temperature inside a capillary, and in the space just outside. The discharge passed first through the capillary, and then by means of an outside connection through the second spark gap; thus the light from the capillary passed through the light from the second spark gap. In both cases

<sup>1</sup> *Ann. der Phys.*, n. 3, 1900, p. 462.

<sup>2</sup> *Ann. der Phys.*, n. 5, 1900.



the light was a glow or luminescence and not a white spark discharge, the pressure in the tube being from one to two centimeters.

A Rowland grating was employed, and an eyepiece was fixed on the C line of hydrogen. The second spark gap gave a fine bright line of the apparent length of the slit, the capillary a continuous spectrum, and where the fine bright line crossed this continuous spectrum, it was reversed.

Kirchhoff's law of radiation thus applies to the radiation in Geissler tubes, and Pringsheim's contention is justified. If the solar corona is an electrical phenomenon of the nature of luminescence it can exhibit either bright lines or dark lines according as it is hotter or colder than the background.

In this study of the upper limit of temperature which one can reach by electric discharges through rarefied gases, we perceive that spectrum analysis is one of the most difficult analyses which modern science has revealed. There are a few broad facts, such as Doppler's principle and the reversal of spectral lines according to Kirchhoff's law; on the other hand there is ionization, dissociation, adsorption, and absorption, all modified by the glass or quartz vessels which must be employed.

M. Cantor calls attention to the fact that Hittorf failed also to observe reversals of spectral lines in the case of electric discharges in Geissler tubes. Hittorf speaks of a first series of hydrogen lines which are seen with feeble discharges. This feeble spectrum with its bands seems to be a peculiarly luminescent effect in which any translatory or colliding effect of the molecules is a minimum. The new theories in regard to the composite nature of the atom seem to demand an extension of our views in regard to the nature of the light emitted by atoms and their aggregates under the stimulus of an electric discharge. The phosphorescent and fluorescent light of a gas under this stimulus may arise from the mechanism of the atom, and therefore may not give sensible heat. The combination of atoms into molecules, and their dissociation and formation of new combinations, may give the spectra we usually observe under the effect of fairly strong electric discharges, and provide the sensible heat which can be measured by the bolometer or the thermal junction.

Spectrum analysis of the future thus becomes more and more difficult of application, and one of its most important fields is in the study of phosphorescent and fluorescent light emitted by gases. We seem to be on the point of regarding the light and heat of the sun more from the electrical standpoint. And the study of discharges of electricity in rarefied gases assumes a great importance.

My attention was first directed to the phenomenon of reversals in Geissler tubes filled with rarefied gases by the reversal of two lines apparently closely coinciding with



the H and K lines of the solar spectrum. It did not seem possible that these lines could be due to calcium, for I obtained them in quartz tubes.

I have, however, made a more extended examination of the possible origin of these lines from the calcium contained in glass, using quartz tubes, and although I occasionally obtained these lines with quartz tubes, I am now persuaded that these lines are due to calcium; for using the utmost care in luting pure silver terminals into quartz tubes, the luting being at a great distance from the point of discharge, I found difficulty in obtaining the lines, and in the majority both lines did not appear. There was, however, in the case of quartz tubes one line coincident with one of the calcium lines and nearly coincident with the H line of the solar spectrum. It seems evident that in the immediate region of the H and K lines, perhaps superimposed upon them, are gaseous lines. At one time I thought that oxygen might contribute lines to this region, but I am less sure of this from subsequent investigations.

It is evident, I think, that the characteristic spectrum shown in Figure 9, Plate XXVII, is due to silica; for it appears in quartz tubes as well as in glass tubes with very powerful discharges in rarefied oxygen, hydrogen, and nitrogen.

The region, however, in the immediate neighborhood, or included in the broad region of the H and K lines, is a composite one, and must be investigated by a spectroscope of greater dispersion than that I have employed. The one I have used gives a space of approximately 4 mm. between these lines.

Figure 10 shows the change in the spectrum of rarefied air in quartz tubes with increasing strength of discharge; the gaseous lines diminish in number, and the final spectrum is characterized principally by two very broad bands.

The spectra of the discharges in the Geissler tubes were produced by discharges from a large condenser and varied in number from one discharge to six discharges. The discharge number one is close to the solar spectrum (Figure 10, Plate XXVII). The spectrum resulting from six discharges is furthest from the solar spectrum. It is evident from the study of these discharges that certain lines appear with comparatively weak discharges which disappear with stronger discharges.

Figure 9 shows the flashing of a silicon line, 2881, toward the red end of the spectrum. This flaring toward the red can be seen in the case of most strong metallic lines obtained in capillary tubes filled with rarefied air.

#### RESULTS.

1. Hydrogen lines do not increase in number with the most powerful electric discharges which glass or quartz can withstand.



I have not been able to produce the new series of hydrogen lines discovered by Professor E. C. Pickering in the spectrum of certain stars.

2. The limit of strength of current and electromotive force that one can employ in the study of gaseous spectra of rarefied gases is far below the safety limit of the glass or quartz tube which is employed, for the containing vessel contributes many impurities which come into strong evidence with powerful discharges; moreover, the resulting continuous spectrum completely masks the line spectrum.

3. It seems probable that many of the lines in gaseous spectra are composite lines, especially those which are seen with condenser discharges. The so-called four-line spectrum of hydrogen is enhanced by the presence of water-vapor.

4. A characteristic spectrum common to rarefied oxygen, hydrogen, and nitrogen, is obtained in glass tubes and quartz tubes when the limit of safety of the tubes is approached. (Fig. 11, Plate XXVII.)

5. The red line of hydrogen, 6562.10, can be reversed in a tube filled with rarefied hydrogen.

6. In general it is difficult to determine whether one has succeeded in reversing gaseous lines in the case of powerful discharges through rarefied gases on account of the continuous spectrum which occurs.

7. Metallic spectra obtained in capillary tubes filled with rarefied air are characterized by a reversal of most of the strong lines, with a pronounced broadening or flare toward the red end of the spectrum. This phenomenon occurs with powerful condenser discharges.

8. Powerful electric discharges in air resulting from the discharge of many condensers in series exhibit at each fork or angle of the discharge brush discharges characteristic of the positive pole; and also an explosive effect.

9. Beyond 3,000,000 volts the leakage and inductive effects inside a building prevent even approximate measurements of relation of length of discharge to voltage.

10. The new construction of the large storage battery described in this memoir will, I believe, greatly add to its life and usefulness; for the battery can be short-circuited without fear of injury. The lead plates in the first form of battery were renewed once in twelve years. A battery of 20,000 cells forms a unique installation for a physical laboratory, and contains the promise of great usefulness, especially in cases where uniform and steady electric fields are necessary.



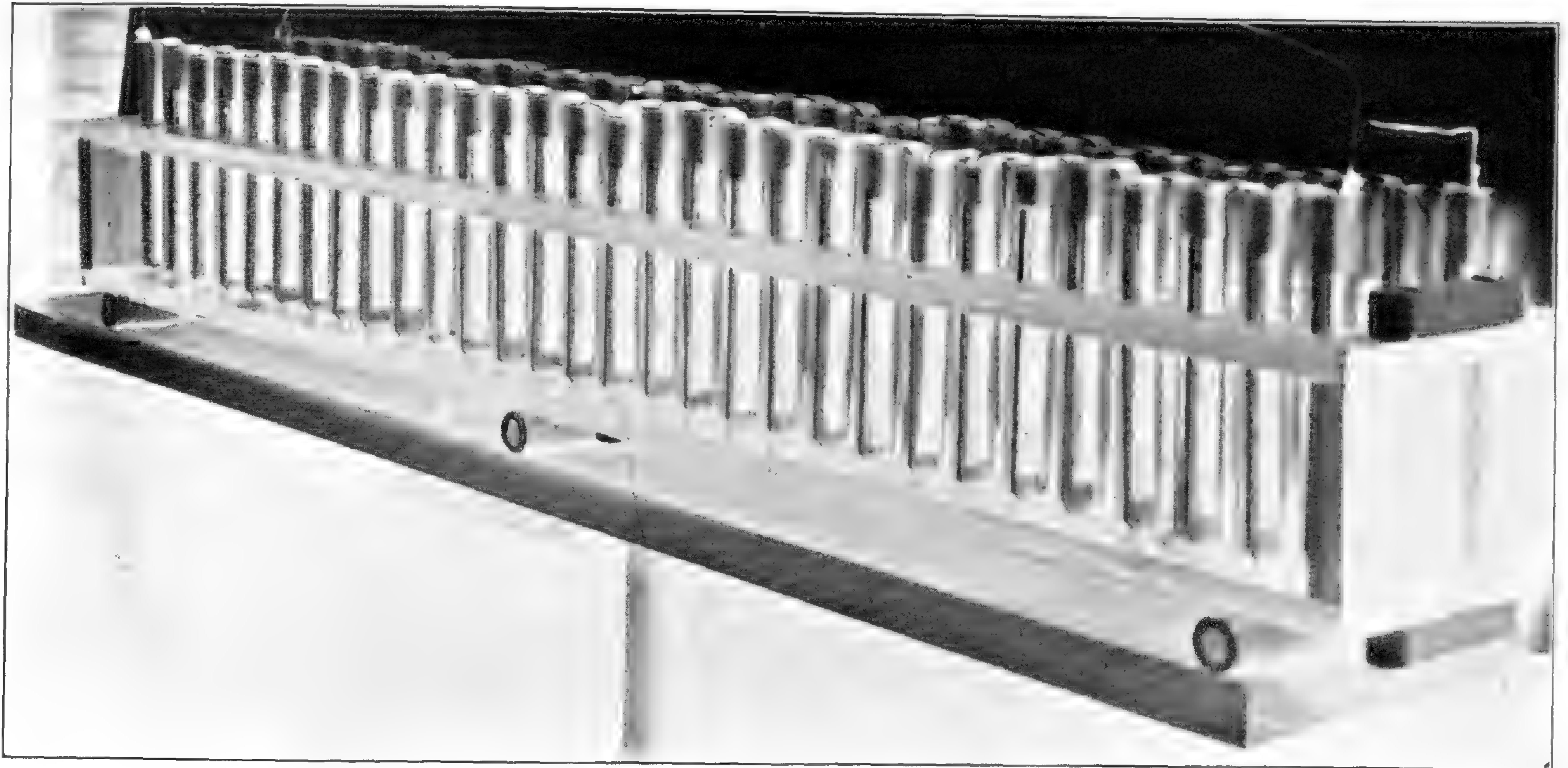

FIG. 1

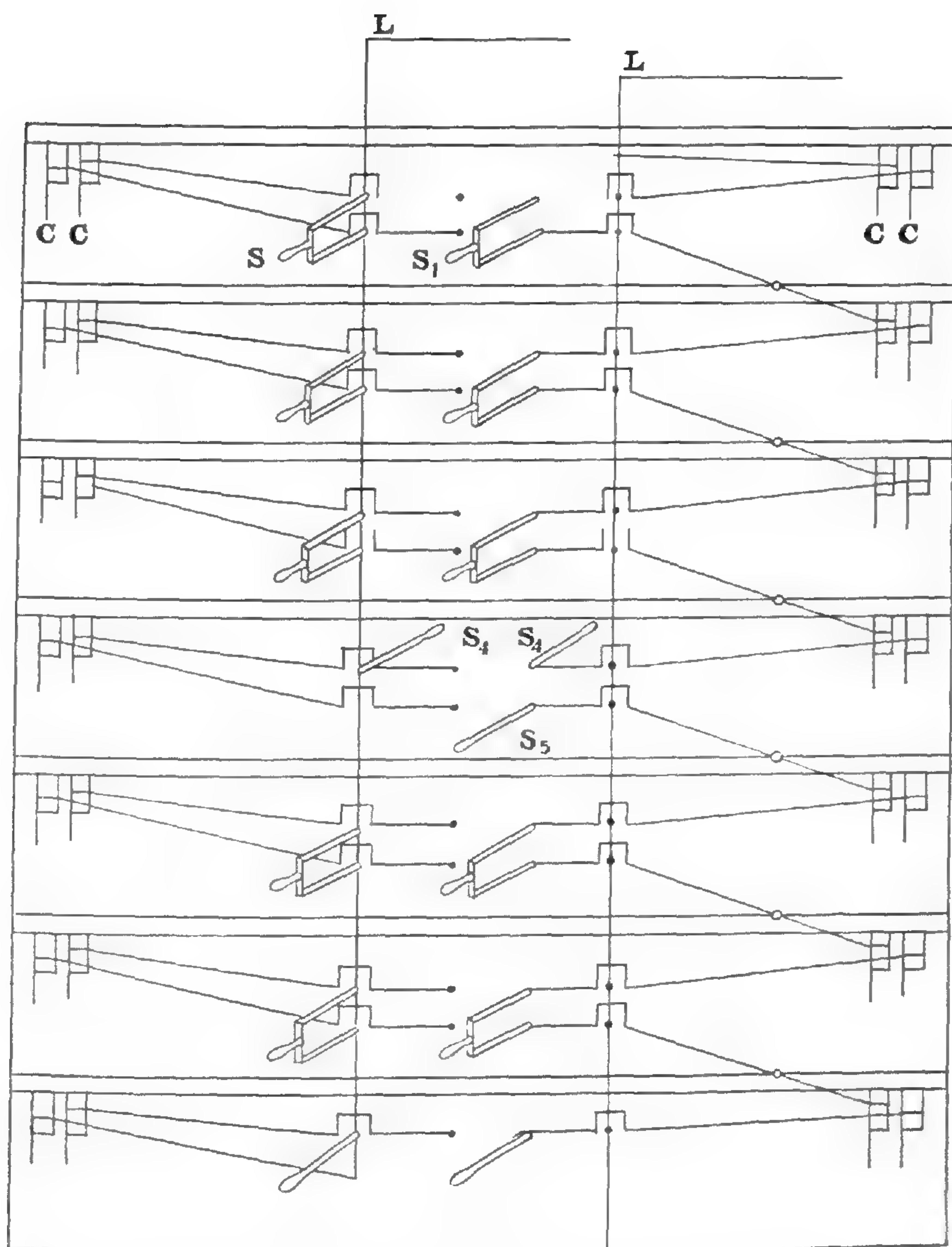

FIG. 2



FIG. 3





FIG. 4



FIG. 7

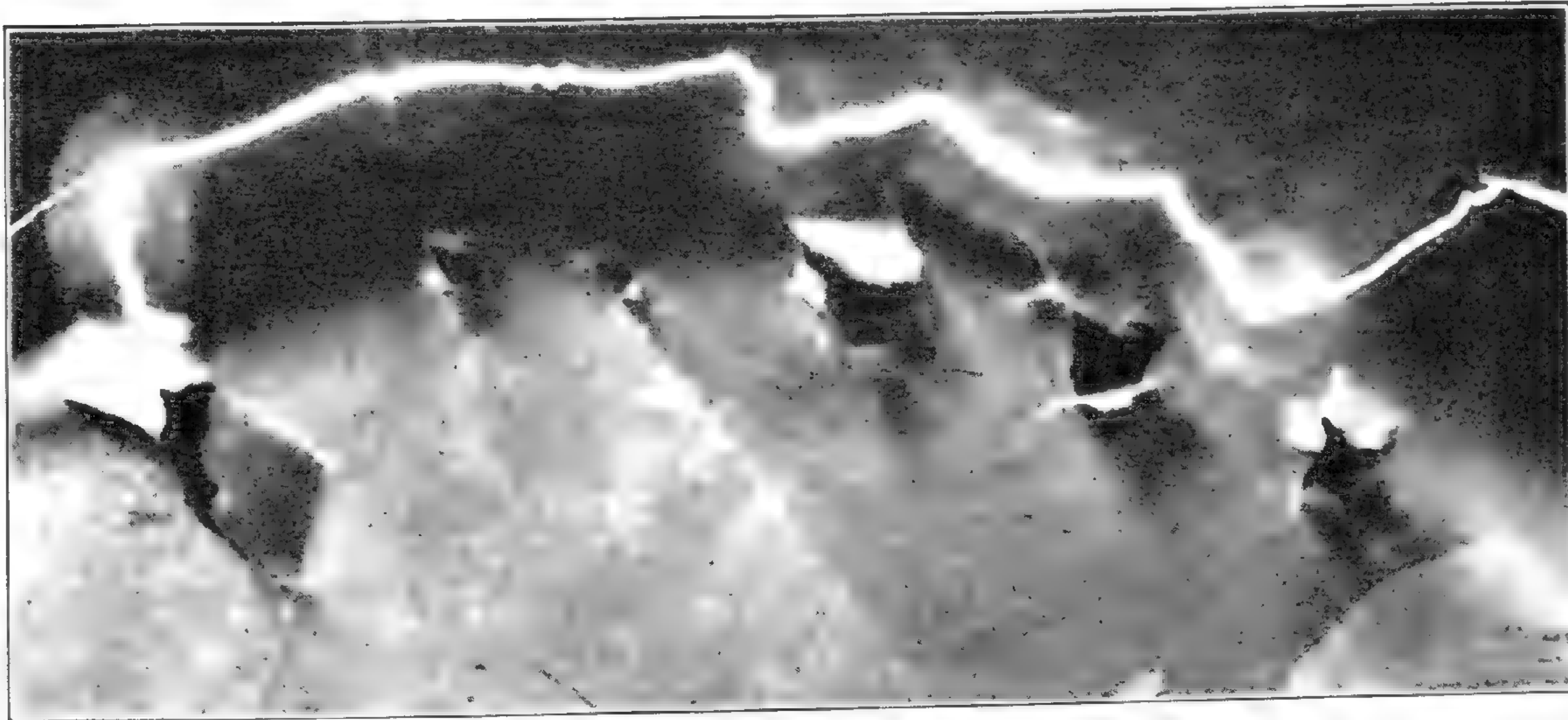

FIG. 5



TROWBRIDGE.—HIGH ELECTROMOTIVE FORCE

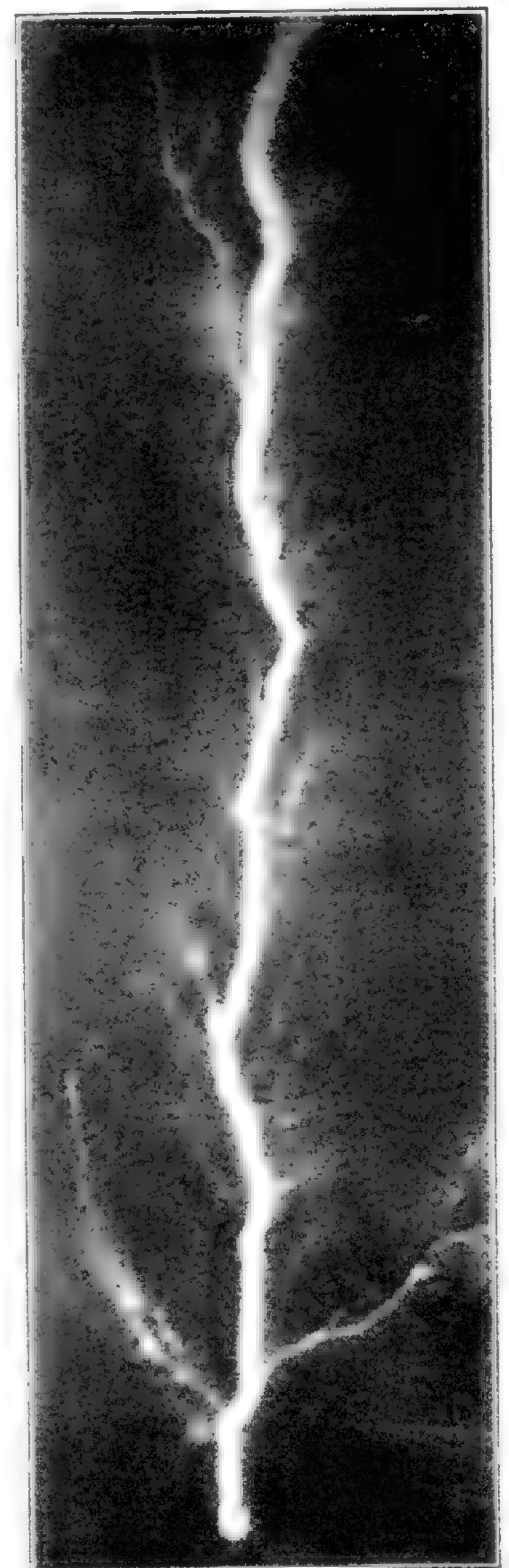

FIG. 6



MAGNESIUM

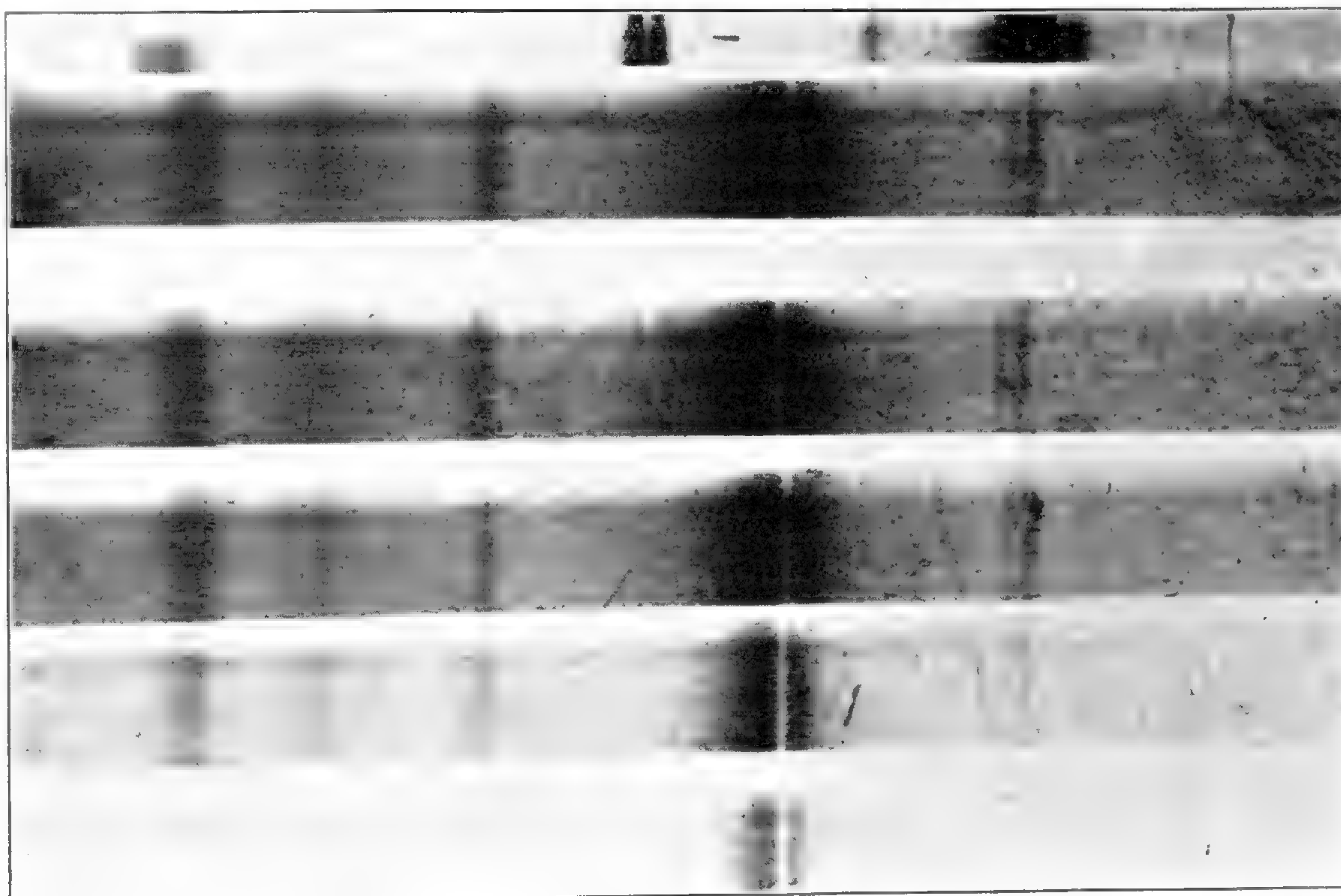

FIG. 9 (NEGATIVE)

SOLAR

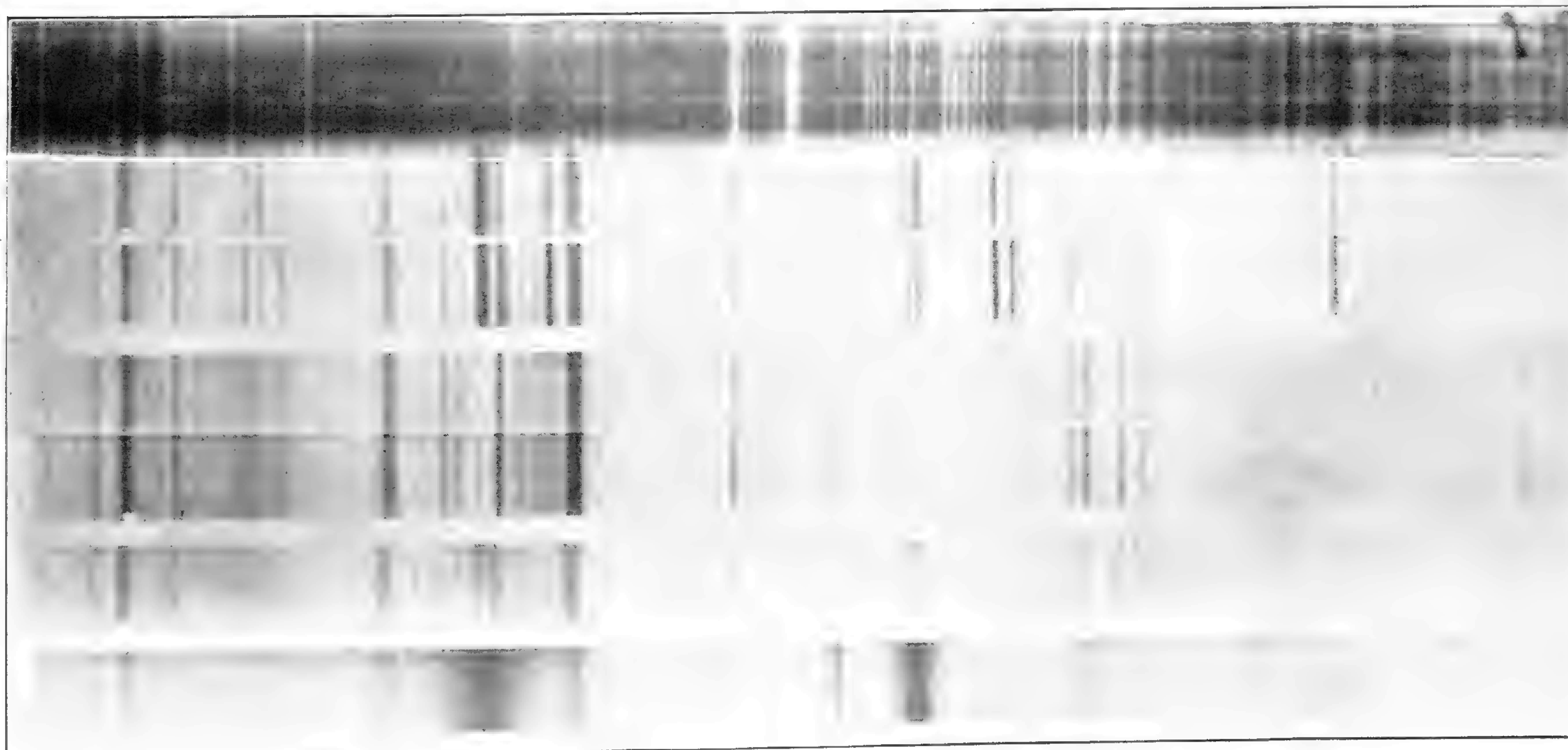

FIG. 10 (NEGATIVE)

CALCIUM

SOLAR

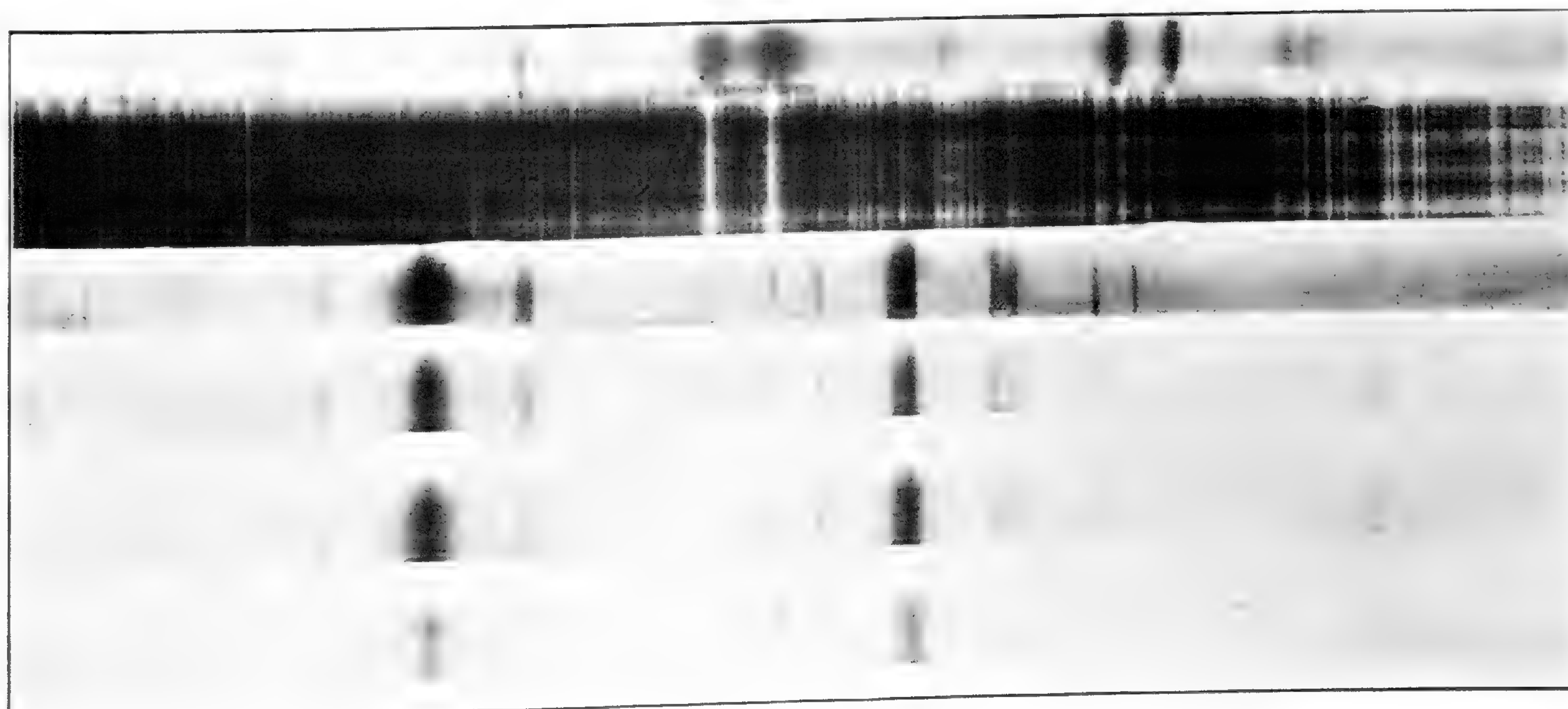

FIG. 11 (NEGATIVE)  
TROWBRIDGE.—HIGH ELECTROMOTIVE FORCE



**PUBLICATIONS**  
OF THE  
**AMERICAN ACADEMY OF ARTS AND SCIENCES.**

MEMOIRS. OLD SERIES, Vols. 1-4; NEW SERIES, Vols. 1-12.  
16 volumes, \$10 each. Half volumes, \$5 each. Discount to  
booksellers 25%; to members 50%, or for whole sets 60%.

- Vol. 11.** PART 1. Centennial Celebration. 1880. pp. 1-104. 1882. \$2.00.  
PART 2. No. 1. Agassiz, A. — The Tortugas and Florida Reefs. pp. 105-134.  
12 pls. June, 1885. (Author's copies, June, 1883.) \$3.00.  
PART 3. Nos. 2-3. Searle, A. — The Apparent Position of the Zodiacal Light.  
pp. 135-157 and Chandler, S. C. — On the Square Bar Micrometer. pp. 158-178.  
October, 1885. \$1.00.  
PART 4. No. 4. Pickering, E. C. — Stellar Photography. pp. 179-226. 2 pls.  
March, 1886. \$1.00.  
PART 4. No. 5. Rogers, W. A., and Winlock, Anna. — A Catalogue of 130 Polar  
Stars for the Epoch of 1875.0, resulting from the available Observations made  
between 1860 and 1885, and reduced to the System of the Catalogue of Publi-  
cation XIV of the Astronomische Gesellschaft. pp. 227-300 June, 1886. 75c.  
PART 5. No. 6. Langley, S. P., Young, C. A., and Pickering, E. C. — Pritchard's  
Wedge Photometer. pp. 301-324. November, 1886. 25c.  
PART 6. No. 7. Wyman, M. — Memoir of Daniel Treadwell. pp. 325-523.  
October, 1887. \$2.00.

- Vol. 12.** 1. Sawyer, E. F. — Catalogue of the Magnitudes of Southern Stars  
from 0° to -30° Declination, to the Magnitude 7.0 inclusive. pp. 1-100. May,  
1892. \$1.50.  
2. Rowland, H. A. — On a Table of Standard Wave Lengths of the Spectral  
Lines. pp. 101-186. December, 1896. \$2.00.  
3. Thaxter, R. — Contribution towards a Monograph of the Laboulbeniaceæ.  
pp. 187-430. 26 pls. December, 1896. \$6.00.  
4. Lowell, P. — New Observations of the Planet Mercury. pp. 431-466. 8 pls.  
June, 1898. \$1.25.  
5. Sedgwick, W. T., and Winslow, C. E. A. — (I.) Experiments on the Effect of  
Freezing and other low Temperatures upon the Viability of the Bacillus of  
Typhoid Fever, with Considerations regarding Ice as a Vehicle of Infectious  
Disease. (II.) Statistical Studies on the Seasonal Prevalence of Typhoid  
Fever in various Countries and its Relation to Seasonal Temperature. pp. 467-  
579. 8 pls. August, 1902. \$2.50.

- Vol. 13.** 1. Curtiss, D. R. — Binary Families in a Triply connected Region,  
with Especial Reference to Hypergeometric Families. pp. 1-60. January, 1904.  
\$1.00.  
2. Tonks, O. S. — Brygos: his Characteristics. pp. 61-119. 2 pls. November,  
1904. \$1.50.  
3. Lyman, T. — The Spectrum of Hydrogen in the Region of Extremely Short  
Wave-Length. pp. 121-148. pls. iii-viii. February, 1906. 75c.  
4. Pickering, W. H. — Lunar and Hawaiian Physical Features Compared.  
pp. 149-179. pls. ix-xxiv. November, 1906. \$1.10.  
5. Trowbridge, J. — High Electro-motive Force. pp. 181-215. pls. xxv-xxvii.  
May, 1907. 75c.

PROCEEDINGS. Vols. 1-41, \$5 each. Discount to booksellers  
25%; to members 50%, or for whole sets 60%.

The individual articles may be obtained separately. A price list of recent  
articles is printed on the inside pages of the cover of the Proceedings.

Complete Works of Count Rumford. 4 vols., \$5.00 each.  
Memoir of Sir Benjamin Thompson, Count Rumford, with Notices of  
his Daughter. By George E. Ellis. \$5.00.

Complete sets of the Life and Works of Rumford. 5 vols., \$25.00;  
to members, \$5.00.

For sale at the Library of THE AMERICAN ACADEMY OF ARTS AND  
SCIENCES, 28 Newbury Street, Boston, Massachusetts.



MEMOIRS  
OF  
THE AMERICAN ACADEMY  
OF  
ARTS AND SCIENCES



VOL. XIII.—No. VI.

CAMBRIDGE:  
PRINTED BY  
EDWARD W. WHEELER  
JUNE, 1908.



VI.

CONTRIBUTION TOWARD  
A MONOGRAPH OF THE LABOULBENIACEÆ.  
PART II.

BY  
ROLAND THAXTER.

---

WITH FORTY-FOUR PLATES.

---

PRESENTED APRIL 8, 1908. RECEIVED APRIL 6, 1908.



CONTRIBUTION TOWARD  
A MONOGRAPH OF THE LABOULBENIACEÆ. PART II.<sup>1</sup>

More than ten years have elapsed since the publication in these Memoirs of the writer's first "Contribution toward a Monograph of the Laboulbeniaceæ"<sup>2</sup> and during this period material of the family has accumulated so rapidly and so many novelties have been discovered, that he has been tempted to defer from year to year the publication of an illustrated account of the many new species enumerated in the six preliminary papers that have appeared in the Proceedings of the Academy between 1899 and 1905. An adequate treatment in a single paper of this mass of material has thus become impracticable; and in order to set some limit to the plates it has been necessary in general to illustrate the species by single figures, or at most two figures of adults, without attempting, except in a few instances, adequately to represent the development, or the variations of the forms considered. In many cases one, or even more plates might well have been devoted to the development and variation of a single species, especially in the genus *Laboulbenia*. Every effort has been made, however, to give accurate figures, and it is hoped that they may, in connection with the diagnoses, render the determination of the species comparatively easy. Although it has seemed undesirable to cut the diagnoses, which have all been revised and in many cases rewritten, it has been necessary, in order to reduce as far as possible the expense of publication, to make the preliminary account as brief as possible, and to omit a host index and certain other parts that might well have been included.

For the purpose of gaining a more complete knowledge of exotic forms the writer has twice visited Europe, and has examined portions of the large collections in the British Museum, the Laboratories of Entomology of the Museums of Natural History at Paris and at Berlin, the Hope Collection at Oxford and the Sharp Collection of Staphylinidæ etc., at Cambridge, now in the British Museum. Certain forms have also been obtained from the Museum of Natural History at Florence, and the National Museum at Washington. Material is also due to the courtesy of friends and correspondents who have sent insects for examination, while a considerable number of new forms have been obtained by the writer in New England and in Florida. Nearly three hundred and fifty forms are herewith illustrated, increasing to about five hundred the total number of species and varieties thus far described, which are included in more than fifty genera. Since the completion of the accompanying plates in 1905, considerably more than one hundred additional new species have already accumulated, derived from various sources; but for the most part gathered by the writer in 1905-6 during a journey in temperate South America. It is his expectation to publish figures and descriptions of these new forms with as little delay as possible, and in the meantime he will feel greatly indebted to the kindness of any correspondents who may communicate additional material. He desires in this connection to ex-

<sup>1</sup> This Memoir is numbered IX in the series of "Harvard Botanical Memoirs."

<sup>2</sup> Mem. Am. Acad. Arts and Sci., Vol. XII, No. 3, p. 195-429. Plates 1-26.



press his great obligations to those who have already aided him in this manner, and to Mr. Charles Bullard in particular, who is one of the few persons that has recognized these parasites on their hosts, and to whom we owe the discovery of several of the most interesting genera and species. To Professor H. M. Richards he is indebted for a small lot of beetles from Java on which several interesting forms were found; to Prof. C. V. Piper for certain flies and beetles collected in Washington; to Dr. W. Horn of Berlin for the communication of specimens of *Tetracha* from Ecuador infested by *Laboulbenia variabilis*; to Dr. A. F. Blakeslee for a small collection of insects from Venezuela; to Dr. Dahl of the Berlin Museum for calling his attention to the occurrence of these parasites on the dipterous insects collected by him near New Guinea; to Mr. Samuel Henshaw for the determination of hosts and for many other favors; to Mr. Coquillett for his kindness in determining Diptera; to Dr. David Sharp for the privilege of examining his private collections and for many kindnesses; to Professor Poulton of Oxford and to the gentlemen in charge of the European collections above mentioned, and to the staffs of the several laboratories visited, for similar favors and courtesies. He is also greatly indebted to several other persons whose generous assistance has made the present publication possible.

HARVARD UNIVERSITY, JANUARY, 1908.

---

In the first part of the present series, which the writer hopes to continue by the addition of further numbers, an account was given of the general history, literature, morphology etc. of the Laboulbeniaceæ, or Laboulbeniales, as, in conformity with modern usage, they may be conveniently designated, and to this paper reference should be made for a comprehensive review of the subject. In the present connection it is the purpose of the writer, before proceeding to a systematic consideration of the species and genera herewith illustrated, to give a brief review, only, of the literature which has appeared since 1895, and to make only such comments on the morphology, development, etc. as may seem necessary in view of the new data now available.

References to the Laboulbeniales have, within the last decade, become more frequent in the general literature of Mycology and in botanical texts, than was formerly the case, and in the numerous discussions which have appeared, dealing with the origin of the Ascomycetes and higher fungi, and the vexed question of their sexuality, one finds as a rule, at least a perfunctory reference to them. Papers, however, which advance our knowledge of them in any respect have not been very numerous, as the following list will show.

F. Cavara, *Malpighia*, Vol. XIII, p. 173, 1899, with plate, describes a new genus, *Rickia*, growing on ants in Europe, the single species, *R. Wassmanni*, having been subsequently distributed in Rehm, *Ascomyceten* No. 1451. The species is described at some length and numerous figures are given. This author, misled by the close resemblance which the general appearance of the compound antheridia of *Rickia* bear to those of the ordinary simple type, places the genus in the "Laboulbeniaceæ" as limited in the appended Key to the Genera. In discussing other general matters connected with the group, it is further suggested that these plants are not in reality parasites, but live saprophytically,



that the "foot" is merely a means of attachment, and that the appendages are the true absorbing organs; an opinion to which reference will be made below.

P. Speiser, in connection with his studies of the Nycteribidæ, publishes in the *Berichte d.d. Botan. Gesell.*, Vol. XVIII, p. 498, 1900, a note on the geographical distribution of *Helminthophana* (*Arthrorhynchus*), enumerating the species on which these fungi have been observed, and recognizing but one species in the genus. Further notes concerning this paper may be found under *Arthrorhynchus*.

C. Spegazzini in the *Annales del Museo Nacional de Buenos Aires*, Tomo VIII, p. 79, 1902, gives a description of a species of *Laboulbenia* which he calls *L. Argentinensis*, occurring on "*Brachinus*," further reference to which will be found under *Laboulbenia decipiens* below.

The writer has published a note in *Science*, N. S. XVII, p. 463, 1903, which is a summary of a brief paper on the genus *Herpomyces* read at the meeting of the American Association for the Advancement of Science of the preceding year.

P. Baccarini, in *Appendici al Nuovo Giornale Botanico Italiano*, Vol. XI, p. 225, 1904, describes and figures two new forms on Gamasidæ, one, "*Rhachomyces*" *Berlesiana*, closely related to *Rickia* and *Distichomyces*, and possibly belonging to one of these genera; the other, *Laboulbenia Napoleonis*. The generic characters of these forms are not exactly determinable from the figures and descriptions given.

L. Errera in the *Recueil de l'Institut botanique, Bruxelles*, Tome I, p. 314, 1905, reports the presence of glycogen in the cells of *Stigmatomyces Muscæ*.

J. H. Faull in *Science*, N. S. XXIII, pp. 134 and 152, 1906, publishes a preliminary note on the Ascus and Spore-formation in Laboulbeniaceæ, in which he states that these processes agree in all essentials with those which occur in other typical Ascomycetes.

Lastly six preliminary descriptive papers have been published by the writer in the *Proceedings of this Academy* and were issued in December 1889, April 1900, March and June 1901, June 1902, and July 1905 respectively. Other contributions, if such exist, have not been brought to my attention.

It is needless to remark that so large an addition to the Laboulbeniales as is herewith presented has thrown new light on various points relating to their general morphology and development, and necessitates some modification, for example, in the conceptions of generic types, the absolute distinctions between series, etc. It has not, however, proved necessary to modify essentially the general account previously given, and in the following pages no attempt will be made to review these matters comprehensively, except in so far as they have been modified or elucidated by the additional data now available. It has been found convenient in this review, to adopt the same sequence of topics formerly employed, beginning with the

*Spore Characters.* *Amorphomyces* still remains the only genus in which a simple spore replaces the hyalodidymous form characteristic of all the other genera, and the reference of *A. Floridanus* to its proper place under the new genus *Dioicomyces*, shows that this simple character in the spore is correlated with an absence of any appendage, or sterile cell, connected with the primary receptacle; a condition found in no other instance. The only spore modification of interest that has been observed among the hyalodidymous forms, is found in the last mentioned genus; the spore-septum of which is more or less conspicuously oblique (Plate XLII, figs. 17 and 29) and this genus also, as may be seen by reference to the figures cited, illustrates in a striking fashion, the differentiation which may



be apparent between the male and female spores in dioecious genera. It may be here remarked that the cytological phenomena in this connection, which lead up to the sexual differentiation and pairing in the ascus of these male and female spores, is likely to prove of unusual interest.

*Moschomyces* and *Compsomyces* remain the only genera in which the presence of octosporic asci has been definitely determined. The writer has been unable to satisfy himself, however, that this is not also the condition in *Herpomyces*. If this were actually the case, it would involve the curious phenomenon of absolute sex differentiation in the last mitosis, which would not necessarily occur in a four spored ascus.

In almost all the species the first step in germination consists, after the spore has become attached, or even before, in the formation of the familiar hoof-like organ of attachment and absorption, the foot: an indurated, firmly attached, blackened rim, surrounding a thin membrane which is in direct contact with the surface of the host and through which materials are absorbed into its cavity, the latter being, as a rule, in direct communication with that of the basal cell of the receptacle; although, in some instances at least, it is evidently separated by a septum, Plate XLIX, fig. 16.

The nature of this foot may be somewhat variable. In *Coreomyces*, for example, it may be modified to form a spreading, almost rhizoidal structure, Plate LXXI, fig. 14, of characteristic appearance somewhat similar to that of *Zodiomyces*. The most striking departure from the normal type, however, is seen in a relatively small number of species, and was illustrated in the writer's earlier Monograph (*Moschomyces* and *Rhizomyces*). In these instances the parasite obtains its nourishment directly from the body-cavity of the host by means of a penetrating intrusion. Such intrusions are usually associated with growth on a thin or soft integument. Thus *Moschomyces*, in which the penetrating organ expands to form a cellular cushion, grows on the thin integument beneath the elytra, or at the bases of the legs of its otherwise hard-shelled host. But the most striking instances of this nature are seen in forms which live on soft bodied Diptera, and produce a more or less well developed filamentous rhizoidal apparatus. In *Dimeromyces rhizophorus* the thin skin on the under surface of the abdomen of a small fly is perforated, as is shown in Plate XXVIII, figs. 6-8, and a stout tapering filament extends some distance into the semi-fluid contents of the abdomen, furcate in the female, and simple in the male individual. A beautifully developed branching rhizoid is seen in *Ceraomyces Dahlii*, Plate XLIII, fig. 4, and a still more copiously branched organ of this nature is present in the species of *Arthrorhynchus*, the copious and intricate branching of which is merely suggested in Plate XLVIII, fig. 2.

It is a remarkable fact that the presence or absence of such penetrating organs is not necessarily an attribute of all the species of a given genus, or even of those which grow on the same, or similar hosts. Thus *Ceraomyces Selenæ* and *Rhizomyces crispatus* both possess a typical foot, although all the other species of these genera are rhizophorous. *Dimeromyces rhizophorus*, moreover, is the only species in a considerable genus, which has this character; although the closely allied *D. coarctatus* grows under exactly the same conditions in the same position on a similar soft bodied host. In the genus *Stigmatomyces*, the species of which with few exceptions occur on soft bodied flies, not a single instance of this nature is known, nor does *Laboulbenia Hageni*, on the delicate integument of the soft bodied Termites, develop any intrusion from the normal foot figured, from below, in Plate III, fig. 4, of the former Monograph. An isolated instance in which the usual foot is combined with a penetrating organ, occurs in the genus *Herpomyces*, all the species of which possess slender simple rhizoidal threads, which penetrate



the host-integument from the foot itself, and are similar in all respects to the rhizoids developed from the cells of the remarkable creeping secondary receptacles which characterize all the species of this genus.

Although forms in which these organs replace the ordinary foot do not appear to gain any very appreciable advantage as regards nutrition, at least in so far as is indicated by size or luxuriance, there can be no doubt whatever that their function is one of absorption; since they are thin-walled, with dense protoplasmic contents, and are not developed in such form as one would expect were their function that of holdfasts merely. That they combine the office of holdfasts with that of absorbing organs is, however, manifest; since otherwise the individuals would be easily detached. Thus in *Arthrorhynchus*, as indicated in figs. 2 and 7, Plate XLVIII, and in *Ceraomyces Dahlii*, Plate XLIII, figs. 3-4, a somewhat abrupt swelling of the rhizoid immediately within the host-integument makes the removal of an individual impossible without breakage, either of the host or of the parasite, and in *Dimeromyces rhizophorus* the same end is attained by the abrupt divergence of the two branches to which the rhizoid immediately divides on entering the body cavity. Cavara, in his paper above cited, criticises the writer for having given scant attention to this matter of the method of food absorption, having apparently overlooked such references as were made to the subject (Monograph, pp. 204-5). The theory advanced by Cavara that the appendages are the organs of absorption, would seem untenable even were it not true that appendages are sometimes wholly absent in these plants; since a majority of the forms come in no immediate contact with water, except such as may be condensed on the surface of the host, and it is not probable that the material necessary for the growth of chlorophyllless plants rich in fat etc., can be taken from the air. In general, too, the appendages are surrounded by the same impermeable membrane that covers the other portions of these plants, and would appear to afford ineffective organs of absorption, even were the surrounding medium a favorable one for obtaining food materials. The rigid limitation of species of Laboulbeniales to single genera, or even species, of insects, which holds in general throughout the group, could hardly, it would seem, be explained on a basis of pure saprophytism; and although, as previously stated, the growth of these plants is not associated with any appreciable injury to the host, it is nevertheless a true parasitism of a typically obligate type. In this connection it may be mentioned that one case has been observed in which definite injury is done to the abdomen of a soft bodied host. The instance referred to, however, is not one in which the parasite possesses an intrusive haustorium; but was seen in a number of the small flies parasitized by large numbers of *Dimeromyces coarctatus*. In these cases a definite lesion, so to speak, appeared to be associated with the presence of the parasites, and was indicated by a brown discoloration and by a shriveled condition of the parts attacked.

*The Structure of the Receptacle*, although it is in general an uncertain guide in tracing general relationships in the family and may in some instances vary very considerably in different species of the same genus, or even in individuals of the same species, affords nevertheless characters of very considerable diagnostic value. The large number of generic types herewith enumerated show so many variations and combinations in this respect that it will not be possible in the present connection adequately to discuss and compare them; yet certain of their types and general tendencies need to be mentioned, in order that the conditions hereafter illustrated may be properly understood. It was formerly pointed out in the earlier Monograph that the vegetative body of these plants, like that of the Red Seaweeds, is in general reducible to a system of branching filaments which, in the present instance, is chiefly peculiar from the fact that the system is, or tends to become, determinate in given genera and species, and that



this determinate character is absolute, as a rule, in the more highly specialized portions of the thallus, like the perithecia and compound antheridia. In considering the variations of the receptacle, it is thus convenient to distinguish in a general way, those forms which are determinate, as in *Stigmatomyces*, *Ceratomyces* etc., from those in which, as a result of secondary cell divisions, whether terminal or intercalary, the cell-number becomes more or less variable, as in *Ecteinomyces*, *Dichomyces* etc. In the second of these types, two categories may be further distinguished; namely those in which the indeterminate character results from an intercalary division of the main axis, a condition well illustrated by *Dimeromyces pinnatus*, Plate XXIX, fig. 16, and secondly those in which the secondary production of cells is due to the development of branches, or secondary axes, such as occur in *Kainomyces*, *Monoicomycetes*, *Dimorphomyces*, *Dichomyces* and other genera, usurping the function of the primary receptacle by giving rise to perithecia, or antheridia, or both.

It is thus convenient to distinguish types which possess a *primary receptacle*, only, corresponding to the original axis of the basal spore-segment, and immediately concerned in the production of procarpic branches; from those in which the primary receptacle, though present, is sterile; the production of sexual organs being relegated to secondary axes which branch laterally from it and may be distinguished as *secondary receptacles*. Among genera of the first category, in which the primary receptacle is determinate and fertile, those types in which the latter consist of two superposed cells are the most common, and of these the simplest condition is illustrated by *Amorphomyces*. In neither sex of this dioecious genus is it associated with sterile cells or appendages; the type being quite anomalous in possessing a continuous spore, from which the procarp in the female, as well as the antheridium in the male, develop terminally. In no other genus is the axis of the procarp continuous with that of the primary receptacle, although, as in *Kainomyces*, it may sometimes bear this relation to its branches. This condition is directly dependent on the fact that in all other genera, even in the very closely related *Dioicomycetes*, the spore is once-septate, the distal segment becoming a "primary appendage," which is either sterile, or is concerned in the production of antheridia. This condition is illustrated on the one hand by *Dioicomycetes*, the species of which possess a two-celled receptacle surmounted by a sterile portion corresponding to the distal spore-segment and bearing the procarp laterally; and on the other by such genera as *Eucantharomyces*, *Stigmatomyces*, *Corethromycetes* and many others, in which the terminal spore-segment produces an antheridial appendage of varying complexity.

Instances in which the primary receptacle is two-celled and sterile, are found in both the monoecious and dioecious genera, and by far the most remarkable illustration of this condition is seen in *Herpomyces*, in which the perithecia are borne on secondary receptacles that are more clearly differentiated than in any other instance. In the female individuals of the species of this genus, Plates XXXIX–XLI, a variable number of branches may thus arise, which originating as simple cylindrical filaments, soon become cellular, forming secondary receptacles which creep more or less extensively, or are variably multiplied in different species by branching; perforating the host-integument, as has been above described, by means of thread-like rhizoids which render these structures independent of the original foot as far as their food-supply is concerned. This peculiar condition is in general confined to the female individuals, although in *H. Ectobiæ* it is equally prominent in the male. Branches which become adherent to the host have been described in no other instance, although they are known to the writer in one other peculiar dioecious genus as yet undescribed, but it is not difficult to imagine that such a condition might either have origi-



nated from, or, on the other hand, have been modified to form conditions such as are found, for example, in *Dimorphomyces*, and especially in *D. Myrmedonia*, Plate XXVIII, fig. 14, in which the elongate secondary axis, projecting as it does laterally, and at right angles, from the short primary receptacle, may rest against the surface of the host, although it does not become attached to it. Of forms in which both male and female organs occur on the same branches, *Monoicomycetes* furnishes a striking example well illustrated by *M. St. Helenæ*, Plate XXXVI, fig. 8, in which they are more than usually elongated.

In this connection attention should be called to certain forms in which the primary receptacle is obliterated at a very early period by the growth of its fertile branch which has the appearance of being directly continuous with it, the two axes becoming coincident. This condition is found in all species of *Rhachomyces*, Plates XLIV and XLV, and accounts for the apparently simple axis in most normal individuals of *Monoicomycetes Leptochiri*, Plate XXXIV, fig. 39. Among other forms having two-celled receptacles, which seem to belong in this general category, two other genera need special mention, namely *Moschomyces* and *Compsomyces*, in which the secondary perithecial axes are single appendiculate cells, continuous with and hardly distinguished from the perithecial stalk-cells, so that the perithecium appears to be borne on a double stalk-cell. A somewhat similar condition is seen elsewhere only in the perithecial branches which arise from the massive receptacles of *Zodiomyces* and *Euzodiomyces*.

Turning now to instances in which the basal spore-segment becomes divided more than once to form the primary receptacle, a variety of conditions may be found, but the same general distinctions previously outlined may be recognized. Thus the primary receptacle may be determinate or indeterminate, and the procarps may arise either directly from it, or from its more or less evident lateral branches.

Instances of determinate receptacles of more than two cells, from which the procarps arise directly, are rare, and may be illustrated by the genus *Ceratomyces* as limited in the present paper, and by *Autoiomyces*, Plates LXVIII–LXX. Whether the peculiar genus *Teratomyces*, Plate XLIX–L, might not be included here, is uncertain; since the exact origin of its perithecia is as yet unknown, although they seem certainly not to arise from the third cell of the receptacle. Whether the cell above this should also be regarded as a part of the primary receptacle, has not been determined, in the absence of a complete series from the germinating spore; but both the perithecigerous and the appendiculate cells appear to arise as proliferations from it. The conditions in *Symplectromyces*, are evidently similar, and the beginning of this condition is perhaps illustrated by *Idiomyces*.

Of indeterminate receptacles from which procarps arise directly, one of the simplest types is seen in the anomalous genus *Chætomyces*, formerly illustrated; but a complete series, in which the relations between the ultimate products of the two spore-segments can be determined, has not as yet been examined. In contrast to this form in which the number of secondary divisions is small, the cell-number thus varying within restricted limits, *Ecteinomyces* may be mentioned as one in which differences due to secondary elongation may be extreme, Plate LI, figs. 15–17, and a similar though less variable condition is illustrated by *Hydrophilomyces*, Plate LXVIII, figs. 1–2. The female individuals of *Dimeromyces*, and even the males, may also be thus secondarily modified, a condition strikingly illustrated by *D. pinnatus*, Plate XXIX, fig. 16. *Enarthromyces*, among the monœcious forms with compound antheridia, affords another instance of the same nature; but one in which the secondary elongation does not result, as in the last mentioned instance, from continued division of the basal cell.

Among types in which the procarps are borne on branches which arise from indeterminate primary



receptacles, the most striking and peculiar is seen in *Kainomyces*, the massive receptacle of which gives rise to lateral axes of superposed cells terminated by perithecia, Plate LXXI, figs. 20-21. *Zodiomyces* and *Euzodiomyces*, both conspicuous for their massive receptacles, also produce their perithecia terminally on short branches, as has been already mentioned. A very peculiar type which seems to belong here, although no young material has been examined, is seen in *Clematomyces*, Plate XLIII, fig. 1. Here a stout main axis, consisting of a double row of cells, gives rise to a variable number of branches similar to it in structure; but how much of the former corresponds to the basal spore segment it is not possible to say.

Lastly the genus *Dichomyces* which, by assuming a scale-like habit, has beautifully adjusted itself to its life on the abdomen of a swiftly running host, illustrates a condition in which a seemingly broadly multicellular primary receptacle consists in reality of a central and invariable axis of superposed cells, corresponding to the basal spore segment, which produces branches right and left above the basal cell, in many species symmetrically paired. Although these branches may be variably united to one another above and below, and thus give the appearance of a cellular mass, they may in other cases be almost wholly free, especially the upper pair, as is well illustrated by *D. biformis*, Plate XXXIII, fig. 3. The genera *Peyritschella*, *Limnaiomyces*, *Chitonomyces* and *Hydraomyces* are all more or less evidently similar in the development of their receptacles. In the very closely allied genera *Rickia* and *Distichomyces*, which, however, form a well marked group by themselves, the development of the receptacles, which is given in some detail below under these genera, although of a different character from that of the *Dichomyces*-type, is similarly resolvable into series of coherent branches.

Before leaving the subject of receptacles, attention should be called to certain peculiar modifications of the basal cell which are evidently protective, acting as supports or buffers, and consist of more or less indurated outgrowths, most conspicuously illustrated by *Kleidomyces*, Plate XXXVII, fig. 3, and to a less extent by *Corethromyces Stilici*, Plate L, figs. 6-9. A similar supporting and protective function is no doubt served by the blackened fork-like upgrowths from either side of the subterminal tier in many species of *Dichomyces*, Plate XXXII, although these structures, being modified tips of lateral branches, are morphologically quite different. In this connection the remarkable extension of the basal cell in species of *Dimorphomyces*, and especially in *D. Myrmedoniæ*, Plate XXVIII, fig. 14, should be referred to, forming as they do a continuous supporting margin below the laterally developed sympodial peritheciigerous branch. The small beginnings of conditions such as the two first above mentioned, are to be found in such occasional modifications as were formerly described and figured in connection with *Laboulbenia Philonthi* and *Compsomyces verticillatus*, Monograph, Plates XI, fig. 13 and XXII, fig. 28, and the foot-like modification of the receptacle in various species of *Ceratomyces* undoubtedly serve a similar purpose.

*Appendages.* An appendage of some kind is present in all genera with the single exception of *Amorphomyces*, which in this, as in other respects, is the simplest known generic type. In all others, the spore being two-celled, the distal segment is transformed into a structure corresponding to a primary appendage, although in male individuals of unisexual types having simple antheridia, like *Divicomycetes*, the distal segment may be transformed directly and *in toto* to an antheridium. The new genera here included offer few general types not described in the former Monograph; but certain ones need special mention, which may be more conveniently made in connection with a brief review of the more important types of antheridia. The distinction between the primary appendages, which are always derived from the upper



spore-segment, and the secondary appendages having a different origin, is usually clearly recognizable; but is sometimes obscured, as in the case of *Teratomyces* and *Symplectromyces*, above referred to, the relation of the crowded appendiculate cells in these forms, to the terminal segment, being uncertain.

The new material now available illustrates more fully than was formerly possible the range of variation in the primary appendages. The simplest type, a two-celled sterile prominence, is seen in female individuals of *Dioicomyces*, and in other types may become complicated by further divisions, as well as by the production of sterile branches; and may remain wholly sterile, or be concerned in the formation of antheridia, or antheridial branches. The latter condition is that which is usually, though not always, found in monœcious types; in which the primary receptacle is directly concerned in the production of procarps. Thus in *Stigmatomyces*, or in *Eucantharomyces*, Plate XXXVIII, the primary appendage is largely devoted to this purpose, while in *Enarthromyces* or in *Coreomyces* it is wholly sterile. Among more highly developed primary appendages, those of *Rhizomyces crispatus*, Plate LII, fig. 19, and *Corethromyces Cryptobii*, Plate LI, fig. 3, may be taken as illustrations; while many members of the genus *Laboulbenia*, in which the stalk of the perithecium is combined with that of the appendage to form a pseudo-receptacle, indicate perhaps the highest development of a primary appendage. This is especially well illustrated, for example, by *L. bicornis*, Plate LXVII, fig. 1, or by *L. spectabilis*, Plate LVII, fig. 12.

In a number of genera, not necessarily related, the primary appendage bears a characteristic spine-like process, to which reference was made on page 209 of the Monograph. This is especially conspicuous in *Haplomyces*, *Stigmatomyces*, *Arthrorhynchus* and *Acompsomyces*, among others, and appears to be nothing more than the persistent spore-apex, its presence thus marking the position of the absolute termination of the upper spore-segment. It is formed in all probability almost entirely from the attenuated extremity of the mucous spore-sheath, which in such cases becomes indurated and persistent. In *Herpomycetes* it is generally associated with a minute appendage of a different type, small, blackish and characteristic in appearance, but probably of secondary origin. The spinous process may be terminal in the adult appendage, lateral on a terminal antheridial cell, as in many species of *Stigmatomyces*, or intercalary in position through the proliferation of the appendage beyond it, a condition seen also in species of *Stigmatomyces*, as well as elsewhere.

The theory advanced by Cavara that these plants absorb their food materials by means of the appendages, has been referred to above. But there seems to be no reason whatever for believing that their function is other than that formerly suggested, namely one primarily for protection, where they are sufficiently developed to perform this office, and for holding moisture about the perithecium or sexual organs; as in forms, especially, that live on hosts frequenting moist situations, where water is sure to be condensed upon their surface. That water is actually held in drops by the appendages is easily determined when living hosts are collected under stones, or in other situations which favor the condensation of moisture; yet, although there is perhaps a distinct tendency to a brush-like development of branches in forms thus conditioned, the exceptions are marked; and any generalization in this connection would be unsafe. *Haplomyces*, for example, inhabits a host, *Bledius*, that lives in moist burrows in mud or wet sand, and is thus exposed for the most part to a nearly saturated atmosphere, yet the appendage is of the simplest type, without sterile branches of any kind, although the closely allied *Cantharomyces*, living on the same host is thus provided. Again *Rhizomyces crispatus* has already been referred to as an example in



which the appendage is remarkably developed, yet the host is a fly which may be assumed to spend most of its life, at least, in the free air, although it is said to be riparian.

*Male Sexual Organs.* A general division of the Laboulbeniales was formerly made by the writer on a basis of the differences which appeared to exist in the method of abjunction of the sperm-cells; those in which the latter were endogenously formed, being discharged free from a specialized antheridial cell, "Endogenæ", and those in which they appeared to be exogenous branchlets, or segments of branchlets, separated from the appendages, "Exogenæ". It appears somewhat doubtful, however, whether this distinction can be as clearly drawn as was at first supposed, in view, particularly, of the conditions seen in *Coreomyces*, a genus very remarkable in its structure and development. The antheridial cells in this instance, are merely undifferentiated cells of secondary appendages arising as branches from special cells of the receptacle lying below the origin of the procarp, and not corresponding to any portion of the primary appendage, which is wholly obliterated during the development of the perithecium. As in *Rhynchophoromyces rostratus*, (Monograph, Plate XXIV, figs. 21-24), the antheridial cells are intercalary as well as undifferentiated; but in the present instance develop a short cylindrical neck through which free sperm-cells are discharged very much as in the endogenous forms. That there is a gradual transition, rather than a sharply defined line of demarcation between these two general types, is further suggested by the conditions seen in *Hydrophilomyces*, the species of which were formerly included in *Ceratomyces*. If the structures represented on Plate LXVIII, figs. 3-4, are in reality antheridia, we have here a type that, although in many respects it corresponds closely to that of the *Ceratomyces*-group which is likewise aquatic, discharges its sperm-cells free, from cells which are almost as distinctly specialized as are those, for example, of *Compsomyces* or of *Ecteinomyces*, Plates XLIII, fig. 12 and LI, fig. 18. The antheridia of *Kainomyces* and *Euzodiomyces*, genera the near relationship of which to *Zodiomyces* may be assumed, are as yet unknown, owing to the imperfect character of the material available. Neither is the nature of the male elements absolutely determined in *Ceratomyces*, or in *Autoicomycetes*, in both of which they appear, however, to be segments of certain slender branchlets. The conditions existing in the genus *Misgomyces* also, which may be related to these forms, are still unknown; so that, as far as any definite production of exogenous male elements is concerned, it must be confessed that it is definitely known only in *Rhynchophoromyces* and *Zodiomyces*. Until the exact conditions can be determined in the cases above referred to, this general distinction must remain of doubtful value, and in attempting to construct a key which should at the same time indicate in a general way the relationships of the genera, the main divisions have been based on the differentiated or undifferentiated character of the antheridial cells, a distinction which, however, can be considered by no means absolute, since it might exclude from the latter class *Hydrophilomyces*, a genus, as above suggested, apparently most nearly related to the *Ceratomyces*-group.

A further general distinction was made in the group of so-called Endogenæ, based on the compound or simple nature of the antheridia: the *simple* type consisting of cells indeterminately placed, or more or less definitely associated, free, or at least with free and independent efferent tubes; the *compound* type involving not only the definite association of several or many antheridial cells in a determinate group, specific in its character, but also a different method of discharge; the efferent tubes of all the antheridial cells composing such an antheridium, opening into a common cavity, whence the sperm-cells make their exit through a single opening or passage. Although this distinction appears to be almost absolute, and



seems to be entirely so as far as the cell relations in development are concerned, a single instance has been found among the recently discovered genera in which the antheridial cells, although they almost certainly originate as in typical compound antheridia, become ultimately free in a compact group, each discharging independently; the cell below which they were formed and through which they would normally discharge by means of a common opening, being sloughed off and destroyed early in their development. The genus *Distichomyces* in which the conditions just described appear to exist, is so closely allied to *Rickia* that it might almost be included in it, yet in *Rickia* highly specialized compound antheridia are present. Moreover the close relationship of both these genera to the group of genera assembled about *Peyritshiella*, and possessing typical compound antheridia, cannot for a moment be questioned. If therefore, one makes an absolute distinction based on the characters of the mature antheridium, as has been done in the tentative key to the genera herewith appended, the genus *Distichomyces* would naturally be sought among the "Laboulbeniaceæ" where it certainly does not belong.

The type of the simple antheridium is in general a very constant one, although there may be a rather wide variation in the minor characters, the form of the venter, length and curvature of the neck, and the relative proportions of its two parts. The relations of the simple antheridia to one another, when they occur in groups, was formerly emphasized as a matter of importance in distinguishing certain genera and species, the serial arrangement being the most distinctive. The genus *Stigmatomyces*, to which many species have recently been added, illustrates this condition very clearly, although in this highly differentiated appendage, the antheridial cells are not always, or even usually, as was formerly stated, superposed in a single row, as is the case in *S. virescens*, or *S. purpureus*, Plate XLVI, fig. 36; but a series of sympodia is formed, each antheridial branchlet separating a basal cell, which in turn grows out directly to form a second antheridium, so that the series is double at least in the lower portion of the appendage, Plate XLIX, fig. 13. The lowest groups may even produce more than two antheridial cells, as in *S. constrictus*, Plate XLVI, figs. 1-2. This last condition tends to break down the distinction based on antheridial series between this genus and *Arthrorhynchus*, Plate XLVIII, in one species of which, fig. 3, the arrangement is very similar. A single type in which the antheridia are strictly intercalary, like those of *Corethromyces*, has been added in the genus *Symplectromyces*, Plate L, figs. 14-16, but this relation appears to be a rare one. The number of antheridial cells in such associations appears to be more or less definite in certain cases. In a majority of the species of *Stigmatomyces*, for example, this character seems to be one of the most useful in distinguishing species, while in *Teratomyces*, on the other hand, in which the antheridial branch is also a monopodium, there is absolute irregularity in this respect. A new and very individual type of appendage somewhat similar to that of *Stigmatomyces* is seen in *Acompsomyces*, and another less well defined in *Acallomyces*; these appendages being in general simpler and tending to break down any abrupt line of demarcation between types of appendages with serially arranged antheridial cells, and those in which the latter are irregularly placed. A few instances occur in which the grouping of the antheridial cells is of specific, though not of generic value, a condition best illustrated, in the genus *Laboulbenia*, by such species as *L. Oezenæ*, Plate LXIII, fig. 11, or *L. variabilis*.

The transition between simple, but distinctly differentiated, antheridial cells, and the undifferentiated segments of an appendage or its branches, which may serve a similar purpose, has already been referred to, and is illustrated most clearly by *Coreomyces*, Plate LXXI, fig. 13. These segments, although they discharge their contents in a similar fashion, are evidently variable in size and form,



and are associated with similar segments having no such function. This function, furthermore, appears to be a transitory one, and as far as has been determined, the discharge of sperm-cells ceases soon after fertilization, and the appendage develops more or less copious sterile branches and loses all traces of its primary function, figs. 7 and 16; a statement which, it may here be mentioned, applies also to the supposed antheridia of *Hydrophilomyces*.

The associations of antheridial cells which form the functional portion of the often highly developed compound antheridia are in general very definite, and the numbers of the latter may be, and usually are, more or less invariable in different genera or species. They arise, like the simple antheridia, as branchlets, which, instead of growing outward, penetrate an adjacent cell, opening and discharging into its cavity, whence the sperm-cells escape by a variably developed, often tubular and elongate outlet, that is sometimes a mere extension of the cell forming the common cavity, or in a few instances involves other cells. An illustration of the last condition is seen in the antheridium of *Euhaplomyces*, Plate XXXVII, fig. 21, a type not previously illustrated. Another new type is seen in the genus *Rickia*, the antheridium of which is quite unlike that of the nearly allied *Peyritsiella*; not, as in this genus, adnate to the receptacle, but borne quite free upon it and distinguished by a broad black septum, Plate XXXIV, figs. 12-13. In general form it closely resembles a simple antheridium of the ordinary type, but the several antheridial cells which compose it are nevertheless clearly distinguishable. The singular condition seen in the closely allied *Distichomyces*, with its groups of apparently simple and free antheridia, has already been referred to above. The most remarkable, however, among the new types illustrated, are those found in the two new genera, *Monoicomycetes* and *Eumonoicomycetes*, Plates XXXVI and XXXVII, the detailed structure of which is described under these genera. This type, which in *Eumonoicomycetes Papuanus* is more complicated than that of any other form, differs widely from those previously illustrated, both in the arrangement of the antheridial cells, and in the method of discharge between four terminal and eventually appendiculate cells. Still another new type is found in the singular *Kleidomyces*, but unfortunately the cell relations here are not determinable from the scanty material available. Lastly the many new species of *Eucantharomyces* illustrate very fully the variations in this highly developed type, in which the usually oblique rows of cells which give it such individuality, appear to represent the intercalary segments of an original branchlet, that become converted directly to antheridial cells which discharge inward.

Of the fifty-four genera thus far distinguished there are five in which the character of the antheridia is quite unknown, namely, *Polyascomycetes*, *Smeringomyces*, *Misgomyces*, *Euzodiomyces*, and *Kainomyces*, while in the following genera these organs are but doubtfully determined: *Chitonomyces*, *Hydræomyces*, *Ceratomyces*, *Autoicomycetes*, and *Hydrophilomyces*.

*Female Sexual Organs.* The general account formerly given of the origin and development of the procarp, appears to be substantially correct, and little new information in this connection has been obtained. One type of trichogyne, not formerly observed, is seen in *Acompsomyces*, the clavate extremities of which are beset in a very characteristic fashion, Plate XLII, figs. 8 and 12, with receptive vesicles, which might at first sight be taken for conjugating sperm-cells.

A most singular departure from the normal method of origin in the procarp is seen in *Coreomyces* in which not only the female branch, but also the sterile cells of the perithecium, originate endoge-



nously, growing, like the antheridial cells of compound antheridia, into the cavity of the adjacent cell above. Not only is this cell traversed by the procarpic, and later by the perithecial branches, but several cells above are successively penetrated, the intervening septa being perforated and destroyed; the free trichogyne eventually making its way out distally and replacing the terminal primary appendage, which is sloughed off. This very peculiar condition, which is illustrated on Plate LXXI, and described in detail under the genus, has no counterpart in the group. The perithecia of *Zodiomyces*, although the branches which produce them arise endogenously, are themselves exogenous, and quite free from the beginning of their development. In *Ceratomyces*, also, although the formation of the perithecium is not of the ordinary type, the conditions do not appear to be in any way comparable.

The early development of the carpogonium after fertilization has been described in detail in the Monograph, and appears to be similar throughout the group. The only striking phenomenon in this connection that has been observed among the new forms is seen in the genus *Polyascomyces*, in which the ascogenic cells become so greatly multiplied that a condition occurs not unlike that seen in the perithecium of other Ascomycetes, more than thirty ascogenic cells covering a basal area from which large numbers of asci bud upwards; Plate XXXVII, figs. 1-2.

The cytology of ascus- and spore-formation has been examined by Dr. Faull who has published a preliminary note in Science, already referred to, and has kindly allowed the writer to examine his preparations. The latter appear to show that the phenomena involved correspond essentially with those in other Ascomycetes, the ascospores being formed as a result of the divisions of a fusion-nucleus by a process exactly similar to that which is normal in this type of spore-formation. Since Dr. Faull has not as yet published a full account of his results, the writer does not feel at liberty to make further reference to them in the present connection.

The structure of the mature perithecium is, in all genera, fundamentally the same, except in the case of the pseudoperithecium of *Coreomyces*, and has been given in detail in the Monograph. The most important variations relate to the number of cells in each of the four outer and of the four inner and alternating rows of wall-cells, and to the production of outgrowths or appendages from the outer rows. A curious condition has, however, been observed in *Dichomyces*, some species of which show a remarkable dimorphism in their perithecia; the two forms being associated on the same individual as in *D. hybridus*, Plate XXXI, fig. 16; or occurring, as in *D. biformis*, Plate XXXIII, figs. 2-3, on distinct individuals. In both these instances it will be observed that the two varieties are not only unlike in size and form, and to some extent in color; but that, while in one auricle-like outgrowths are present, these are wholly absent in the other. Two forms of perithecium also appear to occur in *Rhizomyces crispatus*, Plate LII, figs. 19-20, although in this instance it is barely possible that two species are concerned. It is possible that the dimorphism in *D. hybridus*, may have resulted from hybridization, for example between a form like *D. furciferus* and the common extra-Asiatic form of *D. hybridus*, which is not known to possess auricles. This dimorphic condition, however, appears to occur in other species, and it seems unlikely to the writer that it can be explained in this way. Among instances in which the perithecium may show wide differences in form in a given species, *Laboulbenia Polyhirmæ* may be mentioned, Plate LXV, figs. 1-3; and the varieties of *L. Texana*, if these are rightly separated merely as varieties, show very remarkable conditions in this respect, Plate LXIII, figs. 3-9.



That a *Sexual Condition* exists in these plants and that the organs alluded to as antheridia, sperm-cells, procarps, trichogynes etc. actually have the functions which their names imply, has been assumed in the above account. Although no one who has a knowledge at first hand of the Laboulbeniales in a living condition would for a moment doubt the correctness of this assumption, it should be mentioned here that the cytology of the reproductive process is still unknown, however clearly its general nature may be indicated by the observed morphology, and certain writers have denied *in toto* the sexual nature of the supposed male and female organs. Alfred Moeller, for example, although he has no personal knowledge of these structures, makes the statement without reservation, (Schimper, Bot. Unters. a. d. Tropicen, IX, p. 45, 1901) that the so-called antheridia are merely conidiophores, producing conidia, the supposed sperm-cells, in a *Chalara*-like fashion. Yet if these supposed sperm-cells are in reality non-sexual propagative bodies, it seems singular, since they are produced in enormous quantities in many cases, that no indication has ever been seen which would suggest the possibility that individuals ever arise from bodies other than the ascospores. If individuals were ever developed from these minute micrococcus or bacillus-like, for the most part naked, protoplasmic masses, such an origin would certainly have been indicated in some instances among the great mass of material examined. The whole history of the early development, moreover, forbids such an assumption, and especially the conditions found in the unisexual forms. That matters should be so arranged in the latter that a conidial and an ascigerous individual should be invariably predetermined in every spore-pair, seems a manifest absurdity. The conidial theory also, overlooks the trichogyne, often a very remarkable and highly differentiated structure, as well as the adherence of the "conidia" to certain special portions of it. Even if one could be contented with some of the utterly ridiculous explanations of "trichogynes" found elsewhere among the fungi, that have been gravely advanced, it would be difficult to see, for example, in the present instances, why a "ventilating apparatus" should cease to ventilate and should disappear at the very moment when the active development of the region ventilated was beginning and when "ventilation," one would suppose, would be most necessary. That these structures are designed to "turbulate" the empty air is also, to say the least, an unsatisfying explanation of their presence.

*Abnormalities* among the Laboulbeniales occasionally occur, some instances of which have been previously illustrated, as for example the substitution of an antheridial appendage for a perithecium. Instances of this nature in which bisexual individuals may become unisexual through the atrophy of the perithecium, and the substitution for it of antheridial branches, are not uncommon; but another example of a different nature is sometimes found, and results from the partial atrophy of one member of the spore-pair. The failure of one member of a spore-pair to develop, was noted and figured in connection with *Laboulbenia inflata* in the Monograph, and has been seen in other instances. While, however, such undeveloped individuals are, or appear to be, quite functionless, cases have been seen in which, although one member becomes normally developed, producing an antheridium and procarp, the other develops normally as far only as the production of the antheridium is concerned and shows not the slightest indication of any procarp. Such an instance is represented on Plate XLIX, figs. 16-17, the two individuals being the products of the same spore-pair. The abnormal production of perithecia is a common occurrence in some genera, and has been previously described and figured. It has been seen occasionally in *Laboulbenia proliferans* also, the secondary perithecia arising from the subbasal cell and thus confirming the view taken by the writer as to the homologies of the receptacle in this genus.



Of abnormalities more or less directly due to environment and resulting from growth under continuously unfavorable conditions, as for example exposure to violence or insufficient nutrition, numerous instances might be cited in which the general form and the character of the appendages may have been thus modified. The most remarkable instance, which appears to be of this nature, is seen, however, in the genus *Dichomyces*, and results in a structural variation which may be in the nature of a reversion. In several species, especially when large numbers grow crowded on the legs of swiftly running hosts, the normal symmetry is lost and the individual assumes a structure exactly like that of the genus *Peyritschella*, although under favorable conditions, as on the abdomen, this form never appears. Such a condition of *D. inæqualis* was formerly figured and described as a new species of *Peyritschella*, *P. nigrescens*, and it seems not impossible that this phenomenon may be comparable to reversions resulting from injury in the higher plants. That abnormal forms due to hybridization may exist, has already been suggested above, and this may account for the confused variations seen, for example, in *Dichomyces vulgaris* or *D. princeps*. *Laboulbenia melanotheca*, also, may possibly be nothing more than a hybrid between *L. Mexicana* and some of the species with black perithecia often associated with it, although this is of course a mere suggestion.

The *Geographical Distribution* of the species and genera is now sufficiently well known in many instances to illustrate various points of interest in this connection, but in view of the limitations of the present paper as to space, and the fact that large additional collections of these plants are now awaiting examination and study, no general summary or tabulation of distribution will be here attempted. Information in regard to distribution is most complete in reference to parasites of the Carabidæ; since this family of beetles is a favorite group among entomologists, and is extremely well represented in a majority of the exotic collections examined. Since, also, these insects include a majority of the hosts infested by species of *Laboulbenia*, it is in this genus that the most complete data as to special instances of distribution have been obtained. A brief reference to the subject will be found below under this genus, but it may be remarked in this connection that it is singular to find a species like *L. variabilis* infesting a variety of common genera in both American continents, yet quite unknown elsewhere; while the distribution of *L. Pheropsophi* is coextensive with that of its host in five continents. Of the numerous species on *Galeritæ* in South and Central America none extend to Africa, where *Galeritæ* are numerous in species, and are attacked by a single form only, unrelated to the South American one. Again *L. Philonthi*, which is the common form in North and South America on members of the very large and universally distributed genus *Philonthus*, is unknown from other regions, although almost unlimited material has been looked over; while *L. cristata*, the only species growing on members of the large and varied genus *Pæderus*, has been found from all the continents.

The *Development of Series* in the Laboulbeniales, the directions in which this development has proceeded, and the determination of what characters may be considered primitive or the reverse, are matters of interest concerning which, however, the writer finds himself unable to arrive at any satisfactory conclusions. On the assumption that these plants have been derived from aquatic ancestors, one would naturally look to the existing aquatic forms, rather than the terrestrial ones, for suggestions as to primitive conditions. The aquatic forms which possess compound antheridia, as is evident from the structure of *Limnaiomyces*, are identical in type, and closely related to, the much more numerous and more highly developed terrestrial genera of the Peyritschellaceæ, and the same may be said of the often very highly



developed aquatic species of the genus *Laboulbenia*. It is therefore among the Ceratomycetines, of the accompanying Key, that one would look for suggestions in this connection. That the vegetative characters of this series, far from being simple, are quite the reverse, might have no significance in this respect; but if one presupposes an origin for the group from aquatic types near the simpler Florideæ, it is evident that in these water forms, the antheridial characters, which afford by far the most reliable and fundamental characters for general groupings in these plants, are more unlike the antheridia of the red algæ than those of the more highly developed terrestrial genera. In any attempt to arrive at a conclusion concerning these matters, several fundamental questions need answers which are not as yet forthcoming. First, has the unspecialized antheridial cell of *Rhynchophoromyces* or *Zodiomyces*, for example, become the specialized cell of the Laboulbeniaceæ, through conditions which may be suggested by those found in *Coreomyces*; or has the passage been in the reverse direction, resulting as an adaptation more likely to insure fertilization under the conditions of aquatic life. The second supposition, indeed, seems by no means an unlikely one, and *Ceratomyces*, which is assumed, at least, to produce its sperm-cells in coherent threads, would represent the culmination of this tendency in a modern genus.

Again it may be asked whether the simple antheridium has been derived from the compound, as might be suggested by the conditions seen in *Distichomyces*, or by a reduction to one cell of such a compound antheridium as is found in *Rickia*: or, as seems more probable, has the reverse process actually occurred. Furthermore it is by no means evident whether the unisexual, or the hermaphrodite condition, which are associated with both the simple and compound type of antheridium, is primitive or the reverse. Although the general tendency in upward series appears to be toward a separation of the sperm- and egg-cell-function on different individuals, and this condition has no exceptions in the highest plants, by far the most highly developed and apparently modern genera of Laboulbeniales are hermaphrodite: but if we look for what is absolutely the simplest condition found in this group, we find it without question in the genus *Amorphomyces*, a unisexual type with simple antheridia. And here it may be pointed out that all the forms which grow on Blattidæ, supposed by entomologists to be among the most ancient types of insects, are unisexual, with simple antheridia.

The not uncommon phenomenon already mentioned above, and formerly illustrated in *Laboulbenia inflata*, Monograph, Plate III, fig. 5, which involves the atrophy of one member of the usual spore-pair, may be perhaps significant in this connection; in that it suggests the survival of a tendency to form two kinds of individuals, one of which had become superfluous after the appearance of antheridia on the female individual. This is still more strikingly suggested by instances such as the one illustrated herewith, on Plate XLIX, figs. 16-17, which, although rare in general, are common in this and a few other species. Here one member of the spore-pair, becomes not only a dwarf individual, but is absolutely unisexual, bearing a well developed and normally functional antheridial appendage. Yet here also, the monopolization of food supply by one member of the spore-pair, may have led to a dwarf habit and partial loss of function in the other, and it is not by any means inconceivable that, through gradual loss of its male function by the vegetatively vigorous individual, a unisexual condition might become a fixed phenomenon, in both members.

Since the series may thus be read upward or downward as one prefers, and *Amorphomyces* is quite as likely to illustrate a last step in retrogression as a first in evolution, one may be pardoned, if like the writer he confesses his complete agnosticism in these matters, an agnosticism which embraces the question



of the origin of the Ascomycetes as a whole, and the determination of the course of evolution in the entire fungus series: matters which, in recent years, have been too copiously discussed in the rather feeble light of small contributions to the available data. Although it is difficult to believe that the Laboulbeniales, for example, and the Florideæ; that *Monoblepharis insignis* and *Vaucheria intermedia* Nordst; that *Araiospora* and *Dichotomosiphon*; that the Mycochytridineæ, *Rhodochytrium* and *Chlorochytrium* have none of them ever had mutual kin nearer than some primordial protoplasmic entity at the bottom of the plant series and in the early ages of organic life; it is nevertheless foolish, on the basis of our present knowledge, to attempt an arbitrary settlement of the complex phenomena of series among the fungi. As to the Laboulbeniales, it may be said with safety that they resemble the Florideæ in some respects more closely than they do any other plants, while at the same time they are more surely Ascomycetes than many forms included in this group, and the writer sees no sufficient reason why they should not be placed in the Pyrenomycetes, as a group coordinate with the Perisporiales, Hypocreales etc.



## KEY TO THE GENERA OF LABOULBENIALES.

In order briefly to summarize the genera thus far described, the following dichotomous key has been prepared which indicates in a general way their supposed natural sequence, as far as this is possible in such a summary, and includes a tentative separation of the more pronounced types which have been designated by special names designed to suggest the conditions of isolation in the various genera or groups of genera. It is not expected that this key will prove useful as a means of determining genera to anyone who has not made himself familiar with the general conditions existing in the group and summarized in the preliminary matter of this and the preceding Monograph. It will be observed that *Distichomyces*, although at maturity it possesses free simple antheridia, is included among the Peyritschiellaceæ, where it rightly belongs, and that also *Hydrophilomyces* is included in the second section, of Ceratomycetinae, although its supposed antheridial cells are more or less clearly distinguished. The latter are, however, merely corners, as it were, separated from the cells of the main appendage, and later appear to grow out into sterile branches as in *Coreomyces*. *Polyascomyces*, *Smeringomyces* and *Misgomyces*, being of uncertain affinities, and their antheridia being unknown, are assigned merely provisional places in the arrangement.

1. Antheridia specially differentiated cells or groups of cells.	LABOULBENIINEÆ	80
2. Antheridia compound, the antheridial cells endogenous, arising from one or more intercalary cells and discharging into and from a common chamber (eventually free in a compact group in <i>Distichomyces</i> )	PEYRITSCHIELLACEÆ	35
4. Individuals unisexual.	<b>Dimorphomyceteæ</b>	7
5. Perithecia arising from a primary vertical or oblique axis.	<i>Dimeromyces</i>	6
6. Perithecia arising from one or more secondary axes springing from the subbasal cell.	<i>Dimorphomyces</i>	
7. Individuals hermaphrodite, sterile appendages unicellular, subtended by black constricted septa.		20
8. Antheridium a free branchlet from the receptacle.	<b>Rickiæ</b>	11
9. Antheridial cells discharging through a common pore.	<i>Rickia</i>	10
10. Antheridial cells becoming free in a compact group.	<i>Distichomyces</i>	
11. Antheridium wholly or partly adnate to the receptacle.	<b>Peyritschielleæ</b>	18
12. Cells of the receptacle in tiers above the basal cell.		
13. Perithecia wholly free.		16
14. Subterminal tier of the receptacle bearing paired antheridia.	<i>Dichomyces</i>	15
15. Subterminal tier bearing a single antheridium at one side.	<i>Peyritschiella</i>	
16. Perithecia more or less adnate to the distal portion of the receptacle.		
17. Antheridium anterior at the base of the perithecium.	<i>Limnaiomyces</i>	18
18. Antheridium near base of appendages; two cells superposed above foot.	<i>Chitonomyces</i>	19
19. Antheridium as in 18, three cells above foot.	<i>Hydræomyces</i>	
20. Individuals hermaphrodite, sterile appendages multicellular, subtended by black constricted septa.	<b>Enarthromyceteæ</b>	
21. Individuals hermaphrodite, sterile appendages absent or without black subtending septa.	<i>Enarthromyces</i>	21
22. Antheridium discharging between four terminal appendiculate cells.	<b>Monoicomyceteæ</b>	25



23. Antheridial cells disposed in four opposite pairs.	<i>Monoicomycetes</i>	24
24. Antheridial cells numerous.	<i>Eumonoicomycetes</i>	
25. Antheridium opening by a free pore.	<b>Haplomycetæ</b>	
26. Antheridial cells unassociated with evident sterile cells above the stalk-cell of the appendage.		29
27. Antheridium terminal, rounded, areolate, with lateral pore and terminal spine.	<i>Haplomyces</i>	28
28. Antheridium conical with prominent terminal pore.	<i>Camptomyces</i>	
29. Antheridial cells associated with evident sterile cells above the stalk-cell of the appendage.		
30. Antheridial cells numerous, disposed in obliquely superposed rows, associated with an external sterile marginal cell, opening terminal.	<i>Eucantharomyces</i>	31
31. Antheridium opening by a lateral pore below a terminal cellular sterile portion.	<i>Kleidomyces</i>	32
32. Antheridial cells few, opening into a chamber extending upward beside two external sterile cells to a terminal chamber and pore.	<i>Euhaplomyces</i>	33
33. Antheridium areolate, lateral below sterile terminal branches.	<i>Cantharomyces</i>	
34. <i>Incertæ sedis</i> , ascogenic cells very numerous. (See 46.)	<i>Polyascomycetes</i>	
35. Antheridia single cells with free efferent tubes.	LABOULBENIACEÆ	
36. Individuals unisexual.		42
37. Perithecia on secondary repent receptacles attached to the host.	<b>Herpomycetæ</b>	
	<i>Herpomycetes</i>	38
38. Perithecia arising from a primary receptacle.	<b>Amorphomycetæ</b>	
39. Receptacle two-celled, terminated by the perithecium, spores continuous.	<i>Amorphomyces</i>	40
40. Receptacle terminated by a two-celled prominence, spores once-septate.	<i>Dioicomycetes</i>	41
41. Receptacle several-celled, chætophorous. ( <i>Incertæ sedis</i> .)	<i>Smeringomyces</i>	
42. Individuals hermaphrodite. Primary receptacle without secondary elongation through intercalary growth.		75
43. Receptacle simple, or without free axes of secondary origin.		69
44. Antheridial appendage a single, simple, specialized series of superposed cells, unassociated with sterile branchlets or appendages.	<b>Stigmatomycetæ</b>	50
45. Subterminal cell of the appendage sterile, the cell below it bearing several antheridia, the terminal cell bearing a single spinose antheridium.	<i>Acompsomyces</i>	46
46. Appendage of several flattened irregularly superposed cells, surmounted by a dome-shaped structure, ascogenic cells very numerous. ( <i>Incertæ sedis</i> , see 34.)	<i>Polyascomycetes</i>	47
47. Antheridial appendage of five cells, two superposed antheridia arising from the terminal and subterminal cells respectively.	<i>Acallomyces</i>	48
48. Distal, fertile, portion of the appendage consisting of two to many superposed cells which give rise to antheridia superposed in a single or double series.	<i>Stigmatomyces</i>	49
49. Antheridia more or less distinctly whorled on the fertile terminal portion of the appendage.	<i>Arthrorhynchus</i>	
50. Antheridial appendages or branches more than one and associated with sterile branches or branchlets.		



- |   |                        |    |
|---|------------------------|----|
| 51. Receptacle appearing to be distally multicellular through proliferation, the resultant cells more or less copiously appendiculate.  |                        | 58 |
| 52. A primary appendage of superposed cells bearing specialized antheridial branchlets superposed externally, similar branches arising from cells on one side, about the bases of the perithecial stalk-cells.                | <b>Idiomyceteæ</b>     |    |
|   | <i>Idiomycetes</i>     | 53 |
| 53. No primary appendage distinguishable at maturity.   |                        |    |
| 54. Receptacle obconical, the proliferous cells producing distally a dense tuft of appendages enveloping the bases of the perithecial stalk-cells.  | <b>Teratomyceæ</b>     | 57 |
| 55. Sterile branches few, antheridial cells intercalary in continuous series.   | <i>Symplectromyces</i> | 56 |
| 56. Sterile branches and branchlets copious, antheridial cells free, externally superposed in irregular series on the lower segments of the appendages and associated with beak-like sterile cells.                           | <i>Teratomyces</i>     | 57 |
| 57. Receptacle subtriangular, flattened, with paired, two-celled rounded outgrowths and paired perithecia, proliferating cells above their bases producing numerous branched appendages.                                      | <i>Diplomyces</i>      |    |
| 58. Receptacle consisting of two superposed cells, the upper giving rise directly to a more or less well distinguished free main appendage and to one or more free, stalked perithecia.                                       |                        | 68 |
| 59. Antheridial branches producing serial intercalary antheridia.   | <b>Corethromyceteæ</b> |    |
| 60. Primary appendage hyaline producing branches from its basal cell, secondary perithecia originating like the primary.  | <i>Rhadinomyces</i>    | 61 |
| 61. Primary appendage more or less blackened, its basal cell producing secondary perithecia when these occur.   | <i>Corethromyces</i>   |    |
| 62. Antheridia borne free, singly, or in groups, on the appendage, or on its branches.  | <b>Laboulbeniæ</b>     |    |
| 63. Main axis of the appendage consisting of two superposed cells, the upper bearing a series of branches from the bases of which arise branchlets bearing the antheridia singly or in groups.                                | <i>Eucorethromyces</i> | 64 |
| 64. Appendage consisting of several superposed cells, the distal bearing sterile branches, the basal often perithecia, the rest short antheridial branchlets from their upper inner angles.                                   | <i>Stichomyces</i>     | 65 |
| 65. Appendage of numerous superposed cells, the basal free sterile and specially modified, the rest bearing a series of branches superposed externally, the basal cells of which give rise to antheridia singly or in groups. | <i>Rhizomyces</i>      | 66 |
| 66. Appendage of superposed cells, the basal adnate, sterile unmodified, the rest appendiculate on the inner side, the branchlets bearing antheridia more or less irregularly.  | <i>Sphaleromyces</i>   | 67 |
| 67. Appendage two-celled, the distal cell a blackened insertion-cell bearing sterile and antheridial branchlets.  | <i>Ceraiomycetes</i>   |    |
| 68. Receptacle multicellular, the cells subbiseriate above the subbasal cell, the one series terminated by the perithecium, the other by the appendages.  | <i>Laboulbenia</i>     |    |
| 69. Receptacle producing one or more free secondary perithecial axes.   |                        |    |



70. Primary axis displaced by a single simple more or less elongate multicellular chaetophorous secondary axis, bearing a subterminal perithecium.	<b>Rhachomyceteæ</b>	
	<i>Rhachomyces</i>	71
71. Receptacle a biseriate-multicellular perithecigerous axis, producing laterally similar perithecigerous axes.	<b>Clematomyceæ</b>	
	<i>Clematomyces</i>	72
72. Perithecigerous axes unicellular and distally appendiculate below the perithecial stalk-cell.	<b>Compsomyceteæ</b>	
73. Individuals solitary with subverticillate fertile and sterile branches from a primary two-celled receptacle.	<i>Compsomyces</i>	74
74. Individuals in a dense tuft, with a common intrusive cellular haustorium.	<i>Moschomyces</i>	
75. Receptacle indeterminate or elongating by secondary cell-division.		79
76. Primary appendage a well defined axis of superposed cells (see also 84).		
77. Receptacle and primary appendage forming a bristle-like coincident axis of superposed cells, bearing branches, perithecia and further branches in a unilateral series and in the order mentioned.	<b>Chæatomyceæ</b>	
	<i>Chæatomyces</i>	78
78. Receptacle very variable through secondary growth, producing no branches below the perithecium.	<b>Ecteinomyceteæ</b>	
	<i>Ecteinomyces</i>	
79. Primary appendage a rounded cellular prominence beside the perithecium, with evanescent terminal branchlets ( <i>incertæ sedis</i> ).	<b>Misgomyceteæ</b>	
	<i>Misgomyces</i>	
80. Antheridia more or less undifferentiated cells of the appendages or of their branches. Mostly aquatic.	<b>CERATOMYCETINEÆ</b>	
81. Receptacle not a massive multicellular structure.		90
82. Receptacle bearing no appendages below the perithecium.	<b>Ceratomyceteæ</b>	89
83. Receptacle indeterminate.		86
84. Perithecium determinate, the wall-rows few-celled.	<i>Hydrophilomyces</i>	85
85. Perithecium indeterminate, the wall-rows many-celled.	<i>Rhynchophoromyces</i>	
86. Receptacle determinate.		
87. Perithecium determinate, wall-rows few-celled.	<i>Autoicomycetes</i>	88
88. Perithecium indeterminate, wall-rows many-celled.	<i>Ceratomyces</i>	
89. Receptacle bearing appendages from specially differentiated cells below the perithecium.	<b>Coreomyceteæ</b>	
	<i>Coreomyces</i>	
90. Receptacle a massive multicellular structure.	<b>Zodiomyceteæ</b>	
91. Receptacle distally cup-shaped, a ciliate margin surrounding numerous perithecia.	<i>Zodiomyces</i>	92
92. Receptacle a massive axis continuous with a terminal appendiculate primary appendage and bearing numerous perithecia and appendages in a crowded lateral series.	<i>Euzodiomyces</i>	93
93. Receptacle a massive axis continuous with a terminal appendiculate primary appendage, consisting of numerous superposed tiers, the upper of which grow out laterally on either side to form perithecigerous branches of numerous superposed cells.	<i>Kainomyces</i>	



## LABOULBENIINEÆ.

Antheridia consisting of specially differentiated cells or group of cells.

## PEYRITSCHIELLACEÆ.

Genera monœcious or diœcious, the antheridia "compound," the antheridial cells originally and at maturity (except in *Distichomyces*) opening into a common cavity whence they discharge their sperm-cells through a common pore.

## DIMORPHOMYCES Thaxter.

This well marked diœcious genus was founded on two New England species, *D. infectus* and *D. denticulatus*, and as far as these species are concerned I have nothing to add to my original account except to mention that *D. infectus* has been observed on a *Falagria* sent me from Ohio. Both species are no doubt as common elsewhere as they are in New England. The present addition of two species is, in all probability, no reliable index of the numerical importance of the genus, since the hosts appear to be neglected by collectors and are not well represented in the collections examined. The plants themselves, too, are very minute, pale in color, and visible with great difficulty on dried hosts.

In comparing the structure of these forms with that which is characteristic of the simpler types of the family, it is evident that there is a close correspondence in essentials. The primary receptacle in both sexes consists of the usual basal and subbasal cells, and its axis is terminated by a simple primary appendage of two or three superposed cells. The male, except in abnormal individuals which rarely occur, produces a single antheridium which arises directly from the subbasal cell. In the female, however, the conditions are much more complicated, since the perithecia arise from lateral branches, "secondary receptacles," derived from the subbasal cell, which are bordered below by an extension or outgrowth of the basal cell that keeps pace with the development of the secondary receptacle. In the two species originally described two of these receptacles arise, one on either side, which are more or less symmetrical. In the two herewith illustrated, however, but one such receptacle is produced and the individuals are asymmetrical in consequence. The cell relations are clearly seen in *D. Myrmedoniæ*, Plate XXVIII, fig. 15, in which the actual conditions are more readily made out than in the species first described. A reexamination of the latter leaves no doubt as to the essential correspondence of their structure.

As far as I have observed, the sexes are always associated in the spore-pairs in this genus, although, as in other diœcious forms, instances may occur in which they fail to be juxtaposed at the point of attachment to the host.

DIMORPHOMYCES MYRMEDONIÆ Thaxter. Plate XXVIII, figs. 14–16.

Proc. Am. Acad. Arts. and Sci., Vol. XXXV, p. 409. Apr., 1900.

*Male individual* tinged with smoky brown, relatively small and stout, the neck of the antheridium short, the primary appendage consisting of three superposed cells, the middle one distinguished by slight constrictions and by dark septa, especially below; the terminal one bluntly rounded distally, twice as long as broad; the thick walls above becoming disorganized. Total length to tip of antheridium, including foot, 65  $\mu$ ; to tip of appendage 40  $\mu$ . Antheridium 38  $\mu$  in length, the center 25  $\times$  14  $\mu$ .

*Female individual* relatively large, tinged with smoky brown, the primary appendage consisting of three cells; the fertile secondary receptacle developed, almost at right angles to the primary axis,



on one side only, and consisting of from five to twelve cells. Perithecia one to five in number, the appendages from three to six, alternating with them, or succeeding one another somewhat irregularly; the two series, perithecia and appendages, somewhat divergent; the subtending cells relatively large and obliquely placed with reference to the bordering extension of the basal cell, so that they appear larger from one side than from the other. Perithecium rather long and slender, nearly straight, stouter and somewhat inflated in small individuals; the tip blunt or nearly truncate, tinged with smoky brown; borne on a short inconspicuous stalk-cell from which it bends abruptly upward. Appendages relatively large, consisting of two superposed cells, constricted at the septa; the basal one longer, distally more deeply suffused; the upper distally suffused, and modified like the corresponding portion of the primary appendage. Spores about  $20 \times 3 \mu$ . Perithecia, in well developed individuals,  $100 \times 18 \mu$ . Primary receptacle about  $60 \mu$ . Secondary receptacle (larger)  $75 \mu$ . Appendages about  $58 \times 13 \mu$ .

On *Myrmedonia flavicornis* Fauv., Brit. Mus. (Biologia C.) No. 766, Guatemala.

This singular looking plant was found on various parts of the host, especially on the abdomen, and shows considerable variation in the development of the secondary receptacle especially, small forms occurring with a single perithecium only. The accompanying figures represent the most highly developed individuals, and show the tendency to degeneration which affects the tips of both primary and secondary appendages.

#### DIMORPHOMYCES THLEOPORÆ Thaxter. Plate XXVIII, figs. 12-13.

Proc. Am. Acad. Arts and Sci., Vol. XXXV, p. 410. Apr., 1900.

*Male individual* much as in *D. muticus*, the primary appendage ending in a short blackened cell, bluntly rounded or nearly truncate. Total length to tip of antheridium  $66 \mu$ , to tip of sterile cell  $37 \mu$ .

*Female individual.* Structure of the receptacle like that of the other species, but only developed on one side of the median sterile portion, or primary appendage, which consists of three cells like that of the male individual and is black tipped. The appendages and perithecia arising as in the other species, the latter nearly symmetrically subfusiform, bluntly rounded at the tip, tinged with smoky brown, the tip undifferentiated, the appendages relatively large and simple. Perithecia (not quite mature)  $50 \times 14 \mu$ . Foot, to end of lateral portion,  $50 \mu$ . Total length to tip of perithecium  $80 \mu$ .

On *Thleopora corticalis* Gz., Paris Museum, No. 297, Santa Anna, Madeira. On inferior surface of abdomen.

The material of this species is very scanty and it is impossible to determine the exact appearance of the male individual, since a single specimen, only, is present in the preparations, placed as is shown in fig. 12 at the right. The species is closely allied to the preceding, but differs in the form of the perithecium, as well as in that of the primary and secondary appendages, the disorganization at the tips of the latter causing them to appear truncate.

#### DIMEROMYCES Thaxter.

Eight additional forms of this very peculiar dioecious genus show that, although it is extremely well defined in general, the species present remarkable variations in structure, and, with the exception of *Laboulbenia*, inhabit more diverse hosts than the members of any other genus. With the exception of *Herpomycetes*, no other genus has been found on Orthoptera, and three East Indian forms occur on small species of Diptera. Two of these dipterophilous forms, *D. coarctatus* and *D. rhizophorus*, which are very closely allied, are of especial interest; since, although both occur on the integument of the inferior surface of the abdomen of their soft bodied hosts, and thus live under practically identical conditions, the one absorbs its nutriment by a well developed haustorium which penetrates the body-cavity, Plate XXVIII, fig. 7, while the other, fig. 1, is attached by the usual foot and shows no sign of any penetration. It is not improbable that the members of this genus will prove characteristic parasites on *Forficulæ* generally, as are the species of *Herpomycetes* on *Blattidæ*.



Of *D. Africanus*, illustrated in my Monograph, I have examined additional material from Cape Coast Castle, Africa, on *Pachyteles*, in the Hope Collection No. 287.

DIMEROMYCES MINUTISSIMUS Thaxter. Plate XXIX, figs. 6-9.

Proc. Am. Acad. Arts and Sci., Vol. XLI, p. 304. July, 1905.

*Male individual.* Receptacle consisting of three cells, the basal externally suffused with blackish brown, and projecting beneath the base of the antheridium; the subbasal giving rise to the solitary antheridium; while the distal is separated by a blackened septum from a two-celled erect rigid distally spinose appendage. Venter of antheridium small, tapering gradually to the stout outcurved neck. Total length, including foot,  $32\ \mu$ . Antheridium  $16 \times 5\ \mu$ .

*Female individual.* Receptacle very irregularly formed, externally blackened above the large foot; consisting of several irregularly superposed cells, the subbasal giving rise to a two-celled prominence subtending a blackish tapering appendage, which projects at right angles to the colorless primary appendage; the latter two-celled, distinguished by a blackish septum, and often subtended by a similar appendage from the same (distal) cell of the receptacle. The single perithecium rather short and broad, tapering slightly to the more or less distinctly differentiated somewhat truncate tip. Length to tip of perithecium  $50\ \mu$ . Longest appendage  $40-50\ \mu$ . Perithecium  $34 \times 10\ \mu$ .

On the inferior surface of the rhabdites of *Labia minor* Burm., Cambridge, Mass.

This and the preceding species may prove merely variations of the same form due to the differences in their position of growth, and are only provisionally separated. *M. Labiæ* is much less common than the present species and has only been seen on the elytra. *M. minutissimus* occurs not uncommonly on the rhabdites, but is very difficult to find and to remove, from its minute size, dark color and appressed habit of growth. Both species are most nearly allied to *M. Forficulæ*, although abundantly distinct from it.

DIMEROMYCES LABIÆ Thaxter. Plate XXIX, figs. 1-5.

Proc. Am. Acad. Arts and Sci., Vol. LXI, p. 303. July, 1905.

*Male individual.* Receptacle consisting normally of three superposed cells, the basal projecting laterally to form the base of the lowest antheridium, bearing distally a two-celled appendage distinguished by a basal blackish septum; the two upper cells of the receptacle producing two, rarely three, antheridia: the latter short and stout, the efferent region containing the several tubes rather abruptly distinguished from the venter, as well as from the common efferent tube, which curves outward somewhat abruptly. Total length to tip of appendage, including foot,  $50\ \mu$ . Appendage  $25\ \mu$ . Antheridium  $16-18 \times 6-7\ \mu$ .

*Female individual.* Subhyaline, or straw-colored, consisting of an irregular axis of three or four superposed cells, terminated by a simple, usually two-celled, appendage distinguished by a blackish septum; the subbasal cell bearing a broad blunt bicellular upcurved appendage or protrusion, which subtends either the single perithecium, or a several-celled appendage similar to the primary one. Perithecium solitary, colorless, somewhat elongate, tapering but slightly to the more or less abruptly distinguished rather broad somewhat flattened tip. Total length of tip of perithecium  $65-75\ \mu$ . Perithecium  $50-60 \times 12\ \mu$ . Spores about  $18 \times 12\ \mu$ .

On the elytra of *Labia minor* Burm., Cambridge, Mass.

As has been already mentioned, this species is very closely related to *D. minutissimus* of which it may prove a mere variety due to its position of growth. The material is not abundant, but the differences indicated in the figures and descriptions appear to be constant, even the greater number of antheridia in the male individuals. The host is a small *Forficula* common in refuse, especially in the Fresh Pond region.

DIMEROMYCES FORFICULÆ Thaxter. Plate XXVIII, figs. 9-11.

Proc. Am. Acad. Arts and Sci., Vol. XXXVIII, p. 9. June, 1902.

*Male individual.* Receptacle consisting of three superposed cells, the upper distinguished by a



well-defined black septum from a short two- to three-celled terminal appendage, the subbasal septum of which is also blackened; the subbasal cell of the receptacle producing a suberect, short-stalked, rather long and narrow antheridium; the neck relatively broad, blunt, about as long as the stalk and venter. Total length to tip of antheridium  $60\ \mu$ : the antheridium, including stalk,  $28-30 \times 7-8\ \mu$ .

*Female individual* more or less tinged with purplish-brown, especially the body of the perithecium. Receptacle consisting of usually five cells obliquely superposed, with the exception of the uppermost, successively smaller from below upward, the series more or less strongly curved outward from the male; the subbasal cell bearing a simple differentiated appendage, its basal cell more or less geniculate and separated from the basally inflated, tapering, brown, five- to six-celled distal portion by a blackish constriction; the cell next above it producing the single perithecium; the next a simple cylindrical slightly tapering appendage with a black subbasal constricted septum; the terminal cell bearing terminally a short, simple, few-celled primary appendage, distinguished by a constricted black basal and a pale subbasal septum, and laterally a similar appendage distinguished by a subbasal blackish constricted septum. Perithecium rather elongate, subclavate or subfusoid, the stalk not distinguished from the body of the perithecium, and sometimes showing irregular septa; the tip often somewhat abruptly distinguished, blunt, slightly asymmetrical. Spores about  $35 \times 3.5\ \mu$ . Perithecia, including stalk,  $90-110 \times 18-22\ \mu$ . Longest appendage  $80\ \mu$ . Receptacle  $60-70\ \mu$ . Total length to tip of perithecium  $150-185\ \mu$ .

On all parts of *Forficula tæniata* Dohrn.; Mus. Comp. Zoöl., No. 1355; Guatemala.

A species most nearly related to the other forms on earwigs, but clearly distinguished by numerous points of difference in both sexes.

DIMEROMYCES RHIZOPHORUS Thaxter. Plate XXVIII, Figs. 6-8.

Proc. Am. Acad. Arts and Sci., Vol. XXXVI, p. 412. March, 1901.

*Male Individual.* Receptacle consisting of a basal cell, which penetrates the host directly without a differentiated foot by means of a simple rhizoid, and of two to three superposed cells above it, each of which usually bears an antheridium, the upper terminated by a short, pointed, slender cell. The antheridia rather short and stout, with short, stout necks. Receptacle about  $50 \times 8\ \mu$ . Appendage  $12 \times 3.5\ \mu$ . Antheridia  $25 \times 9\ \mu$ .

*Female Individual.* More or less deeply tinged with amber-brown. Receptacle amber-brown, consisting of six superposed cells, the small basal cell, hardly visible above the integument, penetrates the host directly by means of a very large, abruptly furcate rhizoid, the two cells above it similar, broader than long, bearing each an appendage consisting of a basal cell bent toward the receptacle, darker and narrower distally, and separated by a dark septum from the three-celled terminal portion, which is straight or slightly curved, larger toward the middle, the smaller terminal cell becoming partly disorganized. The next (fourth) cell of the receptacle bears the single perithecium; the distal terminal cell longer and narrower, and terminated by a short, pointed, one- sometimes two-celled primary appendage (similar to that of the male individual), from which it is separated by a constriction; the subterminal cell narrower distally, producing on its inner side an appendage similar to those below it, but straight and somewhat shorter. Perithecium with a short stout stalk rapidly expanding into the asymmetrically inflated deeper brown venter of the perithecium; the neck very short and abruptly distinguished; the tip relatively large, four-lobed, inflated with two lateral papillate outgrowths, above which the lips form a subconical projection. Spores about  $25 \times 3\ \mu$ . Perithecium including stalk  $70-90 \times 20-25\ \mu$ . Receptacle about  $45 \times 12\ \mu$ . Primary appendage  $12\ \mu$ ; secondary appendages  $35-40\ \mu$ . Penetrating rhizoidal branches  $150-184 \times 10-12\ \mu$ . Total length to tip of perithecium  $90-110\ \mu$ .

On the inferior surface of the abdomen of a small fly. Ralum, New Pomerania. Berlin Museum, No. 1295.

This form is distinguished from all other described species of the genus by the presence of penetrating rhizoids which replace the normal blackened foot. In the female they appear to be regularly once furcate



immediately below the integument, the two branches diverging so that the individual cannot be detached without breaking one or both of them. The male, however, develops merely the simple rhizoid, shown in fig. 8, a slight swelling immediately below the integument serving to hold it with sufficient firmness.

*DIMEROMYCES COARCTATUS* Thaxter. Plate XXVIII, Figs. 1-5 and 17.

Proc. Am. Acad. Arts and Sci., Vol. XXXVI, p. 410. March, 1901.

*Male Individual.* Receptacle nearly hyaline, consisting of usually three superposed cells, the upper separated by a dark-colored constriction from a short, simple, two- to three-celled hyaline or brownish appendage. The antheridia usually two, seldom three, borne singly from the successive cells of the receptacle, from which they are separated by a small basal cell; the venter having an external depression and not abruptly distinguished from the stout curved neck. Receptacle  $35-45 \times 6-7 \mu$ . Appendage  $25-50 \mu$ . Antheridia  $18 \times 5 \mu$ .

*Female Individual.* Receptacle consisting of a large basal cell about twice as long as broad, bulging so as to form a rounded base which pushes the small brownish-black foot to a lateral or sublateral position; the remaining cells, usually eight or nine in number, separated by horizontal septa and superposed in a simple series; the lower cells greatly flattened, those above somewhat less so, the series ending in a somewhat abruptly narrower terminal cell, which is more than twice as long as broad, subcylindrical, its extremity rounded symmetrically and bearing a short, simple, usually four-celled terminal brownish appendage, which is distinguished by a constricted dark basal septum, and terminated by a somewhat inflated lighter larger cell, which becomes characteristically disorganized on one side, so that the appendage appears to end in a slender curved projection. The remaining cells of the receptacle producing single appendages or perithecia, except the basal and sometimes a subbasal cell. The uppermost of these secondary appendages arises from the inner side of the subconical subterminal cell of the receptacle, occupying a position in the median line between the primary appendage and the base of the first perithecium, and consists of a short subconical basal cell, from the narrow extremity of which the simple, several-celled terminal portion is distinguished by a constricted dark septum; the remaining appendages laterally divergent on opposite sides in such a way as to appear paired, usually three on each side, each consisting of a rather long basal cell inflated along its upper side so as to appear more or less geniculate, concolorous with the receptacle, its narrower extremity suffused with dark brown, distinguished without constriction by a dark septum from the simple terminal portion, which is usually five-celled, more or less strongly recurved, brown, its terminal cell becoming inflated and undergoing gelatinous degeneration on the lower side, which causes it to appear split in two, the hook-like upper half of the cell alone persisting in some individuals. Perithecia yellowish, distally brownish, one, rarely two, in number; the first always arising from the cell immediately below that which bears the upper secondary appendage, the second, when one is present, replacing one of the appendages lower down; consisting of a symmetrically inflated venter, which tapers gradually downward, passing into the short stalk; a short neck rather abruptly distinguished, deeper brown below, its tip inflated below four terminal projections, three or two of which are in the form of rounded papillæ of unequal size, and one or two of which are pointed and much more prominent. Spores  $42 \times 3.5 \mu$ . Perithecium, including the stalk, which is continuous with it,  $125 \times 20-35 \mu$ . Receptacle to base of primary appendage  $50-75 \mu$ . Secondary appendages about  $75 \mu$ . Total length to tip of perithecium  $150-180 \mu$ .

Densely crowded on the inferior surface of the abdomen or rarely on the legs of a small pale fly. Ralum, New Pomerania. Berlin Museum, No. 1282.

Abundant material of this species has been examined and although it grows on the soft inferior abdominal integument of a similar host and in the same position, it shows no tendency to develop the haustoria which are so characteristic of the preceding species. The two are very closely allied, nevertheless, the form and disposition of the appendages, which project something like the legs of a crustacean, affording the most striking points of difference. The individuals usually occur crowded in large num-



bers on the abdomen of the host, and eventually are very evidently injurious in their effects, causing the abdomen to become brown and more or less shriveled. I know of no other instance in which an evident injury results from the parasitism of any member of the group. In both species the sexes are apt to become separated or irregularly disposed, although their occurrence in pairs is a normal condition.

DIMEROMYCES CRISPATUS Thaxter. Plate XXIX, Figs. 14-15.

Proc. Am. Acad. Arts and Sci., Vol. XXXVI, p. 413. March, 1901.

*Male Individual.* Receptacle consisting of four superposed hyaline cells, the basal one much longer than the rest combined; the upper bearing distally a two-celled terminal appendage, the lower cell of which is small, the upper elongate, brownish; the two remaining cells of the receptacle producing each a single antheridium. Antheridia superposed, the stalk-cell, neck, and venter well distinguished, the latter symmetrically and considerably inflated, the neck slightly curved. Receptacle  $50 \times 8 \mu$ . Antheridia  $33 \times 8-9 \mu$ . Appendage  $36 \mu$ .

*Female Individual.* Receptacle consisting of usually five superposed cells, the basal cell very elongate, slender, and hyaline; while of the four remaining cells the two lower are much flattened, broader than long, and separated by oblique septa, the two upper unlike and narrower. Of these four cells the second from below gives rise to the stalk-cell of the perithecium, while the others by successive proliferation produce each a branch consisting of eight or ten obliquely superposed cells; while each of these cells in turn produces a single simple branchlet from its upper side, originally terminal, but becoming lateral through the further proliferation of the cell which bears it; the branchlets distinguished by a slight constriction and a broad dark septum at the base, brown, curved, distally helicoid, slightly enlarged and paler. The primary terminal appendage thus appears as the lowest of the upper series of branchlets, from which it does not differ in structure. Perithecia one to three in number, the first lowest, and always formed from the second from below of the four distal cells of the receptacle, others sometimes arising from each of the two upper distal cells; the stalk hyaline, long and slender, the venter small, narrow, not distinguished from the stalk, becoming brownish, distally slightly inflated, the neck short and well but not abruptly distinguished; the tip well differentiated, hyaline, symmetrical or nearly so, shovel-shaped or spathulate, swollen at its base, and tapering to the broad, bluntly rounded or nearly truncate apex. Spores about  $30 \times 3.5 \mu$ . Perithecium:  $70-75 \times 18 \mu$ , the stalk  $50-125 \times 15 \mu$ . Receptacle basal cell  $185-250 \times 18 \mu$ , the distal portion about  $50 \mu$ . Total length to tip of perithecium  $360-435 \mu$ . Lateral cell-series or branches about  $50 \mu$  long, their branchlets to tip of helix about  $50 \mu$ .

On the legs and superior surface of the abdomen of the same host parasitized by *D. coarctatus*. Ralum, New Pomerania. Berlin Museum, No. 1282.

This species occurred very rarely and always in solitary pairs on various parts of the host, no instance being observed in which a male failed to develop at the base of the female. It is more highly differentiated than any of the other species in that the upper cells of the receptacle proliferate to form several appendiculate branches. The species is further well distinguished by its curled appendages, elongate basal cell, and peculiar long-stalked perithecia.

DIMEROMYCES NANOMASCULUS Thaxter. Plate XXIX, Figs. 10-13.

Proc. Am. Acad. Arts and Sci., Vol. XXXV, p. 411. April, 1900.

*Male individual* very minute, consisting of three superposed cells, the upper bearing a terminal two-celled appendage with dark septa, the subbasal cell giving rise to a single small antheridium, the neck usually abruptly turned to one side. Total length to tip of appendage  $35 \mu$ ; the antheridium about  $15 \times 5 \mu$ .

*Female individual* consisting of a main axis of superposed cells from which appendiculate cells are separated on both sides, the basal cell large and long, narrower below; the cells above about ten to fifteen in number, usually roundish; the appendages borne side by side in pairs on both sides of the receptacle, mostly five-celled above their basal cells, sometimes curved or almost hooked distally, variably



suffused with brown, the septa dark, the distal cell not conspicuously enlarged, becoming brownish; the subterminal cell of the single terminal appendage examined, producing a blackish-brown, lateral, irregular, spine-like outgrowth. Perithecium straight, more commonly solitary brownish yellow to dark brown near the tip, not at all distinguished from the stalk, which is hyaline only at its narrow base, the hyaline tip abruptly distinguished by a slight subtending ridge, its margins usually converging symmetrically to the truncate, or blunt apex. Spores about  $45 \times 3 \mu$ . Perithecia, including stalk,  $100-120 \times 20-24 \mu$ . Appendages longer  $60 \times 6 \mu$ . Total length to tip of perithecium  $245-285 \times$  about  $22 \mu$ .

On *Ardistomis viridis* Say, Coconut Grove, Florida. November. On *A. educta* Bates, British Museum (Biologia Collection), No. 676.

The carabid hosts on which this form was found were collected under coconut palms along the margin of Biscayne Bay. The species was seldom met with, and the male and female were associated in every case; although, from the very minute size of the former, it is difficult to distinguish and successfully remove it. The appendages are so closely approximated in pairs that they appear at first sight to form a single row, only, on either side; and the presence of a second set below can only be determined by very careful examination. Both this and the succeeding species represent a section of the genus marked by a highly developed erect central axis, which results from intercalary growth, new cells being added apparently as a result of the activities of the basal cell.

DIMEROMYCES PINNATUS Thaxter. Plate XXIX, Figs. 16-18.

Proc. Am. Acad. Arts and Sci., Vol. XXXV, p. 410. April, 1900.

*Male individual* consisting of a basal cell more than twice as long as broad, the axis above of eight or nine cells separated by horizontal septa, all but the lowest and the terminal cell separating a small cell on one side which forms the base of an antheridium or of a sterile appendage, the two organs diverging slightly from one another so as to form two vertical rows. Antheridium compound, short and stout, the venter abruptly distinguished from the stout neck, the base of which is slightly enlarged and purplish brown, the distal part tapering very slightly, the apex blunt. Appendages consisting typically of six cells, including the basal cell, constricted at the dark septa, the distal cells suffused with brownish, the terminal one larger, longer, and more or less vesicular, the thick walls tending to gelatinous degeneration. Total length of receptacle  $100 \times 12 \mu$ . Antheridia  $35 \times 12 \mu$ . Appendages  $50 \times 7 \mu$ .

*Female individual.* Basal cell large and stout, the cells above it about twenty in number, greatly flattened, the septa horizontal, a few of the lower cells having appendages on only one side, or none, the rest bearing them on both sides. Appendages simple, consisting of from five to seven cells including the basal cell, constricted at the dark septa, the terminal cell hyaline and much larger, as in the male; the rest, except the basal one, purplish, or the upper one tinged with brown. Perithecia one to three in number, mostly rather slender, slightly curved outward; the stalk-portion about half as long as the remainder, which is purplish brown, deeper distally; the tip well distinguished when not distended by spores, consisting of a basal portion larger and slightly inflated, and a distal one formed by the lip-cells, abruptly distinguished, its external margins generally symmetrically divergent, the four cells nearly equal and symmetrical and ending distally in a corresponding number of papillæ about the pore. Perithecia including stalk,  $125 \times 20 \mu$ . Receptacle  $190-225 \times 28 \mu$ , not including basal cells of appendages. Appendages  $55 \times 8 \mu$ .

On *Ardistomis* (?) sp., Hope Collection, No. 296. No locality, but probably Mexico or South America. At base of elytra and on leg.

The determination of the host of this species is uncertain, but the insect is at least allied to *Ardistomis*. The parasite is very peculiar and striking in appearance, and although closely allied to the preceding species, differs markedly in the characters of the male, as well as in the arrangement and appearance of the appendages and perithecia. Specimens occurring on the leg of the host (fig. 17), differ decidedly



in the form of the appendages and perithecia, the former being longer and more slender, with more numerous septa, and the latter lacking the subterminal elevation, a condition which may, however, be due to immaturity.

#### RICKIA Cavara.

Receptacle consisting of a single basal cell surmounted by a cellular portion, the cells of which are arranged in general in three vertical series: a *posterior* series each cell of which may cut off externally one or two small cells bearing secondary sterile appendages or antheridia, and which is terminated by a single primary appendage borne on a two-celled base: an *anterior* series similar to the posterior, but terminating in a perithecium, and a *median* series ending opposite the base of the primary appendage and extending downward to the basal cells of the other two series. Antheridia irregularly disposed, the numbers varying in different individuals, wholly free, subtended by a blackened septum, flask-shaped, compound. Appendages as in *Peyritschiella*. Perithecium normally solitary.

This genus, which bears a superficial resemblance to *Peyritschiella*, is clearly distinguished by its free compound antheridia which, in general form and appearance, so closely resemble simple antheridia that they were so described by Cavara. Stained preparations, however, show clearly that the antheridium consists of a basal cell, immediately above the blackened septum, and that from this basal cell a small number of antheridial cells arise, discharging together through the common neck. The antheridial cells are very small, and I have been unable to make out their disposition more exactly than is shown in Plate XXXIV, figs. 12 and 13. The structure and development of the receptacle is peculiar and in the material examined, which was obtained partly through the courtesy of Prof. Cavara and partly from the specimens distributed by Rehm, does not correspond to the figures which accompany the original description in Malpighia. The basal cell constitutes a stalk-cell, which may rarely be once-septate, as in fig. 8; but is usually single. Above this, in the youngest individuals (fig. 1), a subbasal cell is distinguished; above this two small superposed cells (fig. 4 w), one of which may be exceptionally absent, form the base of a terminal simple primary appendage (fig. 4 v), distinguished by the usual blackened septum. This appendage, with its two basal cells, develops no further, and is carried upward, without change of form or structure, by the further growth of the receptacle, which results wholly from the activities of the subbasal cell and its products. In the next stage, the subbasal cell is divided by an oblique septum, connecting its two opposite angles. The two cells thus formed may be conveniently distinguished as anterior (on the perithecial side) and posterior. In the third stage (fig. 2) the conditions are similar to those of the second, except that the posterior cell (at the right of y) has become divided to an upper (o) and a lower (z) cell by a transverse septum. The lower of these two cells (fig. 3 z), then begins to grow outward distally, to form later the first secondary appendage, which may or may not be associated with a first antheridium as in fig. 11, at right. In the next stage (fig. 4), the upper (o) of the two cells which have resulted from the division of the posterior cell, divides into two cells by a longitudinal septum and the remainder of the receptacle results from the activity of these two cells together with that of the original anterior cell (y) at the right in fig. 4, which has, as yet, only elongated. Of these three cells, the anterior (y) produces the anterior, or perithecial series of the receptacle, with its secondary appendages and antheridia; the posterior (x) produces the posterior series with its antheridia and secondary appendages; while the middle cell produces the middle or axial series. The further development of these series will be made sufficiently clear by an examination of the successive figures, if it is remembered that figs. 1, 3, 4, 7 and 10 are drawn with the anterior side at the right; while in the remaining figures it lies at the left. The activity of the three cells just referred to, (x) and (y), with the cell lying between them in fig. 4, results from the separation of a terminal cell from each, which, acting as a scheidel-cell, continues to cut off cells below, which, in the anterior and posterior series, become secondarily divided to produce the small cells on which the antheridia and secondary appendages are inserted. While the anterior and posterior series are morphologically branches, and their growth a terminal growth, the central axis is



strictly intercalary in its origin, and its development may be compared to the trichothallic growth of certain algae.

Although from his observations on the relation of this parasite to its host, Cavara appears to be inclined to regard the Laboulbeniales generally as saprophytes, the occurrence of a number of rhizoidal forms seems to render it quite certain that they feed on the juices of the insect which in this, as in a majority of cases, are absorbed, without penetration, through the sucker-like foot.

The genus is closely allied to the succeeding one, from which it differs especially in the possession of an antheridium which is compound at maturity.

RICKIA WASMANNI Cavara. Plate XXXIV, figs. 1-13.

Cavara: Malpighia, Vol. XIII, p. 182, Pl. VI, 1899. Thaxter: Proc. Am. Acad. Arts and Sci., Vol. XXXVIII, p. 39. Rick: Oester. Bot. Zeitschr., April, 1903, p. 163, with figure. Exsic., Rehm Ascomyceten, No. 1451.

Basal cell about as long as, or longer than, the rest of the receptacle; the axial series of cells, extending to a point nearly opposite the middle of the perithecium; consisting of about six cells, more or less; its lowest cell lying above the basal cells of the other two series: the anterior series consisting of from four to five cells, the two lower longer, the lowest only occasionally appendiculate; the posterior series consisting of usually five or six cells, exclusive of the two (rarely single) basal cells of the primary appendage which terminates this series. The members of both the anterior and posterior series, with the usual exception of the basal cell of the anterior series, cutting off a smaller cell distally and externally, which usually cuts off a second small cell; each of these bearing either sterile appendages or antheridia. Antheridia relatively small, flask-shaped, the venters evenly inflated and evenly curved to the narrow necks which are about half as long as the venters. Secondary and primary appendages hyaline, or suffused with brown, simple, mostly inflated, short. Perithecium somewhat asymmetrical, its outer margin and distal half tapering to the somewhat irregular blunt, or truncate, hardly differentiated tip. Perithecium  $40-50 \times 18-22 \mu$ . Spores  $28 \times 2.5 \mu$ . Total length to tip of perithecium, average  $150 \mu$ , maximum  $200 \mu$ . Antheridia about  $12 \times 4 \mu$ .

On all parts of *Myrmeca lævinodes* Nyl. Linz on the Rhine. (Wassmann.)

This species is said to be abundant in the localities where it has been found, parasitizing a majority of the individuals in certain nests of its host. I have thus far been unsuccessful in attempting to find it in this country, where it seems to be replaced by the curious little *Laboulbenia Formicarum*. In exceptional cases, especially when the primary perithecium has been destroyed, or has failed to develop, secondary perithecia may arise from one or more cells of the receptacle below, as is the case in *Peyrit-schiella* and in other genera.

DISTICHOMYCES Thaxter.

Proc. Am. Acad. Arts and Sci., Vol. XLI, p. 308. July, 1905.

Receptacle consisting of a basal and subbasal cell, surmounted by two parallel series of cells of indefinite number, any of which may bear either a sterile appendage, or an antheridium, externally; one of the series ending in a perithecium, the other terminated by the primary appendage. Appendages of the same type as those of *Rickia* and *Peyrit-schiella*. Antheridia at maturity terminal on a unicellular branch, becoming quite free in a compact group.

This genus is distinguished from *Rickia* by its ultimately free antheridial cells which are apparently developed originally as in the typical compound antheridium. The terminal cell which would ordinarily form the common efferent tube being absorbed, or disorganized, so that the antheridial cells appear to be quite free, as in the Laboulbeniineæ, and of the same simple type, closely associated in a compact terminal group. The very early development of the antheridium has not been seen in any of the specimens examined, but the occurrence of a disorganization, like that described, seems clearly indicated by the general appearance of the nearly mature antheridial branch, especially by the ridge which is present



below the antheridia, Plate LXXI, fig. 5. If this interpretation of the conditions is correct, the basal cell, from which, as in other compound antheridia, the antheridial cells arise as endogenous branchlets proliferating into the terminal cell, by its enlargement and elongation pushes the group of antheridia through the terminal cell, which is destroyed during the process. The development of the receptacle is almost exactly that of *Rickia*, except that the cell (o) of fig. 3, Plate XXXIV, is not divided longitudinally, but as a result of transverse divisions, develops, like cell (x) of fig. 4, to form the posterior series of the receptacle, the median series of *Rickia* not developing at all.

The genus has an especial interest as suggesting that the simple antheridium may possibly have arisen from the compound, rather than that the reverse has taken place, and as indicating the method by which this may have been affected. Yet it should not be regarded as in the least proving that the evolution of the antheridium in the family has not in general been from the simple to the compound type.

DISTICHOMYCES LEPTOCHIRI Thaxter. Plate LXXI, figs. 1-6.  
Proc. Am. Acad. Arts and Sci., Vol. XLI, p. 308. July, 1905.

Slender and considerably elongated, or sometimes short and stout: the primary axis consisting of from twelve to thirty cells, more or less, above the subbasal cell of the receptacle, somewhat proliferous distally beyond the base of the primary appendage, the small cells thus formed, one or two of them appendiculate, extending to the free tip of the perithecium; the perithecial axis consisting of from six to twenty-six cells, more or less; the perithecium slightly broader, but not distinguished from the axis, wholly united on its inner side to the primary axis, more or less strongly curved outward to its blunt subtruncate free tip. Appendages as in *Peyritschiella*, hyaline, rather slender, very variably developed, borne on a small triangular cell, separated distally and externally from the cells of the axis; sometimes numerous, often few and scattered, or almost wanting except distally, where all the cells of the primary axis are usually appendiculate. Antheridial branches borne like the sterile branches, irregular in position and number, sometimes even absent, usually confined to the lower half of the axis, more often near the base, consisting of a short stalk-cell bearing terminally a compact erect group of flask-shaped antheridia, usually four or five in number, their short broad necks at first closely approximated or coherent, divergent only after full maturity. Perithecium  $50-55 \times 15-20 \mu$ . Longer sterile appendages  $75 \times 6 \mu$ . Antheridial branch, including antheridia,  $18 \mu$ . Total length, longer  $475 \times 10 \mu$ , shorter and stouter  $125 \times 36 \mu$ . Secondary perithecia may develop from cells of either axis if the primary perithecium does not develop or is destroyed.

On the head, antennæ and under surface of *Leptochirus* sp., Java; Rouyer, No. 1403.

This species shows very considerable variation in its general habit and in the distribution of its appendages and antheridia, as is indicated by the accompanying figures. As usually happens, individuals which occur on the legs, or in other exposed positions, are commonly short and stout; while those on the thorax or abdomen are characteristically elongate. On account of its small size and pale color it is detected with great difficulty.

DICHOMYCES Thaxter.

This genus, of which only three representatives were included in my Monograph, has proved one of the larger genera of the family, including over twenty species of varied habit, although the general type is remarkably constant. The species appear to be very sensitive to unfavorable conditions, and one can usually be sure of finding typically developed individuals only on the body or elytra of the host, those developed on the appendages being, in general, malformed and continually reverting to the *Peyritschiella*-condition; losing the bilateral symmetry of the receptacle, which is constant in well developed individuals of all species, and possessing but a single antheridium. Such a form of *D. inaequalis* was formerly described as a new species of *Peyritschiella*, *P. nigrescens*, but is undoubtedly a reversion of this nature. Since *Dichomyces* must be considered merely as an elaboration of *Peyritschiella*, this re-



version to a more primitive structure may be compared, perhaps, to the reversions due to wounds or injuries so often seen in the higher plants. Despite this very common occurrence of *Peyritschiella*-forms in probably all the species of *Dichomyces*, I consider the genus well distinguished by its normally symmetrical receptacle and paired antheridia, this condition occurring in *Peyritschiella* only in exceptional individuals if at all.

The most striking variation which one finds in the species of *Dichomyces* is connected with the presence or absence of the two characteristic "auricles" which surmount the tips of the perithecia in certain cases. Although, the presence or absence of such peculiar structures might well be assumed to indicate a specific difference, it is evident that, in some cases at least, there is a dimorphism in this respect; the auricled form being usually smaller than the other, and even occasionally associated with it on the same individual, as in *D. hybridus*, Plate XXXI, fig. 16. More often, however, as in *D. biformis*, the two are always separated on distinct individuals, as is shown in Plate XXXIII, fig. 1-3. This circumstance renders the separation of the species a matter of considerable difficulty in many cases. For example *D. vulgatus* is an auricled form occurring all over the world on various *Philonthi*, and is associated not infrequently on the same insect with a variety having no auricles. This variety may be almost, if not absolutely, identical in appearance with the typical *D. princeps*, a species which is very common and widely distributed on similar hosts, but which I have not found associated with individuals of an auricled type in its typical condition, although it is not infrequently found covering the host in great numbers. The existence of this dimorphism, however, may render necessary the union of these and possibly other forms, although at the present moment I am inclined to consider them distinct.

The antheridium in this genus, from its position and the usually dark color of the adjacent cells, is not easily examined; but its structure is evidently like that of most compound antheridia; the antheridial cells being seemingly proliferations from a subterminal cell into a terminal cell, which serves as a receptacle for the antherozoids as they are formed, and as a common medium of discharge. These conditions are indicated in a general way in fig. 4, Plate XXXII, but no form has been examined in which more than a very general idea of the cell-arrangement could be obtained.

The species of the genus are confined to hosts belonging to the Staphylinidæ, and are especially common on members of the large genus *Philonthus*, some of them being more or less general parasites on these insects, while others appear to be somewhat definitely restricted in the matter of hosts. That numerous species exist in addition to those below enumerated cannot be doubted.

If one disregards the tendency, above referred to, to revert to a *Peyritschiella*-like condition, the genus is more constant in its characters than almost any other, the only variation of importance being associated with those forms in which the symmetry is lost through the production of a single perithecium, as in *D. Javanus*, Plate XXXII, figs. 1-2. It should be mentioned, however, that in some abnormally developed forms, or where the primary perithecia have aborted through injury or otherwise, secondary perithecia may develop from one or both of the two lower tiers, Plate XXXI, fig. 9, a condition seen occasionally in *Peyritschiella*. As may be seen by an examination of the accompanying Plates, the members of this genus, from their symmetrical form and bizarre outline and coloring, are among the most remarkable and striking members of the group. The scale-like habit and appressed growth are striking illustrations of adjustment to their conditions of life on the surface of swiftly running hosts.

#### DICHOMYCES FURCIFERUS Thaxter.

This species, which may be regarded as the type of the genus, occurs on small *Philonthi*, and is common in New England. Typical specimens were obtained in the British Museum on *P. albipes* Grav. from Tillsgate, England, and from *P. centralis* Sharp, from Las Mercedes, Mexico? Nos. 364 and 752 respectively. It was also found on *P. discoideus* Grav. from Scotland in Dr. Sharp's collection, No. 1212, and it has been obtained in abundance about Fresh Pond, Cambridge. Forms which appear very closely related, if not identical, but varying in minor respects, have also been examined on small *Philonthi* from



Ceylon, British Museum, Nos. 377-378: on *P. rectangulus* Sharp from Japan, Sharp Coll., Nos. 1123 and 1131.

The Scottish and Japanese specimens, as well as many of those from Fresh Pond, were associated with a second form similar in size and general appearance, except that the fork-like projections were less prominent, or undeveloped, and that the perithecia were relatively larger and without the characteristic auricles. This same form without auricles has also been found repeatedly, unaccompanied by the auricled form, on hosts from Fresh Pond, and has also been examined from the following sources: on *P. cinctipennis* Fauv., Sharp Coll., No. 1173; and on *P. discoideus* from the Canaries, British Museum, No. 404; as well as on *Philonthus* sp., No. 493, from Balthazar, Grenada, West Indies. Variations of this simpler form are illustrated in Figs. 10-12, Plate XXXI, and although I was at first inclined to consider it distinct from both *D. furciferus* and *D. Cafianus*, to which it is too closely allied, I have concluded to designate it, provisionally at least, as a variety of the former, in view of the dimorphism which certainly occurs in various other species of the genus. Of the figures in the accompanying plate, fig. 12 represents the largest individual seen, and is taken from the Abyssinian material, while the two others were collected about Fresh Pond. Other variations occur which resemble *D. furciferus* more closely in showing a more marked development of the fork-like projections of the middle tier.

DICHOMYCES BELONUCHI Thaxter. Plate XXXIII, figs. 6-9.  
Proc. Am. Acad. Arts and Sci., Vol. XXXVII, p. 27. June, 1901.

Receptacle relatively large and long: the distal tier relatively small, consisting of from eleven to thirteen short cells, slightly suffused, the median cells little longer than the rest, the series forming slight, rounded, sometimes almost obsolete lateral projections on either side of the perithecia: the basal cell small, partly transparent: the lower and middle tiers not distinguished, uniformly opaque; a portion of the middle cell, and sometimes the tips of other cells in the middle tier, more or less translucent, the marginal cells ending in a light rounded prominence below the base of the antheridium. Perithecia normally two, evenly suffused with pale reddish brown, rather long and slender, tapering throughout, the conformation of the lip-cells much as in *D. furciferus*. Spores about  $30 \times 3 \mu$ . Perithecia  $75-80 \times 18-20 \mu$ . Receptacle  $108-126 \times 54-58 \mu$ . Total length to tips of perithecia  $185-200 \mu$ .

On the abdomen of *Belonuchus fuscipes* Fauvel. New Guinea. Sharp collection, No. 1090.

This species is most nearly allied to *D. furciferus*, from which it is distinguished by its longer more slender perithecia, and the almost complete opacity of the two lower tiers, the middle one producing inconspicuous rounded projections in place of the long fork-like outgrowths characteristic of its ally.

DICHOMYCES VULGATUS Thaxter. Plate XXXI, figs. 5-9.  
Proc. Am. Acad. Arts and Sci., Vol. XXXV, p. 424. April, 1900.

Receptacle variable, typically short and stout, the basal cell small squarish hyaline; the lower tier externally opaque, except the whole or the middle of the median cell, or only its upper end, the opaque margin divergent, extending above the base of the second tier, the blackened margin of which is continuous with that of the first tier; sometimes, like it, divergent, more often abruptly less divergent or even erect, extending upward to form on either side free fork-like, usually opaque, sometimes hyaline projections which may extend to a point somewhat above the middle of the perithecia or may be almost obsolete; the three middle cells of the middle tier usually more or less conspicuously punctate below, with transversely elongated blackish brown spots: the antheridia normally placed, unusually long and large, pointed, with two or three short, inconspicuous normal appendages placed one behind, the rest external to it. The upper tier distally concave, consisting of from fifteen to twenty-one cells, producing normally four sometimes two perithecia associated, as usual, with short stout typical appendages. Perithecia erect or slightly divergent, straight, dimorphic: stouter and longer, and ending in a single blunt tip; or rather short and stout, pale reddish amber-brown, the lower half or third often abruptly lighter, tapering to a blunt tip, which bears on either side a short, stout, often slightly recurved ear-like outgrowth



formed by the prolongation of the anterior lip-cells, the posterior lips forming a usually angular, sometimes sharply pointed projection between them. Antheridia purplish, nearly straight or slightly curved, rather abruptly enlarged below the sharply pointed apex, the venter somewhat inflated. Perithecia  $80-100 \times 25 \mu$ . Antheridia  $35 \times 7 \mu$ . Total length to tip of perithecia  $200-225 \times 100-115 \mu$ . Appendages  $35 \mu$ .

On *Philonthus flavolimbatus* Erichs., Panama, British Museum, No. 750 (Biologia Coll.); Las Vegas, Mexico, Sharp Coll. No. 1130; *P. parvimanus* Sharp, Chontales, Nicaragua, British Museum, No. 746 (Biologia Coll.); *Philonthus* sp., Mt. Gay, Est Grenada, West Indies, British Museum, 489 (Smith Coll.); *P. scybalarius* Nord., British Museum, No. 406, Madeira, also Scotland, Sharp Coll. No. 1126; *P. longicornis* Steph., British Museum, No. 408, Island of St. Helena, also Missouri, Sharp, Coll., No. 1127; *P. cruentatus* Gmel., British Museum, No. 358, Europe; *P. varians* Peck, British Museum, No. 359, Ealing, England; *Philonthus* sp. near *variens*, Australia, Sharp Coll. 1128; Europe, Berlin Mus., No. 821; *P. dimidiatus* Er., British Museum, No. 761, Notting Hill, England. On abdomen. A form, apparently this species, also from Hong Kong, on *Philonthus* sp., British Museum, No. 396, on *Philonthus* sp. near *P. scybalarius* Nord., Sydney, Australia, Sharp Collection, No. 1125 (very typical); *P. agilis* Grav., Austria, Berlin Museum, No. 822; *Philonthus* sp., Arabia, Sharp Coll., 1120; *P. ebeneus*, Grav., Siberia, Sharp Coll., No. 1121; also Berlin Museum, No. 820, Europe; *Philonthus* sp., Chile, Berlin Museum, No. 817; *P. bipustulatus* Panz., Europe, Berlin Museum, No. 819.

This common and widely distributed form, although it is in its typical form (Plate XXXI, fig. 5) one of the best distinguished and most easily recognized species in the genus, varies very greatly in the suffusion and development of its receptacle, which sometimes wholly lacks the black, fork-like upgrowths so characteristic in the figure referred to. It is very often associated, also, with what appears almost certainly to be a variety (fig. 9), that lacks the perithecial auricles and differs in its larger longer perithecia, and usually in its larger, sometimes almost colorless, receptacle: such forms, though usually shorter and stouter than the typical *D. princeps*, resembling this species very closely. A similar auricled form has not, however, been found to accompany the typical *D. princeps*, and specimens of typical *D. vulgatus*, from Europe, Australia (fig. 5) and North and South America, correspond in even the most minute details. Its hosts are usually larger *Philonthi* on which it may occur in large quantities. The species is closely allied to *D. dubius*.

DICHOMYCES DUBIUS Thaxter. Plate XXXII, figs. 7-10.

Proc. Am. Acad. Arts and Sci., Vol. XXXV, p. 426. April, 1900.

Receptacle much as in *D. princeps* and similarly colored, smaller, shorter, and stouter, antheridia large purplish; the distal tier of cells producing typically two, rarely more, perithecia, which are dull brownish and dimorphous; usually rather slender, tapering slightly, the posterior lip-cells producing ear-like outgrowths recurved or bent forward as in *D. vulgatus*: more rarely larger and stouter, the blunt, often asymmetrical tip without appendages; the two forms sometimes, but not usually, associated on the same individual: external appendages normally large, long, colorless, reaching to the middle of the perithecium or even to its tip. Individuals asymmetrical, with a single antheridium and perithecia of the second type, are not infrequently met with on the legs of the host. Perithecia  $70-90 \times 20 \mu$ , those without appendages  $70-105 \times 30-35 \mu$ . Spores  $35 \times 4 \mu$ . Receptacle about  $120 \times 75 \mu$ . Total length to tip of perithecium average  $190 \mu$ .

On *Philonthus æneus* Rossi, Niagara Falls, New York; Fresh Pond, Cambridge, Mass.

This species was first observed on material sent me from Niagara Falls by Mr. Bullard, and I have thus far seen it only on this host which is one of the largest species of *Philonthus* in this region. Abundant material has subsequently been obtained from Fresh Pond, near Cambridge, which, though usually very constant, often includes individuals in which the perithecia are not auricled and which closely resemble forms of *D. princeps* and some of the forms of *D. vulgatus* which are without auricles. It is per-



haps possible that these three may be forms of one variable species, but although I have found *D. princeps* on a variety of hosts from various parts of the world, and in abundance, I have never seen it associated with *D. dubius*, unless it be on the above mentioned host. *D. vulgatus*, as I have already mentioned, is also associated with a form like *D. princeps* which is, however, usually larger and stouter with a tendency to black suffusions along the margins of the first tier (Plate XXXI, fig. 9), a tendency which, though it may occur in *D. dubius*, is never seen in *D. princeps*. In the present species the fork-like upgrowths of the second tier are wholly absent, or rudimentary, and never colored; in striking contrast to the normal condition in *D. vulgatus*. Despite these various points of resemblance, a careful reexamination of all the material has confirmed me in the opinion that the present species and probably the two others above referred to, should be regarded as distinct from one another. As in other cases *Peyritschiiella*-forms, without auricles, are very frequently associated with this species.

DICHOMYCES HYBRIDUS Thaxter. Plate XXXI, figs. 15-19.

Proc. Am. Acad. Arts and Sci., Vol. XXXV, p. 423. April, 1900.

Basal cell small hyaline with a red brown suffusion near the base: lower tier narrow and elongate, opaque or sometimes with a median translucent line: middle tier rather narrow, not more than five of the median cells distinguishable, and more or less conspicuously marked on the anterior side by dark transverse flecks or striæ; distally hyaline or merely tinged with reddish brown above, becoming red-brown and finally opaque below; the margins opaque, continuous with those of the first tier and extending upward to form fork-like opaque projections, as in *D. furciferus*, which equal or exceed the upper tier in length; a single appendage arising posterior to the rather small purplish antheridium: upper tier relatively large, distally concave, composed of from fifteen to thirty-three nearly hyaline cells with reddish brown shades along the septa, the median cells sometimes flecked with reddish brown spots or transverse striæ toward the base, bearing two to six perithecia which may be of two types associated on the same individual or occurring on different individuals: the one type somewhat smaller, straighter and more erect, reddish brown, the lower half often abruptly paler or nearly hyaline, tapering rather abruptly to the tip, the lips of which are auriculate much as in *D. furciferus*; the other type larger, rather characteristically divergent, tapering rather abruptly to the truncate unmodified apex; appendages hyaline, sometimes as long as or even longer than the perithecia. Spores  $35 \times 4 \mu$ . Perithecia  $100-115 \times 25-30 \mu$ . Total length to tip of perithecium  $250-300 \mu$ . Receptacle  $175-250 \times 85-145 \mu$ .

With both types of perithecia (the type form): on *Philonthus æncipennis* Boh., Paris Museum, No. 203, Gulf of Oman, India; on *Philonthus* sp., British Museum, No. 366, Sylhet, Assam, India; *Philonthus* sp., Bengal, India, Berlin Museum, No. 825: *P. Lewisius* Shp., Japan, Sharp Coll., No. 1122; on *Philonthus* sp., British Museum, No. 368, Hong Kong, China.

With only one form of perithecium (not appendiculate): on *Philonthus ventralis* Grav., British Museum, Ealing, England; Paris, No. 207, Funchal, Madeira; British Museum, No. 426, Europe, Berlin Museum, No. 823, Europe; Berlin Museum, No. 824, North America; on *Philonthus* sp., British Museum, No. 495, Balthazar, Grenada, West Indies; British Museum, No. 369, China; on *P. proximus* Woll., British Museum, No. 403, Canaries; on *P. gemellus* Kr., British Museum, No. 367, Ceylon; on *Philonthus* sp., Niagara Falls, N. Y. (C. Bullard); Fresh Pond, Cambridge.

The type form of this species in which the ordinary perithecia may be associated with, or wholly replaced by, a much shorter auriculate form, (figs. 16-17), has been found only on Asiatic material, and it seems very doubtful whether the form common on *P. ventralis* and other species of *Philonthus* should not be considered a distinct species. It is common on *Philonthi* about Fresh Pond, but neither in this nor in any material not Asiatic have I seen the dimorphic forms. The ordinary non-asiatic type has not been figured, but resembles that shown in fig. 15, perhaps somewhat smaller and more slender with usually longer and more slender "forks," and a more marked tendency to divergence in the perithecia, which is commonly characteristic. A close comparison of the non-auriculate Asiatic type and the ordi-



nary extra Asiatic type has not enabled me to detect any difference that seems essential. Figs. 16–17 represent the forms which have been taken as the types of this species.

DICHOMYCES MADAGASCARENSIS Thaxter. Plate XXXII, figs. 11–13.

Proc. Am. Acad. Arts and Sci., Vol. XXXV, p. 424. April, 1900.

Basal cell deeply suffused with brown. Lower tier very long and slender, opaque except for a faint median translucent line: middle tier with three to five of the median cells distinguishable, red-brown; the rest indistinguishable in the opaque margins which extend upward to form long fork-like outgrowths on either side that may reach nearly to the tips of the perithecia; antheridia not large, brownish: upper tier consisting of about twenty-one to twenty-three cells, tinged with reddish brown, relatively large, deeply concave distally; the median cells like those of the middle tier, marked by fine faint transverse striae, bearing normally two perithecia which are long and slender, often slightly curved and divergent, pale reddish brown, the tip narrow, the posterior lip-cells forming two small, slightly divergent projections or auricles curved at the tips, the anterior lips meeting in a point between them. Appendages hyaline, sometimes equalling the perithecia in length. Spores very slender and abundant,  $35 \times 2 \mu$ . Perithecia  $125-135 \times 25 \mu$ . Total length to tip of perithecium  $320-350 \mu$ . Receptacle  $225-240 \times 105 \mu$ .

On abdomen of *Philonthus Sikoræ* Fauv., Paris Museum, No. 179, Tananarivo, Madagascar.

This is a large and well marked species, most nearly related to *D. hybridus*. It does not appear, however, to be dimorphic. The perithecia are never more than two, although the distal tier is unusually well developed, and are further more elongate with more slender auricles.

DICHOMYCES BIFORMIS Thaxter. Plate XXXIII, figs. 1–5.

Proc. Am. Acad. Arts and Sci., Vol. XXXV, p. 422. April, 1900.

Basal cell hyaline or nearly so, usually somewhat enlarged and often with a heel-like anterior projection; lower tier rather narrow, quite opaque, the marginal cells extending up to the subterminal marginal cell of the middle tier or to the cell next below it: the middle tier short and stout, the nine to eleven cells hyaline or faintly reddish brown above, usually becoming more or less suffused below and externally with brown; the median cells, where suffused, marked by darker transverse flecks on their anterior faces, the marginal cells ending in a blunt distal often hyaline prominence on either side; antheridia short and stout subconical, subtended by a single brown inconspicuous appendage: the distal tier assuming in well developed individuals the form of a rather slender crescent, the number of cells very variable, the maximum about fifty, sometimes less than half this number, in which case the form is stouter, the marginal cells rarely extending above the tips of the perithecia, which are four to eight in number and of two kinds which are not known to be associated on the same individual; in the one case they are stouter, purplish brown, the basal third, or more, often abruptly hyaline or nearly so, the much darker red brown tip tapering rather abruptly to the apex, which is hyaline, nearly truncate, with a well defined median blunt projection; the posterior lip-cells prolonged, much as in *D. insignis*, to form a long horizontal nearly cylindrical, or slightly tapering, bluntly tipped hyaline appendage on either side; the second type more often longer and more slender than the first, pale reddish brown, the tip tapering, slightly truncate or blunt, often with a blunt median projection as in the first type, but without appendages. Perithecia  $105-110 \times 20-35 \mu$ . Receptacle  $200 \times 100-300 \times 270 \mu$ .

On *Philonthus* sp., Niagara Falls, New York, Mr. Charles Bullard: on *Philonthus umbratilis* Grav., British Museum, No. 362, Leicester, England; Paris Museum No. 206 and British Museum, No. 407, Madeira; Paris Museum, No. 175, St. Pierre et Miquelon: Scotland, Sharp Collection, No. 1213.

This species has been found by me repeatedly at Fresh Pond on *Philonthus umbratilis* and in every case the two forms have been associated. It is perhaps the most remarkable and striking species of the genus not only from its dimorphism and the highly developed auricles, but from the extraordinary development of the distal tier which, in one specimen observed, bore eight fully developed perithecia although four or six are most frequently present. I have seen no instances in which the two types of perithecia



are associated on a single individual and the material examined has been so abundant that it seems hardly probable that there is ever more than one type in a given individual.

In the Sharp Collection a specimen of *Philonthus* labeled "*P. varians?* Victoria, Australia," is parasitized by a form closely related to the present, if not identical with it, but the specimens are too much broken to render an accurate determination possible. As far as has been definitely determined the host is always *P. umbratilis*, a rather large species with dark secondaries.

DICHOMYCES INSIGNIS Thaxter. Plate XXXII, figs. 3-6.  
Proc. Am. Acad. Arts and Sci., Vol. XXXV, p. 421. April, 1900.

Basal cell suffused with reddish brown or partly hyaline; the lower tier wholly opaque or translucent along the median line; the middle tier consisting of about thirteen to seventeen cells, exclusive of those which are indistinguishable in the slender fork-like prolongations which extend on either side higher than the middle of the upper tier, the margin broadly blackened, continuous with the opaque margin of the lower tier; the lower portion of the three to five median cells marked by a few large scattered transversely elongated brown patches which merge on either side into the opacity of the marginal cells; antheridia very large, the venter slightly inflated, the neck sharply pointed, conical, brown, often abruptly contrasting, three to five of the cells immediately external to them bearing normal brownish appendages: distal tier very large subtriangular, distally concave, consisting of from twenty-nine to thirty-nine narrow and elongated cells and bearing from four to eight perithecia with some irregularity; the appendages brownish, paired above the subtending cell, not as long as the perithecia. Perithecia relatively small, purplish brown, tapering almost continuously from the broad base; the tip moderately well distinguished, the posterior lips prolonged to form long nearly straight and horizontal slightly inflated appendages, which project from the tip on either side; the anterior lips forming the truncate apex, which consists of two distinct lateral projections with an intervening convex portion having a median apiculus. Perithecia about  $85 \times 30 \mu$ , appendages from tip to tip  $35-39 \mu$ . Antheridia  $50 \times 11 \mu$ . Receptacle  $300-340 \times 200-230 \mu$ . Total length to tip of perithecium  $375-400 \mu$ .

On an undetermined staphylinid collected by A. R. Wallace at Sarawak, Borneo, Hope Coll. No. 218.

The largest and finest species of the genus, sometimes even larger than the type represented in fig. 3. The perithecia diverge somewhat from the plane of the upper tier and thus seem in the figure somewhat shorter relatively than they really are. No indication was seen in the material obtained of the occurrence of a second type of perithecium. The figure given of the antheridium is only intended to suggest its structure, the outlines of the antheridial cells being too confused to draw with exactness. The antheridial cells appear to arise from more than one basal cell.

DICHOMYCES BIFIDUS Thaxter. Plate XXXII, figs. 14-16.  
Proc. Am. Acad. Arts and Sci., Vol. XXXVII, p. 26. June, 1901.

Basal cell slightly enlarged, pellucid, tinged with brown, about as long as broad: the lower tier, and more or less of the middle tier, opaque; the marginal cells of the latter forming a bluntly rounded, sometimes almost obsolete projection on either side, hardly extending above the venter of the short, stout, short-necked antheridia: the upper tier relatively large, more or less crescent-shaped according to the degree of lateral development, edged externally with blackish brown, more broadly below, the brown area punctate; the cells about thirty-one in the larger individuals, the marginal ones forming a rather slender series, which may curve abruptly upward nearly to the middle of the perithecia, or assume a more divergent habit; the peritheciigerous area horizontal, producing normally four perithecia, three appendages arising between the two middle ones and one between each of the others, the external cells bearing appendages as usual which vary in length. Perithecia rather long and slender, hyaline or faintly yellowish brown, conspicuously tinged with purplish brown below the perfectly hyaline tip, the anterior lip-cells forming a pointed projection, the posterior ones forming each a relatively large ear-like appendage which tapers to a pointed apex, and is slightly curved, the two diverging from one another at an angle of



about  $50^\circ$ . Spores about  $38 \times 2.5 \mu$ . Perithecium without appendages  $126 \times 25 \mu$ ; the appendages  $14 \mu$ . Receptacle  $220-350 \times 120-165 \mu$ . Total length to tip of perithecium  $300-330 \mu$ . Appendages  $20-80 \mu$ .

On the abdomen of (?) *Philonthus* sp. Ralum, New Pomerania. Berlin Museum, No. 1013.

A very beautiful and peculiar species, distinguished from all others by its stout tooth-like auricles which make the tip of the perithecium appear bifid. Although scanty, the material is in fine condition, the host having been brought in alcohol by Dr. Dahl.

DICHOMYCES AUSTRALIENSIS Thaxter. Plate XXXIII, figs. 10-13.

Proc. Am. Acad. Arts and Sci., Vol. XXXVII, p. 28. June, 1901.

Receptacle usually rather long and narrow, the basal cell relatively large, hyaline or slightly suffused; the margins of the lower tier usually continuous with those of the middle one, the marginal cells deep blackish brown or quite opaque, the middle cell hyaline or translucent throughout its lower third often punctate: the middle tier consisting of about nine cells, slightly suffused with pale reddish brown externally, more or less edged with deep blackish brown; the terminal cells forming a free rounded projection on either side, extending as high as about the middle of the rather large antheridia, the tips of which may reach to the base of the perithecia: the upper tier nearly hyaline, consisting normally of from eleven to thirteen subequal cells, the terminal ones extending but slightly higher than the bases of the perithecia, which are normally two in number, rather deeply suffused with purplish brown throughout; the apex hyaline, the posterior lip-cells producing each a relatively large bluntly pointed appendage, the two diverging nearly at right angles to the axis of the perithecium, becoming slightly recurved, the distance from tip to tip about twice the diameter of the perithecium. Appendages nearly as long as the perithecia. Perithecium  $60-70 \times 16-20 \mu$ , its appendages  $18 \mu$ . Receptacle  $90-100 \times 42-48 \mu$ . Total length to tip of perithecium  $160-170 \mu$ .

On the superior surface of the abdomen of *Quedius ruficollis* Grav., Sharp Collection, No. 1102.

A species peculiar for its long recurved auricles which are unlike those of any other species except *D. Mexicanus* from which its compact form, dark color, cylindrical auricles, and pointed tip serve readily to distinguish it.

DICHOMYCES MEXICANUS Thaxter. Plate XXXIII, figs. 14-17.

Proc. Am. Acad. Arts and Sci., Vol. XXXVII, p. 28. June, 1901.

General habit much like that of *D. princeps*, generally rather long and slender. Basal cell hyaline, the lower tier relatively long and narrow broadly edged externally with black; the median cell hyaline, or only the marginal cells slightly suffused with smoky brown: the middle tier distinguished from the lower by a slight prominence, hyaline, seven to nine-celled; the marginal cells protruding but slightly on either side; the antheridia brownish, short, stout, blunt-pointed: the upper tier relatively very long, sometimes twice as long as the middle tier, consisting of from nine to eleven cells; the marginal cells protruding but slightly on either side, very much as in the middle tier. Perithecia normally two, about as long as the distal tier and concolorous with it, or somewhat darker, rather stout, tapering but slightly; the tip rather abruptly distinguished, broadly truncate with a slight median projection; the posterior lip-cells giving rise each to a long horizontal appendage, which becomes recurved, is bluntly pointed and somewhat narrower toward the base, the distance from tip to tip often twice the diameter of the perithecium. In a few specimens the receptacle and perithecia are somewhat evenly suffused with smoky brown. Perithecia  $75-85 \times 25-30 \mu$ , the appendages  $18-22 \mu$ . Receptacle  $165-200 \times 55-70 \mu$ . Total length  $235-275 \mu$ .

On the inferior surface of the abdomen of *Philonthus atriceps* Sharp. Jalapa, Mexico. Sharp Collection, No. 1112. Specimens, sometimes occur in which the tips of the perithecia are blunt and unmodified, but this condition may have resulted from breakage or be due to immaturity. The species is closely related to *D. Australiensis*, from which it differs in its more elongate form, somewhat clavate



auricles, and the conformation of the tip of the perithecium. A few specimens lack entirely the usual blackish-brown suffusions, and except for the auricles very closely resemble typical individuals of *D. princeps*. It was found abundantly on a single specimen in a large series of its host in Dr. Sharp's Collection.

DICHOMYCES PERUVIANUS Thaxter. Plate XXX, figs. 3-5.  
Proc. Am. Acad. Arts and Sci., Vol. XXXV, p. 426 April, 1900.

Receptacle with faint brownish shades especially along the septa, almost in the form of two superposed isosceles triangles, the lower very regular, including the basal cell and the first and second tiers, its distal margin horizontal, the upper truncate at the base and distally concave. The basal cell short, the lower tier consisting of from three to four cells, nearly equal in length; the middle tier of typically thirteen cells, the antheridia of medium size, the outer five cells distally appendiculate, one of the appendages situated behind the antheridium as usual; the distal series consisting of usually twenty-seven cells bearing typically four perithecia, the appendages placed as usual, colorless, somewhat shorter than the perithecia, which are mostly brownish externally and hyaline on the inner side, the brown or reddish fawn-color sometimes predominating, asymmetrical, somewhat inflated, slightly bent inward near the tip which is small, pointed, and well distinguished. Perithecia about  $120 \times 30 \mu$ . Receptacle  $207-240 \times 140-175 \mu$ . Appendages  $185 \mu$  (longest). Total length to tip of perithecium  $300-350 \mu$ .

On *Brachyderus simplex* Sharp, Sharp Collection, No. 774. Peru. On *Plociopterus latus* Sharp, Garrao, Amazon, Sharp Collection, No. 1156.

The types of this species from Peru (fig. 4) are somewhat more slender and darker than the Amazon material (fig. 3). The species differs from all others by the pointed tip of its perithecium, which results from a prolongation of the posterior lip-cell, *i. e.* on the side opposite that which corresponds to the insertion of the antheridia. The suffusion of the anterior and posterior wall-cells is also a well marked character not seen elsewhere, the limitation of perithecial suffusions in other species being transverse, as a rule. It is most nearly allied to *D. princeps*, stout forms of which often resemble it closely except for the perithecial suffusions and pointed tip.

#### DICHOMYCES PRINCEPS Thaxter.

The occurrence of forms resembling this species, or identical with it in appearance, has been noted under *D. vulgatus* and *D. dubius*. Specimens of the typical form occurring unassociated with any other have been found as follows. British Museum No. 371, *Philonthus* sp., Blois, France; No. 380, *Philonthus* sp., S. W. Australia; No. 406, *Philonthus Scybalarius*, Madeira; No. 424, *Philonthus cephalotes* Grav., Europe; No. 372 on *Philonthus* sp., North India; No. 743, (Biologia Coll.), Mexico, on *Quedimarcus puniceipennis* Solsk.: Paris Museum; No. 208, on *P. longicornis* Steph. Madeira; No. 46, on ? *Philonthus* sp. Mexico; Berlin Museum No. 815, *P. sordidus*, Europe; No. 816, on *Philonthus* sp., St. Vincent: Sharp Collection, No. 1118, on *P. sordidus*, California.

#### DICHOMYCES INFECTUS Thaxter. Plate XXXI, figs. 3-4.

This species, which was described from a unique type, has been found again at Fresh Pond, Cambridge, on *Xantholinus obsidianus* sometimes associated with *D. furcatus*, or a form hardly distinguishable from this species. It usually assumes the form represented in fig. 4, but sometimes develops short "forks" as in fig. 3. The perithecia are always normally paired and usually diverge decidedly.

#### DICHOMYCES ANGOLENSIS Thaxter. Plate XXX, figs. 6-7. Proc. Am. Acad. Arts and Sci., Vol. XXXV, p. 421. April, 1900.

Basal cell hyaline. Lower tier opaque or the middle cell subhyaline, the marginal cells opaque, extending up on either side of the middle tier: middle tier relatively large, consisting of about thirteen to sixteen hyaline cells, the three to four external ones continuing the margin of the first tier directly and either subhyaline or blackened below, each bearing a normal appendage; the antheridia of medium



size, brownish: upper tier smaller, shorter, and narrower than the middle one, consisting of from thirteen to fifteen hyaline cells: distally slightly concave, bearing a pair of perithecia, the appendages small, hyaline. Perithecium large and stout, straight, faintly brownish, slightly inflated, tapering distally to the nearly symmetrical truncate apex. Perithecia  $120-135 \times 30 \mu$ . Length to the tip of perithecium  $250 \mu$ . Greatest length of receptacle  $140 \times 75 \mu$ .

On elytra of *Philonthus* sp. indet. British Museum, No. 379. Angola, Africa.

This species is characterized by the relatively small distal tier and well developed middle tier which, however, produces no black fork-like prolongation, or a very short one. Although I should be at a loss where to refer it, I should not, with my present knowledge of the genus, be inclined to describe it as a distinct species without examining more material: yet it appears to differ from any forms with which it might be confused, by the inconsiderable development of its upper tier.

DICHOMYCES CAFIANUS Thaxter. Plate XXX, figs. 1-2.

Proc. Am. Acad. Arts and Sci., Vol. XXXV, p. 425. April, 1900.

Tinged with dull amber-brownish throughout, the perithecia darker. Basal cell nearly hyaline, the lower tier as in *D. vulgatus*, the opacity involving in general but half of the upper (external) cells, the septa of which are visible on the inner side, the median cell dark brown, its lower half or more opaque: the middle tier consisting of typically thirteen cells, the margins unmodified and ending in a short external rounded projection, which does not extend beyond the base of the upper tier; the rather inconspicuous antheridium normally placed, concolorous, a single short appendage close behind it: the upper tier consisting of from nineteen to twenty-three, usually twenty-one, cells, forming an inverted crescent, the short, stout, bladder-like appendages arranged as in *D. vulgatus*. Perithecia normally two in number, somewhat inflated externally, nearly straight, slightly asymmetrical, rather stout, tapering to the bluntly pointed undifferentiated tip. Spores  $45 \times 4.5 \mu$ . Perithecia  $120-140 \times 35-40 \mu$ . Receptacle  $200-250 \times 100-140 \mu$ . Total length to tip of perithecium  $310-350 \mu$ . Appendages about  $20 \times 6 \mu$ .

On *Cafius puncticeps* White, British Museum, No. 381. Colenso, Natal, Africa.

This species is very similar to the variety of *D. furciferus* which is described under that species (Plate XXXI, figs. 10-12), but is much larger than the largest individuals seen in the abundant material of this form which has been examined. The perithecia are relatively smaller and the receptacle relatively larger, especially the upper tier, which is more highly developed. The present species has an individuality which it is hardly possible to describe, and although the two forms appear in general so closely allied they are very readily distinguished when the actual specimens are compared. It must be admitted, however, that the two may prove varieties of one species, although I am distinctly of opinion that they should be kept distinct.

DICHOMYCES EXILIS Thaxter. Plate XXXI, figs. 1-2.

Proc. Am. Acad. Arts and Sci., Vol. XXXV, p. 420. April, 1900.

Basal cell hyaline. Median cell of lower tier deeply suffused with brown but not opaque; marginal cells wholly opaque or translucent on the inner margins, extending upward so as to enclose the base of the second tier; second tier consisting typically of thirteen cells, colorless or partly suffused with brownish, the antheridia large brownish straight or slightly curved, the venter inflated, the cells external to them, appendiculate, the outer three free above the marginal prolongation of the lower tier and forming a short blunt projection on either side: upper tier like the middle one, mostly somewhat longer and narrower, consisting of from thirteen to fifteen cells, the sub-median ones nearly triangular and for the most part distally overlapped by the external cells next in order and the basal cells of the perithecia. Perithecia typically two, pale brownish amber, long and narrow, slightly if at all inflated, tapering gradually to the undifferentiated broad nearly truncate apex. Spores  $35 \times 4 \mu$ . Perithecia  $130-140 \times 22 \mu$ . Receptacle  $130-140 \times 22 \mu$ . Total length to tip of perithecium  $250-275 \mu$ .

On *Philonthus xanthomerus* Kraatz., British Museum (Biologia Coll.), No. 751, San Andres, Vera



Cruz; on *Philonthus oxysporus* Sharp, Oaxaca, Mexico. Sharp Collection, No. 1113, on *Belonuchus formosus* Sharp Coll. No. 1138, Jalapa, Mexico.

This species appears to vary to a form in which the perithecia are not greatly elongated, but it is possible that two distinct species are associated in the material examined. The typical form (fig. 2) which may develop four very elongate perithecia is sufficiently distinguished by this character from all others.

DICHOMYCES JAVANUS Thaxter. Plate XXXII, figs. 1-2.  
Proc. Am. Acad. Arts and Sci., Vol. XXXV, p. 420. April, 1900.

Perithecium solitary as long or longer than the receptacle, clear dark reddish brown, translucent, straight or slightly curved, rather slender, of about the same diameter throughout, the tip usually abruptly distinguished, and more or less conspicuously bent to one side, tapering but little to the rather broad blunt undifferentiated apex. Receptacle rather narrow, the basal cell dark red-brown below, nearly hyaline above; the central cell of the lower tier dark red or red-brown, lighter or hyaline at the base; the cells on either side symmetrical, blackish brown, opaque, extending upward so as to partly enclose the base of the second tier, the margins of the two tiers coincident: the second tier composed of from seven to nine cells, hyaline or becoming suffused below with reddish brown, bearing a well defined sharply pointed purplish slightly asymmetrical antheridium, on either side, which is subtended by from one to two typical rather short appendages: the upper tier very similar to the middle, or slightly larger, nearly hyaline, the single perithecium rising to the right of the median appendage, the right half of the tier thus somewhat larger and higher than the left, three typical appendages usually present on either side. Perithecia  $145 \times 26 \mu$ . Spores about  $36 \times 4 \mu$ . Receptacle  $120-140 \times 50 \mu$ . Total length to tip of perithecium  $250-275 \mu$ .

On the abdomen of *Philonthus* sp. Java, British Museum, No. 375.

This small species is well distinguished by its geniculate habit, and the abruptly bent tip of its elongate single perithecium.

DICHOMYCES HOMALOTÆ Thaxter. Plate XXXI, figs. 13-14.  
Proc. Am. Acad. Arts and Sci., Vol. XXXVII, p. 29. June, 1901.

Form short and stout. Basal cell geniculate, more or less suffused: the lower tier more or less, sometimes wholly, suffused with reddish brown; the margins darker, more or less translucent, without contrasts, the outline somewhat uneven, the transition to the middle tier indicated by a distinct prominence: the middle tier consisting of from nine to (rarely) thirteen cells, hyaline or subhyaline, with slight lateral suffusions; the marginal cells ending in a slight hyaline rounded projection, not extending higher than the venters of the somewhat suffused curved antheridia or extending upward nearly to the middle of the perithecium, with black marginal suffusions and usually asymmetrical on the two sides: the upper tier relatively small, the cells subequal, hyaline, asymmetrical, owing to the development of but one perithecium; the appendages often equalling, or exceeding the perithecium in length. Perithecium characteristically short and stout, inflated below, sometimes oval, tapering somewhat abruptly distally, to the rather broadly truncate, or slightly rounded unmodified apex. Spores  $33 \times 3 \mu$ . Perithecia  $65-75 \times 25-30 \mu$ . Receptacle  $70-90 \times 40-55 \mu$ . Total length  $125-165 \mu$ .

On *Homalota sordida* Marsh. Fresh Pond, Cambridge, and Kittery Pt., Me.

A species not very frequently met with and first observed by Mr. Bullard. When mature (fig. 14) it is clearly distinguished from other species having a single perithecium by its asymmetrical middle tier, long appendages, and red-brown translucent suffusions, which often extend to the middle cells of the middle tier without involving the septa. The species is further exceptional, like *D. Peruvianus*, from the numerous appendages developed on the cells of the middle tier. Curiously enough, it is partial to the head and anterior superior portions of its host, where it is most frequently found, although it also occurs on the abdomen. It is probable that it infests more than one species of *Homalota*, but only a single individual has been determined.



## DICHOMYCES INÆQUALIS Thaxter.

Syn. *Peyritschiella nigrescens* Thaxter.

I have already called attention to the fact that *Peyritschiella nigrescens* figured in my monograph is undoubtedly a "reversion" of this species to the *Peyritschiella*-condition, a phenomenon which is likely to occur in all the species of *Dichomyces* when the individuals grow under unfavorable conditions, as on the legs of the host. The typical *D. inæqualis* seems to occur only on *Philonthus debilis* and is very constant in its characters. A single specimen of this host in Dr. Sharps collection, No. 1213, from Scotland, was found infested, and the individuals correspond exactly to the American types.

## PEYRITSCHIELLA Thaxter.

I have already called attention to the close connection of this genus with *Dichomyces* from which it differs only in its asymmetrical habit, and also to the fact that a majority of the species of the latter genus assume the typical *Peyritschiella*-type when growing under unfavorable conditions as on the legs of their hosts. Despite this fact I feel that the two genera are best kept apart, and are sufficiently distinguished.

PEYRITSCHIELLA PROTEA Thaxter. Plate XXX, figs. 8-9.

Proc. Am. Acad. Arts and Sci., Vol. XXXV, p. 427. April, 1900.

Perithecia translucent, brownish amber-colored, rather stout and symmetrically inflated, the symmetrical tip tapering rather abruptly, the apex rather narrow truncate, the lip-edges unmodified. Receptacle nearly or quite hyaline, consisting of a single basal cell, above which the three typical tiers of cells are very variously developed: the lowest of these may rarely consist of a single cell, often of three which do not project laterally, or in well-developed specimens of as many as twelve or more cells, those external to the middle three forming on either side distal external angular usually asymmetrical projections, one or both of which may bear terminally one or even two perithecia and typical appendages: the middle series like the lower, when the latter is well developed, subtriangular in form, consisting of sometimes as many as fifteen to eighteen cells, generally somewhat asymmetrical; a single perithecium usually arising distally from the projecting portion on either side, together with numerous typical appendages: the distal tier similar to the middle one, mostly smaller, somewhat asymmetrical, bearing usually a single perithecium above the median cell, though not produced from it, the remaining cells bearing typical appendages, often as long or longer than the perithecium, the small subtending cell being unusually well defined. Subject to great variation, and sometimes producing more than one antheridium. Perithecia  $80-96 \times 32 \mu$ . Receptacle  $270 \times 80-100$  to  $120 \times 45 \mu$ . Total length to tip of perithecium 200-350  $\mu$ .

On *Bledius bicornis* Germ., British Museum, No. 392, Europe (Thuringia), No. 432, Europe; on *Oxytelus rugosus* Fabr., British Museum, No. 450, Hampstead, England; on *Acrognathus mandibularis* Gyll., British Museum, No. 434, Europe; on *Oxytelus* sp., Fresh Pond, Cambridge. On legs, elytra, and prothorax.

In small specimens the two lower tiers may be but slightly developed, bearing neither appendages nor perithecia, the middle producing one antheridium, the number of cells and appendages on one side of the perithecium being, as in all species, greater than on the other. Occasionally, as in fig. 9, accessory perithecia may develop from the middle or even the second tier, and a second antheridium, even, may arise; but such conditions are abnormal. Although the simplest individuals differ so widely in appearance from those more highly developed, I think that I am right in placing under this species all the forms here included. The specimens from *Bledius bicornis* are regarded as the type forms, and both figures have been drawn from this material.



PEYRITSCHIELLA AMAZONICA Thaxter. Plate XXX, fig. 10.  
Proc. Am. Acad. Arts and Sci., Vol. XXXV, p. 427. April, 1900.

Perithecium translucent brown, about as long as the receptacle, sub-clavate, large, contracted below to form a neck-like base, somewhat inflated distally, the tip well, though not abruptly distinguished, tapering to the nearly truncate apex formed by the slightly expanded tips of the lip-cells which are otherwise unmodified. Receptacle rather narrow, pale translucent brown, consisting of a single basal cell followed by three tiers of cells; the lower symmetrical or nearly so, consisting of three long narrow nearly equal cells not appendiculate and not projecting laterally: the middle tier not asymmetrical, consisting of about twelve cells, the series projecting distally on either side, all the cells, except the three larger median and the external ones, producing distally short typical appendages, the third cell on the right from the median cell bearing a prominent erect antheridium: the terminal tier very similar to the middle one, consisting of about the same number of cells which produce short typical appendages distally and (in the types) a single nearly median perithecium. Perithecia  $200-210 \times 36 \mu$ . Receptacle  $225 \times 70 \mu$ . Antheridium  $45 \mu$  long. Total length to tip of perithecium about  $400 \mu$ .

On an undetermined staphylinid. British Museum, No. 400, Nanta, Amazon River.

This and the following species, *P. Xanthopygi*, should in all probability be united, although none of the numerous specimens of the latter possess the stalked and subclavate perithecia characteristic of the present species, and there are slight differences in the form and structure of the receptacle. Although I do not regard them as distinct, both names are here provisionally retained until more and better material of the present form can be examined.

PEYRITSCHIELLA XANTHOPYGI Thaxter. Plate XXX, fig. 11.  
Proc. Am. Acad. Arts and Sci., Vol. XXXVII, p. 29. June, 1901.

Basal cell of the receptacle very small, or hardly distinguished from the foot: the first tier consisting of three subequal cells without appendages, the middle one somewhat shorter than those on either side of it: the second tier asymmetrical, consisting of three subequal median cells, the margins of the two outer free below for nearly half their length and coincident with the margins of the tier below, the appendiculate "marginal" cells, about three to five on either side, separated from them as usual by oblique septa; the first on the right bearing the large, slender, pointed, nearly straight purplish antheridium: the upper tier consisting of about fifteen or more cells, the series distally concave, rising abruptly upward on either side above the base of the perithecium and bearing the usual appendages. Perithecium solitary at the right of the median (primary) appendage, almost symmetrically inflated from base to apex, dull purplish; the tip slightly darker, hardly distinguished; the apex truncate, sometimes slightly spreading; the lip-cells hardly projecting. Perithecia  $115-150 \times 34-42 \mu$ . Receptacle  $200 \times 65-70 \mu$ . Total length to tip of perithecium  $310-360 \mu$ .

On the abdomen of *Xanthopygus Solskyi* Sharp. Sharp Collection, No. 1158.

A form which is probably not distinct from *P. Amazonica*, although differing in possessing a stalked and symmetrical perithecium.

#### LIMNAIOMYCES Thaxter.

Proc. Am. Acad. Arts and Sci., Vol. XXXV, p. 428. April, 1900.

Receptacle consisting of two portions, a basal part below the perithecium and a distal part united to its posterior margin; the basal portion consisting of a single basal cell, surmounted by two tiers of cells, the anterior cell of the upper tier giving rise to a compound antheridium in structure similar to that of *Peyritschella*: the distal (marginal) portion consisting of an inner and an outer elongated cell, the inner terminating in one of the bell-shaped appendiculate cells characteristic of *Chitonomyces*, separated from the simple appendage by a broad, constricted, blackened septum; the outer, by successive subterminal external proliferations, forming a series of cells from which a smaller secondary appendiculate cell is separated above. The proliferation taking place to the right and left successively, so that the appendages appear to arise in two rows.



This aquatic genus forms a very perfect link between the closely allied aquatic genus *Chitonomyces* and the terrestrial genera *Peyritschella* and *Dichomyces*. The antheridium, unlike that of *Chitonomyces*, is inserted laterally, like that of *Peyritschella*, although in a different relation to the perithecium, and its character can readily be determined. The regular arrangement of the cells of the receptacle in tiers recalls very strongly the conditions in the terrestrial genera just mentioned, although the perithecium comes to be related to the receptacle as it is in *Chitonomyces*, the marginal portion, as in this genus, being terminated by a similar characteristic, bell-shaped cell. Both the species occur in North America on large water beetles, Hydrophilidæ.

LIMNAIOMYCES TROPISTERNI Thaxter. Plate XXXIV, figs. 14-15.

Proc. Am. Acad. Arts and Sci., Vol. XXXV, p. 428. April, 1900.

Perithecium amber-brown, straight, erect, with a slight nearly median inflation, or tapering but very slightly to the undifferentiated tip; the upper half free. Receptacle pale straw-colored, distally dull amber-brownish, the foot minute, black; the basal cell short and small, the lower tier consisting of two cells which are nearly equal, several times as long as broad: the second tier consisting of three cells, the posterior one longest, the median longer than the anterior, which terminates in the antheridium, which is subtended by four basal cells, two of them outer and lower and separated by oblique partitions, while a smaller upper one lies on either side: above the antheridium two vertically elongated cells form the clearly defined base of the perithecium; external to these cells, and somewhat obliquely separated from them, lies the broad base of the inner marginal cell of the distal portion of the receptacle, which lies next above the middle cell of the upper tier, its cavity nearly obliterated above as the spores mature, the primary appendiculate cell which terminates it rather elongate; the proliferation of the outer marginal cell beginning quite near its base, forming a series of about eight cells separated by oblique septa and terminated by small appendiculate cells; the appendages very small, vesicular, brownish below. Perithecia  $127-175 \times 35-37 \mu$ . Receptacle, distal part  $75-110 \mu$ . Appendages  $6 \times 3 \mu$ . Total length to tip of perithecium  $240-375 \mu$ , to tip of receptacle  $190-265 \mu$ .

On *Tropisternus* sp. indet., Paris Museum, No. 47. Mexico. On tip of abdomen.

This species is conspicuous from its large size and dark brown color, and is readily seen projecting from the tip of its host's abdomen. That it has been observed only once on specimens in alcohol in the Paris Museum, may perhaps be accounted for by the fact that it appears to be very readily detached, and grows in an exposed situation. In any case it has been sought for in vain on the very numerous Central and South American *Tropisterni* that have been subsequently examined.

LIMNAIOMYCES HYDROCHARIS Thaxter. Plate XXXIV, figs. 16-18.

Proc. Am. Acad. Arts and Sci., Vol. XXXV, p. 429. April, 1900.

Hyaline. Perithecium rather stout and short, somewhat inflated, its tip abruptly bent outward, the apex bluntly rounded or nearly truncate; the tip and the appendiculate cell usually symmetrically divergent. Basal portion of the receptacle relatively short and stout but otherwise similar in structure to that of *L. Tropisterni*; the two basal cells of the perithecium almost obliterated at maturity so that its base appears to rest immediately on the antheridium; the distal portion of the receptacle bordering the perithecium to its tip, the inner cell becoming almost wholly obliterated in the middle and terminating in a short bell-shaped appendiculate cell which is slightly divergent: the outer marginal cell usually proliferating three times; of the three cells thus formed the two inner, as a rule, produce well developed, long, simple, hyaline appendages; not, however, as well developed as the primary appendage, which may be twice as long as the perithecium. Spores  $50 \times 3 \mu$ . Perithecia  $60-80 \times 17-20 \mu$ . Receptacle, basal part,  $50 \times 20-26 \mu$ , distal part  $50-62 \mu$ . Appendages, longest, primary  $140 \mu$ , secondary  $70 \mu$ . Total length to tip of perithecium  $100-128 \mu$ .

At tip of abdomen of *Hydrocharis obtusatus* Say, Cutts Island, Kittery Point, Maine.

Unlike the preceding species the present form, being small and pale, is seen with great difficulty,



growing as it does appressed on the anal appendages of its host. Although I have examined many specimens of *Hyrocharis* from the same locality, a pond occupying the highest point on Cutt's Island, as well as from other localities in North and South America, I have seen this species but once.

#### CHITONOMYCES Peyritsch.

The additions to this genus have not been very numerous since the publication of my monograph, in part because no special effort has been made to obtain them, and in part for the reason that small exotic Dytiscidæ do not appear to be well represented in the collections examined. Moreover, after the host has been mounted and has become well dusted, it is almost absolutely impossible to see the smaller forms. The genus is no doubt a large one, and species are sure to be multiplied when the tropical forms can be examined fresh or in alcohol. Nevertheless a few very characteristic forms are herewith illustrated, among which *C. psittacopsis* and *C. Bullardi* are among the most singular yet discovered. A special interest also attaches to *C. Javanicus*, since, with *C. marginatus* and *C. melanurus*, it represents a small group of species, closely allied and evidently either derived from one another or from a common source, and all growing in exactly the same position on the same (left) wing of species of *Laccophilus*.

No attempt has been made since the publication of my Monograph to determine more exactly the nature of the antheridium which, in most species, is so small that it can be detected only with the greatest difficulty, placed as it is on the side of the individual next the perithecium and thus never visible in profile. A careful study of the antheridia, in forms like *C. rhyncostoma* or *C. paradoxus*, in which they appear to be unusually large, is much to be desired. The close relation of this genus to *Limnaiomyces* in which the compound antheridia are evident, cannot be doubted.

All the species added herewith afford further illustrations of the remarkable constancy with which these plants occur in definite positions on the hosts, a condition which is to me quite inexplicable unless, as previously suggested, it is brought about by automatic motions of the legs while the insects are *in coitu*. This explanation, however, seems insufficient to account for the restriction of eight or nine species on a single host to a corresponding number of definite positions.

The two nearly related species, *C. Aethiopicus* and *C. Orectogyri* should probably be removed from this genus, although very closely related to it. It will be necessary to examine young conditions, however, before this can be determined. With the exception of these two forms which occur on *Gyrinidæ*, the species of the genus are all found on small water beetles belonging to the Dytiscidæ and Haliplidæ.

#### CHITONOMYCES HYDROPORI Thaxter. Plate XXXIV, figs. 28-29.

Proc. Am. Acad. Arts and Sci., Vol. XXXVII, p. 32. June, 1901.

Receptacle nearly hyaline, the subbasal cell flattened, many times smaller than the basal cell, slightly inflated and distinguished from the cells above and below by slight constrictions; the two cells above subequal, the posterior somewhat broader, and separated from the lower marginal cell of the distal portion by an oblique curved septum, which overlaps its upper fourth; the subterminal marginal cell often nearly as long as the lower, the narrow upper half, or more, of which it overlaps. The lower appendiculate cell rather small, the upper terminal one of the typical form, relatively rather long, distinguished by a slight constriction, the appendage extending beyond the tip of the perithecium. Perithecium relatively large, its upper half, or more, free, distally broader, the outer margin nearly straight with as light subterminal rounded elevation below the abruptly rounded projecting outer brownish lip-cells; the apex otherwise flat, broad, bent outward so as to be slightly oblique, the inner margin below it bulging and curved throughout. Spores  $55 \times 4 \mu$ . Perithecium  $98-108 \times 25 \mu$ . Receptacle to base of perithecium  $80 \mu$ , to tip of terminal cell  $150 \mu$ . Total length to tip of perithecium  $185 \mu$ .

On the mid-elytron of *Hydroporus modestus* Aubé, Cape Neddock, Maine (Mr. Bullard); on *Hydroporus* sp., Daytona, Florida.

This species is distinguished by the broad out-turned tip of its perithecium and the enlargement of the cells immediately above the very small subbasal cell. The Florida specimens are slightly smaller



than those from Maine and were found on the inferior surface of the abdomen of a small *Hydroporus*. They correspond with the types, however, in all essentials.

CHITONOMYCES FLORIDANUS Thaxter. Plate XXXIV, figs. 36-38.

Proc. Am. Acad. Arts and Sci., Vol. XXXV, p. 430. April, 1900.

Pale straw colored with a smoky, brownish tinge, the basal and subbasal cells relatively large, the former rather elongate, the latter broader than long, the distal cell erect, conical, appendiculate, its basal septum horizontal. Perithecium relatively large, distally somewhat inflated, the posterior margin to the apex nearly straight, the tip moderately well distinguished, the inner margin strongly convex between the tip and the secondary appendage; the lip-cells each forming a more or less distinct papilla. Spores relatively large about  $35 \times 3 \mu$ . Perithecia  $70 \times 28 \mu$ . Receptacle, distal part,  $62 \mu$ , the two basal cells with foot  $52 \mu$ . Total length to tip of perithecium  $120-138 \mu$ .

On *Cnemidotus 12-punctatus* Say, Eustis Florida, October. On legs and elytra.

An insignificant species superficially resembling *Hydraeomyces* but structurally different. The hosts were captured on the margin of Lake Eustis near the landing.

CHITONOMYCES OCCULTUS Thaxter. Plate XXXIV, figs. 30-31.

Proc. Am. Acad. Arts and Sci., Vol. XXXVII, p. 30. June, 1901.

Short and stout, becoming suffused with somewhat smoky amber-brown. Lower portion of the receptacle deeper brown, the basal cell relatively large, broad distally; the subbasal cell broad and flattened; the lower cell of the distal portion rather large and but slightly overlapped by the subterminal cell, which may bulge slightly below the terminal cell, the latter being thus turned so as slightly to overlap the perithecium. Perithecium short and stout, its upper third or less free, darker brownish externally; the tip bent outward, tapering rather abruptly to the slightly irregular apex, its outer half or less suffused with dark brown. Spores about  $22 \times 2.5 \mu$ . Perithecium  $60 \times 20 \mu$ . Receptacle to tip of distal cell  $90 \mu$ . Total length to tip of perithecium  $100 \mu$ .

On the right elytron of *Cnemidotus* sp. Lake Eustis, Florida.

This characteristic little form grows concealed in a depression of the margin near the middle of the right elytron and would readily remain unnoticed unless sought for.

CHITONOMYCES PARADOXUS Peyritsch.

Specimens of this form have been obtained on species of *Laccophilus* from Lake Eustis Florida, and again from *L. minutus* and *L. hyalinus* from Europe (British Museum No. 487, England, and Berlin Museum Nos. 1053-1054, from Europe), and a well marked variety, Plate XLII, fig. 39, has been observed on a small *Laccophilus* from Java (Rouyer, No. 1396). This is distinguished by its more slender straighter habit, by the more erect and slender terminal horn-like perithecial outgrowth, and by the conformation about the pore. It grows in exactly the same position as the type form, and though a well defined variety, should not, I think, be specifically separated.

CHITONOMYCES DENTIFERUS Thaxter. Plate XXXIV, figs. 26-27.

Proc. Am. Acad. Arts and Sci., Vol. XLI, p. 306. July, 1905.

Pale straw-colored. Receptacle nearly straight, the foot large, the basal cell about twice as long as broad, but slightly broader distally, the subbasal cell broader than long, distinguished above and below by a more or less distinct constriction, the lower marginal cell longer than the next above it, the terminal cell subcylindrical with broadly rounded apex bent slightly inward. Perithecium distally curved inward above a suberect, tooth-like, unicellular appendage, which is curved slightly outward, and originates above a rounded more deeply colored prominence, which subtends it and lies nearly opposite the extremity of the distal appendiculate cell of the receptacle, which it about equals in length. The tip of the perithecium tapering, the lip-cells slender and somewhat elongate, with rounded extremities. Total length to tip of perithecium  $90-110 \times 18-20 \mu$ . Perithecium about  $65 \times 18 \mu$ . Basal portion of receptacle about  $35 \mu$ . Spores about  $28 \times 3 \mu$ .



On the margin of the left elytron of *Laccophilus proximus* Say, near the base, Lake Eustis, Eustis, and Daytona, Florida.

This species is distinguished from all others by the position and form of its perithecial appendage. The tip of the perithecium has the same somewhat shriveled appearance that is seen in *C. appendiculatus* from which, though its nearest ally, it is abundantly distinct.

CHITONOMYCES SPINOSUS Thaxter. Plate XLII, fig. 40.  
Proc. Am. Acad. Arts and Sci., Vol. XLI, p. 307. July, 1905.

Basal and subbasal cells of the receptacle subequal, the latter somewhat broader; the lower marginal cell relatively short and broad; the lower appendiculate cell relatively large; the upper marginal cell bearing distally a long unicellular amber-brown outgrowth, about half the total length of the individual, projecting upward and outward at an angle of about  $45^\circ$ , with a slight terminal twist, and subtended by a prominent bulge of the cell which bears it: the distal appendiculate cell relatively large and broad. Perithecium rather stout, the transverse limits of the wall-cells indicated externally by more or less pronounced elevations, the blunt tip somewhat abruptly distinguished above the nearly straight inner margin. Total length to tip of perithecium, including foot,  $130 \mu$ , greatest width  $33 \mu$ . Marginal appendage  $45-60 \mu$ . Spores about  $28 \times 2.5 \mu$ . Perithecium  $75 \times 20 \mu$ .

On the left posterior leg of *Laccophilus* sp., Java. Rouyer, No. 1394.

This species is immediately distinguished from all others by the spinous process which projects from the penultimate cell of the distal portion of the receptacle. Although it occurs in the same position on its host it does not seem nearly related to *C. spinigerus* which possesses a spine arising from the base of the perithecium.

CHITONOMYCES BULLARDI Thaxter. Plate XXXIV, figs. 32-35.  
Proc. Am. Acad. Arts and Sci., Vol. XXXVII, p. 31. June, 1901.

Straw-colored becoming tinged with pale amber-brown. Basal cell of the receptacle monstrously developed, about as long, sometimes twice as long, as the remainder of the plant, its axis coincident with that of a distal, variably developed, blunt, tooth-like, free posterior projection, near the base of which the subbasal cell and the remainder of the plant project backward at an angle of about  $45^\circ$ , or less, to the axis of the basal cell, the separating septum being vertical or nearly so; the subbasal cell small and flattened: the lower marginal cell of the distal portion of the receptacle subtriangular, short and broad; the lower appendiculate cell above it relatively large; the subterminal cell larger than the lower marginal cell, curved inward so that the terminal appendiculate cell projects from it obliquely inward against the perithecium. Perithecium four fifths or more free, relatively large and stout, distinctly inflated below, tapering to the tip, which is characteristically modified through the presence of a large claw-like subterminal dark amber-brown external projection, the distal half of which is somewhat abruptly recurved, like the upper mandible of a parrot, over the small hyaline incurved 4-papillate apex, which is immediately subtended on the inner side by a small, erect, dark amber-brown, tooth-like process, the blunt tip of which alone is free. Appendages slender and extending to or beyond the tip of the perithecium. Spores about  $20 \times 2.5 \mu$ . Perithecium average  $70-75 \times 30-32 \mu$  not including the hook-like appendage, which is  $25 \mu$  to its upper margin. Receptacle: basal cell to tip of prolongation  $90-220 \times 15-22 \mu$ , the portion above to tip of distal cell  $48 \mu$ .

On the right inferior anterior margin of the prothorax of *Cnemidotus 12-punctatus* Say. Cambridge.

This species which has been named for its discoverer, Mr. Charles Bullard, has been seen only on specimens of *Cnemidotus* from the vicinity of Fresh Pond. The peculiar development of the receptacle is associated with its position of growth on the anterior margin of the prothorax, over which it hangs by the monstrous basal cell. The position of growth is invariable and this invariability is here even more inexplicable than in other similar instances. The species appears to be very constant varying only in the length of the basal cell of the receptacle.



## CHITONOMYCES PSITTACOPSIS Thaxter. Plate XXXIV, figs. 23-25.

Proc. Am. Acad. Arts and Sci., Vol. XXXVII, p. 30. June, 1901.

Nearly hyaline. Receptacle rather slender, the basal cell several times as long as the squarish sub-basal cell; the cell above the latter nearly equalling it in size and separated by an oblique septum from the lowest of the marginal cells, which are all subequal; the terminal appendiculate cell of the usual form, relatively large and long, without any distinct basal enlargement; the tip of the lower appendiculate cell curved slightly outward. Perithecium relatively very large, long, slender, usually curved side-wise throughout, the upper half tapering very slightly to the curiously modified, clear black contrasting tip, which resembles the partly open beak of a parrot; a larger upper recurved mandible-like process being separated from a second, that resembles a lower mandible, by a hyaline area which includes, and extends back from, the pore; the lower lip-cells translucent, but suffused with brown in such a way as to suggest a tongue-like process projecting slightly between the "mandibles." Spores very numerous, completely filling the cavity of the perithecium, greatly attenuated,  $85 \times 2.5 \mu$ . Perithecium  $200 \times 30 \mu$ . Receptacle to tip of distal cell  $140 \mu$ . Total length to tip of perithecium  $290-300 \mu$ .

On the posterior legs of *Laccophilus proximus* Say. Lake Eustis, and Daytona, Florida.

This is one of the larger species of the genus and is clearly distinguished by its tip which resembles a parrot's beak and by its large size and slender habit. Two hosts were found bearing the individuals, in groups in the position indicated, which were conspicuous from their large size and contrasting color.

## CHITONOMYCES JAVANICUS Thaxter. Plate XLII, figs. 37-38.

Proc. Am. Acad. Arts and Sci., Vol. XLI, p. 307. July, 1905.

Foot relatively small. Basal cell of the receptacle small and narrow, its basal half or more suffused with dirty blackish-brown, above hyaline; subbasal cell longer than the basal, and of nearly the same diameter throughout; the three cells above it subtriangular, about equal in size, darker straw-colored, or pale amber-brown: the lower marginal cell of the distal portion of the receptacle narrow, clean cut, darker amber-colored; the lower appendiculate cell above it hyaline, small; the two remaining cells above and external to it, forming an opaque appendage, shaped like a knife-blade, its tip rounded outward from the inner side to an external blunt apiculus. Perithecium suffused below with pale amber-brown, long and slender, narrower opposite the insertion of the lower appendage, expanding slightly above it, the small hyaline apex curved inward and subtended externally by an erect, clear, dark amber-brown projection, hardly or not at all exceeding it; and on the inner side by a larger, broader, less deeply colored, spreading cell, which is curved toward the receptacle, the blackened portion of which projects about half its length above it. Total length to tip of perithecium  $165-185 \mu$ , to the tip of the black prolongation of the receptacle  $180-200 \mu$ , greatest width  $22-25 \mu$ . Perithecium  $90-110 \times 16 \mu$ . Basal portion of the receptacle  $75 \mu$ , including the slender foot.

On the margin of the left elytron of *Laccophilus* sp., Java.

Reference has been made above to the correspondence between this species, *C. melanurus* and *C. marginatus*, both as to position of growth and general structure. It is most nearly allied to *C. melanurus*, although the conformation of the blackened termination of the distal part of the receptacle is quite different. The types were obtained from material in alcohol sent from Java by Rouyer, No. 1395.

## CHITONOMYCES ORECTOGYRI Thaxter. Plate XXXIV, figs. 19-20.

Proc. Am. Acad. Arts and Sci., Vol. XXXVII, p. 32. June, 1901.

Dull purplish, the cells thick walled and marked by faint transverse striations. The basal cell of the receptacle very small and hardly distinguishable, owing to an abrupt curvature just above the foot; the subbasal cell relatively large, distally narrowed, nearly the whole upper half of its posterior margin covered by a relatively large triangular cell, from which it is separated by a nearly vertical septum; this triangular cell is in contact distally with the ascigerous cavity and the base of the lowest marginal cell; the latter is very long, extending upward, its narrow extremity ending without enlargement opposite



the blackened base of the inner appendage, lying between the latter and the tip of the perithecium; the lower appendiculate cell well defined, about two thirds as long as the subterminal cell, which projects slightly above and bears the free terminal appendiculate cell, which is hyaline, about equal to the lower in length, its inner margin nearly straight, its outer margin curved abruptly inward to the base of the obliquely distinguished, blackened, narrow, erect terminal portion, from which the appendage has been broken in the types. Perithecium relatively large, of nearly equal diameter throughout; the tip broad with a bluntly rounded apex; a short erect contrasting brown prominence formed by the left posterior lip-cell, toward the base of which the inner (anterior) lip-cells are curved in a characteristic fashion, so as partly to overlap it. Spores about  $75 \times 5 \mu$ . Perithecium  $125 \times 36 \mu$ . Receptacle  $250-270 \mu$ . Total length to tip of perithecium  $255 \mu$ .

On the superior surface of the tip of the abdomen of *Orectogyrus* (*Orectochirus*) *specularis* Aubé. Africa. Berlin Museum, No. 806.

As has been previously mentioned, this and the following species are at least aberrant, and probably should be placed in a genus by themselves. The spores of both seem to be abnormally placed in the asci, the short segment being uppermost, but it is not unlikely that, as in some other species, the base of the spore is shortest, and if this is the case it is probable that a terminal appendage of some length will be found in uninjured specimens. With the exception of species of *Laboulbenia* no other forms have been found on the Gyrinidæ. The label *Orectogyrus* appears to have been a slip for *Orectochirus*. The species is therefore misnamed.

CHITONOMYCES ÆTHIOPICUS Thaxter. Plate XXXIV, figs. 21-22.

Proc. Am. Acad. Arts and Sci., Vol. XXXV, p. 430. April, 1900.

Perithecium red-brown, darker on the inner side, with faint transverse striations, somewhat curved; the inner lip-cells producing at the left a blackish brown projection directed obliquely outward across the tip and resembling a canine tooth, the inner lip-cell on the left producing a much smaller, blackish, inconspicuous, tooth-like projection; the distal end of the lower marginal cell of the receptacle abnormally developed, bulging inward against and almost over-topping the subterminal appendiculate cell, the greater portion of the margin of this outgrowth nearly horizontal and extending from the apex of the perithecium to the insertion of the subterminal appendage which is sunk in an abrupt depression between it and the base of the terminal cell of the receptacle. Receptacle nearly hyaline, strongly curved throughout, consisting of a long basal and subbasal cell which appear to lie side by side for nearly their whole length, the lower marginal cell of the distal portion almost obliterated by the body of the perithecium, the subterminal cell large triangular, the terminal cell about as large, and separated from it by a nearly horizontal septum; wholly free, abruptly geniculate, the distal portion much narrower, erect and black (the tip broken), abruptly distinguished above an external bulge of the portion below it. Perithecia  $128 \times 40 \mu$ , the tooth-like projection  $18 \mu$ . Receptacle to tip  $275 \mu$ , the basal and subbasal cells including the foot  $140 \times 35 \mu$ . Total length to tip of perithecium  $255 \mu$ .

On elytra of *Orectochirus specularis* Aubé, Paris Museum, No. 100, Gold Coast, Africa.

HYDRÆOMYCES CNEMIDOTI Thaxter.

This species which is common on *Cnemidoti* in New England has also been obtained from an undetermined species of the same genus taken at Eustis, Florida. It remains the sole representative of the genus.

ENARTHROMYCES Thaxter.

This very characteristic and remarkable genus is still represented by a single species, *E. Indicus*, which has been obtained from the following additional localities. On *Pheropsophus* sp., Hong Kong, Hope Collection, No. 239. In the Paris Museum on several undetermined species of *Pheropsophus* from Asia; on *P. Latovici* Asia, No. 56; on *P. marginalis* India, No. 118 bis; on *P. Yezoensis*, Ken-Si, China, No. 155; on *P. dipsicollis*, Cochin China, No. 114. In the British Museum; on *P. fuscicollis*,



Java, No. 534. In the Sharp Collection; on *Pheropsophus* sp., from Japan. In the Berlin Museum on *P. parallelus* Dej., Senegal; on *P. Madagascarensis* Nossi Bé, Madagascar No. 1004; on *P. Kersteni*, Aruscha Kisuan, Africa, No. 998; on *P. marginatus* Dej., Africa, No. 999; on *P. fastigiatus*, Cape of Good Hope; on *Pheropsophus* sp., Ceylon, No. 1006. The generic type appears to be an isolated one, and in the Key I have included it in a section by itself, although it is closely related to the Peyritschielleæ.

#### MONOICOMYCES Thaxter.

Proc. Am. Acad. Arts and Sci., Vol. XXXV, p. 412. April, 1900.

Receptacle consisting primarily of two superposed cells terminated by a sterile appendage which is variable in character and simple or branched: the subbasal cell producing one, typically two, or in some species several, branches or secondary receptacles, which may consist of one to many superposed cells and may be simple or branched; giving rise to antheridia and perithecia which may or may not be also associated with sterile appendages. The antheridium consisting of four tiers of paired cells, the lower pair forming the stalk, the cells of the two middle pairs producing each a pair of antheridia from their upper inner angles; those of the distal pair cutting off paired sterile cells which correspond to the paired antheridia below, and one or all of which give rise to variously developed, simple, cellular, terminal, sterile appendages: the four pairs of antheridia opening into a common central cavity which discharges between the sterile terminal appendiculate cells. Perithecium stalked.

This is one of the most peculiar and interesting of the genera of Laboulbeniaceæ and is extremely variable in the general structure and relations of the fertile branches or secondary receptacles; a variability which is well illustrated by the conditions seen in *M. St. Helenæ* and *M. Leptochiri*. The characters of the peculiar antheridium appear, however, to be quite constant in all the species; although, in a few instances, it seems possible that the two middle tiers of cells may produce more than four antheridia each. The curious sterile terminal appendages of this organ are also very variable in their development, both as to number and length, and the cells from which they spring are evidently homologous with the antheridia, which are separated in a similar fashion from the cells below. It will be observed that a more detailed study of these forms has necessitated important modifications in the original diagnosis.

The hosts of this genus all belong to the Staphylinidæ, a majority of the species occurring on the Aleocharini.

#### MONOICOMYCES HOMALOTÆ Thaxter. Plate XXXV, figs. 8-10.

Proc. Am. Acad. Arts and Sci., Vol. XXXV, p. 412. April, 1900.

Receptacle consisting of very small hyaline basal and subbasal cells, the basal cell of the primary appendage short and stout, more or less deeply suffused with blackish brown externally and at the base, the cell above it, bearing two or three branchlets in an antero-posterior plane, the primary (terminal and external) one short and externally suffused with blackish, the lower cell larger and distally inflated. Fertile branches normally two, when the individual is bilaterally symmetrical, rarely three, consisting of a single cell which bears distally an antheridium from its outer and a perithecium from its inner angle. Perithecium amber-brown, slightly asymmetrical, relatively very large, short and stout; the lower half greatly inflated, generally more so on the outer than the inner side; distally conical, the small tip not distinguished, usually abruptly truncate, the stalk-cell hyaline, narrowing to its base. Antheridium borne on a pair of rather short stalk-cells, the cells of the second tier somewhat smaller and angular, the cells of the third tier somewhat smaller than those of the second, but large and distinct, the paired appendiculate cells separated from the terminal tier, relatively large, all four generally bearing stout finger-like sterile appendages of unequal length. Spores about  $35 \times 3 \mu$ . Perithecia including basal cells  $100-120 \times 30-35 \mu$ , the stalk-cell  $35-40 \mu$ . Antheridia including stalk-cells (not the terminal projections)  $70-80 \times 30-35 \mu$ . Sterile part of receptacle about  $70 \mu$ .

On *Homalota putrescens* Woll., British Museum, No. 412, Azores. On inferior surface of abdomen. On *Homalota* sp. and *Trogophlæus* sp. Intervale, N. H., and Kittery Pt., Maine.



The form occurring on *II. putrescens* in Britain is taken as the type of this species as well as of the genus. I have found not uncommonly, however, on small species of *Homalota* infesting decaying *Lactarii*, a smaller form (Plate XXXV, fig. 9), in which the measurements are not far from half those of the type, and which is usually distinguished by a dark suffusion at the base of the perithecial stalk-cells similar to that of *II. similis*. Large specimens of this form nevertheless occasionally occur, and correspond so closely to the type that I think they should not be separated.

MONOICOMYCES BRITANNICUS Thaxter. Plate XXXV, figs. 3-4.

Proc. Am. Acad. Arts and Sci., Vol. XXXV, p. 413. April, 1900.

Nearly or quite hyaline. General structure as in *M. Homalota*, the third cell of the primary appendage suffused with blackish brown, somewhat constricted below. Fertile branches consisting of a single cell bearing the antheridium and perithecium as in *M. Homalota*. Perithecium rather long-stalked, slightly asymmetrical or bent, the base inflated, tapering gradually to the blunt undifferentiated tip. Antheridium borne on a pair of rather long stalk-cells, the basal cells almost exactly similar to them and distally not enclosing any portion of the antheridial cavity, the wall cells well developed, the cavity within them relatively small, the terminal cells growing up into generally stout finger-like processes which may extend above the tip of the perithecium. Perithecium, including basal cells,  $90 \times 30 \mu$ . Antheridia to base of terminal projections  $80 \times 20 \mu$ .

On *Homalota insecta* Thom., British Museum, No. 454, Hammersmith, England. On superior surface of abdomen.

This species is too nearly related to *M. Homalota*, and may prove to be only a variety. It differs in its more slender form and apparently also in the characters of the primary appendage: but more abundant and better material is needed to determine to what extent these characters are constant.

MONOICOMYCES ECHIDNOGLOSSÆ Thaxter. Plate XXXV, figs. 5-7.

Proc. Am. Acad. Arts and Sci., Vol. XXXVII, p. 23. June, 1901.

Subbasal cell of the receptacle somewhat smaller than the basal cell, bearing a terminal appendage the basal cell of which is as long, or nearly as long as the receptacle and often distally enlarged; the axis above it consisting of a curved series of several cells, externally opaque, black, hyaline along the inner margin, each cell giving rise from its inner side to a hyaline simple branchlet. Fertile branches usually two, sometimes one or three, arising from the subbasal cell of the receptacle, and consisting of a single short basal cell which bears directly a perithecium (in some cases more than one) and an antheridium. Antheridium relatively large, the stalk-cells somewhat longer and narrower than the cells of the middle two upper tiers more or less prominent distally: the cells of the distal tier proliferous externally and distally, thus forming an outer crown of shorter appendages of very unequal length, which surround the usual inner series. Perithecium becoming greatly and asymmetrically inflated below, and tapering rather abruptly to the slightly distinguished, rather short, bluntly pointed tip; the stalk-cell variably developed. Perithecia  $100-125 \times 45-55 \mu$ , the stalk-cells  $40-80 \times 15 \mu$ . Antheridia  $75-100 \mu$ , the sterile appendages  $50-75 \mu$ . Total length to tip of perithecium  $220-250 \mu$ .

On the inferior surface of the thorax of *Echidnoglossa Americana* Fauvel. Vera Pass, Colorado. Leconte Collection.

Although closely allied to *M. Homalota*, this species appears clearly distinguished by the proliferation of the last tier of cells of the antheridium, and the similar tendency of the penultimate tier, fig. 7.

MONOICOMYCES SIMILIS Thaxter. Plate XXXV, figs. 1-2.

Proc. Am. Acad. Arts and Sci., Vol. XLI, p. 305. July, 1905.

Pale straw-colored. Receptacle consisting of two superposed cells, terminated by a straight tapering simple several-celled appendage, sometimes reaching to the tips of the perithecia, and distinguished by a black basal septum. The subbasal cell of the receptacle also giving rise to a pair of normally symmetrical



branches, consisting of a single basal cell, from which arises the stalk-cell of the perithecium on the inner, and that of the antheridium on the outer side. Stalk-cell of the perithecium narrowed at the base, the narrow portion red-brown, expanding above and hyaline. Perithecium somewhat asymmetrical or bent, deeper straw-colored, tapering gradually to the blunt tip, which is hardly distinguished. Antheridium of the normal type, the distal appendages usually two, one sometimes exceeding the tip of the perithecium. Total length to tip of perithecium 150–200  $\mu$ . Perithecium 90–110  $\times$  30  $\mu$ , the stalk-cell 35  $\times$  46  $\mu$ . Spores about 35  $\times$  4  $\mu$ .

On the abdomen of *Homalota* sp., infesting species of *Lactarius*, Kittery Point, Maine.

This is a rather rare species, occurring near the tip of the abdomen of one of the larger mycophilous *Homalota*. It is most nearly allied to *M. Homolata*, from which it differs in its slender form, large size and single primary appendage, which is distinguished at its base by a black septum. It is subject to some variation, the more normal form represented in the figures, being often modified through the production of only one perithecium or of more than two. The red brown suffusion at the base of the perithecial stalk-cells is also peculiar.

MONOICOMYCES NIGRESCENS Thaxter. Plate XXXVI, figs. 1–4.

Proc. Am. Acad. Arts and Sci., Vol. XXXVIII, p. 10. June, 1902.

Receptacle minute, its basal cell hardly distinguishable above the foot, bearing distally a simple appendage the basal cell of which is hyaline, the subbasal somewhat longer than those above and deeply tinged with blackish brown below. Fertile branches two or more, usually four, each consisting of a single cell which bears an antheridium terminally and a perithecium subterminally: the primary branches normally two, lateral and symmetrical, edged externally with blackish brown, the blackening contrasting and continuous with a similar coloration which extends to the tip of the primary antheridium: the secondary fertile branches arising, when present, between the primary and resembling the latter, except for the absence of the black discoloration; the whole group of branches forming, with their closely crowded antheridia and perithecia, a compact, fan-like, usually symmetrical tuft. Antheridia relatively long, suffused with smoky brown, more deeply blackish externally, the secondary ones with a more or less conspicuous foot-like blackened base; the stalk clearly two-celled, shorter than the main body; only two of the cells separated from distal cells growing upward to form two unequal terminal appendages, which are smoky brown, darker about their blackened basal septa, the cells immediately below them projecting upward very slightly on either side. Perithecia furnished with variably developed stalk-cells the bases of which are blackened, but which are otherwise hyaline, as is the rest of the rather short, often stout, subconical, bluntly pointed perithecium. Perithecia 60–75  $\times$  22–25  $\mu$ ; the stalk-cell 12–55  $\mu$ . Antheridia including stalk, 35  $\mu$ , the appendages 35–50  $\mu$ . Total length 100–160  $\mu$ .

At the tip of the abdomen of *Calodera* sp. and of *Tachyusa* sp.; Intervale, N. H., No. 1357; Kittery Point, Maine. The hosts frequenting fleshy fungi.

This species is not uncommon on minute staphylinids inhabiting decaying *Lactarii* and other fleshy fungi, but from its small size, dark color and flat appressed habit, it is difficult to find. It is possible that the secondary fertile branches arise as in *M. Aleocharæ* from the proliferation of the primary ones, but in some cases at least they seem to arise directly from the subbasal cell of the receptacle. The species is well marked and recognizable from its marginal suffusions.

MONOICOMYCES ALEOCHARÆ Thaxter. Plate XXXVI, figs. 5–7.

Proc. Am. Acad. Arts and Sci., Vol. XXXVII, p. 24. June, 1901.

Pale amber, shading to amber-brown. Receptacle, together with the foot and the basal cell of the terminal appendage, forming a heart-shaped body, blackened below, bearing terminally the median, rigid, slender, almost wholly opaque, black continuation of the primary appendage which is abruptly distinguished from its broad basal cell: the subbasal cell of the receptacle small, triangular when viewed side-wise, giving rise to two fertile branches, the short small basal cells of which give rise at once each to two



secondary branches and an antheridium; the branchlets proliferous and forming an axis of usually three cells, the lower bearing an antheridium, and each of the two upper an antheridium and a perithecium; there being thus sixteen antheridia and eight perithecia in fully and symmetrically developed specimens, which form a dense, spreading, fan-like tuft, the antheridia being in general posterior in position, overlapping one another between the black sterile appendage and the perithecia. Antheridium distally broadened and truncate, elongate; the stalk-cells about equal and about one half the length of the body of the antheridium or somewhat longer than this; the cells of the second tier somewhat unequal; the cells of the third tier smallest; the terminal cells prominently rounded distally, the appendiculate cells usually prominent, forming papillæ which are subtended by the appendages, all four of which do not always develop; these appendages relatively short, two to three-septate, tapering to a blunt point, distinctly inflated above the slightly constricted base. Perithecium relatively large, straight or slightly curved, somewhat inflated below, tapering gradually to the rather short, moderately well distinguished tip; the apex bluntly rounded, the basal cells relatively small; the stalk-cell variably developed, its distal end usually somewhat broader than the basal cells collectively, sometimes more than half as long as the body of the perithecium. Spores about  $50-55 \times 4-5 \mu$ . Perithecia  $130-185 \times 35-55 \mu$ , the stalk-cell  $35-100 \times 18-25 \mu$ . Antheridia  $70-75 \times 22 \mu$ , its appendages  $45-50 \mu$ . Receptacle about  $35 \times 28 \mu$ . Greatest general length and width of largest individual  $350 \times 300 \mu$ .

On *Aleochara rufipes* Boh., Derema, Usambara, East Africa. Berlin Museum, Nos. 844 and 845.

A very striking species remarkable for its method of branching and the large number of antheridia produced. The figure shows a well and symmetrically developed individual, but many produce but few antheridia and perithecia, and one of the primary fertile branches may be altogether lacking.

MONOICOMYCES OXYPODÆ Thaxter. Plate XXXV, figs. 11-13.

Proc. Am. Acad. Arts and Sci., Vol. XXXVIII, p. 10. June, 1902.

Receptacle very small, the two cells subequal, the basal cell involved by the blackening of the foot and hardly distinguishable; the primary appendage straight and tapering, its basal cell hyaline, nearly isodiametric; the subbasal cell brown, slightly inflated and twice as long; subbasal cell of the receptacle giving rise to a branch on either side; one usually sterile, short, blunt, extending externally above the subbasal cell of the primary appendage, and wholly blackened to its base: the other fertile; consisting of a single cell which is brown, broadly blackened externally, the blackening involving its narrow base almost completely; its distal half becoming more than twice as broad, and giving rise normally to a single antheridium terminally and a stalked perithecium subterminally on its inner side; stalk of the antheridium brown, two-celled equal in diameter to the branch-cell which bears it, and becoming like it externally blackened; the functional portion of the antheridium stout, distally rounded and slightly sulcate; one only of the cells separated from the upper tier growing out to form a colorless appendage. Stalk-cell of the perithecium arising immediately below that of the antheridium on the inner side, its narrow base black and opaque, resembling a "foot," distally hyaline, broader, about as long as the antheridium; the basal cells hyaline, rather small; the perithecium faintly purplish, rather long and narrow, relatively large, the tip rather abruptly distinguished and usually slightly bent. Spores  $45 \times 4.5 \mu$ . Perithecia  $75-90 \times 18-20 \mu$ . Antheridia  $25-35 \times 107 \mu$ , the appendage  $40-50 \mu$ . Receptacle  $10 \mu$ , its appendage  $75 \mu$ . total length about  $150-165 \mu$ .

On the inferior tip of the abdomen of *Oxypoda* sp; Intervale, N. H., July 17, 1901.

This species, which is apparently very rare, since I have sought for it in vain since the single infested host was found, is certainly rightly placed in this genus, its chief peculiarity being the production of a short black infertile branch which appears to arise from the subbasal cell of the receptacle. It is difficult, however, to determine exactly the origin of either of these branches on account of the suffusion about the base. In one or two specimens the fertile branch gives rise to more than one perithecium or antheridium. The species is not related to *Kleidomyces furcillatus*, the antheridium of which is of a different type. The host is a small staphylinid common in decaying vegetable refuse.



## MONOICOMYCES ST. HELENÆ Thaxter. Plate, XXXVI, figs. 8-9.

Proc. Am. Acad. Arts and Sci., Vol. XXXV, p. 413. April, 1900.

Pale yellowish or straw-colored. Receptacle consisting of a triangular basal cell, and a squarish or roundish subbasal cell which bears a small distal cell with a short terminal appendage separated from it by a constricted blackish septum; two to four branches arise from the subbasal cell, normally fertile and consisting of from two to five, usually three, superposed cells which are commonly somewhat inflated distally, more so on one side, an upgrowth from which becomes separated so as to form a prominent small cell which lies close against the base of the axis-cell next above and is simple or usually longitudinally divided; in the former case bearing one, in the latter a pair of peculiar appendages distinguished by a conspicuously blackened septum; the basal cell of this appendage usually blackened externally or often wholly opaque the subbasal cell blackened externally about its characteristically geniculate base, its terminal portion erect suffused with brown, or hyaline, and either terminating the appendage or followed by two or three hyaline cells. Perithecium symmetrically inflated, slightly distinguished from the basal cells, the tip small straight truncate tapering but slightly and abruptly distinguished. The antheridium usually single on the fertile branch, replacing the characteristic sterile appendage at the base of the stalk-cell of the perithecium, relatively small, its stalk-cells and those of the second tier about equal; the antheridium proper about as large as the basal part and hardly broader, its terminal cells developing, as in the other species, long often flexuous hyaline upgrowths. Spores  $38 \times 3.5 \mu$ . Perithecia  $100-120 \times 40-48 \mu$ . The stalk  $34-50 \times 25-27 \mu$ . Appendages of fertile branch  $50-90 \times 5 \mu$ . Sterile part of receptacle  $50-50 \mu$ . Greatest length to tip of perithecium  $250-435 \mu$ .

On abdomen and elytra of *Oxytelus alutaceifrons* Woll., British Museum, No. 411, Island of St. Helena. On *O. piceus* Sim., Germany, and *O. luteipennis* Er., Algeria. Sharp Collection, Nos. 1170 and 1171.

This species suggests *Compsomyces* in general habit, and the secondary fertile branches undoubtedly spring directly from the subbasal cell of the receptacle. The sterile appendages of these branches are very peculiar in appearance and are not unlike those of *M. Leptochiri*, a species which appears to be its nearest ally.

## MONOICOMYCES LEPTOCHIRI Thaxter. Plate, XXXIV, figs. 39-40.

Proc. Am. Acad. Arts and Sci., Vol. XLI, p. 304. July, 1905.

Receptacle consisting of a main axis of superposed cells, usually long and slender, normally simple, sometimes once to several times branched, the whole structure apparently a branch from the subbasal cell of a small primary receptacle: the axis somewhat similar to that of *Rhachomyces*, consisting of a series of superposed cells, variable in number (about twelve to twenty-five), each of which bears on one side, so as to form a unilateral series, a pair of simple cylindrical few-celled appendages, which become better developed from below upward; arising side by side, closely associated and appressed, characteristically blackened at the base, which is usually indistinguishable from the small blackened cell from which they arise, and which is obliquely separated just below each septum of the axis: this opaque region in the lower cells of the axis, usually projecting characteristically like a notch or tooth: the cells of the axis near its base deeply suffused or opaque; the suffusion becoming, from below upward, gradually associated with the septum only: the axis in some specimens nearly hyaline throughout, with blackish-brown suffusions at or about the septa. The paired appendages replaced somewhat irregularly below the perithecium by antheridia of small size, resembling the appendages in general appearance when viewed laterally, and usually terminated by two hyaline simple appendages of no great length. Perithecium solitary, terminating the main axis, or its secondary axes; faintly yellowish, straight, slightly inflated, nearly symmetrical, rather abruptly narrower at the tip, the apex rather small, symmetrical, truncate. Total length to tip of perithecium  $250-800 \mu$ , the axis about  $18-20 \mu$  in diameter. Perithecium  $70-90 \times 18-25 \mu$ . Longer appendages sometimes  $50 \mu$ .



On all parts of *Leptochirus unicolor* Cast., *L. Javanicus* Cast., *L. minutus* Cast., Java.

This anomalous and very peculiar species was at first mistaken for a new generic type, but so far as can be determined from the material, its antheridia are not different from those of other members of the genus, and the multiplication of the cells of the secondary axis or fertile branch, and the coincidence of the latter with the primary receptacle, which is in no way distinguished from it, are points of secondary importance. It resembles *M. St. Helenæ* more closely than perhaps any other species, the peculiar appendages being strikingly similar. The long and usually nearly opaque axis is very like that of *Rhachomyces*. The peculiar staphylinid hosts on which it occurs are sparingly clothed with long stout hairs or setæ, among which the parasite is often distinguished with difficulty. Specimens growing on the jaws, or other portions of the host where they are exposed to unfavorable conditions, often produce secondary fertile branchlets, as in fig. 40, but this condition is exceptional; the normal form, as it occurs on the abdomen or in other favorable situations, being similar to that represented in fig. 39, which is the type form. The axis, however, varies considerably in the number of cells which compose it and in the depth of its suffusions. The hosts are tropical insects living under bark.

#### EUMONOICOMYCES Thaxter.

Proc. Am. Acad. Arts and Sci., Vol. XXXVII, p. 21. June, 1901.

Receptacle consisting of a basal and subbasal cell, the latter producing terminally a sterile appendage and laterally a fertile branch (abnormally more than one) the axis of which is coincident with that of the receptacle, from which it is not distinguished, and consists of a series of superposed cells; the terminal one bearing an antheridium and a stalked perithecium; the rest bearing antheridia or paired sterile appendages from their upper inner angles. The antheridia compound, borne on paired stalk-cells, and consisting of very numerous antheridial cells arranged in subhorizontal, or oblique tiers; the series separated externally by two superposed sterile cells, and opening into a common cavity from which the antherozoids are discharged by a common outlet between four appendiculate cells which terminate the antheridium and arise from the two primary terminal cells of the antheridium, as in *Monoicomyces*.

The only material from which it is possible to form an approximately accurate idea of the structure of the antheridium in this genus is that of *E. Papuanus*, the hosts of which were preserved in alcohol. Although the form is very small, careful examination with a  $\frac{1}{16}$  oil immersion renders its general cell-arrangement sufficiently clear, notwithstanding the fact that from the irregularity of its outline and of the cells composing it, the different appearances that may be obtained from different points of view are very confusing. In the lateral view, fig. 15, which is practically the same on both sides, and is the one almost invariably seen in preparations where the individuals lie flat, the stalk-cell appears to be, as was stated in the original description, single. It can be determined, however, by careful focussing, or when a view anterior or posterior in relation to the fertile branch is obtained, that the stalk like that of *Monoicomyces*, is two-celled (fig. 16). Above this stalk the second tier of two cells is also present and from each of these, instead of a pair, as in *Monoicomyces*, two series of rows of antheridial cells are produced, one on either side. There are thus four such series in paired sets, one anterior and the other posterior, and having much the same appearance in either case, as in fig. 16, which is, however, turned slightly to the left, but shows the straight median line of demarcation which separates the two sets. Were this figure reversed, the opposite side would show much the same appearance and if viewed at right angles, either from the right or from the left, the appearance would in either case be similar to that shown in fig. 15. Each of the four sets, as may be seen by reference to fig. 16, in which one of the pairs is represented, consists of about five somewhat oblique rows, which correspond on either side of the straight median line; each row being composed of about five antheridial cells, the number being apparently subject to some variation, the bases of which are indicated in the figure. The method by which these rows of antheridia are separated, is seen more clearly in fig. 17 where only one set is visible, the antheridium in this instance, being younger and viewed more obliquely than in fig. 16, and turned from right to left. Fig. 16 viewed at right angles to its present



position, whether seen from the right or from the left would have the appearance seen in fig. 15, in which the necks of the antheridia, toward the median line, are shown partly in optical section running obliquely upward. All the antheridia open by longer or shorter necks into a median cavity, as is shown in fig. 18 which is a not quite median optical section. This cavity seems to be single, and from it the antherozoids make their escape by a common aperture between the mouth cells, which as in *Monoicomyces*, are cut off from the third or upper tier of the main appendage, and which may later grow up into appendages as is shown in fig. 12. The somewhat dumbbell-shaped bulge of the upper tier-cells is somewhat exaggerated in fig. 15, which is somewhat confusing in that it combines a surface view with some of the appearances seen in optical section. The nature of the central cavity, whether a cell-cavity or an intercellular space, has not been determined in this or the preceding genus. This antheridium is the most highly developed organ of the kind in the whole group of Laboulbeniales there being perhaps seventy-five or more functional antheridial cells in each antheridium, but in the other species of the genus it is much less complicated; although, as far as can be determined from the insufficient material, the type is the same in all three.

*EUMONOICOMYCES PAPUANUS* Thaxter. Plate XXXVII, figs. 11-18.

Proc. Am. Acad. Arts and Sci., Vol. XXXVII, p. 22. June, 1901.

Nearly or quite hyaline. Basal cell of the receptacle small, usually triangular; the subbasal cell terminating in a short appendage, distinguished by a dark basal septum, and sometimes once-branched. The fertile branch not differentiated from the receptacle, consisting of three, rarely two cells similar to the subbasal cell, obliquely superposed; the lowest bearing normally a closely approximated pair of short, hyaline or faintly brownish, erect, sterile appendages, similar to that of the subbasal cell; the middle cell smaller, bearing a single antheridium, and the upper an antheridium and a stalked perithecium. The antheridia rather stout, broader distally; the stalk-cell small and short; the antheridial cells very numerous, the terminal appendages of the usual type, short or seldom longer than the antheridium. Perithecium rather long and sometimes slender; the venter inflated; the distal portion tapering gradually and symmetrically to the blunt, nearly truncate apex; the rather short tip hardly distinguished above a slight elevation; the stalk-cell variable in length, rather slender, seldom more than half as long as the perithecium; the basal cells rather large and broad, not distinguished from the venter. Spores about  $35 \times 3 \mu$ . Perithecia  $80-120 \times 32-40 \mu$ , the stalk-cell  $35-75 \times 15 \mu$ . Antheridia including stalk-cell and without appendages  $35 \times 18 \mu$ . Total length to tip of perithecium  $150-290 \mu$ .

On all parts of a small pale *Oxytelus*? Ralum, New Pomerania. Berlin Museum, No. 1011.

Several hosts bearing this species were found among the alcoholic material brought by Dr. Dahl from the East Indies. The sterile appendages of the fertile branch, although they appear to be solitary when viewed from one side, are in reality paired, exactly like those of *Monoicomyces*. The terminal cell of the primary appendage is spinose as shown in fig. 13.

*EUMONOICOMYCES CALIFORNICUS* Thaxter. Plate XXXVII, figs. 9-10.

Proc. Am. Acad. Arts and Sci., Vol. XXXVII, p. 22. June, 1901.

Resembling *E. Papuanus* in general habit. Basal cell of the receptacle short, stout, geniculate, with a dark brown suffusion extending from the foot half-way up its convex margin; the subbasal cell bearing distally a long appendage consisting of a short hyaline basal cell, separated by a dark septum from a second cell above it, which is dark brown and bears two long, slender, one-celled, erect branches, brown below, becoming hyaline distally. The fertile branch not distinguished from the receptacle and bearing a sterile appendage like that which terminates the receptacle; the middle cell usually bearing an antheridium, and the upper an antheridium and a perithecium. Antheridium short-stalked, with a more or less well-defined median constriction resulting from an inflation of the cells which bear the terminal appendages. The latter very long, brown, extending beyond the tip of the perithecium. Perithecium short and stout, the venter inflated, the much shorter neck-like distal portion abruptly distinguished, the



apex blunt, the stalk-cell usually rather short and stout. Perithecia  $75 \times 25 \mu$ , the stalk-cell  $20 \times 18 \mu$ . Sterile appendages, longest  $150 \mu$ . Appendages of antheridium  $100 \mu$ . Total length to tip of perithecium  $150 \mu$ .

On *Oxytelus* sp. Berkeley, California.

The antheridia are so placed in the specimens of this species which have been examined, that it has been impossible to determine the details of their structure, which are further obscured by the irregularities and relatively considerable development of the appendiculate cells. The species is distinguished from the others by its dark sterile appendages, as well as by other points of difference.

EUMONOICOMYCES INVISIBILIS Thaxter. Plate XXXVII, figs. 7-8.

Proc. Am. Acad. Arts and Sci., Vol. XXXVII, p. 21. June, 1901. *Monoicomyces invisibilis* Thaxter, l. c. Vol. XXXV, p. 414. Apr., 1900.

Hyaline. Basal cell of receptacle small subtriangular, the subbasal cell rather long and narrow, bearing terminally a distally rounded cell from which it is separated by an oblique septum and which is surmounted by a short simple cylindrical appendage; the fertile branch developed on one side only, not distinguished from the receptacle and its appendage, consisting of two or three obliquely superposed cells extending obliquely upward in a divergent series, the terminal cell bearing a perithecium and antheridium in the usual relative positions, the subterminal cell sometimes apparently producing a second antheridium instead of the simple paired appendage which terminates the lower cell of the series. Perithecium borne on a rather short stout stalk-cell, its inflated basal half not distinguished from the flattened basal cells, its slender distal half abruptly distinguished. Antheridium apparently similar in general to that of the other species. Perithecia  $84 \times 30 \mu$ . The stalk-cell  $20 \times 10 \mu$ . Receptacle, sterile part, about  $40 \mu$ . Total length to tip of perithecium  $110-140 \mu$ .

On *Homalota putrescens* Woll., British Museum, No. 412, Azores.

This species is so minute and so inconspicuous from its pale color, that it would almost inevitably be overlooked on dried hosts. One or two additional specimens were accidentally obtained in the Sharp Collection from scrapings of various species of *Homalota*. In none of the individuals, however, can the detailed structure of the antheridia be made out.

HAPLOMYCES Thaxter.

The genus *Bledius*, on which all the species of *Haplomyces* have thus far been found, is not well represented in the various collections examined, and no additional species have been discovered.

*Haplomyces Texanus* Thaxter, or a form indistinguishable from the type of this species in which the base of the appendage is black, has been found on the following hosts: *Bledius bicornis* Germ., Hope Collection, No. 213; no locality: *B. subterraneus* Erichs., Hope Collection, No. 220, Prussia: *B. opacus* Blk., British Museum, No. 448, Isle of Wight: *B. bicornis* Germ., British Museum, No. 432, "Europe": *B. juvenis* Erichs., Berlin Museum No. 841. A broken specimen on *B. obtusus* (Sharp Collection No. 1176) may perhaps also belong to this species. Whether this apparent form of *Texanus* should be considered identical with the short stout dark *H. Californicus*, and whether *H. Texanus* itself is more than a variety, I am unable definitely to decide without examining more abundant material. The types of *H. Californicus* are, however, numerous and in good condition and show no variation from the characters represented in my Monograph, Plate VII, figs. 1 and 2.

EUCANTHAROMYCES Thaxter.

Nine species have been added to this genus since the publication of the type-species *E. Atrani*, which probably illustrate the possible variations of its members more or less fully. The type of structure is a very constant and simple one; and, apart from certain differences in the cell relations, the modifications of the perithecial wall-cells and the conformation of the perithecial tip, the characters which appear to



be most reliable in distinguishing species are found in the antheridium. The number of rows of antheridial cells, and the number of cells in each row, are apparently very constant; variations in these respects, in a given species, occurring rather exceptionally. In some forms the antheridium may be the most complicated male organ that occurs in the whole group, with the exception of that in *Eumonoicomycetes* and possibly in some forms of *Haplomyces*; since, as in *E. Catoscopi*, there may be over fifty antheridial cells in a single antheridium. In certain other species, nevertheless, this number may be reduced one half or more, as in *E. Euprocti* or *E. spinosus*.

The structure of the antheridium appears to correspond in general to that of most of the other compound types. The antheridial cells are obliquely disposed in rows, usually three, more rarely four or even five, on either side; and their bases being external, they empty by short necks into an interior cavity, which connects directly with an efferent tube, through which the antherozoids are discharged in large numbers. The structure is closely comparable with that of *Haplomyces*, in which, however, the antheridia, not being separated by a sterile external marginal cell, surround the antheridial cavity completely.

An examination of Plate XXXVIII will show that there is a monotonous sameness among the species, which renders a very careful comparison of characters necessary in order to distinguish them. It should be noted that the spores, in many of the species at least, are peculiar in possessing a bluntly rounded apex, in place of the usual acuminate tip. The inner lip-cell is in general more or less distinctly modified, usually also more deeply colored, forming in many instances a more or less characteristic rounded prominence, as in figs. 28 and 36. The characteristic spine which persists in some species at the tip of the antheridium (Figs. 10 and 19) represents the apex of the spore, and is primarily terminal, as in *Stigmatomyces*, where it is almost invariably present. The ascogenic cells may be somewhat peculiar and in some species numerous. In *E. Catoscopi*, for example, as is indicated at the base of the perithecium in fig. 13, they are long erect subclavate and at least eight in number; while in some of the smaller species there do not appear to be more than four, or possibly two, in some cases. The species appear to be very generally distributed and the hosts are in all instances beetles belonging to the Carabidæ.

EUCANTHAROMYCES SPINOSUS Thaxter. Plate XXXVIII, figs. 17-20.

Proc. Am. Acad. Arts and Sci., Vol. XXXV, p. 416. April, 1900.

Perithecium straw-colored, rather stout, inflated, tapering to the broad asymmetrical tip which is slightly sulcate; the outer lips often larger than the inner, the latter more deeply colored and not very conspicuous; the stalk-cell rather short. Receptacle short, the cells nearly equal. Appendage much as in *E. Diaphori*, more slender, the marginal cell extending nearly to the base of the subbasal cell, distinctly enlarged below a terminal spine-like process, which is usually nearly erect; the antheridial cells in three rows of five, three (relatively large) and one to two cells respectively, the discharge tube large and broad, nearly truncate, bent abruptly upward from the base. Spores  $35-40 \times 3.5-4 \mu$ . Perithecia  $138 \times 41 \mu$ . Appendage  $70 \times 14 \mu$ , the antheridium  $35 \times 16 \mu$ . Receptacle  $50 \times 20 \mu$ . Total length to tip of perithecium  $190-207 \mu$ .

On elytron of *Drypta* sp., Paris Museum, No. 80. Java. On *Drypta lineola* Dej., Hong Kong; Berlin Museum, No. 950.

The antheridium in this species is perhaps the simplest thus far observed in the genus, the cells of the third row being apparently functionless and variable in form and number (one to three). The terminal spine stouter and larger, as a rule, even than that of *E. Diaphori*, the antheridium of which is otherwise very different. From its small size and pale color it is distinguished only with the greatest difficulty on the elytra of its host when dry.



## EUCANTHAROMYCES EUPROCTI Thaxter. Plate XXXVIII, figs. 27-30.

Proc. Am. Acad. Arts and Sci., Vol. XXXV, p. 417. April, 1900.

Perithecium straw-colored to pale amber-brown, slightly asymmetrical, somewhat inflated below; the upper half tapering gradually to the blunt asymmetrical apex, the inner lip-cell rounded flat darker amber-brownish slightly prominent; the outline of the mature perithecium becoming more or less corrugated through the appearance of three to five rather broadly rounded successive elevations, corresponding to the distal and basal septa of the two lower tiers of wall cells, and to a median protrusion of these cells, where five are present; stalk-cell becoming slender, mostly slightly shorter than the receptacle; the basal cells small. Receptacle relatively rather long, the cells nearly equal. Appendage generally longer than the receptacle, its basal and subbasal cells nearly equal; antheridial cells in three rows of five, three, and two cells each, the marginal cell bluntly rounded above and extending nearly to the base of the subbasal cell; the discharge-tube large, bent outward or obliquely upward. Spores  $50 \times 4.5 \mu$ . Perithecia  $160-170 \times 48 \mu$ , stalk-cell  $70 \times 15 \mu$ . Receptacle  $85-90 \times 25-30 \mu$ . Appendage  $110 \mu$ , antheridium  $41 \times 22 \mu$ , the discharge-tube  $30 \mu$ . Total length to tip of perithecium  $310 \mu$ .

On *Euproctus quadrinus* Bates, British Museum (Biologia Coll.), No. 731. Volcan de Chiriqui, Panama.

A few individuals of this species were found at the base of the elytra of the host. It is well marked by the abrupt distinction between the base of the perithecium and its stalk-cell, by the broad tip and stout somewhat irregular form of the latter, and by the small number of the antheridial cells.

## EUCANTHAROMYCES ATRANI Thaxter. Plate XXXVIII, figs. 1-3.

Additional material of this species has been obtained on specimens of *Atranius pubescens* from Washington, D. C., and from Kansas, in the collection of the U. S. National Museum. As this material is very much better than the types, both of which were immature or injured, additional figures are given herewith. The antheridium appears to be constant in structure, the rows of antheridial cells containing 6 (rarely 5), 4 and 3 cells respectively, the species is otherwise ill defined and without distinctive peculiarities. The antheridium may be distinguished by a slight terminal apiculus. It should be noted that the marginal cell of the antheridium is not septate above, as represented in Plate VII, fig. 27, of my Monograph.

## EUCANTHAROMYCES CALLIDÆ Thaxter. Plate XXXVIII, figs. 31-34.

Proc. Am. Acad. Arts and Sci., Vol. XXXV, p. 418. April, 1900.

Perithecium rather narrow, slightly inflated, tapering from about the middle to the blunt tip which is rather abruptly distinguished externally, sometimes bent outward, its distal margin outwardly oblique; the inner lip-cell relatively small, projecting slightly externally, but not abruptly distinguished on its inner side; the outline of the perithecium becoming inconspicuously corrugated through the presence of sometimes as many as eleven successive elevations; the basal cells elongated, the base of one of the outer external to the stalk-cell from which it is separated by an oblique septum longer than the width of the stalk-cell which is narrower below and about equal to the basal cells in length, or somewhat shorter. Receptacle symmetrically sulcate distally, rather long, the two cells nearly equal. Appendage rather long, its basal cell extending downward and lying external to the upper half of the subbasal cell of the receptacle; the subbasal cell more than twice as long as broad, the marginal cell reaching to its base and distally prominent. Antheridium relatively small, the antheridial cells in three rows of five (six in one instance), four, and three cells respectively, the discharge-tube rather short and stout, erect or bent but slightly. Spores  $40 \times 4 \mu$ . Perithecia  $230-265 \times 50 \mu$ , basal cells  $120 \mu$ , stalk-cell  $103 \mu$ . Receptacle  $100-120 \mu$ . Appendage  $120-125 \mu$ , antheridium  $25 \times 38 \mu$ . Total length to tip of perithecium average  $325 \mu$ .

On *Callida* sp., Paris Museum, No. 68, Venezuela; on *Callida tristis* Brullé, Berlin Museum, No. 974, Surinam.

A species distinguished by its generally slender habit, the large well distinguished tip of the perithecium and the parallelism between the stalk-cell of the appendage and the two cells of the receptacle. The figures are both drawn from the original types from Venezuela.



## EUCANTHAROMYCES AFRICANUS. Plate XXXIII, figs. 35-38.

Proc. Am. Acad. Arts and Sci., Vol. XXXV, p. 418. April, 1900.

Very similar to *E. Callidæ*. Amber-brown. Perithecium large subfusiform, the margins generally more or less distinctly corrugated, often marked by fine transverse striations which may be wholly absent, the tip relatively small and rather abruptly distinguished, the inner lip-cell well defined, projecting beyond the other lip-cells so that the apex usually appears oblique, asymmetrical and slightly sulcate; the basal cells somewhat shorter than the stalk-cell, their lower septa nearly equal and symmetrical, both slightly oblique. Receptacle of medium size, the basal cell distally enlarged lying beside the subbasal cell and extending to the stalk-cell of the perithecium. Appendage short, the two basal cells rather small and nearly equal in length, consisting of three rows of six, four, and four cells respectively, the discharge-tube slightly curved, abruptly nearly erect, distally somewhat narrower and conical when young, the marginal cell extending nearly to the base of the subbasal cell. Spores  $48 \times 5 \mu$ . Perithecia  $275-325 \times 45-50 \mu$ , the stalk-cell  $100-130 \mu$ , the basal cells  $75-100 \mu$ . Receptacle  $100 \times 26 \mu$ . Appendage  $100 \mu$ . Antheridium  $45 \times 21 \mu$ , the discharge tube  $21 \mu$ . Total length to tip of perithecium  $575-600 \mu$ .

On *Callida Natalensis* Hope, Hope Coll. No. 274, Natal, Africa. On *Callida* sp., Brit. Museum, No. 550, Angola, Africa. On elytra.

This species, which is closely allied to *E. Callidæ* may be distinguished by the different number of antheridial cells in its antheridium, the stalk-cell of which is differently related to the receptacle, as well as by the different relation which the stalk-cell bears to the basal cells of the perithecium. The latter also has a characteristic fusiform outline from the stalk-cell to the tips. Both figures are taken from the Natal material.

## EUCANTHAROMYCES MADAGASCARENSIS Thaxter. Plate XXXVIII, figs. 24-26.

Proc. Am. Acad. Arts and Sci., Vol. XLI, p. 306. July, 1905.

Rather pale straw-colored. Perithecium large, subcylindrical, tapering very slightly distally and basally, the rounded tip rather abruptly distinguished, and subtended by more or less distinct elevations; the trichophoric cell short, prominently rounded, but not extending beyond the lip-cells and rendering the apex subsymmetrical; the base not differentiated from the body of the receptacle, the cells relatively short, not extending down beside the stalk-cell, from which they are rather clearly distinguished: stalk-cell elongate, tapering below. Basal and subbasal cells of the receptacle of about equal length, the former about half as broad as the latter, and extending to the base of the stalk-cell of the perithecium. Basal cell of the appendage somewhat larger than the subbasal, slightly overlapping the subbasal cell of the receptacle, the marginal cell not prominent below the discharge-tube which is curved outward, sometimes horizontally; the antheridial cells in three rows of seven, seven, and five cells respectively. Spores about  $60 \times 4 \mu$ . Perithecium, including basal cells,  $385 \times 60-70 \mu$ , the stalk-cell  $275-290 \times 40-55 \mu$ . Receptacle  $165 \times 35-45 \mu$ . Antheridium, total length  $130-150 \times 30-35 \mu$ , above basal cell  $75 \mu$ .

On elytra of *Callida* sp., Madagascar; Hope Collection, No. 273.

The material of this species being very old has only regained its turgescence after the prolonged action of glycerine. It appears to be unlike any of the other species on *Callida*, and next to *E. Catascopi*, is the largest known form. It is distinguished by its slender form, the elongate stalk-cell of its perithecium, the tip of which is abruptly distinguished, and by the characters of its antheridial appendage.

## EUCANTHAROMYCES CASNONIÆ Thaxter. Plate XXXVIII, figs. 4-6.

Proc. Am. Acad. Arts and Sci., Vol. XXXV, p. 417. April, 1900.

Perithecium relatively large, rather long, often slender, inflated below, tapering to the relatively narrow blunt apex; its outline corrugated through the presence of from seven to eleven elevations varying in prominence some of which may become transversely striate at maturity, the basal cells elongated and as long or nearly as long as the rather stout stalk-cell. Receptacle relatively small. The basal and subbasal cells of the appendage relatively small and stout, nearly equal, or the latter somewhat smaller, the marginal



cell bordering its upper half and distally prominent, partly free and slightly inflated, ending in a short spine-like tip; the antheridium consisting of three rows of nine, seven and five cells respectively, the discharge-tube relatively short and stout, bent upward and over the prominent tip of the marginal cell. Spores  $45 \times 3.5 \mu$ . Perithecia  $240-260 \times 45-62 \mu$ , stalk-cell  $75-80 \times 20-28 \mu$ , basal cells  $75-100 \times 25-30 \mu$ . Receptacle  $55-65 \times 27 \mu$ . Appendage  $85-103 \mu$ , the antheridium  $50-60 \times 24-28 \mu$ . Total length to tip of perithecium  $375-450 \mu$ .

On *Casnonia subdistincta* Chaud., British Museum (Biologia Coll.), No. 704. Cordova, Mexico.

Allied to *C. Africanus* which it resembles in general form, but from which it is at once distinguished by the characters of the appendage.

EUCANTHAROMYCES CATASCOPI Thaxter. Plate XXXVIII, figs. 13-16.

Proc. Am. Acad. Arts and Sci., Vol. XXXV, p. 419. April, 1900.

Straw-colored becoming pale amber-brown. Perithecium elongate, tapering but slightly toward the tip, or becoming distally swollen through the pressure of the spore mass, the margins corrugated through the presence of sometimes as many as seventeen or even more prominences, which are mostly well defined, especially the distal one of the series and often distinctly rough-granular, above which the slightly bent tip is abruptly distinguished, its distal margin straight oblique, the outer and lateral lip-cells extending just beyond the small darker inner lip-cell; basal-cells very much elongated and often corrugated through the presence of six or more elevations; the stalk-cell rather stout, much shorter than the basal cells, from which it is separated by an outer very oblique, and an inner short nearly horizontal septum. Receptacle relatively small, the basal cell longer than the subbasal cell, distally enlarged so that it almost coincides with the base of the stalk-cell, which is thus hardly in contact with the subbasal cell from which it was originally derived. The basal cell of the appendage somewhat smaller than the subbasal cell, the marginal cell bulging outward slightly distally, and extending almost to the base of the subbasal cell. Antheridial cells in five rows of eight, seven, six, five, and four cells, or the four inner rows somewhat variable. Spores  $50 \times 4.5 \mu$ . Perithecia  $400-475 \times 60-70 \mu$ , the stalk-cell  $140-200 \times 35-40 \mu$ , the basal cells  $200-240 \mu$ . Receptacle  $100-110 \times 38 \mu$ . Appendage  $120 \mu$ ; antheridium  $60 \times 32 \mu$ . Total length  $680-950 \mu$ .

On *Catascopus* sp., Paris Museum, No. 117. Iles des Moluques. On the margin of the right elytron.

The largest and most striking species of the genus, the corrugated elevations of the perithecium, although sometimes partly obliterated by the copious spore formation, serving to distinguish it, apart from its other peculiarities. The ascogenic cells are remarkable from their subclavate form, at least eight being arranged in a rosette, as is indicated in fig. 13.

EUCANTHAROMYCES DIAPHORI Thaxter. Plate XXXVIII, figs. 8-12.

Proc. Am. Acad. Arts and Sci., Vol. XXXV, p. 416. April, 1900.

Pale straw-colored. Perithecium rather short and stout, its basal cells small, slightly and usually symmetrically inflated; tapering slightly from about the middle to the broad blunt slightly asymmetrical tip, the flat inner lip-cell, small, lateral, and subterminal, bearing distally a slender recurved rigid appendage (not cellular) about  $8-9 \mu$  long. Receptacle rather short and stout, the subbasal (anterior) cell somewhat stouter than the basal, the two together somewhat larger than the short stalk-cell of the perithecium. Appendage relatively large, its basal cell short subtriangular, the upper and lower septa oblique, the subbasal cell slightly longer than broad, its upper two thirds bordered by the marginal cell which terminates in a slender stiff straight spine-like process about  $11-12 \mu$  long and slightly divergent; the antheridial cells in five rows of five, four, three, three, and two cells respectively; a single additional cell sometimes persisting above the antheridial cavity; the discharge tube bent outward and slightly upward, the tip bluntly conical with a slight basal enlargement. Spores  $40 \times 3.5 \mu$ . Perithecia  $120 \times 30 \mu$ . Stalk-cell  $30 \times 18 \mu$ . Appendage  $70 \mu$  long, the antheridium  $28 \times 21 \mu$ . Receptacle  $45 \times 24 \mu$ . Total length to tip of perithecium  $180 \mu$ .



On mid-elytron of *Diaphorus tenuicornis* Chaud., British Museum (Biologia Coll.), No. 714, Oaxaca, Mexico.

This species is represented by three or four individuals in good condition and is distinguished by its antheridial appendage, as well as by the short recurved appendage which subtends the tip of the perithecium on the inner side and appears to arise from the inner lip-cell, which is lateral and overtopped by the three others which appear to form the whole apex. This appendage may represent the indurated base of a trichogyne, the position of which in this genus may be unusual, but I have no available material which can determine this point. The terminal spine of the antheridium is long and conspicuous. In one specimen there seem to be only four rows of antheridial cells of five, four, four and three cells each.

**EUCANTHAROMYCES XANTHOPHÆÆ** Thaxter. Plate XXXVIII, figs. 21–23.

Proc. Am. Acad. Arts and Sci., Vol. XXXVII, p. 26. June, 1901.

Perithecium (not fully mature) straw colored, somewhat asymmetrical, almost symmetrically and but slightly inflated from base to apex; the tip short, well distinguished; the lip-cells rounded, and slightly inflated, forming a knob-like termination, one of them (the inner) protruding in the form of a slight tongue-like projection beyond the others: the stalk-cell about as long as the receptacle, from which it projects at an angle, being moreover turned at the same time a little to one side. The cells of the receptacle subequal, lying side by side, the basal one extending to the base of the stalk-cell of the perithecium, with which it is in contact. Appendage relatively large, the stalk-cell subtriangular, somewhat larger than the basal cell which is wholly overlapped externally by the well defined and distally somewhat inflated marginal cell; the antheridial cells in four tiers of seven, six, five and four cells respectively; the discharge-tube long and curved outward. Spores about  $36 \times 4 \mu$ . Perithecia  $165 \times 50 \mu$ , the stalk-cell  $46 \times 20 \mu$ . The appendage to tip of discharge-tube  $120 \mu$ , the antheridium proper  $55 \times 30 \mu$ . Total length to tip of perithecium  $290 \mu$ .

On the right inferior margin of the prothorax of *Xanthophæa vittata* Dej., Australia. Berlin Museum, No. 973.

The material of this species consists of but two specimens in which the perithecium is not quite mature. It cannot, however, be confused with either of the other species in which there are more than three rows of antheridial cells.

**KLEIDIOMYCES** Nov. Gen.

Receptacle consisting of two superposed cells, the basal cell (in the type) producing two characteristic outgrowths, the subbasal giving rise to antheridial appendages and to perithecia. The appendage consisting of a stalk-cell followed by a pair of cells with which a small compound antheridium is associated distally, the appendage ending in a free cellular extremity above the antheridium. The stalked perithecium similar to that of *Monoicomycetes*.

This genus, which has been named from the resemblance which its peculiar outgrowths bear to a "wish bone," certainly cannot be retained in *Monoicomycetes*, to which the single species was originally referred provisionally, since the antheridia in the two cases are quite different. The appendage, represented in fig. 4 of the accompanying plate, was obtained by crushing one of the three available specimens, and although little beyond the projecting lateral discharge-tube can be made out in detail, the other characters of the organ are sufficiently evident. The sterile termination appears to consist of three coherent rows of small cells, and in the type (fig. 3) two of these appendages are produced in addition to the perithecium. The peculiar outgrowths above referred to, which are so characteristic in the type are probably without significance generically, and are entirely comparable to the single outgrowth which arises from the basal cell in *Corethromyces Stilici*.



**Kleidiomyces furcillatus** nov. comb. Plate XXXVII, figs. 3-4.

*Monoicomyces furcillatus* Thaxter, Proc. Am. Acad. Arts and Sci., Vol. XXXVII, p. 24. June, 1901.

Receptacle consisting of two small cells which are hardly distinguishable owing to a general blackish brown suffusion; producing on either side, from the basal cell, a stout blackened outgrowth, the two forming a nearly symmetrical fork-like structure, the prongs of which are slightly curved inward and slightly divergent. From near the base of these outgrowths, and between them, arise, apparently from single basal cells on either side, stalked perithecia and appendages. Antheridial appendage rather slender, shorter than the perithecia. Perithecia long and slender, straight, symmetrical, pale yellowish, slightly inflated toward the base, tapering gradually to the blunt apex. Spores about  $40 \times 3 \mu$ . Perithecia  $135 \times 27 \mu$ . Outgrowth from the receptacle  $110 \times 12 \mu$ .

Near the tip of the abdomen of *Aleochara repetita* Sharp. Panama, Sharp Coll., No. 1095.

Only one of the three individuals obtained is in fairly good condition, but the species is so very peculiar in appearance that it can hardly be mistaken for any other form. Owing to the great reduction of the receptacle and its deep suffusion, it has not been possible to determine absolutely the exact origin of the fork-like outgrowths which seem to come from the basal cell, as in *Corethromyces Stilici*.

## EUHAPLOMYCES Thaxter.

Proc. Am. Acad. Arts and Sci., Vol. XXXVII, p. 25. June, 1901.

Receptacle consisting of two cells, the upper bearing a free stalked antheridium and a stalked perithecium. Antheridium conical, consisting of a single stalk-cell followed by a basal cell from which is separated a group of smaller cells some of which (two or four?) extend upward and inward to form antheridial cells: above these follow three external marginal cells, the lowest of which lies beside the antheridial cells; the uppermost succeeded by a conical chamber which terminates in a pore, and extends downward along the inner sides of the marginal cells to form a cavity into which the antheridial cells empty. Perithecium resembling that of *Haplomyces* in the type.

This genus appears to be somewhat closely related to *Haplomyces*, *Cantharomyces* and *Camptomyces*, but the structure of its antheridium is essentially different from that of either of these genera. The number of antheridial cells is small, not more than four or five, and it is somewhat difficult to distinguish them from the adjacent sterile cells. The passage for the discharge of the antherozoids seems to be formed by the disorganization of more than one cell, and as may be seen in fig. 21 lies on the inner (left) side of certain sterile cells; but distally occupies the whole tip. The antheridial cells, as indicated, converge to the base of this cavity and empty into it, but this is shown in one instance only in the figure.

## EUHAPLOMYCES ANCYROPHORI Thaxter. Plate XXXVII, figs. 19-21.

Proc. Am. Acad. Arts and Sci., Vol. XXXVII, p. 25. June, 1901.

Receptacle small, the basal cell somewhat longer, nearly hyaline, tapering to the relatively small foot; the subbasal cell becoming pale amber-brown. Antheridium, including its short stalk-cell, about as long as the receptacle, becoming pale amber-brown, tapering to a pointed apex. Perithecium becoming pale amber-brown, relatively large, thick-walled, considerably and abruptly inflated above the basal cells, somewhat asymmetrical, tapering rather evenly to the blunt apex; the stalk-cell long, thick-walled, slightly curved, nearly hyaline, distally somewhat broader, not distinguished from the basal cells. Spores about  $40-45 \times 3.5 \mu$ . Perithecia  $180-200 \times 72-82 \mu$ ; the stalk-cell  $110-120 \times 28-30 \mu$ . Antheridium, including the stalk-cell,  $55-65 \mu$ . Total length to tip of perithecium  $360 \mu$ .

On the superior surface of the abdomen of *Ancyrophorus aureus*. Dumfriesshire, Scotland, Sharp Collection, No. 1091.

## CANTHAROMYCES Thaxter.

A single British species has been added to this genus which is evidently most closely allied to *Haplomyces* and *Eucantharomyces*. No further data have been obtained in regard to the distribution of the



species, except that the range of *C. pusillus* is extended to Florida, where specimens were obtained on the margin of Lake Eustis, at Eustis. Specimens of *C. Bledii* were also obtained in the collection of the National Museum on *Bledius annularis* Lec. from Iowa, and on *B. nitidicollis* Lec. from Michigan.

The generic type is a clearly defined one, but the species are very variable in respect to the number of antheridial cells in the lateral group, which is characteristic in all cases. An extreme case of this variation is seen in the species described below, in which the antheridium proper is made up of perhaps not more than three or four cells.

CANTHAROMYCES PLATYSTETHI Thaxter. Plate XXXVII, figs. 5-6.

Proc. Am. Acad. Arts. and Sci., Vol. XXXV, p. 415. April, 1900.

Yellowish with a brownish tinge. Receptacle consisting of a small basal cell and a subbasal cell more than twice as large, bearing the perithecium and appendage. Perithecium borne on a rather long stalk-cell, the basal cells continuous with its main body which is inflated below, conical above, the narrow apex truncate or bluntly rounded. The appendage large, its subbasal cell nearly twice as long as the basal, bearing the very small antheridium which forms a short cellular margin below its upper inner angle and apparently consists of not more than ten cells; the subbasal cell terminated by an irregular series of small cells which appear to produce a tuft of branches distally, and from which it may sometimes be separated by a third cell similar to it. Perithecia  $80-86 \times 35 \mu$ . The stalk-cell  $55 \times 20 \mu$ . Receptacle  $50-70 \times 28 \mu$ . Appendages  $140-170 \mu$ .

On abdomen of *Platystethus cornutus* Grav., British Museum, No. 449, Kilburn, England.

This species is most nearly related to *C. occidentalis* which it closely resembles in general form. It is distinguished, however, by the greatly reduced antheridium, which can sometimes hardly be made out in mature specimens, as well as by the distal enlargement of the basal cell of the appendage. The material of this species is unfortunately scanty and in poor condition, the sterile terminal branches of this appendage being broken off in every case.

## LABOULBENIACEÆ.

Genera monœcious or dioecious, the antheridia simple, clearly differentiated, solitary or grouped, free or adnate, but discharging their sperm-cells independently.

HERPOMYCES Thaxter.

Proc. Am. Acad. Arts and Sci., Vol. XXXVIII, p. 11. June, 1902.

Sexual organs normally separated on different individuals. Antheridia simple.

*Male individual* consisting of several (four) superposed cells terminated by a characteristically modified spinous, or by a small foot-like process, or by both; the basal cell attached by a small normal blackened foot: one or more of the distal cells giving rise to short branches which may bear from one to several antheridia terminally, or become more or less copiously branched; the branchlets terminated by antheridia, or in some cases sterile. Antheridia long, flask-shaped. The subbasal cell of the receptacle sometimes producing a fertile branch, as in the female individual, from which are produced secondary receptacles which give rise to antheridial branches.

*Female individual* consisting primarily of several superposed cells similarly modified at the tip, and attached by a small normal foot; the basal and subbasal cells constituting a "primary receptacle," the latter giving rise to a variably developed fertile branch (sometimes apparently dividing to several cells, each of which may produce a fertile branch) from which is developed a single "secondary receptacle," or, as a result of branching, more than one. Secondary receptacles consisting of a partly double series of cells, variable in number, one or more of which may be fertile, the rest sometimes specially differentiated, or unmodified; those in contact with the host, perforating the chitinous integument by means of fine haustoria. Trichogynes short filamentous simple or sparingly branched. Perithecium borne on variably developed stalk-cells, the ascigerous portion including three tiers of wall-cells, more or less clearly distinguished from the distal portion, the wall-cells of which are more or less differentiated, four or five in each



row. Spores minute, of the usual type, normally discharged in pairs the members of which produce male and female individuals. Asci apparently eight-spored?

The discovery of this remarkable genus is due to Mr. Charles Bullard, who first observed it on *Ectobia*. It is unlike all others thus far described from the fact that, in all the species, one or both of the sexes produce secondary receptacles, corresponding to the fertile branches of other genera, which, instead of growing free and depending on the primary foot for their nutrition, attach themselves to the host and become quite independent as far as their food-supply is concerned. Both the primary foot, and the cells of the secondary receptacle, which are in contact with the host, penetrate the latter by means of a simple cylindrical slender rhizoids, readily visible, especially in forms which grow, or begin their growth, as is more often the case, on the usually transparent spines or bristles projecting from the integument of the insect (Plate XXXIX, figs. 3-4, and XLI, fig. 8).

In nearly all cases the original infection appears to take place on one of these bristles, and here, as in other dioecious species, the spores are normally discharged in pairs, the members of which develop side by side (Plate XLI, fig. 17), and grow into male and female individuals respectively (fig. 14). In some species both individuals complete their development on one of these bristles as in *H. chatophilus*, fig. 14; but, in a majority of cases, a fertile branch from the subbasal cell of the primary receptacle of the female, grows downward till it reaches the host's integument, before any production of perithecia begins. More frequently this fertile branch becomes furcate as soon as it leaves the bristle, the two secondary branches being transformed into secondary peritheciogenous receptacles, and in several species two paired perithecia are thus produced, one from each of the secondary receptacles, symmetrically placed at the base of the spine (Plate XXXIX, fig. 9, and Plate XLI, fig. 2). In other cases the secondary receptacles are more highly developed, creeping rather extensively, but never branching, and always growing through the activity of a single terminal cell. Such multicellular secondary receptacles may give rise to numerous perithecia, and this type arrives at its highest development in forms like *H. Ectobiæ* (Plate XXXIX, figs. 11-12) and in *H. tricuspидatus* (Plate XL, fig. 13). In some forms, also, the secondary receptacles may be more than two, and appear to arise not as branches from the primary fertile branch, but independently. In such cases the subbasal cell of the primary receptacle evidently undergoes secondary divisions, and each of the resultant cells sends down its fertile branch to form a corresponding number of secondary receptacles. I have found it almost impossible to determine this connection by actual observation, but that the secondary receptacles are multiplied in this fashion seems evident from the appearance of detached primary receptacles such as are represented in fig. 10, Plate XL, or fig. 12, Plate XLI.

That still another type exists is indicated by the conditions seen in *H. Paranensis* and *H. Nyctoboræ*. Although both these species are closely allied to *H. tricuspидatus*, their secondary receptacles are not continuous cell-series, as in this species (Plate XL, fig. 11), but each perithecium is associated with a shield-like receptacle (Plate XXXIX, fig. 5 and Plate XL, fig. 3). These shield-like structures appear to be quite independent of one another, but that they do not arise, as in the type last described, from distinct branches representing outgrowths from a corresponding cell formed by secondary divisions of the subbasal cell of the primary receptacle, is evident from the conditions seen in isolated primary receptacles (Plate XL, fig. 5) from which but a single branch has been developed in the usual fashion. Whether these shield-like structures arise as branchlets from the primary branch, or whether they are to be considered intercalary modifications of it, I have as yet been unable to determine. The former alternative, however, appears to be the more probable.

A curious condition is also illustrated by *H. Periplanetæ*, which is the most easily obtained and commonest member of the genus. In the typical form of this species a remarkable shield- or shell-like structure is developed, that completely covers the secondary receptacles of the female individuals, which are seated on the integument of the host (Plate XLI, figs. 6-7). This shield-like structure is evidently an up-growth from one of the secondary receptacles that compose the group, and is a very characteristic and highly specialized structure. When, however, this species develops wholly on the bristle, and the primary



fertile branch is unable, or barely able, to reach its base, a curious variety of conditions may result; the most striking difference being indicated by such a form as is illustrated in fig. 8, Plate XLI, in which the whole habit of growth of the secondary receptacle is changed, becoming identical with that of types like *H. chatophilus* (fig. 14). A form which has barely reached the base of the bristle is represented in fig. 10, and in this instance a rudimentary shield has been formed, while in fig. 9, one more fully, though somewhat abnormally developed, is present. Enough transitional conditions have been examined to make it evident that figs. 7 and 8 represent individuals of the same species. The existence of such remarkable variations in a single species indicates that it is necessary to use considerable caution in determining the limitations of species in this genus.

The male individuals vary greatly in their development; some, like *H. chatophilus*, producing only one or two antheridia directly from the typical four-celled primary receptacle; while others may show much greater complication; the most highly developed type being illustrated by *H. Ectobiæ*, the secondary male receptacles of which may produce several hundred antheridia. The latter, in all species are similar to others of the simple type, usually elongate and often showing no very marked distinction between the neck and venter. In a single specimen of *H. Paranensis* the development of antheridia from a single receptacle has been observed; an abnormal condition which finds a parallel among hermaphrodite forms, in which antheridia occasionally replace perithecia, as has been already illustrated in my former Monograph.

The generic type of *Herpomyces* appears to be very well defined, and although in *H. Ectobiæ* the presence of creeping secondary receptacles in the male, as well as in the female, tends to set this form apart from the others, it should be remarked that the same condition occurs in *H. Anaplectæ*. Such male receptacles in this species are, however, rudimentary, and the antheridia are generally produced from the primary receptacle. The immediate affinities of the genus are not apparent, and there appears to be no obvious connection between it and the other dioecious genera with simple antheridia (*Amorphomyces* and *Dioicomycetes*). Although the habit of producing fertile branches which grow horizontally from the primary receptacle is found in other dioecious genera like *Dimorphomyces*, there is no other instance in the whole group in which nutrition is effected by means of secondary attachments to the host. It is not difficult, however, to imagine how a form like *Dimorphomyces Thleopora*, for example, might originate a somewhat similar condition through the production from its fertile branch of rhizoidal attachments; since it already lies in contact with the surface of the host. Among the known dioecious forms, however, which are characterized by simple antheridia and with which the members of the present genus would be naturally supposed to be more closely associated than with any of the other genera, one finds no tendency toward the formation of such fertile branches, and their other characters vary widely from those of *Herpomyces*. The structure of the perithecium and the relatively greater complication in the general structure of both sexes might be assumed to place it higher in the scale than either *Amorphomyces* or *Dioicomycetes*, although the occurrence of a series of forms on Blattidæ, which are supposed to be representatives of one of the most ancient types of true insects, might perhaps have been expected to be correlated with a more primitive type in the parasite. But although the unisexual forms with simple antheridia might for some reasons be assumed to be the more primitive, the present genus is distinguished by a far more complicated structure than the other unisexual forms of the same type, and *Amorphomyces* still remains, as has been pointed out above, by far the simplest in structure of all the Laboulbeniales.

Although I have as yet been unable definitely to determine this point, the number of spores in an ascus appears to be eight, and if this is the case, it is a character shared only by *Moschomyces* and *Comp-somyces*. It may be of interest to note that these genera present a further resemblance in possessing more than usually numerous wall-cells in their perithecia. In one other respect the present genus is unique, namely in the possession of a peculiar blackish foot-like process near or beside the terminal spinous process which is often conspicuous at the tip of the primary receptacle (Plate XLI, figs. 10, 14, 18). The significance of this appendage I am unable to suggest. Although very characteristic, it may sometimes be absent.



The Blattidæ, which are the only hosts of *Herpomyces*, are common in buildings, especially on water fronts and abound especially in tropical regions. Many species occur under logs and under bark and are often numerous in rubbish or under stones. The Croton Bug and the Cockroaches are familiar household pests throughout the world, and all serve as hosts for members of this interesting genus.

HERPOMYCES CHÆTOPHILUS Thaxter. Plate XLI, figs. 14-18.  
Proc. Am. Acad. Arts and Sci., Vol. XXXVIII, p. 12. June, 1902.

*Male individual* consisting of four superposed cells, hyaline, the distal cell terminated by a blackish projection similar to the small foot. The three distal cells, sometimes only the terminal one, usually producing slight outgrowths which bear the single, nearly erect, long, slender antheridia directly; or may separate a cell which bears one or very rarely two such antheridia; the latter nearly as long as the four-celled individual. Total length to tips of antheridia 50-55  $\mu$ .

*Female individual.* Primary individual similar to the male, but stouter; terminated by a similar blackish projection. The fertile branch arising laterally from the subbasal cell, growing down in the form of a slender filament variable in length, usually of two or three cells, enlarging abruptly to form the single secondary receptacle. Secondary receptacle pale dirty brownish yellow, consisting of a vertical series of cells partly double above, simple below; the cells thick-walled, the long (transverse) axes directed obliquely upward and outward, about five to fifteen in number, their points of contact with the host surrounded by a slightly blackened irregular foot-like haustorial margin, and giving rise to single simple, or very rarely branched, haustoria which penetrate the wall of the spine at right angles to its surface; the cells all sterile with the exception of the proximal one from which arises the solitary, nearly erect perithecium. Perithecium relatively large, rather stout; the ascigerous portion large, slightly inflated, longer than the outwardly curved distal portion, which tapers to the bluntly pointed unmodified apex; the tip bent abruptly outward. Spores 30-35  $\times$  3  $\mu$ . Perithecia 125-185  $\times$  35-48  $\mu$ . Total length of primary individual 35-40  $\mu$ . Secondary receptacle 35-75  $\times$  22  $\mu$ .

On spines of legs, antennæ and anal appendages of *Periplaneta* sp., Zanzibar, Africa; Mus. Comp. Zoöl. On *Periplaneta* sp., Mauritius; Mus. Comp. Zoöl., No. 1357.

This species, which is taken as the type of the genus, appears to be perhaps its simplest form, and is distinguished by its solitary perithecium, the tip of which is unarmed and bent outward, as well as by its vertically developed secondary receptacle. It has not been observed on any other of the many individuals examined of its supposedly cosmopolitan host. Its general habit is closely approached by chætophilous forms of *H. Periplanetæ* (fig. 8), but the perithecia are quite different in the two species.

HERPOMYCES PERIPLANETÆ Thaxter. Plate XLI, figs. 6-13.  
Proc. Am. Acad. Arts and Sci., Vol. XXXVIII, p. 13. June, 1902.

Very variable according to the host and the position of growth.

*Male individual* consisting of four superposed cells, the two upper, in simpler individuals, producing one or two antheridia which are either sessile or borne on a single stalk-cell: in more highly developed individuals the two distal cells producing short branches which may bear several antheridia directly, or on secondary branchlets, some of which appear to be occasionally sterile; the total number of antheridia sometimes six or more. Greatest length of well-developed forms, to tips of antheridia, 90  $\mu$ , of small specimens 60  $\mu$ .

*Female individual*, hyaline or nearly so. Primary receptacle surmounted by two or more sterile cells, the uppermost often asymmetrical, ending in a terminal spinous process and bearing the minute characteristic black projection laterally: the subbasal cell sometimes several times divided, each resultant cell apparently giving rise to a single branch from which is developed the very variable secondary receptacle. Secondary receptacle: *in simple individuals growing on spines of host*; consisting of a vertical series of from four to twenty or more obliquely superposed cells, alternating to form a double row, otherwise similar to that of *H. chætophilus* and like it producing a single erect perithecium from one of its uppermost cells:



in individuals growing on the integument of host; producing a variable number of fertile branches, disposed subhorizontally on either side of the primary receptacle, the peritheciigerous cells, of which there may be from one to six, together with the male individual when present, and the bases of the perithecia, protected by a shield- or shell-like, usually very unequally bilobed cellular upgrowth, rounded or bluntly pointed above, the symmetrically curved successive cells which compose it enormously elongated transversely, their lumen scarcely wider than the intervening walls and forming a series of concentrically arranged arcs, the concavities directed downward. Perithecia one to six, commonly five in well-developed specimens, slightly divergent from the median line, long, pointed, tapering from the slightly, more or less asymmetrically inflated base; the distal portion not clearly differentiated, tapering more or less, curved, the slender upper portion bent abruptly inward toward the tip; the pointed apex bent inward, subtended externally by a terminal, slightly incurved, rather slender, bluntly pointed unicellular process, the cells of the cell row which it terminates distinctly larger than the other wall-cells; basal cells somewhat prominent. Spores  $16 \times 1.5 \mu$ . Perithecia  $145-220 \times 30-36 \mu$ , the process  $14 \mu$ . Secondary receptacle, including protective shield, in well-developed individuals  $125 \times 75 \mu$ ; in small specimens  $35 \times 50 \mu$ ; when vertically developed without shield  $35-110 \times 18 \mu$ .

On *Periplaneta Americana* Sauss. (type form), Cambridge (Mr. Bullard): Bermuda, Mus. Comp. Zoöl. On *Periplaneta Australasiæ* Sauss., Bermuda. On *Periplaneta* spp., Mexico, West Indies, Panama, Brazil, Africa, South Seas, China. All Mus. Comp. Zoöl. On *Stylopyga orientalis* Scudd., Boston, Mus. Comp. Zoöl.

This common, and in its typical condition, very striking form, appears to be as universally distributed as are its cosmopolitan hosts. It is remarkable for its variability on different hosts or in different positions on the same host. Thus the shell-like shield of the typical form is very frequently absent in specimens on *Stylopyga*, the form represented in fig. 8, being that which occurs most commonly on this host, while on *Periplaneta* it is rarely seen. On *Stylopyga*, moreover, the shield-like covering, when it is developed at all, is usually much smaller than in individuals growing on *Periplaneta*, and the number of perithecia is usually less. In individuals of the type represented in fig. 8, one often finds instances in which two secondary receptacles have developed from the primary one, each producing its solitary perithecium, the two seeming to be paired.

In the normal typical form (fig. 7) the cells beneath the shield are so closely compacted that I have not been able to satisfy myself as to the exact relations of the structures developed from the female primary receptacle. As in other cases, however, the subbasal cell of the latter seems to cut off a number of cells distally, each of which produces a fertile branch (fig. 12); there being usually five such branches, as shown in the figure; the lower cell, at the left in this figure, being the basal cell of the receptacle from which the foot is broken. If each of these branches produced its single perithecium one would have the condition seen in fig. 7, which is that usually found, the individual bearing five perithecia; one, supposedly, from each branch. Where less than five occur, as often happens, it may be assumed that a smaller number of branches have been developed from the subbasal cell.

A comparison of figs. 10, 9 and 7 will show how the typically bilobed shield is produced by growth of one of the secondary receptacles upward and outward, on both sides, but much more so on the right than on the left. The form of the perithecium in this species and the position and character of its terminal spine, distinguish it from all others, even in cases (fig. 8) where the normal shield has not been developed. The hosts are the common brown and black roaches and the fungus is usually conspicuous from its white color, growing in tufts, especially on the antennæ.

HERPOMYCES PLATYZOSTERIE Thaxter. Plate XXXIX, figs. 3-4.

Proc. Am. Acad. Arts and Sci., Vol. XLI, p. 310. July, 1905.

Male individual consisting of four superposed cells bearing distally one or several antheridia. Total length to tip of antheridia about  $40 \mu$ .



*Female individual*, colorless. Primary receptacle consisting of four superposed cells, the terminal one acuminate; the subbasal giving rise to a branch which produces a single secondary receptacle, made up of a vertical series of cells, obliquely superposed, and variable in number, giving rise above to a solitary perithecium. Perithecium erect, bent inward toward the seta on which the individual grows, the ascigerous portion hardly, or not at all, inflated; the distal portion curved outward, tapering to the pointed apex, which is subtended on the inner side by a stout, bluntly rounded projection, about as long as the free apex of the perithecium, which extends outward at right angles from its base. Total length to tip of subterminal projection 160–225  $\mu$ . Perithecium  $150 \times 33 \mu$ , its terminal process  $10 \times 3.5 \mu$ .

On the antennal setæ of *Platyzosteria ingens* Scud., Mexico; Scudder Collection, No. 1384.

In the conformation of its perithecial tip this species resembles *H. Zanzibarinus* more nearly than any other species. The perithecial appendage or subterminal process is, however, blunt or even slightly enlarged distally. The host is a large wingless roach, species of which are very common in Florida; but although, through the kindness of Professor Rolfs, I have had an opportunity to look over numerous specimens from Miami, I have been unable to discover any parasites on them.

HERPOMYCES ZANZIBARINUS Thaxter. Plate XL, figs. 8–10.

Proc. Am. Acad. Arts and Sci., Vol. XXXVIII, p. 15. June, 1902.

*Male individual* consisting of four cells, the distal one furnished with a sharp colorless terminal spine and a small blackish subterminal process, both of which become pushed to one side by the development of one, or sometimes two, sessile antheridia; the subterminal cell somewhat larger, sterile, or producing an antheridium laterally. Total length  $28 \times 6.5 \mu$ . Antheridia  $25 \mu$ .

*Female individual* colorless. Primary receptacle surmounted by two sterile cells, the upper terminated by a sharp spinous process subtended by a blackish process, as in the male: the subbasal cell apparently divided at least once, the two, or more, cells producing a fertile branch from which two few-celled, paired, compact secondary receptacles are produced, secondary fertile branches sometimes arising from division, of the subbasal cell; each of which bears a single perithecium, the cells rather irregular, about five or six in number, subhorizontal in position, without characteristic modification. Ascigerous portion of the perithecium relatively stout, inflated on its inner side, almost twice as long as the distal portion, which tapers from it rather abruptly: distal portion curved inward abruptly at the pointed tip, which diverges from an erect blunt unicellular process which subtends it, at an angle of more than  $90^\circ$ . Perithecium, including base, to tip of terminal process,  $125 \times 28\text{--}32 \mu$ ; the process  $10 \mu$  long. The pair of fertile receptacles together about  $30\text{--}35 \times 45 \mu$  broad (horizontally).

On the antenna of a large black wingless roach, Zanzibar, Africa; Mus. Comp. Zoöl., No. 1354.

This species is most nearly allied to *H. Platyzosteriæ* from which it differs in its smaller size, paired habit, and in other structural details.

HERPOMYCES ARIETINUS Thaxter. Plate XL, fig. 7.

Proc. Am. Acad. Arts and Sci., Vol. XXXVIII, p. 14. June, 1902.

*Male individual* consisting of four superposed cells, the basal one relatively long; the distal ones bearing two to three antheridia. Length about  $29 \mu$ . Antheridia about  $20 \mu$ .

*Female individual* hyaline. Primary receptacle surmounted by two sterile cells, the upper terminated by an erect distally mucronate appendage; the subbasal cell, and often one or two cells which may be separated from it above, giving rise each to a branch which becomes immediately furcate; each branch producing a secondary receptacle. Secondary receptacles, symmetrically paired or several, each consisting of a horizontal series of about twelve or more vertically elongated, subfusiform, more or less curved cells, corresponding to and external to the fertile cell which bears the primary perithecium, the external margin free. Ascigerous portion of the perithecium relatively long, hardly inflated, tapering slightly above, where it passes into the distal portion; which is about half as long, tapers slightly, and is terminated by an incurved, tongue-like, slender, subcylindrical prolongation of the apex on the inner



side, and by a relatively long straight erect slightly tapering subtending terminal unicellular spine-like process. Spores about  $20 \times 2 \mu$ . Perithecia  $100 \times 22 \mu$ , the terminal process  $18 \mu$ . Secondary receptacles, together,  $55 \times 18 \mu$ .

On the antenna of a small brown wingless roach (probably *Temnopteryx* sp.) taken under stones and bark near the mouth of the Mammoth Cave, Kentucky; Mus. Comp. Zoöl., No. 1370 Type. On *Temnopteryx* sp., Prouts Neck, Mass., No. 1380, and Georgia, No. 1382, Scudder Collection. On *Ischnoptera* sp., Georgia, No. 1386, Scudder Collection.

This species is easily distinguished by the relatively large and long terminal spine, and the elongate nearly cylindrical slender tip of the perithecium. The secondary receptacles are usually paired, but several may develop, generally behind the first two; and appear to arise from secondary fertile branches from the receptacle. The secondary receptacles are sometimes more closely cellular and somewhat larger relatively, than is shown in fig. 7; but the species appears to be otherwise quite constant on all the hosts mentioned.

HERPOMYCES DIPLOPTERÆ Thaxter. Plate XLI, figs. 1–5.

Proc. Am. Acad. Arts and Sci., Vol. XXXVIII, p. 16. June, 1902.

*Male individual*; four-celled, the two middle cells roundish-oblong, the distal longer and subcylindrical, terminated by the usual minute blackish projection; the subterminal and subbasal cells each producing one or two nearly sessile, or short-stalked, antheridia, with well differentiated slender necks. Total length to tips of antheridia about  $50 \mu$ .

*Female individual*. Primary receptacle similar to male, the subterminal and subbasal cells subcylindrical, longer than broad; the fertile branch producing two symmetrically placed secondary receptacles, the sterile external cells yellowish, somewhat larger and more distinct, about twelve or more in number; the series extending externally and inferiorly to form a free buttress-like margin, which almost wholly covers the single fertile cell. Perithecium yellowish, straight, nearly erect, the base bulging very slightly; but hardly broader than the ascigerous part, which is relatively large, long, subcylindrical, or slightly inflated; the distal part, relatively short, rather abruptly distinguished; the posterior cell-row, which is external in relation to the host, more prominent, with larger thick-walled cells, the fifth from below prolonged to form a long, bluntly tipped, erect, horn-like, subterminal projection, distally curved inward above the short slightly incurved pointed subconical tip. Total length of perithecium (exclusive of base) to tip of process  $150 \mu$ ; to tip  $115 \mu$ : ascigerous part  $70\text{--}75 \times 28\text{--}30 \mu$ , distal part to tip  $35\text{--}40 \mu$ ; the process, free part,  $25\text{--}30 \mu$ , whole cell  $40\text{--}44 \mu$ . Secondary receptacles both together  $55\text{--}65 \times 25 \mu$ . Total length to tip of process  $175\text{--}185 \mu$ .

On antennæ of *Diploptera dityscoides* Serv., Ascension Island, South Atlantic; Mus. Comp. Zoöl., No. 1371.

The secondary receptacles are paired in all the individuals of this species which have been examined, and are relatively small; the body of the perithecium is nearly isodiametric till it narrows suddenly to the relatively short, abruptly distinguished distal portion, which is terminated by the relatively long curved spine; the tip short and subconical. It is otherwise very similar to *II. arietinus*.

HERPOMYCES PHYLLODROMIÆ Thaxter. Plate XXXIX, figs. 1–2.

Proc. Am. Acad. Arts and Sci., Vol. XLI, p. 310. July, 1905.

*Male individual* consisting of four superposed cells: producing distally one or several antheridia directly. Total length about  $30 \mu$ .

*Female individual*. Colorless, the primary receptacle minute, consisting of four subequal cells: the subbasal sending down a branch which furcates to produce a pair of small secondary receptacles, consisting of only two or three vertically elongated cells and each bearing a solitary perithecium. Perithecia more or less symmetrically placed, the ascigerous portion slightly inflated, tapering above to the somewhat slender distal portion, which bends abruptly outward from the substratum, diverging but



slightly; the tip subtended by a blunt pointed spine-like projection, directed nearly at right angles to the axis of the free tip. Primary receptacle about  $25 \mu$  long. Secondary receptacle  $20 \times 10 \mu$ . Perithecium, to tip of process, about  $80-100 \times 15-20 \mu$ .

On antennæ of *Phyllodromia* sp., Abyssinia; Scudder Collection, No. 1381.

This is a small and rather insignificant species of which the material is not very abundant. Though resembling *H. Anaplectæ* in some respects, and like it in possessing a very small secondary receptacle, the spinose tip of the latter and the very simple male individuals recall the conditions seen in *H. Zanzibarinus*. It is unlike other species owing to the slight divergence of the paired perithecia and their strong tendency to bend outward from the substratum. An examination of more abundant material may show that the male individual is not in all cases so simple as in the individual represented in fig. 2.

HERPOMYCES ECTOBLE Thaxter. Plate XXXIX, figs. 11-16.

Proc. Am. Acad. Arts and Sci., Vol. XXXVIII, p. 20. June, 1902.

*Male individual* consisting of four superposed cells terminated by the characteristic blackish projection, the distal cells producing a dense appressed tuft of coherent antheridial branchlets and antheridia; the subbasal cell usually giving rise to a fertile branch, simple or furcate, which produces secondary male receptacles consisting of irregularly double straggling series of cells, some of which are sterile, while others bear short-stalked, unilateral, dense antheridial tufts similar to the primary one (which may sometimes be lacking?).

*Female individual* colorless. Primary receptacle as in the male, terminated by two short cells, the upper of which bears distally the characteristic blackish minute foot-like projection, the subbasal cell producing a simple or furcate fertile branch. The fertile receptacles, like those of the male, often creeping extensively, consisting of an irregularly double series of obliquely seriate cells, sterile or fertile without definite sequence, the whole plant producing sometimes twelve or even more perithecia, developed as a rule in irregularly acropetal succession. Perithecia sessile, inflated below, attenuated above, the extremity bent or sometimes slightly recurved, the apex unmodified. Spores  $20 \times 2.5 \mu$ . Perithecia, including base,  $80-90 \times 20 \mu$ . Total length of secondary receptacle, longer,  $200-225 \times 15 \mu$ . Primary individual  $22 \mu$ .

On *Ectobia Germanica* Scudd., Cambridge, Mr. Bullard. On *Ectobia* sp., Zanzibar; Mus. Comp. Zool., No. 1357; St. Kitts, West Indies; Mus. Comp. Zool., No. 1361.

Since repent males and females usually grow together, the antheridia and perithecia often appear to arise from one plant, but this is never the actual condition. The species can hardly be confused with any other, unless perhaps with *H. Anaplectæ*, to which it is most nearly allied; but from which it may be distinguished by the repent habit in both sexes, and by the shape of the perithecia. The species is doubtless as widely distributed as is its cosmopolitan host, the common "water bug" or "Croton bug" well known to housewives.

HERPOMYCES ANAPLECTÆ Thaxter. Plate XXXIX, figs. 9-10.

Proc. Am. Acad. Arts and Sci., Vol. XLI, p. 309. July, 1905.

*Male individual* consisting of four superposed cells, the two or three upper ones becoming variably branched, and bearing a variable number of antheridia on the branchlets; the subbasal cell apparently in some cases producing one or two small secondary receptacles, each of which bears an irregular tuft of antheridia. Total length, including antheridia,  $35-50 \mu$ . Antheridia  $24 \times 2 \mu$ .

*Female individual* hyaline. Primary receptacle mostly 4-celled, the distal cell at first long, conical, mucronate, becoming more or less collapsed and irregular at maturity; the subbasal giving rise to a branch from which are formed a pair of small secondary receptacles, each producing a single perithecium; the two symmetrically placed, and symmetrically curved away from the axis of the primary receptacle. Perithecium long, slender, tapering from below the middle to its attenuated apex; the transverse boundaries of the wall-cells often indicated in the middle region by more or less distinct elevations, the apex unmodi-



fied, blunt. Primary receptacle  $25 \times 3 \mu$ . Secondary receptacle  $16 \times 13 \mu$ . Perithecium  $80 \times 90 \times 16 \mu$ . Spores about  $18 \times 2 \mu$ .

On the antennæ of a species of *Anaplecta* allied to *A. Dohrinana*, collected under stones along the margin of a stream near Caracas, Venezuela, by Dr. A. F. Blakeslee.

This species is most nearly allied to *II. Ectobiæ* and occurs on a related host. The male individual sometimes produces a short branch from the subbasal cell which gives rise to a small secondary receptacle (or perhaps in some individuals to two, through furcation), bearing small tufts of antheridial branches. In the female the perithecia are very regularly and symmetrically paired as shown in fig. 9, the secondary receptacles, in marked contrast to those of *II. Ectobiæ*, being less well developed than in any other species.

HERPOMYCES FORFICULARIS Thaxter. Plate XL, figs. 18–22.

Proc. Am. Acad. Arts and Sci., Vol. XXXVIII, p. 15. June, 1902.

*Male individual* minute, consisting of four superposed cells, the three upper subequal, nearly round, constricted at the septa, the distal one terminated by a short bluntly pointed appendage resembling a minute foot, which is commonly turned to one side by the development laterally from the same cell of a single slender antheridium. Total length  $18 \times 5 \mu$ . The antheridium about  $35 \mu$ .

*Female individual.* Primary receptacle consisting of two superposed cells terminated by a single abruptly smaller sterile cell, which is slightly longer than broad and is terminated by a bluntly pointed appendage similar to that of the male, but larger; the subbasal cell much enlarged, somewhat inflated, the fertile branch at once furcate so that two secondary receptacles are formed symmetrically placed on either side of and just below the primary receptacle. Secondary receptacles distinctly yellowish externally, consisting of a nearly horizontal series of about ten sterile cells, very narrow from the great elongation of their transverse axes which are vertical in position, and so arranged as to cover more or less completely the single fertile cell, which is subtriangular and gives rise to a solitary perithecium. Base of the perithecium nearly as broad as the secondary receptacle, forming a short stout neck: perithecium relatively large, the ascigerous portion somewhat longer than the distal part, very slightly inflated, nearly isodiametric, the base of the trichogyne persistent as a rather conspicuous hyaline projection between it and the distal part which is but slightly narrower, hardly tapering, the large lateral cells thick-walled, the rows similar on either side and terminating in large incurved tapering bluntly pointed brownish-yellow unicellular projections, which surmount the perithecium like a pair of mandibles, the inner somewhat shorter and straighter: the short, pointed apex included between their bases and bent slightly inward. Spores about  $18 \times 2 \mu$ . Perithecia including base  $200 \times 36 \mu$ ; the terminal projections, longer,  $35 \mu$ . Secondary receptacles  $35 \times 20\text{--}35 \mu$ . Primary receptacle including sterile terminal cell  $20 \times 7 \mu$ . Total length to tip of perithecium  $220\text{--}250 \mu$ .

On antennæ of a wingless roach, Mauritius (?); Mus. Comp. Zoöl., No. 1353.

This curious form is readily distinguished by its perithecium which is relatively long and broad and is terminated by two incurved subequal caliper-like processes on either side of the tip, thus presenting an appearance seen in no other species. It is most nearly allied to *H. tricuspидatus*, *II. Paranensis* and *II. Nyctoboræ*, but lacks the third spinous process seen in these species, and is otherwise widely different. In all the specimens examined the secondary receptacles are regularly paired as in fig. 18.

HERPOMYCES TRICUSPIDATUS Thaxter. Plate XL, figs. 11–17.

Proc. Am. Acad. Arts and Sci., Vol. XXXVIII, p. 17. June, 1902.

*Male individual* variably developed, the terminal cell rounded, apiculate, but as a rule soon indistinguishable through proliferation of the cells below, the simple forms producing few antheridia, although in most instances, through continued successive proliferation, a dense compact more or less appressed tuft is formed. Antheridium long flask-shaped, hardly distinguished from the usually several-celled branchlet which it terminates. Total length to tips of antheridia  $75 \mu$ .

*Female individual.* Primary receptacle small, surmounted by two rounded cells constricted at the



septa, the distal one bearing a small sharp spine subtended by the usual minute blackish projection: the subbasal cell producing apparently a single fertile branch which divides at once, growing in opposite directions to form the somewhat irregular, and variably developed continuous secondary receptacles, which may creep more or less extensively; the component cells, which are often very numerous, being vertically elongated and becoming arranged in two more or less complete rows; the inner mostly fertile, producing perithecia of which there may be twelve or rarely more; the outer becoming several times closely divided vertically, the cell-group which thus gives rise to the perithecial stalk, laterally connected with corresponding adjacent cell-groups throughout its lower third only, the upper two thirds forming a free, or nearly free, continuation of the perithecial stalk, forming no free protective margin above, while below they develop a continuous, irregularly lobed, spreading haustorial margin in close contact with the host. Perithecia raised on a well-developed stalk, consisting of two unequal and asymmetrical cells placed side by side; that on the side toward which the tip of the perithecium is bent (anterior) attenuated below and extending higher than the posterior, which becomes narrower upward from its broad base; the stalk becoming gradually and slightly broader from below upward, and directly continued by the base of the perithecium from which it is not distinguished. Ascigerous portion of the perithecium distinguished from the base by a very slight prominence, and about as long as the stalk and base combined; becoming distally slightly broader, the two lower tiers of wall-cells separated by a slight elevation; the third wall-cell of the anterior row small, and forming a prominent elevation followed by a depression which subtends a large, erect, tapering, bluntly pointed, distally incurved spinous process, formed by an outgrowth of the lowest cell in the anterior row of wall-cells of the distal portion (fourth anterior wall-cell), which extends upward higher than the tip of the perithecium, its upper two thirds forming a free spine; the lower cell of one of the corresponding lateral rows (fourth lateral wall-cells) producing a similar process, shorter, slightly sharper, curved inward distally toward the apical pore, this process always external in relation to the host and thus developed on the right or left side according as the perithecium is formed from the receptacle at the left or at the right of the original insertion toward which the anterior sides of all the perithecia are turned: the rest of the terminal portion above the bases of these outgrowths short, abruptly tapering, its outer margin vertical, slightly prominent and not distinguished from the posterior margin of the ascigerous portion, which is directly continued by it; its inner margin running abruptly inward and upward from the base of the anterior process to the small blunt tip, which is curved abruptly inward and is subtended by a nearly erect, short, sharp spinous process; the whole nearly symmetrical with the anterior process which is very slightly longer. Spores about  $12 \mu$  long. Perithecia, ascigerous portion  $45-50 \times 25 \mu$ , terminal part to tip  $28 \mu$ , anterior process  $30-34 \mu$ , apical process  $8 \mu$ , stalk, including basal cells,  $45-58 \times 16-18 \mu$ . Total horizontal extent of larger individuals including both receptacles  $220 \mu$ . Fertile cells below perithecial stalks  $30-40 \times 13-15 \mu$ . Total height to tip of perithecial process  $175-200 \mu$ .

On *Blabera* sp. and *Epilampra* (?) sp., Panama; Mus. Comp. Zoöl., No. 1364. On *Epilampra* sp., No. 1360, St. Kitts, W. I. (type), No. 1366, Hayti. On a wingless form labelled "China?" All Mus. Comp. Zoöl., and in all cases on the antennæ.

Although the perithecia of this species resemble very closely those of *H. Nyctoboræ* in the disposition of their spinous processes, the general form of the perithecium is quite different. The latter are further borne on long stalk-cells which occur neither in *H. Nyctoboræ* nor in the nearly allied *H. Paranensis*. It differs also from all of the other bi- or tri-cuspidate forms in the structure and mode of growth of its secondary receptacles. The perithecia appear to mature more or less simultaneously; at least I have seen no instances in which young and mature perithecia were associated on the same individual. The male individuals vary considerably in their development, some producing perhaps a dozen antheridia, or less, while in others a dense tuft is present containing many times this number.



## HERPOMYCES NYCTOBORÆ Thaxter. Plate XXXIX, figs. 5–8.

Proc. Am. Acad. Arts and Sci., Vol. XLI, p. 309. July, 1905.

*Male individual.* Axis consisting of five or six cells, the basal somewhat elongate, the rest short and somewhat rounded, the terminal one abruptly apiculate; the distal cells producing branches which in turn branch three to four times, the ultimate branchlets bearing the antheridia terminally in groups, the whole forming a dense tuft. Axis about  $54 \times 10 \mu$ , the total length to the tips of the antheridia about  $100 \mu$ . Antheridia  $20 \times 3 \mu$ .

*Female individual.* Colorless, the primary receptacle consisting of four or five cells, the terminal one short and apiculate; the subbasal (perhaps others also?) giving rise to branches which produce a variable number of secondary receptacles arranged with the younger behind the older, as in *H. Paranensis*. The secondary receptacles much as in *H. Paranensis*, the first formed broadest. Perithecium long and slender, tapering, especially above the middle; the stalk-cells flattened, so that the perithecium is almost sessile on the receptacle; the ascigerous portion often abruptly somewhat narrower than the base, the fourth lateral external wall-cell bearing a long curved attenuated wholly free spine-like cell, which extends just beyond a subterminal short distally incurved sharp spinous process, which subtends, and is nearly twice as long as, the free curved tip of the perithecium: the fourth anterior wall-cell also producing a long curved spinous process, slightly shorter than the lateral one, or more divergent. Secondary receptacles  $65 \times 45-50 \mu$ . Base and stalk-cells of perithecium  $30-35 \times 15-18 \mu$ , the ascigerous part to tip of longest spine  $150-165 \mu$ : width near base  $20-25 \mu$ , below lower spine  $10-12 \mu$ ; external spine  $50 \mu$ , terminal spine  $12 \mu$ .

On antennæ of *Nyctobora latipennis*, Texas; Scudder Collection, No. 1383.

This species is closely allied to *H. Paranensis*, from which it differs in its more highly developed male individuals, and in the form and structure of its perithecium. The slender tapering habit, and the arrangement of the spines in relation to the tip, being quite different; although the form and arrangement of the secondary receptacles are very similar.

## HERPOMYCES PARANENSIS Thaxter. Plate XL, figs. 1–6.

Proc. Am. Acad. Arts and Sci., Vol. XXXVIII, p. 19. June, 1902.

*Male individual.* Terminal cell distally modified to form a long slender flexuous tapering unicellular prolongation extending above the tips of the antheridia which are few in number, terminal on rather long often several-celled branchlets. Total length to tip of terminal prolongation  $250 \mu$ ; the prolongation  $185 \mu$ . Antheridia about  $60-70 \mu$ .

*Female individual.* Primary receptacle very small, the distal cells rounded, the uppermost prolonged as in the male. First secondary receptacles developed on either side of the primary, those formed later lying behind them on either side so that the perithecia are more or less clustered (younger ones appearing behind the two primary ones), and each secondary receptacle developing a shield-like structure external to the base of the first fertile cell, like a buttress, the outer and upper margins of which are free, consisting of sterile cells which are greatly elongated vertically and very narrow, similar and successively fewer-celled buttresses being formed behind the primary one in connection with each of the remaining perithecia, of which there may be from four to six or more. Perithecia very similar to those of *H. tricuspidatus*, but with the following differences: the greatly elongated fertile cell of the receptacle extends nearly to the base of the perithecium, the posterior stalk-cell extending downward beside it nearly to its base, covered by the protective shield except at its distal end, which is connected by a narrow isthmus with an abrupt short broad terminal enlargement; the anterior stalk-cell small, short, subtriangular in outline; the base of the perithecium abruptly somewhat broader, its cells protruding more or less distinctly; the ascigerous region thus somewhat clearly distinguished, especially posteriorly, relatively distinctly larger than in *H. tricuspidatus* somewhat inflated; the conformation of the distal portion similar in general, but the third wall-cell of the anterior row is not modified to form a prominence at the



base of the anterior spiniferous cell, the upper half of which forms a free spinous process slightly incurved distally and equalled or even exceeded by the lateral spinous process: the free tip of the perithecium about twice as long relatively, slightly incurved, the erect incurved spinous process, which subtends it externally, more than twice as long as that of *H. 3-cuspidatus* and sublateral; the tip between the base of this spine and the inner angle of the anterior spine relatively shorter and broader. Spores about  $15 \times 1.6 \mu$ . Perithecium: ascigerous portion  $58 \times 30 \mu$ ; terminal portion to tip,  $40 \mu$ ; anterior process, free portion,  $22-25 \mu$ , whole cell,  $50-54 \mu$ ; subterminal process, free part,  $17 \mu$ ; total length,  $123 \mu$ , including basal cells. Width of two outer buttresses together  $85-100 \mu$ ; height of shield-like upgrowth  $36-50 \mu$ ; length from insertion to base of perithecium  $60-80 \mu$ ; total length from insertion to tip of perithecial spine  $180-218 \mu$ .

On antenna of a wingless roach *Blabera* sp., Para, Brazil; Mus. Comp. Zoöl., No. 1362; on *Blabera* sp., Mexico, Scudder Collection.

As has been previously mentioned, the primary receptacle of this species appears to give rise to one branch only (fig. 5), and is very small and otherwise peculiar, the terminal cell greatly elongated and tapering. The fertile branch becomes furcate at once, and the groups of buttressed perithecia seem to result from continued secondary branching; the first pair of secondary receptacles that is produced being anterior and more highly developed, shielding the later ones which arise behind them. The development of the perithecia in these secondary receptacles does not appear to be so simultaneous as it is in other species, *H. Periplanetæ* for example; since very young perithecia are often associated in the same individual with others that are fully matured.

The present form is most nearly allied to *H. Diplopteræ* which is characterized by the same mode of growth, but possesses very different perithecia, and also to *H. tricuspoidatus* in which the habit of growth is quite unlike either of these species.

#### AMORPHOMYCES Thaxter.

The single described species of this genus still remains the simplest of all the types thus far discovered and unique in possessing spores which are continuous. Whether this simplicity should be considered indicative of a primitive condition or as due to a process of reduction, it is quite impossible to say. The species has been seen from various localities in New England where it is common and has also been received from Ohio. Certain undescribed forms are also known from South America, which adhere strictly to the type of *A. Falagriæ*.

#### DIOICOMYCES Thaxter.

Proc. Am. Acad. Arts and Sci., Vol. XXXVII, p. 33. June, 1901.

*Male individual* consisting of four superposed cells, the upper of which is a simple antheridium bearing a subterminal discharge tube.

*Female individual.* Receptacle ending in a peculiarly modified sterile prominence, corresponding to the upper spore-segment: the subbasal cell producing a single perithecium laterally, and separated from the sterile terminal cell by a second small cell. Perithecium free, stalked; the ascogenic cell single, the spores more or less obliquely once-septate, and of two kinds corresponding to the sexes.

This genus is distinguished from *Amorphomyces*, to which it is closely allied, by its obliquely septate spores; as well as by the fact that its perithecium, instead of being terminal, arises laterally below two sterile cells which terminate the receptacle. The subterminal origin of the discharge tube of the antheridium is a further and apparently constant difference; while the presence in the male individual of four, in place of three, cells, serves to separate the two genera at once. The difference in size between the male and female spores is usually very striking, Plate XLII, figs. 24, 25 and 29, and as in the other dioecious genera, one almost invariably finds that the two have been discharged simultaneously and have developed side by side. When the discharge of spores has been copious, however, and the individuals are



growing in a more or less crowded condition, this pairing of the sexes may not be so clearly marked, but it is noticeable that female spores which have begun to develop in positions where there are no male individuals in close proximity tend to abort.

The trichogynes of this genus which have been examined are of the simple type illustrated in fig. 23, and consist of two cells that form a thick-walled inflated structure, from the distal end of which the small thin-walled receptive papilla is developed in close proximity to the end of the discharge tube of the male individual, a condition almost exactly similar to that found in *Enarthromyces*. Abnormal males rarely occur in which a second antheridium may be formed below the first, but such conditions are exceptional. The male individuals in the different species are all very similar and with the exception of *D. Floridanus*, which is unusually large and possesses a very long discharge tube, can hardly be distinguished from one another. The species, which are probably more numerous than might be supposed from the small number of described forms, have thus far been found only on Staphylinidæ and on Anthicidæ, small beetles inhabiting vegetable refuse of various sorts, and sometimes swept from flowers.

DIOICOMYCES ANTHICI Thaxter. Plate XLII, figs. 18–25.

Proc. Am. Acad. Arts and Sci., Vol. XXXVII, p. 33. June, 1901.

*Male individual.* Form slender, of nearly the same diameter throughout, the basal cell half the total length of the individual to the tip of the discharge-tube; the third cell nearly square, the subbasal about as large as the terminal antheridial cell, which ends in a distal blunt projection; the discharge-tube arising laterally below the tip, projecting upward from a broadened base, slightly divergent from the main axis, slender, about as long, or a little longer than, the body of the antheridial cell. Length to tip of antheridial cell, including foot,  $50\ \mu$ : to tip of discharge-tube  $60\ \mu$ . Width  $8\ \mu$ .

*Female individual.* Often more or less strongly curved, the terminal sterile cell bluntly pointed, slightly curved, brownish; the basal cell becoming narrower below, the upper septum convex; tinged with brown posteriorly as is the rest of the receptacle: the subbasal cell very small, subtriangular; separated from the terminal sterile cell by a somewhat smaller triangular cell. Stalk-cell of the perithecium hyaline, long, often about the same diameter throughout; the thick wall becoming gradually thicker distally: the perithecium slightly inflated, faintly brownish; the short, stout, broad, blunt tip slightly distinguished, and nearly symmetrical; the lip-cells forming an unbroken outline, without protrusions. Spores (male)  $40 \times 4\ \mu$ , (female)  $60 \times 6\ \mu$ . Perithecium  $100\text{--}110 \times 35\text{--}45\ \mu$ , the stalk-cell  $75\text{--}115 \times 18\ \mu$ . Receptacle including foot  $35 \times 12\ \mu$ , the sterile terminal cell  $18\text{--}25 \times 7\text{--}9\ \mu$ . Total length to tip of perithecium  $185\text{--}220\ \mu$ .

On *Anthicus floralis* Linn. Fresh Pond, Cambridge. On *A. Californicus* Laf. California (Leconte Collection).

Of the three species which occur on *Anthicus* this is decidedly the most common and has been obtained in abundance near Fresh Pond where the hosts were found in piles of hay or weed. It usually occurs near the tips of the elytra and is subject to little variation. It is most nearly allied to *D. onchophorus*, but is easily distinguished by its perithecial characters. All of the three species which inhabit this host are sometimes found together on a single individual, but occupy more or less restricted regions.

DIOICOMYCES ONCHOPHORUS Thaxter. Plate XLII, figs. 26–29.

Proc. Am. Acad. Arts and Sci., Vol. XXXVII, p. 34. June, 1901.

*Male individual* similar to that of *D. Anthici*, slightly smaller.

*Female individual.* Usually strongly curved, especially at the base of the stalk-cell; similar to *D. Anthici*; the receptacle, sterile cell, and the stalk of the perithecium, relatively smaller. Perithecium dirty brown, one of the lip-cells protruding in the form of a well defined, lateral, finger-like, erect, straight, or slightly curved, blunt-tipped, concolorous process; an irregular anterior elevation or angular prominence is also more or less well defined above the middle of the perithecium. Spores (male)  $35 \times 4\ \mu$ , (female)  $45 \times 5\ \mu$ . Perithecia to tip of projection  $125\text{--}140 \times 40\text{--}45\ \mu$ , the stalk-cell  $90\ \mu$ . Total length to tip of perithecium  $210\text{--}230\ \mu$ .



Usually on the basal half or at the base of the left elytron of *Anthicus floralis* Linn. Fresh Pond, Cambridge.

This species is readily distinguished by the characters of its perithecium, the general form of which is unlike that of the related *D. Anthici*, and which bears a terminal prominence not found in any other species. The sterile cell of the receptacle is also as a rule more pointed than in other species, and relatively somewhat smaller, and the perithecial stalk-cell is usually abruptly bent or twisted. It is less common than either of the other species on this host.

DIOICOMYCES SPINIGERUS Thaxter. Plate XLII, figs. 30-34.

Proc. Am. Acad. Arts and Sci., Vol. XXXVII, p. 34. June, 1901.

*Male individual* similar to that of *D. Anthici*, much smaller, the extremity less prominent, or almost horizontal, the discharge tube somewhat more slender, and more often erect. Total length including foot  $40 \times 6.5 \mu$ ; to tip of discharge-tube  $47 \mu$ .

*Female individual*. Receptacle relatively small, tinged with dirty yellowish, edged with brown to the tip of the small terminal sterile cell. Perithecium dirty yellowish and relatively large, considerably and more or less symmetrically inflated, above and including its basal cells, to the base of the tip, which is bent abruptly outward at right angles to the axis of the perithecium; the apex broad, blunt, the lip-cells hardly projecting: a unicellular brown, straight or slightly curved, spine-like process, which tapers to a blunt point, projects upward at an angle of about  $45^\circ$  from the middle of the outer (anterior) margin of the perithecium; and a slight elevation is also more or less distinct between its base and that of the tip; the stalk-cell, relatively short, becoming rapidly narrower toward its base. Spores (male)  $26 \times 4 \mu$ , (female)  $40 \times 6 \mu$ . Perithecia including basal cells  $125 \times 50 \mu$ , the spinous process  $55 \mu$ , the stalk-cell  $36-40 \mu$ . Receptacle to tip of sterile cell about  $45 \mu$ . Total length to tip of perithecium about  $185 \mu$ .

On *Anthicus floralis* Linn., with the last two species, more commonly on the inferior surface of the abdomen. Fresh Pond, Cambridge.

This species is the most peculiar member of the genus and is at once distinguished by the spine-like outgrowth from one of the anterior perithecial wall-cells, as well as by other characters. It is a rather rare species, but sufficiently abundant material has been examined to show that its characters are quite constant.

DIOICOMYCES FLORIDANUS Thaxter. Plate XLII, figs. 35-36.

Proc. Am. Acad. Arts and Sci., Vol. XXXVII, p. 33. June, 1901. *Amorphomyces Floridanus* Thaxter, l. c., Vol. XXVIII, p. 159.

*Male individual*. Relatively large, long, brown, the discharge-tube long slender curved, the tip of the antheridial cell prominent beyond its base. Length  $55 \times 8 \mu$ ; the discharge-tube  $24 \mu$ .

*Female individual*. Color brown. Perithecium stout strongly curved inward the upper half nearly straight and symmetrical blunt-tipped; the stalk-cells lightly inflated, nearly isodiametric. Receptacle normal. Perithecium about  $150 \times 50 \mu$ . Total length about  $200 \mu$ . Receptacle to tip of sterile cell, including foot,  $65 \mu$ .

Type on abdomen of *Bledius basalis* Lec., Florida, Henshaw Collection: on *Bledius* sp., Ipswich, Mass.

This species was originally described from a single female individual from Florida under the genus *Amorphomyces*, but proves to correspond in all respects to the type of the present genus. A single pair has been obtained from a small *Bledius* collected by Mr. Emerton on the sand dunes at Ipswich, and the male proves to be somewhat different from those of the other species in its brown color, larger relative size, and elongate curved discharge-tube. The female resembles that of *D. Anthici* more closely than it does either of the other species, but differs in its stouter form and the nearly isodiametric stalk-cell of its perithecium, as well as in its darker brown color.



DIOICOMYCES OBLIQUESEPTATUS Thaxter. Plate XLII, figs. 16–17.

Proc. Am. Acad. Arts and Sci., Vol. XXXVII, p. 33. June, 1901. *Amorphomyces obliqueseptatus* Thaxter, l. c., Vol. XXXV, p. 431. April, 1900.

*Male individual*, unknown.

*Female individual*, straw colored tinged with amber-brown. The perithecium broadly inflated at the base, becoming gradually narrower distally, the tip broad blunt asymmetrical; the apex somewhat oblique, the asci and spores in great numbers, filling the perithecium and developed from a single ascogenic cell. Spores obliquely septate,  $40 \times 7 \mu$ . Perithecium  $200 \times 55-60 \mu$ .

On the antennæ of an undetermined staphylinid perhaps near *Myrmedonia*, British Museum No. 398, Ega, Amazon River.

This form is undoubtedly a species of *Dioicomycetes* as is indicated by its obliquely septate spores, and it is evident that practically the whole of the receptacle was broken off when the specimens were removed from the host. It is needless to say that the species would not have been described had this been evident at the time of its publication. Although thus based on a perithecium merely, with its stalk-cell and an adherent fragment of the receptacle, there should be no difficulty in its future recognition. The host was a very peculiar staphylinid among the Miscellanea in the British Museum, and was nearly allied to *Myrmedonia*.

#### SMERINGOMYCES nov. gen.

*Male (?) individual*: bristle-like consisting of several superposed cells.

*Female (?) individual*. Receptacle consisting of three or four superposed cells bearing a single terminal perithecium, the subbasal cell subtended by a bristle-like appendage, the cells above it also bearing similar appendages. Perithecium appendiculate, its cavity becoming continuous with that of the stalk-cell.

The type of this genus was provisionally placed in *Rhachomyces*, but there can be no doubt as to its distinctness, although it resembles it in possessing a receptacle consisting of superposed cells bearing bristle-like appendages. There being no other genus in which it can be even provisionally placed, I have reluctantly made a new one for its reception, although an adequate diagnosis is as yet impossible owing to a lack of any knowledge as to its antheridial characters. The form is rare and at the same time very minute, and I have as yet been unable to obtain young material in sufficient quantities to determine what these antheridial characters are. In all cases where this could be determined, the perithecigerous individual has been accompanied by a small bristle-like individual developed from the other member of the spore pair. This may represent an atrophied condition of an hermaphrodite individual, or may be a male. I have in no case seen paired normal individuals, which if they occurred, would indicate that the spores were not different in a given pair. The small individual resembles very closely the primary bristle-like appendage of the normal type, but possesses a very small foot. It is so opaque that I have found it impossible in the material examined to determine whether there is any structure which might be interpreted as an antheridium. It is also true that in no normal individual have I seen anything that could be similarly interpreted; yet in either case, owing to the small size and opacity of the structures involved, an antheridium might be present and yet be visible only in especially favorable individuals. That it is probably a unisexual type is indicated by the peculiar characters of its perithecium, the absorption of the basal cells of the latter, which results in making its cavity continuous with that of the stalk-cell, being a phenomenon seen only in dioecious genera. For this reason and in the absence of definite information to the contrary I have placed the genus provisionally in its present connection.

The youngest individual examined consists of four superposed cells terminated by a primary bristle-like appendage which seems to correspond to the appendage which at maturity occupies a position at the base of the perithecium. The third cell appears to produce appendages distally, and the fourth to give rise to the perithecium and the rest of the appendages, but the series of specimens is not complete enough to determine these matters with exactness. The axis is thus not of secondary origin as in *Rhachomyces*.



**Smeringomyces anomalus** nov. comb. Plate XLII, figs. 41-42.*Rhachomyces anomalus* Thaxter. Proc. Am. Acad. Arts and Sci., Vol. XXXVIII, p. 25. June, 1902.

Male (?) individual bristle-like, composed of about four superposed cells, nearly opaque, slender, tapering to the hardly differentiated small pointed foot.

Female (?) individual. Receptacle relatively small, consisting primarily of four superposed cells, tapering slightly to the relatively large pointed foot. The basal cell relatively large, the third bearing distally and posteriorly one or two stout bristle-like, simple, rigid, black-brown, hyaline-tipped appendages; the fourth cell becoming divided to several smaller cells from which arise, a usually less suffused primary external appendage, the perithecium, and one or two secondary bristle-like appendages: the appendages about five in all, relatively large, appressed, together more or less completely surrounding the base of the perithecium and extending nearly to its tip. Perithecium tinged with purplish brown, or nearly hyaline, the body relatively long, very slightly inflated, broader distally, tapering slightly to the blunt tip, from which the apex forms a long pointed, hyaline, lateral or subterminal projection toward a large curved, horn-like, stout, hyaline outgrowth of the perithecium, which, arising externally just below the tip, extends upward beyond the apex over which it is slightly recurved (or more rarely curved away from the tip), ending in a bluntly pointed extremity. Spores  $46 \times 4 \mu$ . Perithecia  $75-90 \times 20-25 \mu$ , the outgrowth  $35-45 \times 14 \mu$ . The longer appendages  $75 \mu$ . Receptacles  $35-45 \mu$ . Total length to tip of perithecium  $110-125 \mu$ .

On *Conosoma pubescens* Payk., Waverley, Mass.

This species grows appressed on the scattered bristles which cover the body of its host and appears to be rather rare. Though minute, its form is strikingly peculiar owing to the beak-like apex and horn-like appendage of its perithecium. It is often associated on the same individual with the more common *Stichomyces Conosomæ*. The host is a small and very active Staphylinid which is found commonly in rotten wood.

## ACOMPSOMYCES Thaxter.

Proc. Am. Acad. Arts and Sci., Vol. XXXVII, p. 37. June, 1901.

Receptacle two-celled, bearing an antheridial branch terminally and a single perithecium laterally. Antheridial appendage consisting of a stalk-cell wholly united to the receptacle, or nearly so, and three superposed cells which form the appendage proper: the terminal cell bearing distally a single spinose antheridium, the subterminal cell sterile and the lowest cell bearing distally two or three antheridia. Perithecium furnished with a stalk-cell, five and six wall-cells being present in the rows. Trichogyne producing clavate branches which bear distally several nearly spherical receptive papillæ.

Although the type of this genus is a very simple one, and the species differ within very narrow limits, it is extremely well marked, and essentially constant. The appendage, except for the sterile subterminal cell, is very like a simple form of *Stigmatomyces*, though the antheridia with their characteristic outcurved necks are not all produced on the same side of the appendage as in this genus, with which, however, it seems closely allied. The appearances seen in the original type (*A. Corticariæ*) of which but a single specimen was obtained, gave the impression that in this genus, as in *Dimorphomyces* or *Dimeromyces*, the basal cells of the perithecium became disorganized, so that the cavity of the stalk-cell and perithecium were confluent. Sufficient material, however, of other forms, shows that this is not the case, the basal cells being clearly defined at maturity. The species all appear to be rare, at least an examination of great numbers of hosts has yielded very few infested specimens, and in only two instances have young individuals been found. Three specimens, however, bear trichogynes (figs. 8 and 12, Plate XLII) that are unique from the peculiar differentiation of the receptive parts which appear as terminal spherical vesicles, as shown in the figures. The hosts are the smallest, with the exception of *Trichopteryx*, on which Laboulbeniæ have been found, and are common in piles of weed or grass etc.



## ACOMPSOMYCES CORTICARIÆ Thaxter. Plate XLII, fig. 5.

Proc. Am. Acad. Arts and Sci., Vol. XXXVII, p. 37. June, 1901.

Receptacle narrow below, distally enlarged, hyaline; the subbasal cell small. Basal cell of the appendage brown, distally narrowed to the base of the appendage proper, which is brown, and consists of three symmetrical cells, the upper smaller, bearing a terminal antheridium, the lower bearing several antheridia somewhat irregularly. Perithecium brown, rather abruptly distinguished from the short hyaline stalk; the tip very broad and darker; the lip-cells forming four hyaline-tipped, nearly symmetrical papillæ which terminate four corresponding ridges. Spores about  $30 \times 2 \mu$ . Perithecia  $90 \times 26 \mu$ , the stalk  $15 \mu$ . Receptacle  $25 \mu$ . Antheridial appendage, above stalk-cell, and including terminal antheridium,  $40 \mu$ .

On elytron of *Corticaria* sp. Berkeley, California.

This species is well distinguished by its color and form and especially the conformation of the tip of the perithecium. The unique type was found on a small *Corticaria* in a lot of small flies collected by sweeping near Berkeley.

## ACOMPSOMYCES BRUNNEOLUS Thaxter. Plate XLII, figs. 10-12.

Proc. Am. Acad. Arts and Sci., Vol. XLI, p. 311. July, 1905.

Colorless, the tip of the perithecium and its posterior margin suffused with brown, the suffusion extending to the base of and including the appendage. Receptacle short, the basal cell hyaline, relatively large, slightly inflated above, tapering to the small foot; the subbasal cell very small, twice as broad as long; the basal cell of the appendage deeply suffused with blackish brown, especially externally; relatively small and short, the rest of the appendage much as in the other species, somewhat narrow and suffused with brown. Stalk-cell of the perithecium short, slightly longer than broad, the perithecium relatively large and stout, nearly straight, the inner margin nearly straight, and suffused with brown, the outer bent abruptly inward below the tip, which is brown, short, stout, well differentiated, broadly truncate; the lip-cells rising in a truncate conical apiculus subtended by the four clearly distinguished broad subterminal wall-cells. Total length to tip of perithecium  $125 \mu$ . Perithecium  $80 \times 20 \mu$ , the stalk-cell  $12 \times 10 \mu$ . Receptacle  $28 \times 12 \mu$ . Appendage to tip of spine  $45 \times 10 \mu$ , the basal cell  $10 \mu$  long.

Near the base of the right elytron of *Corticaria* sp., Kittery Point, Maine.

Several specimens of this pretty species were found on a single host on Cutts Island, but although diligent search was made no further material has been obtained.

## ACOMPSOMYCES PAUPERCULUS Thaxter. Plate XLII, figs. 13-15.

Proc. Am. Acad. Arts and Sci., Vol. XXXVIII, p. 23. June, 1902.

Hyaline or nearly so. Receptacle short, somewhat bent; the distal cell very small, irregular, sharply pointed below, externally separated from the basal cell by an oblique septum; the basal cell three or four times as large, narrow below, expanded above its distal point, forming a right angle, the septum on one side applied to the base of the stalk-cell of the appendage. The latter subtriangular, its lower half in contact on the inner side with the two cells of the receptacle, its upper with the stalk-cell of the perithecium; the rest of the appendage free, relatively large, hardly inflated, its lower cell about as large as the two upper combined and bearing commonly one, sometimes three, antheridia as in *A. Atomaria*; the two cells above it nearly equal or the upper often smaller and bearing its antheridium subterminally, so that the spinous process of the latter appears to terminate the appendage, the wall distinguishing this antheridium being commonly invisible from its obliquity. Stalk-cell of the perithecium about as large as that of the appendage and similarly shaped, except that its position is reversed, separated distally from the basal cells of the perithecium by a very oblique septum: the body of the perithecium short, stout, bent asymmetrically, and considerably inflated; the inner margin straighter, the short squarish tip rather abruptly distinguished, the apex subtended by four distinct symmetrical prominences, which form a crown surrounding the four appressed prolongations of the lip-cells, which appear as a blunt,



conical protuberance within it: all the cells rather thin-walled. Spores  $45 \times 4 \mu$ . Perithecia  $70 \times 30-35 \mu$ , the stalk-cell  $12-18 \times 9$ . Receptacle  $20-30 \mu$ . Free appendage  $32-36 \mu$ . Total length to tip of perithecium  $110 \mu$ .

On elytra, prothorax, and legs of *Atomaria* sp., Kittery Point, Maine, June.

This species, which has been found but twice, is distinguished by its hunched bent form and pale straw-color. The venter of the terminal antheridium is usually so small, or so obliquely placed as to be almost indistinguishable, and the terminal cell of the appendage might readily be taken for it. On a very minute brown *Atomaria* at Cutts Island.

ACOMPSOMYCES ATOMARIE Thaxter. Plate XLII, figs. 6-9.

Proc. Am. Acad. Arts and Sci., Vol. XXXVIII, p. 22. June, 1902.

Colorless or very faintly brownish. Receptacle short, the distal cell squarish; the basal cell twice as large, narrow below, bulging beneath the base of the antheridial appendage from which it thus appears to arise terminally. Basal cell of the antheridial appendage rather long and narrow, not distinguished from the receptacle, to the distal cell of which its lower half is closely applied, while its upper half is in equally close contact with the stalk-cell of the perithecium; the rest of the appendage free, compact, slightly inflated, with evenly curved outline, faintly tinged with brown, consisting of three cells: the lower subtriangular in outline with the largest angle outward, bearing distally three closely appressed antheridia neither of which arises from its outer side; the cell next above somewhat larger, sterile, subtriangular with the largest angle external; the terminal cell smaller, separated by a horizontal septum from the terminal antheridium, the neck of which is curved inward, the spinous process conspicuous and external. Stalk-cell of the perithecium well developed, rather slender, about as long as the receptacle, the basal cells well distinguished: body of the perithecium narrower below, its inner margin nearly straight with slight constrictions at the septa, the outer bulging distinctly and more or less symmetrically; the tip distinctly but not abruptly distinguished, short, stout, slightly but rather abruptly expanded below the flat-conical apex, from the middle of which project abruptly the small short appressed prolongations of the lip-cells, forming a terminal apiculus. All the cells thick-walled. Spores very slender,  $44 \times 3 \mu$ . Perithecia  $36-46 \times 25-30 \mu$ , the stalk-cell  $25-30 \times 10 \mu$ . Receptacle  $25 \mu$ . Free appendage to tip of spinous process  $36 \times 12 \mu$ . Total length to tip of perithecium  $125-150 \mu$ .

On elytra of *Atomaria ephippiata* Zimm., Kittery Point, Maine, and Intervale, N. H.

POLYASCOMYCES Thaxter.

Proc. Am. Acad. Arts and Sci., Vol. XXXV, p. 414. April, 1900.

Receptacle consisting of two superposed cells, the upper bearing a perithecium laterally and an appendage terminally. Appendage consisting of a series of superposed flattened cells, surmounted by a dome shaped portion which is not persistent. Perithecium with a distinct stalk-cell and well developed basal cells, the supporting cell and the lower wall-cells forming a funnel-shaped ascigerous area, the asci arising from very numerous ascigerous cells.

It has not been possible from the material available to determine what the precise nature of the antheridial appendage is, or even to decide whether the antheridia are compound or simple. The terminal dome-shaped portion of the appendage may have been a compound antheridium, which early becomes collapsed and disorganized, and I was at first inclined to consider it as such; but it is equally possible that it may have given rise to simple antheridia, or that these may have been produced from some of the cells below in a fashion somewhat similar to that seen in *Acompsomyces* and *Acallomyces*, to the last of which it seems otherwise as closely allied as to any of the genera. It has therefore seemed best to place it among the Laboulbeniaceæ although, such a disposition must be considered as merely provisional. The genus is chiefly remarkable for the unusual multiplication of ascogenic cells, which are far more numerous than in any other. The original position of these cells is probably not that which is shown



in the accompanying figures; since it seems probable that in the specimens examined the whole mass has been displaced from a position lower down, nearer the base of the funnel-shaped cavity below. As far as can be determined by an actual count, there appear to be not less than thirty-two such ascogenic cells in a single perithecium, and perhaps more in some individuals.

Further knowledge of this very peculiar type is much to be desired, and it is to be hoped that English observers may be able to obtain material of young individuals which will make it possible to determine the nature of the antheridium. The host of the unique species is a staphylinid allied to *Tachinus* and appears to be rare in collections, although it is well represented in that of Dr. Sharp, in which, however, much to my regret, I was unable to discover any individuals that were infested.

POLYASCOMYCES TRICHOPHYÆ Thaxter. Plate XXXVII, figs. 1-2.

Proc. Am. Acad. Arts and Sci., Vol. XXXV, p. 415. April, 1900.

Pale dirty brownish. Perithecium broadest in the ascigerous zone, tapering thence to the distinctly differentiated neck-like tip, the subterminal wall-cells enlarged distally, externally and laterally, the resultant rounded protuberances forming a ridge about the tip just above its middle, the distal portion, formed by the lip-cells, of which that on the right is slightly longer than the rest, broad blunt brownish, the other three somewhat shorter terminating in narrow blunt extremities which lie on three sides of the first. The stalk-cell similar to and lying beside the subbasal cell of the receptacle to which it is united throughout, its base being in contact with the distal end of the basal cell, while from its distal end the large basal cells of the receptacle curve abruptly outward and upward. The appendage consisting of from three to six flat superposed darker brown cells, constricted at the septa, looking as if they had been made irregular by crushing, the terminal portion (antheridium?) blunt, slightly longer than broad, with evidences of lateral apertures. Spores  $28 \times 2.5 \mu$ . Perithecia  $175 \times 50-65 \mu$ . Basal cells  $40-48 \times 30 \mu$ . Stalk  $38 \mu$ . Receptacle  $70 \mu$ . Appendage  $48-60 \times 20-24 \mu$ .

On the superior surface of the abdomen of *Trichophya pilicornis* Gyll., British Museum, No. 453, Farnham, England.

ACALLOMYCES Thaxter.

Proc. Am. Acad. Arts and Sci., Vol. XXXVIII, p. 23. June, 1902.

Receptacle consisting of two superposed cells, the lower sometimes obsolete or indistinguishable from the foot, the upper bearing a single perithecium and an antheridial appendage. Appendage clearly differentiated, simple and without branchlets, consisting of an adnate stalk-cell and five cells superposed above it, the two terminal ones each bearing a single antheridium, the terminal antheridium spinose, the subterminal one adnate to the terminal cell of the appendage.

A very simple generic type closely allied to *Acompsomyces* and also resembling *Stigmatomyces* in the characters of its appendage. The latter appears to be similarly distinguished by the presence of a stalk-cell, a basal cell and several (four) cells superposed above it. The two antheridia are superposed and appear to have been separated from the terminal and subterminal cells. Although it is difficult to point out crucial differences which separate this appendage clearly from that of *Stigmatomyces*, unless it be the sterility of the four lower cells, there can be no question of the distinctness of the generic type, which is in reality nearer that of *Acompsomyces*. In this, however, the subterminal cell of the appendage is sterile and the cell below this bears more than a single antheridium. The type bears a very strong resemblance to *Polyascomyces*; but, since nothing is known as to the true character and disposition of the antheridial cells in this genus, the relationship remains problematical.

ACALLOMYCES HOMALOTÆ Thaxter. Plate XLII, figs. 1-4.

Proc. Am. Acad. Arts and Sci., Vol. XXXVIII, p. 24. June, 1902.

Hyaline becoming faintly tinged with straw-yellow. Receptacle very small the lower half becoming tinged with smoky brown; the basal cell hardly distinguished from the foot, and commonly obliterated by a thickening of the walls in this region, so that the receptacle appears to be one-celled. Basal cell of



the antheridium separated from the distal cell of the receptacle by a somewhat oblique septum, and nearly similar to that of the stalk-cell of the perithecium, to which it is closely adnate on its inner side. the subbasal cell very small and becoming scarcely distinguishable in mature individuals; the two cells above it similar, rather distinctly differentiated, the pair forming a slight symmetrical enlargement; the terminal cell above, larger and longer than these two cells combined, the base of the lower antheridium extending its whole length; both this and the terminal antheridium above it relatively large, the necks very long, straight or but slightly bent and somewhat divergent. Stalk-cell of the perithecium somewhat broader than long, the basal cells small, the perithecium proper relatively large and somewhat inflated above the base, distally tapering gradually to the tip; the lip-cells forming four corresponding projections, the anterior larger and broader, the posterior narrow and bluntly pointed, subtended by a more or less well defined hump; the two lateral usually shorter blunt, slightly divergent, sometimes not clearly differentiated, varying in shape and position. Spores  $35 \times 3.5 \mu$ . Perithecia  $75-95 \times 25-32 \mu$ , the stalk-cell  $10-12 \mu$ . Appendage above basal cell to tip of antheridium,  $36 \mu$ . Antheridia  $21-25 \mu$ . Receptacle  $20-25 \mu$ . Total length to tip of perithecium  $125-150 \mu$ .

On the superior surface of the abdomen of a species of *Homalota*. Intervale, N. H.

This species appears to be very rare, since, although diligent search was made for it, a single infested specimen of the host, only, was found. The latter occurred in decaying agarics in the Merriman Woods.

#### STIGMATOMYCES Karsten.

A notable addition is made to this genus since the publication of my Monograph, including nineteen species, a majority of which are either American forms, or derived from a collection of Diptera made by Dr. Dahl in New Pommerania near New Guinea. All of the species, with a single exception, grow upon flies, and it is quite certain that those which have been described represent but a small fraction of the forms which actually exist. The genus is in some respects a very difficult one to treat systematically, the type-structure being very simple, and the species sometimes varying very greatly; as in the case of *S. purpureus*, which, although in its typical condition it is one of the most striking and clearly defined forms, both from its peculiar violet-blue or purple color and the nodulose ridges of its perithecium, varies to smaller and simpler conditions in which these characters are almost wholly lost.

The antheridial appendage in this, as well as in so many other genera, furnishes the most reliable characters, not only for the characterization of the genus, but of the different species as well, and possesses a very well marked and individual type of structure. It consists of a *stalk-cell* more or less well developed and always partly or usually wholly united to the receptacle, that is succeeded by a *basal cell* which is usually, although not invariably, peculiarly modified in color and in structure. The characteristic cup-like thickening of the inner layers of the wall of this cell, above the basal septum, which is so strikingly developed in *Arthrorhynchus Cyclopodia*, is often prominent, as in fig. 22, Plate XLVII, is perhaps connected with the mechanism by which the whole appendage undergoes a quarter or a half turn; so that the antheridia, which were originally directed toward the trichogyne, become turned away from the mature perithecium. This basal cell, which may or may not itself bear antheridia, as is shown in figs. 18 and 36, Plate XLVI, is succeeded above by a series of superposed cells which form the main axis of the appendage and vary in number in the different species.

The simplest type of appendage is that illustrated by *S. purpureus*, Plate XLVI, fig. 36, in which the basal cell is not only unmodified but sterile, the axis above it consisting of but three superposed cells, each bearing a single antheridium; the series ending in a fourth terminal cell which is converted directly into a spinose antheridium. The spine, which persists in a similar fashion in various other genera, notably in *Eucantharomyces*, being the original subulate termination of the germinating spore, it is evident that the cell which bears it is a primarily terminal structure and not one which has resulted from secondary proliferation. In this connection, however, it should be mentioned that the spine is not always attached



to a terminal cell and the different species may be in general divided in two groups, one in which the spinose cell is terminal at maturity as in figs. 1, 7, 36, 41 etc., Plate XLVI; and a second class in which, through a process of secondary proliferation more or less pronounced, the spinose cell becomes intercalary, and the number of cells forming the axis of the appendage correspondingly increased in number, as in fig. 29. In this class also two types may be distinguished namely that in which all the cells of the axis, at least above the basal cell, bear fertile antheridia, whether they be primary or secondary, as in the figure last cited, and those in which the accessory cells of the axis are partly or wholly sterile, producing no antheridia or only sterile ones, as in figs. 7 and 13, Plate XLVII.

In regard to the development, arrangement and number of the antheridia on the appendage, there is a good deal of variation in different cases, but these characters appear to be more or less definitely fixed in individual species, so that the appendage characters are often the only reliable ones. The simplest type of arrangement is that seen in *S. purpureus* previously cited, in which each cell of the axis having cut off a single antheridium, the latter form a series of members superposed in a single row. This type, however, is rarely met with, and in the great majority of cases a more or less complete double row is formed. This condition usually results from the fact that from some or all of the cells which compose the primary axis, a second cell is cut off which corresponds to the single antheridium of the simpler type and like it is morphologically a lateral branch. This branch then divides in two superposed cells, the terminal one being converted directly to an antheridium. The basal cell in turn may then grow out sidewise and form a second antheridium on which the first appears to be superposed, or may itself become divided to an upper and lower cell each of which is transformed to an antheridium, as appears to be the case in *S. Elachipteræ*. The antheridia formed in this manner becoming somewhat divergent as they mature, thus come to be more or less regularly biseriate and alternate. These antheridial sympodia from the main appendage correspond in all respects to the corresponding structures of *Rhadinomyces*, in which the antheridia arise successively in a similar fashion (Monograph, Plate IX, fig. 23), although they are quite free and usually more than two are superposed.

In describing the species it has been found convenient to distinguish three regions in the perithecium although they are not well marked in all cases. These are the *venter*, the more or less swollen ascigerous basal part, the *neck* often abruptly distinguished and elongate above it and lastly the *tip* which is commonly distinguished from the neck by a more or less well defined elevation. A typical instance of this separation into three regions is seen in the perithecium of figs. 12 and 16, Plate XLIX. In several species the venter is marked by granulations or transverse lines as in the figures last cited, but this is often indistinct without a high magnification. The hosts of the members of this genus are mostly small flies many of which, as their names suggest, live near water or in moist places, while others may be swept with a net from various flowers or over grass etc., in somewhat dryer situations. It will be remembered that *S. virescens* occurs on a widely different host, *Chilocorus*, one of the "lady beetles," and I have one other species as yet undescribed which occurs in South America on another order of Coleoptera. It may be mentioned here that, although the species almost all grow on soft bodied hosts, no indication has been seen of any penetration of the integument such as is suggested by the figures of Peyritsch, and the foot is of the usual type, though often small.

STIGMATOMYCES PURPUREUS Thaxter. Plate XLVI, figs. 30-36.

Proc. Am. Acad. Arts and Sci., Vol. XXXVI, p. 404. March, 1901.

Becoming wholly suffused with purple. Venter of the perithecium inflated toward the base, tapering distally; the four wall-cells separated by a corresponding number of prominent longitudinal ridges, rounded in section, which run spirally, making in well-developed individuals a whole half turn about the venter, and becoming sometimes lobulated through the presence of successive constrictions and enlargements; neck not abruptly distinguished, except by the abrupt elevations which form the terminations of the longitudinal ridges of the venter, rather slender, an abrupt posterior subterminal elevation preceded



by a slight constriction, the tip distally quite hyaline; the apex becoming furcate through the presence of an anterior (shorter) and a posterior projection. Stalk-cell of the appendage relatively small, but slightly prominent below the basal cell, which is nearly as long, sterile, and, as a rule, followed by three cells bearing antheridia singly, the terminal one spiniferous. Receptacle usually straight, the cells nearly equal or the upper larger. Spores  $35 \times 3 \mu$ . Perithecium: venter  $80-100 \times 45-50 \mu$ ; neck  $80-83 \mu$ . Appendage  $55 \mu$ , the stalk-cell  $18 \mu$ . Receptacle  $100-120 \mu$ . Total length to tip of perithecium  $200-325 \mu$ .

On all parts of *Scatella stagnalis* Fallen; Berkeley, California; Intervale, New Hampshire; Kittery Point, Maine, and vicinity of Cambridge, Mass., September.

Fully developed individuals with the typical structure are uncommon, a majority of the numerous specimens examined having the color dull or paler purplish, the ridges less well defined, without lobulations and with less than a half twist; the neck and apex hardly, if at all, modified. The same host is infested by an amber-brown form which may prove a mere variety of that above described, being scarcely distinguishable structurally from the less well-marked individuals of this species, the type form of which is, from its remarkable color and from the structure of its perithecium, one of the most peculiar members of the genus. It is most nearly allied to *S. Hydrelliæ*, the appendages in these two species being nearly identical. *L. spiralis* also has certain characters in common with it, as for example its ridged perithecium and uniseriate antheridia; but cannot be confused with it. The spinose cell is terminal and becomes an antheridium. The hosts are small flies with brownish wings abundant in moist places, especially about mud holes, and may be captured, by sweeping, in great quantities, especially in late August and September.

STIGMATOMYCES HYDRELLIÆ Thaxter. Plate XLVI, figs. 19-24.

Proc. Am. Acad. Arts and Sci., Vol. XXXVI, p. 404. March, 1901.

Venter of the perithecium amber-brown, oval, the wall-cells becoming separated by well-defined, slightly oblique longitudinal broad ridges, which become broader distally where they end abruptly; the neck pale, well distinguished, its middle third prominently inflated, more so posteriorly, and separated from the usually abruptly bent tip by a constriction; the apex rounded, one of the (lateral?) lip-cells, forming a slender, bluntly pointed, well-defined free projection. Stalk-cell of the appendage sub-triangular, somewhat prominent below the basal cell, which nearly equals it in length and is sterile; the fertile cells above it nearly equal, bearing rather large, single, antheridia, with stout, straight necks, the series ending in a terminal spiniferous antheridium. Receptacle hyaline, the two cells nearly equal in length, the lower tapering below, the upper broader inflated, its diameter greater than the base of the perithecium and stalk-cell combined, so that the latter region appears to be constricted. Spores  $28 \times 2 \mu$ . Perithecium: venter  $50-55 \times 33-40 \mu$ ; neck  $40-43 \mu$ . Appendage  $50 \mu$ , the stalk-cell  $18 \mu$ . Receptacle  $55-65 \times 20-22 \mu$ . Total length to tip of perithecium  $150-185 \mu$ .

Occurring in scattered groups on the superior surface of the abdomen, sometimes on the legs, of *Hydrellia* sp. Kittery Point, Maine.

This species is closely allied to *S. purpureus*, the appendages being identical in the two species. The conformation of the perithecium appears to separate it, however, very distinctly. It seems to be rare in the type locality and has not been seen elsewhere. The host may be captured by sweeping in moist places about ponds.

STIGMATOMYCES SPIRALIS Thaxter. Plate XLVI, figs. 25-29.

Proc. Am. Acad. Arts and Sci., Vol. XXXVI, p. 405. March, 1901.

Venter of the perithecium relatively long and slender, flask-shaped, or more often but slightly if at all inflated, the granular wall-cells distinguished by a corresponding number of abrupt, narrow, longitudinal prominent ridges, which become minutely roughened, and are spirally twisted so as to describe a full half turn; the neck concolorous, distinguished by the abruptly elevated and abruptly broadened terminations of the longitudinal ridges of the venter, as long as or slightly shorter than the venter, slightly



curved or sometimes straight, nearly cylindrical or slightly tapering; the tip slightly but abruptly narrower, relatively short, somewhat asymmetrical; the apex nearly symmetrical, four papillæ being arranged about a somewhat more prominent central projection. Appendage rather short and stout, distinctly broadened in the middle, the stalk-cell, stout, the basal cell half as large, or less, and fertile; the series of six to eight fertile cells above it surmounted by a single usually sterile antheridium, and distinguished by slight successive constrictions, broad and much flattened, each bearing a single antheridium, the fifth furnished with a very sharp spine; the antheridia forming a usually lateral series, their necks becoming strongly curved. Receptacle elongate, slender, becoming brownish or yellowish, the upper cell often more than twice as long as the basal. Spores  $25 \times 2.5 \mu$ . Perithecium: venter  $90-165 \times 35-47 \mu$ ; neck  $90-160 \times 17 \mu$  (the tip  $25-30 \mu$ ). Appendage  $40-50 \mu$ , the stalk-cell  $15 \mu$ . Receptacle  $100-250 \times 15 \mu$ . Total length to tip of perithecium  $350-600 \mu$  (average  $500-550 \mu$ ).

On *Hydrina* sp., Kittery Point, Maine. Usually on the upper surface of the thorax, less often on the legs and elsewhere.

This well marked species was obtained on a small fly collected by sweeping the flowers of Yarrow (*Achillea*) on Cutts Island in late August. It is conspicuous from its large size and dark brown perithecium, and may readily be seen with the naked eye when growing in its usual position on the thorax. It is distinguished by the clean cut wing-like ridges which run spirally between the wall-cells and end abruptly in an enlargement at the base of the neck. In this respect it resembles *S. purpureus*, in which the ridges are, however, nodulose when well developed, as well as in the uniseriate arrangement of its antheridia; but is in other respects quite different. The spiniferous cell is not converted into an antheridium, but is subterminal; the appendage being proliferous beyond it.

STIGMATOMYCES VENEZUELÆ Thaxter. Plate XLIX, figs. 20-21.

Proc. Am. Acad. Arts and Sci., Vol. XLI, p. 314. July, 1905.

Perithecium slender, curved throughout, the venter pale amber-brown, hyaline externally, not distinguished from the neck on the inner side; the outer wall-cells bulging more or less conspicuously; the neck tapering slightly, the tip blunt, and unmodified; the basal and stalk-cells hyaline, distinguished from the venter by an abrupt external constriction. Cells of the receptacle hyaline, subequal, the basal bulging distally, below the subbasal, to which it is thus asymmetrically adjusted. Stalk-cell of the appendage tinged with amber-brown, more than twice as long as broad, abruptly distinguished from the lower part of the basal cell, which is small and brown: the appendage proper small, hyaline, withering at maturity, except the lower part of the basal cell; consisting apparently of about three cells producing about four nearly free antheridia. Perithecia  $95 \times 30 \mu$ . Receptacle  $90 \times 14 \mu$ . Appendage  $45 \mu$ , exclusive of stalk-cell, which is  $22 \mu$  long.

Growing at tip of abdomen of *Limosina* sp., Island of Margarita, Venezuela; Dr. A. F. Blakelee.

Although not striking in its appearance, this species seems well distinguished from all other forms of *Stigmatomyces*, owing to the peculiar relation between the basal and subbasal cells of the receptacle, as well as by the form of its perithecium. Eight mature individuals have been examined, which show little variation; but in none of them is the antheridial appendage sufficiently well preserved to admit of its being figured in detail, the whole functional portion apparently becoming shriveled and the antheridia ceasing to function at an early stage in the maturity of the individual. In one example it seems as if the lower antheridia, only, had been functional, and the upper were replaced by sterile rounded cells.

STIGMATOMYCES DIOPSIS Thaxter. Plate XLIX, figs. 8-10.

Proc. Am. Acad. Arts and Sci., Vol. XXXVI, p. 399. March, 1901.

Colorless or slightly yellowish. Venter of the perithecium long-oval or elliptical, pale reddish amber, rather abruptly distinguished from the paler neck, which tapers but slightly, except at its base, is straight or slightly bent, and traversed by four broad longitudinal ridges which are corrugated by about six successive elevations and depressions; a seventh distal elevation, larger and more prominent than the rest, is



present just below the tip, which is abruptly narrower and slightly curved; the apex asymmetrical, the posterior lip-cells forming a tripapillate prominence, the middle papilla larger and more prominent; the anterior lip-cells forming two small lateral papillæ placed side by side in such a position that the apex appears to be laterally notched. Appendage erect or somewhat divergent, straight or slightly curved backward, the stalk-cell more than twice as long as broad, and more than half united to the subtriangular stalk-cell of the perithecium, distally constricted at its junction with the well differentiated squarish amber-brown sterile basal cell of the appendage proper; the eight fertile cells above bearing two antheridia each in addition to a terminal pair, the outer of which is spinose at its base, the series of antheridia external in the mature types. Spores about  $40-45 \times 5 \mu$ . Perithecium: venter  $80-87 \times 50 \mu$ ; neck  $72-82 \times 18 \mu$ . Appendage proper  $70-75 \mu$ , stalk-cell  $25-30 \mu$ . Receptacle  $75 \mu$ . Total length to tip of perithecium  $270-290 \mu$ .

On *Diopsis* sp., Berlin Museum, No. 860; Bismarckburg, Togo, West Africa. On the upper surface of the abdomen near the tip.

This species is easily distinguished by the corrugated neck of its perithecium which is unlike that of any known form. It is the fourth species of the family now known to inhabit these curious stalked-eyed Diptera. The appendage is relatively large with very numerous antheridia, the multiplication of its cells not being due to proliferation since the spiniferous cell is terminal and appears to bear two antheridia (fig. 10).

STIGMATOMYCES GRACILIS Thaxter. Plate XLVII, figs. 15-18.

Proc. Am. Acad. Arts and Sci., Vol. XXXVI, p. 403. March, 1901.

Form long and slender. Venter of the perithecium amber-brown, relatively large above its narrow base, more or less inflated, often more distinctly distally; the neck usually straight, sometimes curved, nearly hyaline as a rule; and abruptly distinguished; the tip abruptly but slightly narrower above a prominent and usually symmetrical inflation; the median posterior projection of the lip-cells erect, larger, and slightly more prominent than the two lateral ones, which diverge slightly and are nearly symmetrical with the two anterior ones. Stalk-cell of the appendage slightly prominent distally below the dark amber-brown basal cell, which may be more than half as large, bearing one or two antheridia; the remaining cells four in number, relatively large, except the fourth, which bears a large, curved, conspicuous spine below the base of the terminal antheridium; the antheridia in pairs, lateral or obliquely external, the necks short, becoming pointed and slightly divergent. Receptacle usually shorter than the perithecium, slender, straight or curved, hyaline; the two lower cells about equal, or the upper larger and distally often broader than the combined diameters of the cells above it. Spores  $45 \times 3.5 \mu$ . Perithecium: venter  $85-90 \times 30-40 \mu$ ; neck  $100-110 \times 16 \mu$  (the enlargement  $\times 20 \mu$ ). Appendage  $70-75 \mu$ , stalk-cell  $18-25 \mu$ . Receptacle  $90-125 \times 18-20 \mu$ . Total length to tip of perithecium  $250-360 \mu$ .

Near the tips of the posterior legs on the same host with *S. dubius*. Ralum, New Pomerania. Berlin Museum, No. 1298.

This species appears to be most nearly allied to *S. Sarcophagæ*, from which it is separated by its general form, and by the structure of its appendage, which is not proliferous; the terminal antheridium being subtended by an unusually large stout thorn-like spine.

STIGMATOMYCES SCAPTOMYZÆ Thaxter. Plate XLVI, figs. 37-41.

Proc. Am. Acad. Arts and Sci., Vol. XXXVI, p. 400. March, 1901.

Venter of the perithecium becoming reddish amber-brown, nearly isodiametric, becoming distally enlarged; the nearly hyaline neck very abruptly distinguished, slender, straight, or curved, its lower third sometimes narrower; the tip hardly or not at all differentiated; the apex asymmetrical, the anterior lip-cells forming two lateral papillate slightly divergent protrusions, the posterior lip-cells forming two similar protuberances above them, between which a slight projection may or may not be present. Stalk-cell of the appendage elongate, very abruptly broader than the very small deep brown squarish infertile



basal cell; the fertile cells usually five in number, the antheridia with short curved divergent necks and produced in pairs, except the terminal one, which is conspicuously spiniferous, the whole series usually obliquely external. Receptacle hyaline, the basal cell mostly larger, longer, tapering below. Spores about  $36 \times 3.5 \mu$ . Perithecium: venter  $90-100 \times 36-44 \mu$ ; neck  $108 \times 10-15 \mu$ . Appendage  $47-55 \mu$ , the stalk-cell  $25-30 \mu$ . Receptacle  $65-100 \mu$ . Total length to tip of perithecium  $300-325 \mu$ .

On the abdomen and legs of *Scaptomyza graminum* Fallen. Kittery Point, Maine; vicinity of Cambridge, Mass.; Berkeley, California. On *Scaptomyza* sp.?, Caracas, Venezuela. (Blakeslee).

A very characteristic and common species usually growing in tufts on the upper or lower surface of the abdomen, the specimens from the three somewhat remote regions above indicated not showing any noteworthy regional variations. It is distinguished by its compact tapering appendage, with biserial antheridia, and the unusually abrupt distinction between the rather slender neck and the distally often very considerably broadened venter of the perithecium. The host is common in New England during the late summer and autumn and may be readily captured by sweeping over flowers like mignonette or clematis or in grassy meadows. The South American specimens do not appear to be essentially different, although somewhat more long and slender, the distal portion of the venter rather abruptly swollen and slightly granular. The spiniferous cell in this species is terminal and becomes an antheridium, fig. 41.

STIGMATOMYCES PAUPERCULUS Thaxter. Plate XLIX, figs. 18-19.

Proc. Am. Acad. Arts and Sci., Vol. XLI, p. 313. July, 1905.

Short and stout, dark amber-brown, except the hyaline receptacle, and the antheridial portion of the appendage. Venter of perithecium short, stout, inflated; more or less distinctly granular, abruptly distinguished from the neck, which is slightly inflated above the middle, distally curved, and slightly tapering; the apex somewhat asymmetrical and blunt, the lip-cells forming inconspicuous papillæ. Receptacle hyaline, rather short, the cells subequal, abruptly distinguished from the parts above. Stalk-cell of the appendage short and prominent, separated from the darker basal cell by an abrupt constriction; the rest of the appendage very broad, short, hyaline, curved inward; consisting of three superposed cells and the terminal antheridium, the total number of antheridia eight (possibly nine), scarcely more than their small necks free. Total length to tip of perithecium  $165-175 \mu$ . Venter of perithecium  $40-45 \times 35-38 \mu$ , the neck  $50 \times 16 \mu$ . Appendage, (including basal cell  $16-20 \mu$ ),  $58-65 \times 15 \mu$ . Spores  $32 \times 3 \mu$ .

On legs of a small dark fly with white inferior abdomen, Ralum, New Pomerania; Berlin Museum, No. 1291.

Although based on only three specimens this species seems sufficiently well marked, by its broad fan-like antheridial appendage, to warrant separation from other known forms. It should be remembered, however, that abundant material may show a greater development in luxuriant specimens, both of the receptacle and perithecium. The terminal antheridium is spiniferous.

STIGMATOMYCES MICRANDRUS Thaxter. Plate XLVII, figs. 19-24.

Proc. Am. Acad. Arts and Sci., Vol. XLI, p. 312. July, 1905.

Venter of the perithecium, together with its basal cells and the stalk-cells of the appendage, dark amber-brown, symmetrically oval, or typically subconical; at maturity roughened by numerous transverse, not very prominent, ridges; the neck usually longer than the venter, slender, nearly cylindrical above its slightly spreading base, and usually more or less distinctly curved; the tip slightly narrower, and subtended by slight elevations, distally asymmetrical, somewhat oblique, the lip-cells prominent, somewhat pointed and divergent, subtending a pointed prominent apex. Basal cells of the perithecium small, subequal, and characteristically prominent. Receptacle typically rather short and stout, the two cells subequal, or the subbasal cell more or less elongate, finally more or less distinctly marked by transverse striations. Stalk-cell of the appendage rather short, more or less prominent: the basal cell abruptly narrower, squarish, brown, the rest of the appendage short and stout, hyaline, consisting of two superposed cells, the lower bearing three antheridia, the upper two, which are surmounted by the single terminal



spinose antheridium. Spores  $45 \times 4 \mu$ . Perithecium, venter  $72-80 \times 50-60 \mu$ , the neck  $140-150 \times 16-18 \mu$ . Appendage above stalk-cell  $35-40 \mu$ ; the stalk-cell  $20 \mu$ . Receptacle  $90-110 \times 30 \mu$ . Total length to tip of perithecium  $275-325 \mu$ .

On the superior surface of the abdomen of a small blackish fly, Ralum, New Pomerania; Berlin Museum, No. 1284.

Although in its typical form (fig. 20) this species seems very unlike the typical *S. rugosus*, more slender and elongate specimens occur which have made me hesitate to separate them specifically. The characters, of the antheridium, however, seem constantly different as indicated in the accompanying figures; and while that of *S. rugosus* possesses five superposed cells above the basal cell (fig. 27), bearing in all twelve antheridia, the present species has but two bearing six antheridia, and in one or two small specimens there seem to be even less. The spinose cell is terminal and becomes an antheridium.

STIGMATOMYCES RUGOSUS Thaxter. Plate XLVII, figs. 25-28.

Proc. Am. Acad. Arts and Sci., Vol. XXXVI, p. 398. March, 1901.

Venter of the perithecium dark amber-brown, roughened by about ten transverse more or less irregular and sometimes anastomosing darker ridges formed by irregular wart-like elevations; evenly oval or elliptical, and abruptly distinguished from the rather stout neck, which is usually bent outward and about equal to it in length or somewhat shorter, distally distinctly enlarged, especially posteriorly; the tip beyond this enlargement abruptly somewhat narrower, distally asymmetrical, the two posterior lip-cells forming two corresponding projections, rounded or bluntly pointed and more prominent than the bilobed papilla formed below them by the anterior lip-cells the four subtending a slightly prominent apex. Stalk-cell of the appendage small, subtriangular, amber-brown, abruptly prominent below the relatively large dark brown basal cell, which, though narrower, nearly equals it in size, may or may not bear antheridia, and has a well-marked annular thickening on the inner side of its wall at the base; the fertile cells above it, four or five in number, bearing the rather large antheridia in pairs; the series becoming obliquely lateral or external, the free necks strongly curved outward. The cells of the receptacle nearly equal, or the upper larger; the basal cell tapering to the foot and distally slightly broader than the subbasal cell. Spores about  $40 \times 4 \mu$ . Perithecium: venter  $72 \times 45 \mu$ ; neck  $62-72 \times 15-18 \mu$ . Appendage proper  $60-70 \mu$ , stalk-cell  $18 \mu$ . Receptacle  $90-100 \times 20 \mu$ . Total length to tip of perithecium  $250-290 \mu$ .

On the legs, thorax, and abdomen of a minute fly. Berlin Museum, No. 1296. Ralum, New Pomerania.

A form (fig. 28) which I am unable to separate satisfactorily from this species, was obtained from a small fly sent me by Dr. Piper from Puyallup, Washington; and I have found a similar one at Kittery Point, Me. The material is not very abundant but the species seems too near *S. rugosus* for specific separation. The type from Ralum, figs. 25-26, is very nearly allied to *S. micrandrus*; but differs in the several points referred to under that species. The spinose cell is intercalary, being the fourth above the basal cell of the appendage.

STIGMATOMYCES CONSTRICTUS Thaxter. Plate XLVI, figs. 1-4.

Proc. Am. Acad. Arts and Sci., Vol. XXXVI, p. 401. March, 1901.

Venter of the perithecium dark amber-brown, subrectangular, or more or less inflated; the short stout neck about equal to it in length, very abruptly distinguished beyond the four rounded elevations which mark the distal ends of the brown wall-cells of the venter, subconical, with a considerable submedian enlargement often more prominent posteriorly; the tip often tapering to the five-papillate apex, the middle posterior papilla blunt and more prominent, the other four nearly symmetrical. Stalk-cell of the appendage often suboblong and externally prominent throughout its length, or only distally; the basal cell narrower and longer, separated from it by a rather deep constriction and bearing three antheridia distally: while above it the single remaining fertile cell is very small, bearing two antheridia and followed directly by the spinose terminal antheridium; all the antheridia relatively large and almost free. Recep-



tacle hyaline, its basal cell more or less elongate, tapering to a narrow base, a rectangular distal thicker-walled portion separated by a thin incomplete septum; the subbasal cell much shorter, more or less abruptly and prominently inflated at its base, sometimes slightly also at its distal end, and having a more or less well defined median constriction, below which the inflated base may be separated by a thin partial septum. Perithecium: venter  $54 \times 30-40 \mu$ ; neck  $44-55 \times 18 \mu$ . Appendage  $43-50 \mu$ , the stalk-cell  $18 \mu$ . Receptacle  $70-90 \times 22 \mu$ . Total length to tip of perithecium  $200-300 \mu$  (those on the tips of the legs much smaller,  $180-200 \mu$ ).

On the legs and abdomen of a small fly. Ralum, New Pomerania. Berlin Museum, No. 1294.

Closely allied to *S. Elachipteræ* and perhaps only a regional variety. The differences in the appendage and in the subbasal cell of the receptacle appear, however, to be constant. The appendage in the present form is unique in possessing but two fertile cells, the lower of which bears three antheridia, the upper two in addition to the terminal one. There are thus six antheridia in all, while in *L. Elachipteræ* there are eight, borne on three superposed cells. The spiniferous cell in this species is terminal and becomes an antheridium.

STIGMATOMYCES ELACHIPTERÆ Thaxter. Plate XLVI, figs. 5-10.

Proc. Am. Acad. Arts and Sci., Vol. XLI, p. 323. July, 1905.

Receptacle hyaline, the basal and subbasal cells of nearly equal length, the former more or less distinctly inflated distally in the region of a partial septum, above which it may be somewhat faintly marked by transverse lines; the lower portion having its walls thickened from above downward in a characteristically laminate fashion. Stalk-cell of the appendage abruptly distinguished from its much narrower basal cell, which becomes considerably broader distally, a rather large cell being separated from it terminally, bearing three antheridia: above it the appendage consists of two cells, the upper very small, bearing in all normally five antheridia, including the spinose terminal one. Venter of the perithecium pale amber-brown; the wall-cells bulging conspicuously throughout their length, and rather abruptly distinguished above the neck, usually stout and somewhat shorter than the venter; the tip asymmetrical, and slightly oblique, with projecting bluntly pointed apex. Perithecium, venter  $55-65 \times 30 \mu$ , neck  $50 \times 16-20 \mu$ . Appendage  $80-90 \mu$ , the stalk-cell  $15-20 \mu$ . Receptacle about  $65 \times 18 \mu$ . Spores  $40 \times 3.5 \mu$ .

On *Elachiptera longula* Loew., Intervale, New Hampshire.

I have had much hesitation in separating this species from *S. constrictus* to which it is too closely allied. In addition to minor points of difference the subbasal cell is rather inflated than constricted and the antheridial appendage differs constantly as indicated in the accompanying figures, in having three cells above the basal cell bearing eight antheridia, the terminal one spinose. The material of this form is abundant and well developed, and was obtained on the legs of its characteristic host, a small fly captured by sweeping over golden rod. The singular layering of the subbasal cell, its partial separation by an inner ridge opposite the nucleus and the transverse furrows of its upper half (fig. 9) are phenomena evidently similar to those seen in *S. constrictus*, and may possibly be connected with a secondary elongation of the basal cell.

STIGMATOMYCES PROBOSCIDEUS Thaxter. Plate XLVI, figs. 11-14.

Proc. Am. Acad. Arts and Sci., Vol. XXXVI, p. 403. March, 1901.

Venter of the perithecium amber-brown, sometimes more than twice as long as broad, usually but slightly inflated, often more so distally; the neck lighter brown, rather abruptly distinguished, relatively very stout, elongate, nearly isodiametric, usually curved throughout; the short tip abruptly somewhat narrower, the apex broad and blunt without well developed elevations. Stalk-cell of the appendage brown, relatively small and short, slightly prominent distally; the basal cell broader than long, the five fertile cells above it rather short and stout, the series curved sidewise, the antheridia lateral in pairs. Spores about  $30 \times 3 \mu$ . Perithecium: venter  $75-95 \times 32-36 \mu$ ; neck  $135-185 \times 18-22 \mu$ . Appendage  $55-72 \mu$ , stalk-cell  $18 \mu$ . Receptacle  $110-125 \times 29 \mu$ . Total length to tip of perithecium  $400 \mu$ .

On the abdomen of a small fly, Ralum, New Pomerania, Berlin Museum, No. 1288.



This species is distinguished by the very long curved nearly isodiametric neck of its perithecium, which is rather abruptly distinguished from the short broad truncate nearly isodiametric tip. The antheridia are not numerous and rather crowded on the appendage, the terminal one spiniferous. Under a high magnification the venter of the perithecium is seen to be finely transverse-punctate.

**Stigmatomyces Baeri** (Knoch) Peyritsch. Plate XLIX, figs. 22-24.

Since the adult of this species has not as yet been properly figured, I have given two illustrations in the accompanying plates for comparison. The terminal antheridium appears to have arisen from the terminal cell by proliferation, as the latter bears the spine, where its presence has been determined (fig. 22). In older individuals the twist of the wall-cells is even more pronounced than is indicated in fig. 23. The form of the perithecium is somewhat similar to that of *S. dubius*, which is, however, quite different in possessing an eight-celled appendage, and in other respects. I have not yet seen this species in America, but have no doubt that it occurs here.

**STIGMATOMYCES SARCOPHAGÆ** Thaxter. Plate XLIX, figs. 14-17.

Proc. Am. Acad. Arts and Sci., Vol. XLI, p. 325. July, 1905.

Normally long and slender. Color nearly uniform dull amber-brown, except the hyaline receptacle and the appendage above its basal cell. Venter of perithecium minutely transversely granular-striate, rather narrow, straight, the wall-cells prominent and slightly spiral; the neck rather abruptly distinguished, the cells more or less spirally disposed, a rather distinct subterminal enlargement, above which the subconical tip ends in a blunt slightly oblique apex, the paired posterior lip-cells slightly prominent; the basal cells small, somewhat prominent; the stalk-cell relatively large. The receptacle normally very elongate, hyaline, nearly isodiametric; the subbasal cell much longer than the basal. The appendage long, slender, recurved; its stalk-cell about two or three times as long as broad; the basal cell more than twice as long as broad, the portion above it consisting of five superposed cells, and a terminal antheridium; the total number of antheridia normally nine. Spores about  $35 \times 4 \mu$ . Venter of perithecium  $75-90 \times 35-42 \mu$ , the neck  $150 \times 18-22 \mu$ . Appendage, to edge of curvature,  $110 \mu$ , the stalk-cell about  $35 \mu$ , the basal cell  $18-20 \mu$ . Receptacle  $200-325 \times 30 \mu$ . Total length of larger individuals  $600 \mu$ .

In tufts on the abdomen of *Sarcophaga* sp., Island of Margarita, Venezuela; Dr. A. F. Blakeslee.

This large and fine species was obtained in great abundance on a black *Sarcophaga* collected in large numbers by Dr. Blakeslee by sweeping over a mud hole. I was at first inclined to think it identical with *S. Limnophoræ* which is its nearest ally, but the appendages are constantly different and the general characters are sufficiently unlike in the two species, to warrant their separation, although they are undoubtedly closely allied. The position of the spiniferous cell in the mature appendage has not been observed.

**STIGMATOMYCES LIMNOPHORÆ** Thaxter. Plate XLIX, figs. 11-13.

Proc. Am. Acad. Arts and Sci., Vol. XXXVI, p. 400. March, 1901.

Venter of the perithecium relatively small, amber-brown, the wall-cells becoming powdered by a darker maculation and separated by a corresponding number of well-defined unmodified longitudinal ridges which run somewhat obliquely and end, not abruptly, at the base of the neck: the latter generally slender, strongly bent throughout or even recurved, abruptly differentiated, sometimes of less diameter than the tip, which is distinguished from the rest of the neck by an abrupt enlargement more prominent anteriorly; the apex (in the not wholly mature types) unmodified, blunt, slightly oblique. Stalk-cell of the appendage rather prominently rounded externally, but not protruding abruptly below the basal cell, which nearly equals it in length and is slender, slightly larger distally, its base hyaline, its wall, which is dark amber-brown above, becoming gradually thicker, so that the lumen of the cell is attenuated below, distally bearing two antheridia; the fertile cells above it, usually seven in number, forming a series outwardly recurved, the terminal cell apparently sterile, the two small cells below it bearing each a single antheridium, while the remainder bear two; the antheridia with short, broad, slightly recurved necks.



Receptacle relatively large, hyaline, the basal cell tapering slightly downward, the subbasal cell slightly longer and much broader distally. Perithecium: venter  $55 \times 30 \mu$ ; neck  $75 \times 10 \mu$ . Appendage about  $75-80 \mu$ , stalk-cell  $28 \mu$ . Receptacle  $110 \times 25 \mu$ . Total length to tip of perithecium  $250-275 \mu$ .

On the inferior surface of the abdomen and at the base of the posterior legs of a species of *Limnophorus*. Berkeley, California.

The material on which this species is based was found on two specimens of *Limnophorus* sent from Berkeley with a miscellaneous lot of flies collected by sweeping. Although the perithecia are not quite mature, the characters of the species are sufficiently well defined. *S. Sarcophagæ* being the only form with which it is likely to be confused. The two are most readily distinguished by the appendage which is shorter, with more antheridia, in the present species. It is evidently somewhat proliferous, but I have been unable to determine the position of the spiniferous cell.

STIGMATOMYCES HUMILIS Thaxter. Plate XLVII, figs. 29-32.

Proc. Am. Acad. Arts and Sci., Vol. XXXVI, p. 401. June, 1901.

Venter of the perithecium amber-brown, slightly inflated throughout and slightly asymmetrical; the neck rather abruptly distinguished, concolorous, but paler distally, generally shorter than the venter, stout, tapering to the blunt, hardly differentiated apex; about one third of its length taken up by the tip, which is distinguished from it by a slight broad constriction; the outer basal cells subequal and irregularly prominent. Appendage relatively rather slender, very long, sometimes extending nearly to the middle of the neck of the perithecium, the stalk-cell separated by a slight constriction from the basal cell, which is relatively large, the annular thickening about the base on the inner side of its wall unusually well developed, amber-brown, bearing two antheridia; the subbasal cell almost as large, bearing two antheridia, the two successive cells above it smaller and bearing each a single antheridium; the series completed by a single terminal antheridium; the antheridial necks rather slender, and tapering, somewhat appressed. Receptacle short, stout, the cells subequal. Spores about  $28 \times 3 \mu$ . Perithecium: venter  $46-55 \times 32-37 \mu$ ; neck  $45-47 \mu$ . Appendage  $65-75 \mu$ , the stalk-cell  $18 \mu$ . Receptacle  $55 \mu$ . Total length to tip of perithecium  $175 \mu$ .

On the superior surface near the tip of the abdomen of a muscid somewhat larger than the other hosts from Ralum, New Pomerania. Berlin Museum, No. 1287.

This small and somewhat insignificant species is distinguished by its compact habit, the large venter and short neck of its perithecium, and its relatively large and elongate appendage, which may reach to the middle of the perithecial neck. Its terminal antheridium is spinose just below the neck.

STIGMATOMYCES DUBIUS Thaxter. Plate XLVII, figs. 14-18.

Proc. Am. Acad. Arts and Sci., Vol. XXXVI, p. 402. March, 1901.

Amber-brown with the exception of the receptacle and the stalk-cell of the perithecium. Venter of the perithecium slightly inflated, relatively small, not abruptly differentiated from the broad neck, which gradually enlarges distally below the rather abruptly tapering, slightly bent tip; the middle of the three posterior projections from the lip-cells larger and longer than the others and bent over so as to overlap the anterior lip-cells, which are curved abruptly toward it; the two lateral posterior projections prominent beyond the base of the middle one, rather slender, and slightly curved inward. Stalk-cell of the appendage distally darker, abruptly prominent below the basal cell, which is small, squarish, and deeper brown; the rest of the appendage, which is unusually long, apparently proliferous above the spiniferous cell, extending beyond the venter of the perithecium, is made up of about eight cells, which bear rather long antheridia in pairs, their necks appressed usually in a lateral series. Receptacle relatively large, hyaline, the subbasal cell much longer and broader than the basal cell, which tapers but slightly to the small foot. Spores  $30 \times 3.5 \mu$ . Perithecium: venter  $58 \times 40 \mu$ ; neck  $110 \times 25 \mu$ . Appendage  $80-95 \mu$ , stalk-cell  $25-32 \mu$ . Receptacle  $145-185 \times 25-30 \mu$ . Total length  $350-375 \mu$ .

On a fly with monstrously developed anterior legs resembling those of *Ochtheria mantis*. Ralum,



New Pomerania. Berlin Museum, No. 1281 and 1298. On the head and at the base of the posterior legs.

This species is chiefly peculiar for its long flat appressed appendage, the axis of which consists of eight or more cells including the basal cell. The spine arises from the base of the eighth cell where its position has been determined. The neck of the perithecium is relatively stout and has a "bloated" look and is usually not abruptly distinguished from the venter.

STIGMATOMYCES LIMOSINÆ Thaxter. Plate XLVII, figs. 1-7.

Proc. Am. Acad. Arts and Sci., Vol. XXXVI, p. 406. March, 1901.

Perithecium amber-brown, the venter slightly inflated, the neck not abruptly distinguished, tapering slightly; the tip usually abruptly narrower, the posterior lip-cells forming an inconspicuous irregular truncate or rounded bilobed projection somewhat more prominent than a similar projection formed by the anterior lip-cells; basal cells relatively very large, forming a short, well-defined stalk, hyaline or colored above, often carrying the base of the perithecium beyond the tip of the appendage, and consisting of an inner cell next the appendage and two superposed outer ones, the lower of which (secondary stalk-cell) is smaller; the stalk-cell below these wholly united to the stalk-cell of the appendage, rather stout and short, separated from the cells above it by a horizontal septum, which may be slightly oblique or (as in the California variety) strongly oblique, in which case the secondary stalk-cell extends downward beside the stalk-cell so that only the lower third or quarter of the latter is free externally. Stalk-cell of the appendage relatively large, as long as or often longer than that of the perithecium and about half as broad, usually bulging externally, its outer margin usually curved symmetrically from its base to the base of the basal cell; the latter relatively small, deep amber-brown, half as long as broad, pointed distally between the antheridium which arises from its inner side and the base of the first fertile cell above it, which, with the other fertile cells, are large and prominent, thick walled, much flattened, and obliquely superposed, distinguished by rather deep constrictions, seven to ten in all, or rarely more (seven to fourteen in the Californian form), the original number being increased by the terminal proliferation of the appendage; the antheridia borne on the inner side of the appendage, their very long but not abruptly differentiated necks extending obliquely upward, appressed in a double series; the upper antheridia often infertile, becoming septate and irregularly swollen. Receptacle relatively short, the two cells nearly equal. Spores  $28 \times 3 \mu$ . Perithecium: venter  $50-90 \times 40-54 \mu$ ; neck  $90-125 \times 15-18 \mu$ ; stalk (basal cells only)  $72-100 \times 25-35 \mu$ . Appendage  $60-100 \mu$ , stalk-cell  $30-45 \mu$ . Receptacle  $70-75 \times 22 \mu$ . Total length to tip of perithecium  $250-360 \mu$ . Specimens on legs often much smaller.

On *Limosina fontinalis* Fallen. Kittery Point, Maine; vicinity of Cambridge, Mass.; on *Limosina* sp., Berkeley, California. Usually in a dense tuft on the side or near the tip (inferior) of the abdomen and near the base of the posterior pair of legs.

The Californian material, figs. 3-4, from two specimens of the host, differs constantly from the abundant New England material as noted in the description, as well as from the fact that the venter of the perithecium is longer and less distinctly inflated, while its apex shows no perceptible modification of the lip-cells. The species is remarkable for the repeated proliferation of its appendage, which makes the primarily terminal spinose cell intercalary, the distal cells unlike those of any other species, with the exception of the nearly allied *S. Papuanus*, being usually sterile. The host is a small fly, beset with coarse hairs, and captured by sweeping around muddy ponds or over wet places in woods.

STIGMATOMYCES PAPUANUS Thaxter. Plate XLVII, figs. 8-13.

Proc. Am. Acad. Arts and Sci., Vol. XXXVI, p. 407. March, 1901.

Venter of the perithecium dark amber-brown, relatively small and rather prominently inflated, oval to elliptical; usually not abruptly distinguished distally from the hyaline or yellowish neck, which in well-developed specimens is very elongate, tapering very gradually, in others shorter and stouter; the tip clearly distinguished (abruptly so in the shorter forms), subconical, the posterior lip-cells forming a narrow, subtruncate, slightly recurved apical projection beyond the two laterally placed, papillate,



slightly divergent projections of the anterior lip-cells; the basal cells forming a short, stout stalk, separated from the stalk-cell by an oblique septum. Appendage relatively small, resembling that of the *S. Limosina* in general form, the fertile cells not more than five or six in number, the upper ones separated by constrictions which may be obsolete between the lower ones. Receptacle relatively short, the cells subequal, yellowish. Spores about  $20 \times 2 \mu$ . Perithecium: venter  $50-55 \times 40 \mu$ ; the neck  $90-290 \times 20 \mu$ ; the stalk  $35-45 \times 33-36 \mu$ . Appendage,  $35-45 \mu$ , the stalk-cell  $22-30 \times 14-17 \mu$ . Receptacle  $55-72 \mu$ . Total length to tip of perithecium  $400-485 \mu$ . A few specimens on the legs much smaller.

On three small flies of different species allied to *Limosina*. Ralum, New Pomerania.

This species may prove a regional variety of *S. Limosina*, the appendage, though much smaller, and never well developed, being nevertheless of the same peculiar irregularly proliferous type, not seen in any other species. It differs chiefly in the bulbous venter of its perithecium, which passes distally into the enormously developed elongate neck and tip.

#### ARTHRORHYNCHUS Kolenati.

The original name given to this genus in 1857 by Kolenati is here retained in preference to the much later one applied to it by Peyritsch, who redescribed it as *Helminthophana* in 1873; since, however absurd and scientifically worthless the original zoological descriptions of these forms may be, there has never been the slightest question as to the generic identity of the organisms studied by these two authors. Neither the descriptions nor the figures given by Kolenati and Diesing are, however, sufficient to render a specific determination possible, so that the name given by Peyritsch to the European species of the genus, although undoubtedly a synonym of *A. Diesingii* Kol. or of *A. Westrumbii* Kol., or more probably of both, may properly be retained.

The three species herewith illustrated are all characterized by the possession of a highly developed rhizoidal apparatus, which penetrates the soft body-cavity of the host, and arises from a slightly swollen extension of the basal cell. From this intrusion is produced a mass of copiously branching hyaline filaments, which become interlaced in a mass so dense that the course of individual filaments cannot be followed in detail. This condition is barely suggested in Plate XLVIII, fig. 2, in which a few of the branches are approximately indicated.

The genus is undoubtedly very closely related to *Stigmatomyces*, differing in the relative development of the perithecium and receptacle, as well as in its antheridial appendage. The antheridia, although in *A. Cyclopodia* they are somewhat unilateral, usually assume a more or less distinctly whorled arrangement on the cells of the appendage, as is well illustrated by the two other species. The modifications of the basal and stalk-cells of these appendages in *A. Cyclopodia* and *A. Eucampsipoda* are very peculiar, and the curious thickenings which are also well marked in the basal cell of the appendage proper of some species of *Stigmatomyces*, are especially noticeable in the first mentioned species. This peculiar structure is perhaps concerned in the partial rotation of the appendage, by which the antheridia become turned away from the perithecium at maturity. As in many species of *Stigmatomyces* the terminal antheridium is armed with a stout spine.

There appears to be but a single ascogenic cell in all three species which is very conspicuous, and peculiar from the fact that, as in *Moschomyces* and a few other genera, it produces the numerous asci which arise from it in several vertical rows, instead of in two, as is more commonly the condition. This is clearly shown in fig. 11, in which a posterior view of the ascus-mass is given, figs. 1 and 7 showing lateral views of similar masses, and their relation to the ascogenic cells.

Dr. P. Speiser, who has made a specialty of the Nycteribidæ, gives a list, in his note on the geographical distribution of the genus *Helminthophana*, of the hosts on which *H. Nycteribia* has been observed; but it is evident that at least the three species enumerated below are included in this enumeration. The forms on *Cyclopodia macrura* Speiser are *A. Cyclopodia*, the specimens examined by Dr. Speiser and by



myself being the same. Those on *Eucampsipoda Hyrtli* Kol. belong to *A. Eucampsipodæ*, one of the specimens here referred to being the same examined by myself in the Berlin Museum. The other hosts mentioned, which are European and may be assumed to have been infested by *A. Nycteribia*, at least in some cases, are as follows: *Nycteribia Blasii* Kol., from East Prussia, *N. vexata* Westw., Austria; *Penicillidia conspicua* Speiser, Servia and *P. Dufourii* (Westw), Banat; but it is not impossible that two species may have been confused here. The hosts are all wingless parasites of bats and do not appear to be very commonly infested. I have myself examined the Nycteribidæ in the British Museum and in the Museums at Berlin and Florence, as well as such scanty material as has been available in this country, but, with the exception of the forms referred to seen at Berlin, no parasites were discovered.

ARTHRORHYNCHUS NYCTERIBIÆ (Peyritsch) Thaxter, Plate XLVIII, figs. 7-10.

Thaxter, Proc. Am. Acad. Arts and Sci., Vol. XXXVI, p. 408, March, 1901.

Although the specimens obtained in the Berlin Museum from species of *Nycteribia* (*N. Frauenfeldii* Kol., No. 922 and *N. Hermani* Leabl., No. 856, both presumably from Europe) do not correspond in all details with the figures given by Peyritsch, especially as regards the conformation of the perithecium, it can hardly be doubted that they belong to the present species, the long free stalk-cell of the appendage being a character which is quite peculiar. The tip of the perithecium is four-lobed, the lobes short and broad, like those of *A. Eucampsipodæ*; but are in turn conspicuously three-lobed. Reference has previously been made under the genus to Dr. Speiser's notes in regard to hosts of this species.

ARTHRORHYNCHUS CYCLOPODIÆ Thaxter. Plate XLVIII, figs. 1-6.

Proc. Am. Acad. Arts and Sci., Vol. XXXVI, p. 407. March, 1901.

Becoming tinged with brownish yellow except the hyaline stalk-cell of the perithecium. Perithecium nearly straight and symmetrical, slightly inflated, usually distinctly constricted in the region of its very small basal cells just above the very large hyaline stalk-cell, which may nearly equal it in length and diameter and is often somewhat enlarged distally: the venter comprising the lower two-thirds, not clearly distinguishable from the neck, which tapers slightly and almost symmetrically, the tip fairly well distinguished above a more or less distinct enlargement, from which it is separated by a slight constriction; the apex consisting of a crown of four nearly symmetrical, distinctly tridentate, erect, or very slightly divergent projections, which are subtended by a corresponding number of slight elevations, the middle lobe of each projection more prominent than the lateral and like them bluntly rounded. Receptacle consisting of two small cells, the lower twice as large as the upper, which gives rise distally to the stalk-cell and bears the free appendage laterally; the foot an unmodified cell which penetrates the host, dividing below into a very copiously branched system of slender, sinuous, rhizoidal hyphæ. Appendage consisting of a dumb-bell-shaped, free stalk-cell, the basal half-rounded or flattened, brownish, somewhat larger than the distal portion, which is deeper brown, flattened and inflated, connected by a narrow hyaline isthmus (the lumen of which may become almost obliterated) with the lower half, and mostly broader than the base of the basal cell of the appendage, which is infertile, subrectangular, or somewhat inflated, slightly longer than broad, the lower half of the walls becoming conspicuously modified by a progressive thickening from above downward, the thickened portion deeper brown; the remaining cells of the appendage three to four in number, brownish, successively smaller from below upward, giving the organ a characteristically tapering habit; the two lowest of these cells usually relatively shorter, and bearing each three to four antheridia side by side, distally and externally; those above relatively longer and narrower and producing fewer antheridia, the terminal one spiniferous. Antheridia with slender curved necks. Spores  $60-65 \times 4.5 \mu$ . Perithecium: venter  $325-350 \times 70-90 \mu$ ; the stalk-cell  $220-250 \times 75-80 \mu$ . Appendage,  $100-110 \mu$ , the stalk-cell  $35-40 \times 30-35 \mu$  (the upper half  $\times 28-30 \mu$ ). Receptacle  $55-75 \times 45-50 \mu$ .

On the abdomen of *Cyclopodia macrura* Speiser. New Pomerania. Berlin Museum, No. 854, (Dr. Dahl).



Although Dr. Speiser in his note above referred to, appears to consider this form identical with *A. Nycteribia*, there can, I think, be no doubt whatever of its specific distinctness, as a comparison of the accompanying figures will clearly show. The appendage in this species resembles that of *Stigmatomyces* more closely from the somewhat unilateral position of the antheridia; which are fewer in number than in the other species. The host examined was an alcoholic specimen, the Type of Dr. Speiser in the Berlin Museum, and was one of the many interesting forms brought by Dr. Dahl from New Pommerania, near New Guinea. The specimens are mostly broken from the host in removal, yet in a few specimens in which a fragment of the integument adheres, the entering rhizoids are clearly seen forming a dense mass of tortuous branching filaments, which it is quite impossible to follow in detail. The rhizoidal apparatus in this species is more extensively developed than in any other form, not excepting that which is represented in an unbroken condition in the figures of *Ceraiomycetes Dahlii* (Plate XLIII, fig. 4).

ARTHROHYNCHUS EUCAMPSIPODÆ Thaxter. Plate XLVIII, figs. 11-14.

Proc. Am. Acad. Arts and Sci., Vol. XXXVI, p. 109. March, 1902.

Hyaline throughout. Perithecium straight or distally slightly curved, tapering gradually from the middle, or lower, to the broad tip; the apex consisting of a slight median projection surrounded by a crown consisting of four slightly shorter, broad, blunt, distinctly divergent projections, which show indistinct marks of lobing and are symmetrically placed; the stalk-cell about one half as long as the perithecium or less. The basal cell of the appendage constricted in the middle as in the preceding species, the lower half irregularly rounded and four or five times as large as the upper half, which is very small, colorless, and less than half as wide as the cell above it; the fertile cells three in number, the lower bearing four or (?) five antheridia, the upper three in addition to the terminal one, which is furnished with a short hyaline basal spine; the necks of the antheridia large, tapering, divergent. Receptacle as in the preceding species. Spores about  $45-50 \times 4 \mu$ . Perithecium: venter  $250-325 \times 65-75 \mu$ ; the stalk-cell  $110-150 \times 55 \mu$ . Appendage,  $75-90 \mu$ , the stalk-cell  $35 \times 25$  (the upper half  $\times 10 \mu$ ).

On the abdomen of *Eucampsipoda Hyrtli* Kol., Egypt. Berlin Museum, No. 855.

As in the case of the preceding species, Dr. Speiser is inclined to consider this form as identical with *A. Nycteribia*, but it seems certainly distinct. It is undoubtedly much more closely allied to *A. Eucampsipodæ*, from which it differs more especially in the details of its appendage. As may be seen by a comparison of figs. 14 and 3, the antheridia of the present form are more numerous and differently disposed, while the conformation at the base of the appendage is quite different in the two cases, the upper lobe of the stalk-cell being very small and not continuous with the base of the appendage proper, as in *A. Cyclopodia*. The four lobes at the tip of the perithecium are short and more like those in *A. Nycteribia*, but are not three-lobed as in that species.

#### IDIOMYCES PEYRITSCHII Thaxter.

Additional material of this species has been obtained as follows: Hope Collection, No. 223 on *Deleaster dichrous*, England; and from Scotland on the same host in the Sharp collection: British Museum, No. 393, Europe. On *D. adustus*, Sharp Collection No. 1093, England. I found the peculiar host flying in the evening at Lauterbrunnen, Switzerland, in the village street, and one of the specimens bore a few individuals of this curious form, which seems to be a transitional type between *Stigmatomyces* and the group of genera immediately associated with *Teratomyces*; in which the proliferation and production of appendiculate cells about the base of the perithecial stalk-cells has become much more marked.

#### SYMPLECTROMYCES nov. gen.

Receptacle consisting of three to four superposed cells, the distal one irregularly proliferous, the proliferations resulting in the formation of numerous appendiculate cells, or short appendiculate branches, which surround more or less completely the bases of the perithecia. Appendages fertile or sterile; the latter simple, cylindrical, sometimes terminated by a beak-like cell: the fertile consisting of numerous



superposed cells all of which, except the two or three basal ones and the terminal one, function as antheridial cells, opening by short necks superposed in a single series.

This genus is made for the reception of a single species formerly placed in *Teratomyces*, from which it differs in the character of its appendages, both sterile and fertile; the latter resembling more nearly those of *Corethromyces* by reason of the serial arrangement of its intercalary antheridial cells. The two or three sterile basal cells of this appendage are usually rather definitely distinguished by a slight constriction from the appendiculate cell, and the antheridial cells appear to be formed through successive divisions of a terminal cell which surmounts the series at maturity and is not functional. It is evident that the genus is closely related to *Teratomyces*, between which and *Corethromyces* it seems, on account of the structure of its antheridial appendages, to form a connecting link. The antheridial appendages also recall those of *Stigmatomyces*, but are of a different type, since the successive cells which compose them and are assumed to be antheridial cells, are absolutely intercalary and do not cut off a basal cell.

***Symplectromyces vulgaris* nov. comb.** Plate L, figs. 14-16.

*Teratomyces vulgaris* Thaxter, l. c., Proc. Am. Acad. Arts and Sci., Vol. XXXV, p. 431. April, 1900.

Perithecia one to three in number, usually symmetrical and straight, becoming clear purplish brown, often considerably inflated below and conical above; the tip blunt or sometimes slightly pointed, the basal cells variously elongated sometimes nearly as long as the perithecium proper and often longer than the usually well developed stalk-cell. Receptacle symmetrical, its basal cell nearly hyaline, the cell above it tinged with reddish brown and somewhat larger, the third cell like the subbasal, squarish and somewhat larger. Appendages nearly hyaline or suffused, never deeply, with reddish brown, comparatively few in number, rather stout and long in general, curved beak-like cells sometimes borne on short peripheral appendages; all the appendages, or their primary branches, distinguished by a blackish brown basal septum, some, often many of them distinguished by being closely septate above, the cells thus formed (the antheridia ?) producing a series of lateral outgrowths projecting obliquely upward and superposed. Perithecia  $140-200 \times 45-60 \mu$ , their basal cells  $40-120 \mu$ , the stalk-cell  $35-126 \times 25 \mu$ . Receptacle to base of appendages  $70-100 \mu$ . Appendages (longest)  $175 \mu$ . Total length to tip of perithecium  $325-450 \mu$ .

On *Quedius fulgidus* Fabr., British Museum, No. 354, Kiel, Germany, Berlin Museum No. 828; Europe, Sharp Collection No. 1096, Spain; on *Q. fuliginosus* Grav., British Museum, No. 355, Europe; on *Q. truncicolus* Fair (= *ventralis* Arag.), British Museum, No. 435, Great Britain; on *Q. cruentus* Oliv., British Museum, No. 422, Europe; on *Quedius* sp. indet., British Museum, No. 356, Canada; on *Q. fulgidus* Fabr., Hope Coll., No. 216, Europe; on *Philonthus?* sp. indet., British Museum, No. 365, Hungary. Berlin Museum No. 830 on *Quedius impressus* Panz., Lusitania, No. 829 on *Q. occultus*, North America, No. 831 on *Quedius* sp., Bengal: Sharp Collection on *Q. dubius* Heer., Albertville, Grande Chatreuse, near Monte Rosa: LeConte Collection on *Quedius peregrinus* Grav., Canada.

It is evident from the hosts and localities above enumerated that this species is widely distributed, although I have never had an opportunity to examine it in a fresh condition and have thus been unable absolutely to observe any discharge from the antheridia. The appendages appear to be very easily broken and are not in good condition in a majority of the specimens examined. A few that are comparatively young possess short peripheral appendages which, as in *Teratomyces*, are terminated by the beak-like cell characteristic of this genus. It is very doubtful if the record on *Philonthus* is reliable.

**TERATOMYCES** Thaxter.

Several notable additions are made to this well marked type which is a very constant one, as the genus is now restricted by the exclusion of *Symplectromyces vulgaris*. One additional form is known to exist, which was found on a species of *Acylophorus* in the British Museum, No. 394, from Tasmania, and



is easily distinguished by its slender form and translucent receptacle, the basal cell of which is very small and conspicuously suffused. The material was however too immature for description.

Of the species previously illustrated *T. Actobii* has been found in the British Museum on *Actobius cinerascens* Gr., from Merton, England, No. 438: *T. mirificus* has also been again observed on a species of *Acylophorus* from Lake Eustis, Florida.

TERATOMYCES PHILONTHI Thaxter. Plate XLIX, figs. 4-5.

Proc. Am. Acad. Arts and Sci., Vol. XXXV, p. 432. April, 1900.

Perithecia commonly two, long and slender, a basal middle and distal portion distinguished, corresponding to the basal, middle and the distal wall- and lip-cells, the basal portion slightly inflated, purplish, the middle distinguished from it by a slight elevation at the septa; the middle nearly hyaline, rather abruptly narrowed, its margin slightly concave owing to a slight distal enlargement, which, in mature specimens, distinguishes it rather abruptly from the much shorter narrower subconical mostly symmetrically truncate colorless distal portion; the stalk-cell rather short, concealed by the appendages; the basal cells forming a squarish base. Receptacle relatively small, symmetrical or asymmetrical, the basal cell translucent brownish, the subbasal cell very small, flattish, wholly involved by the deep nearly opaque suffusion of the lower half or more of the upper cell, which is nearly hyaline above. Appendages short, slightly exceeding the base of the perithecium, rather rigid, slightly divergent, for the most part dark brown; forming a rather dense tuft, many ending in pointed cells, the slender terminations straight or bent and forming the beak-like cells characteristic of the genus. Spores  $36 \times 4 \mu$ . Perithecia  $140-175 \times 25-30 \mu$ , the stalk-cell about  $35 \mu$ . Receptacle about  $85 \times 35 \mu$ . Appendages (longest) about  $70 \mu$ . Total length to tip of perithecium  $250-300 \mu$ .

On *Philonthus* sp. indet., British Museum, No. 365, Hungary.

A species well distinguished by the successive ridges on the perithecium and short dense appendages. It appears to be rare as I have met with it only once among the many hundreds of *Philonthi* examined. It is possible that the generic determination of the host may not be correct.

TERATOMYCES ZEALANDICA Thaxter. Plate XLIX, figs. 1-3.

Receptacle with a distinct distal obliquity, opaque with the exception of a hyaline area just above the foot, the margins straight, the distal portion relatively narrow, the base relatively broad, the suffusion involving the bases of the appendiculate cells which are relatively numerous and narrow and more or less suffused with brownish yellow. Appendages sometimes scanty, but slightly divergent, concolorous throughout, nearly hyaline or pale yellowish; the basal cells of the larger branches relatively slender, the external branchlets and numerous beak-like cells hardly more deeply colored. Perithecia relatively large, long, rather slender, slightly inflated throughout, the blunt tip more or less abruptly distinguished; the stalk-cell very short or almost obsolete, hidden by the appendages; the basal cells relatively small and not distinguished from the body of the perithecium. Spores about  $50 \times 2.5-3 \mu$ . Perithecia  $150-180 \times 20-28 \mu$ , basal and stalk-cells together about  $35 \mu$ . Longest appendage  $180 \mu$ . Receptacle  $75-125 \times 15-18$  (base)  $22-30 \mu$  (distally).

On *Quælius insolitus* Sharp. Dunedin, New Zealand. Sharp Collection, No. 1099.

This species is well distinguished by its nearly isodiametric receptacle, as well as by its appendages, which are either wholly hyaline, or evenly and only slightly suffused; while the dark ring which separates the stalk-cell of the perithecium from the receptacle (fig. 1) is at least not visible in other species.

TERATOMYCES PETIOLATUS Thaxter. Plate XLIX, fig. 7.

Proc. Am. Acad. Arts and Sci., Vol. XXXVII, p. 35. June, 1901.

Receptacle nearly symmetrical, almost wholly black, slender below, expanding rather abruptly distally; the appendiculate cells relatively large and long, translucent, brownish yellow, subtended by a slight enlargement. Appendages numerous, spreading, the larger ones consisting of a very large colorless



or brownish basal cell, which bears a series of branchlets externally and several branches terminally; the branchlets usually short, and two-celled, the distal cell usually long, beak-like and clear purplish brown, the lower cell hyaline or light brown and in the lower branchlets usually bearing long-necked antheridia: the terminal branches with several short branchlets of a similar character. The smaller shorter appendages about the bases of the larger ones, mostly dark purplish brown, with many beak-like cells. Perithecia usually several, large, symmetrical, purplish brown; the tip short, rather narrow and abruptly distinguished; the basal cells relatively very large, forming a portion of the stalk sometimes half as long as the perithecium proper; the stalk-cell stout and elongate. Perithecia  $185-225 \times 45-50 \mu$ , the basal cell  $100-150 \times 10 \mu$ , the stalk-cells  $180-300 \mu$ . Receptacle about  $150 \mu$ . Appendage, longest  $175$ , longest basal cells  $110 \mu$ .

On *Quedius* sp. Greymouth, New Zealand, Sharp Collection, No. 1103.

This species, which is nearly allied to *T. insignis*, differs in its shorter and abundantly branched appendages, as well as in the characters of its perithecia, the basal cells of which are very large and not related as in the last mentioned species.

TERATOMYCES INSIGNIS Thaxter. Plate L, figs. 12-13.

Proc. Am. Acad. Arts and Sci., Vol. XXXVII, p. 36. June, 1901.

Receptacle usually quite opaque, long, slender; the outline unbroken and nearly straight, tapering evenly to the slightly geniculate base, which is nearly hyaline just above the foot: the margin of the suffused area distally strongly oblique, especially before maturity; the appendiculate cells small, becoming brownish. The appendages numerous, spreading, the larger ones hyaline or nearly so, consisting of a large elongate basal cell, which bears two or three small remote antheridial branches externally; and terminally, as a rule, two large branches placed side by side (one of which may be wanting) sometimes associated with one or two subterminal smaller branchlets, the basal cells of which are dark contrasting brown: the terminal branches hyaline with branchlets like those of the basal cell; the branchlets, however, more numerous, contrasting, brown, simple or branched, many having characteristic beak-like terminations, while others are blunt tipped, with oblique septa. The smaller peripheral appendages more or less crowded around the bases of the larger ones, with conspicuous and numerous beak-like terminations. The antheridia with long curved necks. Perithecia usually several, brown, long and slender, straight, very slightly inflated near the base, with a slight submedian enlargement; tapering throughout to the short, truncate, well distinguished tip: the basal cells rather small, concolorous; the group narrower than the stalk-cell and separated from it by a horizontal septum: the stalk-cell very large, usually elongate, often inflated and thick walled. Spores about  $50 \times 4 \mu$ . Perithecia including basal cells  $240-275 \times 40 \mu$ , the stalk-cell  $150-325 \times 25-35 \mu$ . Appendages, longest  $225 \mu$ . Receptacle  $100-185 \times 14$  (base)  $\times 55$  (distal end). Total length to tip of perithecium largest,  $800 \mu$ .

On abdomen of *Quedius* nov. sp., New Zealand. Sharp Collection, No. 1159.

The accompanying figures represent what appear to be variations of this species, fig. 12 being taken as the Type, both obtained from the same individual. Although they differ as to the suffusion of the receptacle, and to some extent as to the appendages, I am inclined to consider them the same, the differences, being perhaps due partly to difference in age or position of growth.

#### RHADINOMYCES Thaxter.

I have called attention in my Monograph to the close relation between this genus and *Corethromyces*, but though I have been often tempted to unite them, I feel that until the species are more thoroughly known they are best kept separate. The present genus normally produces one or more secondary perithecia, while this is an exceptional occurrence in *Corethromyces*, and these secondary perithecia always arise from the subbasal cell like the primary one. In *Corethromyces*, on the other hand, when a secondary perithecium occurs it is always developed from the basal cell of the appendage; and while this basal



cell is never appendiculate in this genus, it is normally so in *Rhadinomyces*. There are also certain differences in the antheridial branchlets which may be significant. Several allied forms are represented in my South American material which has not yet been studied and it may be hoped that an examination of these new forms may make a more definite conclusion possible.

Of the species of *Rhadinomyces* first described, I have found *R. pallidus* in its typical form in the British Museum, No. 441 on *Lathrobium angustatum* from Folkestone, England, No. 444; on *L. quadratum* from Notting Hill, England; and also in the Hope Collection No. 226 on *Lathrobium* sp. from England. A third species, possibly a variety of *R. cristatus*, has been found on several *Lathrobia* in America, and was illustrated in my Monograph, Plate IX, fig. 10, as "Var. a." The same form, or one closely allied, was obtained in the British Museum, No. 445, on *L. terminatum* Gr., from Eltham, and in the Sharp Collection, No. 1144, on *L. brunneipennis* from Thornhill, England. It is necessary, however, to examine more abundant and better material of this variety before its limits can be determined.

#### CORETHROMYCES Thaxter.

Two typical species are added to this genus which correspond in all respects to the original type, and also two peculiar forms on *Stilicus* which depart distinctly from this type. The relations of their antheridia, however, appear to correspond to the type as may be seen in fig. 9, plate L, and their reference here appears to be correct.

#### CORETHROMYCES CRYPTOBII Thaxter. Plate LI, fig. 3.

This species appears to vary considerably in size, the accompanying figure representing its extreme development. The individual illustrated was associated on the same host with much smaller ones in which the appendages form a shorter denser tuft; but in all cases there seem to be three main erect branches of the appendage which, in connection with other details of structure, serve to distinguish it from the allied *C. Braziliensis*. The figure is drawn from material found on specimens of *Cryptobium* kindly sent me from Kansas by Professor M. A. Barber.

#### CORETHROMYCES BRAZILIANUS Thaxter. Plate LI, figs. 1-2.

Proc. Am. Acad. Arts and Sci., Vol. XXXV, p. 432. June, 1901.

Perithecium and receptacle much as in *C. Cryptobii*, but differing distinctly in the character of its appendage, the inner main branch of which consists of from four to six cells, the others very short, all nearly opaque, the branchlets long rigid divergent, curved abruptly outward at the tips. Total length to tip of perithecium 200-375  $\mu$ . Spores  $28 \times 3 \mu$ . Perithecia  $90-175 \times 28-38 \mu$ . Appendages to tip of branchlets 140-200  $\mu$ . Two specimens from Colombia, apparently identical, are much larger; total length 610  $\mu$ ; branches of appendages 540  $\mu$ ; perithecia 450  $\mu$ .

On *Cryptobium Brazilianum* Luc., Paris Museum, No. 173, (Type) Brazil; on *C. fasciatum* Erichs, Paris Museum, No. 197, Caracas, Venezuela; on *C. Flohri* Sharp, British Museum (Biologia Coll.), No. 762, City of Mexico; also from same collection on *C. venustum* Sharp, No. 758, Oaxaca, Mexico; on *C. similipenne* Say, No. 761, Mexico. The larger type on *Cryptobium* sp. indet., British Museum, No. 385, Colombia. On all parts of host.

This species seems clearly distinguished from *C. Cryptobii* in that its appendage produces only an inner main branch, the rigid branchlets from which, together with the tuft of short external branches from the main appendage, are bent outward in a characteristic fashion quite unlike that in *C. Cryptobii*. The very large specimens (British Museum No. 385) from Columbia do not appear to differ essentially from the typical form, and similar variations in size are common in *C. Cryptobii*.

#### CORETHROMYCES PURPURASCENS Thaxter. Plate L, figs. 4-5.

Proc. Am. Acad. Arts and Sci., Vol. XXXV, p. 433. April, 1900.

Perithecia dull purple, mostly slender straight or slightly curved, nearly isodiametric or the outer margin convex; the base slightly broader, the junction of the basal and subbasal, and of the subbasal and



subterminal wall-cells indicated by a distinct protrusion in well developed individuals, in which the tip is thus moderately well distinguished; although in most cases, especially in smaller specimens, the margin forms an unbroken line from base to apex, the perithecium being sometimes distinctly inflated basally; the stalk-cell as in *C. Cryptobii*, hyaline above, becoming opaque brown below. Basal cell of the receptacle purplish or brownish translucent, the rest opaque indistinguishable from the almost wholly opaque main body of the appendage, the oblique inner margin of which is followed by a series of hyaline or purplish cells, three or more in number which give rise to the erect branches; the primary branches sometimes purplish near the base but producing an erect tuft of branches and branchlets which are quite hyaline, more or less flexuous and tapering. Perithecia  $100-150 \times 25 \mu$ . Total length to tip of perithecium  $175-275 \mu$ . Longest branches of appendages about  $140 \mu$ .

On *Cryptobium capitatum*, Paris Museum, No. 172, Brazil; on *Cryptobium* sp. indet., British Museum, No. 494, Balthazar, Grenada, West Indies.

Although distinguished from the allied *C. Cryptobii* by no very striking characters, this species can hardly be confused with it on account of its purplish color and hyaline appendages, which are suffused only about the base.

CORETHROMYCES STILICI Thaxter. Plate L, figs. 6-9.

Proc. Am. Acad. Arts and Sci., Vol. XXXVII, p. 42. June, 1901.

Perithecium amber-colored, with a faint brownish or reddish tinge, somewhat irregular in outline through a spiral twist in the wall-cells, which are distinguished from one another by slight furrows; slightly inflated toward the base, tapering to the broad blunt apex; the tip not at all distinguished; the basal and stalk-cells well developed, hyaline, the latter bent abruptly upward from its insertion. Basal cell of the receptacle small, hyaline on the anterior side just above the foot, but otherwise blackish brown or opaque, bulging posteriorly above the foot; distally and posteriorly proliferous to form a straight, black, blunt finger-like outgrowth, which lies external to the appendage; the subbasal cell nearly hyaline, subtriangular, separated from the basal cell by a very oblique septum. Appendage hyaline, consisting of a nearly free and nearly isodiametric stalk-cell, above which are three or four cells which produce a close tuft of hyaline branches on the inner side. Spores about  $30 \times 3 \mu$ . Perithecia  $80-85 \times 22 \mu$ , its stalk-cell  $30 \times 18 \mu$ . Receptacle  $25 \mu$ , the outgrowth  $55 \times 7 \mu$ . Appendage, including branches,  $50 \mu$ . Total length to tip of perithecium  $150 \mu$ .

On the abdomen of *Stilicus* sp., Interlaken, Switzerland. On *Stilicus rufipes* Germ., Berlin Museum, No. 836. Europe. On *S. angularis* Lec., Arlington, Mass.

The American specimens of this species appear to be identical with the European material. It is principally peculiar for the blackened proliferation of the basal cell, which is somewhat variably developed in different individuals. It is a small form not readily seen as it grows more or less appressed on the black abdomen of its host, an ant-like staphilinid common in dry brush piles.

CORETHROMYCES LONGICAULIS Thaxter. Plate L, figs. 10-11.

Proc. Am. Acad. Arts and Sci., Vol. XXXVIII, p. 21. June, 1902.

Receptacle abnormally developed, very small, the basal and subbasal cells arising almost side by side immediately above the foot; the basal cell long and narrow, strongly curved so as to become concave externally, its wall very thick, the cavity becoming almost obliterated; the distal half nearly horizontal, slightly bulging and becoming wholly deep black-brown, except along its upper (in position) margin which is transparent yellowish and closely applied to the lower surface of the basal cell of the appendage, beyond which it hardly projects externally and which thus appears to arise from it; the subbasal cell larger, nearly hyaline externally, convex, bulging below, with a more or less distinct constriction below its slightly enlarged upper portion, which gives rise distally to the broad stalk-cell of the perithecium and sublaterally to that of the appendage. The appendage much reduced, nearly hyaline, consisting of three superposed cells; the basal (stalk-cell) squarish or rounded, the lower half or less of its inner mar-



gin connected with the subbasal cell of the receptacle, its subbasal cell smaller, bearing usually a single short antheridial branchlet; the upper cell still smaller, often hardly distinguishable, bearing one or two short antheridial branchlets and a short sterile terminal branch. Antheridia terminal, one to three in a series. Stalk-cell of the perithecium relatively very large, often curved, usually as large as all the other parts of the plant combined, brown, slightly constricted at its insertion, nearly cylindrical, slightly and gradually broader toward and below the basal cells, which are relatively small and barely separate the cavity of the perithecium from that of the stalk-cell; body of the perithecium concolorous with the stalk-cell, slightly inflated, tapering distally almost symmetrically to the blunt tip, which is somewhat asymmetrical from the slightly greater prominence of one of the lip-cells; the series of wall-cells strongly spiral, completing as a rule somewhat more than one whole turn. Spores  $30 \times 3 \mu$ . Perithecia  $65 \times 20 \mu$ , the stalk-cell  $90-110 \times 12 \mu$ . Receptacle  $25 \mu$ . Appendage  $30-40 \mu$ . Total length to tip of perithecium, average  $200 \mu$ .

On *Stilicis angularis* Lec., at the base of the head on the upper side; Arlington, Mass., June.

This species was found in the same locality and on the same hosts that yielded *C. Stilici*, and *Stichomyces Stilicolus*, and is remarkable for the great reduction of its receptacle and appendage, the hypertrophy of its perithecial stalk-cell, and the close spiral twist of its perithecial wall-cells, which is more marked here than in any other species of the family. The species is most nearly allied to *C. Stilici*, but seems constantly different in the characters above noted.

#### EUCORETHROMYCES Thaxter.

Proc. Am. Acad. Arts and Sci., Vol. XXXV, p. 433. April, 1900.

Receptacle consisting of two superposed cells, the upper giving rise to the stalked perithecium and the appendage. Appendage consisting of two superposed cells, the distal one bearing terminally a series of branches which produce directly free, flask-shaped, sessile antheridial cells borne laterally, singly or in groups.

The type of this genus resembles *Rhadinomyces* very closely in general appearance, but differs in the origin and arrangement of its antheridia which are never intercalary, arising, as is indicated in fig. 6, Plate LI, quite independently of one another.

#### EUCORETHROMYCES APOTOMI Thaxter. Plate LI, figs. 4-6.

Proc. Am. Acad. Arts and Sci., Vol. XXXV, p. 433. April, 1900.

Hyaline becoming tinged, especially the perithecium, with pale amber-brown. Receptacle short, the subbasal cell usually smaller, its axis coincident with that of the stalk-cell. Perithecium rather slender, inflated toward the base, the distal half slender tapering slightly to the blunt unmodified apex, the basal cells rather small, nearly equal, the stalk-cell stout and well developed. Appendage divergent almost at right angles to the axis of the receptacle, its basal cell usually more than twice as large as the subbasal cell, which bears distally and anteroposteriorly a single, or partly double, row of from four to six branches, some of them often elongate, slender straight or curved, suffused with dark blackish brown, hyaline along the inner margin at least toward the base, obliquely septate, the septa dark; the antheridia, stout, flask shaped, subtended by a dark septum, borne singly and laterally, or several together, on short branchlets near the base of the branches. Spores  $26 \times 2 \mu$ . Perithecia  $100-125 \times 25-28 \mu$ ,  $35-38 \times 14-18 \mu$ . Receptacle  $40 \times 18 \mu$ . Appendage without branches  $50 \times 16 \mu$ . Total length to tip of perithecium  $190-207 \mu$ . The Celebes material somewhat smaller.

On elytra of *Apotomus xanthotelus* Bates, British Museum, No. 578, Celebes; on *A. rufus* Rossi, British Museum, No. 577, Europe.

Although the East Indian material of this pretty species is somewhat immature, it appears to differ in no essential respect from the European specimens. The appendage represented in fig. 6 is drawn from the Celebes material, while figs. 4 and 5 are from *A. rufus* and are taken as the type forms. The host is a minute carabid beetle of singular appearance.



## STICHOMYCES Thaxter.

Proc. Am. Acad. Arts and Sci., Vol. XXXVII, p. 37. June, 1901.

Receptacle consisting of two cells, the upper bearing one or more perithecia laterally, and an antheridial appendage terminally. The appendage consisting of several superposed cells, the lowest normally sterile, those above it bearing opposite lateral branches distally, the series ending in a terminal sterile branch. Antheridia simple flask-shaped, free, borne in small groups on short branchlets.

The two species included under this name are so unlike, that the inclusion of *S. Stilicolus* must be regarded as only provisional. It is therefore somewhat difficult to define the limits of the genus with great exactness. In *S. Conosomæ* the perithecia are often several in number, budding from the subbasal cell of the receptacle or from the usually sterile cell above it, which normally forms the base of the appendage. The main axis thus becomes a series of superposed cells which, except the basal ones, separate by an oblique septum distally, on one or both sides, perithecia, in the case of the two lower cells, and antheridial branches in the others; the series ending in a long terminal "appendage." An examination of more species is needed to indicate the limitations of the genus and its immediate relationships. Among the other genera it approaches *Rhizomyces* in the character of its appendage, but the resemblance is otherwise slight.

## STICHOMYCES CONOSOMÆ Thaxter. Plate LI, Figs. 7-10.

Proc. Am. Acad. Arts and Sci., Vol. XXXVII, p. 38. June, 1901.

Dull amber-brown. Receptacle and appendage undifferentiated, the basal cell of the former small, triangular in outline; the subbasal cell about as broad as long, and similar to the cells of the appendage, bearing distally and laterally a single perithecium, sometimes two, which are then paired on opposite sides of the cell, like the antheridial branchlets. Appendage consisting of five superposed subequal cells slightly longer than broad, the basal one sterile, or not infrequently producing one or two perithecia as in the subbasal cell below it: the three cells above slightly larger, the upper angles separated by oblique septa to form small cells on either side, which bear short one- or few-celled antheridial branchlets; the terminal cell somewhat smaller, bearing a simple terminal several-celled branch in addition to the lateral branchlets, all of which usually appear to be sterile. Antheridia with broad necks grouped in twos or threes. Perithecium darker brown, more or less symmetrically inflated; the tip hardly modified; the basal cells collectively broader and nearly as long as the stalk-cell. Spores  $35 \times 2.5 \mu$ . Perithecia  $85 \times 25 \mu$ , the stalk-cell  $36 \times 14 \mu$ . Total length to tip of the appendage proper  $150 \mu$ , the terminal branch  $150 \mu$ , the antheridial branchlets about  $20 \mu$ . Total length to tip of perithecium  $185-200 \mu$ .

On *Conosoma pubescens* Payk. Belmont and Waverley, Mass. First observed by Mr. Bullard. Kittery Point, Maine.

This species is not uncommon on its active host, sometimes in company with *Smeringomyces*; but is usually found in rather poor condition; the terminal portion becoming easily broken, or injured, so that an abnormal production of branchlets takes place. It occurs on all parts of the host, but especially on the elytra.

## STICHOMYCES STILICOLUS Thaxter. Plate LI, figs. 11-14.

Proc. Am. Acad. Arts and Sci., Vol. XXXVII, p. 24. June, 1902.

Hyaline, becoming tinged with yellowish, the perithecia becoming pale amber-brown. Subbasal cell of the receptacle about twice as long as the basal cell; the stalk-cell of the perithecium and that of the appendage symmetrically divergent, or the former lateral in position. The appendage consisting of a free, relatively long, distally somewhat enlarged basal cell, and two to four much smaller distal cells; the lower of which give rise from their upper angles to short branches bearing free antheridia, usually in pairs; the distal cells producing sterile branches which are more or less elongate, hyaline, and sparingly branched. Stalk-cell of the perithecium very large and stout, inflated or distally enlarged below the rather inconspicuous basal cells; body of the perithecium relatively small, becoming amber-brown, curved



strongly inward, tapering slightly to the blunt unmodified tip. Spores  $35 \times 3 \mu$ . Perithecia  $60-90 \times 18-28 \mu$ , the stalk  $90-100 \times 20 \mu$ . Receptacle  $30-40 \times 18 \mu$ . Appendages  $150-200 \mu$ .

On the thorax, prothorax and adjacent legs of *Stilicium angularis* Lec., on the right side; Arlington, Mass., June.

Although very different from the type of *Stichomyces* this species seems provisionally referable to no other genus. It has been found only once in company with *Corethromyces* near the pond in the Arlington Park, where its host occurred in great abundance concealed in piles of dry melon stems. It may be mentioned that what appears to be the same species as well as certain others nearly allied, were found by me on species of *Stilicium* near Buenos Aires; but these forms have not as yet been carefully examined. In habit it resembles *Rhadinomyces*, but differs in having free antheridia. As above mentioned the generic reference must be regarded as merely provisional.

#### RHIZOMYCES Thaxter.

The two additional species of this genus herewith illustrated indicate that, although its appendage-characters are well defined, the presence of a penetrating rhizoid, which occurs in the type and suggested the generic name, is not of generic value; since in *R. ctenophorus* the plant is attached by the usual foot. The same condition is seen in *Dimeromyces* and in *Ceraomyces*, which further illustrate the unimportant nature of the rhizoidal character. The species thus far observed all occur on the very peculiar flies belonging to the Diopsidæ, all of which are characterized by the possession of stalked eyes. It is uncertain, however, whether all the infested specimens belong to the genus *Diopsis*, since these insects are largely undetermined in the collections examined.

#### RHIZOMYCES CTENOPHORUS Thaxter.

Further material of this species was found in the Berlin Museum on African species of *Diopsis*; No. 852 from Usambara; No. 861 from Zanzibar, and No. 853 from Wangunga. Although the species varies considerably in the length of its perithecial stalk-cell, and in the development of its appendage which may be much shorter than in the specimen illustrated in my figure, the characters seem otherwise quite constant.

#### RHIZOMYCES GIBBOSUS Thaxter. Plate LII, figs. 22-23.

Proc. Am. Acad. Arts and Sci., Vol. XXXVI, p. 409. March, 1901.

General habit more or less sigmoid. Perithecium amber-brown, concolorous, with its relatively large basal cells, from which it is hardly distinguished, asymmetrically inflated, bent, and tapering somewhat distally; a subterminal abruptly rounded enlargement, beyond which the short asymmetrical tip is clearly distinguished, bearing a large two-celled outgrowth posteriorly, the lip-cells being otherwise unmodified: stalk-cell hyaline, variably, sometimes greatly elongated, separated from the basal cells by a more or less distinct constriction. Appendage nearly hyaline, except the small deep brown sterile basal cell, the remaining cells, three to seven in number, bearing short one- to two-celled branches distally and laterally on which the free flask-shaped antheridia are borne singly or several together. Receptacle short and stout, the upper cell several times as large as the basal cell, which appears to penetrate the host directly by means of a rhizoidal apparatus. Spores about  $35 \times 3 \mu$ . Perithecium, including basal cells,  $85-108 \times 30-36 \mu$ ; the stalk  $60-160 \times 18-20 \mu$ . Appendage  $65-110 \mu$ . Total length to tip of perithecium  $180-325 \mu$ .

On the upper surface near the tip of the abdomen of a species of *Diopsis*. Berlin Museum, No. 850. Tanga, Africa.

This species is well distinguished from the allied *R. ctenophorus* by the peculiar conformation of its perithecium, and by its comparatively simple appendage. That it possesses penetrating rhizoids is evident from an examination of the types, but in all cases they were broken in removal.



RHIZOMYCES CRISPATUS Thaxter. Plate LII, figs. 19-21.

Proc. Am. Acad. Arts and Sci., Vol. XXXV, p. 434. April, 1900.

Perithecia brownish, dimorphous either (a) with the inner margin strongly convex, the outer nearly straight or concave owing to a general outward curvature, tapering to the undifferentiated tip, the apex broad truncate usually symmetrically bisulcate or (b), the type, straight symmetrical abruptly enlarged below the narrow abruptly distinguished tip: the basal cells well defined nearly isodiametric, the stalk-cell large, as long or longer than the perithecium. Receptacle two-celled, the foot typically modified and blackened, without rhizoids, distally geniculate through a protrusion of the distal cell below the insertion of the stalk-cell and opposite that of the appendage. Appendage erect, sometimes exceeding the tip of the perithecium, consisting of a single series of superposed cells, the three or four lower suffused with smoky brown, the rest subhyaline, each cell except the basal one giving rise directly and externally to a branch, the insertion in successive cells being somewhat to the right and left of the median line so as to form two vertical rows, the basal cells of alternate branches being superposed; each branch consisting of a basal cell externally blackened, which gives rise above to a one-celled short branchlet, bearing usually a pair of long, slender antheridia, the remainder of the branch curved upward blackish brown except its upper margin, and giving rise from its lower (external) side to a series of close-set simple branchlets, black, recurved, more abruptly at the tips which are slightly enlarged and nearly hyaline, the whole suggesting the margin of a curled black feather. Spores  $20 \times 2.8 \mu$ . Perithecia  $65-75 \times 27-30 \mu$ , the stalk-cell  $50-85 \mu$ . Receptacle  $30 \mu$ . Appendages  $140-175 \mu$ .

On *Diopsis* sp., Brit. Mus., No. 739, Natal: Berlin Museum No. 850, Tanga; No. 859, Johan Albrechtshohl, N. Kamerun; No. 851, Usambara; No. 858, Bismarkberg, Togo. All African.

This species is one of the most striking members of the family from the peculiar ostrich-plume habit of its appendages. There appear to be two distinct types of form in the perithecia even among individuals occurring together on the same specimen of the host-insect, as is indicated in the accompanying plate. In the straight form the enlargement below the tip is more or less striking, and specimens occur in which, as in fig. 20, the enlargement is double. These differences were at first thought to be due to differences in the point of view, but an examination of sufficient material would seem to show that such is not the case. Although it is barely possible that these forms may be distinct, there appear to be no other differences. The penetrating rhizoid which characterizes the other species is absent in the present instance, and is replaced by the normal foot.

#### SPHALEROMYCES Thaxter.

This genus proves to be well represented on hosts belonging to the Staphylinidæ and though of a single type, the species are often well distinguished, especially by their perithecial characters. In a few cases it has been difficult to determine whether forms should be referred here or to *Corethromyces*, the general characters being superficially similar in the two genera. The seriate antheridia of *Corethromyces* serve to distinguish it at once, when the material is sufficiently good to show these structures, although even in this respect, simple species of the last mentioned genus, like *C. Stilici* in which the antheridia may be even solitary or serially grouped in small numbers, are not always easily placed. Owing to the fact that the appendages are easily broken, the presence of antheridia has been actually observed in but few instances, and the general structure has of necessity been used in referring many of the species to this genus.

#### SPHALEROMYCES LATHROBII Thaxter.

Specimens corresponding in all respects to the type of this species were found in the Hope Collection on a specimen of *Lathrobium quadratum* Puyk., labeled "Puyk Gyll." Whether this is a locality, and if so where it is, I am unable to say. The host is a European species.



## SPHALEROMYCES INDICUS Thaxter. Plate LII, figs. 17-18.

Proc. Am. Acad. Arts and Sci., Vol. XXXVII, p. 41. June, 1901.

Perithecium relatively very long and large, yellowish, very slightly inflated toward the base, tapering very gradually to the broad, blunt tip which is subtended by a truncate, conical lateral projection; the stalk-cell relatively short. Receptacle relatively small, the two cells nearly equal, the upper bearing the stalk-cell of the perithecium terminally and the basal cell of the appendage laterally; the latter overlapping it to its base. Appendage consisting of four superposed cells, the basal (stalk-cell) small, triangular; the two cells above it larger and longer, bearing short antheridial branches from the upper inner angles; the terminal cell smaller, subconical, bearing a small terminal branchlet. Spores about  $44 \times 4 \mu$ . Perithecium  $290-340 \times 45 \mu$ , the stalk-cell  $72 \mu$ . Receptacle  $55 \mu$ . The appendage  $125 \mu$ .

On the upper surface of the tip of the abdomen of *Pinophilus* (near "*P. rufipennis*"). Malabar, India. Sharp Collection, No. 1151. British Museum, Burmah India, No. 390.

A species most nearly related to *S. occidentalis*, which occurs on *Pinophilus* in Utah but is small and differently shaped, and lacks the characteristic subterminal projection of the perithecium peculiar to the present species. The material is, for the most part, in bad condition, the branchlets of the antheridial appendages being mostly broken, but its essential characters are shown with sufficient clearness.

## SPHALEROMYCES ATROPURPUREUS Thaxter. Plate LII, figs. 6-7.

Proc. Am. Acad. Arts and Sci., Vol. XXXV, p. 441. April, 1900.

Perithecium large, purplish, more or less distinctly curved away from the appendages, tapering below, often broader distally above the middle, tapering thence slightly to the tip, which is usually not distinctly differentiated; the apex small truncate or slightly papillate; the basal cells large, as long as or longer than the stalk-cell, dull amber-brown. Basal cell of receptacle large, not greatly elongated, tapering below, the nearly hyaline distal portion, obliquely distinguished from the deeply suffused, partly opaque portion of the cell below; the subbasal cell subtriangular. Appendage consisting of about five cells decreasing in size from below upward, the septa nearly horizontal; those above the basal cell giving rise to a branch on the inner side, which in the subbasal cell and the cell above it consist of a very large broad basal cell, from which arise from two to four subhyaline branches which may be once branched, the branches crossing the stalk and basal cells of the perithecium obliquely, usually on the left side, so that when the perithecium lies at the left, the appendages lie above them. Spores  $35 \times 3.5 \mu$ . Perithecia  $175-200 \times 30-35 \mu$ , the stalk and basal cells together  $50-70 \times 17-20 \mu$ . Receptacle  $85-100 \times 40 \mu$ . Total length to tip of perithecium  $270-350 \mu$ . Appendage without branches  $50-75 \mu$ .

On abdomen of *Quedius graciliventris* Sharp, British Museum, No. 740 (Biologia Coll.), Volcan de Chiriqui, Panama; on *Q. basiventris* Sharp, No. 741, from same locality.

This species is distinguished from other forms possessing a blackened basal cell, by the small unmodified tip of its relatively very large perithecium. It is perhaps most nearly allied to *S. Brachyderi*, but lacks the perithecial appendage of this species.

## SPHALEROMYCES BRACHYDERI Thaxter. Plate LII, figs. 3-5.

Proc. Am. Acad. Arts and Sci., Vol. XXXV, p. 442. April, 1900.

Perithecium evenly suffused with brown, paler distally, somewhat inflated at the base, tapering slightly toward the tip; an external deep brown almost opaque appendage projects subterminally, exceeding the tip of the perithecium, broad with a nearly median indentation of the inner side, the outer margin slightly, the upper strongly curved outward, terminating in a short blunt point or slightly inflated portion rather abruptly distinguished on its inner side; the tip asymmetrical, one of the outer lip-cells extending above and free from the others, forming a hyaline bluntly pointed termination at the base of which the tips of the other lip-cells form irregular prominences which may be slight, or obsolete; basal cells concolorous, stalk-cell short and similar to the basal cells. Basal cell of the receptacle very large, long, attenuated below and deeply blackened, as in *Camptomyces*, the distal cell subtriangular concolorous with the stalk-



cell. Appendage consisting of four or five rather flattish brown cells, decreasing in size from below upward, their septa directed obliquely outward and downward, each producing a branch from its upper inner angle, which is simple or one or more times branched, the branchlets subhyaline. Spores about  $30 \times 3 \mu$ . Perithecia  $120-140 \times 28-35 \mu$ , its appendage  $35 \times 12 \mu$ . Receptacle  $85-100 \times 30-35 \mu$ . Primary appendage about  $35 \mu$ , with branchlets about  $120 \mu$ . Total length to tip of perithecium  $225-260 \mu$ .

On tip of abdomen of *Brachyderus antennatus* Sharp, in Dr. Sharp's Coll., Ega, Amazon, No. 1155.

This species is similar in general to *S. atropurpureus* which, however, lacks the perithecial appendage. It varies considerably in size, but the characters appear otherwise constant.

SPHALEROMYCES CHIRIQUENSIS Thaxter. Plate LII, figs. 1-2.

Proc. Am. Acad. Arts and Sci., XXXVII, p. 40. June, 1901.

Almost uniformly translucent dirty amber-brown. Perithecium very large and crowded with spores, long, with a very slight general inflation, the base narrower, tapering abruptly at the short tip: one of the lip-cells forming an erect, median, straight, hyaline, cylindrical or slightly inflated, nearly truncate terminal projection, which is subtended by a posterior or partly lateral, somewhat larger, spine-like, slightly divergent, deep black brown, nearly straight or slightly outcurved pointed outgrowth, its tip nearly on a level with that of the median projection: the basal cells collectively slightly larger than the short stalk-cell, and not distinguished from the base of the perithecium. Basal cell of the receptacle very large, tapering throughout from the broad distal to the narrow basal end, paler than the small, flattened, deeper brown subbasal cell. The appendage consisting of a relatively large basal stalk-cell, which is slightly longer than broad, and partly united to the stalk-cell of the perithecium; above are four short successively smaller cells, their septa slightly oblique, the three lower bearing branches as usual, which may branch once above their basal cells, the branchlets brown, erect, rigid, closely aggregated; the uppermost cell paler, with a terminal branch. Spores  $50 \times 2 \mu$ . Perithecia  $220-250 \times 40-48 \mu$ , to tip of median projection, the subterminal process  $25 \times 7 \mu$ ; the stalk-cell  $35 \times 25 \mu$ . Receptacle  $240 \times 40 \mu$ , the basal cell  $220 \mu$ . Total length to tip of perithecium  $500-600 \mu$ . Appendage without branches, including stalk-cell,  $75 \mu$ .

On the tip of the abdomen of *Quedius flavicaudus* Sharp, Volcan de Chiriqui, Panama. Sharp Collection, No. 1157.

This large and fine species is allied to *S. Brachyderi*, but is abundantly distinct as a comparison of the figures will show, and in the type material shows no variation except in size.

SPHALEROMYCES QUEDIONUCHI Thaxter. Plate LII, figs. 8-9.

Proc. Am. Acad. Arts and Sci., Vol. XXXVII, p. 39. June, 1901.

Perithecium relatively small, translucent, tinged with amber-brown, straight, very slightly almost symmetrically inflated; the tip hardly distinguished; one of the lip-cells forming a blunt, terminal, irregularly curved, hyaline, sometimes abruptly distinguished projection, below the base of which arises on the inner side a tongue-like outgrowth externally and basally blackish brown, the broad rounded hyaline end of which is curved against or across the base of the terminal outgrowth; the stalk-cell small, the basal cells collectively larger, and separated from it by a very oblique septum. Basal cell of the receptacle long, black, obconical, the narrow base translucent; the subbasal cell small, nearly triangular. Appendage consisting of five very obliquely superposed cells, the two lower nearly equal, the cells above successively smaller, but equal in length; the branches which are once or twice branched and extend about to the middle of the perithecium, arising from the whole surface of their inner margins, the terminal cell soon destroyed. Spores  $55 \times 3 \mu$ . Perithecia  $135 \times 36 \mu$ . Basal cell of receptacle  $120 \mu$ . Appendage without branches  $55 \mu$ . Total length to tip of perithecium  $290-310 \mu$ .

On the abdomen of *Quedionuchus impunctus* Sharp. San Andres, Vera Cruz. Sharp Collection, No. 1105.

A species distinguished by its small blunt perithecium, and almost wholly opaque basal cell, but nearly allied to the three preceding species.



**Sphaleromyces Latonæ** nov. nom. Plate L, figs. 1-3.

*Corethromyces Latonæ* Thaxter. Proc. Am. Acad. Arts and Sci., Vol. XXXVII, p. 41. June, 1901.

Perithecium reddish brown with a purplish tinge, often straight, or externally concave, slightly inflated; the lip-cells forming a small short, slightly bent, nearly cylindrical, truncate, or papillate terminal projection, which is rather abruptly distinguished; the secondary stalk-cell, and the basal cell above it, bulging outward more or less prominently, and separated by a rather conspicuous irregular indentation: the stalk-cell small and squarish. The basal cell of the receptacle asymmetrical; its anterior margin straight and perpendicular, the posterior slightly curved and oblique; its distal margin oblique with a posterior protrusion; its slender base translucent, but otherwise opaque, the opacity involving a portion of the small flattened subtriangular subbasal cell. The appendage consisting of a series of about five successively smaller hyaline cells, the lowest greatly flattened; the series above, the distal cells of which soon disappear, often turned outward so as to become almost horizontal in position, giving rise from their inner sides to numerous hyaline branches, which may be more or less copiously branched. Spores about  $35 \times 2 \mu$ . Perithecium  $90-105 \times 20-25 \mu$ , the stalk and basal cells together  $20-25 \mu$ . Receptacle  $110 \times 50$  (distal end)  $\times 10 \mu$  (base). Total length to tip of perithecium  $225-250 \mu$ .

On the legs and abdomen of *Latona Spinolæ* Guér. Bogota, Columbia. Berlin Museum, No. 834.

Although I have been unable to determine with absolute certainty, young specimens of this species appear to produce solitary antheridia on the branchlets, and I have therefore included the species in *Sphaleromyces* to which in other respects it corresponds exactly; although somewhat peculiar from its condensed primary appendage and large opaque distally prominent basal cell. The types were found in company with *Laboulbenia Latonæ* on various parts of the host.

**SPHALEROMYCES OBTUSUS** Thaxter. Plate LII, figs. 11-13.

Proc. Am. Acad. Arts. and Sci., Vol. XXXV, p. 440. April, 1900.

Perithecia relatively large, clear dark brown becoming almost opaque; the inner margin nearly straight, the outer strongly convex; tapering very slightly basally and distally; the tip paler brown, abruptly distinguished, and when viewed sidewise flaring, with straight divergent lateral margins, the distal margin as broad as the portion of the perithecium below the tip, and slightly concave, the outer lips more prominent and much broader than the inner: when viewed at right angles to this position the tip appears in general bluntly rounded, not expanded, the more or less papillate tips of the lip-cells situated in asymmetrical pairs, which are visible above and below a broad bluntly rounded median portion between them: the basal cells colored like the perithecium, distinct, hardly broader than the stalk-cell which is hyaline contrasting thick-walled and about twice as long as broad. Receptacle small, suffused with brown, two celled; the septa somewhat oblique, the upper cell contrasting abruptly with the colorless stalk-cell, and giving rise laterally to the slightly divergent appendage, which consists of from five to six nearly opaque brown cells, separated by oblique septa; each producing distally on the inner side a short hyaline branch, sometimes once branched. Spores about  $40 \times 3.5 \mu$ . Perithecia  $140-150 \times 40-45 \mu$ , the stalk-cell  $35 \times 20 \mu$ . Receptacle not including foot  $27-35 \times 10 \mu$ . Appendage, mostly broken  $70-100 \mu$ . Total length to tip of perithecium  $230-245 \mu$ .

On *Lathrobium Illyricum* Dej., British Museum, No. 384. Algeria (?). On superior surface of abdomen.

**SPHALEROMYCES PROPINQUUS** Thaxter. Plate LII, figs. 14-16.

Proc. Am. Acad. Arts and Sci., Vol. XXXV, p. 441. April, 1900.

Like *S. obtusus* in size, form, and color, except that the tip of the perithecium is symmetrical or nearly so, the lips forming a broadly rounded blunt terminal prominence with sometimes a slight median elevation, while at the base the tip is characteristically broadened through the presence of distinct lateral elevations on either side: the stalk-cell rather abruptly swollen below the basal cells of the perithecium.

On *Lathrobium*, sp. indet., British Museum, No. 383. Europe. On superior surface of abdomen.



This species is doubtfully separated from *S. obtusus* on account of the very different conformation of the tip of the perithecium, which, as the material in either case occurred in the same position on the host, can hardly be due to position of growth. Their retention as distinct species is, however, only provisional.

CERAIOMYCES Thaxter.

Proc. Am. Acad. Arts and Sci., Vol. XXXVI, p. 410. March, 1901.

Structure of the perithecium as in *Laboulbenia*, its stalk-cell united to the free base of the free stalk-cell of the appendage, which bears a well differentiated insertion-cell terminally, from the end of which are borne antheridial branches, their successive cells producing terminally either successive secondary branchlets, or antheridia or both. Receptacle two-celled.

This genus is in some respects very similar to *Laboulbenia*, with species of which it might be confused on superficial examination. It differs in possessing an appendage, the stalk-cell of which is free from the stalk-cell of the perithecium. The main appendage, moreover, consists of but two superposed cells terminated by an insertion-cell which does not necessarily give rise to outer and inner branches. As in species of *Dimeromyces* and *Rhizomyces*, the two forms herewith illustrated differ in their relation to the host; *C. Dahlii*, which grows on a soft-bodied fly, being characterized by a copiously branched rhizoid that enters the body cavity, whereas *G. Selenæ* is attached by the usual blackened foot.

CERAIOMYCES DAHLII Thaxter. Plate XLIII, figs. 3-6.

Proc. Am. Acad. Arts and Sci., Vol. XXXVI, p. 410. March, 1901.

Perithecium large, blackish brown, with an olive shade, becoming opaque, usually slightly curved, tapering gradually to the slender undifferentiated tip; the anterior lip-cells forming two appressed hyaline-tipped finger-like projections; the base very broad, translucent, dull brownish, bulging conspicuously below the venter, especially on the left side; the stalk-cell small, nearly isodiametric, united on its inner side to the base of the stalk-cell of the appendage. The latter free, though often in contact with the base of the perithecium, dull blackish olive, outwardly inflated, narrower terminally where it bears the characteristically differentiated basal cell of the appendage, which becomes almost opaque and is somewhat flask- or bottle-shaped with a rounded extremity, from which, typically, two divergent branches arise which in turn may branch one to three times subdichotomously; the long slender flask-shaped antheridia borne, one to two together, distally from the successive cells. The basal cell of the receptacle nearly spherical, penetrating the host by a long filament which is slender except for an enlargement immediately below the integument of the host, simple at first but becoming more or less copiously branched; the upper cell very large and elongate. Spores about  $30 \times 3 \mu$ . Perithecium  $275-310 \times 55-60 \mu$ ; the base, including the stalk-cell,  $68-72 \times 58-68 \mu$ . Appendage  $75-85 \mu$  (the basal cell  $18 \times 12 \mu$ ), the stalk-cell  $40-45 \times 18-22 \mu$ . Receptacle  $175-240 \times 35 \mu$  (the basal cell  $20-22 \mu$ ). Total length to tip of perithecium  $400-675 \mu$ , average  $550 \mu$ .

On various parts of a small flower fly. Ralum, New Pomerania. Berlin Museum, Nos. 1283 and 1298.

This species is conspicuous from its large size and dark color, and growing, as it often does, projecting forward from the head of its host, was at first mistaken for an antenna. The many peculiarities of this fine species need hardly be pointed out, and are clearly indicated by the accompanying figures. In all the specimens the black insertion-cell gives rise to two antheridial branches. The species has been named after Dr. Dahl of the Berlin Museum, from whose collections of Papuan Diptera so many interesting Laboulbeniales were obtained.

CERAIOMYCES SELINÆ Thaxter. Plate XLIII, figs. 7-8.

Proc. Am. Acad. Arts and Sci., Vol. XXXVIII, p. 26. June, 1902.

Receptacle pale dirty brownish, becoming gradually somewhat broader distally, the foot blackish brown, not clearly distinguished, the subbasal cell longer than the basal. Stalk-cell of the perithecium



slightly longer than broad, the basal cells forming a hyaline neck bent above the stalk-cell and not distinguished, except in color, from the body of the perithecium, which is nearly straight, symmetrical, dull purplish brown, tapering gradually to the slightly asymmetrical apex; the tip hardly distinguished by a slight external elevation. Stalk-cell of the appendage more or less strongly curved, or recurved so that the appendage bends downward; the insertion-cell slightly broader than long, blackish purple below, separated by a slightly oblique septum from the much larger cell above it, from which four or five branches arise distally; the branches simple, or sparingly branched, hyaline or reddish brown, sterile or bearing antheridia. Perithecia  $125-150 \times 30-35 \mu$ , the stalk-cell  $22-25 \mu$ . Receptacle  $200-325 \times 25-30 \mu$ . Appendages  $185-400 \mu$ . Total length to tip of perithecium  $219-490 \mu$ .

On the prothorax of *Selina Westermanni* Mostch., India Orient. (labelled "Tranquil"), Berlin Museum, No. 976.

The only two specimens of this species that were obtained are figured in the accompanying plate. It looks at first sight like a somewhat malformed *Laboulbenia*, but the essential characters correspond exactly with those of the preceding species. The insertion-cell bears but a single appendage, however, and the host is not penetrated by any rhizoid. The host in this case is a carabid beetle and the genus *Selena* is said to be synonymous with *Ega*.

#### LABOULBENIA Robin.

Taken as a whole the characters of this very large and varied genus are remarkably constant as far as the general type of structure and development are concerned, and I have little to add to the account already given in my Monograph. As I have there pointed out the type is peculiar from the fact that the so-called receptacle here, is not homologous with that of its simpler allies, like *Rhadinomyces* for example, but includes in addition to the primary two-celled receptacle of such forms, a cell series of very constant characters which results from the adnation of the basal portion of a primary appendage with the stalk-cell, and usually with some of the basal cells, of the perithecium. This pseudo-receptacle gives rise, then, to a single perithecium on one side and on the other to appendages which are in reality branches from the adnate primary appendage. The arrangement of cells in this combination is, in general, so regular and constant that it has been found possible and convenient to number the successive cells. The basal and subbasal cells, representing the primary receptacle of the simpler forms, are numbered I and II respectively; the primary appendage includes cells III to V, the latter a double cell which, like cell IV, is normally separated from the "appendages" by a blackened insertion-cell. Of the remaining cells, cell VII corresponds to the normal perithecial stalk-cell of many other genera, which in this instance is never free.

The more important variations which are met with among the members of the genus are for the most part associated with secondary divisions of the distal portion of the "primary" appendage, that is to say of cells IV-V and of the insertion-cell. *Laboulbenia olivacea*, for example, is a unique instance in which such a division of cell IV appears to be invariable (Plate LV, fig. 3). In *L. Anaplogeni* also, although the phenomenon is neither regular nor invariable, the same cell may be divided by one or even more septa, becoming thus to some extent proliferous distally and externally. The most complicated instances of this nature are seen in some of the aquatic species like *L. ceratophora*, and such forms might on this account be put in a genus by themselves were it not for the existence of various species showing transitional conditions.

Normally the free appendages consist of an outer and an inner, arising immediately above the insertion-cell from corresponding basal cells; but through the subdivision of these basal cells, as well as of the insertion-cell, the normal arrangement may be wholly confused, as in the instances last mentioned. A further modification which is unusual, is seen in *L. proliferans* and its varieties (Plate LIII) in which certain secondary cells, resulting from the proliferation of cell V, may give rise to a more or less copious



production of secondary appendages. Similar tendencies toward irregular division of the appendages, as well as of cell IV and of the insertion-cell, are also seen in *L. Clivinalis* (Plate LXI) and several allied species, although a perfectly normal type may be associated as in this species, with such abnormalities.

It is evident that this large genus is a modern one, in which species making is in active progress, and it is thus an extremely difficult one to treat from a systematic standpoint; especially in view of the limited material usually available for study, and the poor condition in which such material is found in collections, on dried insects which have in general been previously soaked in alcohol, and it must often be a matter of opinion whether species, or varieties, or regional variations are in question. In endeavoring to put in order the almost endless variations of the simpler, or "*flagellata*" type, I do not feel that I have in all cases been consistent in my view of what constitutes a variety and what a species. For example under *L. Texana* and *L. proliferans* certain apparent variations are distinguished by varietal names, while from *L. orientalis* I have separated as species, *L. japonica*, *L. pusilla* and *L. rhizophora*, although the differences in these cases are no greater, perhaps, than they are in cases where the varietal designation has been applied. I do not feel at all sure that it would not have been better to discard varietal designations entirely, or at least in *L. Texana*, *L. proliferans* and *L. cauliculata*, in recognition of the fact that in these cases species making is in progress, although the forms do not appear to have become so well defined as they are, for example, in a majority of the numerous closely allied species of the remarkable "*Galerita*" group.

Apart from a crowd of forms which it is very difficult to assemble about any very definite type species, there are several subdivisions of the genus which may be distinguished with some definiteness; and among these that which occurs on water beetles belonging to the Gyrinidæ, and which may be grouped about *L. Gyrinidarum* as a type, is perhaps one of the most clearly defined. This group, instead of suggesting primitive conditions, which might be expected to throw light on possible aquatic ancestors of the family as a whole, appears to illustrate, rather, one of its most highly developed types, as is indicated by the greater complexity of the receptacle, appendages and, in many cases, of the perithecium. The more complicated members of this group, however, are directly connected with the terrestrial types through forms like *L. variabilis*; while it contains within itself a certain number of simpler forms like *L. coarctata*, for example, in which the receptacle is absolutely normal. Among these aquatic species, of which there are about twenty, *L. aquatica* alone shows a copious development of typical flask-shaped antheridia, while in the others no bodies have been observed which can certainly be regarded as organs of this nature. It should be mentioned, however, that material of these forms is almost invariably in bad condition, and that I have made no attempt to reexamine fresh material of the common forms on American *Gyrini* in order to determine this point.

A somewhat similar and very curious tendency to secondary division, not only in the distal cells of the receptacle, but in the basal cells of the appendages as well, is also seen in the group of forms referred to above, occurring on *Clivina* and allied carabid genera *Schizogenius*, *Morio*, etc., although in these cases the tendency has not become fixed, as is illustrated in figures 5-6 of Plate LXI.

As might be expected in a genus which includes more than two hundred species, the parasitism of the latter is unusually varied; and although the Carabidæ among the beetles harbor the great majority, forms are known to occur on Staphylinidæ, Gyrinidæ, Cicindelidæ, and several other orders among the Coleoptera; on Diopsidæ among the flies; on Termites among the Neuroptera; on two Gamasid mites, and even on ants. It is rather remarkable that such extreme differences in hosts have, in most instances, induced no considerable departure from the conventional type, even in cases where the character of the host is so unusual as in those of *L. Hageni* and *L. Formicarum* which occur on Neuroptera and Hymenoptera. Whether the forms on Gamasidæ (*L. armillaris* and *L. Napoleonis*) are aberrant, it is hardly possible to determine from the published figures; but these hosts might certainly be expected to harbor very peculiar species.

The distribution of the species corresponds in some instances to that of the genus of host insects, as



in the case of *L. cristata* which occurs in all the continents; although the members of the large genus *Pæderus* which it infests, are very varied and numerous. On the other hand certain forms seem to be decidedly restricted. *L. variabilis*, for example, which occurs on a variety of carabid hosts and even on one genus of tiger-beetles, seems certainly not to occur outside the American continents. *L. Philonthi*, also, which occurs on members of one of the largest and most widely distributed genera of the Staphylinidæ, is only found in North and South America. In the two instances last mentioned, enough exotic material of the hosts has been examined to make it reasonably certain that the species are thus restricted, and this is doubtless true of many other forms in connection with which the data are less complete. Among still more restricted forms the species on Hawaiian Carabidæ may be mentioned, although they are in general not confined to special genera; while numberless forms have as yet been seen only on members of the same host species, or genus, and from single localities.

In attempting to arrange the species serially, and at the same time bring together groups of evidently related forms, a confusion has resulted in the following enumeration, through the unavoidable juxtaposition of unrelated species, and it would have been in some respects less misleading to have adopted an alphabetical arrangement. The different groups of species, where groups can be distinguished, center about the so-called normal, or *flagellata*-type. For example the whole series on American *Galeritæ*, already referred to, which comprises about twenty-five species, has apparently come from some type similar to that of *L. Mexicana*, which is found widely distributed on the same hosts. The same may be true of the group comprising *L. Pachytelis*, *L. Pheropsophi*, *L. Texana* with its varieties, and other related forms; some or all of which may have come from *L. Darwinii*, or a similar type. The series of *L. proliferans* and its varieties, comes also directly from a normal type through the proliferation of cell V; and further abnormal divisions in this region result in the type of *L. variabilis*, which passes directly to the types already referred to as seen in the aquatic parasites of Gyrinidæ, which themselves vary to forms possessing quite normal receptacles.

In my Monograph I called attention to certain abnormalities which were of interest as showing that the sexual characters did not appear to be inherent in any special cells of the receptacle, although the primary branches of the subbasal cell are normally antheridial and procarpic respectively. In this way perithecia may be wholly or in part replaced by antheridial branches, and, especially in African forms of *L. proliferans*, instances occur in which perithecia may arise secondarily from the subbasal cell, or even other cells of the receptacle.

#### LABOULBENIA FASCICULATA Peyritsch.

*L. brachiata* Thaxter, Proc. Am. Acad. Arts and Sci., Vol. XXIV, p. 11.

The figures of this species given by Peyritsch give so incorrect an idea of its characters, that I felt no hesitation in separating the American form. An examination of European material on the same hosts on which it was observed by Peyritsch clearly indicates, however, that the two are identical. Material has been examined, from the Florence Collection on *Platynus dorsalis* Müll., on *Patrobus excavatus* Payk. and on *Chlænium vestitus* Payk., all of which were Italian; in the British Museum on *Patrobus rufipes* Fabr., from Britain, No. 638; on *Brachinus* sp., China (?) No. 535; the last two differing somewhat in color but structurally identical with the North American and European types. Closely allied to *L. proliferans* and resembling especially the varieties *divaricata* and *interposita*, it is always separable from the fact that the insertion-cell is undifferentiated and is not directly related to the basal cell of the inner appendage. Each basal cell of the appendages, moreover, as well as the secondary appendiculate cells which result from the proliferation of cell V, bear in the present species more than a single branch or appendage; while the basal cells of the latter are relatively large and somewhat inflated, and all the lower septa are black and somewhat oblique. The species bears also a certain resemblance to *L. variabilis* to which it may be related.



## LABOULBENIA PROLIFERANS Thaxter.

This species presents a plexus of variations, several of which it has seemed desirable to distinguish by varietal names and some of these like the var. *cineta* or var. *atrata* might be considered by some persons as specifically distinct. But although these seem very constant, for example on a given host from a given locality, there are so many of them and they are otherwise so variable that it has appeared wiser to regard them all as representing a single species which is undoubtedly in a very plastic condition, and from which a number of species are likely eventually to separate themselves. Whether such a separation has not actually begun is perhaps a matter of opinion. If we take the well defined African form Var. *atrata*, it might well be considered specifically distinct from the normal form as it occurs for instance on Asiatic species of *Chlænius*; yet the var. *interposita* on African *Chlæni*, which approaches *atrata* very closely, becomes identical with the Eastern form on *Chlænius* when, as actually occurs in a few individuals, the blackened septa are absent at the bases of its accessory appendages; while var. *divaricata*, again, could hardly be separated from *atrata* if these blackened septa were added.

Among the minor variations which I have seen the following deserve mention. British Museum No. 604 on *Chlænius pallipes* Gebl. from Japan differs in possessing a receptacle the lower part of which is very slender, cell I being nearly isodiametric, slender, usually abruptly curved above its base, with a more or less well marked prominence distally and anteriorly just below cell II.

Berlin Museum No. 918, on *Brachionychus sublævis* Chaud. from Salang I., Siam, though not otherwise peculiar, has an outer appendage similar in type to that of *L. spiralis* or *L. flaccida* (Plate LVIII).

Berlin Museum No. 930, on *Chlænius xanthocerus* Wied., from Bengal, is a small form, the distal portion of the receptacle relatively large and diverging from the relatively small perithecium.

British Museum No. 596 on *Clæniomus gracilicollis* Jnk. from Turkestan, is a pale form peculiar for the characteristic wine-red color of its insertion-cell.

Hope Collection on *Chlænius* sp. No. 320, from Ceylon, has copious accessory branches, which are hardly divergent, and 750  $\mu$  in length.

Minor variations in color, size and form of the receptacle, perithecium and appendages are common, as well as in the degree of proliferation in cell V (which is rarely quite normal), the number of accessory appendiculate cells cut off rarely exceeding five and usually not more than two in number.

In a few individuals of the normal type (Paris 51, on *Chlænius* sp., Algeria, and No. 83 on *Eudema*, Africa, the subbasal cell of the receptacle has organized procarps and perithecia, and in one case two have arisen after a division of this cell. This appears to occur usually when the primary perithecium aborts for any reason, or is destroyed; but in one instance both primary and secondary perithecia appear to be functional.

A complete list of the material examined since the publication of my Monograph, and exclusive of the named varieties, is as follows; — British Museum: No. 588 on *Eudema conica* Murr., Old Calabar, Africa; No. 589 on *E. microcephalus* Dej., Sierra Leone; No. 596 on *Chlæniomus gracilicollis* Jnk., Turkestan, No. 598 on *Chlænius spoliatus* Rossi, Andalusia; No. 601 on *C. marginellus* Dej., Delagoa Bay, Africa; No. 603 on *C. æneipennis*, Port Natal, Africa; No. 604 on *C. pallipes* Gebl., Japan; No. 605 on *C. bimaculatus* Dej., Java; No. 608 on *C. marginatus* Dej., Hong Kong; No. 610 on *Rhembus* sp., W. India. Paris Collection: No. 20 on *Chlænius* sp., Madagascar; No. 51 on *Chlænius* sp., Algeria; No. 83, on *Eudema* sp., Africa; No. 87 on *Chlænius* sp., Java; No. 134 on *Chlænius* sp., Japan; No. 140 on *Chlænius* sp., West Asia. Hope Collection: No. 320 on *Chlænius* sp., Ceylon; No. 335 on *Craspedophorus* sp., West Australia; No. 381 on *Eudema Erichsonii* Hope, Africa. Berlin Museum: No. 918 on *Brachionychus sublævis* Chaud., Salang Island, Siam; No. 923 on *Chlænius biguttatus* Motsch, Japan; No. 929 on *C. Schaumii* West., "Tranquil": No. 928 on *C. Javanus* Chd., Java; No. 924 on *Chlænius* sp., New Guinea; No. 930 on *C. xanthocerus* Dej., Bengal. Sharp Collection; No. 1106 on *Pheropsophus Hispanica* Dej. Spain; also on *Chlænius velutinus* Duft., from Italy? in the Florence collection. The specimen on



*Pheropsophus* from Spain is immature but appears certainly to belong here. I hope to illustrate this species more fully in a future paper.

The varieties of this species which it has been thought desirable to distinguish by special names are as follows:

var. *Liberiana* Thaxter. Cell V constantly once-proliferous, the accessory appendage simple, distinguished by a broad opaque black base. Type on *Eudema* sp., Liberia (Cooke); British Museum No. 591 on *E. arcuatocolle* Murr., Old Calabar: Paris Museum Nos. 84 and 152 on *Eudema* sp., Congo, Africa, in the original figure of this variety (Monograph, Plate III, fig. 7) the septum separating cell III from cell IV, was not inked in before reproduction, so that the figure is incorrect to this extent. The septum is almost exactly horizontal, and the two cells which it separates are about equal in length. The additional material obtained since this variety was described resembles the type in all respects.

var. *CINCTA* Thaxter. Plate LIII, fig. 5.

Proc. Am. Acad. Arts and Sci., Vol. XXXVIII, p. 53. June, 1902.

Perithecium borne on a black base resembling a normal insertion-cell; cell V several times proliferous, each cell bearing a simple accessory appendage distinguished by a broad black basal suffusion. On *Eudema sinuaticolle* Laf., Lagos, Guinea; British Museum, No. 590. On *E. grossum* Hope, Old Calabar, Africa; British Museum, No. 587. On *Episcosomus (Eudema) grossus* Hope, Africa; Paris Museum, No. 81. On *Craspedophorus adæquatus* Kolbe, Bismarkdorf, Togo, Africa; Berlin Museum, No. 919, and Kamerun, Africa; Berlin Museum, No. 912. On *C. Congoanus* Kolbe, Kimpoko, Congo, Africa; Berlin Museum, No. 907. On *C. Preusii* Kolbe; Barumba Station, Kamerun, Africa; Berlin Museum, No. 910. On *C. (Eudema) Strachani* Hope, Togo, Africa; Berlin Museum, No. 913.

This variety is entirely similar to the var. *Liberiana* except that cell V is more than once proliferous, and that the perithecium is seated on a clearly defined black base which is like the normal insertion-cell of this genus. In the latter respect the variety is quite unique, since no other member of the genus shows any such tendency. The black portion appears to result from the modification of two cells (cells g and d, Monograph, Plate II, fig. 17).

var. *ATRATA* Thaxter. Plate LIII, fig. 2.

Proc. Am. Acad. Arts and Sci., Vol. XXXVIII, p. 53. June, 1902.

Cell V twice to five times proliferous, the accessory appendages distinguished by thick black bases and either divaricately once- or twice-branched, or simple. Very variable in size, the type on *Rhopalomelus* (Berlin No. 921) over 1.5 mm. in length, while specimens on *Rhopalomelus* from Port Natal (British Museum, No. 630) are only 450  $\mu$  to tip of perithecium. A fine variety, which, in the absence of intermediate forms, would never be specifically associated with the normal form of *proliferans*. Specimens in which the accessory branches are simple (Berlin 909 and 908, Brit. Mus. 630) resemble var. *cincta* exactly, except that no blackened base is distinguished below the perithecium. On *Chlænius Dohrini* Bert., Tropical E. Africa; Berlin Museum, No. 226. On *Euchlænius trochantericus* Kolbe, Njam Njam, Semnio, Africa; Berlin Museum, No. 921. On *Craspedophorus nucatus* Harold, "Regne Lugna"? Africa; Berlin Museum, No. 908. On *C. Westermanni* Laf., Togo, Africa; Berlin Museum, No. 909. On *Rhopalomelus angusticollis* Boh., Port Natal, Africa; British Museum, No. 630. On *Rhopalomelus* sp., Africa; Hope Collection, No. 311.

Var. *interposita* nov. var. Plate LIII, figs. 3-4.

This name may be used to designate a form on African species of *Chlænius* which resembles var. *atrata* from the fact that one or all of its accessory appendages may be distinguished at the base by blackened septa, although specimens occur in which no such blackening is present. It resembles the Asiatic forms of the species on the same host in general form, and in the Type (British Museum No. 599 on *Chlænius* sp., Angola), has the same pale straw yellow coloring often seen in material from this region.



Specimens from Delagoa Bay, however, (Brit. Museum, No. 600) and from Sierra Leone (B. M. No. 602 on *C. venator*) are suffused with dark brown in most cases.

Var. DIVARICATA Thaxter. Plate LIII, figs. 6-7.

Proc. Am. Acad. Arts and Sci., Vol. XXXVIII, p. 53. June, 1902.

Cell V once proliferous or sometimes normal without proliferation, the primary appendages copiously several times branched, the branches or branchlets commonly more or less marked by basal blackish suffusions, divaricate, slender, tapering, flexuous. On *Chlænius* sp., Sandakan, Borneo; British Museum, No. 664, Type. On *Chlænius* ? sp., Victoria, Australia; Hope Collection, No. 339. On *Notonomus viridescens* Chaud. (?), New Zealand; Paris Museum, No. 159. On *Bembus gigas* Bates, Japan; Paris Museum, No. 133. On *Rhembus lævis* Lesne, Java; Paris Museum, No. 109.

LABOULBENIA CRASPIDOPHORI Thaxter. Plate LIII, figs. 8-9.

Proc. Am. Acad. Arts and Sci., Vol. XXXVIII, p. 32. June, 1902.

Perithecium relatively large, almost wholly free, erect, usually bent slightly inward toward the base and outward toward the tip, becoming almost opaque dark brown; the tip rather small, hardly distinguished, bent slightly outward; the lip edges pale, outwardly oblique. Receptacle usually rather slender, the basal and subbasal cells relatively large and long, faintly suffused with brown, the upper longer, separated from cell III by a narrow horizontal septum and from cell VI by a very oblique or almost vertical one; the distal portion of the receptacle narrow, but rather abruptly distinguished, especially cells III and IV, more or less deeply suffused, becoming concolorous with the perithecium. Outer appendage long, slender, simple, or rarely distally furcate, curved outward; the basal cell of the inner appendage relatively very small, bearing a single, erect, short, one-celled branch; which, after bearing several antheridia distally, soon disappears. Spores  $75 \times 5 \mu$ . Perithecia  $180-210 \times 48 \mu$ . Receptacle  $150-325 \mu$ . Appendages longer,  $300-375 \mu$ . Total length to tip of perithecium  $280-500 \mu$ .

On *Craspidophorus tenuipunctatus* Laf., East Indies; British Museum, No. 592. On *Panagæus* (*Eudema*) *Symeii* Murr., Old Calabar, Africa; British Museum, No. 594. On *Microsomus* (*Eudema*) *vicinus* Murr., Gaboon, French Congo, Africa; Berlin Museum, No. 920. On *Craspidophorus* (?) sp., U. S. National Museum, Liberia, Africa, No. 8.

This form is allied to *L. proliferans*, and although from a description alone it might be readily confused with other species in which the outer appendage is single and simple, its characters show sufficient individuality to separate it readily from any other species thus far described. It might be regarded as representing the original simple type from which *L. proliferans* and its varieties have come, and it, moreover, occurs on similar hosts. Its individuality is perhaps best illustrated by the outline of its perithecium which resembles that of *L. proliferans*. The tip is not, however, distinguished as in this species, and none of the individuals thus far examined have shown any tendency to proliferation in cell V.

LABOULBENIA EXIGUA Thaxter. Plate LIII, fig. 1.

Proc. Am. Acad. Arts and Sci., Vol. XXXVIII, p. 37. June, 1902.

Perithecium relatively very small, the upper third or less free, reddish brown, deeper than the receptacle, erect, straight, nearly symmetrical; the tip clearly and rather abruptly distinguished; the lip-cells with darker shades, distinctly spreading, especially externally, the edges hyaline, nearly horizontal. Basal and subbasal cells of the receptacle subequal small. The insertion-cell broad, well marked. The basal cells of the appendage clearly distinguished, subequal, about as broad as long; the outer bearing a single, simple erect branch, the basal cell of which is abruptly narrower, squarish, deeper brown, the septa dark, the rest of the branch simple, obscurely septate, distally hyaline, tinged with pale brown below; the inner appendage like the outer, shorter, paler, the brownish short basal portion of the single simple branch smaller and without septa. Spores about  $40 \times 4 \mu$ . Perithecia  $86 \times 26 \mu$ . Receptacle  $220 \mu$ . Appendages  $184-150 \mu$ . Total length to tip of perithecium  $250-290 \mu$ .



On the inferior thorax of *Chlœnius biguttatus* Motsch., Japan; Berlin Museum, No. 923.

Allied to *L. humilis*, but differing in its appendages, and in the conformation of the spreading tip of its perithecium which is itself differently shaped, and differently related to the insertion-cell.

LABOULBENIA HUMILIS Thaxter. Plate LIII, fig. 10.

Proc. Am. Acad. Arts and Sci., Vol. XXXVIII, p. 42. June, 1902.

Rather slender, nearly uniform dirty olivaceous. Perithecia relatively large, straight, erect, the outer margin nearly straight to the lips, or slightly convex; the tip not well distinguished, with darker shades below the rather coarse, pale, outwardly oblique lips. Basal cell of the receptacle relatively large, somewhat paler; the cells above it darker, and transversely, rather coarsely, striate-punctate especially cell II; cell III separated from cell II by a short horizontal septum; cell VI separated from cells II and III by oblique septa; the anterior margin of the receptacle slightly convex, the posterior strongly divergent above cell II. Insertion-cell relatively narrow and thick, the outer appendage short, simple, tapering, four to five-celled, slightly divergent above the basal cell, which is rather long, irregular and paler; the subbasal cell separated by a more or less distinctly oblique septum, where the appendage is slightly geniculate; the inner appendage erect, simple, or the small basal cell producing two pale, short, few-celled, simple branches. Spores about  $50 \times 5 \mu$ . Perithecia  $100-125 \times 30 \mu$ . Receptacle about  $185 \mu$ . Appendages  $60-75 \mu$ . Total length to tip of perithecium  $250-275 \mu$ .

On the elytra of *Chlœnius monogrammus* Laf., Hong Kong; British Museum, No. 606. On *C. cyaniceps* Bates, Hong Kong; Berlin Museum, No. 925.

This species, although insignificant, is well distinguished by its feebly developed appendages, the form of its perithecium and the conspicuous striation of cell II. It seems to be as nearly allied to *L. Craspidophori* and *L. exigua* as to any other species, but could hardly be confused with either. The form on *C. cyaniceps* is taken as the type and illustrated in fig. 10.

LABOULBENIA BRACHIONYCHI Thaxter. Plate LIII, figs. 11-12.

Proc. Am. Acad. Arts and Sci., Vol. XXXV, p. 162. December, 1899.

Perithecium wholly free, rather deeply suffused with smoky or reddish brown, subclavate or almost symmetrically inflated, tapering from the middle to the nearly symmetrical, or externally slightly oblique blunt tip, the basal wall-cells contracted to form a long slender neck-like subhyaline stalk. Receptacle abnormally developed, cells I and II nearly equal, cells III to V forming a stalk which is deeply suffused with blackish brown especially externally, and rather coarsely punctate in the darker areas, of equal diameter throughout and quite free, except at its very base, from the rest of the receptacle: cell IV larger than cell III, cell V small and separated by an oblique septum; cell II often somewhat suffused and distinctly finely punctate; cell I about as long as cell II, and faintly punctate above; cell VII and the basal cells of the perithecium very small. Outer appendage consisting of a basal cell deeply blackened externally, and bearing a long slender simple branch, distally hyaline, more or less suffused with smoky brown toward the base: the inner appendage consisting of a basal cell about half as long as that of the outer producing a single branch on either side which may be once or twice branched, the antheridia borne usually in twos or threes on short branchlets near the base. Spore  $110 \times 7 \mu$ . Perithecia exclusive of stalk,  $270-340 \times 65 \mu$ ; including stalk  $340-430 \mu$ . Total length to tip of perithecium  $650-800 \mu$ ; to insertion-cell  $400-500 \mu$ . Stalk-like portion of receptacle  $138 \times 38 \mu$ . Appendages  $400-470 \mu$ .

On *Brachionychus* sp., Paris Coll. Nos. 99 and 822, Cochin China; on *Episcosoma laticollis*, No. 85, Cochin China; on *Episcosoma* sp., No. 86, Java. Berlin Museum No. 916 on *Microcys robustus* Mor. Japan. Usually on inferior surface of thorax.

This fine species appears to be quite isolated by reason of its peculiarities. Of the other species, *L. anomala* alone possesses a receptacle somewhat similarly developed in relation to the perithecium, but this aquatic form is otherwise totally diverse. The slender neck of the perithecium appears almost to arise from the subbasal cell, cell VI being small and cells II-V forming together a free structure terminated



by the insertion-cell. Apart from slight differences in the depth of the suffusions, the Javan, Chinese and Japanese material shows no variations worthy of note. Fig. 11 represents an individual from Cochin China, Paris Museum, No. 9, which is taken as the Type.

LABOULBENIA NEBRLE Peyr.

Specimens of this species were obtained in the British Museum No. 458 on *Nebria Gyllenhalii* Sch., from Whallen, England: in the Paris Collection on *N. rubicunda* Quens., from Algeria, No. 32. Berlin Museum No. 863, on *N. angustata* Dej., Tyrol, No. 866 on *N. angusticollis* Dej., France.

LABOULBENIA VULGARIS Peyritsch.

The varieties of this species and its near allies on species of *Bembidium* are in need of thorough revision and illustration, which I have deferred until it becomes possible to examine the large amount of material which I have collected in South America and elsewhere, but which is not yet available for study. It may be mentioned here, however, that material from Greece, Italy, the Canaries, India, Japan and the Hawaiian Islands has been obtained from the European Collections.

LABOULBENIA INSULARIS Thaxter. Plate LVI, figs. 1-2.  
Proc. Am. Acad. Arts and Sci., Vol. XXXV, p. 181. Dec., 1899.

Perithecium one third or more free, inflated, dark brown, becoming almost opaque, tapering to the rather pointed apex, the lip-edges hyaline. Receptacle elongate, the distal portion concolorous with the perithecium; cell I suffused with brown above and below, cell II hyaline except for a brown suffusion at its base and distal end. Outer appendage consisting of a large subconical basal cell becoming dark brown and bearing terminally a single short erect slender branch, the two basal cells of which are dark blackish brown, the septa usually oblique; the distal cell somewhat longer than the rest of the appendage, hyaline and soon broken. The inner appendage consisting of a very small basal cell, usually producing a single short hyaline branch about as long as that of the outer appendage. Perithecium  $85-95 \times 40 \mu$ . Total length to tip of perithecium  $215-275 \mu$ ; to insertion-cell  $200-250 \mu$ . Appendages, longest  $100 \mu$ .

On *Bembidium sublimatum* Woll., and *B. Grayanum* Woll., Brit. Mus. No. 409, Island of St. Helena.

This species, though most nearly allied to *L. vulgaris*, differs constantly from forms of that species in the character of its appendages; the outer short, slender, more or less indurated, simple, externally suffused with rich brown, is partly broken in all the adult individuals examined, but is shown from young individuals, fig. 2, to be but slightly longer than is represented in fig. 1.

LABOULBENIA PERPENDICULARIS Thaxter.

A few specimens of a form not separable from this species were found on the legs of *Bembidium atlanticum* Woll. from Teneriffe: British Mus., No. 420.

LABOULBENIA SUBTERRANEA Thaxter.

The different forms which seem referable to this species are very perplexing; especially those from European caves, which are seldom very like the striking American type-form, yet correspond too closely to some of its variations to warrant a specific separation. The European species of *Trechus*, furthermore, are not infrequently parasitized by a form illustrated on Plate LIII, figs. 14-15 which, though strikingly different from the types of this species, are so nearly identical with its varieties that I have not thought it wise to separate them at present. This variety is characterized by the possession of a simple, usually rigid, stiff outer appendage, the lower cells of which are apt to be more or less elongated, and sometimes of variable diameter, or distally somewhat enlarged as in the two figures referred to. The species approaches some forms of *L. polyphaga*, although it is always sufficiently distinct to be readily recognizable. On several European species of the staphylinid genus *Stilicis* I have also found a form that I am not able to separate satisfactorily from the varieties above mentioned, although it is usually somewhat smaller.



The individual represented in fig. 13 was found on *S. geniculatus* Ehr., from England, and was at first given a specific name corresponding to the host; but although an examination of abundant material may show essential and constant differences, I have preferred to place this form also provisionally under the present species.

Of the forms on *Anophthalmus* the following have been examined: British Museum No. 660 on *A. Doriae* Fairm., Liguria; on *A. Schmidtii* Sturm., Carniola. Paris Museum on *A. Caranti* Sell., Alpes Maritimes, Italy; No. 188 on *A. Dalmatinus* Mill., Dalmatia; No. 189 on *A. Schaumii* Schm., Haute Carniola. Berlin Museum No. 875 on *A. Motschulskyi* Schm., Carniola; No. 876 on *A. Dalmatinus* Mill., Dalmatia; On species of *Trechus* as follows: British Museum; No. 639 on *T. micros* Hubst., Hungary, also in Hope Coll., No. 323, Europe. Berlin Museum, No. 880 *Trechus* sp., Macugnaga Italy; No. 881 on *T. lævipennis* Heer., Macugnaga, N. Italy; No. 879 on *T. strigipennis* Kies., Monte Rosa, Italy; on *Trechus* sp. Canada; No. 878 on *T. paludosus* Prussia.

On species of *Stilicis*, British Museum: No. 447 on *S. geniculatus* Ex., Cowley, England; No. 446 on *S. similis* Er., Rathay, England. Berlin Museum; No. 837 on *S. orbiculatus* Payk, Europe.

LABOULBENIA ŒDODACTYLI Thaxter. Plate LIV, fig. 10.

Proc. Am. Acad. Arts and Sci., Vol. XXXV, p. 189. Dec., 1899.

Perithecium free except at the base, pale transparent amber-yellow, somewhat inflated at the base and tapering gradually thence to the slender tip, a blackish shade below the nearly hyaline lips which are turned slightly outward. Receptacle amber-colored, deeper anteriorly, cell II sometimes elongate, cell VI very short, so that the base of the perithecium comes opposite cell III. Insertion-cell and the inner margin of cell V usually free from the perithecium. The outer appendage simple, divergent, the basal cell very large; the basal cell of the inner appendage much smaller, bearing one to two short branchlets. Spores  $35-40 \times 41 \mu$ . Perithecia  $120 \times 35 \mu$ . Total length to tip of perithecium  $175-380 \mu$  (longest); to insertion-cell  $115-275 \mu$ .

On elytra of *Œdodactylus fuscobrunneus*, Fairm., Brit. Mus., No. 397, Chile.

The material of this species is unfortunately very scanty, the typical form being represented in fig. 10, and recalling *L. Atlantica*, although its color, the conformation of the perithecium and of the receptacle, as well as its slender tapering colorless outer appendage, serve to distinguish it.

**Laboulbenia Atlantica** nov. sp. Plate LIII, figs. 16-17.

Perithecium dark olivaceous brown, short, stout, about two thirds free from the receptacle; the free portion subsymmetrical, or curved outward; the tip hardly distinguished, bent slightly outward, with darker subterminal suffusions. Receptacle short and rather stout; cells I and II subequal pale dirty yellowish, the distal half, or less, of the latter united laterally to cell VI; cells III and IV subequal, short and broad, and concolorous with the perithecium. Outer appendage yellowish, simple, elongate, divergent, tapering but slightly, rather closely septate, lower cells slightly constricted at the septa; basal cell of the inner appendage bearing a short one-celled branch on either side, from which arise a few antheridia. Perithecium  $90 \times 70 \mu$ . Receptacle  $110 \mu$ . Greatest total width  $58 \mu$ . Longest appendage  $380 \mu$ .

On elytra of *Lathrobium multipunctatum* Gz., Santa Anna, Madeira; Paris Museum No. 205. On *Gargus Schaumii* Woll., Arribentes, Madeira, Paris Museum No. 212.

Although the hosts of these two forms belong to different families of Coleoptera, I am unable to separate them specifically, the specimens on *Gargus* differing only in the slightly greater relative length of the basal and subbasal cells and in a slight tendency to general curvature in the free portion of the perithecium. The material on *Lathrobium* is taken as the type, one of the individuals from this source being represented in fig. 16, while figure 17 represents an individual from *Gargus*. The species is allied to *L. subterranea* and *L. Œdodactyli*, but seems sufficiently distinct from either.



## LABOULBENIA MADEIRÆ Thaxter. Plate LIV, fig. 7.

Proc. Am. Acad. Arts and Sci., Vol. XXXV, p. 185. Dec., 1899.

Perithecium united to receptacle for about two thirds of its length, pale straw-yellow becoming brownish yellow, the whole tip clear contrasting black or blackish brown, the hyaline lip-edges turned outward. Receptacle concolorous with perithecium, rather short, normal, cell V relatively large, its upper margin free between the perithecium and the insertion-cell, the latter oblique, clear black, contrasting. Outer appendage often simple, elongate, sometimes once branched above its subbasal cell; the branches divergent; inner appendage consisting of a basal cell smaller than that of the outer, and bearing one or two short branches commonly three-celled usually terminated by paired antheridia. Spores  $75 \times 6 \mu$ . Perithecia  $100-130 \times 35-40 \mu$ . Total length to tip of perithecium  $225-250 \mu$ ; to insertion-cell  $175-210 \mu$ . Appendages, longer  $350 \mu$ .

On *Calathus complanatus* Dej., Paris Museum, No. 211, Madeira. On elytra.

Through the enlargement of cell V, the broad insertion-cell in this species is thrown out free from the perithecium, which is relatively small, and united to the receptacle up to a point not far below its broadly blackened blunt apex. A sufficiently characteristic form, but without striking peculiarities.

## LABOULBENIA ERECTA Thaxter. Plate LIV, figs. 20-21.

Proc. Am. Acad. Arts and Sci., Vol. XXXV, p. 175. Dec., 1899.

Perithecium pale yellowish brown, slightly and evenly rounded, united to the receptacle as far as its subterminal cells, the nearly symmetrical tip rather broad, often flattened distally, becoming deeply suffused with blackish, except the narrow translucent margins of the lips. Receptacle pale yellowish, cell I short and stout, distally suffused with blackish brown; cell VI very small, cell V free from the perithecium, sometimes lateral. Insertion-cell thick and black, sometimes carried forward opposite the apex of the perithecium through the elongation of cells IV and V. Outer appendage consisting of a large basal cell several times longer than broad, which may bear terminally one or two branches, the outer sometimes once branched, the branchlets very long, slender, tapering, hyaline or pale yellowish, more or less flexuous. The inner appendage sometimes laterally placed, usually single, simple, consisting of two or three short cells with one or two lateral antheridia and sometimes producing longer branchlets, the basal cell much smaller than that of the outer appendage. Perithecia  $110-120 \times 35-40 \mu$ . Total length to tip of perithecium  $200-275 \mu$ ; to insertion-cell  $200-250 \mu$ . Appendages, longest  $675 \mu$ .

On *Colpodes agilis* Chd., Jalapa, Mexico, Brit. Mus. (Biologia Coll.), No. 696; on *C. evanescens* Bates, U. S. National Museum, Biologia Coll., Mexico. Elytra.

Five specimens of this form in good condition have been examined, three from *C. evanescens* (fig. 20), having somewhat longer appendages, but not differing otherwise from the two on *C. agilis* (fig. 21). The tip of the perithecium appears to be turned in all cases so that the view is anterior, or posterior, instead of lateral. The distal portion of the perithecium also may be so twisted that cell V is hardly visible beside cell IV, a condition similar to that which is the normal one in *L. paupercula*. This species appears to be allied to *L. flagellata* and resembles *L. Madeira* in some respects.

## LABOULBENIA ORTHOMI Thaxter. Plate LIV, fig. 14-15.

Proc. Am. Acad. Arts and Sci., Vol. XXXV, p. 192. Dec., 1899.

Perithecium free, long and straight, slender, sometimes slightly inflated distally, deep clear brown; the tip broad, prominent, not abruptly differentiated; the lips rather large and prominent, the lower wall-cells as a rule elongated to form a hyaline neck, usually well marked and contrasting with the body of the perithecium. Receptacle often shorter than the perithecium, faintly punctate, olive-brown, except the hyaline or slightly yellowish basal cell, or pale dirty brownish yellow, with distal deeper olive suffusions. Insertion-cell not as broad as cell IV. The outer appendage normally simple, the basal cell longer than broad, blackened externally, as are also the two cells which lie above it, the subbasal cell and even the cell above it rarely giving rise to erect simple branchlets. The inner appendage consisting of a



basal cell similar to that of the outer, and producing on either side a straight hyaline erect branch. Spores  $50 \times 4 \mu$ . Perithecia  $130-140 \times 30-35 \mu$  exclusive of the variably developed neck, which may be  $18 \mu$  long. Total length to tip of perithecium  $260 \mu$ ; to insertion-cell  $100 \mu$ ; width  $40 \mu$ . Longer appendages  $200-270 \mu$ .

On margin of elytra of *Orthomus (Argutor) aquilus* Coquer, Algeria, Paris Museum, No. 41.

The typical form of this species, which is represented in fig. 14, is a clearly defined and readily recognizable type; yet among the individuals examined with which this type form was associated, are several variations, notably the elongate form represented in fig. 15, which measures about  $380 \mu$  to the tip of the perithecium, lacks the well defined hyaline neck at the base of the latter, and in which the elongate receptacle is dirty brownish yellow, with olive shades, only, in the distal region. The outer appendages are normally simple, and where branches occur, they appear always to have arisen as the result of injury.

LABOULBENIA DRYPTÆ Thaxter. Plate LIV, fig. 19.

Proc. Am. Acad. Arts and Sci., Vol. XXXVIII, p. 35. June, 1902.

Perithecium usually nearly straight, often nearly symmetrical, the region corresponding to the basal wall-cells usually distinctly differentiated, hyaline or transparent, brownish, becoming darker in older individuals, concolorous with the basal and other cells below; but in general contrasting strongly, but not abruptly, with the rich dark brown of the rest of the perithecium above it, which may become opaque; the tip often bent slightly outward, not abruptly distinguished; the inner lip-cells more prominent and deeply suffused, except the edges. Receptacle rather short, punctate, becoming more or less and rather irregularly stained with brown, often blackish along the posterior margin up to the insertion-cell, which is thick, well defined, contrasting. The appendages rather slender; the outer nearly straight in normal individuals, simple, divergent, rigid, tapering; the basal cell more than twice as broad, subhyaline, with brownish suffusions next its deep black contrasting outer wall, the opacity sometimes involving the subbasal cell, which is similar and similarly blackened externally, as is the cell next above: the inner appendage simple, or more often once branched above the subbasal cell, divergent like the outer, brownish yellow, the antheridia borne singly from the lower cells. Perithecia  $110-150 \times 35-40 \mu$ . Receptacle  $135-180 \mu$ . Longer appendages  $220 \mu$ . Total length to tip of perithecium  $220-250 \mu$ .

On *Drypta ruficollis* Dej., Natal, Africa; British Museum, No. 506.

This species is perhaps as closely allied to *L. Orthomi* as to any other, and is distinguished from the fact that the basal cells of the perithecium form an enlargement below the latter, rather than a more slender neck. The form and relative size of the perithecium are also different.

LABOULBENIA MELANARIA Thaxter. Plate LIV, fig. 18.

Proc. Am. Acad. Arts and Sci., Vol. XXXV, p. 186. Dec., 1899.

Perithecium nearly free, uniformly suffused with clear blackish brown, straight or bent slightly outward; the tip more deeply colored, the lip-edges hyaline, contrasting, externally oblique. Receptacle hyaline becoming yellowish, often suffused with blackish brown except the lower portions of cells I, III, and VI, and usually cell V. Outer appendage consisting of a basal cell mostly free, bearing terminally a single branch typically once branched above its basal cell, the branchlets elongate, thick-walled, rigid, more or less tinged with brown. The inner appendage consisting of a much smaller basal cell, producing either a short two-celled branch with one or two terminal antheridia, or two longer branches which may be once branched; the branches like those of the outer appendage but shorter. Perithecium  $120 \times 35 \mu$ . Total length to tip of perithecium  $275 \mu$ ; to insertion-cell  $150 \mu$ . Appendages, longest,  $550 \mu$ .

On *Diachromus germanus* Linn., Florence Museum, Florence. Hope Coll. No. 344½, 319, France and Portugal; on *Anisodactylus militaris*, No. 315, Sardinia; on *A. heros* Fabr., No. 316, "Europe."

This is a characteristic form, occurring usually on the elytra of its host, distinguished by its long, apparently invariably once-furcate outer appendage, long clear brown blunt tipped perithecium, and hyaline, or but slightly suffused receptacle. The figure, which represents one of the types on *Ophonus*



(*Diachromus*) *germanus*, from Portugal, does not give a correct idea of the rich brown even suffusion of the perithecium.

LABOULBENIA MADAGASCARENSIS Thaxter. Plate LXI, fig. 12.

Proc. Am. Acad. Arts and Sci., Vol. XXXV, p. 184. Dec., 1899.

Perithecium free, mostly straight, the inner margin more convex, uniformly clear dark brown or blackish except just below the black tip, abruptly distinguished from and contrasting with the receptacle; the tip rather abruptly distinguished, straight or bent slightly inward, with hyaline lip-margins, the wall-cells with a slight spiral turn. Receptacle hyaline or finally yellowish, cells III and VI about equal. Insertion-cell opposite base of perithecium. Outer appendage consisting of a rather small basal cell, its outer wall blackened, the blackening continuous with the insertion-cell, usually producing distally two branches, an outer blackened externally or suffused with brown at its base and once branched, and an inner usually simple and hyaline. The inner appendage consists of a basal cell like that of the outer, and produces a single branch on either side which may be once branched, all the branchlets of both appendages rather stout and stiff, tapering, slightly curved outward, hyaline or becoming dirty yellowish. Perithecia  $100-120 \times 40-45 \mu$ . Total length to tip of perithecium  $240-270 \mu$ ; to insertion-cell  $140-155 \mu$ . Appendages, longest  $250 \mu$ .

On margins of both elytra of a carabid allied to *Harpalus*, Paris Museum, No. 3, Madagascar.

When young, this species is almost perfectly hyaline, the perithecium as well as the outer edge of the outer appendage, soon assuming a rich dark brown, abruptly contrasting color. A somewhat similar and larger form has been examined on *H. roninus* Bates from Japan, (Berlin Museum No. 1018), but is in very bad condition. The species is nearly allied to or perhaps identical with certain other forms occurring on species of *Harpalus* which have been examined from America and elsewhere, but which are in need of further study.

LABOULBENIA OPHONI Thaxter. Plate LIV, fig. 11.

Proc. Am. Acad. Arts and Sci., Vol. XXXV, p. 190. Dec., 1899.

Perithecium free except at the base, short and stout, pale straw-yellow or nearly hyaline, variably inflated; the inner margin often strongly convex, the black tip abruptly differentiated on its inner side, black, contrasting, the lip-edges hyaline, turned slightly outward. Receptacle short, stout, normal, concolorous with the perithecium. Insertion-cell black, contrasting. The outer appendage divergent, simple or once to three times branched, the ultimate branchlets distally attenuated; the inner appendage consisting of a basal cell half as large as that of the outer, bearing a short branch on either side which may be several times branched, the antheridia borne in small groups. Spores  $28 \times 3 \mu$ . Perithecia  $70 \times 30-34 \mu$ . Total length to tip of perithecium  $165 \mu$ ; to insertion-cell  $85-100 \mu$ ; width  $40 \mu$ . Appendages, longest  $200 \mu$ .

On elytra, inferior thorax and prothorax, and abdomen of *Ophonus obscurus* Fabr., *O. brevicollis* Dej., *O. azureus* Fabr., *Harpalus neglectus* Dej., *H. serripes* Quensel, *H. sulphuripes* Germ., *H. tardus* Panz., *Dolichos flaviventris* Fabr., in Florence Museum collection of Italian Coleoptera. Paris Museum, on *Ophonus* sp., No. 37, Algeria. Berlin Museum, on *Carterus fulvipes* Sardinia.

It has not seemed possible to include this species under any of the various forms known to occur on *Harpali*, and their allies; but although the varied material is very constant and readily distinguishable, the form is a very commonplace one, without marked distinctions. Always short and stout in form, the insertion-cell, foot and perithecial tip contrasting strongly with the uniform pale transparent yellow color of the plant as a whole, the inner appendages short, hardly ever extending to the tip of the perithecium, the outer divergent with two to three tapering branches.



LABOULBENIA PALLIDA Thaxter. Plate LIV, figs. 8-9.  
Proc. Am. Acad. Arts and Sci., Vol. XXXV, p. 193. Dec., 1899.

Perithecium almost wholly free from the receptacle, colorless becoming faintly yellowish, bent outward at a considerable angle to the axis of the receptacle; the prominent tip abruptly distinguished, coarse lipped, hyaline except for an inner purplish-black suffusion. Receptacle concolorous with the perithecium, the basal cell large and broad, longer than cell II, the cells of the distal portion relatively small, cell III roundish, about as large as cells IV and V together. Insertion-cell thick, contrasting purplish black. Outer appendage consisting of a basal cell, rectangular or distally enlarged and producing usually two, sometimes but one branch, the branches once or even twice branched, the ultimate branchlets sometimes very elongate and attenuated: the inner appendage consisting of a basal cell much smaller than that of the outer and sometimes lateral in position, bearing one or two branches which may be short or elongate like those of the outer appendage. Perithecia  $70 \times 25 \mu$ . Total length to tip of perithecium 110-175  $\mu$ ; to insertion-cell 85-120  $\mu$ . Appendages, longest 285  $\mu$ .

On the elytra of a carabid allied to *Harpalus*, Paris Museum, No. 94, Java.

This small pale species suggests *L. lepida*, but is quite distinct. The broad spreading tip of its perithecium is peculiarly differentiated, and the latter normally projects at an angle to the axis of the receptacle which is coincident with that of the appendages, as in *L. Pseudomasci*, a species otherwise quite different.

LABOULBENIA AEROGENIDII Thaxter. Plate LIV, figs. 4-5.  
Proc. Am. Acad. Arts and Sci., Vol. XXXV, p. 155. Dec., 1899.

Form short and stout. Perithecium suffused with smoky brown, translucent, becoming distally rather abruptly subhyaline, contrasting with the abruptly differentiated tip; the latter black-brown, opaque or nearly so below, the lip-cells usually symmetrical, rounded, spreading broadly and rather abruptly, the lip-edges translucent; sometimes asymmetrical with the inner lip-cells, only, prominent and the pore external: the wall-cells with a slight spiral twist. Receptacle hyaline below, becoming more or less tinged with smoky brown above, especially cells III and IV and the region immediately below the perithecium; the suffused parts indistinctly punctate. Appendages consisting of two basal cells; the inner producing two short branches on either side, which usually bear a rather compact cluster of antheridia; the outer giving rise to from two to four branches placed antero-posteriorly with more or less regularity, the outer for the most part soon broken and deeply blackened, the rest especially the outermost more or less suffused with brown, commonly twice branched, above the basal and subbasal cells, elongate though for the most part broken. Total length to tip of perithecium 200-220  $\mu$ . Appendages 200-250  $\mu$ . Perithecium  $110-120 \times 35-45 \mu$ , the apex reaching a width of 35  $\mu$ .

Along the margins of the elytra of *Arogenidion Bedeli* Tsch., Mon-Pin (China?), Paris, No. 179.

Although closely allied to *L. filifera* and *L. intermedia*, this species is strikingly unlike any other member of the genus by reason of the remarkable conformation of the spreading tip of the perithecium, which is rendered still more prominent by its opacity. The outer branch of the outer appendage is almost invariably destroyed in mature individuals; but its form is shown in the young specimen represented in fig. 5.

LABOULBENIA INTERMEDIA Thaxter. Plate LIV, figs. 2-3.  
Proc. Am. Acad. Arts and Sci., Vol. XXXV, p. 181. Dec., 1899.

Perithecium about three fourths free, suffused with yellowish brown deeper below the apex, rather stout, slightly inflated, the apex very broad, rounded, often almost flat, short, wholly blackened, the lips indistinguishable, the wall-cells with a slight spiral twist. Receptacle short and stout, at first hyaline below, becoming concolorous with the perithecium. Outer appendage consisting of a rather large subisodiametric cell bearing distally two or three antero-posterior branches, once or twice branched, the external branchlets brown, basally deeply blackened. Inner appendage consisting of a basal cell similar



to that of the outer, and producing usually two simple or once branched branches placed antero-posteriorly, the ultimate branchlets in both appendages elongate, tapering slightly distally, hyaline. Perithecia  $95-105 \times 35-40 \mu$ . Total length to tip of perithecium, average  $190 \mu$ ; to insertion-cell  $120 \mu$ . Appendages, longest  $300 \mu$ .

On *Anisodactylus tricuspидatus* A. Mor., Paris Museum, No. 199, Mon-Pin, (China?). Margin of the elytra.

This species is nearly allied to *L. filifera* and *L. Erogenidii*, representing an intermediate type between the two. The appendages are practically identical with those of the latter species, while the perithecium, though peculiar for the irregular bulging of its very blunt tip, is more like the former. The position of growth is the same in all three species and the hosts are nearly allied.

LABOULBENIA OBTUSA Thaxter. Plate LIV, fig. 1.

Proc. Am. Acad. Arts and Sci., Vol. XXXV, p. 189. Dec., 1899.

Perithecium about three fourths free, becoming opaque, black-brown, very stout, the outer margin slightly and more or less symmetrically convex, the inner bulging prominently distally and curved abruptly to the brown blunt rounded hardly differentiated apex, the pore external. Receptacle short, cell VI together with the basal cells of the perithecium concolorous with the latter, becoming indistinguishable; cell VI extending to or towards the base of cell II, which is mostly suffused above, hyaline and contrasting below as is cell I; cells III and IV with median brown shades. Insertion-cell black-brown. Appendages hyaline becoming tinged with brown, the outer basal cell twice as long as the inner, each bearing one to two branches which form a compact group curved toward and against the perithecium. Perithecium  $120 \times 65 \mu$ . Total length to tip of perithecium, average  $260 \mu$ ; to insertion-cell  $175 \mu$ . Appendages, broken,  $35 \mu$ .

On *Aerogenidion Bedeli* Tsch., Paris Museum, No. 198, Mon-Pin, (China?). On left inferior margin of prothorax.

This species is most nearly related to *L. filifera* and *L. intermedia*, but differs from both in the form of its stout opaque perithecium. In perfect specimens the appendages are no doubt longer than they are represented in the figure; but probably do not attain the great length of *filifera*, as may be inferred from the fact that they are strongly curved towards the perithecium.

LABOULBENIA FILIFERA Thaxter.

Specimens apparently identical with the American material have been obtained from the Paris Collection No. 12, on *Harpalus æneus* from Selenga, Siberia; and in the British Museum No. 617 on *Pangus* sp., from Germany. The allied Chinese forms *L. obtusa*, *L. intermedia* and *L. Erogenidii* have been referred to above. All of these forms occur on the margin of the elytron, near the middle and towards the base.

LABOULBENIA CASNONIÆ Thaxter.

This species appears to be separable from forms of *L. polyphaga* with which it might be confused, by its subconical perithecium, simple outer appendage, and more or less copiously branched inner appendage. Although it is not a well characterized species, it seems best to keep it distinct, at least provisionally. The additional material examined is as follows. British Museum, No. 500 on *Ophionea* sp., Adelaide, Australia; No. 499 on *Ophionea cyanocephala* Fabr., Daccu, India; No. 501 on *Casnonia* sp., Ohio. Hope Collection; No. 270 on *Homothes elegans* Newm., "India," No. 276; *Pennsylvanica* Linn., Ohio. No. 277 on *D. imperialis* Mey., no locality; No. 346 (bis) on *Demetrius atricapillus* Linn., Morocco; No. 277 on *D. imperialis* Mey., no locality; No. 346 (bis) on *Dromius longipes* Dej., England. The type form has also been collected again by myself on *Casnonia* at Kittery Point, Maine. It should be noted that the hosts above enumerated are for the most part nearly allied.



## LABOULBENIA POLYPHAGA Thaxter.

This variable form, which in its typical condition, is readily distinguished, often appears to approach so closely to *L. flagellata* and *L. Pterostichi* that, as I have mentioned in connection with these species, I am uncertain whether it should be kept distinct. It is typically small straight and stiff in habit, and rather slender; the outer appendage erect, or slightly divergent, and often quite simple, or usually but once branched near its base; the basal cell of the inner appendage bearing two short branches producing a rather compact group of incurved antheridia, which are not usually associated with any well developed sterile branches. In this respect it is not unlike some forms of *L. Anaplogeni*, although the groups of antheridia are never as dense as in this species, and cell IV of the receptacle never shows the same tendency to proliferation and division. Though normally a short form, a few which seem otherwise indistinguishable, especially from South America, are greatly elongated and very slender, measuring more than 700  $\mu$  in some cases; but such large individuals are, as a rule, readily distinguished from any of the ordinary types of *L. flagellata*. Until I can thoroughly revise and illustrate this type of which a large amount of new material has recently been obtained in South America, the forms below enumerated which have been examined since the publication of my Monograph may be provisionally assigned to this species.

British Museum: No. 614 on *Pelmatellus variipes* Bates, Pinchincha, Ecuador; No. 616 on *Bradycellus puncticollis* Coquer., Algeria; No. 681 on *Nitobia cupreola* Bates, Irazu, Costa Rica; No. 659 on *Loxandrus unistigma* Bates, Paso Antonio, Guatemala; No. 683 on *Pelmatellus nitescens* Bates, Vera Paz, Guatemala; No. 624 on *Argutor vernalis* Fabr., Europe; No. 687 on *Bradycellus circumdatus* Bates, Volcan de Chiriqui, Panama; No. 618 on *Pangus* sp., Venezuela; No. 627 on *Platysma* sp., Lake Huron, North America; No. 723 on *Stenognathus quadricollis* Chaud., Mexico; No. 685 on *Pelmatellus vexator* Bates, Totonicapam, Guatemala; No. 637 on *Tropidopterus Duponcheli* Solier, Chile; No. 623 on *Abacetus quadraticollis* Thom., Old Calabar; No. 724 on *Phlæotheratus quadricollis* Chd., Cordova, Mexico; No. 626 on *Platyderus calarhoides* Dej., Tangier; No. 625 on *Argutor elongatus* Klg., Europe. Paris Museum: No. 197 on *Ærogenidion Bedeli* Tsch., Mon-Pin, China (?); No. 65 on harpaloid, Venezuela; No. 43 on *Bradycellus Lusitanicus* Dej., Lusitania; No. 111 on carabid, Celebes; No. 1a, 1b and No. 2, on Carabidæ indet., Llanos de Venezuela; No. 64 on carabid indet., Venezuela. Hope Collection: No. 325 on carabid indet., Amazon, and No. 341, Brazil. Berlin Museum: No. 1031 on *Antarctia concinna*, Lima, Peru; No. 1169 on *Lecanomerus obesulus*, Greymouth, New Zealand.

## LABOULBENIA PTEROSTICHI Thaxter.

Although the type material of this species, as it occurs for example on *P. adoxus* in New England, is sufficiently well marked and easily distinguishable from the character of its appendages, the examination of varied material, which I have provisionally included under *L. flagellata* and *L. polyphaga*, lead me to believe that the present form might be more properly united with one or both of these species. Yet, as I have remarked elsewhere, if all the forms which approach perhaps too closely to *L. flagellata* were to be united under one "species," such a combination would become far too indefinite and comprehensive, and would lead to still further combinations and an ever increasing specific chaos. The South American forms that I have provisionally included here, show certain variation from the North American type, and of forms from the Eastern Hemisphere I should include, somewhat doubtfully however, material on *P. sodalicus* Heyd. from Turkestan and on *Harpalus* sp. ? from Japan. It is my purpose to give this species a thorough revision in connection with its two nearest allies, as soon as I have an opportunity to study the South American material which I have recently collected. In the interim this species is retained provisionally, and in addition to the North American forms mentioned in my Monograph the following South American ones may be provisionally added. On *Pterolepta* sp., British Museum No. 629; Hope Collection; No. 336 on *Orizabus calipilatus* Columbia; No. 344 on *Pterolepta* sp. Columbia: Paris Collection No. 148 on *Pterolepta (Orizabus)* sp. Columbia: Berlin Museum No. 931 on *Physomerus porosus*, New Grenada.



## LABOULBENIA PSEUDOMASCI Thaxter. Plate LIV, fig. 6.

Proc. Am. Acad. Arts and Sci., Vol. XXXV, p. 196. Dec., 1899.

Perithecia dark rich brown, slightly and rather evenly inflated, relatively large divergent, free from the receptacle except at the very base; the broad opaque tip hardly differentiated, the lip-edges nearly hyaline, not prominent, turned slightly outward. Receptacle colorless or yellowish below, distally brownish, slender, its axis coincident with that of the appendages; cell I usually larger and longer than cell II, the rest of the receptacle relatively unusually small, the inner margin of cell V partly free from the perithecium. Insertion-cell free, black. Outer appendage consisting of a basal cell several times longer than it is broad, which may branch above its basal or subbasal cell one to three times successively, the branchlets divergent; the inner appendage consisting of a much shorter basal cell bearing one or rarely two branches, sometimes simple, mostly one to three times branched, all the branches becoming more or less suffused with brown. Spores about  $65 \times 45 \mu$ . Perithecia  $120-165 \times 60 \mu$ . Total length to tip of perithecium  $225-300 \mu$ ; to insertion-cell  $170-240 \mu$ . Appendages, longest  $100 \mu$ .

On *Pseudomascus nigrita*, Fab., Paris Museum, No. 201, Mongolia. Near upper inferior margin of prothorax on left side.

This species recalls *L. umbonata* in its habit of growth, the axis of the receptacle being coincident with that of the appendages, the perithecium being laterally inserted at an angle of  $45^\circ$  or more, the outer appendage often unbranched, except distally, and the basal cell of the inner appendage giving rise, as a rule, to one branch only. The abrupt enlargement of cell I, immediately below cell II, and the form and contrasting coloration of the perithecium, are also characteristic.

## LABOULBENIA OOPTERI Thaxter. Plate LIV, fig. 12.

Proc. Am. Acad. Arts and Sci., Vol. XXXV, p. 190. Dec., 1899.

Perithecium three fourths or more free, translucent blackish brown, the inner margin evenly curved outward, the outer margin with slight elevations at the septa and curved abruptly inward to form the well differentiated tip which is pale brownish, with dark inferior suffusions. Receptacle concolorous with the perithecium, except that cells I and II are usually hyaline, the suffused portions sparsely, rather coarsely and distinctly punctate. Insertion-cell broad and black. Basal cell of the outer appendage for the most part very long, simple or usually bearing distally an outer and an inner branch sometimes three, the former with blackened basal septum, simple, or once branched, in which case the basal septum of the outer branchlet is also blackened. Inner appendage consisting of a very small basal cell bearing a short branch on either side. Perithecia  $95-110 \times 30-35 \mu$ . Total length to tip of perithecium  $175-275 \mu$ ; to insertion-cell  $85-160 \mu$ . Appendage broken,  $200 \mu$ , probably much longer.

On elytra of *Oopterus rotundicollis* White, Brit. Mus. No. 613; Sharp Coll. No. 1161, on *Cyclothorax insularis*, New Zealand.

This species is distinguished by the enlargement and elongation of the basal cell of the outer appendage which may be much broadened distally, so as to become triangular in outline; and though it more commonly bears two terminal branches, as in fig. 12, and is sometimes not even once proliferous, it may become twice proliferous, so that three closely set branches arise from it in radial succession, each of which may branch above its basal cell. The outer branch is always distinguished by a black septum, and its outer branchlet is similarly distinguished and more or less distinctly edged externally with black. The figure was drawn from the material on *Oopterus*. I shall endeavor in a future publication to illustrate this species more fully from the *Cyclothorax* material which is in good condition and sufficiently abundant. The species appears to be allied to *L. bidentata* and *L. Copteæ*, but is readily separated from either.

## LABOULBENIA COPTÆ Thaxter. Plate LIV, fig. 13.

Proc. Am. Acad. Arts and Sci., Vol. XXXV, p. 167. Dec., 1899.

Form slender. Perithecium free, except the base, nearly straight, curved outward slightly at the tip, which is blackish with hyaline lip-edges; dull translucent olive-brown, concolorous with the receptacle,



or with the basal wall-cells nearly hyaline. Receptacle slender, bulging slightly at the base of the perithecium, cell II narrower distally than cell I, the base of which is hyaline. Outer appendage consisting of a basal cell several times as long as broad, hyaline, externally suffused, usually curved strongly outward, constricted distally at the deeply suffused septum, the subbasal cell abruptly narrower and shorter, usually terminated by two branchlets, the outer distinguished by a dark septum. Inner appendage consisting of a small basal cell bearing a short branch on either side, distinguished by a blackened septum, simple or once branched, usually not longer than the perithecium. Perithecium  $120-140 \times 35 \mu$ . Total length to tip of perithecium  $340-470 \mu$ ; to insertion-cell  $220-300 \mu$ . Appendages (longest)  $400 \mu$ .

On *Coptea armata* Lup., Brit. Mus. No. 595, Santarem, Amazon River, Brazil. On elytra and superior prothorax.

This species is readily distinguished from allied forms by the blackened septa which separate the basal cell of the inner appendage from its branches, a condition seen in no other species of the same general type. The types are in good condition and show little variation.

LABOULBENIA BIDENTATA Thaxter. Plate LIII, figs. 18-20.

Proc. Am. Acad. Arts and Sci., Vol. XXXV, p. 161. December, 1899.

Uniformly pale dirty brown. Perithecium rather darker, free, except at its base; somewhat inflated below, tapering symmetrically from the extremity of the basal wall-cells to the rather narrow apex; the two inner lip-cells suffused with blackish brown and projecting beyond the others to form two blunt prominences, their tips hyaline, contrasting. Receptacle rather short and stout, uniform pale dirty brown, inconspicuously striate punctate with minute somewhat darker points, the lower part of the small basal cell mostly hyaline. Outer appendage consisting of a basal cell several times as large and long as that of the inner, giving rise to an inner (lower) and an outer branch the latter distinguished by a horizontal black septum, its basal cell somewhat rounded and giving rise distally to an outer and an inner branchlet, each commonly once branched, the outer deeply blackened at the base (usually broken): the inner appendage consisting of a basal cell which bears a branch on either side which may be twice branched, hyaline, bearing solitary antheridia laterally. Spores  $50 \times 4 \mu$ . Perithecia  $115-130 \times 45 \mu$ . Total length to tip of perithecium  $220-270 \mu$ ; to insertion-cell  $135-150 \mu$ . Greatest breadth  $70 \mu$ .

On elytra of *Homothis* sp., St. George's Sound, Australia, Hope Coll., No. 309.

Although this species appears at first sight to be a very ordinary type of the *polyphaga* group, the conformation at the tip of the symmetrically inflated perithecium, due to the peculiar form of the lip-cells is quite unlike that of any other species, and serves as an absolute distinction.

LABOULBENIA PEDICILLATA Thaxter.

Specimens of the short stout form of this species have been obtained from *Bembidium nigrum* Dej., South America, in the Berlin Museum, No. 869; and a group of individuals, which I am unable to separate specifically, was found at the tips of the elytra on a specimen of *Dyschirius thoracicus* Rossi, from Europe, in the same collection, No. 893. A figure of this form on *Dyschirius* is given on Plate LVI, fig. 11. A somewhat more elongate form was also found on *Dyschirius globosus* Herbst, from England in the Hope Collection, No. 349.

LABOULBENIA FLAGELLATA Peyritsch.

*L. elongata* Thaxter, Proc. Am. Acad. Arts and Sci., Vol. XXIV, p. 10, 1890.

There can I think be little doubt that the form which I have described as *L. elongata* should be referred to Peyritsch's species since, although I have as yet seen no specimens on species of *Bembidium*, the form which generally occurs on European *Anchomeni* cannot be separated from the American material. It appears to be the common type on *Anchomeni* the world over, and is subject even in its more typical conditions to very considerable variations in form, size, color and in the characters of its appendages. A comparison, moreover, with the varied material which I have included under *L. polyphaga*



and *L. Pterostichi*, make me feel very doubtful whether it would not be better to unite all three forms under one protean species. Yet until I have examined more material, and especially have had an opportunity to study the large collections obtained during a recent journey in South America which are not yet available for examination, it seems best to retain these three names provisionally. What I have formerly spoken of as the "*flagellata*" type, is one about which are clustered a large number of undoubtedly distinct forms, which may occasionally, or even frequently, present variations which, in the absence of other data, could not possibly be separated from conditions of the present species. This is true for example in the case of *L. Brachini* which, in its typical condition is, however, one of the most readily recognizable species.

What the type form of *L. flagellata* really is, it is not possible to determine from the insufficient description of Peyritsch, or from the diagrammatic figures which accompany it, and it is not improbable that the form said to occur on *Bembidium* may be specifically distinct from those on *Anchomenus*; although, as far as can be determined from the figure of the former, it does not differ from the anchomenoid type.

Among the more striking forms which, from their variations toward this type, I have been reluctant to separate specifically, those occurring on *Anchomeni* (*Platynus*) in New Zealand deserve special mention. The typical forms of this race are very striking, and would be without hesitation specifically separated from the more typical conditions of *L. flagellata*: yet its variations are such that I am at present unable to separate it from certain Asiatic and South American material, and it is therefore included provisionally under the present species.

Until I am able to make an extended revision of these forms and illustrate them adequately the following additional material which has been accumulated since the publication of my Monograph may be provisionally included under the present species.

British Museum: No. 416 on *Anchomenus debilis* Woll., Canaries; No. 415 on *A. Nicholisi* Woll., Canaries; No. 634 on *Platynus alacer* Boh., Natal, Africa; No. 633 on *Antisphodrus cavicola* Schaum., Carniola, Austria; No. 632 on *A. longicollis* Boh., Carniola; No. 414 on *Calathus carinatus* Brullé, Teneriffe; No. 416 on *Argutor angularis* Br., Teneriffe; No. 631 on *Pseudopristonychus cimmerius* Steph., South Russia; No. 728 on *Coptodera Championi* Bates, Bugaba, Panama; No. 635 on *Pleurosoma sulcatum* Guer., Columbia; No. 697 on *Colpodes melanocnemis* Chd., Guatemala City, Guatemala; No. 698 on *Colpodes atratus* Chaud., Irazu, Costa Rica; No. 418 on *Dichirotrichus levistriatus* Woll., Canaries; No. 701 on *Onypterygia pusilla* Chaud., Jalapa, Mexico; No. 680 on *Notiobia lurouides* Bates, British Honduras.

Florence Museum: No. (a) on *Pristonychus punctulatus* Dej., Naples; No. (d) on *Platynus albipes* Fabr., Florence ?; No. 1 on *Argutor interstinctus* Sturm., Florence; No. (m) on *Pristonychus Algerinus* Gory, Sardinia; No. (f) on *Platynus lugens* Duft., Piedmont; No. (c) on *P. dorsalis* Mull., Florence (?)

Paris Museum: No. 181 on *Antisphodrus Aeacus* Miller, Cave of Narente, Dalmatia; No. 182 on *A. Eberi* Sch., same locality; No. 182b on *A. cavicola* Sch., Istria; No. 131 on *Platynus*?, Sikkim, India; No. 120 on *Platynus* sp. (?) New Zealand (?); No. 123 on *Anchomenus deplanatus* White, New Zealand; No. 158 on *Notonomus variicollis* Chd., Australia; No. 195 on *Rhagodus lævipunctatus*, Pekin, China.

Berlin Museum: No. 1041 on *Colpodes ruficeps* MacLeay, Ceylon; No. 1034 on *Lipterus microcephalus* Motsch. Japan; No. 1035 on *Anchomenus validus*, New Grenada; No. 1038 on *Megalonychus* sp., Port Natal, Africa; No. 1046 on *Acanthogenius asteriscus* Hope, Hong Kong; No. 1036 on *Anchomenus oblongus* Fabr., Europe; No. 1042 on *Colpodes reflexus* Chaud., Columbia; No. 1044 on *C. atratus* Chd., Bogota, No. 1043 on *C. sulcatus* Chd., New Grenada. Sharp Collection; No. 1143 on *Antisphodrus Fairmæri* Sch., Spanish Caves; No. 1166 on *Anchomenus Faradayi* Bates, New Zealand (typical); No. 1160 on *Dichochile subopacum*, New Zealand; No. 1162 on *Anchomenus Otagoensis* Bates, New Zealand; No. 1163 on *A. montivagus* Bates, N. Zealand; No. 1164 on *A. latipennis*, Auckland, N. Z.; No. 1165 on *A. Helusi* Sharp, Greymouth, N. Z.

Hope Collection; No. 275 on *Onypterygia purpuratus* Bogota; No. 352 on *Stomis puniceatus* Pz.,



England, No. 351 (a) on *Platynus "lævis" Mull.*, England; No. 351 (b) *P. dorsalis* Mull., England; No. 351 (c) on *P. dorsalis* Müll., Italy. No. 351 (d) on *P. oblongus* Fab., Italy; No. 313 ? *Diorichodorus*, "N. H."

LABOULBENIA PARVULA Thaxter.

Specimens apparently belonging to this species were found on *Pelmatellus obtusus* Bates Brit. Mus. No. 684. Ostuacan, (?), Mexico.

LABOULBENIA TÆNODEMÆ Thaxter. Plate LVIII, fig. 13.

Proc. Am. Acad. Arts and Sci., Vol. XXXV, p. 204. Dec., 1899.

Perithecium nearly free, slightly inflated, clear translucent brown; the tip well differentiated, externally black with an inner inferior hyaline patch, the lips well distinguished hyaline, the inner very prominent, rounded, the pore external. Receptacle long and slender through the elongation of cell II, pale dirty yellowish brown or nearly hyaline. Insertion-cell large, free, blackish, slightly narrower than cells IV + V. Appendages concolorous with the receptacle, the outer consisting of a large basal cell which bears distally as a rule two antero-posterior branches; the inner simple, the outer furcate above its basal cell; the branches stout, slightly tapering, elongate, the inner erect, the outer divergent; its branchlets curving upward: the inner appendage consisting of a much smaller basal cell, rounded and bearing one or two short branchlets. Spores about  $70 \times 5 \mu$ . Perithecia  $125-155 \times 35-50 \mu$ . Total length to tip of perithecium  $400-650 \mu$ ; to insertion-cell  $300-400 \mu$ . Appendages, longest about  $600 \mu$ .

On the elytra and superior prothorax of *Tænodema* sp., Brit. Mus. No. 391 and Sharp Coll. No. 1152 on *T. cinerea* Sharp, Ega, Amazon.

Thirty individuals of this species which have been examined vary very slightly, and for the most part only in size, the appendages being constant in their characters as represented in fig. 13. The perithecium is practically free and almost symmetrically inflated. The tip almost neck-like, the black and hyaline parts sharply contrasting. I was at first inclined to consider this one of the many varieties, perhaps better assembled under one name, which are included in *L. flagellata* and *L. Pterostichi*; but further comparison leads me to believe that it should be kept distinct. The hosts belong to a remarkable and very beautiful genus of large tree living Staphylinidæ inhabiting tropical South America.

LABOULBENIA UNCINATA Thaxter. Plate LXI, fig. 13.

Proc. Am. Acad. Arts and Sci., Vol. XXXV, p. 208. Dec., 1899.

Pale yellowish, becoming tinged with pale reddish yellow. Perithecium more than one half free, relatively large, stout, nearly oblong, the black tip recurved externally through the rounded upgrowth of the inner distal portion of the perithecium which makes them almost lateral in position, the right lateral lip-cell often twice as long as the others and more prominently recurved, its projecting portion the branchlets short, translucent, rounded. Receptacle medium, normal. Appendages normal, rather short, several times branched, the cells rather short stiff, divergent and somewhat tapering. Spores  $50 \times 3.5 \mu$ . Perithecium (not including lip-cells)  $120 \times 62 \mu$ . Total length to tip of perithecium  $100-120 \mu$ ; to insertion-cell  $72-92 \mu$ . Appendages (longest)  $40 \mu$ .

At base of anterior legs of *Harpalus æneus* Fabr., Selenga, Siberia, Paris Mus. No. 12, and of *Harpalus viridiæneus* Beauv., Cape Neddock, Maine, collected by Mr. Charles Bullard.

This species is well distinguished from *L. macrotheca*, to which it seems to be more nearly related, by the repeated branching of its short stiff tapering divergent branches, and by the peculiar modification of its lip-cells, which is exactly the same both in the Siberian and American material. The accompanying figure is drawn from specimens obtained by Mr. Bullard from a species of *Harpalus* the determination of which as given above is not certain.



## LABOULBENIA MACROTHECA Thaxter.

Typical specimens of this form were found in the Paris Museum No. 13; on *Anisodactylus* (or *Harpalus*?) from Selenga, Siberia. On *Harpalus viridiæneus* Beauv., Bathurst, N. B. (Dr. Richards). The Siberian and American specimens of this coarse tipped, straw yellow form are identical and indicate that it is a species of constant characters.

LABOULBENIA PLATYPROSOPI Thaxter. Plate LV, fig. 6.  
Proc. Am. Acad. Arts and Sci., Vol. XXXVIII, p. 51. June, 1902.

Uniform transparent pale reddish amber, the cell-walls very thick. Perithecium straight, wholly or nearly free, erect, the margins slightly convex; of nearly equal diameter throughout to the rather abruptly differentiated short erect blackish tip; the hyaline lip-edges outwardly oblique: the base sometimes abruptly broader than the ascigerous portion. Cells I-VI of the receptacle not differing very greatly in length, except cell V, which is relatively large; cells III and VI paired; cell IV prominent externally below the thin contrasting distinctly reddish insertion-cell. The appendages quite hyaline, the basal cell of the outer several times larger than that of the inner, and bearing two to four branches in an antero-posterior series; the basal cells of which usually bear each a pair of branchlets in the same plane: the small basal cell of the inner appendage producing a branch on either side bearing branchlets similar to those of the outer appendage; the antheridia crowded on special branchlets, curved hyaline, small and closely appressed. Spores about  $55 \times 5 \mu$ . Perithecia  $150-185 \times 36-45 \mu$ . Receptacle  $150-220 \times 60-70 \mu$ . Appendages, longest,  $360 \mu$ . Total length to tip of perithecium,  $275-350 \mu$ .

On the elytra and abdomen of *Platyprosopus Beduinus* Nordm.; Berlin Museum, No. 810; Nubia.

This pale form was found in numbers and in good condition on the large Staphylinid above mentioned. Though it possesses no very marked individuality, it is easily distinguished by its relatively short and broad receptacle, cells III and VI of which are almost equal, though cell III may be slightly the longer of the two. The perithecium, which is usually straight and relatively long, is often set on the receptacle a little within the external margin and, as in *L. Anaplogeniæ*, the insertion-cell has a characteristic red-brown or claret-colored tint.

LABOULBENIA ANCHONODERI Thaxter. Plate LV, figs. 10-11.  
Proc. Am. Acad. Arts and Sci., Vol. XXXV, p. 156. Dec., 1899.

Pale amber-yellow, perithecium slightly darker, about two thirds free, the inner lip-cells suffused below with blackish brown, an external prominence involves the upper portion of the subbasal and lower portions of the subterminal wall-cells, forming, in the specimens from *A. subæneus*, an abruptly defined hunch. Receptacle normal, the basal and subbasal cells usually slender and somewhat darker, the subbasal more distinctly marked with fine transverse striations which are less distinct on the cells above it. Appendages concolorous, the outer simple (always?), the inner consisting of a basal cell similar to that of the outer, about twice as long as broad, giving rise on either side to a single branch which may be once branched above its basal cell; all the branches somewhat flexed. Insertion-cell red-brown or purplish, more or less oblique through the upgrowth of cell V. Spores about  $45-48 \mu$ . Perithecia (larger)  $185 \times 48 \mu$ , average  $125 \times 48 \mu$ . Total length to tip of perithecium  $275-500 \mu$  (longest  $535 \mu$ ). Appendages about  $200 \mu$ .

On the elytra of *Anchonoderus subæneus* Reiche, San Felix, Panama, and *A. binotatus* Reiche, Guatemala City, Brit. Mus. (Biologia coll.), Nos. 706 and 707. On *A. pallipes* Reich., New Grenada, Berlin Museum No. 1026, var. on *A. rugosus* Dej., Columbia, Berlin Museum No. 1025.

Although this species is subject to considerable variation, it is usually easily recognizable by its reddish to claret-colored insertion-cell, which is carried out free from the perithecium, as a rule, by the enlargement of cell V. The subterminal external, often somewhat angular, hunch of the perithecium is sometimes wholly absent, but is usually well marked. A variety on *A. rugosus* (Berlin Museum No. 1025) has the subbasal cell of the outer appendage suffused with deep red brown. The material on *A. subæneus* is taken as the type.



## LABOULBENIA ANAPLOGENII Thaxter. Plate LV, figs. 4-5.

Proc. Am. Acad. Arts and Sci., Vol. XXXV, p. 156. Dec., 1899.

Perithecium nearly hyaline or pale yellowish, becoming tinged with pale amber-brown, stout, free except at its base, the outer margin mostly straight, the inner convex; the tip rather small and abruptly distinguished, blackish except the hyaline lip-margins. Receptacle concolorous with the perithecium, rather short and stout, cell V relatively large, cell IV divided by transverse septa into from two to several superposed cells, usually extending upward beyond the insertion-cell, thus forming a blunt outgrowth external to it. Insertion-cell red-brown to claret-colored. Basal cells of the appendages nearly equal, each producing as a rule two similar branches antero-posteriorly, once or twice branched in the same plane, the branchlets rather elongate and slender, concolorous with the receptacle. Perithecium 140-155  $\times$  50-55  $\mu$ . Spores 50  $\times$  4.5  $\mu$ . Total length to tip of perithecium 300-400  $\mu$ , to insertion-cell 200-240  $\mu$ , greatest width 50-70  $\mu$ . Appendages, longest 600  $\mu$ , average 300  $\mu$ .

On the elytra of *Anaplogenius circumcinctus* Moh., Brit. Mus. Nos. 622 and 665, China: on *Abacetus costatus* Ceylon; Berlin Museum No. 903: *A. rubripes*, ? France, Berlin Museum No. 905; *Abacetus* sp. Bengal, Berlin Museum No. 904; on *Agonoderus pallipes* Fabr., New England. *Stenolophus fuliginosus* Dej., Cambridge, Mass. Also immature material of apparently the same species on an undetermined Carabid, Paris Museum, No. 4, from Madagascar.

Allide to *L. polyphaga*, but distinguished by its pale yellow color and the tendency of cell IV to become septate and proliferous. Many specimens occur, however, in which the receptacle is normal. The antheridia are often greatly multiplied; but the numerous antheridial branches may be replaced, especially in the Asiatic material, by numerous elongate sterile branches. No. 665, on *Anaplogenius* from China, has been taken as the type (fig. 4). A remarkably well developed form from the Cambridge region is represented in fig. 5. The species resembles *L. Anchonoderi* and *L. Platyprosopi* in having a red insertion-cell.

## LABOULBENIA VERRUCOSA Thaxter. Plate LVI, fig. 16.

Proc. Am. Acad. Arts and Sci., Vol. XXXV, p. 209. Dec., 1899.

Perithecium becoming deeply suffused with smoky brown, straight, the line of demarcation between the subterminal and subbasal wall-cells indicated by a more or less well defined ridge forming a rather prominent external hunch in this region, above which the perithecium is abruptly contracted, almost at right angles in the type, below the rather narrow nearly erect tip, the lip-cells black below, with the broadly hyaline edges turned obliquely outward. Receptacle dirty yellow-brown, becoming more or less suffused with smoky brown, especially the two basal cells, and covered with irregular wart-like prominences which are more or less definitely arranged in transverse rows. Appendages of ordinary type, the outer once to twice branched, the inner consisting of a smaller basal cell giving rise on either side to single branches which may be from once to three times branched; all the branches divergent, pale dirty yellowish with brown shades above the lower septa. Perithecia 150-170  $\times$  45-50  $\mu$ . Total length to tip of perithecium 550-610  $\mu$ ; to insertion-cell 430-480  $\mu$ . Appendages (longest) 400  $\mu$ .

On the elytra of a carabid allied to *Platynus*, Hope Coll. No. 342 (without label) and U. S. Nat. Museum, No. 7, Mt. Coffee, Liberia, Africa.

The specimens from Mt. Coffee are paler than those from the Hope Collection, the perithecium being concolorous with the dirty amber receptacle, the subterminal ridge and external hunch alone being darker colored. The species is nearly allied to some large forms of *L. flagellata*. Its corrugated surface recalls *L. notata*, but the two are not nearly allied.

## LABOULBENIA SPIRALIS Thaxter. Plate LVIII, fig. 1.

Proc. Am. Acad. Arts and Sci., Vol. XXXV, p. 202. Dec., 1899.

Perithecium one half to one third (sometimes only the tip), free from the receptacle, dark dull amber-brown with dirty brown suffusions, rather stout, the tip moderately well distinguished, rather short and



stout, deep black-brown, except the distal hyaline lip-edges. Distal portion of the receptacle concolorous with the perithecium; cells I and II much paler; cell I longer than cell II, the two forming a rather slender stalk of about the same diameter throughout, above which the distal portion of the receptacle is somewhat abruptly distinguished; the lighter portions marked by fine transverse striations not visible in the deeply colored often opaque distal region. Outer appendage consisting of a main straight divergent axis formed by usually three nearly equal cells, deeply blackened externally, bearing distally and from each of their upper inner angles, a very long slender erect simple branch, which is reddish brown, paler and spirally twisted distally. The inner appendage consisting of a basal cell about as large as that of the outer appendage and bearing on either side a branch which may give rise to one or two erect simple branchlets similar to the branches of the outer appendage. Perithecia about  $150 \times 55 \mu$ . Total length to tip of perithecium 300–390  $\mu$ ; to insertion-cell 275–325  $\mu$ . Appendages, longest 480–610  $\mu$ .

On *Hexagonia* sp. ?, Hope Coll., No. 288, Ceylon (Thwaites) on *Helluodes Nebrioides* Nietn., Berlin Museum, No. 1050, Ceylon.

This species appears to suggest a transitional type between *L. flagellata*, or some of its forms, and *L. Helluodis* which it approaches in the character of its appendages. The branches of the latter are remarkably developed, and although in the material from *Helluodes* they are mostly broken, the spiral twist of the extremities seems characteristic of this as well as of the type material, supposed to have occurred on *Hexagonia*, although the determination in the last instance was uncertain.

LABOULBENIA CEYLONENSIS Thaxter. Plate LVIII, figs. 9–10.

Proc. Am. Acad. Arts and Sci., Vol. XXXV, p. 164. Dec., 1899.

Perithecium wholly free, suffused with smoky brown, relatively short and small, straight, hardly inflated, somewhat abruptly contracted distally to form the unusually large broad tip, the distal half of which is hyaline, distinguished from the opaque black lower half by a clean cut line of demarcation: the basal cells forming a short stout hyaline neck narrower than the body of the perithecium. Receptacle elongate, of nearly the same diameter throughout, the basal cell nearly hyaline, the cells above it more or less deeply suffused with smoky brown, cell V and the upper portion of cells IV and VII hyaline, the distal suffused portion obscurely punctate. Outer appendage consisting of a basal cell deeply blackened externally (the blackened area continuous with the black insertion-cell and involving also the external walls of the two cells immediately above it) producing from one to three branches arranged antero-posteriorly, which may be once or twice branched in a similar fashion, the branchlets long, slender, drooping, hyaline, some of the lower cells suffused with reddish brown: the inner appendage consisting of a basal cell about half as large as that of the outer, producing in the types a single branch which may be once branched as in the outer. Perithecium  $105 \times 32 \mu$ . Total length to tip of perithecium 445  $\mu$ ; to insertion-cell 320  $\mu$ . Greatest breadth 42  $\mu$ . Appendages 340  $\mu$ .

On *Hexagonia*?, Ceylon, Hope Coll. No. 288. On elytra.

This singular species, which belongs to the group in which *L. Helluodis*, *L. spiralis* and *L. Planetis* are associated, is remarkable for its relatively very small perithecium, which is combined with a large elongate, almost isodiametric receptacle. The four types examined are in moderately good condition and show no essential variations.

LABOULBENIA FLACCIDA Thaxter. Plate LVIII, fig. 5.

Proc. Am. Acad. Arts and Sci., Vol. XXXVIII, p. 37. June, 1902.

Perithecium free except at its base, brown, straight, slightly inflated below, tapering evenly to the broad blunt apex; the tip scarcely if at all distinguished, marked by darker shades; the lips coarse, forming slight irregular projections. Receptacle yellowish or nearly hyaline, becoming slightly tinged with brownish and faintly punctate above the basal cell, which, as well as the subbasal, is relatively large, the two subequal, usually more or less abruptly distinguished from the broader compact portion, the cells of which are relatively small, the upper half or less of cell IV free, projecting externally to the insertion cell,



which is rather small and thick; deep, slightly reddish, brown, the deep suffusion continuous with a corresponding external coloration of the basal cell of the outer appendage and the three to four lower cells of the outer branch, which arises from it and which curves more or less strongly outward; the distal portion curved upward, hyaline, tapering, flaccid, each of the suffused cells giving rise distally, from the inner side, to a more or less erect, simple (or the lower sometimes furcate) hyaline branchlet, the lower cells of which are rather long and slender, inflated; the distal portion tapering, thin-walled, usually becoming flaccid; the inner branch of the appendage furcate above its erect basal cell, the branchlets divergent and similar to those of the outer branch, or short and bearing antheridia usually in pairs; the inner appendage consisting of a basal cell about as large as the outer, bearing a hyaline branch on either side which is usually furcate above its basal cell, the branchlets similar to those of the outer appendage. Spores about  $40 \times 4 \mu$ . Perithecia  $80-90 \times 25-30 \mu$ . Receptacle  $90-125 \mu$ . Appendages  $150-200 \mu$ . Total length to tip of perithecium  $175-220 \mu$ .

On legs of *Casnonia subdistincta* Chaud.; British Museum, Biologia Collection, No. 704. (Mexico ?)

This species is in some respects not unlike *L. Casnoniæ*. Its appendages, however, belong to the type illustrated by *L. Planetis* and *L. Helluodis*, and easily distinguish it from any of the forms of *L. polyphaga*, or of other species with which it might possibly be confused.

LABOULBENIA STOMONAXI Thaxter. Plate LIV, fig. 16-17.

Proc. Am. Acad. Arts and Sci., Vol. XXXVIII, p. 54. June, 1902.

Perithecium hyaline, becoming tinged with brown, less than one half free; short, the outer margin nearly straight, bending rather abruptly inward at the tip; the inner margin converging to the apex from its point of union with cell V; the tip rather abruptly distinguished, broad; the apex nearly flat, the lips hardly prominent. Receptacle yellowish or hyaline, with faint brownish shades; the basal cell usually bent, the subbasal with deeper brown suffusions; cell III more or less deeply suffused with brown, its thick outer wall opaque or nearly so; cells III and IV subequal, several times longer than broad; cell V long-triangular. Insertion-cell thick, black, contrasting, wholly free, separated from the perithecium by nearly the whole upper margin of cell V. Outer appendage curved strongly outward, hyaline on its inner side, deeply suffused on the outer concave side, the suffusion continuous with the insertion-cell; consisting of a small number of cells, the basal relatively long, the rest producing suberect hyaline branchlets distally on the upper side: basal cell of the inner appendage smaller, the subbasal cell usually bearing two branchlets. Spores  $50 \times 5 \mu$ . Perithecia  $65 \times 25 \mu$ . Receptacle  $100-110 \mu$ . Appendages  $50-75 \mu$  approximately. Total length to tip of perithecium  $130-140$ .

On the margin of the left elytron of *Stomonaxus* sp., Java; Paris Museum, No. 93.

In the types of this small and peculiar species, the appendages are more or less broken, even in the youngest specimens. It is distinguished by the conformation of the distal portion of the receptacle, and the deep lateral suffusion of the latter, as well as by the entire absence of suffusions even at the tip of its perithecium. The spores are large for so small a form, nearly equalling the perithecium in length. It does not appear to be nearly related to any other described species.

LABOULBENIA HELLUODIS Thaxter. Plate LVIII, figs. 11-12.

Proc. Am. Acad. Arts and Sci., Vol. XXXVIII, p. 41. June, 1902.

Perithecium becoming rich brown, free, usually somewhat broader distally, slightly inflated; the basal-cells forming a clearly defined, somewhat constricted, short neck; the tip abruptly distinguished, bent very slightly outward, opaque except the broadly hyaline or subhyaline, broadly rounded lips. Basal cell of receptacle hyaline or subhyaline, inflated, broader than, and contrasting with, the opaque subbasal cell, which is of about equal length and forms a constricted region; the distal portion of the receptacle small, rather abruptly broader, sub-triangular, the external margins even; cells III, IV and VI subequal, more or less deeply suffused with brown; cells III and IV more deeply suffused externally, about half the upper margin of cell IV free and forming a distinct prominence external to the jet black insertion



cell; cell V small and roundish, the dark portions indistinctly punctate. Outer appendage consisting of a divergent main axis of three cells, broadly and deeply blackened externally and at the septa; the two lower bearing a single, usually simple, divergent branch distally from the inner side; the upper bearing two such branches terminally, the outer deeply suffused with blackish brown, especially toward its base, and directly continuous with the suffused portion of the main axis; the basal cell of the inner appendage half as large as that of the outer, giving rise to a rather short simple branch on either side, or often itself simple, bearing one or two solitary antheridia near its base. Spores about  $85 \times 5 \mu$ . Perithecia  $150-165 \times 40-55 \mu$  including the stalk ( $20 \mu$ ). Receptacle  $185-220 \times 60 \mu$ . Longest appendages  $290 \mu$ . Total length to tip of perithecium  $360 \mu$ .

On *Helluodes Nebrioides* Nietn., Ceylon; Berlin Museum, No. 1050.

This striking species seems most nearly related to *L. Ceylonensis*, *L. spiralis* and *L. Planetis*, the appendages of which are very similar. Its typical form illustrated in fig. 11, is very clearly distinguished by its free perithecium, and the peculiar conformation and coloration of the receptacle. The types were associated with a few mostly broken specimens of *L. spiralis* which, however, is distinguished from it by the form and coloration of the perithecium and receptacle, and the relation which the former bears to the latter.

LABOULBENIA PLANETIS Thaxter. Plate LVIII, fig. 6.

Proc. Am. Acad. Arts and Sci., Vol. XXXVIII, p. 50. June, 1902.

Perithecium large and stout, clear transparent brown, except the subhyaline base, which is separated by a more or less clean-cut line of demarcation; the wall-cells with a slightly spiral twist, the tip abruptly distinguished, symmetrical or nearly so, black, except the evenly rounded subhyaline symmetrical lip-edges. Receptacle rather slender, subhyaline with pale brownish shades; cell II twice as long as the basal cell; cell IV bulging rather prominently externally and more deeply suffused with brown. The insertion-cell deep black, broad, thick. The appendages erect, their branches curved toward the perithecium: outer appendage normally consisting of a main axis of three superposed cells, externally broadly blackened, the blackening involving the septa and adjacent external portions of the cells; the distal cell bearing three branches; an outer and an inner simple, and a median one, once branched, the outer deeply suffused about its base, which forms a direct continuation of the suffused external area of the main axis; the remaining cells each producing a usually simple branch distally on its inner side; all the branches long, slender, distally thin-walled and hyaline, curved toward the perithecium, the lower somewhat constricted, and more or less deeply suffused at the lower septa: basal cell of the inner appendage half as large as that of the outer, bearing a branch on either side, from the basal cells of which arise often two branchlets, similar to those of the outer appendage. Spores  $65 \times 5 \mu$ . Perithecia  $155-165 \times 55-60 \mu$ . Receptacle  $290 \mu$ . Appendages  $360-435 \mu$ . Total length to tip of perithecium  $400-425 \mu$ .

On the thorax of *Planetes bimaculatus* MacLeay, Java; Berlin Museum, No. 1047.

A beautiful species, closely allied to *L. Helluodis*, but having a very different receptacle and perithecium. Three specimens, only, have been examined, two of which are in nearly perfect condition.

LABOULBENIA ROUGETII Robin.

*L. Europæa* Thaxter.

It seems quite certain that what I previously described as *L. Europæa* is in reality the species figured by Robin, although the plates are quite misleading, apparently representing individuals in which the appendages have become more or less abnormal through injury. So large a number of European *Brachini* have been examined, however, on which *L. "Europæa"* is the common species, that there seems no question as to the correctness of the reference.

The typical form, as it occurs on *Brachinus*, and also on *Aptinus*, *Leistus* and *Chlænium*, is distinguished by its almost obconical receptacle, which is relatively broad distally; the form of the perithecium, which normally tapers very evenly from its base to the blunt apex, the outer and inner margins often nearly



straight; the character of the outer appendage, which is more or less deeply suffused toward the base and from the basal or subbasal cells of which, sometimes from both, arise simple, more or less rigid branches of variable length, tapering and rather slender; the normal color of the receptacle and perithecium is a characteristic red amber-brown, which may often be obscured by smoky brown shades. Some South African and Madagascar specimens are uniformly pale yellowish, sometimes without any suffusions, even in the appendages, and closely resemble the simple types of *L. Brachini* which replaces *L. Rougetii* on these hosts in the western hemisphere.

Two varieties on *Brachini* from the Orient are distinguished below. Exclusive of these, the material examined of this species is as follows: Paris Museum No. 30 on *Brachinus* sp., Algeria; No. 35 on *Chlænium aneocephalus* Dej., Algeria; No. 61 on *Brachinus nigricornis* Gebl., Asia; No. 62 on *Brachinus* sp., Africa; No. 129 on *Brachinus* sp., Turkestan; No. 196 on *Chlænium gracilicollis*, Turkestan (also from British Museum No. 596). British Museum No. 532 on *Aptinus* sp., Port Natal, Africa; No. 538 on *B. exhalans* Rossi, Athens, Greece; No. 542 on *Brachinus* sp., Cape of Good Hope. Hope Collection No. 242 on *Aptinus Italicus*, Rome; No. 243 on *A. Boeticus*. Andalusia, Spain; No. 246 on *A. displosor* Dufour, Spain; No. 251 on *B. angustatus* Dej., Morocco; No. 326 on *Chlænium Mediterraneus*; No. 327 on *Leistus præustus* Fabr. = *rufescens* Fabr. (no locality); No. 347 on *B. crepitans* Linn., England; Berlin Museum No. 979 on *B. humeralis* Ahr., France; No. 984 on *B. gentilis* Erichs., Angola, Africa; No. 986 on *B. Bayardi* Dej., Bagdad; No. 987 on *B. bipustulatus* Quens., Caucasus; No. 988 on *B. cyanipennis*, and No. 989 on *B. ruficeps* Fabr., Cape of Good Hope.

The following varieties occurring on the larger oriental species of *Brachini* may be distinguished.

Var. **Chinensis** nov. var. This form which is common on various oriental species of *Brachinus*, is distinguished by its large size, 450  $\mu$  to the tip of its perithecium, and the luxuriant development of its several times divaricately branched appendages which may measure more than 450  $\mu$ . The general color and form of the receptacle are as in the type, the perithecium more distinctly inflated as shown in fig. 8, Plate LV, which is much reduced.

On *B. Chinensis* Chaud., British Museum 536, China; Hope Collection, No. 244, Hong Kong; Paris Collection No. 59 Macao, China; Berlin Museum No. 997, Hong Kong. On *Brachinus* sp. British Museum No. 539, China.

Var. **Japanensis** nov. var. This is a large form, the largest specimens measuring 700  $\mu$  to the tip of the perithecium, and is distinguished by the very stout outwardly curved relatively short appendages, which are closely branched at and near the base; the whole basal region becoming black and opaque in some specimens, a condition not marked in the individual illustrated in Plate LV, fig. 7. The general color is as in the type, the perithecium somewhat inflated and relatively small. The twenty-five specimens of various ages that have been examined are constant and readily separable from any other forms of *L. Rougetii*. In a few individuals the dense branching of the appendages gives an appearance very similar to that seen in certain forms of *L. Brachini*. The branches do not, however, result from a repeated proliferation of the basal cells, the characteristic oblique black septa are absent, and the antheridia are of a different type.

On *Brachinus* sp., Japan, Sharp Collection, No. 1188.

The species is thus similar on the one hand to *L. flagellata* and its near relatives, and on the other to *L. Brachini* through the var. *Japanensis*.

LABOULBENIA BILABIATA Thaxter. Plate LV, fig. 9.

Proc. Am. Acad. Arts and Sci., Vol. XLI, p. 315. July, 1905.

Form stout, the basal cell of the receptacle nearly hyaline, the subbasal becoming amber-yellow, the parts above it clear amber-brown. Perithecium stout, nearly symmetrical, tapering to the broad tip, the anterior lip-cells modified subterminally to form a closely approximated pair of broadly rounded projections, which are subtended on the inner side by the slightly prominent rounded apex, which is in turn



subtended by a blackish suffusion of no great size. Receptacle normal, rather short and stout, the basal and subbasal cells slightly prominent anteriorly, of nearly equal length, the walls very thick and striate. Appendages normal, the outer consisting of a black-brown basal cell, twice as long as broad, bearing distally the two divergent branches, which are mostly once branched (antero-posteriorly), all the lower cells suffused with brown, becoming hyaline toward the tips: the inner appendage consisting of a basal cell, slightly shorter than that of the outer, paler brown, bearing the normal branch on either side; the branchlets more or less elongate, or bearing loose tufts of antheridia. Perithecium  $240 \times 75 \mu$ , including the terminal projections, which measure  $25 \times 22 \mu$ . Receptacle  $225-250 \mu$ . Total length  $450 \times 115 \mu$ . Appendage  $200-300 \mu$ .

On *Brachinus armiger* Dej., Cape of Good Hope; Berlin Museum, No. 982.

This species is closely allied to *L. Rougetii*, being similar in color and having the same appendages; but differs in the subterminal outgrowth at the tips of the perithecium which renders the pore lateral on the inner side.

LABOULBENIA DUBIA Thaxter. Plate LV, fig. 1.

Proc. Am. Acad. Arts and Sci., Vol. XXXVIII, p. 35. June, 1902.

Perithecium dark brown, rather long, mostly straight externally, the tip small, usually abruptly distinguished; the lips outwardly oblique, the blackish inner lip-cell more prominently rounded and subtended by a slight, usually distinct rounded elevation especially on the inner side, which gives the tip a characteristic outline; the body dark translucent brown, wholly free. The receptacle very thick-walled, pale dirty brownish yellow, deeper distally. The basal cells of the appendages subequal, the outer bearing two branches radially, which are simple, or the inner once branched above its subbasal cell; the antheridia borne singly at the lower septa or on short branchlets: all the ultimate branches of both appendages, about six, relatively stout, erect, rather closely septate, about six- to eight-celled, curved slightly outward, tapering to the blunt extremities, which but slightly exceed the apex of the perithecium. Spores  $55 \times 5 \mu$ . Perithecia  $165-185 \times 55-65 \mu$ . Receptacle  $220-325 \times 75 \mu$ . Longer appendages  $220 \mu$ . Total length to tip of perithecium  $440-500 \mu$ .

On the abdomen of *Philonthus politus* Linn., Alverstoke, England; British Museum, No. 363.

With the exception of a few immature individuals on *Philonthus punctus* Grav. from Europe (British Museum No. 427) which may belong to this species, no other form on the thousands of *Philonthi* which I have examined, has been found which at all resembles the present one. It is perhaps too near *L. rigida*, but differs in its copious appendages and in the often pronounced subterminal enlargement of the perithecium. One other species of *Laboulbenia* has been seen on *Philonthus* (exclusive of *Cafus* on which *L. Cafi* and a second undetermined form are known to occur) which is represented by a single immature specimen from *P. decorus* Grav. in the British Museum, No. 423, Heidelberg; but this species, with its very copiously branched appendages, which recall those of *L. Brachini*, is entirely different from the present form.

LABOULBENIA LATONÆ Thaxter. Plate LVI, figs. 3-4.

Proc. Am. Acad. Arts and Sci., Vol. XXXVIII, p. 45. June, 1902.

Perithecium usually deep brown, nearly opaque, the tip large rather coarse lipped, free from the receptacle. The receptacle normal often greatly elongated through the development of cell II, insertion-cell borne free from the receptacle by the elongation of cells IV and V. The outer appendage consisting of a large, broad, subhyaline basal cell, which gives rise to two, often three, or rarely more, branches in a crest-like radial series, their basal cells small squarish subhyaline; producing, as a rule, a pair of greatly elongated simple deep rich brown flexuous tapering branchlets; the basal cell of the inner appendage giving rise in general to a branch on either side, one of which resembles the branches of the outer appendage, and gives rise to long slender brown branchlets; the other commonly short, and bearing one or two antheridial branchlets; the small straight antheridia borne in compact groups of two to four members.



Spores  $70 \times 5 \mu$ . Perithecia  $175-220 \times 60 \mu$ . Longest appendages  $1150 \mu$ , the average  $750 \mu$ . Total length to tip of perithecium  $325-1125 \mu$ .

On all parts of *Latona Spinolæ* Guér., Bogota, Berlin Museum, No. 834.

This species, which varies considerably in size, is well distinguished by its crest-like appendages, which recall those of *L. cristata*, the very long stiff deep red-brown ultimate branchlets of which are very similar in general appearance. The type of branching is however quite different, and the species is perhaps more nearly allied to *L. Quedii* which is still only known through the Type figured in my Monograph.

LABOULBENIA OEDICHIRI Thaxter. Plate LXI, fig. 7.

Proc. Am. Acad. Arts and Sci., Vol. XXXVIII, p. 48. June, 1902.

Tinged with smoky brown. Perithecia falcate, strongly bent toward the appendages, pale smoky brown, tapering symmetrically, or nearly so, to the base and apex; the basal cells forming a short narrow hyaline stalk; the tip not differentiated, suffused with deep blackish brown, except the pale or hyaline blunt apex, the outer lips most prominent. Receptacle more or less distinctly punctate, relatively long and of nearly equal diameter throughout, often slightly geniculate through an enlargement of the basal cell, which is relatively very large just below the subbasal cell, which is smaller and separated by a more or less oblique septum; cell III relatively small, distally more prominent on the inner side; cells IV and V very small, nearly equal; cells III and VI subequal. The insertion-cell small, rather thick, wholly free and separated from the stalk of the perithecium by about half the width of cell V. The basal cell of the outer appendage larger, sometimes inflated, bearing distally, as a rule, one terminal and two lateral branches which are usually simple, distally hyaline, somewhat constricted at the septa, hardly reaching to the tip of the perithecium; basal cell of the inner appendage very small, circular in outline, bearing apparently three branches like the outer. Spores  $55 \times 5.5 \mu$ . Perithecia  $125 \times 32 \mu$ . Receptacle  $150 \times 30 \mu$ . Appendages about  $90 \mu$ . Total length to tip of perithecium about  $250 \mu$ .

On the elytra and upper surface of the abdomen of *Oedichirus* nov. sp.; Sharp Collection, No. 1154; Rio de Janeiro, Brazil.

The curious form of the perithecium in this species which is inflated above its narrow hyaline neck, and its peculiar receptacle, the distal part of which is relatively greatly reduced, serve to distinguish it very clearly. Cells IV and V are very small and nearly equal, while cell I is relatively large, larger and broader than cell II, and punctate where it is suffused. The host is a staphylinid, one of the *Pæderini*, but the parasite does not appear to be nearly related to *L. cristata*, or to any other described species.

LABOULBENIA CRISTATA Thaxter.

Although the species of *Pæderus* are so numerous and at the same time so varied and peculiar, this single species of *Laboulbenia*, which occurs on them all over the world, does not appear to be subject to any considerable variation except in the number of branches which compose the crest-like group of appendages; and even this variation is not associated either with particular regions, or special hosts. Further material has been obtained from the Berlin Collection No. 838 on *P. longipennis* Erichs., Sicily; No. 839, on *P. coarctatus* Erichs., Brazil; No. 840 on *P. duplex* Epp., "Arussi Calla.," N. W. Africa; in the Sharp Collection; No. 1153 on *P. rutilicornis* Er., Columbia: in the British Museum; No. 763 on *P. luridiventris*, Sharp, Volcan de Chiriqui; No. 388 on *Pæderus* sp., Java; No. 389 on *P. australis* Guer., Australia, No. 764 on *P. erythroderus* Erich., Cordova, Mexico: in the Paris Museum No. 204 on *P. furcipes* Curtis, Muscata, India; No. 180 on *Pæderus* sp. Venezuela: in the Hope Collection No. 219, on an East Indian *Pæderus* collected by Wallace, labeled "Bac. 38."

LABOULBENIA DIOPSIS Thaxter.

Additional specimens of this well marked species were found in the Berlin Museum on *Diopsis tenuipes* Westw. No. 862, Bondie, Africa and on *Diopsis* sp. No. 857, Togo, West Africa, and in the British



Museum on *Diopsis* sp. from East Africa No. 738. In the last mentioned specimens the tips of the appendages are characteristically helicoid, being curved downward instead of upward, as is more often the case. In the material on *Diopsis tenuipes* some of the specimens are very elongate, nearly a millimeter to the tip of the perithecium, and the rather rigid appendages project nearly at right angles to the axis of the receptacle. The species is curiously near to *L. cristata*, but is very well marked and distinct.

LABOULBENIA FALCATA Thaxter. Plate LXV, fig. 12.

Proc. Am. Acad. Arts and Sci., Vol. XXXV, p. 175. Dec., 1899.

Perithecium free or nearly so, mostly very large, pale yellowish, the inner half or more suffused with smoky brown, darker toward the margin, the base more or less strongly curved so that the perithecium is directed outward nearly at right angles to the axis of the receptacle or even recurved, basally inflated along the inner margin, tapering gradually from about the lower third to the apex; the tip not differentiated from the body of the perithecium, the lip-cells with darker longitudinal brown shades the outer more prominent, hyaline, notched; the inner rounded, brownish. Receptacle short, straight or nearly so, the basal cell broad, sometimes slightly inflated, a slight constriction often present between cells II and III, all the remaining cells unusually small in proportion. Outer appendage consisting of a small rounded basal cell bearing a single branch separated from it by a blackened constricted septum and consisting of a hyaline externally blackened basal cell bearing two branchlets; an outer externally blackened and bearing several vertical branchlets; an inner usually simple, hyaline or yellowish. Inner appendage consisting of a basal cell similar to that of the outer or slightly smaller, producing a branch on either side, each usually branched, all the branches pale yellowish with occasional brown suffusions, the longest not greatly exceeding the tip of the perithecium. Spores  $35 \times 3 \mu$ . Perithecium  $150-200 \times 35-55 \mu$ . Total length to tip of perithecium  $275-380 \mu$ ; to insertion-cell  $140-190 \mu$ . Width  $34-40 \mu$ . Appendages  $175-275 \mu$ .

At the base of elytra and on superior prothorax of *Casnonia* sp., Paris Mus. No. 116 bis, Bahia, Brazil.

A well marked species, chiefly peculiar for the large size and unusual form of its perithecium, which is twisted so that the inner and outer lip-cells are lateral in position. The outer lip-cells project slightly above the inner, and form a characteristic sulcate somewhat asymmetrical apex. The material is somewhat scanty and for the most part in bad condition. No specimens show the form and arrangement of the antheridia, yet the species appears to be most nearly allied to *L. equatorialis*, which also occurs on *Casnonia* in Brazil.

LABOULBENIA EQUATORIALIS Thaxter. Plate LXV, figs. 10-11.

Proc. Am. Acad. Arts and Sci., Vol. XXXV, p. 174. Dec., 1899.

Perithecium free, hyaline becoming tinged with brown, slender and elongate; the basal wall-cells forming a well marked though not clearly differentiated hyaline stalk; a median and subterminal external prominence; the rather broad tip more or less deeply tinged with blackish brown, rather abruptly differentiated and bent outward, the lip-edges hyaline, the inner lip-cells prominent, more deeply suffused. Receptacle very long and slender, cell I short, cell II greatly elongated, cells III and VI about equal. Insertion-cell broad, deeply blackened. Outer appendage consisting of a somewhat rounded basal cell, which is hyaline externally, distally suffused with blackish brown, and bearing two branches antero-posteriorly; the outer of which consists of a nearly isodiametric basal cell, becoming opaque except its upper inner angle, from which arise two branches; the inner simple, becoming red-brown, distinguished by a broad black septum, the outer consisting of a small basal cell, opaque, except its inner upper hyaline angle, and bearing two branches; an inner dark red-brown and slender, an outer curved outward and upward, more slender, deep red-brown, opaque toward the base, the inner branch from the basal cell of the outer appendage consists of a basal cell like that of the outer branch, which bears distally two branches, red-brown, about equal, the lower two cells inflated inward. The inner appendage consists



of a slightly smaller basal cell bearing a branch on either side, the basal cell of each branch shorter, and giving rise typically to paired branchlets from the basal cells of which the large, long, slender deep red-brown antheridia are produced in pairs. Perithecia 400–760  $\mu$ . Total length to tip of perithecium, average 550  $\mu$ ; longest over 1 mm.; average breadth 50  $\mu$ . Appendages, longest 375  $\mu$ .

On upper surface of prothorax, at base of elytra and on legs of *Casnonia* sp., Brit. Mus. No. 502, Amazon River.

A very distinct species, readily recognized by its long large slender dark paired antheridia, its slender coarse tipped perithecium, etc. It does not appear to be very closely allied to any described species, unless perhaps to *L. falcata*, which occurs on a similar host in Brazil.

LABOULBENIA DENTIFERA Thaxter. Plate LXI, fig. 8.

Proc. Am. Acad. Arts and Sci., Vol. XXXVIII, p. 34. June, 1902.

Perithecium relatively large, as long or longer than the receptacle, straight, erect, almost wholly free, rather dark dull brown; the outer margin distally converging rather abruptly in an almost straight line to the apex; one (the right) of the lateral lip-cells prolonged obliquely inward and upward to form a large tooth-like projection. The receptacle relatively short and stout, the basal cell longer, hyaline and contrasting, except distally, where it is involved in the general uniform dark dirty olive-brown suffusion of the rest of the receptacle, the cells of which are short and broad, punctate, hardly distinguishable. The insertion-cell thick, black, rather narrow, the basal cell of the outer appendage short and stout, bearing distally an inner and an outer branch, the basal cell of the outer bearing two branches, the black contrasting constricted base, only, of the outer, persisting; the appendages otherwise hyaline, stout, tapering slightly; the basal cell of the inner appendage very small, roundish, bearing a branch on either side with single antheridia near the base. Perithecium  $125 \times 32 \mu$ , the tooth-like appendage 20  $\mu$ . Receptacle  $115 \times 55 \mu$ . Appendage 220  $\mu$ . Total length to tip of perithecium 240  $\mu$ .

A single specimen on the margin of the elytra of *Notiobia disposita* Bates; British Museum No. 678; Chontales, Nicaragua.

A more careful examination of the type of this species suggests that the very peculiar conformation of the tip of the perithecium may be to some extent abnormal. It is to be hoped that more material may be obtained from which its characters may be more exactly determined. It is hardly possible to say to what species it is most nearly allied.

LABOULBENIA CHIRIQUENSIS Thaxter. Plate LVI, fig. 18.

Proc. Am. Acad. Arts and Sci., Vol. XXXV, p. 164. Dec., 1899.

Perithecium yellowish brown, straight, the inner margin convex, the outer slightly concave, tapering distally to the broad short blackened tip, which is bent abruptly inward almost at right angles. Receptacle yellowish brown, deeper in the region of cell III, the basal cell slightly curved, its upper half rather abruptly expanded; a more or less distinct bulge below the perithecium. Outer appendage usually simple, stout, the basal cell of the inner usually much smaller bearing a branch on either side usually once branched above the basal cell; all the branches stout and constricted at the lower septa. Spores  $60 \times 4 \mu$ . Perithecium  $100\text{--}125 \times 37 \mu$ . Total length to tip of perithecium 200–270  $\mu$ ; to insertion-cell 135–160  $\mu$ . Greatest width 55  $\mu$ .

On margin of elytron of *Callida scintillans* Bates, Brit. Mus. (Biologia Coll.), No. 735, Volcan de Chiriqui, Panama.

This species is chiefly distinguished by the peculiar conformation of the tip of its free perithecium which is somewhat similar to that seen in *L. Loxandri*. The two species, however, are otherwise readily distinguishable.



LABOULBENIA EUDALÆ Thaxter. Plate LVIII, figs. 7-8.  
Proc. Am. Acad. Arts and Sci., Vol. XXXVIII, p. 36. June, 1902.

Perithecium transparent brown, nearly straight externally, the inner margin somewhat convex; the inner lip-cells deeply suffused, contrasting, coarse, erect, prominent, the lip edges hyaline, outwardly oblique. Receptacle normal, rather short and stout, somewhat prominently rounded below the perithecium; cell III smaller than cell VI; cells IV and V broad, equal in length, prominent below the broad insertion-cell. Outer appendage consisting of from three to four mostly roundish or flattened superposed cells, constricted at the blackened septa, which become oblique by the proliferation of each cell from its inner side to form a single, usually simple, erect branch; the branches eventually stout, rather closely septate, thick-walled; the basal cell of the inner appendage half as large as that of the outer, producing one or more simple branches similar to those of the outer appendage, and short antheridial branchlets, which bear the brown, slightly curved antheridia in a rather dense group. Spores  $72 \times 5 \mu$ . Perithecia  $150-155 \times 55 \mu$ . Receptacle  $170-220 \mu$ . Appendages  $180-225 \mu$ . Total length to tip of perithecium  $250-350 \mu$ .

On elytra and legs of *Eudalia latipennis* MacLeay, Port Denison, Australia. Berlin Museum, No. 952.

The outer appendage is broken in all the types of this species which are not very young, but in the latter the character of the appendage is clearly shown (fig. 8); the primary axis consisting of short inflated cells, each of which is distinguished by a blackened septum and bears a branch from its inner side. The relationships of this species are quite uncertain, but perhaps it may be placed as well near *L. Loxandri* as elsewhere, although the outer appendage of the latter species is simple.

LABOULBENIA LOXANDRI Thaxter. Plate LVI, fig. 5.  
Proc. Am. Acad. Arts and Sci., Vol. XXXV, p. 183. Dec., 1899.

Perithecium about three fourths free, suffused with brownish, translucent, the distal half narrow and strongly curved inward, especially at the tip, the latter externally and distally blackened, the lip-edges hyaline. Receptacle rather stout, pale dirty brownish; cell II basally and distally and cell VI externally more deeply suffused. Cells IV and V elongated so that they become parallel and carry the insertion-cell upward and outward free from the perithecium. Outer appendage consisting of a rounded basal cell bearing a single terminal branch, the basal cell and one or two cells above it rounded, constricted at the mostly blackened septa, simple or each of the lower cells producing distally on the inner side a branchlet, the branchlets and the terminal portion of the main branch hyaline, slender, thin-walled, tapering. Inner appendage consisting of a basal cell like the outer and like it producing a branch on either side. Spores about  $45 \times 4 \mu$ . Perithecium  $140 \times 40 \mu$ . Total length to tip of perithecium  $340 \mu$ ; to insertion-cell  $275 \mu$ . Appendages, longest  $120 \mu$ .

On elytra of *Loxandrus unistigma* Bates, Brit. Mus. No. 659 (Biologia Coll.), Paso Antonio, Guatemala.

A well marked species, perhaps allied to *L. Chiriquensis*, but differing in its appendages and in other important respects. It has been seen only in one instance among the numerous forms of *Loxandrus* examined.

LABOULBENIA EGÆ Thaxter. Plate LVI, fig. 12.  
Proc. Am. Acad. Arts and Sci., Vol. XXXV, p. 173. Dec., 1899.

Perithecium free or nearly so, slender, usually somewhat curved inward, becoming evenly suffused with pale-olive brown, the broad tip not differentiated from the body of the perithecium, the lip-cells more or less suffused with darker brown. Receptacle pale yellowish, often elongate, the basal cell short; cell II several times as long, becoming amber-brown with transverse striations; cells III and VI about equal, elongate. Insertion-cell not deeply blackened. Outer appendage consisting of a usually somewhat inflated basal cell with thick outer wall, bearing a branch terminally distinguished by a thin black septum



and often a second subterminally on the inner side, the branches simple or once branched, subhyaline; the inner appendage consisting of a basal cell half as large as that of the outer, bearing one to three simple or once divided branches on either side: the branches of both appendages subhyaline, mostly thin-walled, erect in a compact small tuft, tapering slightly, extending but slightly above the tip of the perithecium. Perithecium  $190-225 \times 34 \mu$ . Total length to tip of perithecium  $540-680 \times 65 \mu$ ; to insertion-cell  $375-470 \mu$ . Appendages  $175-200 \mu$ .

On elytra of *Ega* sp., Paris Mus. No. 151, Acapulco, Mexico. On *Ega Sallei* Chev., Brit. Mus. No. 705, Biologia Coll., Paso Antonio and Champerico, Guatemala.

A slender pale species which varies in the development of its appendages, the basal cells of which are variably proliferous; the outer, which is characteristically inflated, bearing from one to three branches, one of which may obscure those of the inner basal cell, as in fig. 12, from which one to two branches may arise on either side. It does not appear to be nearly related to any of the described species, but is perhaps as nearly allied to *L. Philonthi* as to any other.

LABOULBENIA COLUMBIANA Thaxter. Plate LVI, figs. 6-7.

Proc. Am. Acad. Arts and Sci., Vol. XXXVIII, p. 30. June, 1902.

Uniform amber-yellow. Perithecium straight, free, converging abruptly from the base toward the appendages at an angle of about  $45^\circ$ , slightly and nearly symmetrically inflated, the tip relatively broad, with darker subterminal suffusions; the lip-cells somewhat spreading, the posterior and two lateral ones forming distinct ear-like lateral horizontal prolongations. Receptacle normal, tapering to the pointed foot, the basal and subbasal cells relatively large, the latter largest, cells IV and VI subequal; cell V separated obliquely from cell III, and somewhat longer than cell IV, which is separated by a horizontal septum. Insertion-cell thick, somewhat translucent, purplish. Outer appendage simple, short; the basal cell faintly purplish, more or less abruptly convex externally, separated by a constriction and dark septum from the subbasal cell, which is also distinguished above by a dark septum, basal cell of the inner appendage smaller than that of the outer, bearing a simple short erect branch on either side. Spores  $50 \times 4 \mu$ . Perithecia  $20-25 \times 90-110 \mu$ . Receptacle  $150 \times 30 \mu$ . Appendages  $40 \mu$ . Total length to tip of perithecium  $200-250 \mu$ .

On bristle-like hairs on the elytra of *Anchonoderus concinnus* Reiche, Columbia; Berlin Museum, No. 1023.

A single specimen, fig. 7,  $680 \mu$  long, with a free perithecium curved outward, with only lateral finger-like projections and with appendages  $300 \mu$  in length which are otherwise similar to those of the type, was found on the same host; but in the absence of further material it is not possible to determine whether or not it should be considered a mere variety. It is not impossible that the type form on spines owes its short habit and small size to less abundant nutrition, but the two may prove distinct.

LABOULBENIA PHILONTHI Thaxter.

This species appears to be strictly American, and nothing resembling it, except perhaps *L. Bledii*, occurs on other staphylinids. Additional material has been obtained as follows: British Museum; No. 747 on *Philonthus ochromerus* Sharp, Vera Cruz; No. 748 on *P. occultus* Sharp, Guatemala; No. 749 on *P. incertus* Solsk., City of Mexico. Sharp Coll.; No. 1108 on *P. acciderus* Sharp, Guatemala; No. 114 on *P. furvus* Nordm., var. *Flohrii* Sharp, Mexico; No. 1115 on *P. furvus* Nordm., California. It has also been obtained on numerous undetermined *Philonthi* from New England and Florida and is the common species on these hosts in temperate South America.

LABOULBENIA BLEDDII Thaxter. Plate LVI, figs. 8-10.

Proc. Am. Acad. Arts and Sci., Vol. XXXVIII, p. 27. June, 1902.

Color uniformly pale dirty yellowish. Perithecium more than two thirds free, rather slender, tapering to the tip, which is more or less well distinguished; the lip-cells rather coarse and prominent, with a sub-



terminal blackish shade on the inner side. Appendages divergent and free through the enlargement of cell V: the outer appendage simple, short, four- to five-celled; the basal cell of the inner appendage somewhat smaller than that of the outer, bearing a branch on either side similar to the outer appendage, the three straight closely applied in a more or less compact group. Receptacle rather coarsely punctate, the basal cell slender below and suffused above the foot, rather short, and separated from the usually very long subbasal cell by a more or less distinct constriction; cells III, IV and VI subequal, more than half the upper margin of cell V free. Perithecia  $100-125 \times 35-40 \mu$ . Receptacle  $220-275 \times 45 \mu$ . Appendages about  $90 \mu$ . Total length to tip of perithecium  $290-360 \mu$ .

On elytra and abdomen of *Bledius jacobinus* Lec., California; Sharp Collection, No. 1174, on *Bledius basalis* Lec., Florida (Henshaw Collection).

Figure 8 and 10 of the accompanying plate represent the Californian specimens of this species, and fig. 9 one of the smaller stouter forms occurring on *Bledius* in Florida. None of the material is in very good condition and I have even been led to suspect that the species might prove a depauperate condition of *L. Philonthi* which, however, in its typical condition would appear to be abundantly distinct.

LABOULBENIA FORMICARUM Thaxter. Plate LVIII, figs. 14-15.

Proc. Am. Acad. Arts and Sci., Vol. XXXVIII, p. 39. June, 1902.

Basal cells of the perithecium small, compact, not distinguished from the body, which is suffused by darker brown shades and tapers from near the broad base, with but slight inflation, to the well-distinguished tip; which is more or less distinctly curved outward, with subterminal blackish suffusions on both sides; the rather blunt, coarse-lipped apex outwardly oblique. Receptacle abnormal in form, very short and stout, the basal cell small hyaline, narrow below, abruptly broader distally below the subbasal cell, which is broader than it is long and bulges prominently externally, giving the plant a humpbacked habit; cell III small, broader than it is long; cell IV small, squarish separated from cell V which is slightly smaller, by a nearly vertical septum. Appendages normal, insertion-cell blackened, but not deeply, the outer appendage simple, the three lower cells inflated, the subbasal cylindrical and distinguished by dark septa. Spores  $30 \times 2.5 \mu$ . Perithecia  $50-60 \times 16-18 \mu$ . Receptacle  $30-35 \times 18 \mu$ . Longest appendages  $90 \mu$ . Total length to tip of perithecium  $70-80 \mu$ .

On all parts of *Lasius Americanus* M. and of *Formica neogagates* M., Cambridge, Mass.

This very minute and peculiar species appears to be common on small ants in the Cambridge region. It is perhaps as nearly related to *L. inflata* as to any other species, the appendages being very similar in both cases. The conformation of the receptacle is, however, unlike any other species. *Rickia Wassmanni* is thus far the only other member of the family that is known to occur on true ants.

LABOULBENIA MICROSCOPICA Thaxter. Plate LVI, fig. 17.

Proc. Am. Acad. Arts and Sci., Vol. XXXV, p. 187. Dec., 1899.

Perithecium one half or wholly free, pale olivaceous, somewhat inflated, tapering to the relatively long narrow subtruncate blackened tip which is bent slightly inward. Lower half of receptacle greatly reduced in size, the basal cell hyaline or nearly so, the rest suffused with dark brown, cell III paler, cell II broader than long, cells III to V relatively large, bulging prominently outward beyond and below the insertion-cell. Outer appendage consisting of a basal cell which becomes sub-triangular through the protrusion of its upper outer angle which renders its distal margin twice as broad as the basal cell of the single branch which rises from its upper inner half. The inner appendage arising from a much smaller basal cell which produces two branches. Spores about  $35 \times 3 \mu$ . Perithecia  $75-93 \times 27-34 \mu$ . Total length to tip of perithecium  $120-140 \mu$ ; to insertion-cell  $75-90 \mu$ . Greatest width  $45-60 \mu$ . Appendages about  $70 \mu$ .

On elytra of *Pelmatellus nitescens* Bates, Brit. Mus. (Biologia Coll.), No. 683, Vera Paz, Guatemala.

One of the very smallest species, in which the perithecium is larger than the whole of the receptacle. Apart from other peculiar characters, the shelf-like projection of the basal cell of the outer appendage



serves to distinguish this form, a somewhat similar conformation occurring only in *L. Tachys*. Three specimens, only, have been examined.

LABOULBENIA TACHYIS Thaxter. Plate LVI, fig. 15.

Proc. Am. Acad. Arts and Sci., Vol. XXXVIII, p. 38. June, 1902.

Form slender. Perithecium tinged with brown, relatively small, narrow, erect, very slightly curved outward distally; about three quarters free, tapering slightly to the relatively broad, hardly differentiated tip; the lip-cells coarse, outwardly oblique, with hyaline edges. Receptacle slender, the basal and sub-basal cells hyaline, elongate, nearly equal in length; the distal portion tinged with brown. Basal cell of the outer appendage forming a well defined prominence distally and externally; its upper surface horizontal, the outer half free, the inner half bearing a solitary branch which may be rather elongate, slender tapering; its basal cell short, somewhat inflated, distinguished by dark septa; the basal cell of the inner appendage giving rise to an erect branch on either side similar to the outer. Perithecia  $60-75 \times 16-25$ . Receptacle 110-166. Appendages longest  $220 \mu$ . Total length to tip of perithecium 155-220  $\mu$ .

On *Tachys incurvus* Say, Cambridge. On *Tachys* sp., Coconut Grove, Florida, December. On *Tachys* sp., Kittery Point, Me.

This small and slender species is peculiar for the conformation of the basal cell of its outer appendage, the external projection of which varies somewhat in different specimens. It resembles *L. microscopica* in this respect, but is otherwise quite different. It appears to be a rare species, occurring singly, or in pairs, on a given individual of its minute host. Specimens on the legs may be much shorter and more compact in habit.

LABOULBENIA OLIVACEA Thaxter. Plate LV, fig. 3.

Proc. Am. Acad. Arts and Sci., Vol. XLI, p. 315. July, 1905.

Perithecium nearly free, broader distally, olivaceous brown, paler and subhyaline distally on the inner side; the inner margin bulging characteristically above and curved abruptly outward to the tip, which forms a flat blunt hyaline papilla, turned outward and hardly distinguished from the body of the perithecium, and wholly subtended by a wide blackish suffusion, the outer margin forming a slight curvature continuous with that of the receptacle. Receptacle relatively small, the basal cell small, narrow, and quite hyaline, except distally, where it is partly involved in the dark olive-brown suffusion of the rest of the receptacle, which is coarsely punctate in the region of cells II and III, sometimes becoming wholly opaque and indistinguishable from the base of the perithecium, with the exception of cell V and a corresponding cell of about equal size which lies external to it, being cut off distally from cell IV, the receptacle being abnormal in this respect. These two cells hyaline or translucent, the whole anterior margin, from the base of cell II to the tip of the perithecium, forming a nearly symmetrical continuous curvature. Outer appendage consisting of a small slightly prominent basal cell, slightly constricted above, where it is separated by a blackish septum from a hyaline erect slender nearly straight distal portion or branch: the basal cell of the inner appendage somewhat smaller, giving rise to several erect branches, like the outer, which reach about to the tip of the perithecium, or may be longer. Perithecia  $80-100 \times 32-40 \mu$ . Receptacle  $90 \mu$ . Appendages  $75-110 \mu$ . Total length to tip of perithecium  $185-220 \times 40-48 \mu$ .

On legs and on the inferior surface of the abdomen of *Lebia* sp., Java; Rouyer, No. 1396.

Closely resembling *L. curtipes* in general form, but unlike all other species in the regular secondary division of cell IV by a horizontal septum, a condition which appears to be the normal one, as it is present in all of the ten examples examined. This condition is approached in *L. Anaplogeni* in which, however, the division is not invariably present, and results from a distal proliferation.



## LABOULBENIA PRODUCTA Thaxter. Plate LXIV, figs. 13-14.

Proc. Am. Acad. Arts and Sci., Vol. XXXVIII, p. 52. June, 1902.

Perithecium faintly tinged with pale dirty brown, rather long and slender, nearly erect, free except the rather narrow subhyaline base; the lips somewhat prominent, outwardly oblique, the inner subtended by a dark suffusion. Receptacle tapering to a slender pointed base, the basal cell hyaline, becoming faintly tinged with dirty brownish, contrasting with the opaque subbasal cell which is less than twice as long; cells III and VI subequal, nearly opaque, reddish brown; cell IV nearly opaque, continued upward to form a free blunt well-defined prominence which projects beside and slightly beyond the basal cell of the appendage; cell V relatively very large, extending to the base of cell IV, wholly pale dirty brown like the perithecium, contrasting. Insertion-cell relatively large, slightly oblique inward, resting below on cell V and laterally and obliquely on cell IV. Basal cells of the appendages nearly equal, subisodiametric, the outer bearing an outer and an inner simple hyaline branch distally, the basal cells of which, especially the inner one, are more or less inflated, roundish, with dark septa, and tinged with dirty brown; the basal cell of the inner appendage bearing a branch on either side similar to those of the outer, the branches hardly extending to the tip of the perithecium. Spores  $55 \times 4 \mu$ . Perithecium  $90-100 \times 25 \mu$ . Receptacle  $110 \mu$  to insertion-cell, the projection above  $10-12 \mu$ . Total length to tip of perithecium  $220 \mu$ .

Growing appressed on the bristle-like hairs on the elytra of *Anchonoderus concinnus* Reiche, Columbia; Berlin Museum, No. 1023.

This species is widely different from any other known species and is at once distinguished by the finger like protrusion of cell IV. The only other species that shows a similar tendency is *L. Anaplogeni* to which, however, it is not at all related. The type of the appendages, the short inflated basal cells of the branches, and their dark septa and mode of origin, suggest a remote connection with forms like *L. celestialis*, but it seems on the whole distinctly isolated. Fig. 13 represents a well developed individual obtained on an undetermined host, without locality, in the collection of the Museo Nacional at Buenos Aires.

## LABOULBENIA CELESTIALIS Thaxter. Plate LXV, figs. 13-14.

Proc. Am. Acad. Arts and Sci., Vol. XXXV, p. 163. Dec., 1899.

Perithecia almost wholly free, rather deeply suffused with dark reddish brown except the almost hyaline basal wall-cells; tapering slightly to the well distinguished rather large tip, which is turned slightly outward, the lip-cells blackened except around the pore. Receptacle finely punctate, pale dirty brown, darker along the posterior margin, the lower half of cell I hyaline, rather short and stout, somewhat abruptly expanded below the perithecium; cell IV bulging abruptly below the black insertion-cell. Outer appendage consisting of a somewhat rounded basal cell, brown externally, and bearing usually two branches placed antero-posteriorly, the basal cell of the outer nearly round, deep brown externally and bearing two branches placed antero-posteriorly which are very long and slender, remotely septate and more or less suffused with dirty brown: the inner appendage consisting of a smaller basal cell producing a branch on either side, the basal cells of which are short with black septa and bear solitary antheridia or short sterile branches which are blunt and shorter than the perithecium. Perithecia  $110 \times 35 \mu$ . Total length to tip of perithecium  $280 \mu$ ; to insertion-cell  $156 \mu$ . Greatest width  $55-60 \mu$ . Appendages (longest)  $400 \mu$ .

On the elytra of *Drypta lineola* Dej., Brit. Mus. No. 507, China. On *Dichranoncus celestinus*, Sharp Collection, No. 1204; and British Museum No. 636, Japan; on *Drypta ruficollis* Dej., British Museum No. 506, Natal, Africa.

The specimens on *Dichranoncus* referred to this species, differ somewhat in their more slender form, darker color, and deeply suffused perithecia; the receptacle is usually enlarged between cells I and II, and the inner branches from the basal cell of the outer appendage are often paired. In the Natal specimen this inner branch is not distinguished by the usual black septum. It is possible that we are here dealing



with more than one species, but in the absence of abundant material they have been included with the type. The latter is most nearly related to *L. Asiatica*, but should, I think, be kept distinct.

LABOULBENIA ASIATICA Thaxter. Plate LXV, fig. 15.

Proc. Am. Acad. Arts and Sci., Vol. XXXV, p. 159. Dec., 1899.

Perithecium and receptacle typical in form more or less suffused with dirty brownish yellow, the perithecium somewhat smoky-brown above the basal wall-cells. Outer appendage consisting of a very large subtriangular hyaline basal cell, which gives rise from a deeply blackened area of insertion to an antero-posterior series of short stout cells, themselves outwardly blackened and bearing from one to three branchlets, also placed antero-posteriorly and themselves mostly once branched in a similar plane; the ultimate branchlets rather long and remotely septate, the lower septa blackened and somewhat oblique. The inner appendage consists of a much smaller basal cell which gives rise on either side to a series of from two to three branches arranged antero-posteriorly, the lower septa blackened and more or less oblique, the branches once or twice branched, the branchlets shorter than those of the outer appendage. Perithecium  $140 \times 45 \mu$ . Total length to tip of perithecium 400–500  $\mu$ . Appendages (longest) 400  $\mu$ .

On the elytra of *Casnonia* sp., Asia, Paris, No. 139.

This species is exactly similar in the general form and appearance of its receptacle and perithecium, to the common types of *L. flagellata*, but differs in the crest-like series of branches, distinguished by black septa, that form dense tufts arising from the inner and outer basal cells of the appendages. The species is most nearly related to *L. celestialis*, of which it may prove to be a luxuriantly developed condition.

LABOULBENIA ACROGENIS Thaxter. Plate LXVI, figs. 6–8.

Proc. Am. Acad. Arts and Sci., Vol. XXXV, p. 154. Dec., 1899.

Perithecium rather slender, free except at its base, pale yellowish or straw-colored, becoming yellowish brown, tapering to the neck-like rather slender often almost clavate apex, the lip-cells hyaline, well distinguished, the inner large and prominent often spreading, the pore obliquely external: below more or less deeply suffused with smoky brown, especially the outer half, the posterior (outer) subterminal wall-cells often becoming deeply suffused with smoky brown. Receptacle usually short, becoming slightly suffused with yellowish brown, normal in form, sometimes slightly inflated between cells I and II. Outer appendage consisting of a large rounded basal cell bearing four to eight branches arranged antero-posteriorly in a more or less definitely double row, their insertions forming a continuous deeply blackened area, their-cells inflated, with blackened septa, successively once to three times branched antero-posteriorly. The inner appendage consisting of a much smaller basal cell producing from one to two branches similar to those of the outer, one on either side. The antheridia solitary or from two to four, borne rather regularly on the ends of short branchlets. Perithecium  $90\text{--}175 \times 28\text{--}35 \mu$ . Antheridia 14  $\mu$  long. Total length to tip of the perithecium 190–360  $\mu$ . Appendages 85–100  $\mu$ . Spores about 40  $\mu$ .

Occurring on the inferior posterior margin of the prothorax and the adjacent portions of the thorax of *Acrogenys hirsuta* MacLeary, Brit. Mus., Nos. 668 and 528, Australia, and Union Reefs, Australia.

This species is nearly allied to *L. Asiatica*, the appendages being similarly arranged, though very different in general appearance: the clear hyaline cells of the copiously divided branches inflated, and strongly constricted at the blackened septa, five or six of which may occur successively from the base upward. The conformation of the perithecium is distinctly different, especially at the tip, which is usually even more prominently distinguished than is represented in the figures, the inner lip-cell considerably enlarged to form a rounded or flat topped somewhat spreading termination. Two immature specimens were obtained on *Acrogenys* from Union Reefs, in which the branches are more copiously developed and the insertion-cell wholly unmodified. The antheridia, which are small and well formed, often occur in terminal groups of three to five, closely appressed, almost as in some forms of *L. Brachini*. (Monograph, Plate XX, fig. 7.)



## LABOULBENIA MINIMA Thaxter.

The figures drawn from the material available at the time my Monograph was published, give but an inadequate idea of the appearance of full grown specimens of this well marked and rather variable species, additional material of which has been obtained from the following sources; British Museum; No. 732 on *Callida pulchripennis*, no locality; No. 736 on *C. onypterigioides*, Volcan de Chiriqui, Panama; No. 551 on *Callida* sp., Mexico; No. 503 on *Pionycha* sp., Nanta, Amazon; No. 504 on *Leptotrachelus* sp. Sao Paulo (? Brazil); No. 510 on *Calophæna maculata* Dej., Para, Brazil: Hope Collection; No. 264 on *Agra* sp., South America: Paris Collection; No. 68-69 on *Callida* spp., Venezuela. All these forms, though undoubtedly referable to this species, show a certain amount of variation, in coloration, in the degree and conspicuousness of the punctation, which is sometimes very marked even on the perithecium; in the conformation of the tip of the perithecium, which is sometimes flat topped and peculiarly modified, and in the development of the appendages. The latter arise in crest-like series from the basal cells: one such series from the outer, which may consist of seven or eight members which arise by successive proliferation from the inner angle of the basal cell and are variably branched and suffused; the inner basal cells producing a somewhat similar series on either side. The general type is similar to that seen in *L. longicollis* which, although so very different in general appearance must be considered as not remotely related to it. On species of *Agra* in the Hope Collection, and in the British Museum, specimens occur in which the differences are so considerable that I think these forms may perhaps be specifically separated; but I have preferred to defer any further account of them until I have an opportunity properly to illustrate the present species, figures of which could not conveniently be included in the accompanying plates.

## LABOULBENIA BRACHINI Thaxter.

This species replaces *L. Rougetii* on American *Brachini*, but although very similar in form and color, differs distinctly in the centripetal proliferation of the basal cells of the appendages, in the black oblique septa of their branches, and in the grouping of the antheridia. Simple forms of this species in which there is no proliferation of the basal cells, are hardly distinguishable from some South African specimens of *L. Rougetii*, and in one instance typical *L. Brachini* was obtained on a specimen in the British Museum labeled "*B. oblongus* Dej. Tangier, Africa." That there is some error, either in my own, or in the Museum label, I feel quite sure; since this is the only instance among the very large number of Eastern-Hemisphere *Brachini* which I have examined, in which a form like *L. Brachini* has been observed. *L. Rougetii* var. *Japanensis*, with its dense stout appendages bears a superficial resemblance to this species, but there is no doubt in my own mind as to the distinctness of the two.

Additional material has been examined as follows. Paris Museum No. 67 on *Brachinus* sp., Venezuela; Hope Collection No. 249 on *Brachinus* sp., Rio de Janeiro; No. 245 on *B. fumans* Fabr., North America; No. 247 on *B. geniculatus* Dej., St. Thomas W. I., a curious hunched variety (?) with very simple appendages: British Museum No. 720 on *B. rhytiderus* Chd., Oaxaca, Mexico; No. 719 on *B. elongatus* Tourn. Mexico; No. 544 on *B. geniculatus* Dej., South America: Berlin Museum No. 990 on *B. Mexicanus* Dej., Mexico; No. 991 on *B. fusicornis* Dej., Buenos Aires, Argentina; No. 992 on *B. genicularis* Dej., Montivideo, Paraguay; No. 993 on *B. nigrescens* Chd., Brazil.

## LABOULBENIA LONGICOLLIS Thaxter. Plate LXIV, fig. 10.

Abundant material of this fine species has been obtained from various sources, and it seems to be the only form which occurs on the numerous African species of *Galerita*; in marked contrast to the multiplication of species which has taken place on this host in the western hemisphere. Although in its general appearance, large size and stalked perithecia, it recalls the condition seen in many of the American forms on *Galerita* it does not appear to be at all closely related to the species of this well marked "*Galeritæ*" type, the series of appendages arising, not from cells successively separated above the basal cell, but from the basal cell itself, which does not become divided during the process. The species shows no important



variations except in size. The additional material examined is as follows: Berlin Museum No. 972 on *Galerita femoralis* Murr., Gaboon; No. 971, on *G. attelaboides* Fabr., Guinea. Paris Museum No. 10 on *Galerita* sp., East Africa. British Museum No. 522 on *G. femoralis* Murr., E. Africa; No. 524 on *G. Africana* Dej., Angola; No. 523 on *G. interstitialis* Dej., Sierra Leone. Fig. 10 of the accompanying Plate is drawn from material on an undetermined species of *Galerita* collected by Dr. O. F. Cooke in Liberia.

LABOULBENIA ORIENTALIS Thaxter. Plate LXV, fig. 4-5.

Proc. Am. Acad. Arts and Sci., Vol. XXXV, p. 191. Dec., 1899.

Perithecium straight, its base free from and higher than the insertion of the appendages, straight to strongly recurved, becoming suffused with pale brownish; the tip blackish brown in normal specimens, well distinguished, with prominent lips (when curved, not abruptly distinguished, somewhat pointed, with ill defined lips), the translucent edges dirty brown. Receptacle hyaline or concolorous with the perithecium, sometimes becoming dark smoky brown; cell V often as large as cell IV, pushing the small subtriangular unmodified insertion-cell outward so that it may become lateral, with its transverse diameter vertical, cell VII unusually large. Appendages consisting of an outer and an inner basal cell, the two free from one another except at the base, mostly several times as long as broad and overlapping slightly; the outer bearing an external row of superposed branches, usually seven or eight in number, formed by the successive proliferation of the tip of the basal cell, and separated from it by broadly blackened septa; the branches successively subdichotomously branched several to eight or more times, the basal and sometimes the subbasal cell often producing more than two branchlets (two to four) superposed in a single row. The inner appendage like the outer, the basal cell producing a single similar row of branches fewer (usually two to four) in number, overlapping those of the outer appendage and bearing antheridia in groups of from one to eight not characteristically grouped, the venter rather abruptly distinguished from the straight cylindrical purplish neck: the branches of both appendages directed outward, hyaline or distally reddish or purplish, constricted at the lower purplish septa. Perithecia (largest)  $230 \times 55 \mu$ ; average  $170 \times 40 \mu$ . Total length to tip of perithecium very variable, from  $275 \mu$  to 1 mm. Appendages  $200-350 \mu$ . Antheridia  $16 \times 4 \mu$ . Spores  $65 \times 6.5 \mu$ .

On *Brachinus Chinensis* Chaud., Paris Museum, Nos. 58, 59; Manila, Philippine Islands, and Macao, China. Brit. Mus. Nos. 536 (bis), China. Hope Coll. No. 244, China. On *Brachinus* spp., Brit. Mus. Nos. 537, 539, 540, China and Philippine Islands, Berlin Mus., No. 994 on *B. scotomedes* Redt., Japan. Usually on inferior surface of thorax and prothorax.

This fine species is a characteristic form, common on the larger species of *Brachinus* from the far East. Although it has not been seen on the numerous *Brachini* examined from intermediate stations, the form previously separated as *L. Italica* on *B. explodens* from Italy, does not appear to be more than a variety. The species is decidedly variable in form, size and color, often abnormally bent, as in Fig. 5, or greatly elongated; becoming suffused in many cases till the perithecium is nearly opaque. The vertically elongated basal cell of its inner appendage lacks entirely the right and left development of branches which normally occurs in the genus, and usually overlaps the similarly developed basal cell of the outer appendage. A similar condition is seen in *L. pusilla*, *L. Japonica* and *L. rhinophora*, yet these three forms seem otherwise so different that their separation as distinct species appears desirable.

var. ITALICA Thaxter. Plate LXVI, figs. 9-10.

*L. Italica* Thaxter. Proc. Am. Acad. Arts and Sci., Vol. XXXV, p. 182. Dec., 1899.

Perithecium free except at its base, rather short and stout, the upper half or third curved strongly outward, the tip large, sulcate, blackened, the lips coarse, nearly equal, subhyaline. Receptacle concolorous with the perithecium, the base nearly hyaline, usually bent between cells I and II, short, abruptly expanded above cell II, the anterior margin straight above cell I. Appendages compact, the basal cells subtriangular, the outer producing externally an oblique row of about four superposed branches from a



blackened area of insertion, the branches erect mostly twice subdichotomously branched, all the lower septa blackened and constricted, the inner appendage similar to the outer: the insertion-cell unmodified normally placed, broad, subhyaline, close to base of perithecium. Antheridia brown, the venter much inflated, the neck becoming pointed,  $23 \times 8 \mu$ . Perithecium  $100 \times 42 \mu$ . Total length to tip of perithecium  $275 \mu$ ; to insertion-cell  $175 \mu$ . Appendages  $140 \mu$ .

On *Brachinus explodens* Duft., Florence Museum, Florence, Italy.

LABOULBENIA PUSILLA Thaxter. Plate LXV, fig. 6.

Proc. Am. Acad. Arts and Sci., Vol. XLI, p. 316. July, 1905.

Short, stout, pale yellowish with brownish tinges. Perithecium free, straight, very slightly narrower distally, the distal portion, except externally about the hyaline pore, deep black, the suffusion extending less than half-way down externally, and about a third on the inner side: the distal end broad, flat, projecting on the inner side to form a rounded prominence; the pore lateral and external, hyaline, with adjacent paler shades; the black, slightly projecting area below it forming a more or less clean-cut line of demarcation. The receptacle short and stout; cells I and II subequal, as are also cells III and IV. Appendages as in *L. orientalis*, hyaline, the two basal cells partly overlapping and bearing each four to five branches four to five times branched, the cells distinguished by constrictions and blackish septa. Spores  $45 \times 5 \mu$ . Perithecia  $90 \times 36-40 \mu$ . Receptacle  $100-110 \mu$ . Total length to tip of perithecium  $200 \times 210 \mu$ . Appendages  $100-110 \mu$ .

On inferior surface of *Brachinus scotomedes* Redt., Japan; Berlin Museum, No. 994.

This very peculiar little form is most nearly related to *L. orientalis* of which it may possibly prove to be an abnormal condition. It is however quite unlike the smaller forms of this species which grow in similar situations, and the types show no tendency to vary toward the normal form, even very young perithecia exhibiting the very peculiar conformation represented in fig. 6.

LABOULBENIA JAPONICA Thaxter. Plate LXV, fig. 7.

Proc. Am. Acad. Arts and Sci., Vol. XXXVIII, p. 44. June, 1902.

Short and stout, unevenly suffused with smoky or faintly olive brown. Perithecium relatively very large and long, more or less distinctly curved toward the appendages; the base subhyaline, the body evenly dark, slightly olivaceous brown, scarcely inflated, tapering very slightly to the stout, evenly rounded, opaque, hardly differentiated tip; the longitudinal series of wall-cells slightly spiral, describing about one quarter of a turn or somewhat more. Receptacle relatively small, short and stout, the basal and subbasal cells hyaline, contrasting, the latter somewhat larger, separated by an oblique partition from cell III, which is small, subtriangular and deeply suffused; cell IV larger, suffused, as is cell V, which is relatively large and long-oval; cell VI deeply suffused, extending down beside and to the base of cell II; the cells above it also suffused and more or less indistinguishable. Insertion-cell large and unmodified. Basal cells of the outer and inner appendages vertically elongated, each bearing externally and distally a series of four or five superposed branches distinguished by blackened septa, curved outward and often downward, and branching in a radial plane, the branches two to four times branched, forming a compact tuft, the basal cells usually bearing three branchlets, the further division of which is subdichotomous; the cells not differing very greatly in size, except the terminal ones, which are somewhat elongated hyaline subisodiametric and blunt-tipped. Spores  $80 \times 5 \mu$ . Perithecia  $235 \times 70 \mu$ . Receptacle  $185 \times 70 \mu$ . Appendages  $100-150 \mu$ . Total length to tip of perithecium, average,  $420 \mu$ .

On anterior legs of *Brachinus* sp., Japan; Sharp Collection, No. 1188.

This is a striking species allied to *L. orientalis* and more closely to *L. rhizophora*, which has the same peculiarly developed receptacle in which cell VI extends downward to cell I, although it lacks the monstrous development of cells IV and V peculiar to this species. The perithecium is also quite different and unlike any forms of *L. orientalis*, both in form and relative size. The appendages project out subhorizontally in a compact mass, with a tendency to recurve, and the branching is in a plane coincident



with that in which the individual is flattened. A somewhat smaller variety, which closely resembles this species, was found on the legs of a species of *Brachinus* from Port Natal, Africa (Berlin Museum No. 983), but the material is too scanty and not in sufficiently good condition to determine definitely.

LABOULBENIA RHINOPHORA Thaxter. Plate LXV, figs. 8-9.

Proc. Am. Acad. Arts and Sci., Vol. XXXV, p. 199. Dec., 1899.

Perithecium large and stout, dirty smoky brown, the lower half much deeper and united to the receptacle, the base nearly opaque, one of the subterminal wall-cells forming a terminal blunt finger-like brown outgrowth, close beside the rather small internally blackened tip, which it exceeds in length. Receptacle stout, the basal cell small hyaline; a blackish brown suffusion becoming opaque involves the upper part of cell II, cells III, VI, and VII, as well as the basal cells of the perithecium; cells IV and V very large and nearly parallel, translucent; the suffused parts, when not opaque, marked by darker transverse dots and striæ. Insertion-cell very large, triangular, quite unmodified. Appendages consisting of two basal cells concolorous with insertion-cell, the outer usually somewhat larger, both protruding upward and slightly overlapping, producing directly numerous branches (four to eight from each cell) which arise in more than one row from their outer surfaces; all the branches once to twice branched, the lower segments deeply constricted at the purplish septa, the distal cells without constrictions at the hyaline septa. Spores  $75 \times 5 \mu$ . Perithecia to tip of protuberance  $275-300 \times 85 \mu$ ; to insertion-cell  $300-340 \mu$ . Appendages about  $200 \mu$ .

On the legs of *Brachinus* sp., Hope Coll. No. 252, Madagascar.

Three mature and one young individual of this peculiar species have been examined, the former all considerably injured. It is most nearly allied to *L. Japonica* from which it is distinguished by the form and peculiar modification of its perithecium, as well as the relation of the latter to the receptacle and by the monstrous development of cells IV and V of the receptacle.

LABOULBENIA CONCINNA Thaxter. Plate LVIII, fig. 4.

Proc. Am. Acad. Arts and Sci., Vol. XXXVIII, p. 31. June, 1902.

Perithecium opaque, nearly symmetrical, rather long and slender, straight, the lower half slightly inflated; tapering very gradually distally to the broad, truncate often symmetrical tip, which is barely differentiated above an inconspicuous elevation; the flat lip-edges slightly translucent brown: the basal cells forming a well distinguished short hyaline stalk, the curvature of which bends the perithecium away from the appendages at an angle of nearly  $45^\circ$ . Appendages forming a dense rather short slightly spreading tuft, the axis of which is coincident with that of the receptacle, copiously branched, the branchlets unilaterally disposed, rather closely septate; the septa mostly dark brown, except the very numerous paler slightly tapering extremities, which hardly reach the middle of the perithecium. Receptacle subclavate, the basal cell rather large, hyaline narrower below; the cells above yellowish brown, inconspicuously punctate; cells III and IV bulging symmetrically and prominently below the well-defined insertion-cells; cells IV and V separated by a nearly vertical septum. Perithecia, exclusive of stalk,  $15-180 \times 33-45 \mu$ , stalk  $25 \times 30 \mu$ . Receptacle  $150-185 \times 55-65 \mu$ . Appendages (longest)  $125 \mu$ . Total length to tip of perithecium  $325-375 \mu$ .

On *Casnonia* sp., Buitenzorg, Java.

A small group of mature individuals of this very pretty and distinct species was found on one of several hosts kindly collected for me by Professor H. M. Richards, growing at the tip of the abdomen on the upper side, and conspicuous for their large size and dark color. The tuft of appendages is so dense that it has been almost impossible to determine the exact origin of the main branches. Several of the latter appear to arise in radial series from the basal cell of the outer appendage, and that of the inner appears to give rise as usual, to single branches on either side which are very copiously and closely branched. Although the perithecium is too deeply suffused to determine this point, there seems to be a twist in its wall-cells which makes the anterior and posterior lip-cells lateral in position, and gives the tip its characteristic nearly symmetrical habit.



LABOULBENIA IMITANS Thaxter. Plate LIX, figs. 24-26.

Proc. Am. Acad. Arts and Sci., Vol. XXXV, p. 180. Dec., 1899.

Perithecium free, long, rather slender, curved slightly outward, suffused with dark smoky brown, tapering rather abruptly to a somewhat truncate sometimes neck-like tip, the inner lip-cells darker: the basal cells forming a hyaline well developed neck. Receptacle short, stout, subtriangular, usually abruptly bent above the basal cell, becoming deeply suffused with blackish brown, coarsely and conspicuously punctate, except where quite opaque, the opacity first involving the anterior and lower portions above the hyaline basal cell: cells IV and V nearly equal, cell IV bulging outward, more than half its upper surface being free from and external to the black insertion-cell. Outer appendage consisting of a hyaline basal cell which may become entirely opaque, its upper and outer margins curving evenly inward to form a deeply blackened ridge, from which arises a crest-like series of from three to five, or even six, branches, which are rigid opaque or deeply suffused and several times branched, especially distally; the inner appendage consisting of a much smaller basal cell which gives rise to a branch on either side, the branches laterally divergent, or erect, and similar to the main branches of the outer appendage; the successive cells of all the branches and branchlets, except at the very tips, externally blackened and distinguished by contrasting and more or less prominent black septa. Spores  $42\ \mu$  long. Perithecium (exclusive of neck)  $150-255 \times 28-58\ \mu$ ; the neck  $20-60 \times 20-32\ \mu$ . Total length to tip of perithecium  $270-585\ \mu$ ; to insertion-cell  $100-225\ \mu$ ; greatest width  $50-80\ \mu$ . Appendages,  $45-200\ \mu$ .

On *Nycteis* sp., Paris Museum, No. 29, Madagascar. Berlin Museum No. 934, on *Thyreopterus brevicollis* Kl., and No. 935 on *T. sublævis* Casteln., both from Madagascar. On legs, elytra and abdomen.

This species which has very much the appearance of species of *Corethromyces*, is most nearly related to *L. forficulata* and *L. fissa*. In the material obtained in the Berlin Museum from *T. brevicollis*, the individuals are far larger than the original types, almost twice as large, but there seems no doubt as to the identity of the two, although the form of the perithecium and its tip is somewhat different in the Berlin material. On *T. sublævis* a single mature individual was found in which the total length reaches nearly  $800\ \mu$ ; the perithecium  $265 \times 65\ \mu$ , its neck  $150\ \mu$ ; the receptacle but slightly suffused, over  $325\ \mu$  long and without maculation. The appendages are, however, the same and the form is undoubtedly referable to the present species.

LABOULBENIA FISSA Thaxter. Plate LIX, figs. 12-13.

Proc. Am. Acad. Arts and Sci., Vol. XXXV, p. 177. Dec., 1899.

Perithecium three fourths or more free, short and stout, slightly bent toward the appendages, dirty olive-brown becoming deeply suffused with blackish brown except distally just below the tip, which is abruptly distinguished, long, narrow, hyaline below its black distal portion, furcate, the inner fork formed by the upgrowth of one of the inner (right) lip-cells which grows outward and abruptly upward beside the deep black blunt-tipped projection formed by the other three which it may equal in length, though narrower and somewhat paler. Receptacle short, the basal cell largest, pale yellowish or hyaline, of about the same diameter throughout, broader than cell II, which is short, narrow, of equal diameter throughout, hyaline or yellowish at the very base, the rest opaque and indistinguishable from the remainder of the receptacle, which expands abruptly above, and may become opaque, except the upper part of cell IV and cell V. Insertion-cell much narrower than cells IV-V. Outer appendage consisting of several superposed cells, which form a black opaque axis, usually broken off, curved outward, each cell producing a short hyaline or brown edged branchlet distally on the inner side; the inner appendage consists of a smaller basal cell, which gives rise on either side to a branch much like the outer appendage, its main axis less deeply blackened, curving outward on either side of the perithecium, the hyaline branchlets arising from its convex side mostly once branched and sometimes reaching above the tip of the perithecium. Perithecia, average  $150 \times 48\ \mu$ , including the tip, which is about  $45 \times 18-20\ \mu$ . Total length to tip of perithecium  $290-300\ \mu$ ; to insertion-cell  $185\ \mu$ ; greatest width  $70\ \mu$ . Appendages about  $110\ \mu$ .



On *Pericallus guttatus* Chev., Paris Museum, No. 78; Brit. Mus. No. 571; Hope Collection, No. 301, Java; Sharp Collection No. 1202. On *P. flavoguttatus* Dej., E. Indies. Hope Coll. No. 279, Type On elytra.

This very peculiar species is well characterized by the unique modification of the tip of its perithecium, which looks like a pair of mandibles. The more slender of the two projections varies somewhat in length, and is not always as erect as is represented in the figures, and the whole tip sometimes has the slightly bulbous habit indicated in fig. 13. The branches of the inner appendage may be erect, as in fig. 13, or strongly divergent on either side, as fig. 12, which also shows the appearance of the fully matured and nearly opaque individual. The species is most nearly allied to *L. separata* and *L. corethroopsis*.

LABOULBENIA FORFICULATA Thaxter. Plate LIX, figs. 9–11.

Proc. Am. Acad. Arts and Sci., Vol. XXXV, p. 178. Dec., 1899.

Perithecium free, straight or somewhat curved, slightly inflated, brown except the basal wall-cells which form a mostly hyaline well developed narrow neck-like stalk less than one third as long as the ascigerous portion, the latter tapering rather abruptly at the tip, two of the lip-cells prolonged to form a pair of erect pointed hyaline symmetrical apposed outgrowths which resemble the tips of a pair of shears. Receptacle short, stout, subtriangular, cell I hyaline below, forming a short slender usually curved pedicel; the body of the receptacle deeply suffused below with blackish brown, the more deeply suffused portions coarsely punctate with darker spots. The outer appendage consisting of a basal cell from the blackened upper and outer margin of which arise usually three branches in an antero-posterior series, which are curved slightly outward and give rise from their convex side to secondary branches which in turn may bear branchlets in a similar fashion: of the primary branches the inmost is more copiously branched, the outmost being small, usually broken; all the branches black externally and brown on the inner margins, or wholly opaque, usually constricted on the inner side at the blackened septa, the terminal cells of some of the ultimate branchlets abruptly inflated at the base: the basal cell of the inner appendage gives rise to a branch on either side, the two divergent and very similar in character and mode of branching to those of the outer appendage. Perithecium exclusive of neck,  $150\text{--}200 \times 28\text{--}38 \mu$ ; the neck  $35\text{--}50 \mu$  long. Total length to tip of perithecium  $300\text{--}450 \mu$ ; to insertion-cell  $100\text{--}150 \mu$ ; greatest width  $50\text{--}70 \mu$ . Appendages  $175\text{--}200 \mu$ .

On *Thyreopterus striatus* Guer., Hope Collection, No. 302, Madagascar. On elytra.

This species is very closely allied to *L. imitans* in its general form and the character of its appendages, and is also the nearest known relative of the two large species, *L. palmella* and *L. Kunkeli* which occur on the allied *Mormolyce*. It is distinguished from all other species by the shear-like tip of its perithecium. The material is scanty and the appendages are badly broken in all the adults. Whether the flask-like terminations of the inner appendages represented in fig. 9 are sterile extremities, or peculiar antheridia I am unable to determine, although I am inclined to the former view.

LABOULBENIA PALMELLA Thaxter.

This species has been obtained on *Mormolyce phyllodes* in the Brit. Mus. No. 556, Ding Ding Is. and No. 556b, Penang, and in the Berlin Museum No. 975a, Sumatra, on the same host. It appears to be constant in its characters and always separable from the much larger *L. Kunkelii*, which has been again observed on the inferior surface of a specimen of *M. phyllodes* from Sumatra in the British Museum, No. 556.

LABOULBENIA CORETHROPSIS Thaxter. Plate LIX, figs. 3–6.

Proc. Am. Acad. Arts and Sci., Vol. XXXV, p. 168. Dec., 1899.

Perithecium relatively large, translucent brown or yellowish brown, generally larger distally through a subterminal external bulge, the tip moderately well differentiated, often bent rather abruptly inward, wholly blackish brown or hyaline in the median line, the inner lip-cells smaller and usually more prominent than the outer, sometimes overlapping them, the whole perithecium free from the receptacle. Recep-



taele short and rather stout, cells II–IV becoming externally blackish brown, the rest concolorous with the perithecium; cells III and IV rather prominent. Outer appendage becoming wholly opaque, its successive cells indistinguishable as are the basal and insertion-cells, consisting of a blackened axis erect or bent outward, from the inner side of which arise several more or less blackened branches, the basal portion of the appendage only, as a rule, remaining. The inner appendage, consisting of a basal cell which is usually indistinguishable from the insertion-cell, being quite opaque, producing a branch on either side, the axis of the branches erect, becoming blackened and opaque, except the inner margins of the distal cells, bearing externally from six to ten or even more branchlets which are more or less deeply suffused. Perithecium  $130\text{--}150 \times 30\text{--}33 \mu$ . Total length to tip of perithecium  $190\text{--}240 \mu$ ; to insertion-cell  $90\text{--}130 \mu$ . Greatest width  $40\text{--}50 \mu$ . Appendages longest (broken)  $185 \mu$ .

On inferior surface of abdomen, and on elytra of *Miscelus Javanus* Klug., Hope Collection, No. 304, Java; on *Miscelus* sp., Paris Museum, No. 114, New Guinea.

This somewhat variable species occurs on the elytra and abdomen of its host. Its small receptacle and relatively large perithecium, together with its peculiar appendages, give it, like the allied *L. imitans*, a general habit which strongly suggests some species of *Corethromyces*. The main axis of the outer appendage, as well as the main branches of the inner, appear to result from successive proliferation and may be quite opaque. The species is very closely allied to *L. Misceli* from the Moluccas, which may prove merely a paler variety. The figures represent specimens from the type slide on *M. Javanus* from Java.

LABOULBENIA MISCELI Thaxter. Plate LIX, figs. 19–20.  
Proc. Am. Acad. Arts and Sci., Vol. XXXV, p. 189. Dec., 1899.

Perithecium free, long and slender, translucent, pale brownish olive, slightly narrowed at the base to form a short paler stalk which lies opposite the insertion-cell; the tip long, not very abruptly distinguished, paler below, straight or turned slightly outward, distally blackened on the inner side; the lips variable, rather prominent. Receptacle rather short and stout, darker olive-brown; the basal cell pale yellowish. Insertion-cell nearly as broad as cells IV–V. Basal cell of outer appendage blackish brown externally, bearing a single terminal branch of less diameter, externally suffused with blackish brown, slightly curved outward and bearing two or three branchlets from the inner side which are hyaline, their basal cells somewhat suffused with brown; the basal cell of the inner appendage smaller than that of the outer, nearly hyaline and bearing a branch on either side similar to the outer appendage; both the appendages and their branches erect, subappressed. Perithecia including base  $145\text{--}180 \mu$ . Total length to tip of perithecium  $240\text{--}300 \mu$ ; to insertion-cell  $90\text{--}130 \mu$ ; greatest width  $35\text{--}40 \mu$ . Appendages, longer  $150 \mu$ .

At base of posterior legs of *Miscelus* sp., Paris Museum, No. 114 bis, Isles des Moluques.

This species is too closely allied to *L. Corethroopsis*, of which it will probably prove to be merely a variety. It differs in its paler color, and erect and unsuffused appendages, which are however, very similar in structure. The general appearance of the two is distinctly different and they are kept apart provisionally until more and better material of both forms can be examined.

LABOULBENIA SEPARATA Thaxter. Plate LIX, figs. 1–2.  
Proc. Am. Acad. Arts and Sci., Vol. XXXV, p. 200. Dec., 1899.

Perithecium pale olivaceous, the inner margin convex, the outer nearly straight; the tip rather abruptly distinguished, blackened, but not uniformly, below the inner lip-edges which are prominent, olivaceous, translucent, the right inner lip prolonged to form a slender nearly hyaline finger-like projection, the tip of which is blunt and somewhat swollen. Receptacle relatively large dull olivaceous, cells, II, III, and IV sometimes becoming blackish brown externally, cells III and IV rather large; the insertion-cell close to the base of the perithecium, half as broad as cells IV and V. Outer appendage curved strongly outward, opaque and indistinguishable from the insertion-cell, bearing three or four branches from its convex side which are mostly once branched; the inner appendage consisting of a small basal cell, bearing



a branch on either side externally blackened, somewhat curved outward, and bearing three or four branchlets which are curved toward the perithecium, externally or wholly brownish toward the base. Perithecia  $100-110 \times 25-30 \mu$ . Total length to tip of perithecium  $220-260 \mu$ ; to insertion-cell  $130-165 \mu$ ; greatest width  $55 \mu$ . The prolongation of the lip-cell extending about  $20 \mu$  or more beyond the tip of the perithecium.

On *Pericallus guttatus* Chev., Brit. Mus. No. 571, Java. Margins of elytra.

This well marked species is allied to *L. corethroopsis* and *L. fissa*, the general characters of the appendages being similar in all three species. The conformation of the tip of the perithecium in the present species, with its obliquely projecting finger-like outgrowth, as well as its general form, large receptacle, and small perithecium, serve abundantly to distinguish it. On the other hand it appears to be allied to *L. Coptoderæ* from Mexico, figured in my Monograph, as are also the two other species above mentioned.

LABOULBENIA INSIGNIS Thaxter. Plate LXI, fig. 2.

Proc. Am. Acad. Arts and Sci., Vol. XXXVIII, p. 43. June, 1902.

Perithecium free except the base, straight, nearly symmetrical, brown, translucent or transparent, paler below; the wall-cells spiral, describing about half a turn from the base to the tip, which is abruptly distinguished, nearly symmetrical, abruptly opaque below the broadly subhyaline, faintly brownish lips, which are not prominent and form a somewhat angular-truncate or very slightly oblique apex. Distal and basal portions of the receptacle very thick-walled, punctate, abruptly distinguished; the basal cell hyaline or faintly reddish brown, nearly parallel with the perithecium; the subbasal cell larger and longer, more or less prominently and gradually constricted toward the middle; the straight anterior margin of the distal portion of the receptacle abruptly divergent and formed by cell VI and the secondary stalk-cell, both of which become deeply suffused with black brown, except the base of cell VI which is concolorous with the subbasal cell, from the upper half or less of which it is obliquely separated: cell III and IV subequal and separated by a slight constriction, faintly brownish or subhyaline, their margins slightly convergent toward the thick, jet black, constricted, slightly oblique insertion-cell; the inner margin of which is free from the base of the perithecium. Basal cell of the outer appendage squarish or slightly longer than broad, bearing above its outer upper angle a single opaque contrasting short branch (broken in the types but evidently bearing several branchlets); the basal cell of the inner appendage somewhat smaller, bearing a branch on either side; each branch thrice closely branched, their short basal cells, which are subhyaline or faintly reddish brown, each successively bearing two or three divergent stout branchlets; the series ending in branchlets of the fourth or fifth order, which are deep brown, slender, stiff, divergent, thirty or more in all. Spores  $185 \times 6.5 \mu$ . Perithecia  $290-310 \times 80-87 \mu$ . Receptacle  $365-540 \times 150 \mu$ . Appendages (broken)  $220-250 \mu$  or more. Total length to tip of perithecium  $600-650 \mu$ .

On inferior thorax of *Thyreopterus brevicollis* Kl., Madagascar; Berlin Museum, No. 934.

One of the largest and finest species of the genus, the three mature specimens examined being in good condition except that the tips of the ultimate branchlets are broken in all cases. As far as can be determined from the specimens, one of which is quite young, the basal cell of the outer appendage bears only a single opaque branch, all the rest belonging to the inner appendage. Its relationships to other species are not evident and it is placed provisionally near *L. palmella* and *L. forficulata*, both of which occur on allied hosts.

**Laboulbenia Lebiæ** nov. sp. Plate LXI, figs. 3-4.

Perithecium faintly olivaceous, deeper below; the cells at or about its base more deeply suffused, especially externally, and more or less distinctly elevated above the surrounding surface; the body of the perithecium tapering more or less evenly and considerably to the tip, which is not abruptly distinguished except by its contrasting blackish color, and is usually turned strongly outward and somewhat sidewise, the translucent lip-edges external, olivaceous. Receptacle rather long and slender, tapering gradually from the distal region to the base; dirty olivaceous yellow; cell III distally, and cell IV almost wholly,



suffused with olive brown, the latter prominent below the black insertion-cell; cell III slightly longer than cell VI which lies erect beside it. The outer appendage consisting of a somewhat incurved series of about three obliquely superposed cells, the basal large, externally suffused with olive-brown, the rest successively smaller, yellowish, all bearing distally a branch from a nearly horizontal base, the branches mostly once or more branched and more or less deeply suffused; the inner appendage consisting of a basal cell somewhat smaller than that of the outer, which bears on either side a branch somewhat similar to the outer appendage: the whole forming a dense tuft of branches mostly opaque or deeply suffused with olivaceous brown, and strongly curved toward, or partly across, the perithecium. Perithecium  $165 \times 50 \mu$ . Appendages, longest  $125 \mu$ . Receptacle  $360 \times 60 \mu$ . Total length  $500 \mu$ .

At the base of the posterior legs of *Lebia* sp., Java, Rouyer, No. 1398.

A smaller form, which cannot be separated from this species, occurs on the legs of the host (fig. 4), and differs in the blunt straight tip of its perithecium, the absence of dark suffusions, except in the appendages and at the tip of the perithecium, in its ill developed appendages, and in the greater prominence of the cells about the base of the perithecium. The latter character is one which distinguishes this species from any other known to me, and the type form represented in fig. 3, can hardly be confused with any other. It appears to be somewhat allied to *L. insignis*, but not at all closely.

#### LABOULBENIA AUSTRALIENSIS Thaxter.

Additional material of this species on *Acrogenys hirsuta* from Australia has been obtained from the British Museum No. 668 and from the Berlin Museum No. 943. The branches of the appendages appear to be very brittle, and in most of the adults are so broken that their true character is obscured. The variable basal cell of the outer appendage, unlike those of the specimens figured in my Monograph, is apt to be more or less completely and deeply suffused, and in general gives rise to an outer and an inner branch; the inner hyaline and usually furcate above its basal cell; the successive cells of the main axis of the outer, about three in number, more or less deeply suffused, especially externally, each giving rise distally, sometimes from both the inner and outer angles, to rigid branchlets, which may be simple or, especially in the lowest, commonly bear several secondary branchlets which grow upward. This type of branching seen in the outer appendage is unusual, and the species is well distinguished.

LABOULBENIA PROMINENS Thaxter. Plate LIX, fig. 14.  
Proc. Am. Acad. Arts and Sci., Vol. XXXV, p. 195. Dec., 1899.

Perithecium short and stout, less than half free from the receptacle, nearly opaque blackish brown lighter distally, the short broad blunt black tip rather abruptly distinguished on the inner side. Receptacle rather stout, cells I and II dirty yellowish or subhyaline, the rest more or less deeply suffused with blackish brown; all the cells except cell I marked by fine transverse striations more distinct on the suffused portions; cells III and IV large and prominent, the insertion-cell broad but narrower than cells IV-V. Outer appendage consisting of a short irregular cell abruptly prominent externally above the insertion-cell, narrowed distally and bearing two branches antero-posteriorly, the outer externally deep blackish brown, once branched, its outer branchlet blackened and also branched, the inner consisting of a short basal cell which bears an inner and an outer branchlet, all the branchlets pale brown, except the outermost which is blackened, curved outward: the inner appendage consisting of a basal cell smaller than that of the outer, irregular and bearing a branch on either side; each once branched, the branchlets like those of the outer appendage. Perithecia  $150 \times 52 \mu$ . Total length to tip of perithecium  $310-330 \mu$ ; to insertion-cell  $275 \mu$ . Greatest width  $95-100 \mu$ . Spores  $75 \times 7 \mu$ .

On *Pericallus guttatus* Chev., Brit. Mus. No. 571, Java. On legs.

A stout species, the form of which is similar in general to that of *L. Maylayensis* the distal part of the receptacle (cells III-V) being as large as the whole remainder. The appendages are, however, quite different, as is the form and position of the perithecium. But two specimens of the species have been examined, in both of which the tips of the ultimate branchlets of the appendages are broken.



## LABOULBENIA DISTINCTA Thaxter. Plate LIX, figs. 15-16.

Proc. Am. Acad. Arts and Sci., Vol. XXXV, p. 172. Dec., 1899.

Perithecium short and broad, wholly united to the receptacle except the tip, clear dark brown, darker distally, the tip large, blackish, somewhat compressed, the lips translucent smoky brown, not prominently distinguished. Receptacle short and stout, the distal portion larger than the basal; cells I, II, and VI transparent yellowish, the rest smoky brown, marked by closely set fine transverse lines; cells III and IV relatively very large, subequal. Insertion-cell two thirds as broad as cells IV-V. Outer appendage consisting of four superposed cells, the three lower flat and subequal; the second subbasal, and third bearing single simple or once branched upcurved branches from their inner sides; hyaline becoming dark brown, the two lower larger and nearly equal, the uppermost cell much smaller almost opaque producing a similar branch from its inner side and a terminal branch which is deep brown curved outward and upward, slender, simple; the inner branches of the three cells all at first hyaline, mostly once branched; later developing a dark brown contrasting suffusion above their basal cells: the inner appendage consisting of a small basal cell producing a branch on either side, the basal cell of which is larger than that of the appendage, and bears two branchlets basally suffused with brown like those of the outer appendage. Perithecia  $130 \times 50 \mu$ . Total length to tip of perithecium  $275 \mu$ ; to insertion-cell  $250 \mu$ ; greatest width  $95 \mu$ . Appendages, longest  $235 \mu$ .

On margin of elytra of *Pericallus cæruleovirens* Tat., Brit. Mus. No. 570, Singapore.

The appendages of this very distinct species are quite different from those of any described form. The receptacle is somewhat similar to that of *L. prominens*, cells III and IV being relatively very large, each bulging prominently, but separated by a marked constriction. Two mature specimens only have been examined. The tip of the branch at the extreme left in fig. 15, has been supplied, being broken in the adult specimens, though present in the young, fig. 16.

## LABOULBENIA ACANTHOPHORA Thaxter. Plate LVI, fig. 14.

Proc. Am. Acad. Arts and Sci., Vol. XXXVIII, p. 27. June, 1902.

Pale smoky brown. Perithecium relatively very large and elongate, the lower wall-cells forming a well-developed stalk, slightly narrower and paler than the main body which is very long, straight, but slightly inflated; the tip stout, more deeply suffused, well differentiated; one of the lip-cells forming a median, terminal, erect, slightly curved and tapering, blunt-tipped, dark brown projection, the lower half broader, the whole more than twice as long as a similar second outgrowth which, arising near its base, curves outward on the right side (the perithecium being considered anterior). Basal cell of receptacle subhyaline, more than twice as long as broad, the subbasal subisodiametric, darker brown than the other cells; cells III and VI subequal, lying perpendicularly side by side, both several times longer than broad; cell IV about as long as cell III; cell V small, obliquely separated. Insertion-cell black, well defined. Outer appendage (broken) simple (?) its basal cells blackened; the branches curved outward, externally blackened below, and giving rise above to several successive branchlets. Spores  $75 \times 4.5 \mu$ . Perithecium (main body)  $220 \times 50 \mu$ ; stalk  $60 \times 30 \mu$ ; terminal appendage  $60 \mu$ . Receptacle  $220 \times 65 \mu$ . Appendages (broken)  $150 \mu$ . Total length to tip of perithecium  $580 \mu$ .

On the elytra of *Pericallus* sp.; Sharp Collection, No. 1202; East Indies.

The general habit of this species, which is represented by a single type specimen, is peculiar. The perithecium is much longer than the receptacle, which is shaped like a butter-spat, cell I forming the handle, cell II being somewhat abruptly broader, and cells III and VI being almost paired. The species is most nearly related to *L. ceratophora*, from which it differs, however, in numerous important points which are too obvious to need enumeration.



## LABOULBENIA CERATOPHORA Thaxter. Plate LX, figs. 32-35.

Proc. Am. Acad. Arts and Sci., Vol. XXXV, p. 163. Dec., 1899.

Perithecium wholly free, borne on a short nearly hyaline stalk, slightly tinged with brown, for the most part nearly straight, rather slender, hardly inflated, the outer margin usually slightly concave; tapering slightly and rather abruptly to the peculiarly modified tip; the tip black, except externally immediately about the pore, a large broad tooth-like prominence projecting inward, the upper surface of which is nearly horizontal; while it is continued upward and outward above and beyond the lateral pore into a longer more slender, finger-like, bluntly tipped outgrowth, the lower or external margin of which may be partly hyaline. Receptacle yellowish tinged with brown distally, where it is rather abruptly, but slightly, broader above cell II, cell IV small and hardly longer than cell V, cells III and VI subequal. Insertion-cell opposite the distal extremity of the short perithecial stalk. The basal cell of the outer appendage longer and narrower than that of the inner, becoming concolorous with the insertion-cell, bearing a single branch of usually three cells more or less deeply tinged with brown, each of which may give rise distally on the inner side to a short simple branchlet: the inner appendage consisting of a basal cell shorter and broader, which usually bears distally on either side a branch, the basal cell of which usually bears distally two erect simple branchlets, one of them sometimes replaced by a single large long-necked brown antheridium. Perithecia, including the stalk ( $17 \mu$ ),  $150-155 \times 30 \mu$ . Total length to tip of perithecium  $290-310 \mu$ ; to insertion-cell  $150 \mu$ ; greatest width  $35 \mu$ . Appendages, longer  $200 \mu$ .

On *Serrimargo guttiger* Schaum, Hope Collection, No. 300, Sumatra; on *Miscelus Javanus* Klug., Hope Collection, No. 303, Java; on *Miscelus* sp., New Guinea, Paris Museum, No. 113 Type. On elytra and inferior surface of the prothorax.

A well marked species, nearly allied to *L. Javana*, from which it is distinguished by the conformation of the tip of its perithecium, as well as by other differences which appear to be constant in the material examined, and are sufficiently indicated in the accompanying figures.

## LABOULBENIA ASSAMENSIS Thaxter. Plate LX, figs. 36-39.

Proc. Am. Acad. Arts and Sci., Vol. XXXV, p. 159. Dec., 1899.

Perithecium rather long and slender, usually straight and erect, free except at its very base, evenly suffused with dark slightly reddish brown, paler distally, tapering very slightly and gradually to the not abruptly differentiated tip which is somewhat rounded, slightly bent inward and suffused with blackish brown; the left lateral lip-cell prolonged to form a blackish blunt-tipped prominent outgrowth, which is either erect or bent slightly outward or inward. Receptacle dirty brownish yellow, punctate with fine rather indistinct transverse striations, cell V very small, often hardly visible against the perithecium. Appendages concolorous with the receptacle, the outer simple, straight, rigid, mostly somewhat divergent; the inner consisting of a basal cell often as large as that of the outer, and giving rise on either side distally to a branch similar to the outer appendage which bears several lateral antheridia near the base. Perithecium (including outgrowth  $18 \mu$ )  $185-190 \times 33-37 \mu$ . Total length to tip of perithecium  $375-450 \mu$ ; to insertion-cell  $185-300 \mu$ ; greatest width about  $48 \mu$ . Appendages,  $150 \mu$ .

On *Catascopus?* sp., Brit. Mus. No. 663, Assam, India. Inferior surface.

Allied to *L. tenuis*, in which the appendages are very similar, and to *L. Sumatra*, *L. Javana* and *L. ceratophora*; although the conformation of the perithecial tip is quite different from either. The material is sufficient and in good condition.

## LABOULBENIA JAVANA Thaxter. Plate LX, figs. 17-20.

Proc. Am. Acad. Arts and Sci., Vol. XXXV, p. 182. Dec., 1899.

Perithecium about two thirds or less free, sessile, tinged with brown, paler in the middle, the distal portion hyaline and tapering considerably to the greatly modified tip, which is deeply suffused with blackish brown and bears two often symmetrically placed divergent outgrowths, the inner broader at the base and much shorter than the outer which is finger-like, with a hyaline area above, close beside the sub-



terminal pore: the outer of these two projections appears, through a twist in the perithecium, to lie on the inner side. Receptacle pale yellowish with brownish shades, the deeply suffused base of the perithecium opposite the upper half of cell III or lower; the distal portion usually so twisted and bent in conjunction with the perithecium that it crosses the latter and the appendages at a considerable angle. Insertion-cell higher than the middle of the perithecium. Appendages concolorous with the receptacle, the outer simple, consisting of a basal cell, large, long, usually more or less suffused, and distally slightly geniculate so that the remainder of the appendage is bent abruptly toward the perithecium, the basal cell of the inner appendage smaller, bearing a single branch on either side which may be once branched. Perithecia about  $100\ \mu$  long, exclusive of outgrowth,  $27\ \mu$  broad. Total length to tip of perithecium  $190\ \mu$ ; to insertion-cell  $140\ \mu$ . Appendages  $130\ \mu$ . Distance from tip to tip of perithecial outgrowths  $45\text{--}48\ \mu$ .

On *Pericallus cicindeloides* MacLeay, Paris Museum, No. 143, Tongou, Java. On inferior surface of thorax.

This curious form is chiefly remarkable for the peculiar conformation of the tip of its perithecium, the outgrowths from which are more highly developed than they are in any of the other terrestrial forms. It is most nearly related to *L. Sumatræ*, in which the tip of the perithecium is somewhat similar, though less peculiarly developed.

LABOULBENIA SUMATRÆ Thaxter. Plate LX, figs. 13–16.  
Proc. Am. Acad. Arts and Sci., Vol. XXXV, p. 203. Dec., 1899.

Perithecium small, pale amber-colored, darker and somewhat inflated below, tapering distally; the tip, only, free from the receptacle, not distinguished from the body of the perithecium, long, nearly hyaline below, the lip-cells abruptly spreading, contrasting, black except about the pore and peculiarly modified, the two outer broadly rounded, the two inner developing outgrowths which grow inward and upward; that on the right side longer than the left, narrower and indented near the base on the inner side. Receptacle concolorous with the perithecium, paler below, marked by faint fine transverse striations. Appendages concolorous with the receptacle, the outer simple, stiff, curved slightly outward, the inner consisting of a basal cell smaller than that of the outer and bearing on either side a branch which may be once branched at the base. Perithecium  $92 \times 22\ \mu$ . Total length to tip of perithecium  $200\ \mu$ ; to insertion-cell  $166\ \mu$ . Appendages about  $185\ \mu$ .

At base of anterior legs of *Catascopus cupripennis* Thoms., Hope Collection, No. 291 Borneo, No. 299 Sumatra.

This little species is intermediate between *L. tenuis* and *L. Javana*, approaching the latter very closely, though differing in the peculiar conformation of the tip of the perithecium and the relation of the latter to the receptacle, which is normal in form, and undistorted. The outer appendage also differs in being straight, with a relatively smaller basal cell.

LABOULBENIA MEGALONYCHI Thaxter. Plate LVIII, fig. 2.  
Proc. Am. Acad. Arts and Sci., Vol. XXXVIII, p. 46. June, 1902.

Hyaline, becoming very faintly tinged with yellowish brown. Perithecium about one half or more free, slightly divergent, short, stout, tapering slightly from the broad basal half to the tip; which is, as a rule, bent abruptly inward, rarely outward, or erect, rather small and well-distinguished by its long external contrasting broadly blackened margin, and by a shorter broadly blackened area below the small, prominently rounded inner lips; the lip-edges horizontal, or nearly so. Receptacle rather long and slender; cells I and II of nearly equal diameter, the latter large; while between it and cell III and VI the receptacle may be abruptly and strongly twisted; cells III and VI subequal, the former higher; cell IV slightly smaller; cell V relatively large, the inner half or less of its inner margin free between the perithecium and the broad, thick, black contrasting insertion-cell. Outer appendage consisting of three superposed, distinctly brown, successively smaller cells, each nearly twice as long as broad; each of the two lower



producing distally from its inner side a simple hyaline abruptly erect branch, the terminal one bearing two such branches distally. Basal cell of the inner appendage half as large as that of the outer, bearing on each side a branch which bears one or more branchlets and, bending across the outer appendage, is often characteristically recurved beyond it. Spores  $58 \times 5 \mu$ . Perithecia  $100-125 \times 40-50 \mu$ . Receptacle  $275-360 \mu$ . Appendages  $185 \mu$ . Total length to tip of perithecium  $300-435 \mu$ .

On the right inferior prothorax of *Megalonychus patrobioides*, Chincoco, E. Africa; Berlin Museum, No. 1037; on *M. Angolensis* Harold, No. 1039.

A species well distinguished in all its characters and not closely related to any other. The material on *M. Angolensis* is all immature, but undoubtedly belongs to this species.

LABOULBENIA OBLIQUATA Thaxter. Plate LVIII, fig. 3.  
Proc. Am. Acad. Arts and Sci., Vol. XXXVIII, p. 48. June, 1902.

Color pale amber-yellow. Perithecium almost wholly free, distally bent abruptly outward or almost recurved; the base slightly inflated; tapering somewhat, distally, to the apex; the tip hardly distinguished, irregularly bent or twisted; the asymmetrical lip-cells forming irregular projections, the two inner subtended by unequal dark patches. Subbasal cell of the receptacle somewhat longer than the basal, nearly as broad as the distal portion of the receptacle; cells III and VI subequal; cell IV subtriangular; cell V broad and short, carrying the thick contrasting black insertion-cell out free from the perithecium. Outer appendage simple (or distally branched?), slightly divergent; the basal cell somewhat inflated, abruptly broader than the subbasal cell, its basal third or more obliquely involved by the opacity of the insertion cell: the basal cell of the inner appendage similar to that of the outer, without suffusion, bearing a short branch on either side, each of which may bear several branchlets. Spores  $45 \times 3.5 \mu$ . Perithecia  $165-170 \times 40 \mu$ . Receptacle  $185-200 \times 45 \mu$ . Total length to tip of perithecium  $325-360 \mu$ .

On elytra of *Coptodera gagatina* Dej., Brazil; Berlin Museum No. 978.

This species is distinguished by the abrupt curvature of its perithecium, the peculiar modification of the tip of the latter, and the oblique black suffusion of the basal cell of the outer appendage, which is continuous with the opacity of the insertion-cell, and contrasts strongly with the otherwise general pale yellowish color. It appears to be more nearly allied to the group of forms on *Pericallus* and allied hosts of the East Indies.

LABOULBENIA TENUIS Thaxter. Plate LX, figs. 24-26.  
Proc. Am. Acad. Arts and Sci., Vol. XXXV, p. 204. Dec., 1899.

Perithecium relatively small and narrow, dull amber-yellow to brown, the upper half or more free from the receptacle, tapering somewhat distally, curved toward and partly across the appendages; the tip not well distinguished, broad, its distal margin often concave, the lips projecting slightly on either side, the lip-cells black, except about the pore. Receptacle slender, amber-yellow, becoming tinged with brown especially distally, strongly curved throughout, the concave side anterior. Insertion-cell black and thick, narrower than cells IV and V. Appendages straight and rigid, the outer usually simple, its basal cell large bulging and blackened externally, much larger than that of the inner appendage which gives rise to a branch on either side with short antheridial branches near the base. Perithecia  $90-130 \times 22-26 \mu$ . Total length to tip of perithecium  $250-500 \mu$ ; to insertion-cell  $425-185 \mu$ . Greatest width  $37-55 \mu$ . Appendages more than  $200 \mu$  (broken).

On *Miscelus Javanus* Klug., Hope Collection, No. 308, Java; on *Miscelus* sp., Paris Museum, Nos. 114 and 115, New Guinea; on *Catascopus* ? sp. Brit. Mus. No. 663, Assam India. On the elytra and inferior surface.

This species is well distinguished by its subfalcate habit, the whole plant being evenly curved from base to tip, the small narrow perithecium with its broad obtuse tip lying against the straight appressed appendages. The receptacle is relatively long and slender, and faintly punctate. The material from Assam (fig. 26) though much larger and darker than the type form from New Guinea (figs. 24-5), is other-



wise identical with it. The species appears to be allied to *L. subconstricta*, *L. aristata*, and several others of the numerous and varied forms which occur on these and other nearly related genera of East Indian Carabidæ. The maximum measurements given above apply to the form on *Catascopus*.

LABOULBENIA SUBCONSTRICATA Thaxter. Plate LX, figs. 30-31.

Proc. Am. Acad. Arts and Sci., Vol. XXXV, p. 203. Dec., 1899.

Perithecium less than one half free, rather small, curved strongly and evenly toward the appendages, evenly suffused with dark brown or lighter distally; the tip black, not abruptly distinguished, the lips distinct with a broad hyaline margin about the pore. Receptacle dull amber-yellow, cells IV and V, sometimes cell III, less deeply suffused with brown; cell I narrow, straight, but slightly enlarged distally; cell II abruptly much larger, symmetrically and prominently constricted in the middle; cells III and IV relatively, large and broad. Outer appendage simple, the basal cell moderately large; externally or wholly blackened; the rest of the appendage straight, rigid, directed across the tip of the perithecium: inner appendage consisting of a smaller basal cell which bears one or two branches similar to the outer appendage. Perithecia  $85 \times 25 \mu$ . Total length to tip of perithecium about  $200 \mu$ ; to insertion-cell  $165 \mu$ ; greatest width  $50 \mu$ . Appendages, broken, about  $150 \mu$  or a little more.

On *Catascopus* sp., Paris Museum, No. 116, New Guinea. On anterior inferior margin of thorax on the right side.

This species is very closely allied to *L. tenuis*, but differs in its short stout perithecium, and in the peculiar form of its receptacle, which does not vary in the five types.

LABOULBENIA EUCHILÆ Thaxter. Plate LV, fig. 13-14.

Proc. Am. Acad. Arts and Sci., Vol. XXXVIII, p. 36. June, 1902.

Slender, nearly uniform pale dirty yellowish throughout. Perithecium relatively small with a faint brownish tinge, about four fifths free, erect, straight; the tip fairly well distinguished, the inner lip-cells large, prominent, rounded, the lip-edges outwardly oblique. Receptacle slender and long, punctate; the subbasal cell much longer than the basal, nearly isodiametric, or swollen above the basal cell and broader than the distal part of the receptacle, which is separated from its distal end by a prominent constriction; cells III and VI subequal, or cell III larger; cell V very small; cell IV longer than broad, becoming externally tinged with brownish. Insertion-cell relatively thick, free, narrow. Appendages becoming wholly dark brown, in contrast to the rest of the plant; the outer simple, or once furcate above the third cell; the basal cell more than twice as long as broad; the basal cell of the inner appendage less than one half as large as that of the outer, bearing a usually simple branch on either side, which bears single antheridia near its base. Spores  $60 \times 4.5 \mu$ . Perithecia  $100 \times 30 \mu$ . Receptacle  $220-250 \times 35-40 \mu$ . Appendages  $150 \mu$ . Total length to tip of perithecium  $300-350 \mu$ .

At the base of the anterior legs of *Euchila flavilabris* Dej., Brazil; Berlin Museum, No. 938.

This pale dirty brownish yellow, evenly colored species is well distinguished by the peculiar conformation of its receptacle; cell II being greatly enlarged, and the receptacle immediately above it distinctly narrowed, forming a constriction. The appendages become very dark contrasting brown; but in all the specimens examined, which are sufficiently numerous, though not in the best condition, the perithecium remains concolorous with the receptacle and without dark shades.

LABOULBENIA TUBERCULIFERA Thaxter. Plate LX, figs. 1-3.

Proc. Am. Acad. Arts and Sci., Vol. XXXV, p. 208. Dec., 1899.

Perithecium deeply suffused with smoky brown, free except the lower fifth; the tip not abruptly distinguished, nearly black, the distal margin somewhat oblique, mostly straight with an outer more or less ill defined tooth-like prominence; in general variable, the lip-cells not prominent. Receptacle rather long and slender, cell I quite hyaline below, distally tinged with deep brown and coarsely punctate; cell II tinged with brown and punctate below with scattered black-brown dots, otherwise nearly hyaline,



except a series of deep brown short tubercular transverse ridges on one side of cell IV, and the basal cells of the perithecium which are deep brown, the rest subhyaline, cell IV bulging. Outer appendage simple, slender, the basal cell sometimes long and somewhat inflated: the inner appendage consisting of a small basal cell with a short branch on either side. Perithecia about  $140 \times 50 \mu$ . Total length to tip of perithecium, average  $340 \mu$ ; to insertion-cell, average  $225 \mu$ ; greatest width  $60 \mu$ . Appendages  $225 \mu$  (longest).

On *Serrimargo guttiger* Schaum., Brit. Mus. No. 558, Penang, East Indies. On base of elytra.

This species is closely allied to *L. leucophæa* and *L. corrugata*, being the least characteristic of the three. It is distinguished from *L. leucophæa*, which it most nearly resembles in the relation of its perithecium to the receptacle. The short basal cell of the latter, the punctation of the subbasal cell in connection with its suffusion, and in the very differently shaped perithecial tip, which is without any finger-like projections.

LABOULBENIA LEUCOPHÆA Thaxter. Plate LX, figs. 9–11.

Proc. Am. Acad. Arts and Sci., Vol. XXXV, p. 183. Dec., 1899.

Perithecium dark brown, almost opaque, rather small, hardly more than the tip free from the receptacle; the tip relatively large and long, bent slightly outward, not abruptly differentiated, black except around the pore, the right inner lip forming a hyaline nearly median blunt outgrowth which is bent slightly outward. Receptacle sometimes twisted at the distal end of and above cell II; cell I hyaline; cell II suffused with brown, in some cases with deeper brown transverse elevations on one side; the lower half of cell III and cell VI hyaline, the rest of the receptacle concolorous with the perithecium. The outer appendage simple, its basal cell four or more times as long as broad, curved toward the perithecium; the basal cell of the inner appendage very small, bearing in general a single short branch, both appendages pale yellowish. Perithecium to tip of outgrowth  $130\text{--}150 \times 35\text{--}40 \mu$ . Total length to tip of perithecium  $325\text{--}375 \mu$ ; to insertion-cell  $250\text{--}290 \mu$ ; greatest width  $55\text{--}65 \mu$ . Appendages about  $200 \mu$ .

On mid-elytron and base of legs of *Serrimargo guttiger* Schaum., Hope Collection, No. 300, Sumatra.

This species is closely allied to *L. corrugata* and *L. tuberculifera*, but differs from both in the relation of its perithecium to the receptacle, and the conformation of the tip. Of two original preparations one has unfortunately been destroyed, so that the species is represented by two individuals only.

LABOULBENIA CORRUGATA Thaxter. Plate LX, figs. 6–8.

Proc. Am. Acad. Arts and Sci., Vol. XXXV, p. 168. Dec., 1899.

Perithecium rather small, irregular, free from the receptacle except at the base, blackish brown, darker and almost opaque below, a rounded distal elevation extending completely around the perithecium, broader externally, forming a nearly opaque broad collar, above which the tip is very abruptly distinguished; the latter subhyaline basally, a dark median external and internal suffusion, the lips translucent, faintly brownish, the two outer rounded and curved inward between the two inner, which form two free slightly unequal divergent blunt-pointed projections. Receptacle rather long and slender, pale brownish yellow with deeper brown suffusions about the distal region of cell I and the basal region of cell II; the basal cells of the perithecium opaque and cell IV and V more deeply suffused; a series of prominent blackish brown tuberculate ridges extend more than half way across the receptacle from the anterior margin, beginning below the insertion-cell and extend as far as the base of cell II, cell IV bulging distally outside the thick rather narrow insertion-cell. Outer appendage simple, erect, tapering, yellowish; inner appendage consisting of a smaller basal cell with a similar and shorter branch on either side. Perithecia  $120 \times 37\text{--}40 \mu$ . Total length to tip of perithecium  $340 \mu$ ; to insertion-cell  $200 \mu$ ; greatest width  $60 \mu$ . Appendages  $185 \mu$ .

On base of the elytron of *Serrimargo guttiger* Schaum., Hope Collection, No. 300, Sarawak, Borneo.

This species, although closely allied to *L. tuberculifera* and *L. leucophæa*, is readily distinguished from either by the peculiar conformation of the distal portion of the body of its perithecium, as well as



by the two ear-like processes from its rounded tip. The tubercular corrugations are also more prominent and differently placed. Two mature specimens, only, have been examined.

LABOULBENIA NOTATA Thaxter. Plate LVI, fig. 13.

Proc. Am. Acad. Arts and Sci., Vol. XXXVIII, p. 47. June, 1902.

Perithecium straight, erect, hardly more than the tip free, almost or quite opaque distally, paler below; covered with scattered wart-like protuberances; the tip abruptly distinguished, opaque, separated from the body of the perithecium by a subhyaline zone; the apex broadly hyaline, truncate, somewhat angular. Receptacle elongate throughout; the basal cell relatively small, dark brown, somewhat contrasting, the rest pale brownish yellow to dark brown; distally more or less conspicuously marked by scattered brown warts; cell VI very long and slender, overlapping cell II for some distance, the cells above it also unusually elongate; cell III very long and slender, separated from cell II by a narrow horizontal septum; cell V relatively small. Insertion-cell somewhat oblique, thick, black, not abruptly narrower than the cells below it. Outer appendage simple, short, the basal cell several times longer than broad, the remainder more slender, brown, contrasting with the basal cell. Inner appendage consisting of a basal cell more than half as long as that of the outer, bearing distally on either side a short simple branch similar to the outer appendage but paler. Perithecia  $271 \times 55 \mu$ . Receptacle  $1100 \times 75 \mu$ . Appendages about  $185 \mu$ . Total length to tip of perithecium  $1150 \mu$ .

On *Thyreopterus armatus* Cast., Madagascar; Berlin Museum, No. 933.

A very peculiar, coarsely warted form, evidently related to the other members of the series with simple outer appendages, which occur on hosts of this and of allied genera. A single full grown individual only has been examined which is illustrated in fig. 13.

LABOULBENIA PROTRUDENS Thaxter. Plate LIX, figs. 7-8.

Proc. Am. Acad. Arts and Sci., Vol. XXXV, p. 196. Dec., 1899.

Perithecium smoky brown with a tinge of olive, the outer margin concave, relatively small; the tip, only, free from the receptacle, short, broad, subtruncate not abruptly differentiated, bent slightly outward, black except around the pore. Receptacle dirty olivaceous, faintly punctate above cell I which is, except at the base, concolorous with perithecium; cells IV and V forming a somewhat angular protrusion which carries the insertion-cell out free from and beyond the tip of the perithecium. Insertion-cell less than half as broad as the adjacent distal margins of cells IV and V, which form a flat surface in which the insertion-cell is mostly central. Outer appendage arising from a small roundish basal cell, simple or once branched, the branches short, tapering, nearly hyaline; the basal cell of the inner appendage very small, bearing one or two short tapering hyaline branches. Perithecia  $95-110 \times 34 \mu$ . Total length to tip of perithecium  $280 \mu$ ; to insertion-cell about the same measurement; greatest width  $66 \mu$ .

On *Pericallus cicindeloides* MacLeay, Paris Museum, No. 144, Tongou, Java. On mid-elytron.

The general appearance of this species, owing to the peculiar relation of the perithecium and receptacle, recalls that of *L. Schizogenii* and *L. Morionis*. The character of the appendages makes it seem probable that it is allied to some of the simpler forms which occur on this and on related hosts, as for example *L. aristata*, *L. tenuis*, *L. Maylayensis* etc., rather than to forms of the "*Clivinæ*" group.

LABOULBENIA MALAYENSIS Thaxter. Plate LIX, figs. 17-18.

Proc. Am. Acad. Arts and Sci., Vol. XXXV, p. 185. Dec., 1899.

Perithecium clear translucent brown with a slight olive tinge, becoming almost opaque; united to the receptacle, except the abruptly distinguished tip which is hyaline, all but the blackened lips; the latter turned abruptly usually to the right, forming a lateral somewhat irregularly four-lobed papilla in which the hyaline pore is central. Cells I and II of the receptacle about equal in length, nearly hyaline, often distally olivaceous; cells III and IV relatively large, translucent olive-brown, cell IV bulging distally so that the dark but not opaque insertion-cell is turned obliquely toward the tip of the perithecium; cells



VI and the basal cells of the receptacle more or less tinged with olive-brown forming an elevation so that the perithecium appears indented below, all the cells except cell I marked by fine transverse striations. Outer appendage simple, the basal cell rather large, often externally indented near the base, the second and third cells nearly equal, narrower than the basal cell and the cells immediately above them; the rest of the appendage tapering to the hyaline attenuated elongate distal portion; the inner appendage consisting of a basal cell one third as large as that of the outer and bearing a single branch on either side, one or both of which may be elongate much like the outer appendage, bearing one or two short slender antheridial branches near the base, which are bent rather abruptly upward from their point of origin; the branches all distally hyaline and attenuated; the basal cells faintly reddish. Perithecia, average  $110 \times 37 \mu$ . Total length to tip of perithecium 260–280  $\mu$ ; to insertion-cell 250–275  $\mu$ ; greatest width 75  $\mu$ . Appendages, longest 375  $\mu$ .

At base of posterior legs of *Pericallus caruleovirens* Tat., Brit. Mus. No. 570, Singapore.

This species is well defined by its general form, the relation of the perithecium to the receptacle, and the conformation of the outer appendage, which is similar to that of *L. aristata*; but especially from the peculiar conformation and twist which characterize the tip of the perithecium. The four mature specimens examined are all in good condition and show no variation.

LABOULBENIA ARISTATA Thaxter. Plate LX, figs. 27–29.  
Proc. Am. Acad. Arts and Sci., Vol. XXXV, p. 158. Dec., 1899.

Perithecium less than one half free from the receptacle, pale amber-yellow, straight and symmetrical or nearly so, the tip well distinguished, symmetrical, blackish, the lip-cells symmetrically rounded and protruding slightly on either side, their distal margins straight and horizontal, or nearly so. Receptacle concolorous with the perithecium, cell I tinged with brown, a brownish shade below the base of the perithecium, cell IV bulging distally where it is rather faintly suffused with blackish. Outer appendage simple, the basal cell more than twice as long as it is broad, the two cells above it abruptly narrower and equal; two or three of the cells above these broader with thicker walls, the rest of the appendage tapering; the whole rigid, straight, erect or bent toward the tip of the perithecium, a part of which it may overlap; inner appendage consisting of a small basal cell bearing a very short one- or two-celled branch on either side. Perithecia  $95\text{--}110 \times 30 \mu$ . Total length to tip of perithecium 240–260  $\mu$ ; to insertion-cell 185–200  $\mu$ ; greatest width 60  $\mu$ . Appendages 260–330  $\mu$ .

On a carabid (near *Pericallus*), Hope Collection, No. 322, Bouro, East Indies (A. R. Wallace).  
On superior margin of prothorax.

This species bears some resemblance to *L. erecta*, from which it differs in the conformation of the bulbous tip of its perithecium, the relation of the latter to the insertion-cell and the enlargement of the receptacle below the insertion-cell, which is slightly bent (fig. 27), the outer appendage lying across or against the tip of the perithecium.

LABOULBENIA PLATYSTOMA Thaxter. Plate LX, figs. 4–5.  
Proc. Am. Acad. Arts and Sci., Vol. XXXV, p. 194. Dec., 1899.

Perithecium free except at the very base, straight, rather long and narrow, pale amber-yellow becoming slightly tinged with brown, slightly and symmetrically inflated; the tip black, opaque, the lip-cells forming an abruptly spreading almost flat symmetrical termination with a slight median indentations, two of the lips forming a small median hyaline truncate cone, the other two arching over them from the outer and inner side, wholly opaque except their inner margins, the blackened part not quite meeting in the median line. Receptacle medium, pale amber-yellow becoming tinged with brown distally. Outer appendage mostly simple, the basal cell about twice as long as broad, often slightly inflated, the rest of the appendage much narrower, straight, rigid, tinged with brown, tapering somewhat distally; the inner appendage consisting of a basal cell about half as long as that of the outer, producing a branch on either side; the branch usually bearing an antheridial branchlet near its base, the branches and the outer append-



age similar, often curved slightly outward, becoming tinged with brown. Perithecia  $175 \times 40 \mu$ ; the tip  $37 \mu$  broad. Total length to tip of perithecium  $325-400 \mu$ ; to insertion-cell  $185-230 \mu$ ; greatest width  $55-63 \mu$ . Appendages about  $175 \mu$  (longest).

On inferior surface of *Catascopus* sp., Paris Museum, No. 119, New Guinea.

This species, although closely allied to *L. tenuis* and *L. aristata*, is clearly distinguished from all others by the very peculiar conformation of the symmetrical spreading tip of its perithecium, the detail of which is shown in fig. 5; the black portions at the apex strongly suggesting the end of a pair of horizontal cut-plyers, or blacksmith's tongs. The material, though scanty, is in fairly good condition and shows no essential variation. The differentiation of the three basal cells of the outer appendage is similar to that of *E. Maylayensis* though less distinct and constant.

LABOULBENIA THYREOPTERI Thaxter. Plates LV and LXIV, fig. 15.

Proc. Am. Acad. Arts and Sci., Vol. XXXV, p. 205. Dec., 1899. *L. Borneensis* Thaxter, l. c., Vol. XXXVIII, p. 28. June, 1902.

Perithecium nearly free, proportionately large, dull amber-brown, straight, narrower at the base, the inner margin slightly convex, the outer concave through the presence of a prominent subterminal hump, which is suffused with blackish brown, the suffusion often involving a fainter discoloration of the subbasal wall-cell below it; the tip small, prominent, and abruptly differentiated, blackish with broad hyaline lips. Receptacle slender, the basal cell black, opaque, mostly curved below, very slender; the subbasal cell broader, suffused with blackish, mostly verrucose or coarsely punctate, the remaining cells normal and concolorous with the perithecium. Insertion-cell thick and narrow. The outer appendage simple, its basal cell long, undifferentiated; the basal cell of the inner appendage shorter, bearing a branch distally on either side, all the branches similar, crowded, concolorous with the perithecium, erect, straight or bent slightly toward the perithecium, the inmost in contact with it. Spores  $55 \times 4 \mu$ . Perithecia  $140-175 \times 14-25 \mu$ . Total length to tip of perithecium  $340-400 \mu$ ; to insertion-cell  $250-270 \mu$ . Appendages  $120-140 \mu$ .

On the elytra of *Thyreopterus flavosignatus* Dej., Brit. Mus. No. 561, Port Natal, Africa. On *Thyreopterus* sp., Paris Museum, No. 125, Africa and Sharp Collection, No. 1201, South Borneo.

A reexamination of these forms shows that there is no essential difference between the African and Borneo material, although the pale yellow color of the latter, Plate LV, which is formerly distinguished as *L. Borneensis*, its more prominent perithecial hump, the absence of the blackened induration of the basal cells of its receptacle, and some other points, give it a somewhat different appearance. The species is a peculiar one, and most nearly allied to *L. ceratophora* and others of the curious group of forms which occur on this and related hosts.

LABOULBENIA FINITIMA Thaxter. Plate LX, figs. 21-23.

Proc. Am. Acad. Arts and Sci., Vol. XXXV, p. 176. Dec., 1899.

Perithecium one half to two thirds or more free, olivaceous brown, lighter distally, becoming wholly dark brown, straight or curved outward, rarely inward; the tip broad, rounded, generally not well differentiated, blackish. Receptacle relatively small, the basal cell hyaline or yellowish, the rest concolorous with the perithecium; cells III-V lighter, cell VI extending down almost or quite to cell I. Appendages brownish or pale olivaceous, the outer simple, its basal cell twice as long as broad, externally somewhat rounded and more deeply tinged with brown; the basal cell of the inner appendage half as large, bearing a branch on either side which is usually furcate above its basal cell: all the branches erect, closely appressed, and often bent terminally across the tip of the perithecium which they scarcely exceed. Perithecia, average  $125 \times 45 \mu$ . Total length to tip of perithecium, average  $240 \mu$ ; to insertion-cell  $145-150 \mu$ ; greatest width  $48-50 \mu$ . Appendages  $30 \mu$ .

On *Pericallus guttatus* Chev., Paris Museum, No. 78, Brit. Mus. No. 571, Java; on *P. cœruleovirens* Tat., Brit. Mus. No. 570, Singapore. On the legs.



The type form of this species (fig. 21) strongly suggests *L. scelophila*, which occurs on the legs of *Platynus extensicollis* in New England; but the two species are abundantly distinct. The variety represented in fig. 23 occurred with the normal form on *P. caruleovirens*, and was associated with other forms like fig. 22, in which the general habit is slightly different. The figures given are darker than they should appear, the typical form having a somewhat translucent olive tint.

LABOULBENIA MICROSOMA Thaxter. Plate LX, fig. 12.

Proc. Am. Acad. Arts and Sci., Vol. XXXV, p. 187. Dec., 1899.

Perithecium free, several times as large as the receptacle, smoky brown darker basally and distally, the longitudinal septa subhyaline, the outer margin concave, the inner convex; a subterminal external small rounded elevation; the tip very broad, short, almost flat-topped, the outer angle almost a right angle, the inner rounded. Receptacle consisting of a basal cell which is nearly hyaline, above which cells II, III, and VI form an almost transverse row; cell II median, triangular, lying between the other two, the receptacle abruptly expanded in this region; cells III and IV small and flattened: similar in size and shape: cell V relatively large, lying within cells III and IV and extending quite to the base of the latter. Insertion-cell and basal cells of the appendages nearly opaque and indistinguishable from one another, the outer basal cell apparently producing two branches antero-posteriorly; the inner, a branch on either side, all the branches (broken) brown, stiff, erect or slightly divergent. Perithecium  $185 \times 66 \mu$ . Total length to tip of perithecium  $295 \mu$ ; to insertion-cell  $90 \mu$ ; greatest width  $65 \mu$ .

On *Serrimargo guttiger* Schaum., Brit. Mus. No. 560, Penang, East Indies. At base of posterior legs.

The small rounded distal portion of the receptacle in this species recalls that of *L. Formicarum*, but the cells are differently arranged. The relative size and arrangement of cells III, IV and V are quite unusual. The appendages are unfortunately badly broken, but appear to be very similar to those of *L. Serrimarginis* to which species I am inclined to believe it is most nearly allied. A single specimen only has been examined.

LABOULBENIA MACULATA Thaxter. Plate LIX, figs. 21-22.

Proc. Am. Acad. Arts and Sci., Vol. XXXV, p. 184. Dec., 1899.

Perithecium free, dark brown becoming nearly opaque, the outer margin more convex than the inner; somewhat constricted at the base, the tip rather abruptly distinguished externally, the margins nearly straight, the inner lips small and prominent, the outer broad, straight, oblique. Receptacle abnormal, cell I short, slender, curved, opaque; cell II nearly hyaline in the middle, brownish above, coarsely spotted with blackish brown below, becoming darker and indistinguishable from cell I at its base; cell VI distally nearly hyaline and narrow, extending down beside cell II nearly if not quite to cell I, its base spotted as in cell II; cell VII (the "secondary stalk-cell") external to it, the margin blackish brown especially distally, extending down beside cell VI to within a short distance of its base where it is similarly punctate towards its base or throughout; cell III narrow, external to the upper two thirds of cell II, punctate below, its distal end close beside the corresponding termination of cell II; the base of cell IV overlapping cell III so that a cross section in this region would cut cells II, III, IV, VI, and VII: distal portion of the receptacle concolorous with the perithecium or somewhat paler. The perithecium bent toward and partly or wholly overlapping the insertion-cell. Appendages directed across the lower half of the perithecium, sometimes at right angles; the outer simple, consisting of a long basal cell sometimes slightly inflated, the rest of the appendage brown: the inner appendage consisting of a basal cell less than half as large, which produces two branches one on either side, the basal cells of which are usually curved, somewhat inflated, bearing two branchlets distally; all the branches slender, rather rigid and straight, parallel and closely approximated, tapering slightly. Perithecia  $225 \times 60 \mu$ . Total length to tip of perithecium  $560 \mu$ ; to insertion-cell  $375 \mu$ ; greatest width  $140 \mu$ . Appendages about  $200-250 \mu$ .



On *Serrimargo guttiger* Schaum., Brit. Mus. No. 559, Penang, East Indies; on *Serrimargo* sp., Borneo, in Cambridge University Collection (England), No. 1216.

This species is very clearly distinguished by the peculiar conformation of its black maculate receptacle, and the attenuation, induration, and opaque suffusion of the basal cell of the latter; which is similar to the condition seen in the type forms of *L. Thyreopteri*. The cell arrangement is somewhat similar to that of *L. Serrimarginis*, which is its nearest ally, but which appears to be very different in other respects. Although the cell arrangement is so abnormal, I am inclined to believe that the species is related to some of the forms like *L. finitima* and *L. subconstricta* which occur on similar hosts.

LABOULBENIA SERRIMARGINIS Thaxter. Plate LIX, figs. 23.

Proc. Am. Acad. Arts and Sci., Vol. XXXV, p. 201. Dec., 1899.

Perithecium about three fourths free, dull olive-brown, the outer margin nearly straight, the inner bent rather abruptly below the tip; the latter not abruptly distinguished, broad, blunt, the lips not well defined, dull blackish. Receptacle dull olive-brown, except the almost hyaline rather slender basal cell; the rest of the receptacle short and stout, concolorous with the perithecium, cell VI broad and extending down to cell I beside cell II, cell VII extending half way down cell VI externally, the septa of cells III and IV oblique; cell III extending up to the base of cell V. Outer appendage simple translucent brown, paler distally, the basal cell twice as long as broad, bulging slightly externally; inner appendage consisting of a much smaller basal cell which bears a branch on either side; the basal cells of each branchlet bearing two simple branchlets similar to the outer appendage, erect, brownish, approximated. Perithecia  $136 \times 50 \mu$ . Total length to tip of perithecium about  $300 \mu$ ; to insertion-cell  $190 \mu$ ; greatest width  $85 \mu$ . Appendages  $260 \mu$ .

On *Serrimargo guttiger* Schaum., Brit. Mus. No. 558, Penang, East Indies. At base of anterior legs.

A form most nearly allied to *L. maculata*, the cells of the receptacle being somewhat similarly arranged and the appendages similar in general, but hardly to be confused with this species. Two mature specimens only have been examined.

LABOULBENIA PERICALLI Thaxter. Plate LV, fig. 12.

Proc. Am. Acad. Arts and Sci., Vol. XXXV, p. 194. Dec., 1899.

Perithecium becoming almost opaque, its upper fourth, sometimes only the tip, free from the receptacle, relatively small, the tip more or less prominent, sometimes subconical, short, and wholly black (often more prominent, abruptly distinguished, the rounded lips well defined with hyaline edges). Receptacle normal, cells III and IV large and broad, concolorous with the perithecium; cells I and II together with the lower end of cell VI pale yellowish. Outer appendage mostly simple, stout, the lower cells slightly inflated; inner appendage consisting of a much smaller basal cell, bearing a usually simple branch on either side very similar to the outer appendage; all the branches yellowish or becoming tinged with brown, especially toward the base. Perithecia  $110-130 \times 37-45 \mu$ . Total length to tip of perithecium  $200-300 \mu$ ; greatest breadth about  $75 \mu$ .

On *Pericallus guttatus* Chev., Paris Museum, No. 78, Java; on *Miscelus* sp., Paris Museum, Nos. 113, 114, 115, New Guinea.

The type form of this species (Paris No. 78), which is represented in fig. 12, is sufficiently characteristic, its general habit recalling that of *L. Maylayensis*, the perithecium being almost wholly united to the receptacle. I have seen specimens, however, that vary toward *L. Catascopi*, and it may be necessary to unite the two eventually.

LABOULBENIA CATASCOPI Thaxter.

The typical form of this species as it occurs in Mexico, is sufficiently well distinguished, and easily recognizable by its uniform amber-brown color, the inflated basal cell of the outer appendage, and the rather abruptly distinguished tip of its perithecium. A comparison, however, of material on *Catascopus*



of various species and from widely different localities, as well as of forms of the same general type which occur on allied hosts, renders any definite decision as to the limits of this species a matter of great difficulty. The East Indian forms approach very closely indeed to *L. flagellata*, though they retain the coloration of the type, and the slightly individual perithecial tip. The basal cell of the outer appendage is either not at all or very inconspicuously inflated, and one form from the Philippines can hardly be distinguished from typical *L. flagellata*. On other American hosts, however, the inflation of the basal cell becomes even more pronounced than it is in the type, the coloration changes, and on species of *Ina*, *Pinacodera*, *Cymindis*, *Euproctus*, *Apenes* and *Callida* a form occurs which, without comparison, I should not have hesitated to separate specifically. Such a separation may eventually prove desirable, yet I have thought it best to group all these forms under the present name until they can be more carefully revised and illustrated. The material thus grouped has been obtained from the following hosts. British Museum; No. 564 on *Catascopus fascialis* Willd., Panama No. 565 on *C. amomus* Chaud. New Guinea; No. 567 on *Catascopus* sp. Mexico; No. 555 on *Apenes pallidipes* Chd. Costa Rica; No. 734 on *Callida quadrispora* Bates, Volcan de Chiriqui, Panama; No. 739 on *Pinacodera atrata* Chev., Puebla, Mexico; No. 716 on *Ina costulata* Chd., Zapota, Guatemala; No. 552 on *Cymindis pallipes* Reich., Venezuela; No. 363 on *Coptodera arcuata* Chev., Bobo, Mexico; No. 566 on *Catascopus* sp., Philippines. Hope Collection; No. 298 on *Catascopus elegans* Fabr., Amboyna, E. Indies; No. 297 on *C. cupripennis* Thoms., Borneo; Nos. 271 and 272 on *Callida "cancellata,"* Brazil; No. 303 on *Physodera* sp., no locality (typical). Paris Museum; No. 88 on *Catascopus* sp., Java; No. 116 do., New Guinea; No. 119 do., New Guinea. Sharp Collection; No. 1210 on *Colpodes auratus* (= ? *atratus* Chd.) Pantaleon, Mexico. Berlin Museum; on *Catascopus fascialis* Wied., Bengal.

LABOULBENIA HAWAIIENSIS Thaxter. Plate LVII, figs. 1-3.

Proc. Am. Acad. Arts and Sci., Vol. XXXVIII, p. 40. June, 1902.

Perithecium variously suffused with dark olive brown, sometimes transparent brownish yellow, becoming nearly opaque, about one quarter, or only the tip, free from the receptacle, rather short and stout; the tip black, often bent outward, tapering rather abruptly; the lip-edges hyaline, rather prominent and outwardly oblique. Receptacle pale reddish amber or yellowish, becoming variously suffused with dark olive-brown, especially distally; the basal cell more commonly narrow and hyaline below; abruptly broader and suffused with dark olive-brown below the base of cell II, which is often abruptly broader through a slight inflation in this region, and similarly suffused, the suffusions often faint; cells III to V often deeply suffused with olive-brown, faintly striate; cells III and IV subequal; cell V extending more or less prominently upward along the inner margin of the perithecium which is further bordered by cells III and IV; the insertion-cell carried obliquely outward by these modifications. Basal cell of the outer appendage usually hyaline, bearing normally two branches; the basal cell of the inner hyaline, that of the outer often small and blackened, bearing two branchlets; the outer shorter, more slender, opaque (usually broken); the basal cell of the inner appendage similar to that of the outer, often protruding somewhat inward, bearing two branches like the outer, or less often laterally, that next the perithecium bearing one or more antheridial branchlets; the antheridia terminal in groups of two or more, sometimes densely clustered; the other bearing similar antheridial branchlets or more often one or more long sterile branchlets like the outer appendage; all the sterile branches usually elongated in a sweeping curve toward the perithecium, commonly rich brown or nearly opaque, sometimes hyaline, sometimes multiplied by branching close to the base. Spores  $65 \times 5 \mu$ . Perithecia  $90-125 \times 40-55 \mu$ . Receptacle  $200-335 \mu$ . Appendages  $290-725 \mu$ . Total length to tip of perithecium  $230-360 \mu$ .

On *Atelothrus erro* Blk. Maui, No. 1230 (Type); *A. gracilis* Sharp, Lanai, No. 1232; *Mauna frigida* Blk., Maui, No. 1221; *Colpodiscus lucipetens* Blk., Maui, No. 1217 *Colpocaccus tantalus* Blk., No. 1223; *Colpocaccus Hawaiiensis* Sharp, Hawaii, No. 1224; *C. Lanaiensis* Sharp, Lanai, No. 1225; *C. posticatus* Sharp, Kauai, No. 1227; *Mesothriseus muscicola* Blk., Hawaii, No. 1237; *M. tricolor* Sharp,



Molokai. No. 1239; *M. alternans* Sharp, Kauai, Nos. 1220 and 1243; *Mecyclothorax pusillus* Sharp, Maui, No. 1263; *M. ovipennis* Sharp, Maui, No. 1266, and Molokai No. 1267; *M. montivagus* Blkm., Maui, No. 1269; *Mecyclothorax* sp. ? Maui, No. 1270; on "*Bembidium*" Nos. 1275-1276, and 1280, Kauai. On the following numbers in the Perkins Collection: Kauai, Nos. 1248, 1249, 1251, 1257; Maui, Nos. 1214, 1226, 1264, 1271; Molokai, Nos. 1250, 1272, 1274; Hawaii, Nos. 1265, 1268.

Reference has previously been made under the genus *Laboulbenia* and elsewhere to the group of variable forms which occur on the carabid fauna of the Hawaiian Islands. Of these the one which comes nearest to the ordinary "*flagellata*" type is the present species, which, although it is very closely allied to *L. Disenochi*, appears to differ normally in the development of the distal portion of the receptacle less than a third of which, or sometimes only the tip, is free. Its coloration is very variable; the distal portions, including the perithecium, being most commonly very deeply suffused with contrasting rich black-brown, as in figs. 1 and 2, while less frequently the receptacle and all but the tip of the perithecium may be yellowish or reddish amber, with inconspicuous suffusions. The size is usually moderate, and not subject to extreme variations depending on position of growth; but one form represented in Fig. 3, which appears to belong here and occurs on *Mecyclothorax pusillus* Sharp, has a short stout rotund habit which is peculiar, the specimen figured measuring about  $160 \times 70 \mu$ . Of the illustrations in the accompanying plate, fig. 1 is taken from material on *Colpodiscus tantalus* from Oahu; fig. 2 from *Metromenus ero*, the Type, in which an outer branchlet is broken off, and fig. 3 as above mentioned.

LABOULBENIA DISENOCHI Thaxter. Plate LVII, figs. 4 and 6-7.

Proc. Am. Acad. Arts and Sci., Vol. XXXVIII, p. 34. June, 1902.

Perithecium three quarters or wholly free, transparent, yellowish, becoming more or less irregularly and for the most part rather faintly suffused with blackish brown; the tip relatively large, black, more or less well distinguished, the black suffusion not abruptly limited and extending some distance downward externally; the lips outwardly oblique, hyaline about the pore. Receptacle rather short and stout, normal, pale yellowish, often becoming tinged with brown distally where it is rather faintly striate. Insertion-cell well defined, slightly oblique. Outer appendage consisting of an erect series of usually four hyaline cells, each of which bears *externally* (the upper terminally) a stiff simple branch of variable length, curved outward and upward, deeply blackened externally, the notched often broadly hyaline upper (inner) margin contrasting: the basal cell of the inner appendage bearing a branch on either side, mostly two- to three-celled, and resembling the outer appendage, except for the presence of basal antheridial branchlets on which the brown antheridia are borne terminally, usually in pairs. Spores  $65 \times 6 \mu$ . Perithecia  $150-165 \times 58-62 \mu$ , sometimes smaller. Receptacle  $185-220 \mu$ . Total length  $290-360 \mu$ .

On *Disenochus fractus* Sharp, Kauai, No. 1222; *D. agonoides* Sharp, Haleakala, Hawaii, No. 1229; *D. aterrimus* Sharp, Kauai, No. 1218; *D. sulcipennis* Sharp, Kauai, No. 1219; *Brosconequeus optatus* Sharp, Oahu, No. 1215.

This species, which is closely allied to *L. Hawaiiensis*, appears to differ normally in the character of the receptacle, the distal portion of which is less well developed, more compact, and wholly, or for the most part, free from the perithecium, fig. 4 representing the only exception seen in a large series. The main axis of the outer appendage, and the primary branches of the inner, are better developed; sometimes consisting of five or six superposed hyaline cells from which the usually jet black, stiff, variously elongated and curved simple branchlets arise externally. The Type on *Disenochus sulcipennis* is represented in fig. 7, and illustrates almost the extreme development of these branchlets, as well as the condition in which the perithecium is wholly free from the receptacle. Fig. 6 represents a form on *D. agonoides* the two figures illustrating almost the extremes of variation. It is a question, however, whether this and the preceding were not better united under one protean species.



LABOULBENIA SPHYRI PSIS Thaxter. Plate LVII, fig. 5.  
Proc. Am. Acad. Arts and Sci., Vol. XXXVIII, p. 53. June, 1902.

Perithecium free, projecting at right angles to the axis of the receptacle or recurved, opaque, blackish brown, slightly asymmetrically inflated below, the tip not distinguished, very broad, truncate or bluntly rounded, concolorous. Receptacle relatively slender, hyaline, cells I and II relatively very large, the rest small; cell I shorter, often tinged with brown; cells II and III edged with blackish brown externally; cell IV wholly blackish brown; cell V hyaline or partly suffused, the insertion-cell thick. Basal cell of the outer appendage more or less suffused, giving rise to an outer and an inner branch; the basal cell of the former giving rise to an outer, shorter, and an inner branchlet; the inner branch simple: basal cell of the inner appendage bearing a simple branch, distally furcate above its basal cell; the branchlets both fertile, short, with a single terminal antheridium; or one of them sterile and similar to the outer appendage, short, stout, nearly straight, stiff, opaque, hyaline-tipped: the antheridia relatively large, solitary; the broad neck bent abruptly at right angles. Perithecia  $90-110 \times 40-48 \mu$ . Receptacle  $220-250 \mu$ . Appendages  $150-185 \mu$ .

On *Metromenus caliginosus* Blk., Oahu, Honolulu, *M. epicurus* Blkm. No. 1261, and No. 1262. No. 1256 on *M. latifrons* sp. Molokai Mts., Maui. Perkins Collection, Hawaiian Carabidæ. Right inferior surface of prothorax.

This species, which is allied to both *L. Hawaiiensis* and *L. Disenochi*, is well distinguished by its peculiar hammer-like habit, and absolutely opaque blunt perithecium. The slender, nearly isodiametric perithecium is at first quite hyaline, but may become slightly soiled with yellowish brown, as well as deeply suffused externally below the insertion cell. The type form on *M. caliginosus* was obtained from several individual hosts always in the same position and does not vary. The form on *M. epicurus* and *M. latifrons* is slightly different, in that the perithecium does not project at right angles from the receptacle, is somewhat narrowed toward the tip, while the stiff black branchlets of the appendages are distally enlarged, having a club-shaped habit.

LABOULBENIA CAULICULATA Thaxter. Plate LVII, figs. 8-10.  
Proc. Am. Acad. Arts and Sci., Vol. XXXVIII, p. 29. June, 1902.

Perithecium short and stout, straight or slightly curved, inflated more prominently on its inner side; dull olivaceous brown, translucent, or becoming opaque; the basal wall-cells forming a well-defined pale olivaceous or hyaline narrow stalk; the tip black, broad, not distinguished, except by its color; the rather coarse, but not prominent, lip-edges hyaline and outwardly oblique. Receptacle relatively short and small, the basal cell usually curved, narrow and subhyaline below, becoming opaque and punctate distally; the subbasal cell having only a small portion of its posterior margin free, cell III being subtriangular and overlapping it; cell IV nearly as broad as, and somewhat larger than cell III, separated from cell V, which may equal it in size, by a vertical or but slightly oblique septum; cells II-VI mostly translucent yellowish brown, often becoming opaque. Insertion-cell rather broad: basal cells of the appendages hardly distinguishable, the outer giving rise abruptly to usually two erect, or slightly divergent, stiff, bristle-like, curved branches, which are blackish brown, externally opaque, producing short hyaline branchlets along their hyaline inner margins: the basal cell of the inner appendage producing a branch on either side consisting of from one to two cells from which arise several branchlets similar to those of the outer appendages. Spores  $58 \times 5 \mu$ . Perithecia  $125-165 \times 45-60 \mu$ , including stalk ( $18-22 \mu$ ). Receptacle  $90-100 \times 35-40 \mu$ . Appendages  $125-185 \mu$ . Total length to tip of perithecium  $220-290 \mu$ .

On *Colpocaccus Lanaiensis* Sharp, No. 1226; *C. marginatus* Sharp, Kauai, No. 1228; on *Atelothrus depressus* Sharp, Lanai, No. 1231; *A. constrictus* Sharp, Molokai, No. 1234; *Mesothriseus Hawaiiensis* Sharp, Hawaii, No. 1238; *M. alternans* Sharp, No. 1220, Kauai, No. 1242, Maui, 1241 and 1244 Oahu; *M. muscicola* Blkm., No. 1236, Tahura; *Metromenus fraudator* Sharp, Nos. 1253, 1255, Maui; on other numbers of the Perkins Collection of Hawaiian Carabidæ as follows: Kauai, Nos. 1246-1248; Molokai, No. 1250; Maui, Nos. 1214, 1253, 1255.



## Var. PROLIXA Thaxter. Plate LVII, fig. 11.

Proc. Am. Acad. Arts and Sci., Vol. XXXVIII, p. 29. June, 1902.

Perithecium straight or slightly curved, large and greatly elongated, the body opaque; the neck usually elongate, hyaline or translucent. Receptacle as in the type, but usually translucent brownish yellow. Branches of the appendages usually more numerous and more slender, the two main branches of the inner often consisting of from three to four cells. Spores  $70 \times 5 \mu$ . Perithecia  $365-540 \times 55 \mu$ , including the stalk ( $90-220 \times 36 \mu$ ). Appendages  $220 \mu$ . Total length to tip of perithecium  $450-670 \mu$ .

On *Mesothriscus tricolor* Sharp, Molokai, No. 1239; *M. collaris* Sharp, No. 1240, Molokai; *Metromenus aqualis* Sharp, No. 1260, Oahu; and on No. 1235, Maui, in Perkins Collection.

## Var. SPECTABILIS Thaxter. Plate LVII, fig. 12.

Proc. Am. Acad. Arts and Sci., Vol. XXXVIII, p. 30. June, 1902.

Perithecium large, long, tapering more or less symmetrically above and below, strongly curved (or often recurved) outward throughout its length, including the clearly distinguished hyaline neck; dark olive brown, becoming nearly opaque, the black tip slightly distinguished, the lip-edges hyaline. Receptacle as in the type. Appendages as in the type, but one or both of the primary branches of the inner appendage hyaline, contrasting, many celled, and variably elongated through continued terminal proliferation, black branchlets arising one from each successive cell and alternating on opposite sides of the primary branch, often very long, curved upward and inward so as to cross one another, when two primary branches are present, with such regularity as often to form a lattice-work pattern; the series often complicated by the production of copious slender hyaline branchlets from the upper side of the secondary branches. Perithecia, main body,  $165-200 \times 40-48$ . Total length of appendages  $290-360 \mu$ .

On Hawaiian Carabidæ from Perkins Collection: No. 1261, on *Metromenus caliginosus* Blk., Honolulu, Oahu; No. 1179 and No. 1259 (Type); on *M. mutabilis* Blk., Oahu; Nos. 1254 and 1256, on *M. latifrons* Sharp, Molokai.

It has been with some hesitation that I have separated the three forms included under this species as varieties, yet repeated recomparison of my material has only served to convince me that, although three species are probably in process of differentiation here, it is better to consider them varieties. *L. caudiculata* (typica) might well be separated from *L. spectabilis*, yet between them lie various modifications of *L. proluxa* which cannot be separated on the one hand from the type, and on the other from *L. spectabilis*. The latter, which is one of the most beautiful and striking forms in the whole group of Laboulbeniales is characterized by the form and curvature of the perithecium and of its slender more abruptly distinguished neck, as well as by the more luxuriant, though variable, development of the branches of its inner appendages. An extreme illustration of this is represented in fig. 12; but in no respect does this branching differ, except in its luxuriance from that of *L. proluxa*. The latter form on the other hand, although distinguished in general by its larger size, and large elongate perithecium and neck, varies to less striking forms which cannot, I think, be distinguished from the usually smaller type-form of *L. caudiculata*. Although the habit of the receptacle differs in all three varieties, the appendages do not differ greatly from well developed specimens of *L. Disenochi*, the main axis of the outer appendage, and of the primary branches of the inner, differing from the fact that in the present species the branchlets alternate on opposite sides of the main axis, and that these branchlets, in *L. proluxa* and *L. spectabilis* especially, give rise to often very long slender and copiously developed unilateral hyaline branchlets.

Of the accompanying figures fig. 8 represents a type from *Colpococcus Lanaiensis* var.; fig. 9 from host *indet.* No. 1246; fig. 10 from *Metromenus fraudator*; fig. 11 (*L. proluxa*), Type, on *Mesothriscus tricolor* Shp.; fig. 12 (*L. spectabilis*) Type on *Metromenus mutabilis* Shp.

## LABOULBENIA MEXICANA Thaxter.

Although the appendages of this as well as of the succeeding species bear no very close resemblance to the type which I have distinguished as the "*Galerita* type," it seems more than probable that they rep-



represent the original *flagellata*-like condition from which this series has been derived; since the species is the most universally distributed form that occurs on *Galerita* in the western hemisphere. The antheridia, instead of arising terminally from special branches, occur one to three together below the septa of branchlets borne on the branches of the inner appendage. The typical form of this species, which occurs only in Mexico and Central America, is stout and large, sometimes more than a millimeter in length, usually amber-brown throughout; although in a few instances the perithecium becomes smoky brown, a condition well marked in material from Columbia and Costa Rica (Berlin Museum No. 967 and British Museum No. 521). These forms, as is pointed out below, approach perhaps too closely to *L. melanothea*, which is otherwise very clearly distinguished, even when it occurs in company with the present species on the same host. South of the Isthmus of Panama, however, material from Venezuela, Peru, Brazil and the Argentine, shows a distinct variation from the type; the individuals approaching the "*flagellata*" type more closely; usually smaller, sometimes not over 300  $\mu$  in length, pale straw-colored, with a contrasting black perithecial tip, and more or less strongly marked olive-brown suffusions; never, as far as I have seen, assuming the typical amber-brown tint. The appendages of these more southern types are also usually more slender and tapering, and sometimes exceed the receptacle in length. The specimens from Peru with their dark perithecia and numerous divergent branches are especially characteristic.

Specimens of this form have been examined as follows. British Museum: No. 521 on *Galerita Lecontei* Dej., Costa Rica; No. 520 on *Galerita* sp., Mexico; No. 709 on *G. Americana* Linn., Volcan de Chiriqui, Panama; No. 514 on *G. pallidicornis* Reich., Columbia; No. 708 on *G. aquinoctialis* Chd., Ventanas, Mexico; No. 517 on *G. unicolor* Dej., Brazil and Forest of Santarem, Amazon, No. 518. Hope Collection, No. 246, on *G. ruficollis* Latr., No. 255 on *Galerita* sp., Venezuela; No. 257 on *G. ruficollis* Dej., Cuba. Paris Museum No. 136 on *Galerita* sp., South America and Nos. 73-74, Venezuela; No. 160, Rosario, Argentina. U. S. National Museum, on *Galerita* spp., Brazil and Peru. Berlin Museum No. 962 on *Galerita* sp., Bahia, Brazil; No. 963 on *G. striata* Klg., Port au Prince; No. 964 on *Galerita* sp., Columbia; No. 965 on *Galerita* sp., Guayaquil, Ecuador; No. 960 on *G. carbonaria* Mannerh., Brazil; No. 968 on *G. pallidicornis* Reich., Columbia. Occurring on various parts of the host but most commonly on the elytra.

#### LABOULBENIA MELANOTHECA Thaxter.

It is not altogether certain that this form might not better be designated as a var. *melanothea* of *L. Mexicana*; since certain specimens on *Galerita pallidicornis* (?) from Columbia (Berlin Museum, No. 967) and on *G. Lecontei* from Costa Rica (British Museum, No. 521) both of which were found growing at the bases of the anterior legs, seem to represent a transitional condition, and have been referred to *L. Mexicana* rather than to the present form. Nevertheless the typical *L. Mexicana* when it occurs, as it sometimes does abundantly, in company with *L. melanothea* on the same host, shows no tendency to intergrade, and the two may be distinguished at once with a hand lens. Typical *L. melanothea* has been obtained as follows: British Museum, No. 521 on *Galerita Lecontei* Dej., Costa Rica; No. 710 on *G. ruficollis* Latr., Nicaragua; these specimens being exactly like the type in the form and coloration of their perithecia, which project at an angle to the axis of the receptacle and are furnished with slender hyaline necks, the wall-cells showing a slight spiral twist. It is uncertain whether *G. ruficollis* here referred to, is the same with *G. erythrodera* Brullé of which *G. ruficollis* Dej. is a synonym, or whether it is *G. ruficollis* Latr. which appears to be a different form.

#### LABOULBENIA ANGULARIS Thaxter. Plate LXIII, fig. 16-17.

Proc. Am. Acad. Arts and Sci., Vol. XXXV, p. 157. Dec., 1899.

Perithecium wholly free, symmetrically inflated, straight, evenly suffused with smoky brown except the very short narrow hyaline neck-like base; the tip well differentiated, black, distally hyaline, the whole perithecium inserted nearly at right angles to the axis of the receptacle. Receptacle amber-yellow or amber-



brown, the basal cell tinged with smoky brown, cell II abruptly broader and long, all the cells except cell I more or less conspicuously marked by short transverse striæ, cell V bulging on the inner side and carrying the black insertion-cell out free from the neck of the perithecium. Outer appendage consisting of an erect series of about six obliquely superposed cells, the lower becoming nearly opaque, the basal one larger and darker, opaque externally and below; each cell bearing externally a single simple branch, the branches consisting of a basal portion of mostly three short cells prominently constricted at the blackish septa, and a terminal portion (unicellular (?), brownish): the inner appendage consisting of a basal cell which gives rise to a series of superposed cells on either side, like that of the outer appendage and similarly branched, one of the series in the types much shorter than the other (two and four celled): the branches all erect, closely apposed, more or less suffused with brownish. Perithecia  $280 \times 45-55 \mu$ . Total length to tip of perithecium  $680 \mu$ ; to insertion-cell  $420 \mu$ ; greatest width  $75 \mu$ . Appendages (broken)  $55 \mu$ .

On *Galerita unicolor* Dej., Brit. Mus. No. 516, Amazon River. Inferior surface of prothorax.

Two specimens only of this well marked species one of which is badly broken, have been examined. It bears some resemblance to *L. melanotheca* in general appearance; but the appendages at once distinguish it, not to mention other points of difference. The antheridia are broken in both specimens but appear to have been solitary. The perithecial tip, represented in fig. 17, is drawn from the second broken specimen, and appears to represent a view at right angles to that shown in fig. 16. It is possible, however, that this may have been somewhat abnormally developed, as the specimen is evidently old.

LABOULBENIA SPECIOSA Thaxter. Plate LXII, fig. 5.

Proc. Am. Acad. Arts and Sci., Vol. XXXV, p. 201. Dec., 1899.

Perithecium free, long and narrow, somewhat swollen at the base, the inner half or less hyaline, the outer dark clear blackish brown; the basal wall-cells forming a short hyaline stalk narrower than the ascigerous portion; the tip hardly distinguished, bluntly rounded, slightly oblique outwardly, black, hyaline about the pore. Receptacle very elongate, hyaline except cells IV and V which are tinged with amber-yellow, indistinctly punctate with short transverse striæ except cell I; cell II very elongate. Insertion-cell black, free from the stalk of the perithecium through the slight enlargement of cell V. Outer appendage consisting of a series of five to eight cells superposed not very obliquely, the basal one larger tinged with brown below, the rest hyaline; all the cells producing externally a single simple branch, the lower three, sometimes two, cells of which are mostly not longer than broad, constricted at the black septa, distally faintly brownish yellow; the inner appendage consisting of a basal cell which bears on either side a branch consisting of a series of about four cells, like that of the outer appendage, and bearing similar branches in a similar fashion; the three series quite distinct from one another. Perithecium, including its short neck, about  $285 \times 56 \mu$ . Total length to tip of perithecium  $750-925 \mu$ ; to insertion-cell  $450-650 \mu$ . Appendages about  $200-280 \mu$ .

On *Galerita unicolor* Dej., Brit. Mus. No. 517, Brazil. On inferior surface of the prothorax. On *Galerita* sp. indet., Bahia, Brazil, at base of mid legs: Berlin Museum No. 962.

Four specimens of this very distinct and beautiful species have been examined, none of which show any perceptible variation from the type. The antheridia in all are either broken, or so disorganized that it is not possible to describe them in detail. They appear, however, to have been solitary, colorless, and unusually long. Although the bases of the branches of the appendages are usually three-celled (the cells distinguished by blackened septa) the upper ones occasionally include but two. The species is perhaps as nearly allied to *L. angularis* as to any of the other species, but its black and white perithecium is in itself sufficient to distinguish this apparently rare form from other known species.

LABOULBENIA CORNICULATA Thaxter. Plate LXII, fig. 17.

Proc. Am. Acad. Arts and Sci., Vol. XXXVIII, p. 31. June, 1902.

Hyaline becoming pale yellowish. Perithecium becoming tinged with brown, usually bent inward from the base at an angle to the axis of the perithecium, sometimes at right angles (the appendages and



their insertion undergoing a corresponding change in position), relatively stout and short, somewhat irregular in form, distally slightly inflated, with a more or less well-marked external elevation just above the base; the tip rather abruptly distinguished, relatively narrow, the apex broadly hyaline, with coarse irregularly prominent lips, the lower half black, subtended externally by a well-developed, horn-like, blunt-tipped, hyaline outgrowth, which is larger than the whole tip and slightly curved outward. Receptacle colorless or pale yellowish, the basal and subbasal cells of about the same diameter throughout, subequal, rather long and stout in contrast to the small, compact distal portion; cells III and IV subequal, or cell IV larger, the septum between them nearly horizontal, *i. e.* cell III is not extended upward externally beside cell IV; cell V triangular, relatively small and, like cell IV, slightly suffused above with brownish yellow, below the very broad, thin, clearly defined, black insertion-cell, the upper hyaline angle of which protrudes between the basal cells of the appendages. Appendages similar in type to those of *L. Galerita*, hyaline, the outer consisting of about five to seven very obliquely superposed cells, which bear the simple branches externally; the basal part of each branch consisting usually of two to three short brownish inflated or squarish cells, distinguished by constrictions and dark septa, the distal part about equal to the basal in length, or somewhat longer, often unicellular, hyaline, stained reddish in the types, very thick-walled, slightly inflated at the base; the tip bent slightly, tapering or even slightly inflated. The inner appendages similar to the outer, the basal part of the branches usually three-celled, the lowest, and sometimes that next above it, consisting of a single cell which bears terminally a single relatively large antheridium, the long stout neck of which is rather abruptly bent near the middle. Spores  $90-110 \times 7 \mu$ . Perithecia  $175-240 \times 60-80 \mu$ . The horn-like projection about  $40 \times 22 \mu$ . Receptacle  $325-475 \mu$ . Greatest total length of appendages  $450-600 \mu$ .

On inferior surface of *Galerita carbonaria* Mannerh., Brazil; Berlin Museum, No. 960.

This is one of the finest and most characteristic species of the genus, and is the only one of this section in which the perithecium is provided with a tooth-like outgrowth. The basal half of the simple branches of the inner appendages appears always to be composed of three cells, distinguished by black septa; but the lowest branch of the outer appendage has but two such cells. The solitary antheridia are unusually large, with stout necks abruptly and characteristically bent. The reddish color by which the distal portion of the branches is suffused may be accidental, but is present in all the specimens examined, both young and mature. It is perhaps more nearly allied to *L. speciosa* than to any other species and was found associated with several other wholly unrelated forms.

LABOULBENIA TRICHOGNATHI Thaxter. Plate LXII, figs. 1-2.

Proc. Am. Acad. Arts and Sci., Vol. XXXV, p. 206. Dec., 1899.

Perithecium free, generally straight, long, narrow and of nearly equal diameter throughout, to the base of the rather abruptly differentiated tip (sometimes, however, shorter, stout and slightly inflated), pale yellowish or becoming rather deep, evenly translucent smoky brown; the basal wall-cells forming a very short scarcely noticeable stalk; the tip obliquely black below the rather coarse and prominent hyaline lips. Receptacle generally very long and slender, pale yellowish, the basal cell tinged with blackish brown; cells IV and V amber or often becoming wholly amber-brown or smoky brown; cells IV and V large, prominently marked, especially when suffused, by short transverse lines or patches which are less numerous and distinct on the other cells. Insertion-cell well differentiated, black, carried out free from the perithecium by the enlargement of cell V. Outer appendage consisting of a series of obliquely superposed cells three to ten in number, the basal one subtriangular and blackish, the rest hyaline or yellowish, each producing distally and externally a single simple straight branch, slightly constricted at the three to four lower black septa; the distal portion without black septa, sometimes short, sometimes elongate and tapering. The inner appendage consists of a basal cell usually giving rise on either side to a single series of superposed cells, which may be further multiplied through the formation by proliferation of secondary series of superposed cells, similar to those of the outer appendage. Perithecia  $165 \times 55-350 \times$



90  $\mu$ , average  $275 \times 60 \mu$ . Receptacle very variable. Total length to tip of perithecium 425–1480  $\mu$ ; to insertion-cell 275–1260  $\mu$ . Appendages, longest 600  $\mu$ , average about 400  $\mu$ .

On *Trichognathus marginipennis* Latr., Hope Collection, No. 267, Columbia, Brit. Mus. No. 525, "Tamaz," S. America; on "*T. marginata* Latr." Brit. Mus. No. 526, Brazil: Hope Collection, No. 266, "S. America"; on *Trichognathus* sp. indet.: Paris Museum, Nos. 70, 71, and 135, Venezuela and "S. America." Berlin Mus. No. 955 on *T. immarginatus*, Columbia; No. 957 on *T. cinctus* Chaud., Caracas, Venezuela. On all parts of host.

This species appears to be a decidedly variable one, not only in size and coloration, but in the development of its appendages. It is the only species of the section in which the cells of the inner primary appendages may show a secondary proliferation which results in more than the normal single series of appendiculate cells. This proliferation gives rise to variably developed secondary series of appendiculate cells, each of which bears its branch; so that where this phenomenon is pronounced, the inner appendages, as a whole, give rise to a dense tuft of very numerous branches; especially noticeable in the material on the Paris specimen, No 135, from Venezuela. Although the ordinary form, in which the inner appendages consist, as usual, each of a single series of obliquely superposed appendiculate cells, this simpler form may be associated on the same host with others in which a greater or less degree of complication has resulted through the proliferation above referred to. In the simpler type, the branches tend to be more or less constant, with two basal cells usually little, or not at all, inflated, and distinguished by blackened septa; but in the proliferous conditions, especially, this distinction is more or less lost; the number of blackened septa varying very considerably, as is indicated in fig. 2. The antheridia are normally paired, dark, and borne on a rather long single stalk-cell. Small specimens of this species are not unlike certain individuals of *L. Helluomorphæ*, or even of *L. triordinata*; the essential differences of which are pointed out under these species. It is apparently not uncommon on its host, which is a carabid allied to *Galerita* and *Brachinus*.

LABOULBENIA ADUNCA Thaxter. Plate LXII, figs. 7-9.

Proc. Am. Acad. Arts and Sci., Vol. XXXV, p. 151. Dec., 1899.

Perithecium long and slender, straight or nearly so, the outer half clear dark translucent brown, the inner pale olivaceous, wholly free, a short well distinguished hyaline neck formed by the basal wall-cells; the tip well distinguished, wholly blackish below or especially on the inner side, the inner lips black-margined, curved outward completely over the outer lips in a characteristic hook-like fashion. Receptacle uniform dirty olivaceous, cell I paler, the cells above it faintly punctate. Insertion-cell black, broad, indistinguishable from the blackened basal portions of the basal cells of the appendages. Outer appendage consisting of a very large externally rounded basal cell, becoming wholly blackened, except its upper margin, and surmounted by a series of usually six superposed hyaline cells which is curved toward the perithecium, each cell producing externally a single simple branch consisting of a basal portion made up of two roundish short cells constricted at the dark septa, and a distal portion six or more times as long, tapering, hyaline or tinged with brownish; the inner appendages consisting of basal cells wholly or almost wholly black, giving rise on either side to a short series of cells, usually three or four, similar to that of the outer appendage and similarly branched. Perithecia  $225-245 \times 40 \mu$  (including neck, which is about 18  $\mu$  long). Total length to tip of perithecium, average 450  $\mu$ ; to insertion-cell 200  $\mu$ , greatest width 50  $\mu$ . Appendages 150  $\mu$ .

On *Galerita unicolor* Dej., Brit. Mus. No. 516, Amazon River. Inferior surface of prothorax.

This species is distinguished from *L. geniculata*, to which it appears to be most nearly allied, by the peculiar conformation of the tip of its perithecium, as well as by the color of the latter, which is evenly suffused in the last mentioned species. The externally rounded basal cell of the outer appendage and the general suffusion and punctation of all the cells of the straight receptacle, above cell I, serve further to distinguish it.



## LABOULBENIA GENICULATA Thaxter. Plate LXIV, figs. 2-3.

Proc. Am. Acad. Arts and Sci., Vol. XXXV, p. 178. Dec., 1899.

Perithecium free, long and narrow, evenly tinged with translucent olive-brown except the short somewhat constricted hyaline neck, the tip well distinguished, blackish brown, bent outward, the lips coarse subhyaline oblique outward. Receptacle nearly hyaline, except cell II, and sometimes the upper part of cell I which is suffused with dirty olive-brown and faintly punctate with fine transverse striæ, long and slender, geniculate above cell II. Insertion-cell broad, black, close to base of perithecial neck. Outer appendage consisting of a larger basal subtriangular cell becoming more or less suffused with olive-brown, its outer edge straight, surmounted by a series of five or six obliquely superposed hyaline cells which curves inward toward the perithecium; each cell of the series bearing externally a simple branch consisting of two short faintly brownish basal cells constricted at the blackish septa, and a terminal hyaline tapering portion about twice as long: the inner appendage consisting of a basal cell blackened below, from which arises on either side a series of superposed cells like that of the outer appendage and similarly branched, except that one or two of the lower cells of the series bear antheridia, solitary, on a unicellular stalk. Perithecia  $200-285 \times 37 \mu$  (the neck,  $18-20 \mu$ , included). Total length to tip of perithecium  $500-670 \mu$ ; to insertion-cell  $275-370 \mu$ ; greatest width  $55 \mu$ . Spores  $65-70 \times 5 \mu$ . Appendages  $150-175 \mu$ .

On *Galerita* sp., Paris Museum, No. 160, Rosario, Argentine Republic. On left side of inferior prothorax.

The material of this form is not abundant, but all the specimens examined have the same geniculate habit and show no variations. The species possesses no very striking individual characters except its geniculate habit, which may prove inconstant; yet it does not seem possible to refer it to any of the other described species. It is most closely allied to *L. adunca*, the distinguishing points of difference in which have already been referred to under that species.

## LABOULBENIA INCERTA Thaxter. Plate LXIV, fig. 1.

Proc. Am. Acad. Arts and Sci., Vol. XXXVIII, p. 43. June, 1902.

Perithecium erect or slightly divergent, evenly suffused with rather pale or rarely darker translucent dirty brown, considerably, often almost symmetrically, inflated, slightly broader below; the basal wall-cells forming a short, often almost obsolete, hyaline stalk; the tip rather abruptly distinguished, usually bent slightly outward, short, stout, wholly suffused with brown, darker below; the apex evenly rounded as a rule; the outer lip-cells curved outward to the external pore, slightly prominent. Receptacle normal, hyaline, or faintly yellowish; the distal portion short and broad; the basal cell relatively short; cells III and IV subequal. The insertion-cell slightly oblique, black, contrasting, the opacity usually involving a part or the whole of the basal cells of the outer and inner appendages. Appendages similar to those of *L. perplexa*, more compact, with shorter branches; outer appendage consisting of about six to eight obliquely superposed cells, the branches divergent, curved upward; the two cells of the basal part stout, clear brown, constricted at the dark septa, roundish to long-oblong; the distal part rather stout, unicellular, tapering to a blunt apex and seldom reaching beyond the tip of the perithecium; the two branches of the inner appendage similar to the outer, except that the two lowest branches consist of a single cell, its basal septum alone dark and constricted, bearing distally a single rather short, slightly curved brown antheridium. Spores  $95-100 \times 8 \mu$ . Perithecia  $185-250 \times 60 \mu$ . Receptacle  $185-290 \times 70-80 \mu$ . Appendage  $200-250 \mu$ . Total length to tip of perithecium  $360-500 \mu$ .

On the superior and inferior surface of *Galerita carbonaria* Mannerh., Brazil; Berlin Museum, No. 960.

This species appears to be allied to *L. perplexa*, with which it was associated on the same host in company with *L. bicolor*, *L. corniculata* and *L. fusiformis*. It differs, however, in its short, nearly evenly inflated, evenly semitransparent olive-brown perithecium; which is characterized by a stouter, somewhat differently formed, coarse-lipped tip. The receptacle also differs from that of *L. perplexa* in being



nearly hyaline, or yellowish; while cells III and IV are separated by a horizontal septum, not obliquely superposed, as in the last mentioned form. The primary appendages are not divergent, as in *L. perplexa*, their branches much shorter, the basal cells of the primary appendages combining with the insertion cell to form a much broader black, and externally more prominent, general insertion. The perithecium of the present species is, in all the examples, marked by fine longitudinal wrinkles which may be due to a lack of complete turgescence in the mounted material.

LABOULBENIA TRIORDINATA Thaxter. Plate LXIII, fig. 15.

Proc. Am. Acad. Arts and Sci., Vol. XXXV, p. 207. Dec., 1899.

Perithecium usually wholly free from the receptacle, very variable, amber-brown or usually becoming almost black, paler subdistally, generally somewhat elongate, the wall-cells usually showing a distinct spiral twist, the basal wall-cells forming a hyaline or less deeply suffused neck; the tip wholly black except the lip-edges, which may be translucent brown and are more or less distinctly differentiated. Receptacle variable, minutely punctate, pale amber-brown or amber-yellow, gradually tapering from the base to the often relatively broad distal portion, or more commonly cells I and II forming a slender stalk above which the rest of the receptacle expands abruptly, the unmodified colorless triangular insertion-cell carried up and out free from the receptacle through the enlargement of cell V, the inner margin of which is mostly free. Outer appendage consisting of a series of about seven to ten obliquely superposed cells, each bearing distally and externally a single simple branch; the branches constricted at the first, second, and third septa, which are deeply blackened; the second less conspicuously, the basal and subbasal cells variably suffused with clear brown especially near the septa, the distal portion of the branch hyaline, tapering, somewhat inflated above its usually brown base: inner appendage consisting of a basal cell which gives rise on either side to a branch resembling the outer appendage, often with fewer cells (sometimes only 3-celled) similarly branched, except that the lower branch consists of a single cell which bears terminally a solitary antheridium that becomes brown; the outer appendage and the two branches of the inner erect and close together, or more or less strongly and irregularly divergent. Perithecia, average  $200 \times 52 \mu$  ( $110-260 \times 45-60 \mu$ ) including stalk. Total length to tip of perithecium  $260-600 \mu$ ; to insertion-cell  $185-370 \mu$ ; greatest width  $65-100 \mu$ . Appendages  $220-330 \mu$ .

On *Calophæna bifasciata* Oliv., Brit. Mus. No. 509, South America; on *Calophæna* sp., Brit. Mus. No. 512, Nanta, Amazon; on *C. bicinctus* Dej., Hope Collection, No. 268, Brit. Mus. 508, Columbia; on *Calophæna* sp., U. S. National Museum, Central America; Berlin Mus. No. 953, on *Calophæna bicinctus* Dej., Bogota.

The typical form of this species shows variations of no great importance, which are, for the most part, dependent on the variable development of its receptacle, of which fig. 15 shows an average form. Many, however, are more elongate, while very often a peculiar habit results from the fact that the two basal cells become abruptly distinguished from the distal portion, as a slender stalk. Individuals also occur in which the general form is quite normal, like other members of the *L. flagellata* type. A single small group of individuals obtained from the inferior surface of the prothorax of *Calophæna bifasciata* (Brit. Mus. No. 509), though otherwise similar to the type, possess a narrow black insertion cell: while on the legs of *Cordistes (Calophæna) bicinctus* Dej. (Hope Coll. No. 268) as well as from a Central American *Calophæna* in the U. S. Nat. Mus., No. 19, a well marked variety has been found, strikingly unlike the type from the fact that its more compact receptacle is, with the exception of its basal cell, deeply suffused with blackish brown, the suffusion involving the insertion-cell as well as the basal cells of the appendages.

The tip of the perithecium, in specimens in which the twist in the wall-cells is sufficient to give a posterior view, show a symmetrically bluntly bilobed outline, somewhat similar to that of *L. aristata* (Plate LX, figs. 27-29). The species is allied to *L. Helluomorphæ*, which is most easily distinguished by the black septum which subtends its antheridium, and also approaches *L. perplexa* in the tendency to diverge shown by the primary axes of its appendages; a character which is, however, not always pronounced.



## LABOULBENIA HELLUOMORPHÆ Thaxter. Plate LXIII, figs. 13-14.

Proc. Am. Acad. Arts and Sci., Vol. XXXVIII, p. 42. June, 1902.

Perithecium straight or slightly divergent, hyaline to yellowish, becoming somewhat tinged with smoky brown; the basal wall-cells forming a scarcely apparent short stalk; the blackish tip abruptly distinguished; the coarse translucent lip-edges outwardly oblique. Receptacle normal, hyaline to straw-yellow, distally obscurely punctate and slightly suffused with faint brownish shades; cells III, IV and VI subequal; cell V rather large, its inner margin more than one half free, nearly vertical, the thick, black, slightly oblique insertion-cell thus free above the base of the perithecium. Basal cell large, more or less suffused with brown; the two or three cells above it obliquely superposed, hyaline; all the cells bearing distally and externally single simple branches, the basal part consisting of two cells, becoming clear brown, constricted at the dark septa; the distal part hyaline, or more faintly brownish, distinguished by a deep brown suffusion at the base: the inner appendage consisting of a very small hyaline basal cell, giving rise on either side to a very short branch, consisting of from one to two cells; the basal one bearing an antheridial branch, consisting of a single rather long cell terminated by a solitary brownish antheridium seated like the branch on a blackened septum. Spores  $70 \times 7 \mu$ . Perithecia  $130-140 \times 35-40 \mu$ . Receptacle  $220-180 \mu$ . Appendages  $185-300 \mu$ . Total length to tip of perithecium  $290-325 \mu$ .

On *Heluomorpha melanaria* Reiche, Ega, Amazon; British Museum, No. 527. On *Pleuracanthus brevicollis* Dej., Surinam; Berlin Museum, No. 942. On the elytra.

This species bears a general resemblance to small forms of both *L. triordinata* and *L. Trichognathi*. It is most easily distinguished from these, as well as from other known species of this section from the fact that not only the antheridial branch, but also the antheridium itself, is distinguished by a blackened septum. From *L. triordinata*, which it most nearly approaches, it is further distinguished by its normally black insertion-cell, and undeveloped inner primary appendages, which bear at most only two, or possibly very rarely, three, branches each.

## LABOULBENIA MINIMALIS Thaxter. Plate LXII, figs. 10-11.

Proc. Am. Acad. Arts and Sci., Vol. XXXV, p. 188. Dec., 1899.

Perithecium free, becoming olivaceous to smoky brown, mostly straight, the basal wall-cells forming a very short stalk, the tip rather abruptly distinguished, mostly straight, symmetrical, black, distally hyaline. Receptacle olivaceous yellow with brown suffusions; cell I slightly suffused with brown, somewhat longer than cell II, both rather narrow; the receptacle expanding rather abruptly above cell II; cells III, IV, and V nearly equal becoming rather deeply suffused with brown. Insertion-cell broad, blackened. Outer appendage consisting of a large triangular basal cell becoming deep blackish brown, above which four to six small nearly hyaline cells obliquely superposed, or with their long axes nearly vertical, form a series which runs obliquely toward the perithecium, each cell producing externally a single simple branch consisting normally of three cells; the basal subhyaline, much longer (especially in the upper branches) than the subbasal, which is somewhat suffused, broader below, slightly inflated, distinguished above and below by blackened septa; the terminal cell short hyaline, mostly somewhat swollen and soon disorganized: the inner appendage consisting of a series of cells similar to that of the outer, usually four in number, each bearing an antheridial branch which consists of a subhyaline relatively long stalk-cell, seated on a blackened septum and bearing distally a pair of slightly divergent long brown antheridia about equalling the stalk-cell in length; their tips usually exceeding those of the sterile branches of the outer appendages. Perithecia  $100-110 \times 30 \mu$ . Total length to tip of perithecium  $200-250 \mu$ , to insertion-cell  $110-125 \mu$ ; greatest width  $45 \mu$ . Appendages  $60-90 \mu$ .

On *Galerita* sp. Paris Museum No. 74, Venezuela, on the mid-elytron. On a small species of *Galerita* with red prothorax from Guayaquil, Ecuador, Berlin Museum, No. 965.

This small species, of which sufficiently abundant and perfect material has been examined, is one of the most readily recognized members of this section, distinguished by its small size and the character of



its antheridial branches, and its antheridia, which are relatively large, and usually exceed the sterile branches in length, a condition seen in no other species. The cells of the inner primary appendages may all bear such antheridial branches, but in a few instances the uppermost is replaced, as in fig. 11, by a sterile branch similar to those of the outer appendage. The perithecium is often more deeply suffused than is represented in the figures and the wall-cells seem, in old individuals, to be spirally twisted.

LABOULBENIA GALERITÆ Thaxter.

This fine species which is distinguished by its contrasting black and white color, black punctate perithecium, and normal receptacle in which cells III and IV are separated by a horizontal septum, is the common species on *Galerita* in temperate and tropical North America; but does not appear to extend south beyond the Isthmus, though specimens have been examined from Nicaragua and the West Indies. The antheridia appear to occur always in terminal groups of two or three. Additional material has been examined from the following sources. On *Galerita* sp., Iowa: on *G. Janus* Fabr., Illinois: on *G. California* Lec., California; U. S. Nat Mus., No. 47, *Galerita* sp., Florida. Hope Collection No. 253 on *G. atripes* Lec., Texas: Berlin Mus., No. 970 on *G. tenebriosa* Klg., Port au Prince, Haiti: No. 967 on *Galerita* sp., Nicaragua: Sharp Collection, No. 1192 on *G. Forreri* Bates, Presidio, Mexico. British Museum; No. 712 on *G. Mexicana*, Chaud., Oaxaca, Mexico, No. 711.

**Laboulbenia subpunctata**, nov. sp. Plate LXIV, figs. 5-6.

Perithecium relatively large, longer than, sometimes nearly twice as long as, the receptacle; usually straight, sometimes curved, cylindrical or slightly inflated, dirty yellow, becoming tinged more or less deeply with rather rich brown; the lower fifth or half, rarely more, flecked by scattered dark rounded spots, which are larger and more irregular in shape toward the base; the tip rather abruptly distinguished, mostly abruptly darker; the apex hyaline yellowish, the pore terminal, or slightly sublateral: a well distinguished hyaline stalk slightly narrower than the base of the perithecium, as a rule, its length not equalling its breadth. Receptacle normally relatively short and compact, the basal cell quite hyaline and contrasting abruptly with the deeply suffused subbasal cell from which it is obliquely separated, and below which it bulges more or less prominently on the posterior side: cells II and III becoming quite opaque, the former often projecting more or less conspicuously below the latter, which extends up to the lower outer angle of the insertion-cell, below which it forms a usually well defined rounded projection: cells IV and V becoming deeply suffused, but seldom opaque, their long axes parallel with that of cell III: cells II-V nearly hyaline immediately below the contrasting black insertion-cell: cell VI relatively long, somewhat less deeply suffused especially at its base, the cells above it somewhat prominent, concolorous, often flecked with darker irregular patches. Insertion-cell broad, black, the opacity involving the basal cells of the outer and inner appendages more or less completely; the former extending as a black rounded prominence external to the base of the branch (usually broken off) which it bears. The outer appendage consisting of about six very obliquely superposed cells, forming a compact series running inward toward the base of the perithecium, each bearing a single simple branch, the branches having a basal two-celled part, with constrictions at the blackened septa, clearly distinguished from a more elongate tapering distal hyaline portion, which extends not much above the upper third of the perithecium proper: inner appendage consisting of a basal cell, giving rise on either side to a series of cells so obliquely superposed that the long axis of the inner is nearly vertical; the three or four lower (outer) ones giving rise to antheridial branches, consisting of a basal cell about twice as long as broad, distinguished by a blackish basal septum, and bearing a relatively short strongly curved antheridium, exceeding it in length. Average length to tip of perithecium 400-450  $\mu$  (300-550  $\mu$ ): to insertion-cell, average, 170  $\mu$ , greatest width about 70  $\mu$ . Length of perithecium, including stalk, 180  $\times$  45-270  $\times$  50  $\mu$ , average 200  $\times$  40  $\mu$ . Appendages, total length including insertion-cell, 125-150  $\mu$ , the sterile branches longest 120  $\mu$ . Spores 44  $\times$  5  $\mu$ .

On *Galerita* sp., Rosario, Argentina. Paris Museum No. 160. On *Galerita* sp., Sierra Geral,



Brazil, Berlin Museum No. 966 Type; on *Galerita carbonaria* Mannerh., Brazil, Berlin Museum No. 960: on *G. unicolor* Amazon, British Museum No. 516, and No. 517 (Brazil). Usually on the prothorax, inferior or superior, and head.

This species has been separated from *L. punctata* to which it is very closely allied, and for which it might readily be mistaken, chiefly for the reason that its appendages and antheridia appear to be constantly different. The antheridia and their stalk cells are relatively short, the former strongly curved, while in *L. punctata* they are straight, very long, and borne on long stalk-cells. The branches of the outer appendage, which in *L. punctata* scarcely exceed the tips of the antheridia and are not distinguished by a basal and terminal portion, are distinctly thus distinguished in the present species, in which the three lower septa, only, are suffused; while this is the case with all the septa in *L. punctata*. The suffusion of the basal cells of the appendages which are indistinguishable from the insertion-cell, the external prominences formed by the basal cell of the outer appendage, and by cell III, give the individuals a peculiar habit unlike that of *L. punctata*. The material of the two species, as well as the sources from which it has been derived, are sufficiently varied to determine the constancy of the differences indicated. In a few individuals cell II of the receptacle is not opaque at maturity, but merely suffused and coarsely punctate. In some individuals the punctation of the perithecium may be almost obsolete, and is very rarely as general as in *L. punctata*.

LABOULBENIA PUNCTATA Thaxter. Plate LXIV, fig. 7.

Proc. Am. Acad. Arts and Sci., Vol. XXXV, p. 197. Dec., 1899.

Perithecium free, straight, translucent brown, sometimes becoming almost opaque, except the broad short neck formed by the basal wall-cells, which is nearly hyaline and as broad as the ascigerous portion; the lower half or more of the suffused body of the perithecium covered with irregular more or less rounded dark spots, irregularly distributed, the lower larger; the tip rather abruptly distinguished, narrow, black, distally translucent. Receptacle rather short and stout, the basal cell rather narrow and hyaline or yellowish, contrasting; the rest of the receptacle subtriangular and more or less deeply suffused; cell VI paler, cells III and IV side by side, nearly vertical, deeply suffused, except the upper edge; cell V relatively large, subhemispherical, becoming opaque; all the suffused cells where not opaque, more or less conspicuously and rather coarsely punctate. Insertion-cell very broad, black, close beside the base of the perithecial stalk. Outer appendage consisting of a large triangular basal cell externally blackish brown, forming the base of a series of (eight or less) much smaller cells obliquely superposed, which curves toward the perithecium; each cell producing externally a single simple erect branch, rather closely septate, the (usually six) septa dark, constricted, the terminal cell short with rounded apex. The inner appendage consisting of a basal cell giving rise to a series of cells on either side like that of the outer appendage, but shorter, one to three of the lower branches consisting of a single long cell bearing terminally a long slender flask-shaped brown antheridium. Perithecia  $200-220 \times 40 \mu$ ; smaller  $130 \times 48 \mu$  (including the neck about  $35 \mu$ ). Total length to tip of perithecium, average  $350 \mu$ ; to insertion-cell  $145 \mu$ ; greatest width  $75 \mu$ . Appendages  $110-130 \mu$ .

On *Galerita* sp., Paris Museum, No. 74, Venezuela, No. 136, "South America." On head of *G. pallidicornis* Reid. (= *G. Moritzi* Mann.), Columbia, Berlin Museum No. 968.

The perithecium of this species possesses the same peculiar dirty yellowish coloring, often obscured by brown suffusions, which characterizes that of *L. subpunctata*, as well as the peculiar irregular coarse punctation which is much less well marked in the last mentioned species. The undifferentiated branches of the appendages, the cells of which are all distinguished by dark septa; the long stalk-cells of the antheridia, the tips of which nearly reach the tips of the sterile branches; the form and coloration of the basal cells of the appendages, as well as of the receptacle, and to a less extent the broader stalk of the perithecium, are characters which serve to separate the present species from its near ally.



## LABOULBENIA FUSIFORMIS Thaxter. Plate LXIV, fig. 4.

Proc. Am. Acad. Arts and Sci., Vol. XXXVIII, p. 39. June, 1902.

Perithecium relatively long and slender, becoming nearly opaque and marked by scattered blackish points more conspicuous near the base, sometimes nearly obsolete, erect, or slightly divergent above the stalk, straight, subfusiform; the basal wall-cells forming a short hyaline stalk; the tip often rather abruptly differentiated, darker, often curved outward; the lips suffused, or the edges hyaline. Receptacle very long and slender; the basal cell short, nearly hyaline; the rest pale dull brownish, indistinctly transversely striate-punctate; cell II very long, isodiametric, throughout, except where its distal end is obliquely overlapped for a short distance by cell VI, separated by a short horizontal septum from cell III, which is much elongated and is separated from cell IV by an oblique septum, above which the receptacle shows a slight but abrupt contraction in diameter; cell IV more than twice as long as cell V. Insertion-cell black and thick, the blackening involving the greater portion of the basal cell of the outer appendage. Appendages very similar to those of *L. perplexa*, the basal cells of the branches somewhat darker, the distal part somewhat shorter. Spores  $90 \times 7 \mu$ . Perithecia  $450-580 \times 60-75 \mu$  including stalk ( $40 \mu$ ). Receptacle  $500 \mu$  to over 1 mm.  $\times 70-75 \mu$ . Appendages  $275-375 \mu$ . Total length to tip of perithecium 1.65 mm.

On the inferior surface of the prothorax of *Galerita carbonaria* Mannerh., Brazil; Berlin Museum, No. 960.

This species is so large that it has been necessary to reduce to  $\times 150$  the magnification ( $\times 260$ ) used in figuring its allies. Although apparently so well distinguished, especially by its very peculiar, usually distinctly punctate, perithecium, I feel uncertain whether it may not possibly prove no more than a variety of *L. perplexa*, brought about, perhaps, by more abundant nutrition, afforded by its position of growth on the host. It was found associated with *L. perplexa*, *L. incerta*, *L. corniculata*, and *L. bicolor* on the same individual.

## LABOULBENIA PERPLEXA Thaxter. Plate LXIII, fig. 18.

Proc. Am. Acad. Arts and Sci., Vol. XXXVIII, p. 49. June, 1902.

Perithecium very large and long, not twice as long as the receptacle, dull translucent olive-brown, or becoming blackish brown, straight, usually erect, nearly isodiametric, or often subelavate, tapering slightly below to a short rather narrow hyaline contrasting stalk formed by the basal wall-cells; the sub-basal wall-cells slightly spiral, making from one quarter to one half a turn; the tip short, blunt, blackish, generally not well distinguished, sometimes bent rather abruptly inward. Receptacle short, the basal cell nearly hyaline, somewhat elongate, the rest of the receptacle hardly exceeding it in length, dirty olive brown, becoming more deeply suffused with brown or blackish brown and somewhat mottled; cell II small, separated from cells III and VI by very oblique septa, its lower third or fourth, only, free; cells II, III, VI and often IV not differing greatly in size, their inner angles often converging to a common point at about the centre of the distal portion of the receptacle; cell III triangular or subtriangular, extending upward to a point just below the insertion-cell, and downward often nearly to the base of cell II; cell V but slightly smaller than cell IV. Insertion-cell slightly oblique, well defined, rather thick, broad, black. Appendages corresponding in type to those of *L. Galerita*, hyaline, or the lower cells becoming suffused more or less, but not deeply, with brown; the outer and inner free above the base, usually divergent; the outer consisting of from six to sometimes ten or more obliquely superposed cells each of which bears externally a simple branch consisting of a two-celled basal part, the cells slightly longer than broad, constricted at the dark septa, clear brown; the distal part long, becoming slender, flexuous and hyaline toward its extremity, which may reach, or even exceed, the tip of the perithecium. The basal cell of the inner appendage producing a free branch on either side similar to the outer appendage, and bearing similar branchlets; except that the lowest, and usually the next above it, consist of single cells bearing terminally single brownish slightly curved antheridia. Spores  $90 \times 7 \mu$ . Perithecia 290-360



× 50-60  $\mu$ , including the stalk (40  $\mu$ ). Receptacle 220 × 60-70  $\mu$ . Appendages including branches 200-360  $\mu$ . Total length to tip of perithecium, average, 500  $\mu$ .

On the elytra and prothorax of *Galerita carbonaria* Mannerh., Brazil; Berlin Museum, No. 960.

This species, as I have noted above, may prove to be nothing more than the ordinary typical condition of a species in which a tendency to considerable variation culminates in the form described as *L. fusiformis*; and even *L. incerta*, despite the essential difference in the cell arrangement of its receptacle and its different type of perithecium may have to be united with it. As may be seen from the illustrations, however, the differences between these forms are sufficiently striking, and appear to warrant at least their provisional separation. Though quite unlike it in other respects *L. perplexa* resembles *L. triordinata* in the free vertical development of its primary appendages, and their divergence which is usually well marked.

LABOULBENIA DECIPIENS Thaxter. Plate LXIV, figs. 11-12.

Since it was originally described, a considerable amount of material of this species has been examined from various localities, as well as additional specimens from the original source. The original figure represents the maximum development of older individuals, in which the perithecium may become a dark olivaceous brown; but in general the brown coloration is not well marked, being replaced by olivaceous shades. There is considerable variation in the suffusions of the receptacle, which may be nearly hyaline, as well as in the prominence of the opacity of the basal cells of the appendages. A reexamination of the specimen from which the original figure was drawn, in which the appendages were badly broken and confused, shows further that the drawing is incorrect in that it represents the third and fourth branches of the inner appendage as of the sterile type. As a matter of fact in well developed specimens four, or even five, of the lower branches of the inner appendage may be antheridial, and in ordinary cases there are at least three such antheridial branches.

In South America the species varies to a usually smaller and more olivaceous form, fig. 12, and specimens from three sources on the upper Amazon, fig. 11, tend to vary, in that cells III-V are replaced by two cells; but individuals occasionally occur in this material having the normal number and arrangement. The receptacle apparently never becomes elongate and is often very short and compact. The twist in the perithecial wall-cells is always pronounced and characteristic, although it might readily be overlooked in paler specimens. The appendages in smaller forms are apt to become more elongate than in the larger, and may reach a length of 300  $\mu$ . An examination of over one hundred and fifty specimens shows an extreme variation in length from 675  $\mu$  in one specimen, to 225  $\mu$ , the Amazon specimens being usually smaller on the average.

*Laboulbenia Argentinensis* described by Spegazzini in the Anales del Museo Nacional de Buenos Aires, Tomo VIII (Ser. 3a, t. I) p. 79, of which the author has kindly furnished me an original sketch, appears to be one of the forms of the present species. Although it was described as occurring on a species of *Brachinus*, there seems to have been confusion as to the nature of the host, which was, with little doubt, the common *Galerita* of middle Argentina. The types have unfortunately been lost, so that there is no way of verifying the above reference. As sketched, the tip of the stalked perithecium is more blunt, the spiral wall-cells are not indicated, the sterile appendages are represented as moniliform throughout, though evidently broken, the antheridia large and sessile, the receptacle, however, just as in typical *L. confusa*. The original description is not intelligible and it would be quite impossible to determine the species from it.

The sources of the additional material of *L. decipiens* above referred to are as follows: U. S. National Museum; on *Galerita nigra* Chev., Paso Antonio, Guatemala; also No. 18, Maracaibo, Brazil. From the British Museum No. 708, on *G. æquinoctialis* Chd., Vera Paz, Guatemala; No. 518, on *G. unicolor* Dej., Amazon; No. 957 on *G. porcata* Kl., Cameté, Brazil; No. 963 on *G. striata* Klg., Port au Prince, Haiti; No. 958 on *G. melanaria* Erichs, British Guiana; No. 964 on *Galerita* sp., Columbia; No. 966 on *Galerita* sp., Sierra Geral, Brazil.



**Laboulbenia bicolor** nov. sp. Plate LXII, figs. 13–15.

Perithecium free, subsodiametric throughout, or with a slight general inflation, rich dark clear brown becoming almost opaque, often darker on the inner half, more or less granular; the granulation coarser at the base: the tip short, abruptly distinguished, broad, suffused, the inner lip often more prominent and hyaline: a clearly defined short hyaline stalk. Receptacle consisting of a contrasting hyaline basal cell as long as the balance of the receptacle, or nearly equalling it in length: cell III extending upward beside cell IV, its apex forming a prominence just below and external to the insertion-cell: cell II abruptly narrower than cell I, which is prominent below it, especially on the posterior side, opaque, the opacity involving finally cells II–VI, which usually remain more or less hyaline distally. Insertion-cell broad and black, continuous with the opaque basal cell of the outer appendage, which forms a more or less conspicuously developed upcurved external prominence, bearing the lower branch of the appendage, which is further composed of three or four obliquely superposed cells each bearing a single simple branch: the branches consisting of a basal and distal portion, the former two celled, the cells short inflated and distinguished by suffused septa; the latter unicellular, or spuriously septate, tapering, faintly brownish, or hyaline, mostly considerably shorter than the receptacle: the inner appendages consisting of a basal cell wholly or only partly suffused, the rest of the appendage consisting of about four hyaline obliquely superposed cells, bearing simple branches similar to those of the outer appendage; except that the basal and subbasal cells give rise to short stalk-cells, with single terminal antheridia; the latter with rather long curved slender necks, the base usually somewhat inflated, often broader than the stalk-cell, which is seated on a blackened septum. Perithecia, exclusive of stalk ( $18\ \mu$ ), type-form  $125\text{--}150 \times 18\text{--}32\ \mu$ ; larger form  $180\text{--}225 \times 45\ \mu$ . Receptacle, type-form  $100\text{--}125 \times 35\text{--}40\ \mu$ ; larger form  $100\text{--}150 \times 55\text{--}65\ \mu$ . Appendages  $125\text{--}150\ \mu$ . Total length to tip of perithecium, type-form  $275\text{--}300\ \mu$ , larger form  $325\text{--}400\ \mu$ . Spores type-form  $50 \times 5\ \mu$ , larger form  $65 \times 6\ \mu$ .

Type on a slender black *Galerita*, Paris Museum No. 73 Venezuela. Larger form on *Galerita carbonaria* Mannerh., Berlin Museum No. 960, Brazil. On the legs.

I have considered the smaller and more slender form from Venezuela as representing the type of this species (fig. 14), but although the Brazilian type presents constant differences in general size form and in the detail of the appendages, I think it should not be separated, even as a variety. It is conspicuous for the black and white effect of the contrasting regions of the perithecium and receptacle, which has suggested the specific name. The suffused portions of the receptacle, before becoming opaque, are usually more or less conspicuously mottled or punctate with darker flecks.

## LABOULBENIA COLPODIS Thaxter. Plate LXII, fig. 16.

Proc. Am. Acad. Arts and Sci., Vol. XXXV, p. 166. Dec., 1899.

Perithecium wholly free, very large, uniform clear translucent brown, slightly inflated or the margins straight, the basal wall-cells forming a well marked hyaline neck as broad as the base of the ascigerous portion from which it is not abruptly distinguished; the tip rather narrow and well distinguished, darker, the distinct lip-edges hyaline or translucent. Receptacle very small, cell I hyaline or yellowish, the rest more or less deeply suffused with blackish brown becoming nearly opaque, especially cells III and IV, which lie side by side and are about equal in size, cell III forming a rounded prominence just below the outer edge of the insertion-cell, cell V triangular, about as large as cells III and IV combined. Insertion-cell very broad, thin, oblique not at first deeply blackened, but becoming indistinguishable in the general blackish brown suffusion of the adjacent cells. Outer appendage consisting of a nearly erect series of obliquely superposed small cells (sometimes as many as thirteen) at first hyaline, the basal cell and sometimes several of the cells above it becoming more or less suffused, each producing externally a single simple branch, curved upward, its basal portion consisting of two cells, sometimes three, longer than broad and more or less deeply suffused with brown, constricted at the dark septa; its distal portion elongate, reaching nearly to the tip of the perithecium, strongly tapering, hyaline, except at its base where it is involved by



the brown suffusion of the basal part: the inner appendage consisting of a basal cell giving rise on either side to an inner and an outer nearly horizontal series of cells similar to that of the outer appendage, but fewer in number, similarly branched except that the two or three lowest cells of each series bear single large stout straight brown antheridia on undifferentiated concolorous stalk-cells, the basal cells of the series, as in the outer appendage, becoming suffused with blackish brown. Perithecia  $190-220 \times 40-50 \mu$ . Total length to tip of perithecium  $300-375 \mu$ ; to insertion-cell  $75-80 \mu$ ; greatest width  $55 \mu$ . Appendages, longest  $220 \mu$ . Spores (in perithecia) about  $50-55 \times 6 \mu$ .

On elytra of *Colpodes Chiriquinus* Bates, Brit. Mus. No. 735 (Biologia Coll.), Volcan de Chiriqui, Panama.

This well marked species is represented by four individuals, only, in the material available. The inner appendage appears to be proliferous above its base, and thus to become double, bearing two sets of antheridia and sterile branches, an inner and an outer; the latter arising from basal cells that are nearly horizontally placed. The basal region of the inner appendage is therefore very broad and cell V of the receptacle is correspondingly large, larger than cells II, III, or IV. The tendency of the inner appendage to proliferate recalls the conditions seen in *L. Trichognathi*, though the two species are quite unrelated in the section. The insertion-cell may be without any of the usually opaque suffusion, but varies in this respect.

LABOULBENIA CURVATA Thaxter. Plate LXII, fig. 12.

Proc. Am. Acad. Arts and Sci., Vol. XXXVIII, p. 33. June, 1902.

Perithecium large and long, strongly curved inward throughout, rich deep red-brown, the inner half usually opaque, the outer more or less translucent or becoming opaque; the basal wall-cell forming a well-defined, short, hyaline stalk; the tip short and broad, suffused about the terminal nearly median pore. Receptacle short and stout, translucent, more or less deeply and unevenly suffused with dirty brown; the basal cell paler, or nearly hyaline below, often as long as the rest of the receptacle above it, obscurely punctate; the subbasal cell short, a very small part, only, of its anterior margin free; cells III and IV subequal, or cell IV larger, separated by a very oblique septum, a small portion only of the outer margin of cell IV free externally. Insertion-cell slightly oblique, brown or black, the suffusion involving the basal and even the subbasal cells of the appendages. Appendages consisting of from six to eight obliquely superposed cells, the branchlets usually much shorter than the perithecium, the two lowest cells of the inner appendage bearing antheridial branchlets consisting of a relatively large subhyaline stalk-cell bearing terminally a pair of deep brown divergent relatively small antheridia, the long slender necks curved rather abruptly distally. Spores  $70-75 \times 4 \mu$ . Perithecia  $325-400 \times 50-70 \mu$ , including the stalk ( $40-55 \mu$ ). Receptacle  $185-220 \times 75-90 \mu$ . Total length to tip of perithecium  $500-600 \mu$ .

At base of anterior legs of *Galerita carbonaria* Mannerh., Brazil; Berlin Museum, No. 960: and of *Galerita* sp., Hope Coll., No. 259.

This species is distinguished by its almost falcate habit, the outer and inner halves of the large curved perithecium translucent and opaque, respectively, and distinguished by a more or less clean line of demarcation; although, in older individuals, the outer half may also become rather deeply suffused. The appendages in general resemble those of *L. perplexa* very closely, but are at once distinguished by the antheridial branchlets, and the antheridia; the latter being small, with very slender necks, and borne in terminal pairs. The Berlin material is taken as the type of the species, but the material from the Hope Collection, the locality of which was not indicated on the host label, agrees in every respect.

LABOULBENIA PYGMÆA Thaxter. Plate LXII, fig. 6.

Proc. Am. Acad. Arts and Sci., Vol. XXXV, p. 198. Dec., 1899.

Perithecium dark brown becoming almost opaque, coarsely granular-punctate throughout, somewhat more densely below, the basal wall-cells forming a well defined hyaline contrasting short neck slightly narrower than the body of the perithecium, the tip usually not very abruptly distinguished and bent very



slightly outward, or straight, rather blunt; the lip-edges translucent, the lip-cells rather prominent, blackened below, especially on the inner side. Receptacle short coarsely punctate, triangular, cell I short, slender, curved, hyaline at the base, distally becoming suffused and finally indistinguishable from cell II, which is finally wholly opaque. Cells III and IV elongated and lying obliquely side by side, cell III forming a more or less prominent rounded projection below the apex of cell IV which also forms a slight external prominence just below the insertion-cell, both cells coarsely punctate, becoming opaque; cell V rather large, at first hyaline, becoming later suffused with brown; cell VI and the other cells below the perithecial neck coarsely punctate translucent. Insertion-cell black, very broad, often becoming indistinguishable from the basal cells of the appendage. Outer appendage consisting of a subtriangular basal cell distally rounded, becoming deeply suffused with blackish brown, prominent externally and coarsely punctate; surmounted by a series of obliquely superposed cells close set, their long (transverse) axes sometimes almost perpendicular, each bearing externally a single simple branch, the two lower cells of which are longer than broad, tinged with brown, the septa dark and often oblique; the distal portion hyaline, twice as long, blunt-tipped: the inner appendage consisting of a smaller basal cell also becoming punctate and almost entirely suffused, surmounted on either side by a series of cells like that of the outer appendage and similarly branched, except that the two or three lowest cells of the series bear a short one-celled branch terminated by usually three slightly curved brown antheridia. Spores  $52 \times 4 \mu$ . Perithecia  $110 \times 22-150 \times 33 \mu$ , exclusive of neck which is  $20-30 \mu$ . Total length to tip of perithecium  $175-300 \mu$ ; to insertion-cell about  $90-110 \mu$ ; greatest width  $40-55 \mu$ . Appendages  $90-130 \mu$ .

On *Trichognathus* sp., Paris Museum, No. 72, Venezuela. On *Galerita* sp., U. S. Nat. Museum No. 23, Bobo, Mexico. On *Galerita* sp. Berlin Museum No. 961, Mexico.

This species, which occurs on the legs, elytra, and other parts of the host, is distinguished by its short stout habit and densely black punctate perithecium, which is similar to that of *L. Galeritæ* in this respect. The specimens from Bobo are slightly more slender than the type material from Venezuela (Paris No. 72), the receptacle, above the basal cell, less triangular and less deeply suffused, but otherwise exactly similar. It is most nearly related to *L. media*, but is well distinguished by its smaller size, and especially by the different structure of the receptacle and basal portion of the appendages in the latter, and their relation to the insertion-cell.

LABOULBENIA MEDIA Thaxter. Plate LXII, figs. 3-4.

Proc. Am. Acad. Arts and Sci., Vol. XXXVIII, p. 45. June, 1902.

Perithecium usually narrow, straight, erect, sometimes slightly inflated, the basal wall-cells forming a relatively long, well-distinguished, hyaline or subhyaline stalk; the basal cells vertically elongated; the ascigerous portion marked by distinct transverse blackish coarse granular striations throughout, and becoming opaque or nearly so; the tip erect, the apex slightly asymmetrical, subtended by a darker shade on the inner side. Receptacle medium to short, the basal cell hyaline, becoming dirty brownish yellow; cells III and IV deep brownish, the suffusion more or less confined to these cells or involving also cell II and other adjacent cells, the more deeply suffused parts coarsely punctate; cell III extending upward beside cell IV and distally forming a well-defined external prominence, sometimes as distinct as that formed by the basal cell of the outer appendage; cells V and VI wholly or partly hyaline becoming dirty brownish yellow, the latter coarsely punctate. Insertion-cell small, almost wholly external to cell V, hardly distinguishable, translucent and only finally involved in the opacity of the adjacent cells. The basal cell of the outer appendage large, subtriangular, forming distally and externally a rounded prominence, from the upper nearly horizontal surface of which arises the first of the oblique series of branches; the remaining cells of the appendage hyaline, very obliquely superposed successively smaller, from about six to ten in number, forming a series extending obliquely back to the perithecium, each bearing externally a single branch; the branches relatively short, the basal cell more elongated than the subbasal, both purplish brown, slightly constricted at the dark septa; the rest of the branch shorter or not much longer than



the basal part and consisting of from one to three cells, hyaline or brown below, blunt-tipped; the basal cell of the inner appendage giving rise to the characteristic series of superposed ramiferous cells on either side like that of the outer appendage but nearly horizontal and extending inward well beyond the inner end of the insertion-cell, the four to six lower cells of each series producing, two, less often three, unicellular branchlets terminated by brown long-necked antheridia; the sterile branchlets of the upper and distal cells similar to those of the outer appendage. Spores  $45 \times 4.5 \mu$ . Perithecia  $180-290 \times 40-48 \mu$ , the stalk  $55-125 \times 25-35 \mu$ . Receptacle  $165-220 \mu$ . Appendages, greatest total length,  $165-185 \mu$ . Total length to tip of perithecium  $350-725 \mu$ .

On *Galerita* sp. (tips of elytra), Venezuela; Paris Museum, No. 75. On tip of abdomen, inferior, of *Galerita Lecontei* Dej.: British Museum, No. 521, Costa Rica; No. 525 on *Trichognathus marginipennis* Latr. Tamas, ? Columbia, No. 526 on *T. marginatus* Latr., Brazil.

This fine species is distinguished from *L. pygmaea* especially, with which it was formerly in part confused, by the insertion of its appendages, the insertion-cell being unmodified and small, and finally continuous with the series of cells which form the primary inner appendages, the bases of which are in contact with cell V of the receptacle, except the uppermost (innermost).

#### LABOULBENIA PHEROPSOPHI Thaxter. Plate LXIV, figs. 8-9.

Since the original publication of this species, it has been possible to examine a considerable amount of additional material occurring on species of *Pheropsophus* from both hemispheres. The material from these sources is, in general, rather clearly distinguished, however; that from the western hemisphere adhering closely to the type as originally described, in which the outer appendage is at most not more than five or six times proliferous, that is the main axis consists of not more than five or six cells and is of compact habit: the inner appendage producing, as a rule, only a single branch with two or three proliferations, the axis thus only two- to three-celled; a small short stout solitary antheridium being borne on a short stalk-cell at its base. Material from the Eastern Hemisphere, though often closely resembling the type, especially in the African specimens, tends to vary to the condition shown in figure 8, the outer appendage, as well as the two branches of the inner, being much more luxuriantly developed and the antheridia (fig. 9) produced usually in groups of two or three, their form more slender and elongate, the necks curved. This is especially true of specimens from Madagascar, Ceylon, the Philippines, and localities to the east of Africa. The differences, however, are not sufficiently absolute to warrant even a varietal designation.

The additional material obtained is as follows: British Museum No. 534 on *P. fuscicollis* Dej., Java; No. 717 on *P. æquinoctialis* Linn., Yucatan; No. 718 on *P. biplagiatus* Chaud., Junquilla, Mexico; Paris Museum; No. 8 on *Pheropsophus* sp., Madagascar, and No. 14, Ceylon; No. 55 on *P. fuscicollis* Dej., Asia; No. 56 on *P. Latoni* Dej., Asia; No. 76 on *Pheropsophus* sp., Venezuela; No. 77 on *Pheropsophus* sp., Java; Berlin Museum; No. 995 on *P. obliquatus*, Kimpoko, Congo; No. 998 on *P. Kersteni* Gerst., Aruscha Kisnani, Africa; No. 1001 on *P. humeralis* Chaud., Madagascar; No. 1003 on *Pheropsophus* sp., Luzon, Philippines; No. 1005 on *P. bipartitus*, Madagascar. Hope Collection; No. 238 on *Pheropsophus* sp., Ceylon.

#### LABOULBENIA PACHYTELIS Thaxter.

This type proves to be a very variable one, in which species-making is going on in a fashion somewhat similar to that which is seen in the forms occurring on the closely related *Brachinus* and *Galerita*. I have separated as species three forms which are closely related in this group, *L. punctulata* from widely separated localities, *L. tortuosa* on our small western *Pachyteles*, and *L. Ozæna* which has developed a very characteristic method of bearing its antheridia. It is probable that a fourth species is represented in material from the Amazon, as well as a fifth on *Pachyteles longicornis* from Mexico; but I have been unable to include figures of these forms which I hope to illustrate in a future paper. The variations among the more typical forms are in general associated with extreme differences in size, (the total length



to tip of perithecium varying from 150 to 900  $\mu$  or more); in color; in the development of the outer appendage, which may be short and compact or elongate, consisting of only one or two cells or many celled; and in the relation of the perithecium to the receptacle, to which it is variably united.

Additional material has been examined as follows: British Museum No. 572 on *Ozæna parallela* W., Rio Janeiro; No. 574 on *Pachyteles* sp., Ega, Amazon; No. 573 on *Ozæna Reichii* Guer., Columbia; No. 672 on *Pachyteles Mexicanus* Chaud., Toxpain, Mexico; No. 671 on *P. seriatoporus* Chaud., Bugaba, Mexico. Hope Collection No. 281, on *Goniotropis rufipes* Hope, New Grenada; No. 280 on *P. Brazilianensis* Gray, Brazil; No. 285 on *Pachyteles* sp., Brazil. In the Berlin Museum No. 945 on *Ozæna Reichii* Guer., New Grenada; No. 946 on *O. pedestris* N., Bogota Columbia; No. 948 on *O. glabra* Klg., Brazil. In U. S. National Museum No. 24 on *P. Mexicanus* Chaud., Mexico (very typical specimens).

LABOULBENIA PUNCTULATA Thaxter. Plate LXIII, fig. 12.

Proc. Am. Acad. Arts and Sci., Vol. XXXV, p. 197. Dec., 1899.

Perithecium about three fourths free, dark brown, translucent, curved toward the appendages which cross it obliquely, the broad short flat-topped snout-like tip slightly upcurved. Receptacle short and stout, the basal cell small, short, hyaline, contrasting, the rest concolorous with the perithecium, but darker and distinctly punctate with dark brown spots. Outer appendage consisting of a series of from three to about six successively smaller superposed cells, from each of which a simple tapering brown branch arises, blackened about its subbasal septum, the successive branches superposed in a vertical external row, the basal cell of the inner appendage producing usually a short one-celled antheridial branch bearing a single small antheridium. Perithecia  $120 \times 45 \mu$ . Total length to tip of perithecium 200–220  $\mu$ ; to insertion-cell 125  $\mu$ . Appendages 100–120  $\mu$ .

On *Pachyteles parallelus* Chaud., Brit. Mus. No. 575, Para: on *P. porrectus* Chaud., Brit. Mus. No. 670 (Biologia Coll.), Pantaleon, Guatemala.

Although obtained from widely separated localities, this form, which occurs on the legs of its host, is in both instances very constant in its characters, and quite unlike small short forms of *L. Pachytelis* which are often found growing in a similar situation. Although its appendages are practically the same, its peculiar short hunched form, the shape of its perithecium, and the coarse punctation of its receptacle above the hyaline basal cell serve to distinguish it at once.

LABOULBENIA DARWINII Thaxter. Plate LV, fig. 2.

Proc. Am. Acad. Arts and Sci., Vol. XXXV, p. 170. Dec., 1899.

Perithecium hyaline becoming pale straw- or amber-yellow, sometimes with a shade of brown, relatively small, its upper third or less free from the receptacle, the tip black, abruptly distinguished, the broad lip-edges translucent purplish brown. Receptacle relatively stout, indistinctly punctate with short lines or dots of darker yellowish color, cells II, III, and IV often unusually broad. Insertion-cell well developed, deep purplish brown or black. Outer appendage consisting of a short angular brownish basal cell, which bears an outer and an inner branch distally, the outer simple or once branched above its basal cell, the inner mostly simple; the outer branchlet mostly shorter, divergent, often deeply suffused with reddish brown, the rest less deeply colored, rigid, erect. The inner appendage consisting of a smaller basal cell which may produce a single branch, or two placed laterally or antero-posteriorly, short, simple with lateral antheridia or once branched. Perithecia  $100 \times 30\text{--}35 \mu$ . Total length to tip of perithecium 150–275  $\mu$ ; to insertion-cell 135–250  $\mu$ . Appendages, longest 200–250  $\mu$ .

On *Ozæna parallela* W., Brit. Mus. No. 572, Rio de Janeiro (legit C. Darwin); on *O. lavis* Klg., same locality, Berlin Museum No. 947; on *Pachyteles* spp.; Paris Mus. No. 137, South America, Hope Collection, Nos. 284 and 285, Brazil. Occurring usually at the base of the posterior legs or margins of clytra.

This species, which appears in general to be a well defined form, is perhaps the representative of the *flagellata*-like type from which the other forms on *Pachyteles* and its allies have been derived. The only



distinct variation from the type represented in fig. 2 is seen in two or three specimens obtained from *O. lævis*, collected at Rio Janeiro, in which cell V is abnormally protruded within the insertion-cell and even divided, as in *L. proliferans*. Its color is very pale, and the appendages are too much broken for comparison, but it hardly seems distinct. The type is most readily distinguished by its stout receptacle, cells III and IV being especially large, and its relatively very small perithecium, which is almost wholly adnate to the receptacle, except the tip. The type is derived from a host collected by Charles Darwin on his famous "Voyage of the Beagle."

**Laboulbenia Ozænzæ** nov. sp. Plate LXIII, Fig. 11.

Rather evenly suffused with dirty yellowish, faintly shaded with brown. Perithecium more than half free, relatively small; the tip relatively large; the lips prominent, transparent, subtended by blackish brown suffusions. Receptacle normal, cells I and II subequal, cells III-IV not much smaller and subequal, the external walls suffused with brown; cell V triangular, its upper margin oblique. Outer appendage consisting of usually three cells obliquely superposed, the upper bearing two, the rest bearing externally single tapering simple branches about equal to the perithecium in length, distally hyaline; below, externally and at the base, suffused with rather deep blackish brown: inner appendage consisting of a basal cell which gives rise to an antheridial branch, occasionally on both sides, which sometimes arises at the base of a short sterile branch; the antheridial branch consisting of a single stalk-cell, constricted at its deeply blackened base, above which it is abruptly inflated, assuming a spherical form and bearing three or four large antheridia side by side in a fan-like fashion, their slender tips reaching to the apex of the perithecium. Insertion-cell translucent reddish brown, rather broad and oblique. Total length to tip of perithecium 220  $\mu$ ; greatest width about 60  $\mu$ . Perithecium 90-100  $\times$  30-32  $\mu$ . Receptacle to apex of cell V, about 150  $\mu$ . Antheridia 36  $\mu$ . Spores about 55  $\times$  5  $\mu$ .

On *Ozæna angulicollis* Schm., Berlin Museum, No. 944, Venezuela. This species occurred at the tips of the elytra of its host and is very clearly distinguished, by its peculiar antheridial branches and large antheridia, from the other forms (*L. Pachytelis*, *L. punctulata* and *L. tortuosa*) occurring on *Pachytetes* and its allies. The types show very little variation in form, size or color. In a few individuals the inner appendage gives rise to two sterile branches, one on either side, from the bases of which the antheridial branchlets arise.

**LABOULBENIA TORTUOSA** Thaxter. Plate LXIII, fig. 10.

Proc. Am. Acad. Arts and Sci., Vol. XXXV, p. 206. Dec., 1899.

Perithecium with hardly more than the tip free, relatively small, externally suffused with smoky brown and concave through the presence of a well defined subterminal hunch, above which the somewhat pointed well defined outwardly oblique blackish-brown tip is abruptly differentiated, the lip-edges pale brown translucent. Receptacle very pale reddish or yellowish, variously bent, sometimes at right angles or at an angle of forty-five degrees above cell II; cells I and II straight or more frequently cell II curved strongly, while there is often a less pronounced curvature in the opposite direction immediately above it. Insertion-cell horizontal, about opposite the external hunch of the perithecium. Outer appendage consisting of a very large basal and somewhat broader subbasal cell, the two commonly as broad as or broader than any portion of the receptacle with which they are concolorous; the upper outer angle of both cells marked by the black insertion of a short simple branch, usually broken off, the subbasal cell surmounted by a small flattish cell which bears a simple terminal branch with blackened base like those developed laterally below it: the inner appendage consists of a very small basal cell which usually produces a pair of relatively large antheridia with inflated venters and brown necks distinguished by a deeply blackened basal septum. Perithecia 85  $\times$  27  $\mu$ . Total length to tip of perithecium about 275  $\mu$ . Appendage, to upper blackened septum 50  $\mu$ , by 28  $\mu$  wide. Spores about 55  $\times$  5  $\mu$  (in perithecium).

On *Pachytetes testaceus* Horn, U. S. National Museum, No. 28, Arizona. Along the adjacent inferior margins of the thorax and prothorax, on left side.



This species, though closely allied to *L. Pachytelis*, of which it might at first sight appear to be an abnormal development, was found on several specimens of this small Arizona *Pachyteles*, always in the same general position and in no case varying from the type form illustrated in Fig. 10. The antheridial branch occupies a median position, the two antheridia diverging slightly on either side, and apparently arising from a very small stalk-cell. Its abnormally bent habit, its pointed and hunched perithecium, and its inflated primary outer appendage, consisting of two similar cells, basal and subbasal, distinguish it clearly from *L. punctulata*, *L. Ozænæ* and *L. Pachytelis* which are its nearest allies.

#### LABOULBENIA TEXANA Thaxter.

The type form of this striking species has not again been observed since the original material was obtained on species of *Brachinus* from Texas and Guatemala; but a number of forms on *Brachinus* which approach it perhaps too closely for specific separation, have been distinguished as varieties. The type forms of these varieties, though occurring in widely separated localities, are absolutely identical, and show scarcely any variation and the same is true of the form previously described as *L. rostellata*, individuals from Florida and from Montevideo being identical. The series of varieties as a whole, however, shows certain gradations between extreme forms, and the character of the appendages, although subject to peculiar variations in luxuriance of development is, on the whole, so constant that I have concluded to retain varietal designations in all cases. This disposition of the forms must be, nevertheless, considered as provisional; and further study of material from the La Plata region, as yet unexamined, may indicate that a revision of this opinion is desirable. The present species is so closely allied to *L. Pachytelis*, which also occurs on an allied host, that it would be difficult to distinguish a variety like *retusa* from some of its many variations. The varieties illustrated in the accompanying figures which have been greatly reduced ( $\times 150$ ) as compared with the other figures of the plate, may be distinguished as follows:

#### Var. ROSTELLATA Thaxter. Plate LXIII, fig. 5.

Proc. Am. Acad. Arts and Sci., Vol. XXXVIII, p. 55. June, 1902. L. c., Vol. XXXV, p. 199. Dec., 1899, as *L. rostellata* n. s.

Perithecium about one half free, becoming more or less deeply suffused with blackish brown, relatively small, narrow and curved toward the appendages, distally monstrously developed, bulging terminally and externally to form a rounded prominence from the inner side of which the tip projects inward in the form of a blunt pointed, blackened outgrowth, the hyaline contrasting apex of which is bent slightly upward. Receptacle more or less suffused, sometimes deeply colored with blackish brown, cells I and II paler, slender, of nearly equal width, cell II longer; cells IV and V very broad, carrying out the insertion-cell free from the receptacle so that it becomes oblique or even vertical and lateral. Outer and inner appendages similar, bent away from the perithecium, their bases overlapping; consisting of a series of superposed cells which are successively smaller from below up, each bearing distally and externally a short tapering branch; all the branches brown, the subbasal septa blackened, all simple except the lower branch of the outer appendage which bears two or three short branchlets; the basal cell of the inner appendage bears a short antheridial branch from its inner side; the outer appendage somewhat longer than the inner, the superposed cells usually eight in number. Perithecia  $140-190 \times 40-50 \mu$ . Total length to tip of perithecium  $400-550 \mu$ ; to insertion-cell  $270-450 \mu$ . Appendages,  $140-170 \mu$ . Tip of perithecium, including outgrowth,  $50-60 \mu$ .

On *Brachinus lateralis* Dej., Hope Coll. No. 246, "North America"; on *Brachinus* sp., Eustis, Florida, October; on *B. geniculatus* Dej., Berlin Museum No. 992, Montevideo, Uruguay. At base of anterior legs.

Specimens from the localities mentioned are remarkably constant in character, the subbasal and basal cells of the receptacle, however, usually forming a stalk which is more abruptly differentiated from the distal portion than is indicated by the individual represented in fig. 5.



Var. *PENDULA* Thaxter. Plate LXIII, fig. 3.

Proc. Am. Acad. Arts and Sci., Vol. XXXVIII, p. 55. June, 1902.

Longer and more slender than the type; cell V not greatly broadened, so that the perithecium and appendage diverge but slightly. The outer appendage nearly erect, brown, relatively very long, tapering; one or sometimes more than one of the three lower cells producing externally or laterally well-developed branches of the characteristic type, which are long, slender and more or less pendulous. The inner appendage recurved, more or less pendulous, relatively slender and similar to a well-developed branch which arises on its inner side from the third cell above its base. Perithecium nearly erect, the tip well distinguished, bent slightly inward; the lips somewhat spreading. On *Brachinus geniculatus* Dej., Montevideo, Uruguay; Berlin Museum, No. 992. On the inferior surface of the prothorax.

A very large and striking form, to which the pendent branches of its appendages give a graceful habit. Unlike the *var. incurvata*, which occurs with it, the two basal cells do not form a stalk clearly distinguished from the distal portion of the receptacle, and although cells IV and V are greatly enlarged, they are so arranged as to bear the appendages in the usual vertical position.

Var. *Oaxacana* nov. var. Plate LXIII, fig. 7.

Perithecium suffused with rather dark brown, tapering and curved slightly inward from about the middle to the tip, which is abruptly distinguished, subcapitate, the lips translucent only about the pore. Receptacle somewhat bent, the subbasal cell broader and several times longer than the basal cell; both evenly suffused with pale dirty brownish and contrasting in color with the darker brown distal portion, which is concolorous with the perithecium, except cell V, which is somewhat paler, indistinctly marked by transverse striæ, and prolonged upward and outward beside cell IV, carrying the insertion-cell out free from the perithecium almost horizontally. Outer appendage long tapering and slender, the lower half suffused with dirty brown, the distal hyaline; the successive cells bearing distally and externally small branches without blackened basal septa. Total length to tip of perithecium 550  $\mu$ . Perithecium 200  $\times$  85  $\mu$ . Appendage 400  $\mu$ . Receptacle to insertion cell 470  $\mu$ . Spores 60  $\times$  5  $\mu$ . Inner appendage consisting of a basal cell which gives rise laterally to a single small antheridium on a very short stalk-cell, and a hyaline terminal branch of five or six cells each bearing an upcurved branch; the branches producing upcurved branchlets, the lowest of which is distinguished by a blackened septum.

On the inferior surface of the prothorax of *Brachinus lateralis* Dej., Oaxaca, Mexico, British Museum No. 721.

The single type of this variety which has been examined, approaches *var. pendula* in the form of its perithecium, but differs both in the form of its appendages and in their relation to the receptacle, through the modification of cells IV and V.

Var. *INCURVATA* Thaxter. Plate LXIII, fig. 4.

Proc. Am. Acad. Arts and Sci., Vol. XXXVIII, p. 55. June, 1902.

Corresponding closely to the type in the form and coloration of the receptacle. The outer appendage nearly straight, divergent, hardly incurved, becoming more or less brownish, relatively somewhat longer and more tapering than in the type, the subbasal cell producing from its left side a short well-developed five- to six-celled branch, recurved, and bearing branchlets of the characteristic type from its convex side; the second cell producing on its concave side a two-celled branchlet, the lower cell of which bears one and the distal two of the characteristic branchlets. The inner appendage closely resembling that of the type, hyaline, incurved, its third cell producing a well-developed similar branchlet from its concave side. Perithecium as in the type, but the tip quite different, narrow, bent abruptly inward at right angles, the lips compressed. On *Brachinus geniculatus* Dej., Montevideo, Uruguay; Berlin Museum, No. 992.

While the appendages of this variety are not unlike those of the *var. pendula*, it differs in the form of the perithecium, with its abruptly inbent tip, and in the differentiation of the receptacle into a stalk-part, consisting of cells I and II, which is very abruptly distinguished from the subtriangular distal part: cells IV and V lying almost horizontally, instead of vertically.



Var. *retusa* nov. var. Plate LXIII, fig. 6.

Perithecium short stout somewhat inflated, becoming deeply suffused with smoky brown; the tip opaque, except for the translucent lip-edges and erect, or usually bent slightly outward. Receptacle becoming rather evenly suffused with dirty brown, paler or hyaline at the base, and sometimes with an olivaceous tinge; the basal and distal portions rather variably distinguished, cells IV and V considerably enlarged and elongated, carrying the insertion-cell out free from the perithecium. Appendages rather closely septate, the successive cells bearing the usual series of branches externally, which are simple and distinguished by a black septum at the base, the inner appendage shorter and more slender than the outer, but otherwise similar. Spores about  $70 \times 5.5 \mu$ . Perithecium  $150 \times 60 \mu$ . Total length to tip of perithecium 200–300  $\mu$ . Receptacle to insertion-cell 275–360  $\mu$ . Appendages total length 180–280  $\mu$ .

At the base of the anterior legs and on the adjacent inferior surface of the prothorax of *Brachinus* sp., Eustis, Fla., and from Argentina.

This variety approaches forms of *L. Pachytelis* so closely that it might almost be regarded as a variety of that species, and certainly would be, did it occur on the same host. The material from Eustis, which is taken as the Type, differs to some extent from the Argentine specimens, which have an olivaceous caste, are shorter, with a receptacle which is basally more slender and distally more conspicuously enlarged; the tip of the perithecium being not as stout and less rounded and the appendages longer and more slender than in the type, which is represented in fig. 6.

Var. *TIBIALIS* Thaxter. Plate LXIII, figs. 8–9.

Proc. Am. Acad. Arts and Sci., Vol. XXXV, p. 205. Dec., 1899.

Perithecium deeply suffused with blackish brown, somewhat inflated, the small tip rather abruptly distinguished. Receptacle stout, deeply suffused with blackish brown except cells I and II, which are hyaline or nearly so, abruptly contrasting, and cell V which together with the adjacent portions of cell IV is yellowish; cells IV and V broad, the insertion-cell broad and in contact with the base of the perithecium. Appendages as in *L. rostellata* except that the inner is larger and longer than the outer without overlapping it at the base and the lower branch of the outer is simple. Perithecia  $150-175 \times 60-70 \mu$ . Total length to tip of perithecium 300–325  $\mu$ ; to insertion-cell 200–225  $\mu$ . Appendages exclusive of the branches, inner 100–120  $\mu$ , outer 85  $\mu$ .

On *Brachinus* sp., Eustis, Florida, October. On the legs.

This pediculous variety is distinguished by its contrasting coloration, the short stout form of its perithecium and receptacle, cell IV of the latter being relatively very large, and cell II very small, about a third as large as the basal cell; the two contrasting abruptly with the deep black suffusion of cell III. The appendages are further unlike those of other varieties in that the outer is much smaller than the inner. A second variation is represented in fig. 8, which also occurs on the legs and is distinguished by its more compact form and the presence of a double hunch, which is developed externally below the tip of the perithecium. Whether these differences are constant is uncertain since only two individuals have been examined.

LABOULBENIA *CAFII* Thaxter. Plate LXIII, fig. 1–2.

Proc. Am. Acad. Arts and Sci., Vol. XXXV, p. 162. Dec., 1899.

Perithecium almost wholly free, pale amber-colored or straw-yellow, transparent, stout, the tip blunt, with blackish basal suffusions, well distinguished, especially on the inner side. Receptacle short and stout, pale amber-colored, normal in form. Insertion-cell broad, often not deeply blackened. The appendages consisting of an outer and an inner series of from four to six superposed cells which, through a twist of the insertion-cell, become lateral instead of antero-posterior in position; each cell of these series produces externally a single simple short branch usually three-celled, the two lower cells short and inflated, the upper longer tapering to a blunt apex. Perithecia  $140-165 \times 60-70 \mu$ . Total length to tip of perithecium 310–350  $\mu$ , to insertion-cell about 170  $\mu$ . Appendages, longest 85  $\mu$ .



On *Cafius seminitens* Horn, and *C. canescens* Mäk, U. S. National Museum, Los Angeles, California. On *C. sericeus* Holme, Brit. Mus. No. 437, Great Britain. On *Cafius* sp., Brit. Mus. No. 425, "Europe," No. 395, Hong Kong; *C. bisulcatus* Sol., Chile, Paris Museum No. 174. On *Cafius* sp. Kittery Point, Maine; on *C. catenatus*, New South Wales, Sharp Collection, No. 1136. On elytra and legs.

Although entomologists appear to be somewhat doubtful whether the staphylinid genus *Cafius* should be separated from *Philonthus*, this cosmopolitan species of *Laboulbenia* does not seem to share any such uncertainty, as I have never seen it on any of the thousands of *Philonthi* that I have examined, while members of the genus *Cafius*, as above indicated, are subject to its parasitism all over the world. The species is well marked, being clearly distinguished by its appendages, the outer and inner eventually so displaced that they lie nearly side by side, and consisting each of a single series of somewhat obliquely superposed cells which give rise externally to simple single branches, somewhat as in appendages of the *Galerita*-type. The species is remarkably constant considering its very wide distribution, and is not nearly allied to any other described form.

LABOULBENIA PALLESCENS Thaxter. Plate LXI, figs. 9-10.

Proc. Am. Acad. Arts and Sci., Vol. XLI, p. 318. July, 1905. *Laboulbenia pallida* Thaxter, l. c., Vol. XXXVIII, p. 49, June, 1902: nec *L. pallida*, l. c., Vol. XXXV, p. 193. Dec. 1899.

Hyaline, becoming faintly suffused with yellowish brown. Perithecium one half or less free, concolorous or slightly darker, stout, erect; the tip small, usually well distinguished, bent outward; the lip-cells outwardly oblique, the inner much more prominent, rounded distally, wholly suffused, except the edges, with dark distinctly reddish brown. Receptacle normal, or often abnormally septate, more commonly as a result of one or two distal divisions of cell V. Insertion-cell broad, reddish brown, transparent but contrasting, irregular in form, often oblique in position, being carried out free from the base of the perithecium, from which it is separated by the partly free upper margin of cell V, sometimes once divided vertically; an external distinct similar accessory insertion-cell, bearing a single appendage and standing in direct relation to one of the subdivisions of cell V is rarely present. The appendages hyaline, in general normal, the outer basal cell twice or more than twice as large as the inner, bearing usually two branches which may be once branched, one of them sometimes an antheridial branch; the basal cell of the inner appendage producing usually a branch on either side, which may bear only short antheridial branchlets or longer simple sterile ones. Antheridia relatively large, stout, single or in pairs. Spores  $75 \times 6 \mu$ . Perithecia  $125-150 \times 60-70 \mu$ . Receptacle  $220-300 \mu$ . Longer appendages  $150 \mu$ . Total length to tip of perithecium  $290-380 \mu$ .

On elytron of *Clivina fasciata* Putz., St. Geronima, Guatemala; British Museum, No. 674. On *C. dilutipennis* Putz., Mexico; British Museum, No. 675.

This species is quite typical of the "*Clivinæ*" group, the abnormal divisions below the insertion cell being characteristic; although in some specimens the receptacle is absolutely normal. It is distinguished by its pale color and the peculiar red shade of its insertion-cell, which is but faintly suffused, the suffusion at the tip of the perithecium having the same peculiar pale red tinge. In fig. 10 an individual is represented in which an accessory insertion-cell is developed in connection with a cell distally separated from cell IV, which has the same reddish coloration.

LABOULBENIA CLIVINALIS Thaxter. Plate LXI, figs. 5-6.

Proc. Am. Acad. Arts and Sci., Vol. XXXV, p. 165. Dec., 1899.

Usually rather slender. Perithecium three fourths or more free, more or less deeply tinged with blackish olive-brown, distally curved slightly outward, the tip black with hyaline lip-edges. Receptacle wholly hyaline, or cells III and IV becoming more or less suffused with blackish brown, the suffused areas punctate: bulging distally below the perithecium. Insertion-cell well differentiated, black. Appendages consisting of an inner and an outer basal cell, which may remain simple or become longitudinally divided, sometimes also transversely or even obliquely: the outer basal cell hyaline, often several times



as long as broad, its distal septum blackened; when simple, bearing a single branch, if divided, several; the basal cell of the outer branch usually rather short and somewhat suffused, commonly bearing two branchlets. The basal cell of the inner appendage usually smaller than that of the outer, sometimes equal, and like it simple or divided; when simple, bearing a branch on either side, or more if it is divided. All the branches of both appendages hyaline or nearly so, mostly once branched above their basal cells. Spores about  $55 \times 4.5 \mu$ . Perithecia  $120-150 \times 35-50 \mu$ . Total length to tip of perithecium  $275-400 \mu$ ; to insertion cell  $200-340 \mu$ . Appendages, longest  $300-400 \mu$ .

On *Clivina collaris* Herbst, Hope Coll. No. 348, and Brit. Mus. No. 456, both from England. On *Clivina fossor* Linn., Hope Coll. Nos. 353, 275 and 475, England; No. 295, "Europe"; Florence Mus., Italy; Berlin Mus., No. 886, on *C. fossor* Linn. Usually on elytra and superior prothorax, but occurring elsewhere.

The typical unmodified form of this species is represented in fig. 5, a British specimen, which is taken as the Type (B. M. No. 456); but the material examined shows very considerable variation similar to that which characterizes the "*Clivina*" group generally, and here usually manifests itself in abnormal divisions of cell IV, and of the basal cells of the appendages. Apart from other differences, the species is distinguished from others in this section by the black septum and suffusion which occur at the base of the outer branch of the outer appendage. It does not usually occur abundantly on a given host, but on the other hand does not appear to be uncommon. A form identical with this, or very closely allied was obtained on *C. Australasiæ* Boh., from Luzon, Philippines in the Berlin Museum No. 885.

LABOULBENIA BARBATA Thaxter. Plate LXI, fig. 11.

Proc. Am. Acad. Arts and Sci., Vol. XXXV, p. 160. Dec., 1899.

Perithecium large, pale yellowish or brownish becoming slightly tinged with amber-brown, often symmetrically inflated and tapering gradually to the tip, which is brownish below, becoming black on the inner side, the lips subhyaline, turned slightly outward. Receptacle concolorous with the perithecium, normal except that cell V is greatly enlarged and extends upward covering nearly one half of the inner margin of the perithecium, bulging strongly outward and carrying out the insertion-cell, which is thus made lateral in position. Insertion-cell externally concave or indented. The outer appendage consisting of a small roundish basal cell giving rise to two, rarely more, branches antero-posteriorly, which are usually once branched near the base, the branchlets very elongate, slender, attenuated, curved outward and downward: the inner appendage consisting of a similar basal cell from which arise usually two branches, one on either side, similar to those of the outer appendage, the whole forming a hanging beard-like tuft. Perithecia  $190-200 \times 55-60 \mu$ . Total length to tip of perithecium, average  $400 \mu$ ; to insertion-cell, average  $190-200 \mu$ . Appendages, longest  $450-650 \mu$ . Spores  $100 \times 6 \mu$ .

On *Morio Georgiae* Pal., Brit. Mus. No. 690 (Biologia Collection), El Zambador, Mexico; on *M. simplex*, Dej., Brit. Mus. No. 581, Cayenne; on *M. monilicornis*, Latr., Hope Collection, No. 289, "North America." On the elytra.

This very distinct species, which was found in one instance in company with *L. Morionis*, cannot be confused with any other known form: its pendent appendages and the monstrous development of cell V, as well as the form of its perithecium, serving clearly to distinguish it. The receptacle is usually somewhat shorter than is shown in fig. 11; but the material, which is sufficient and in good condition, shows no variations of importance. Although no tendency to an irregular division of the distal cells of the receptacle, or of the basal cells of the appendages, has been observed, this species seems as nearly allied to *L. pallescens* and to the small "*Clivina*" group as to any others, and is therefore included here.

LABOULBENIA POLYHIRMÆ Thaxter. Plate LXV, fig. 1-3.

Proc. Am. Acad. Arts and Sci., Vol. XXXV, p. 195. Dec., 1899.

Perithecium rather slender, almost wholly free, nearly hyaline or faintly brownish yellow; tapering slightly toward the moderately well differentiated tip which is usually bent slightly outward, more or less



blackened on the inner side, where it may form a hunch-like projection, sometimes wholly black, the inner lips often prominently rounded and terminal, sometimes subtended externally by a more or less well developed hunch. Receptacle concolorous with the perithecium, marked by faint transverse striations, long and slender; cell II usually greatly elongated; the distal portion small and normal, protruding more or less distinctly below the perithecium. Outer appendage consisting of a small basal cell more or less rounded and producing distally from two to four branches, usually four; an outer and an inner, the two others placed between them one on either side, the branches simple or usually not more than once branched above the basal cell; the branchlets slender, often flexed, rather closely septate, hardly tapering: the inner appendage consisting of a smaller rounded basal cell which produces on either side a single branch, which may branch several times and bears hyaline lateral or terminal antheridia singly or in pairs; all the branches nearly hyaline. Perithecia  $130-190 \times 30-40 \mu$ . Total length to tip of perithecium  $400-700 \mu$ , average  $500 \mu$ , to insertion-cell  $275-450 \mu$ . Appendages, longest  $350-400 \mu$ . Greatest width  $40-50 \mu$ . Spores  $35-45 \times 4-4.5 \mu$ .

On *Polyhirma* sp., Paris Museum, Nos. 5, 6, and 168, Tangar, Algeria. Berlin Mus. No. 1051 on *P. hamifera* Harold, Zanzibar. Sharp Coll. No. 1167 on *Polyhirma* sp., Lorenzo Marques, Africa. On inferior surface of abdomen and thorax, especially in depressions at base of posterior legs.

This species is subject to considerable variations the extremes of which are illustrated in figs. 1-3, the latter being the normal type-form from which the original description was drawn. This normal form, although it is not distinguished by any very striking peculiarities, does not seem nearly related to any of the known species. The normal arrangement of the branches of its outer appendages is unusual, cell IV is relatively small, not longer than cell V in general; the rest of the receptacle slender, the perithecium relatively small, as are the spores. Between this normal type and the variety represented in fig. 2, a complete series of intermediate conditions occurs. The variety represented in fig. 1, in which the general form is stouter and more compact, with a relatively larger perithecium, having a tip quite differently shaped, was found in company with the type and is certainly not to be separated from it. Its spores are larger ( $45 \times 4.5 \mu$ ), however, than in the type, in which they hardly exceed  $35 \mu$  in length.

LABOULBENIA PAPUANA Thaxter. Plate LXI, fig. 1.

Proc. Am. Acad. Arts and Sci., Vol. XXXV, p. 193. Dec., 1899.

Perithecium nearly two thirds free, straight or curved slightly outward, the inner margin convex, pale brownish yellow, the tip rather well differentiated, blackish; the hyaline irregularly prominent lip-edges turned inward. Receptacle elongate, cell II, and cell I except at its base, conspicuously tinged with blackish and faintly transversely striate-punctate, the rest of the receptacle concolorous with the perithecium; cell IV externally concave, the whole receptacle more or less prominently bent anteriorly in the region of cells III and VI. Insertion-cell broad, horizontal, black, narrower than cells IV-V. The basal cells of the appendages simple and distinct, the outer producing a single branch which may branch once; the branchlets short; the basal cell of the inner appendage producing two small branches which may be once branched. Spores about  $65 \times 5.5 \mu$ . Perithecium  $160-200 \times 55-65 \mu$ . Total length to tip of perithecium  $650-880 \mu$ ; to insertion-cell  $544-700 \mu$ . Appendages, longest seen,  $140 \mu$ .

On *Morio* sp., Paris Museum, No. 112, New Guinea. On anterior inferior surface of thorax on right side.

It is conceivable that this species might prove an extreme form of *L. Morionis* which occurs on the same host; but its horizontal insertion-cell, the peculiar modification of the apex of its perithecium, and the form and coloration of its receptacle, seem to distinguish it sufficiently.

LABOULBENIA MORIONIS Thaxter.

Although this species appears to be subject to considerable variation in form, size, color, and in the development of its appendages, it is, with the exception of a possible variety on *Morio orientalis* from Java below referred to, readily separable from the other species of the "*Clivinæ*" group, by the relation



in position between its receptacle and perithecium, only the tip of which is free above cell V. The specimens from the East are usually more deeply colored, and less yellowish, cell V often less prominent than in the American specimens. The appendages, though usually short or broken, as represented in my Monograph, are sometimes well developed, exceeding the perithecium in length, with variably developed basal cells. One form from the legs of *M. Braziliensis* (Berlin Museum No. 899) varies in its comparatively short stout habit, black brown suffusions, and elongate appendages (over 200  $\mu$ ); but is associated with the normal type, and is merely a variation brought about by growth on the legs of its host. Two numbers (Paris 90 and Berlin 901) on *M. orientalis* from Java, vary distinctly from the type in that the insertion-cell is horizontally placed, and a third of the perithecium, more or less, is free above it. In these respects it is more nearly allied to *L. Papuana* in which more than half the perithecium is free, but the apex of the latter is quite different as is the general form and coloration of the receptacle.

Additional material has been examined from the following sources: British Museum: On *Morio Georgiæ* Pal., El Zambador, Mexico; No. 580 on *M. Braziliensis* Dej., Brazil; No. 579 on *Morio* sp., Nanta, Amazon; No. 691 on *Moriosomus sylvestris* Motsch., Mexico. Paris Museum No. 112 on *Morio* sp., New Guinea and No. 157 Java; No. 90, variety, on *M. orientalis* Dej., Java. Hope Collection; No. 291 on *M. monilicornis* Latr., Mexico; No. 293 on *Morio* sp., Brazil; No. 292 on *M. Braziliensis* Dej., Brazil. Berlin Museum; Nos. 899-900 on *M. Braziliensis* Dej., Rio de Janeiro; No. 898 on *M. simplex* Dej., Peru; No. 901, variety on *M. orientalis* Dej., Java.

LABOULBENIA DERCYLI Thaxter. Plate LXVI, figs. 2-3.

Proc. Am. Acad. Arts and Sci., Vol. XXXV, p. 171. Dec., 1899.

Perithecia free except at the base, short, stout, becoming tinged with brown, straight or the usually very broad tip turned slightly outward, the latter black, contrasting with the hyaline lip-edges. Receptacle elongate, faintly and uniformly tinged with smoky brown, normal, except that cell V is pushed up even beyond the hyaline unmodified insertion-cell which becomes thus external to it. Appendages typically consisting of an inner and an outer basal cell, the outer bearing a single oblique or nearly vertical more or less irregular row of branches arising antero-posteriorly; the inner bearing a similar row on either side, all the branches hyaline or yellowish brown, more or less copiously branched; the lower cells somewhat inflated, the septa blackened, often oblique, the basal cells of the branches bearing distally and externally from one to three obliquely superposed branchlets with blackened septa, which may branch again; the ultimate branchlets tapering slightly, the septa transverse and hyaline, usually appressed and coherent. A third group of branches similar to the rest sometimes arises between these and the perithecium, apparently from the distal portion of cell V. Perithecia 140-200  $\times$  55-60  $\mu$ . Total length to tip of perithecium 475-875  $\mu$ ; to insertion-cell 400-700  $\mu$ . Appendages, longest about 175  $\mu$ .

On *Dercylus tenebriosus* Laf. (= *Eurysoma tenebrioides*?), Hope Coll. No. 328, Para; Brit. Mus. No. 586, "S. America." On *Dercylus ater* Castel., Berlin Museum, No. 917. Para.

This form has been found on several specimens of *Dercylus* always along the margin of the right elytron. It is very doubtful whether it should properly be kept distinct from *L. variabilis*. The perithecium is more stout and blunt, the appendages are more closely septate and flexuous, and it does not show the same tendency to produce secondary appendiculate cells through proliferation of cells IV and V, that is so striking in the last mentioned species. Although it may well be nothing more than a variety, I have thought it best to retain the specific distinction until material can be examined in better condition than that available, in which even the youngest specimens do not show the character of the antheridia. That *L. Dercyli* is distinct from *L. gibbifera* on the same host where it grows in a different position, is also very doubtful.



## LABOULBENIA GIBBIFERA Thaxter. Plate LXVI, fig. 1.

Proc. Am. Acad. Arts and Sci., Vol. XXXV, p. 179. Dec., 1899.

Perithecium free or nearly so, somewhat narrower than in *L. Dercyli*, the apex narrower and more abruptly distinguished, the lips distinct, turned slightly inward; an external outgrowth just below the blackened tip, which it may exceed in length, forming a free protuberance straight or bent sidewise or inward, its apex evenly rounded or slightly inflated, its outer margin continuous with the nearly straight margin of the perithecium. Cells I and II of the receptacle faintly punctate, relatively long and stout, nearly isodiametric; cell II about twice as long, distally nearly as broad as the portion of the receptacle above it comprising cells III and VI, which are about equal in length; the latter extending obliquely somewhat lower but little higher than the former, and much narrower; the region of cells II-V more deeply suffused and distinctly punctate with blackish brown points, the undifferentiated insertion-cell pushed out by the enlargement of cells IV and V. Appendages consisting of a number of prominently projecting basal cells, originating in part from the proliferation of cell V, which bear branches terminally and unilaterally, distinguished by blackened septa; the branches once to twice branched, their basal portion slightly suffused and with blackened oblique septa; the distal portion quite hyaline. Perithecium  $150-167 \times 50 \mu$ . Total length to tip of perithecium  $400-450 \mu$ ; to insertion-cell  $275-340 \mu$ . Appendages  $150 \mu$ .

On *Dercylus tenebriosus* Laf. (*Eurysoma tenebrioides*?), Hope Coll. No. 328, Para; Brit. Mus. No. 586, "S. America." Inferior surface of thorax and prothorax near base of two anterior pairs of legs.

Although this form is distinguished from *L. Dercyli*, with which it was associated on the same host, by the peculiar outgrowth from its perithecium, by the arrangement of the distal cells of its receptacle, and by the multiplication of its appendages through the proliferation of cell V, it may prove only a variety. The curious perithecial outgrowth, however, is certainly not a structure which develops at late maturity; since it appears well developed in the youngest perithecia; and in the sufficiently abundant material available of both species, there are no transitional conditions. It should nevertheless be pointed out that a similar outgrowth occurs in some specimens of the very variable *L. Polyhirmæ* (Plate LXV, figs. 1-3) but in this case a variety of intermediate conditions occurs. As in the case of *L. Dercyli*, the specific designation is provisionally retained and both may eventually have to be reduced to synonyms of *L. variabilis*.

## LABOULBENIA VARIABILIS Thaxter.

This species appears to be absolutely confined to the western hemisphere, although it extends throughout the two continents. It is a very common and extremely variable form and occurs on a great variety of hosts. Through the courtesy of Dr. Horn of Berlin I have been able to examine specimens on two species on *Tetracha* from Ecuador, which differ in no essential respect from the typical forms, and are the first members of the family which have thus far been seen on any member of the Cicindelidæ. The variations of the species in general are associated with rather extreme variations in size and coloration and in the variable proliferation of the cells of the receptacle adjoining the insertion-cell which give rise to a variable number of appendiculate cells. The following is a partial list of the additional material of this species which has been examined since the publication of my Monograph.

British Museum, No. 628, on *Platysma caudicollis* Dej., Buenos Aires; No. 658 on *Pæcilus Mexicanus* Chd., Mexico; No. 584 on *Aspidoglossa* sp., Louisiana; Hope Collection No. 333 on *Pterostichus* sp., "New York"; No. 337 on an undetermined carabid from Valparaiso, Chile; Berlin Museum No. 868 on *Omophron Americanum* Dej., N. America; No. 914 on *Brachygnathus fulgidipennis* Guer., Brazil; No. 927 on *Chlænius Gundlachi* Chaud., Cuba. U. S. National Museum No. 21, on *Chlænius chlorochrous* Chaud., Central America; on *Tetracha Horni* Ruse, and *T. fulgida* Klg., Ecuador; received from Dr. W. Horn of Berlin.



## LABOULBENIA MELANOPUS Thaxter. Plate LXVI, figs. 4-5.

Proc. Am. Acad. Arts and Sci., Vol. XXXV, p. 187. Dec., 1899.

Perithecium free except at the base, large, rather deeply suffused with smoky brown, translucent, not contrasting; the subdistal wall-cells lighter, tapering abruptly to the narrow somewhat incurved tip, the inner lip-cells, only, deeply blackened. Receptacle somewhat curved, tapering below to the short slender basal cell which is smoky black except at its base, the distal cells gradually suffused with yellowish brown. Insertion-cell unmodified, blackened externally, the basal cells of the outer appendage becoming blackened externally very broad and short, bearing distally a series of erect branches at first more or less double, but later multiplied to form a dense tuft covering the expanded upper surface of the cell; the basal cell of the inner appendage producing similar but smaller groups of branches on either side, the basal cells of all the branches becoming more or less inflated distally, and bearing terminally and subterminally several (six to ten) branchlets, each of which may become again branched, the branches and branchlets distinguished by blackened septa; the ultimate branchlets very slender flexuous hyaline, not extending to the tip of the perithecium in the types. Spores about  $60 \times 4.5 \mu$ . Perithecium  $290 \times 70 \mu$ . Total length to tip of perithecium  $675 \mu$ ; to insertion-cell  $400 \mu$ . Appendages, longer  $140 \mu$ .

On a carabid (allied to *Harpalus?*), at the tip of abdomen. Paris Mus. No. 115, Africa.

This very distinct species is most nearly allied to *L. variabilis* and *L. orientalis*, from which it is, however, so distinct that its numerous differences do not need to be pointed out. The material is unfortunately not abundant, and the mature individuals have their appendages more or less broken in all cases; but the manner in which they originate is clearly seen in fig. 5, a young individual in which neither the basal cells of the inner appendage nor of the branches have begun to proliferate.

## LABOULBENIA GYRINIDARUM Thaxter.

The type of this species was figured (Plate XXII, fig. 31) in my Monograph, but a more careful reexamination of the material available shows that there are two species often associated on our American *Gyrini*. The type is distinguished by its smaller size, its straight, almost isodiametric, perithecium, which is furnished with short blunt projections as in the figure; and by the narrower insertion-region, and less abundant appendages: the wall-cells of the perithecium are straight, and the receptacle usually geniculate. The second form corresponds so closely to that which I have described as *L. chætophora*, of which a single example was found in the Sharp Collection on *Dineutes solitarius* from Madagascar (?) that I am unable to distinguish them specifically; and this species should therefore be added to the North American forms. It is the tip of the perithecium of this second form that is represented in fig. 37 of my Monograph, the projections from which are much longer and more sharply pointed, usually black and spine-like. The general form of the perithecium is conical, exactly as in *L. chætophora*, the wall-cells spirally twisted, the plant as a whole usually straight and subfusiform, the insertion-region much broader than in *L. Gyrinidarum*, and the appendages more numerous.

Several specimens in very poor condition have been obtained from British and Italian species of *Gyrinus* (British Museum No. 459 on *Gyrinus urinator* Illig., British Isles, and in the Florence Museum on *G. bicolor* Payk. and *G. striatus* Fabr., Italy, which have been referred provisionally to *L. Gyrinidarum*. It is uncertain, however, whether they properly belong to this species. Several poor specimens on *Gyrinus* from Mexico and from South America have also been examined, but here also the material is not sufficient to render a reliable determination possible, and their reference here is only provisional.

## LABOULBENIA CHÆTOPHORA Thaxter. Plate LXVII, fig. 19.

Proc. Am. Acad. Arts and Sci., Vol. XLI, p. 317. July, 1905.

Perithecium dirty olive brown, straight, subconical; the upper two-thirds free, tapering from a broad base, the wall-cells with a distinct spiral twist, very slightly enlarged below the tip, which is slightly, but rather abruptly, distinguished, symmetrical, black, except distally; the apex rounded, and bearing an erect shorter, and an externally divergent, much longer, straight, black-brown, spine-like process. Re-



ceptacle broad, distally tapering to a slender base; the basal and subbasal cells about equal in length, dirty yellowish; cells III and VI about equal in length, much darker; the cells above them almost opaque, bulging externally below the insertion-cells, which bear numerous short, rounded appendiculate cells, one or two of them larger and opaque; the branches numerous, the branchlets similar to those which in general characterize species of this section of the genus (mostly broken in the type). Perithecia  $380 \times 110 \mu$ , the longer spine  $40 \mu$ . Receptacle  $525 \mu$ , or over. Total length to tip of perithecium  $800 \times 185 \mu$ .

On the tip of abdomen of *Dineutes solitarius*, Madagascar (?); Sharp Collection, No. 1075. On North American species of *Gyrinus*.

Fig. 19 represents the type of this species from *Dineutes solitarius*. It is distinguished from other described species by its conical spinose perithecium, and straight subfusiform habit. As has been previously mentioned under *L. Gyrinidarum*, I have referred to this species a form found in various parts of North America on *Gyrinus*, sometimes associated with *L. Gyrinidarum* which, though not quite so large, appears to correspond in all essentials with the present species. The dissimilarity of the two American forms was first called to my attention by Professor Faull who had observed them in Canada, but it seemed to me at the time that they were no more than varieties, an error of which I have been convinced by a thorough reexamination of all the material available.

LABOULBENIA BICORNIS Thaxter. Plate LXVII, figs. 1-2.

Proc. Am. Acad. Arts and Sci., Vol. XXXV, p. 160. Dec., 1899.

Perithecium wholly free, dark brown tinged with olive, becoming opaque, lighter at the base; very elongate, nearly straight, slightly and gradually inflated from the neck-like base to about the middle, thence tapering very slightly to the tip, which is distinctly though not abruptly differentiated: the two inner lip-cells symmetrical, each terminating in a small rounded prominence which bears a second smaller rounded terminal prominence; from the base of the lower prominence a long slender brown or olive-brown horn-like process grows downward, inward, and upward, the two symmetrical and similar and resembling the horns of an ox; though formed from the *inner* lip-cells, a slight twist in the wall-cells usually makes them appear lateral or even external. The two outer lip-cells grow beyond the inner and are closely united forming a large bluntly pointed nose-like projection, its inner margin slightly convex, while externally it is nearly straight and slightly oblique. Receptacle short and stout, evenly dark olive-brown; cell I short, slender; cell II abruptly larger, broad and short. The basal cells of the appendages opaque and indistinguishable, giving rise, as in allied aquatic species, to cladophorous prominences, the branches once or twice branched, hyaline, the lower three or four septa dark, the cells between them slightly inflated, the distal portion elongate, cylindrical, thin-walled, blunt-tipped, without dark septa, the whole forming a dense tuft. Spores  $125-140 \times 7-8 \mu$ . Perithecia  $340-750 \times 60-75 \mu$ . Total length to tip of perithecium, longest  $1150 \mu$ ; to insertion-cell  $340-400 \mu$ ; greatest width  $120-130 \mu$ .

On *Dineutes areus* Klug., Brit. Mus. No. 461, Hadramant, Arabia; on *Dineutes* sp., Brit. Mus. No. 463, Ambaca, Angola, W. Africa. On abdomen, elytra, thorax, and head.

This large species is one of the most striking that has thus far been discovered in this genus, and cannot be confused with any other described form. The peculiar conformation of the tip with its remarkable appendages is quite unique and has the appearance of a cow's head (fig. 2).

LABOULBENIA AQUATICA Thaxter. Plate LXVI, figs. 18-19.

Proc. Am. Acad. Arts and Sci., Vol. XXXV, p. 158. Dec., 1899.

Perithecium free nearly to its base, rather short and stout becoming dark olive-brown, the wall-cells very slightly twisted, the blackened tip well differentiated; nearly symmetrical, subtruncate, the lip-edges hyaline, the lip "valves" prominent. Receptacle rather short and distally broad, olivaceous, lighter below. Insertion-cell unmodified, external, about as large as and nearly symmetrical with cell V, the two lying side by side above cell IV. The appendages consisting of an outer basal cell from which is formed a primary dark brown terminal prominence bearing several small branches distally, while about



its base externally, and often on only one side, several secondary unmodified prominences arise, each producing usually a single terminal branch. The inner basal cell moderately distinct, at first simple, later apparently divided or lobed and bearing several branches. All the branches hyaline, constricted at the lower (four to about six) dark, mostly oblique septa; the distal portion slender, elongate, subrigid, tapering, without constrictions or colored septa, the basal segments bearing numerous typical flask-shaped antheridia. Spores  $70 \times 4.5 \mu$ . Perithecia, average  $100 \times 38 \mu$ . Total length to tip of perithecium average  $220 \mu$ ; to insertion-cell  $150 \mu$ ; greatest width  $30 \mu$ . Appendages, longest  $175 \mu$ .

On *Gyretes* ? sp., Paris Museum, No. 106, Venezuela. On elytra.

Abundant material of this species has been examined, and it appears to be very constant in its characters. The perithecium lacks entirely the peculiar modifications that distinguish nearly all the other members of this aquatic section of the genus, and corresponds in form, structure and appearance to that of the most typical "terrestrial" species. While the appendages, both in their general character and method of origin in connection with a sterile elevation, correspond to the conditions seen in the more pronounced aquatic types, it is the only one of these thus far examined in which typical single flask-shaped antheridia are readily recognizable and abundantly developed (fig. 19). In fact I have as yet been unable to satisfy myself concerning the antheridia in any other aquatic species, a fact which may in part be due to the poor condition in which these forms are usually obtained.

LABOULBENIA CUBENSIS Thaxter. Plate LXVI, figs. 11-13.

Proc. Am. Acad. Arts and Sci., Vol. XXXV, p. 169. Dec., 1899.

Perithecium short and stout, free except at the base, slightly curved toward the appendages, blackish olive, the lip-cells prominent but flattened backward and outward. Receptacle elongate, cells I and II dirty olive, cell III hyaline, long, contrasting with cells IV and V, which, together with the basal cells of the perithecium, are deeply suffused with blackish olive; cell VI as long as cell III and lying beside it, becoming tinged with dirty olive; basal cells of appendages dark olive, indistinguishable, producing concolorous prominences which give rise to a number of hyaline branches, the basal cells of which are large, swollen distally, and bear numerous terminal and subterminal branchlets externally; the branchlets once or twice branched, the septa olive. Perithecia  $155-190 \times 75-85 \mu$ . Total length to tip of perithecium  $480-800 \mu$ . Appendages, longest  $140 \mu$ .

Tip of abdomen of *Dineutes longimanus* Oliv., Paris Museum, No. 101, Cuba.

This species, of which only three specimens have been examined is distinguished by the ear-like modification of the lip-cells (fig. 12) and the numerous appendiculate upgrowths from the insertion region. It has no close allies in this section, though perhaps as nearly related to *L. constricta* as to any other species.

LABOULBENIA CONSTRICTA Thaxter. Plate LXVI, figs. 16.

Proc. Am. Acad. Arts and Sci., Vol. XXXV, p. 167. Dec., 1899.

Perithecium more than one half free, short, stout, inflated, somewhat olive-brown, the tip not differentiated, one of the lip-edges becoming modified to form a flattish or roundish brown prominence which lies usually in a median position between two rather ill defined prominences on either side of it. Receptacle usually with a double curvature, its basal cell very large, somewhat inflated distally, the base and posterior margin paler, cell II shorter, suffused below, strongly constricted distally, the constricted portion paler or hyaline: the distal portion of the receptacle short, deeply suffused, bulging strongly anteriorly below the insertion of the appendages. Insertion-cell not blackened, the appendages arising much as in *L. Orectochili* and *L. strangulata*, the branches hyaline, the basal portion closely septate, simple, without persistent blackened basal portions. Spores  $70 \times 6 \mu$ . Perithecia, average  $130 \times 60 \mu$ . Total length to tip of perithecium, average  $400 \mu$ ; to insertion-cell  $340 \mu$ . Appendages  $70 \mu$  (or more ?).

On *Orectogyrus glaucus* Klug., Brit. Mus. No. 465, Cape Coast Castle, Africa. On elytra.

This form is distinguished by the usually very marked inflation of its large basal cell, and the constriction of its subbasal cell, which forms a slender neck below the distal portion of the receptacle. The



latter is unusually prominent below the insertion-region, though not developed in the abnormal fashion seen in *L. anomala*, which is perhaps its nearest ally. The material examined is not abundant, or in good condition, but, as far as can be determined, the characters are constant.

LABOULBENIA ANOMALA Thaxter. Plate LXVI, figs. 14-15.  
Proc. Am. Acad. Arts and Sci., Vol. XXXV, p. 157. Dec., 1899.

Perithecia nearly symmetrical, free except at the base, tapering distally, the tip somewhat lighter, subtruncate, with one (or more ?) of the lip-edges modified to form a prominent large somewhat irregular blackish brown median projection, which causes the tip to appear notched on the inner side. Receptacle dirty olive-brown, finely punctate, the whole curved almost to a horseshoe form: cells I and II about equal in length and diameter, the base of the perithecium opposite cell III, insertion-cell unmodified external subtriangular, cell V similar to it, about twice as large and occupying a corresponding position on the inner side; the two together with the terminal portion of cell IV, on either side of which they lie, form the free broadly clavate terminal portion of the receptacle above the narrower and also wholly free basal half or more of cell IV. Basal cells of appendages not distinguishable, giving rise to a number of prominences (about twelve) each forming the base of a branch, the branches simple or rarely branched, hyaline, of two kinds, the one with long slightly inflated basal cells, the other closely septate, intermediate forms occurring in which the septa are more remote; all the septa brownish purple. Perithecia  $140 \times 40 \mu$ . Total length to tip of perithecium about  $450 \mu$ ; to tip of free end of receptacle  $450 \mu$ . Appendages  $140-160 \mu$ .

On elytra of *Orectogyrus suturalis* Reg., Paris, No. 102, Zambesi River, Africa; of *O. glaucus* Klug. Brit. Mus. No. 465, Cape Coast Castle, Africa.

This species, of which only scanty material has been examined, is distinguished by its contorted form and the anomalous development of the distal part of the receptacle, the insertion-region being carried up and out free, even beyond the tip of the perithecium. Though similar in some respects to *L. constricta*, it seems abundantly distinguished from this species.

LABOULBENIA DACTYLOPHORA Thaxter. Plate LXVII, figs. 3-4.  
Proc. Am. Acad. Arts and Sci., Vol. XXXV, p. 169. Dec., 1899.

Perithecium relatively small, its upper third, only, free from the receptacle, translucent smoky brown, the tip prominent, not abruptly differentiated, its upper half hyaline, relatively large and broad, subtruncate or irregularly sulcate, the lower half blackened, the lips black-tipped, somewhat spreading. Receptacle very elongate, concolorous with the perithecium or paler, finely punctate, tapering below, its curved base hyaline, the basal cell expanding distally to the very broad upper septum, which forms the middle of a somewhat one-sided enlargement involving the adjacent extremities of cells I and II, cell II more distinctly punctate, very long, tapering very slightly nearly to its distal extremity, cell V producing two outgrowths, one on either side, erect, usually similar, brown, distally somewhat enlarged, the rounded tips often bent slightly outward, extending to or beyond the tip of the perithecium. Appendages consisting of two (or more ?) basal cells from which several protrusions arise bearing groups of branches which are several times branched, forming a dense tuft not as long as the outgrowths from cell V, the lower septa brown or blackish, between the short cells. Perithecia  $170-190 \times 48-50 \mu$ . Total length to tip of perithecium  $750-880 \mu$ ; to insertion-cell  $680-810 \mu$ ; cell II about  $425 \mu$  long. Outgrowths from cell V,  $58 \mu$ . Appendages  $50 \mu$ .

On *Orectogyrus specularis* Aube, Paris Museum, No. 100, Gold Coast, W. Africa: on *O. ornatocollis* Aube, Sharp Coll. No. 1084, Madagascar: also Berlin Museum No. 806, "Africa." Margin of elytra.

Specimens of this species from Madagascar, of which six have been examined, all differ from the type form from Africa (fig. 4, Paris Museum) in that the paired finger-like projections, associated with the appendages are much shorter, while the receptacle lacks the characteristic geniculate habit above cell I, which occurs in all the other specimens. The species is nevertheless very well distinguished, and cannot be confused with any other at present known. The figure of the type (Fig. 4) does not show the deeper suffusion of the paired outgrowths, or of the perithecium and the distal part of the receptacle.



## LABOULBENIA GUERINII Robin.

Sufficiently abundant material of this species has been examined from a variety of localities including specimens on *Gyretes sericeus* in the Paris Museum collected in Venezuela, if I recollect aright, by Guérin-Meneville, from whom the original material of *L. Guerinii* was obtained, so that there can be no doubt as to the accuracy of my former reference of the North American forms on *Gyretes* to this species, despite the fact that, as in the case of *L. Rougetii* the plant does not agree in all particulars with Robin's account and figures. The species is in general constant in its characters, the most striking departure from the usual form occurring in the specimens of *G. cinctus* in the Berlin Museum, the locality of which, Rio Janeiro, was doubtful, according to my memoranda. These specimens vary from the type in the considerable elongation of cell II, which is quite hyaline and contrasts with a deep brown distal suffusion of cell I.

Specimens have been examined from the following sources: Hope Collection: No. 227 on *Gyretes* sp., Mexico: No. 228 on *G. cinctus* Germ., Brazil. Paris Museum: No. 105 on *Gyretes* sp., Arauca, Venezuela; Nos. 97 and 104 on *G. sericeus* Lab., "S. America" and Venezuela; No. 107 on *G. cinctus* Germ., Brazil. British Museum: No. 468 on *G. pulverulentus* Sharp, Columbia; No. 771 on *G. acutangulus* Sharp, Bugaba, Panama; No. 770 on *G. proximus* Sharp, Costa Rica; No. 769 on *G. Guatemalensis* Reg., Paso Antonio, Guatemala; No. 767 on *G. minor* Reg., Torola, Mexico ?; on *G. Boreandri* Chev. Mexico. Sharp Collection: No. 1080 on *G. leionatus* Duby, Mexico; No. 1078 on *G. sericeus* Lab., Caraccas, Venezuela; U. S. National Museum; on *Gyretes* sp., Texas. Berlin Museum: No. 800 on *G. cinctus* Germ., Rio Janeiro ?; No. 801 on *G. dorsalis* Brullé, Brazil; No. 802 on *G. immarginatus*, Mexico; No. 803 on *G. pruinosis* Sharp, Columbia.

## LABOULBENIA DREPANALIS Thaxter. Plate LXVII, figs. 5-6.

Proc. Am. Acad. Arts and Sci., Vol. XXXV, p. 173. Dec., 1899.

Perithecium smoky olive, the inner half or less usually much paler, the upper three fourths free, falcate; the inner margin concave, the tip undifferentiated, the lip-edges forming a small hyaline rounded abruptly distinguished papilla. Receptacle rather short, concolorous with perithecium; cell I paler or hyaline with a basal blackish suffusion; cell V large, growing upward above the oblique insertion-cell which is thus pushed out free from the perithecium together with the basal cells of the appendages. Insertion-cell small, unmodified. Basal cells of the appendages closely united, and finally indistinguishable from one another, forming a prominent rounded outgrowth which gives rise to about six or eight branches, their dark basal septa of variable diameter only remaining, as a rule; the basal cells of the branches are distally inflated, and bear several branchlets externally and terminally, the basal cells of the branchlets mostly similar to those of the primary branches and similarly branched, the ultimate branchlets closely septate, the septa dark. Perithecia, Panama specimens  $100 \times 40 \mu$ , Amazon  $140 \times 35 \mu$ . Total length to tip of perithecium, Panama  $210 \mu$ , Amazon  $275 \mu$ ; to insertion-cell, Panama  $130 \mu$ , Amazon  $140 \mu$ .

On *Gyretes acutangulus*, Sharp, Brit. Mus. No. 771 (Biologia Coll.), Bugaba, Panama; on *Gyretes* sp., Brit. Mus. No. 477, Amazon. On mid-elytron.

This species is distinguished from others of the same section by its falcate perithecium and small prominent insertion region. Specimens from Panama differ from the Amazon material, which is taken as the type (fig. 5), in their smaller size and darker color; but are not otherwise essentially distinguished. As in so many of the aquatic forms, the appendages are either badly broken or wholly wanting in the specimens examined.

## LABOULBENIA HETEROCHEILA Thaxter. Plate LXIV, fig. 16.

Proc. Am. Acad. Arts and Sci., Vol. XXXV, p. 179. Dec., 1899.

Perithecium olive-brown, united to cell IV nearly to its base, rather short, inflated below, tapering distally, the tip not abruptly differentiated, blackened below, the four lip-cells all differently modified: of the two inner lips one produces an erect rather slender brown finger-like terminal outgrowth, the other



a shorter much broader paler outgrowth, turned inward nearly at right angles: of the two outer lips one forms merely a rounded prominence, while the other grows out into a large prominent brown blunt-tipped tooth-like projection, which becomes bent slightly outward and sideways. Receptacle rather long and slender, suffused with brown, the darker distal portion marked by fine transverse indistinct striations. The basal cells of the appendages more or less indistinguishable and giving rise to indistinct prominences bearing numerous branches, the basal cells of which are short, inflated distally, and bear a terminal and external series of closely septate branchlets; the latter once or twice branched, the septa dark, the whole forming a dense tuft about half as long as the perithecium. Spores  $60 \times 6 \mu$ . Perithecium  $200 \times 70 \mu$ . Total length to tip of perithecium  $550 \mu$ ; to insertion-cell  $400 \mu$ . Longest lip-prominence  $35 \mu$ .

On the elytra of *Macrogyrus* sp., Brit. Mus. No. 486, and on *Macrogyrus obliquatus* Aube, Sharp Collection No. 1088, Timor, E. Indies.

The type of this species has unfortunately been so injured that it is not possible to make a drawing of the specimen. The tip of its perithecium, however, which is its most distinctive feature is represented in Fig. 16. The host was given in the original description as *Dineutes* sp. with a query, but it seems probable that it is in reality a species of *Macrogyrus*. The form obtained from the Sharp collection on this genus is not in good condition, nor are the peculiar perithecial outgrowths as well developed. A figure of one of these specimens will be given in a subsequent contribution, unless more typical material can be obtained.

LABOULBENIA DINEUTIS Thaxter. Plate LXVII, figs. 17-18.

Proc. Am. Acad. Arts and Sci., Vol. XXXV, p. 171. Dec., 1899.

Perithecium free except at the base, dark brown, the inner margin straight, the outer curved from the base to the tip, which is not well differentiated, the lip-cells inconspicuously modified to form an inner tooth-like brown prominence curved inward, and a median small brown rounded elevation, which is covered by an outer hyaline externally brown broad irregular elevation. Receptacle elongate or rather short, dark brown, inconspicuously punctate. Appendages arising from a number of basal cells one of which, lying somewhat at the right, is more or less conspicuously prominent and more deeply suffused; the basal cells of the branches somewhat inflated distally, and bearing several branchlets, which may in turn be branched; the lower portion of the branches made up of short cells with contrasting black septa; the distal portions, when unbroken, slender hyaline elongate, without dark septa, much longer than the basal portion. Perithecium (Ceylon)  $275 \times 72 \mu$ , (India)  $140 \times 40 \mu$ . Total length to tip of perithecium, (Ceylon) 1 mm., (India)  $400 \mu$ , (Madagascar)  $350 \mu$ . Appendages, (Ceylon)  $200 \mu$ . Spores, (Ceylon)  $75 \times 6 \mu$ .

On *Dineutes subspinosus* Klug., Paris, Nos. 33 and 34, Madagascar and Isle de France; Hope Collection, No. 236, no locality. On *Dineutes* spp., Hope Collection, Nos. 230, 231, 232, and 235, Bengal, Pondicherry (India), Ceylon, Mauritius. On *Dineutes*, Brit. Mus. No. 483, Nilgiri Hills, India. Berlin Museum No. 808b on *D. subspinosus*, Klg., Pondicherry and No. 808, Isle de France, No. 809 on *D. Indicus*, India. On margin of elytra and tip of abdomen.

This apparently common species is one of the least well defined members of this section. The tip of the perithecium varies but slightly in the conformation and coloration of the projections at its apex. A few specimens show slender hyaline filaments arising distally from the appendages, but in most cases the latter are not in good condition. As will be seen from the above measurements, the species appears to be subject to great variation in size. It is most nearly related to *L. heterocheila* and to *L. denticulata* which may prove to be a mere variety.

LABOULBENIA DENTICULATA Thaxter. Plate LXVII, figs. 7-9 and 12-13.

Proc. Am. Acad. Arts and Sci., Vol. XXXV, p. 170. Dec., 1899.

Perithecium free, olivaceous with blackish shades below the paler tip, rather narrow, straight; the tip broad, one of the inner lip-cells forming a short brown conical terminal prominence which is straight



or bent toward the pore contrasting with the nearly colorless lip-edges below it. Receptacle pale brown or dirty olivaceous, elongate, normal. The insertion-cell nearly horizontal external to cell V, unmodified. The outer basal cell of the appendages giving rise to a single subconical brown prominence bearing branches terminally and externally and protruding beyond the inner basal cell, which is indistinguishable from the very numerous branches arising from it in all directions; all the branches hyaline, their basal cells bearing distally several branchlets which may again be branched, the four to eight lower septa dark. Perithecia, average  $175 \times 44 \mu$ ; the spine-like apex  $10-12 \mu$ . Total length to tip of perithecium  $400-575 \mu$ ; to insertion-cell  $275-400 \mu$ ; greatest width  $55-70 \mu$ . Appendages about  $70 \mu$ .

On *Dineutes?*, Brit. Mus. No. 482, Adelaide River, Australia.

A comparison of this Australian form with more abundant material of *L. Dineutis*, makes it appear very doubtful whether the two should be kept distinct, and their separation must be considered merely provisional. I have included under this name the form on *Macrogyrus elongatus*, represented in fig. 12-13, from New Guinea (Sharp Collection No. 1089) in which the conformation at the tip of the perithecium is even more unlike that of the typical *L. Dineutis* (fig. 18), and the appendages are very copiously developed. Yet it is hardly possible without examining more abundant material of all these forms to determine their relationships satisfactorily.

LABOULBENIA FALLAX Thaxter. Plate, LXVII, figs. 14-15.

Proc. Am. Acad. Arts and Sci., Vol. XXXV, p. 176. Dec., 1899.

Perithecium becoming dark dirty olive-brown; the tip blackened, bent outward, the lips hyaline. Receptacle becoming concolorous with the perithecium except the hyaline slender basal cell, the remaining cells usually short and stout except cell V, which extends up along the inner margin of the perithecium nearly to its tip, its inner margin continuing the curvature of the tip down to the insertion of the appendages, so that the perithecium seems at first sight twice its actual size. Insertion-cell unmodified, forming a slight rounded external prominence within which the basal cells of the appendages form an evenly curved base from which arises a single antero-posterior row of branches about twelve in number, their lower cells slightly inflated, hyaline with dark septa, usually twice branched; the ultimate branchlets above the third or fourth septum slender without dark septa, scarcely exceeding the tip of the perithecium. Perithecium  $100-120 \times 35-40 \mu$ . Total length to tip of perithecium  $190-325 \mu$ ; to insertion-cell  $120-250 \mu$ . Greatest width  $85 \mu$ . Appendages  $50 \mu$ . (The larger measurements are from the Amazon specimens.)

On *Gyretes acutangulus* Sharp, Brit. Mus. No. 771 (Biologia Coll.), Bugaba, Panama; on *Gyretes* sp., Brit. Mus. No. 477, Amazon River; on *Gyretes* sp., Hope Coll. No. 229, Rio de Janeiro. At tips of elytra.

This species is very clearly distinguished, both from the monstrous development of cell V, and from the crest-like insertion of its appendages. The material is very scanty from all of the localities above mentioned, but there seems to be no considerable variation except in size and depth of suffusion, the latter, which involves the perithecium and the distal portion of the receptacle in most instances, is not shown in fig. 14. In several specimens there are two, or even three, external blackish elevations below the tip of the perithecium, which look like the base of old trichogynes, and in one young specimen two trichogynes seem actually to have been formed one above the other.

LABOULBENIA ROTUNDATA Thaxter. Plate LXVII, fig. 16.

Proc. Am. Acad. Arts and Sci., Vol. XLI, p. 317. July, 1905.

Perithecium deep brown, except below the tip; broadly rounded, the inner margin of the upper half free above the insertion-cells, and formed by a single long cell extending to the tip, somewhat as in *L. fallax*, and perhaps representing a marginal extension of the receptacle, as in that species. The tip blunt, with two minute inner tooth-like prominences of unequal size, the larger subtended by a narrow black suffusion, the whole tip more deeply suffused externally. Receptacle straight, elongate, tapering



throughout to the base, the basal cell more deeply suffused distally, and protruding somewhat anteriorly below the subbasal cell, which is pale dirty yellowish-brown, inconspicuously granular-punctate: the distal portion dark dirty brown, the cell-boundaries hardly visible. The insertion cells small, giving rise to numerous (a dozen or more, for the most part broken in the type) primary slender clavate cells, from which closely septate short branchlets arise externally. Perithecium  $185 \times 65 \mu$ , not including the marginal cell, which is  $18 \mu$  broad. Receptacle  $360 \mu$ . Appendages (broken) about  $50 \mu$ . Total length to tip of perithecium  $450 \mu$ .

On *Dineutes spinosus*, Fabr., Java; Sharp Collection, No. 1086.

A single specimen, only, of this species has been examined, which is so deeply suffused that it is not possible to determine with certainty whether the peculiar cell which extends from the insertion region to the tip of the perithecium should be regarded as a prolongation of cell V, as it manifestly is in *L. fallax*, or as an abnormally developed wall-cell of the perithecium itself. It is so closely associated with the extreme tip of the perithecium that I am rather inclined to the latter view, but it will be necessary to see younger individuals before this can be determined. The species is not likely to be confounded with any other in this group by reason of the rounded form of its broad perithecium.

LABOULBENIA ORECTOCHILI Thaxter. Plate LXVII, figs. 10-11.

Proc. Am. Acad. Arts and Sci., Vol. XXXV, p. 191. Dec., 1899.

Perithecium free except at the base, more or less evenly suffused with smoky brown, with a subterminal external blackish patch, nearly symmetrical and straight, slightly inflated, tapering gradually to the hyaline tip which is surmounted by a median straight pointed purplish tooth-like projection, formed by the outgrowth of one of the lip-cells; the inner lip-cells forming a small hyaline or partly purplish lateral papilla. Receptacle elongate, cells I and II stout, the latter slightly if at all narrower distally, cells IV and V and the basal cells of the perithecium darker brown, the rest very pale yellowish or purplish brown, finely punctate, the dots scarcely visible except in the more deeply suffused areas. The insertion-cell broad, blackened, extending completely across the distal margins of cells IV and V. Appendages consisting of an inner and outer basal cell, giving rise in all to from five to ten erect subconical prominences, each of which becomes separated as the basal cell of a very short two-celled branch of which only a blackened basal portion remains in mature specimens, the rounded purplish slightly inflated terminal portion of the upper cell usually breaking off above its blackened slightly constricted basal half. Of the branches, that borne by the protuberance first formed from the outer basal cell, is always somewhat larger and more prominent than the rest. Perithecia  $190 \times 59 \mu$ . Total length to tip of perithecium  $475-680 \mu$ ; to insertion-cell  $400-550 \mu$ .

On *Orectochilus cordatus* Reg., Paris No. 99, "Asia." On elytra. Berlin Mus. No. 805, on *O. semivestitus* Guér., Siam. Sharp Coll. No. 1081 var. on *O. oblongiusculus* Reg., "Pedong."

This, together with the two succeeding species, form a well marked group in this section of the genus owing to the normal differentiation of the insertion-cell and the production of a variable number of basal cells, each of which bears but a single appendage, distinguished by a broad black septum. In the type cells, each of which bears but a single appendage, distinguished by a broad black septum. In the type form the appendages are more numerous (fig. 11, on *O. cordatus*), and the color darker. The extreme of variation, so far as it has been observed, is illustrated by fig. 10, on *O. oblongiusculus*, where but two basal cells are developed, and a slight difference in the projections from the tip of the perithecium is observable. The species is most nearly allied to *L. strangulata*, from which, as well as from *L. coarctata*, it is at once separated by the perithecial projections.

LABOULBENIA STRANGULATA Thaxter. Plate LXVI, fig. 20.

Proc. Am. Acad. Arts and Sci., Vol. XXXV, p. 202. Dec., 1899.

Perithecium one third to one half free, dark brown, concolorous below with the distally almost opaque receptacle; symmetrical, straight; the tip undifferentiated, bluntly rounded except for a hyaline flattish terminal papilla formed by the projection of one of the external lip-cells. Receptacle slender, cell I usu-



ally basally curved, broader at the distal end where it is rather deeply suffused with brown; cell II much longer, its lower two thirds often distinctly inflated, deep brown distally, rather abruptly constricted to less than half its greatest diameter, the constricted portion hyaline, the short remaining portion above the constriction becoming deep brown, concolorous with the upper portion of the receptacle. Insertion-cell normal, oblique, often concave above, the appendages consisting of an outer and an inner basal cell, the two producing in all from three to six outgrowths, hyaline, except the first one formed from the outer basal cell which is always external to those subsequently formed and is often divergent, deep brown or opaque, the suffusion involving the basal cell which bears it: each branch consists of a single simple cylindrical cell the distal portion of which is usually broken off, leaving the deep brown contrasting base. Spores  $60 \times 4.5 \mu$ . Perithecium  $120-140 \times 40-45 \mu$ ; to insertion-cell, average  $275 \mu$ . Appendages  $100 \mu$ .

On *Orectochilus* ?, Brit. Mus. Nos. 480 and 484, Timor, East Indies. Margin of elytra. On *O. discifer* Walk., Sharp Coll. No. 1079, Nilghiri, India. No. 1076 and No. 1082, "Kodeicanel" Mts., Ind. Orient.

This species possesses a strangulate habit somewhat similar to that of *L. constricta*; but is otherwise quite different, being most nearly allied to *L. coarctata*. The small protruding lip-cells vary somewhat in their conformation, sometimes merely papillate, sometimes slightly spreading, subtended on the inner side by a blackish suffusion which is more or less conspicuous. Fig. 20 represents one of the specimens from Timor which are regarded as the type forms.

LABOULBENIA COARCTATA Thaxter. Plate LXVI, fig. 17.

Proc. Am. Acad. Arts and Sci., Vol. XXXV, p. 165. Dec., 1899.

Perithecium short and stout, dark brown and opaque, its upper half free, its contour evenly rounded, the small papillate translucent tip turned slightly inward and abruptly differentiated, the lips well defined. Receptacle dirty brown finely and obscurely punctate, of the typical form, lighter below, short, stout, cell I much narrowed below, cell II very broad, slightly inflated. Insertion-cell normally differentiated, broad and black. Basal cells of appendages well developed bearing about eight erect short stout simple branches with broad basal constricted blackened septa, their rounded tips slightly exceeding the tip of the perithecium. Spores  $70 \times 7 \mu$ . Perithecia  $140-170 \times 62 \mu$ . Total length to tip of perithecium  $325-400 \mu$ ; to insertion-cell  $250-300 \mu$ ; greatest width  $100 \mu$ .

On *Orectochilus* ?, Hope Coll. Nos. 233 and 234; Brit. Mus. No. 466, Bengal, India. Along median depression of elytra.

This species, which was found on several specimens growing along a groove of the elytra, is most nearly related to *L. strangulata*, but is abundantly distinct in a variety of ways. The material is in unusually good condition and abundant, and the characters appear to be very constant. Although the determination of the host is doubtful, there can be little chance of confusion in the case of so well defined a species.

RHACHOMYCES Thaxter.

This type proves to be a very constant one and the species, which are rather numerous, are found in all parts of the world on Carabidæ and Staphylinidæ. The main axis, as has been previously pointed out, is a proliferous branch arising from the subbasal cell of a two-celled appendiculate primary receptacle. The variations in the development of this secondary axis are very remarkable and the most highly developed forms are very striking in appearance.

In the more elongate species there are certain curious appearances on the cells of the main axis which strongly suggest the stigmata of lepidopterous and other insect larvæ. These appearances which are shown in the accompanying figures of *R. Philonthinus* and *R. Dolicaontis*, Plate XLIV, figs. 3-4 and 8, occur three on each cell as a rule, two lateral and one anterior. They do not appear to occur on the short forms, and it seems possible that they may act as valves to relieve the tension caused by sudden and abrupt flexion



to which such individuals must often be subject. A structure somewhat similar in appearance has been described in connection with the perithecium of *Laboulbenia* (Monograph, Plate II, fig. 14, *x*).

RHACHOMYCES CANARIENSIS Thaxter. Plate XLIV, figs. 1-2.

Proc. Am. Acad. Arts and Sci., Vol. XXXV, p. 436. April, 1900.

Perithecium pale straw-colored, nearly straight, a median and subterminal well-defined broadly-rounded ridge marking the transverse septa between the three lower tiers of wall-cells; the tip tapering rather abruptly, hyaline, the apex rounded. Receptacle rather slender, the basal and subbasal cells relatively large, hyaline, the rest pale straw-colored, the main axis consisting of fifteen or sixteen cells, the upper five or six forming a free erect termination. The appendages not numerous, appressed, brown; those about the base of the perithecium larger, distally blunt and hyaline, about two thirds as long as the perithecium. Perithecia  $90-130 \times 27-30 \mu$ . Receptacle  $175-225 \mu$ . Appendages, longest, about  $100 \mu$ . Total length to tip of perithecium  $250-325 \mu$ .

On the elytra of *Trechus flavomarginatus* Woll., British Museum, No. 419. Teneriffe: Paris Museum No. 184, on *Trechus Asturiensis* Le Br., Grotte de Puerto de Paganes, Asturias. Berlin Museum on *T. rotundipennis* Duft., "Gastein."

This small species, specimens of which from Teneriffe, fig. 1, and the single specimen from "Gastein," are illustrated in the accompanying plate, is well distinguished by the pale color of its appendages, the very prominent antheridia, and the two successive ridges which are present in the perithecium. It appears to be rare, and only one or two specimens were found on each of the hosts above referred to.

RHACHOMYCES THALPII Thaxter. Plate XLV, figs. 6-7.

Proc. Am. Acad. Arts and Sci., Vol. XXXV, p. 436. April, 1900.

Perithecium hyaline or straw-colored, becoming faintly tinged with brown, slender, inflated near the base; the distal half or less mostly curved away from the appendages, tapering gradually to the blunt undifferentiated apex. Receptacle normally consisting of eleven cells superposed to form the main axis, hyaline, their septa horizontal or but slightly oblique, the basal cell subtriangular, tinged with reddish brown; the cells of the secondary series hyaline and proportionately rather large. Appendages rather dense, almost opaque except the nearly or quite hyaline tip and inner margin; rather short, about four to six of those about the base of the perithecium much larger, longer, and stouter, reaching somewhat higher than the middle of the perithecium, their tips at first clavate becoming obliquely truncate or fan-shaped through the degeneration of the hyaline portion, the curved tips of the antheridia projecting rather conspicuously. Perithecia  $115-30 \mu$ . Total length of receptacle  $140 \mu$ . Longer appendages  $90 \mu$ .

On *Thalpius rufulus* Lec., U. S. National Museum, Texas.

This species is very closely related to *R. Zufi* from which it seems constantly to differ in its smaller size and differently shaped curved perithecium, the distal portion of which, even in young specimens, is free above the longest appendages. The appendages about the base of the perithecium are in both species characteristically spathulate-tipped, this type being larger, longer and more numerous in *R. Zufi* and extending down the axis to the base.

RHACHOMYCES ZUPHII Thaxter. Plate XLV, figs. 10-11.

Proc. Am. Acad. Arts and Sci., Vol. XXXV, p. 436. April, 1900.

Perithecium relatively small, straw-colored, somewhat inflated at the base, the tip rather abruptly distinguished and slightly inflated. Axis of the receptacle slender, consisting normally of about sixteen cells which are nearly hyaline, or with brown shades below the septa. Appendages nearly opaque, straight stout appressed, not elongate, more or less swollen distally along the inner margin of the subhyaline tip; eight to ten about the base of the perithecium longer and stouter. Perithecia  $110-140 \times 25 \mu$ . Longer appendages about  $110-140 \mu$ . Total length to tip of perithecium  $350-400 \mu$ .

On *Zuphium Mexicanum* Chaud., British Museum (Biologia Coll.), No. 713. Cordova, Mexico.



Closely allied to *R. Thalpii*, but larger, with longer and more numerous appendages which nearly conceal the perithecium. The septa of the axis are usually more or less deeply suffused. In one specimen these suffusions above form black bands, but the region is not visible in a majority of the specimens, being hidden by the appendages.

RHACHOMYCES PILOSELLUS (Robin) Thaxter.

Scanty material of this species in poor condition was found in the Paris Collection, No. 176 on *Lathorium fulvipenne* Fab. from France, and also on the same host var. *apteraum* in the Berlin collection from Europe. The specimens appear to correspond in all respects with those previously examined.

RHACHOMYCES APHÆNOPSIS Thaxter. Plate XLV, figs. 12-14.

Proc. Am. Acad. Arts and Sci., Vol. XLI, p. 314. July, 1905.

Perithecium but slightly inflated, hyaline, straight, the tip blunt symmetrical. Receptacle variable, hyaline; the main axis consisting of about ten to fifteen hyaline cells, the two lowest larger and suffused with brown, the rest broader than long, and separated by somewhat oblique septa; the hyaline appendiculate cells relatively large, and not concealed by the appendages, which are rich black brown, the lower ones, when unbroken, extending upward far beyond the tip of the perithecium and curved toward it: those arising about its base, and even below it from the inner cells of the appendiculate series, unlike the rest, erect, straight, consisting of a paler basal part, five to six septate, with constrictions at the septa, and a distal unicellular more or less elongate portion. Perithecium (not fully matured) about  $85 \times 25 \mu$ . Receptacle  $75-165 \times 15-18 \mu$ . The longest appendages about 300-350  $\mu$ .

On the elytra of *Aphænops cerberus* Diek., Ariège, France; Sharp Collection, Type, No. 1142; Berlin Museum, No. 877; Paris Museum, No. 193.

I have found a few specimens of this species in all the collections mentioned, but none are fully matured and only the two figured have perithecia. The species is well characterized by the closely septate appendages about the base of the perithecium, and the long clear rich dark brown appendages of the usual type which arise from the axis and are as long near its base as near its summit. The species is most nearly allied to *R. hypogæus* and all the specimens infested appear to have come from the same locality.

RHACHOMYCES HYPOGÆUS Thaxter.

Single preparations of this species have been obtained from the Hope Collection, No. 304 on *Anophthalmus oblongus* Motsch, Carniola, and from the Berlin Museum on *A. Bilimeki* Sturm. from the Adelsburg Grotto, No. 872: both, however, immature. Several small forms which are perhaps undeveloped individuals of this species were also found in the Paris Museum on *A. hirtus* Sturm., No. 192, and *Anophthalmus* "n. s."

RHACHOMYCES STIPITATUS Thaxter. Plate XLIV, figs. 5-6.

Proc. Am. Acad. Arts and Sci., Vol. XXXV, p. 438. April, 1900.

Perithecium pale straw-colored becoming tinged with brownish, much darker toward the tip; broadly subfusiform, usually symmetrical, tapering from about the middle to the small blunt usually symmetrical, hardly differentiated, often hyaline tip; borne free on a stalk-cell which is concolorous, sometimes as long as the receptacle, in other cases but slightly developed. Receptacle straw-colored, or faintly brownish with pale "stigmatal" marks; the main axis consisting of about fifteen to seventeen cells, the septa rather oblique, its distal portion, consisting of about two to four cells, erect and free: the cells of the secondary axis relatively large, concolorous, that opposite the subbasal cell of the main axis bearing a long opaque blackish brown appendage curved toward the receptacle and often equalling it in length, other similar appendages arising at intervals above it but not from all the lower cells, becoming more numerous throughout the distal half and in some instances extending to or beyond the tip of the perithecium even in the long-stalked forms, associated throughout with shorter appendages and antheridia. Some of the individuals



on *A. Lespezi* small, the main axis of the receptacle consisting of only seven cells, the perithecia nearly sessile and small in proportion. Spores  $50-60 \times 4 \mu$ . Perithecia  $140-150 \times 45-69 \mu$  ( $100 \times 30 \mu$  in small specimens), the stalk including basal cells, longest  $220 \times 47 \mu$ . Total length to tip of perithecium about  $550 \mu$  ( $200-680 \mu$ ). Receptacle  $325 \mu$  ( $110-350 \mu$ ). Appendages longest  $400 \mu$ .

On *Anophthalmus Rhadamanthus* Lind., Hope Coll. No. 306, Greece; on *A. Lespezi* Fair., Paris Museum; No. 185, Grotte des Capucini, Seine et Garonne, France.

Although the types of this species on *A. Rhadamanthus*, which are figured in the accompanying plate, are strikingly unlike the other species, specimens occurring on *A. Lespezi* were found in the Paris collection which, though distinctly smaller, have similar stiff upright appendages, and although it is not so well developed, the perithecium has a distinct stalk. An examination is needed of a large number of these cave forms, and it is barely possible that *R. hypogæus* may tend to vary toward the present species.

RHACHOMYCES GLYPTOMERI Thaxter. Plate XLV, fig. 16.

Proc. Am. Acad. Arts and Sci., Vol. XXXVII, p. 39. June, 1901.

Receptacle slender, dirty translucent brown, the main axis consisting of about seven cells (below the lower of the two perithecia which are present in the type): the appendages slightly divergent, large and long, opaque brown, flexed inward near their hyaline, somewhat more slender extremities, and extending beyond the tips of the perithecia. Perithecium short-stalked, strongly curved, slightly inflated, hyaline, soiled with brownish, the tips well distinguished, blackish brown and obliquely truncate. Perithecia, including basal and stalk-cells, about  $185 \times 44 \mu$ . Receptacle to base of lower perithecium  $150 \times 15 \mu$ . Appendages, longest  $360 \mu$  or more.

On tip of abdomen of *Glyptomerus cavicolus* Müll. Carniola, Austria. Sharp Collection, No. 1141.

The solitary type of this species which is well defined by the shape of its perithecia and the character of its appendages, is illustrated in the accompanying plate. This specimen is no doubt abnormal in producing two perithecia, the axis of the normal receptacle probably not consisting of more than a dozen cells at most; the distal portion in this specimen representing a proliferation such as is seen occasionally in most species of the genus, which gives rise to a second perithecium. The cave-dwelling staphylinid which it inhabits appears to be rare in collections.

RHACHOMYCES CAYENNENSIS Thaxter. Plate XLV, figs. 4-5.

Proc. Am. Acad. Arts and Sci., Vol. XXXV, p. 438. April, 1900.

Perithecium rather small, yellowish, the anterior margin nearly straight, the posterior convex; the tip clearly and abruptly differentiated, concolorous, asymmetrical, somewhat bent. Main axis of the receptacle rather strongly curved, consisting of about twelve cells; the basal ones slender, deeply suffused, those immediately above opaque slender, the rest rather large with central brown suffusions; the distal cells paler. Appendages rather coarse, crowded, black-brown, opaque or nearly so, the tips mostly bent outward, appressed below, somewhat divergent distally; six or more about the base of the perithecium slightly longer than the rest, nearly equalling, sometimes slightly exceeding the perithecium in length. Perithecium  $120-140 \times 25-30 \mu$ . Total length to tip of perithecium about  $350 \mu$  (average). Longest appendages  $140 \mu$ .

On *Cryptobium* sp. indet., British Museum No. 387. Cayenne. On the inferior surface of abdomen.

This species is distinguished most readily by the form of the perithecium, straight on the inner side and strongly curved on the outer to the peculiar and well differentiated tip: as well as by its short, stout, curved form, and dense appendages. The small group of appendages characteristically curved outward near the base which are shown at the left in figure 4, appear to be peculiar to this species, although in some specimens they have been broken off.



## RHACHOMYCES FURCATUS Thaxter.

Specimens of this species, which is well marked by its long appendages and the considerable extension of its axis beyond the base of the perithecial stalk-cell, have been found as follows: Hope Collection, No. 221, on *Othius fulgidus*, no locality: in the British Museum, No. 382 on *O. fulvipennis* Fabr., France; No. 428 on *O. melanocephalus* Grav., Europe and on *O. fulvipennis* Fabr. in the Berlin Museum (immature). In addition to these single specimens of a somewhat paler and more slender variety were found on *O. myrmecophilus* Kies. from Tilgate, England, in the British Museum, No. 440, and in the Berlin Museum, No. 812, on *O. melanocephalus* Grav., from England. This form, however, does not seem separable from the type which is clearly defined and appears to be confined to Europe.

RHACHOMYCES CRYPTOBIANUS Thaxter. Plate XLV, fig. 15.

Proc. Am. Acad. Arts and Sci., Vol. XXXV, p. 437. April, 1900.

Perithecium hyaline or pale straw-colored, very long and slender, nearly isodiametric throughout, almost straight, the tip apparently blunt and not well differentiated. The main axis of the receptacle consists of about sixteen cells; the basal cell and those immediately above it slender black and opaque; the rest becoming larger upward, hyaline suffused or mottled with reddish brown. Appendages numerous, slightly divergent, becoming longer from the base upward, nearly opaque except along the inner margin and at the tip which is generally bent abruptly outward, a group of about six below the base of the perithecium much longer than the rest and curved outward in a tuft, those arising about the base of the perithecium very elongate, erect, with straight blunt tips, reaching nearly to the apex of the perithecium. Perithecium  $490-450 \times$  (about)  $35 \mu$ . Receptacle  $275-430 \mu$ . Total length to tip of perithecium  $650-800 \mu$ . Longest appendages  $300-430 \mu$ .

On *Cryptobium capitatum*, Paris Museum, No. 172. Brazil.

A fine species remarkable for its long slender perithecium and the characteristic disposition of its appendages near the base of the latter.

RHACHOMYCES OEDICHIRI Thaxter. Plate XLV, figs. 8-9.

Proc. Am. Acad. Arts and Sci., Vol. XXXVII, p. 38. June, 1901.

Receptacle strongly curved, rather short, the lower cells especially more or less suffused with clear brown, the basal cell slender, the cells of the main axis above it successively larger, about ten to twelve in all. Appendage hardly ever reaching to the tip of the perithecium; the shorter margin alone subulate and straight, the rest appressed, denser toward the base of the perithecium, where they form a tuft which does not wholly surround it, curved slightly outward, somewhat attenuated; tips abruptly recurved or subhelicoid. Perithecium somewhat inflated with a more or less evident submedian ridge, hyaline, with the exception of several longitudinal dark brown marks at the tip, the base concealed by the appendages. Spores  $36 \times 4 \mu$ . Perithecia  $90-110 \times 30-35 \mu$ . Total length to tip of perithecium  $220-250 \mu$ . Longest appendages about  $90 \mu$ .

On *Oedichirus* nov. sp. Rio de Janeiro, Brazil. Sharp Collection, No. 1154.

This pretty species is distinguished by its short stout curved form; absolutely hyaline perithecium, with small subterminal brown patches; and characteristic appendages, which are mostly similar, gradually longer from below upward and abruptly recurved at the tips, forming a little hook. The species is very constant in its characters, and appears to be most nearly related to *R. Philonthinus*. The host is a staphylinid supposed to be a new species, and is allied to *Pinophilus*.

RHACHOMYCES PHILONTHINUS Thaxter. Plate XLIV, figs. 3-4.

Proc. Am. Acad. Arts and Sci., Vol. XXXV, p. 435. April, 1900.

Perithecia borne on a short broad hardly visible stalk-cell, reddish brown, inflated toward the base, conical above, straight and nearly symmetrical, the tip blunt, undifferentiated, symmetrical. Main axis of the receptacle distinct, consisting of about twenty cells, the "stigmatal" markings usually conspicuous



including about eight to ten cells which form its erect free termination beside the base of the perithecium; the three lower cells mostly suffused with red brown, those above hyaline or partly suffused, increased in size to about the eleventh cell, above which they become successively smaller to the tip of the free portion; the septa for the most part marked by rather prominent constrictions. Appendages numerous but not obscuring the main axis of the receptacle, slightly divergent, mostly tapering distally and slightly bent below the straight hyaline tips; those arising about the base of the perithecium only slightly longer and stouter, brown and mostly blunt tipped, about six in number and as a rule hardly extending to the middle of the perithecium. Spores about  $40-45 \times 4 \mu$ . Perithecia  $140-200 \times 40-60 \mu$ . Receptacle  $220-340 \mu$ . Total length to tip of perithecium  $300-1000 \mu$ . Longest appendages about  $100 \mu$ .

On *Philonthus longicornis* Steph., British Museum, No. 408, Island of St. Helena; on *Philonthus* sp. indet., Hope Coll., No. 225, British Isles. Berlin Museum, No. 814 on *P. albipes* Grav., Sweden; No. 827 on *P. exiguus* Nord., Europe. Sharp Coll.; No. 1132, on *P. gastralis* Sharp, Japan; No. 1129 on *P. mutans* Sharp, China; No. 1107 and 1109 on *Amichrotus apicipennis* Sharp, Japan; No. 1193 on *Amichrotus* sp., Japan; No. 1133 on a new genus near *Amichrotus*, Japan.

Although this species has not yet been seen from America, it appears to be widely distributed in the western hemisphere, as is indicated by the above list of hosts. It is a well defined species, varying mostly in size, the very large specimens (fig. 3) occurring on *Amichrotus*, a genus said by Dr. Sharp to be very near, if not identical with *Philonthus*. Its numerous rather short stiff appendages do not differ greatly in length throughout the receptacle, and are characteristically bent at the tips. An individual typical in form and size is represented in fig. 4 which was obtained from a British *Philonthus*. The species is most nearly allied to *R. Oedichiri* and *R. arbusculus*, the latter differing in the form of its perithecium and the differentiation of its appendages.

RHACHOMYCES DOLICAONTIS Thaxter. Plate XLIV, fig. 8.

Proc. Am. Acad. Arts and Sci., Vol. XXXVII, p. 39. June, 1901.

Form elongate. Cells of the main axis of the receptacle twenty to thirty-five, more or less dirty brownish, banded with dark blackish brown below, while the more slender proximal cells are usually opaque; the axis of nearly equal diameter throughout and nearly straight above about the eighth cell; each cell containing distally one, the axis cells two, roundish or oblong brown bodies (possibly valve-like structure) which suggest the stigmata of an insect larva. The appendages somewhat divergent, opaque, except a narrow upper hyaline margin, short, stiff and numerous; those external more slender, slightly curved and sharply pointed; those between somewhat stouter and longer, with slightly recurved tips; those about the base of the perithecium, which they do not conceal, but slightly longer and few in number. Perithecium short-stalked, slightly more or less symmetrically inflated, dull brown, minutely punctate or granular, not uniformly suffused; the tip with darker shades, the blunt apex hyaline. Spores  $66 \times 5 \mu$ . Perithecia  $150-200 \times 42-60 \mu$ , including the basal and stalk-cells. Larger appendages  $90-110 \mu$ , smaller about  $75 \mu$ . Total length  $600-1100 \mu$ , the average diameter about  $30-35 \mu$ .

On all parts of *Dolicaon Lathrobioides* Casteln. Cape of Good Hope, Africa. Sharp Collection, No. 1146. Berlin Museum, Nos. 833 and 842.

A specimen of this large staphylinid in Dr. Sharp's collection was found completely covered by this fine species. It differs from the other elongate forms in its rather small and not very numerous mostly divergent appendages. The peculiar stigmata-like markings on the cells of the receptacle are unusually conspicuous in the species, and the dark lines which separate the perithecial wall-cells are usually more pronounced than is indicated in the figure. The surface of the perithecium appears to become granular as it matures, and more deeply suffused with brown. The characters of the species are very constant although there is some variation in size.



## RHACHOMYCES LONGISSIMUS Thaxter.

Fine specimens of this species, which is the largest of the genus and may reach a length of almost two millimeters, have been obtained in the British Museum on *Colpodes evanescens* Bates No. 694, Totonicapan, Guatemala; on *C. proteinus* Bates, No. 699, Vera Paz, Guatemala; on *C. reflexus* Chaud., No. 1042 from Columbia. It shows a certain amount of variation in color, few specimens being as dark as the one represented in my Monograph. The appendages also are often more widely separated from one another, and the axis relatively stouter. It recalls *R. Dolicaontis* which, however, lacks the successive pairs of divergent appendages which are so characteristic in this species as well as in *R. tenuis*, to which it appears to be most nearly allied.

## RHACHOMYCES TENUIS Thaxter. Plate XLIV, fig. 7.

Proc. Am. Acad. Arts and Sci., Vol. XXXV, p. 437. April, 1900.

Perithecium relatively small, the lower half or more hidden by the appendages, hardly inflated, faintly tinged with brown, tapering very slightly to the tip, which is suffused with dark brown, broad, hardly differentiated and slightly asymmetrical. Receptacle very long and slender, the cells of the main axis thirty to forty in number, dark reddish brown or nearly opaque, subhyaline below the somewhat oblique septa, except the lower members of the series, which are as a rule wholly opaque; the cells increasing slightly in size from the base upward. Appendages straight, narrower distally, rather short and appressed, not very numerous; those about the base of the perithecium, about twelve in number, somewhat larger and longer than the rest, surrounding and concealing it more or less completely; some of the lower appendages also longer and curved conspicuously outward, as are the antheridia. Perithecia about  $110 \times 30 \mu$ . Longer appendages about  $140-160 \mu$ . Greatest width of receptacle about  $20 \mu$ . Total length to tip of perithecium  $800-1000 \mu$ .

On the legs of a small carabid beetle, Paris Museum, No. 113. Java.

This elegantly formed species is distinguished from *R. longissimus*, which appears to be its nearest ally, by its more slender form, its more slender and differently shaped perithecium and the character of its appendages, which are quite different, although the same succession of projecting pairs occurs, the members of which, unlike those of *R. longissimus*, are subulate and not recurved.

## RHACHOMYCES JAVANICUS Thaxter. Plate XLV, figs. 1-2.

Proc. Am. Acad. Arts and Sci., Vol. XLI, p. 314. July, 1905.

Perithecium straight, symmetrical, tapering slightly distally, translucent, brown, the tip opaque blackish brown, the apex hyaline and blunt, the whole surrounded and more or less hidden up to the tip by the appendages. Receptacle rather long and slender, the main axis normally consisting of more than twenty cells which are clearly distinguishable, more or less suffused with blackish brown, less so toward the base, more or less hyaline at, and obliquely below, the septa; the appendiculate cells giving rise to a dense series of similar black subequal appendages, their inner edges somewhat hyaline, with slightly upturned and enlarged bluntly pointed hyaline tips, more numerous distally and forming a dense tuft below and around the perithecium which they conceal, except for its projecting tip. Perithecium  $95-110 \times 35-40 \mu$ . Receptacle  $275-350 \mu$  by about  $18 \mu$ . Total length  $350-460 \mu$ . Appendages, longer, about  $90-100 \mu$ .

On legs of a small Harpaloid (?) beetle brought from Buitenzorg, Java, by Dr. H. M. Richards.

Closely allied to *R. velatus*, but differing in its smaller size more slender form and fewer stouter appendages, which do not conceal the axis as in *velatus*.

## RHACHOMYCES VELATUS Thaxter. Plate XLIV, fig. 9, XLV, fig. 3.

Proc. Am. Acad. Arts and Sci., Vol. XXXV, p. 435. April, 1900.

Perithecium short stout straight symmetrical, evenly inflated, pale brownish, translucent; the tip abruptly dark brown, opaque or nearly so, tapering symmetrically to the blunt rounded apex. Receptacle



varying in length, consisting of perhaps eighteen to twenty cells, the basal cell and sometimes two or three of those above it hyaline or nearly so, the rest indistinguishable, being concealed by the densely crowded appressed appendages, which are rather short and slender, deep brown or opaque except along the inner margin and at the tip; those around the base of the perithecium also densely crowded, subequal blunt-tipped, wholly suffused, completely enveloping it and wholly concealing it till it is fully developed when the tip alone projects beyond them. Spores about  $35-40 \times 3-4 \mu$ . Perithecia  $175 \times 75 \mu$  or smaller. Total length to tip of perithecium  $400-550 \mu$ . The longer appendages about  $120 \mu$ .

On *Colpodes agilis* Chaud., British Museum (Biologia Coll.), No. 696, Jalapa, Mexico; on *C. atratus* Chaud., British Museum (Biologia Coll.), No. 698, Irazu, Costa Rica; on *Gynandropus Mexicanus* Putz., British Museum (Biologia Coll.), No. 682, Cordova, Mexico. Usually on legs.

This species, which in general appearance suggests a young shoot of larch or spruce, owing to its densely crowded appressed and undifferentiated appendages, is distinguished by its broad stout perithecium, which is usually almost completely concealed by the somewhat longer appendages which arise about its base, and by the enormous numbers of the latter which also render the main axis quite indistinguishable. The only species with which it might be confused is *R. Javanus* in which, however, the appendages are much less numerous. The individuals on *Gynandropus* (fig. 3) have been taken as the type, although they do not appear to differ essentially from those on *Colpodes*. In fig. 9, Plate XLIV, the perithecium has become visible owing to pressure of the cover glass.

#### CLEMATOMYCES Thaxter.

Proc. Am. Acad. Arts and Sci., Vol. XXXV, p. 439. April, 1900.

Receptacle consisting of a basal and a subbasal cell from which arises distally a main axis bearing a terminal perithecium and formed from a double row of cells; the cells of the external row producing sterile appendages, those of the inner producing secondary axes similar in structure to the primary one, or antheridial branches; the secondary axes producing antheridial or sterile branches on both sides, and like the primary ones bearing a single terminal perithecium. The antheridia simple, borne singly, or usually in whorls, from the distal end of the successive cells of the antheridial branchlet, which consists of several superposed cells.

The structure of the receptacle in this genus, although it suggests that of *Distichomyces*, is unlike that of any other type, consisting as it does of two axes or cell-rows; an anterior (inner) bearing mostly fertile branches, and a posterior bearing sterile appendages. The antheridial appendages which occur both in the main anterior axis, and on its secondary branches, when the latter are well developed as in fig. 2, recall the appendages of *Arthrorhynchus* but they vary considerably both as regards the number of cells which compose them and of antheridia which they bear. The wall-cells of the perithecia are more numerous than usual, there being apparently seven in each row, although the lower apparent wall-cells may prove to be upgrowths of the basal cells which function as wall-cells. The affinities of the genus are doubtful and although the appendages are so similar to those of *Arthrorhynchus* the type may prove to be more nearly related to *Moschomyces* and *Compsomyces*.

CLEMATOMYCES PINOPHILI Thaxter. Plate XLIII, figs. 1-2.

Proc. Am. Acad. Arts and Sci., Vol. XXXV, p. 440. April, 1900.

Nearly hyaline or yellowish, the basal and subbasal cells small, the cells of the main axis in six to twelve pairs more or less alternate on either side, each cell of the outer series giving rise to a three- or four-celled usually simple generally appressed sterile appendage, the terminal cell of which is often smoky brown, its basal cell almost wholly united to the cell of the axis next above; the secondary axes one to three in number, usually with a single basal cell, the external branches more often simple and sterile, the inner fertile; the antheridial appendages of both primary and secondary axes more often simple, sometimes sparingly branched, those near the perithecia bearing the greatest number of antheridia which may



arise singly or opposite in pairs, or in whorls of three or four from the distal (one to four) cells of the appendage. Perithecium solitary, sessile at the tips of the primary and secondary axes, often straight and symmetrical tapering to the truncate unmodified apex, pale becoming amber-brown. Spores about  $38 \times 3 \mu$ . Perithecia  $100-150 \times 25-40 \mu$ . Sterile appendages, longer  $100 \times 7 \mu$ . Greatest length to tip of perithecium (main axis)  $300-400 \times 35 \mu$ .

On inferior surface of thorax of *Pinophilus* sp. indet., British Museum, No. 390, Burmah, India.

In the individual figured, the basal and subbasal cells are abnormally placed or the latter is abnormally septate. In the other specimens these two cells are directly superposed. The species shows a good deal of variation in the number of cells composing both the main and secondary axes, and also in the number and position of the latter.

#### COMPSOMYCES Thaxter.

This genus and *Moschomyces*, which may prove to be not generically separable from it, are decidedly isolated, and it is difficult even to suggest the probable affinities of the few species thus far discovered. It seems to me that it is better to regard the perithecia as arising from a single stalk-cell which is in turn borne on an appendiculate branch from the receptacle consisting of a single cell. The sterile appendages, or certain of them, are peculiar in having slightly oblique septa when young, and it is only in this group that asci with eight spores are definitely known to occur.

COMPSOMYCES LESTEVI Thaxter. Plate XLIII, figs. 9-12.

Proc. Am. Acad. Arts and Sci., Vol. XXXV, p. 439. April, 1900.

Receptacle consisting of a small basal and subbasal cell, the latter giving rise to rarely more than two branches; one of which consists of a basal cell, from the upper side of which the stalk-cell of the perithecium arises; while externally it gives rise to a characteristic sterile branch, simple, usually slightly upcurved, rather closely and somewhat obliquely septate, commonly consisting of about nine superposed cells, tapering rather abruptly at the tip. Perithecium borne on a well developed erect stalk-cell, nearly symmetrical, tapering from about the middle to the broad truncate undifferentiated tip; the basal cells small, but slightly distinguished from the inflated base of the ascigerous portion, the spores few and relatively large. The other branch arising from the subbasal cell of the receptacle, an antheridial branch, divergent, consisting typically of four superposed cells above which it becomes furcate, dividing into two branches which are large stout tapering, distally curved; the third cell of the appendage producing a single short flask-shaped antheridium distally on its inner side and sometimes giving rise to a branch similar to those above. Spores  $42 \times 4 \mu$ . Perithecia  $75-85 \times 30-35 \mu$ , the stalk  $75 \times 22 \mu$ . Antheridial appendage including branches  $275 \mu$ , the basal part about  $60 \times 20 \mu$ .

On abdomen and elytra of *Lesteva sicula* Erich, British Museum, Nos. 452 and 453, Paisley and Red Hill, England: on *L. pubescens* Mannerh., No. 1094, Scotland: on *Lesteva* sp. No. 1175. Savoy, in Sharp Coll.

This species differs from the type of the genus in having a single antheridium definitely placed on a main appendage; at least this appears to be the condition in all the specimens examined which have been in sufficiently good condition to show the antheridium at all. At first sight it might seem wholly different from *C. verticillatus* from the apparent absence of a basal appendiculate cell below the stalk-cell of its perithecium; but an examination of young specimens shows, as in fig. 12, that this appendiculate cell is present, although very small, and as the individual matures the enlargement of the stalk-cell, as well as of the basal cells of the other appendages, causes it to become obscured and displaced, so that the stalk-cell itself appears to arise directly from the subbasal cell of the receptacle. That this is not the case is clearly seen in the figure mentioned, which also shows the position of the single antheridium. The material from Dr. Sharpe's collection is in somewhat better condition than the types, but does not vary greatly. The specimens from Scotland have more slender perithecia, but do not seem otherwise different.



## MOSCHOMYCES Thaxter.

*M. insignis*, the only known species of this genus, appears to be a rare form; but this is perhaps owing to the fact that I have been unable to obtain its host in any considerable numbers. It has been collected in one instance on *Sunius longiusculus* at Kittery Point, Me., on one of many specimens of the host examined. As I have previously pointed out, it may prove only a very curious development of *Compsomyces*, to which it is at least very closely allied. As in the case of the genus last mentioned, it has seemed best to regard the basal stalk-cells of the perithecia as branches from the receptacle, from which the perithecia originate as well as the peculiar sterile branches which subtend it, rather than as parts of a compound perithecial stalk-cell.

## CHLETOMYCES PINOPHILI Thaxter.

Three specimens agreeing in all respects with the types of this species were found in the Biologia Collection at the British Museum on an undetermined species of *Pinophilus*, No. 765, from Chontales, Nicaragua. The species still remains the unique type of a genus not closely approached by any other thus far described. It is clearly distinguished by its simple axis of superposed cells one or more of which immediately below that which bears the perithecium, give rise to branchlets. No other form has perithecia and branches similarly associated on a simple axis of this nature, which appears to be entirely primary, and not in any part a secondary development from a primary receptacle such as is seen in *Rhachomyces*.

## ECTEINOMYCES Thaxter.

Proc. Am. Acad. Arts and Sci., Vol. XXXVIII, p. 26. June, 1902.

Receptacle consisting of a single series of superposed cells, becoming variable in number as a result of intercalary division; bearing distally a single perithecium and an antheridial appendage. The appendage consisting of a series of superposed cells, several of which, above its basal or stalk-cell, bear simple antheridia, which are cut off distally on one or both sides, by oblique septa.

This genus, although it lacks any very striking characteristic, is one of the rare instances in the family in which the primary receptacle becomes multicellular through intercalary divisions of its cells. The appendage in young specimens consists of several superposed cells, the lower of which cut off simple antheridia distally by an oblique septum, while later they develop a variable number of filamentous branches. The genus appears to bear some resemblance to *Compsomyces* in the character of its perithecium and antheridia, and also to *Hydrophilomyces* and *Misgomyces* in the presence of intercalary growth, and in the general relations of its parts.

## ECTEINOMYCES TRICHOPTEROPHILUS Thaxter. Plate II, figs. 15-18.

Proc. Am. Acad. Arts and Sci., Vol. XXXVIII, p. 26. June, 1902.

Wholly hyaline with the exception of the typically blackened foot. Receptacle varying from a very long and slender to a comparatively short and stout form, the number of superposed cells varying in number from five to fifteen, or rarely more; the cells often hardly larger distally; the series as a whole often irregular, the successive cells irregularly unequal in length. Appendage similar to the receptacle, consisting of five or six superposed cells; the basal cell united to the stalk-cell of the perithecium; the subbasal cell sterile; two or three of the cells above it bearing one to two antheridia each, which may be replaced by sterile branches similar to those which always arise from the terminal cells of the series, both laterally and terminally. Stalk-cell of the perithecium short, not distinguished from the basal cells; the body of the perithecium oblong or oval, tapering abruptly distally to form the slender well-distinguished tip, which tapers slightly to the blunt unmodified apex. Spores  $25 \times 3 \mu$ . Perithecia  $55-65 \times 22-28 \mu$ . Appendage including branches  $75-100 \mu$ . Receptacle  $25-140 \times 7-12 \mu$ . Total length to tip of perithecium  $100-220 \mu$ .



On the elytra of *Trichopteryx Haldemani* Lec., Intervale, N. H. On species of *Trichopteryx*, near Fresh Pond, Cambridge, and at Kittery Point, Maine.

This species seems to be commonly distributed on various species of its curious and microscopic host, which is the smallest insect thus far known to be infested by Laboulbeniales. It varies very considerably in the amount of secondary growth of its receptacle, the extremes in this respect being illustrated by figs. 15-17. The host is often very abundant in piles of moist vegetable refuse.

#### MISGOMYCES Thaxter.

Proc. Am. Acad. Arts and Sci., Vol. XXXV, p. 443. April, 1900.

Receptacle indeterminate, consisting of numerous cells superposed singly, or in tiers of two or three cells each, ending distally in an appendiculate portion not clearly distinguished from the receptacle, and a solitary perithecium, the two related to one another somewhat as the corresponding structures are related in *Laboulbenia*. (Antheridia simple and borne free on the short appendages?).

In the absence of any exact knowledge as to the antheridia, it is not possible to define this type very precisely, although its general characters are such as to distinguish it very clearly from other genera unless perhaps from *Ecteinomyces*, which also possesses an indeterminate multicellular receptacle. The antheridia seem to be evanescent, and in even the youngest specimens, in which the perithecium is quite undeveloped, what appear to be the remains of them, only, have been seen. The appendages are not well developed and are irregular in their origin; the primary "appendage" from which they arise recalling that of *Ceratomyces*, although less definitely differentiated and varying considerably. It seems safe to assume from an examination of the material available that the antheridia are simple and free, but it is to be hoped that European observers may obtain fresh material of the young conditions of *M. Dyschirii*, which appears to be common on various species of *Dyschirius*, in order definitely to determine this point. Until the antheridia are known, it is difficult to judge of the nearest relationships of the genus, but the character of its receptacle would appear to ally it to *Ecteinomyces*, although the primary appendage is clearly distinguished in this genus and the perithecium is different in character.

#### MISGOMYCES DYSCHIRII Thaxter. Plate LXX, figs. 9-10.

Proc. Am. Acad. Arts and Sci., Vol. XXXV, p. 443. April, 1900.

Rather rich amber-brown, the receptacle consisting of from eight to twenty-three superposed cells, the upper ones rarely divided longitudinally, the distal cell lying between several, usually three, smaller cells which become separated from it on either side, and which, together with its base, are united to the base of the perithecium; while above it, and separated from it by a thin dark insertion, a cellular base gives rise to the group of appendages, the irregular basal cells of which alone remain in the material examined. Perithecium nearly oval or very slightly pointed, the tip and lips undifferentiated. Spores, seen only in perithecium, with base apparently abruptly recurved or bent, about  $60 \times 3.8 \mu$ . Perithecia  $70-85 \times 35-40 \mu$ . Receptacle  $135-400 \mu$ . Total length to tip of perithecium  $200-435 \mu$ .

On *Dyschirius globosus* Herbst., Hope Coll., No. 349, England; on *D. salinus* Schaum., British Museum, No. 582, Europe. On *D. politus* Dej., *D. externus* Sch., *D. digitatus* Dej., *D. nigricollis* F., *D. læviusculus* Putz., Europe, Berlin Museum Nos. 894, 895, 896, 897.

This species is very clearly distinguished from the next by its amber-brown color, more simple receptacle and differently shaped perithecium. It does not appear to be rare on species of *Dyschirius* in England and on the continent, but has always been found with the appendages badly broken, so that no antheridia are visible, and even the appendages themselves can with difficulty be made out. The host is a minute carabid allied to *Clivina*.



## MISGOMYCES STOMONAXI Thaxter. Plate LXX, figs. 7-8.

Proc. Am. Acad. Arts and Sci., Vol. XXXV, p. 443. April, 1900.

Hyaline or pale straw colored. Receptacle consisting of a basal and one or two more single superposed cells, the cells above these becoming rather irregularly divided longitudinally to form a double row of variable length, above which a second longitudinal division appears, the receptacle in this region being made up of three-celled tiers as far as the base of the perithecium, above which its distal part consists of several superposed pairs of cells, or of two rows of cells more irregularly distributed, the insertion of the appendages rather indefinite, the cells composing it producing irregular hyaline or brownish branches distally. Perithecium externally nearly straight, the inner margin convex, the tip rather abruptly differentiated, straight or curved outward. Perithecia  $90-100 \times 25-30 \mu$ . Receptacle  $300-335 \mu$ . Total length to tip of perithecium  $365-400 \times 40-45 \mu$ .

On *Stomonaxus striaticollis* Dej., British Museum No. 593, China. On elytra.

This species is based on three specimens, two of which are illustrated in the accompanying plate. It differs from *M. Dyschirii* chiefly in the form of its perithecium, and in the fact that its receptacle consists not of superposed cells but of tiers of cells. It is possible that I am in error in associating these forms under one genus; but until sufficient material can be examined, there seems to be no better disposition possible. A fourth specimen apparently identical with the others was found in the Paris Museum, No. 17, on a small harpaloid (?) carabid from Madagascar.

## CERATOMYCKETINEÆ.

Antheridia more or less undifferentiated cells of the appendages or of their branches. The species for the most part aquatic.

## HYDROPHILOMYCES nov. gen.

*Ceratomyces* Thaxter pro parte.

Receptacle consisting of an indeterminate series of superposed cells indefinitely multiplied by intercalary division and with occasional longitudinal septa. Axis of the appendage similar to that of the receptacle and continuous with it, giving rise to a double row of branches arising from small cells separated distally and obliquely from its successive members; many of these small cells nearer the base apparently converted directly to pointed antheridial cells. Perithecia consisting of a small and determinate number of cells.

There appear to be not more than five cells in each lateral and in the inner row of wall-cells, and perhaps but four in the outer, while the perithecium is developed in relation to the trichogyne like other members of the family, and not in the fashion peculiar to *Ceratomyces* and its near allies which was described in my Monograph. It is possible that I am mistaken in regarding the beaked cells of the appendage (Plate LXVIII, figs. 3-4) as antheridia, since I have seen no actual discharge of sperm-cells; on the assumption that they are, the genus may, however, be provisionally placed not far from *Ecteinomyces*. At least two more undescribed species on Hydrophilidæ have similar characters.

For a further comparison of this type with the assemblage of species formerly placed by me in *Ceratomyces* reference should be made to the last mentioned genus under which these matters are discussed.

**Hydrophilomyces rhynchophorus** nov. comb. Plate LXVIII, figs. 1-4.

*Ceratomyces rhynchophorus* Thaxter. Proc. Am. Acad. Arts and Sci., Vol. XXXV, p. 446. April, 1900.

Hyaline. Receptacle long slender, but slightly narrower below, consisting of about forty (thirty-five to fifty) superposed cells, wider than long; those in the lower half more flattened, the foot small. Perithecium lateral, nearly erect, slightly divergent; a short but definite stalk-cell; the basal wall-cells greatly elongated, extending some distance up around the ascus-mass and forming, together with the large elongated inferior supporting cell, a broad sterile base to the perithecium which is not differentiated from its



main body; the cell rows consisting of but five cells, including the very small lip-cells, and the cells of the sterile base; the three upper tiers of cells forming an abruptly differentiated, thick walled, long, tapering beak-like termination, curved outward or inward, often at right angles; below which the distal end of the outer wall-cell forms a slight rounded prominence, the very small lip-cells forming a slight enlargement. Appendage similar to and continuing the axis of the receptacle directly, or diverging very slightly; the cells giving rise to a double series of branches, which are subtended by small cells obliquely separated at the distal angles, those from the lower cells short (antheridial ?), those from the upper long and several times branched; the main appendage usually broken, but in young individuals consisting of from twenty to twenty-five superposed cells. Spores  $48 \times 3 \mu$ . Perithecia, ascigerous portion  $175 \times 45-50 \mu$ , beak-like termination  $140-160 \mu$ , sterile basal portion about  $100 \mu$ . Receptacle  $270-430 \times 30-35 \mu$ . Appendage (young individuals)  $350 \mu$ , the branchlets  $200 \times 6 \mu$ .

On legs and inferior surface of *Phænonotum estriatum* Say. Eustis, Florida, October.

Although but a small percentage of individuals of this host were found to be infested, abundant material was obtained, the beetles occurring in large numbers on the under side of pieces of board floating along the margin of Lake Eustis. In two individuals the parasite was attached to the inner surface of the elytron near its tip, all the individuals being remarkable for the monstrous development of the perithecium which reached a maximum length of one millimeter. It is possible that the following species may also be a similar variation due to its position of growth. Although the branches of the appendage are originally opposite in two rows, the latter become as a rule approximated on the inner side, as a result of greater external growth in the cells of the main axis.

**Hydrophilomyces reflexus** nov. comb. Plate LXIX, fig. 3.

*Ceratomyces reflexus* Thaxter. Proc. Am. Acad. Arts and Sci., Vol. XXXV, p. 447. April, 1900.

Hyaline with a few purplish or reddish suffusions on the receptacle, which is composed of from about twenty-five to fifty superposed cells with occasional longitudinal septa; the foot hyaline, or slightly yellowish, much enlarged, bladder-like or spherical; the distal portion distinctly broader, its axis coincident with that of the erect appendage which forms a direct continuation of it. Perithecium small with few asci, abruptly recurved at the base, its apex thus sometimes touching the inflated foot; nearly straight, tapering almost symmetrically to the blunt slender tip; the ascigerous cells situated at the base just above the small angular stalk-cell. Appendage usually flat and broader than the receptacle toward its base, the superposed flat cells of which it is composed producing appendages on either side much as in *C. rhynchophorus*. Spores  $70 \times 4 \mu$ . Perithecia  $140 \times 20 \mu$ . Receptacle  $140-280 \mu$ . Appendage  $200-400 \mu$ . Foot about  $30 \times 30-38 \mu$ .

On *Phænonotum estriatum* Say. Eustis, Florida, October.

Specimens of this species were found on several individuals, but never fully matured, growing on the soft integument of the upper surface of the abdomen just beneath the elytra, from under which they may be seen projecting. The branches of the primary appendage remain opposite and the basal cell of the receptacle assumes a bulbous form. The cells of the receptacle, in fresh material, were characterized by reddish suffusions suggesting phycoerythrin. The great elongation of some of the specimens is noteworthy, the receptacles comprising from forty to fifty superposed cells. As previously mentioned this species may prove to be nearly an abnormal form of *II. rhynchophorus*.

**RHYNCHOPHROMYCES** nov. gen.

*Ceratomyces* Thaxter *pro parte*.

Receptacle indeterminate, consisting of a considerable and variable number of superposed cells terminated directly by the perithecium. Perithecium consisting of a well defined venter and clearly distinguished neck in which the wall-cells are very numerous and indeterminate. The base of the appendage indistinguishable from the venter of the perithecium, from the walls of which it appears to arise at maturity, together with its basal branches. Antherozoids extruded and abjoined distally and laterally, and for the most part singly, from cells composing the branchlets of the appendage.



The type of this genus, *R. rostratus*, was formerly included in *Ceratomyces* but, as I have pointed out below under the last mentioned genus, there can be no question as to the advisability of separating the three well marked species here enumerated in a group by themselves. As the venter of the perithecium develops, the whole base of the appendage becomes incorporated with it, as well as the basal cells of its lower branches, which actually, in the end, form a portion of the perithecial wall, and seem to arise, as is shown in Plate LXVIII, fig. 5, from wall-cells above the base of the main appendage. The neck, or trunk-like prolongation of the perithecium is most characteristic, and at maturity becomes abruptly reflexed in all the species, while in the two described below, it is further peculiar in possessing tooth-like outgrowths below the curvature. The known species all inhabit water beetles belonging to the Hydrophilidæ, and have been found in North America and Oceanica.

**Rhynchophoromyces elephantinus** nov. comb. Plate LXVIII, fig. 5.

*Ceratomyces elephantinus* Thaxter. Proc. Am. Acad. Arts and Sci., Vol. XXXV, p. 446. Apr., 1900.

Faintly tinged with pale amber-brown; the neck stout, its upper three fifths (more or less) abruptly recurved: certain corresponding cells of two opposite rows just below this curvature producing broad rather short, blunt, tooth-like outgrowths, one to two or three to four, usually, in each group, or sometimes solitary from one group only; the tip snout-like, broad, slightly and irregularly sulcate. Receptacle consisting of from seventeen to twenty-two squarish or flattened cells, sometimes hardly broader distally. Appendage producing numerous long slender flexuous branches repeatedly branched. Perithecia, ascigerous part, about  $140 \times 65 \mu$ , the neck to recurved part  $475-525 \mu$ ; recurved part  $390-400 \mu$ . Spores  $70 \times 3.5 \mu$ . Receptacle  $370-550 \mu$ . Longest branch of appendage  $600 \mu$ .

On legs of *Hydrobius* (?) sp., Eustis, Florida.

This very striking species is closely allied to *R. denticulatus*, but differs in general form and size, and especially in the number and character of the tooth like perithecial appendages or outgrowths. The accompanying figure shows the posterior view of an individual, the cells in the median line above the receptacle corresponding to the base of the appendage, and the upper cells cut off from this row corresponding to the main basal branches of the appendage. The host, a rather large hydrophilid, possibly *Hydrobius* sp., was found swimming in rain pools in the pine woods near Lake Eustis.

**Rhynchophoromyces denticulatus** nov. comb. Plate LXX, fig. 1.

*Ceratomyces denticulatus* Thaxter. Proc. Am. Acad. Arts and Sci., Vol. XXXV, p. 445. April, 1900.

Amber-brown, the ascigerous portion of the perithecium slightly inflated and rather abruptly distinguished from the elongate neck, which at maturity is straight or slightly sinuous; the cell rows containing about fifty-five cells, the neck more slender toward the base, distally somewhat broader; successive cells in two adjacent rows in this broader portion projecting to form well marked rather slender tooth-like blunt outgrowths, directed obliquely upward and separated by a basal septum, one series usually consisting of five cells, sometimes six, the cells immediately below often bulging prominently or forming shorter tooth-like outgrowths; the second series consisting of usually not more than three well defined similar tooth-like outgrowths: above these two series the upper fifth (about) of the neck is bent abruptly backward, lying nearly parallel to the portion below it; the tip broad snout-like, the lip-cells forming a small papillate prominence above and external to a broad rather distinctly differentiated cell, which terminates one of the inner rows, and is almost as large as the lip-cells taken together. Receptacle slender, tapering toward the base, consisting of (about) ten superposed cells, exclusive of the foot-cell, which is not always wholly blackened. Appendage as in *C. rostratus*, the numerous branches and branchlets rather slender, not very long, forming a rather compact tuft more or less appressed around the base of the perithecium. Perithecium, ascigerous portion about  $85 \times 35-40 \mu$ , neck to recurved portion  $475-500 \times 20-25 \mu$ , recurved portion about  $125 \mu$ , tooth-like projections  $15-35 \times 6-7 \mu$ . Receptacle (ten superposed cells)  $130-150 \mu$ . Appendages (longest branches)  $175 \times 3 \mu$ .

On under surface, of a small hydrophilid beetle, Paris Mus., No. 11, Isles Mariannes, Oceanica.



Sufficient material of this species was obtained from alcoholic specimens of its host, and is in very good condition. The cells of the receptacle often appear to be longitudinally divided as in fig. 1; but the smaller apparent cell is merely a space between the general envelope and the cell-wall proper. The species is most nearly related to *R. elephantinus*, from which it is distinguished by its smaller size, more slender habit, shorter appendages, amber-brown color, and by the more numerous and differently formed tooth-like outgrowths from the perithecial neck.

**AUTOICOMYCES** nov. gen.

*Ceratomyces* Thaxter *pro parte*.

Receptacle consisting of three superposed cells, the lowest often involved by the blackened foot, the upper surmounted by a pair of cells giving rise to the single perithecium and the antheridial appendage respectively. Antheridial appendage consisting of a series of superposed cells producing ramigerous branches irregularly along its inner margin. Perithecium usually appendiculate, determinate, the wall-cells in rows of seven and eight members.

This genus which I have already pointed out, is very nearly related to *Ceratomyces* emend., differs in the constant and comparatively small number of cells forming the rows of wall-cells in the perithecium; the inner and outer rows having eight and the lateral rows seven in all species examined. All the known forms inhabit species of a single genus, *Berosus*, a fact which has suggested the generic name, and of the six that have been described, one occurs in the East Indies, while the rest are American. In addition to the three forms illustrated herewith, three others, *Autoicomycetes furcatus*, *A. distortus* and *A. humilis* were formerly included in *Ceratomyces* and it may be mentioned that a seventh species is known to occur on *Berosus* in South America. All the species have a certain family resemblance and are for the most part pale, or quite hyaline. *A. humilis*, of which good material has been again obtained from the type locality, is the only form which lacks a perithecial appendage, the conformation of its tip being rather exceptional, the edges spreading somewhat and pointed, not compressed as in the other species. *A. contortus* has also been found on the same host in the vicinity of Fresh Pond, Cambridge, but the other New England species have only been met with in the small pond, formerly referred to, on the highest point of Cutt's Island, at Kittery Point, Maine.

**Autoicomycetes acuminatus** nov. comb. Plate LXVIII, fig. 8.

*Ceratomyces acuminatus* Thaxter. Proc. Am. Acad. Arts and Sci., Vol. XXXV, p. 447. April, 1900.

Hyaline. Receptacle consisting of three superposed cells, the basal cell partly suffused and continuous with the blackened foot. Perithecium rather stout, the outer margin nearly straight, the inner strongly convex; the seventh wall-cell of the inner row greatly enlarged, its outer wall very thick, forming an erect tapering bluntly pointed terminal appendage, at the base of which the papillate apex of the lip-cells projects on the right side; the fifth cell of the external row of wall-cells growing out to form a sub-terminal slender appendage, eight-celled in the type, distally attenuated, its terminal cell bearing one or two slender branches. Appendages consisting of from four to five superposed cells, the distal ones appendiculate (the branches mostly broken). Perithecium  $185 \times 40 \mu$ . The appendage without branches  $82 \mu$ , the branches  $150 \mu$ ; the rostrate terminal cell  $50 \times 17 \mu$  (at base). Receptacle  $85 \times 48 \mu$ . Spores about  $70 \times 3.5 \mu$ . Appendage, broken, without branches  $70 \mu$ .

On the inferior surface of abdomen and thorax of *Berosus* sp. indet. Eustis, Florida, October.

A few specimens of this well marked form were found in Lake Eustis on a *Berosus* very like *B. striatus*. The conformation of its tip and the character of its perithecial appendage distinguish it from other species of this genus.



**Autoicomycetes ornithocephalus** nov. comb. Plate LXIX, figs. 7-8.

*Ceratomyces ornithocephalus* Thaxter. Proc. Am. Acad. Arts and Sci., Vol. XXXV, p. 448. April, 1900.

Hyaline or becoming more or less suffused with amber-brownish. Perithecium relatively rather small, the external margin somewhat concave, the inner convex, the four distal cells of the eight external wall-cells rather abruptly enlarged, their external walls much thickened and forming an irregularly rounded crest-like prominence, the distal half of the margin of which becomes abruptly almost horizontal, terminating near the base of the beak-like pointed apex, which projects somewhat obliquely from the right side: the external row of wall-cells producing above the fourth cell a large appendage, geniculate at its base, tapering distally where it curves outward, consisting of from ten to twenty cells, the terminal cell rarely bearing one or more slender branches. Receptacle consisting of three superposed cells, the basal one usually opaque, except distally, and continuous with the foot, surmounted by two cells from which arise the perithecium and the appendage. The appendage (usually broken) curved outward and upward, consisting of about ten superposed cells, the upper ones giving rise to few branches on the inner side, which may be several times branched, the branchlets slender, mostly erect and rather rigid. Spores about  $70 \times 30 \mu$ . Perithecia  $120-160 \times 35-45 \mu$ , the crest-like tip  $38-45 \mu$  broad, the appendage  $120-325 \mu$ . Receptacle  $85-120 \mu$ . Appendage, exclusive of branches  $140-150 \mu$ . Total length to tip of perithecium  $210-290 \mu$ .

On margin of right elytron toward the apex, of *Berosus striatus* Say. Kittery Point, Maine.

Occurring rather rarely and always in the same position in company with *T. furcatus*, *T. distortus*, and *T. humilis*, all of which inhabit *Berosus* in a small pond at the summit of Cutts Island. It is easily separated from the other species by the conformation of the tip, which suggests a beak, subtended by a crest or rounded cockscomb.

**Autoicomycetes falciferus** nov. comb. Plate LXXI, fig. 19.

*Ceratomyces falciferus* Thaxter. Proc. Am. Acad. Arts and Sci., Vol. XLI, p. 318. July, 1905.

Allied to *A. furcatus*, hyaline, the inner margin of the perithecium and the base of the appendage suffused with amber-brown, becoming blackish and opaque below the appendage. External margin of the perithecium nearly straight, the inner strongly convex; the pointed tip curved to the base of the large, long, sickle-shaped, external, subterminal perithecial appendage, which consists of about twenty-five to thirty superposed cells, and is curved outward. Receptacle consisting of three superposed cells, surmounted by two cells from which the perithecium and antheridial appendage arise; the latter consisting of six or more cells, bearing branches like those of the other allied species on *Berosus*. Spores  $55 \times 4 \mu$ . Perithecium  $125-150 \times 55-65 \mu$ , its appendage  $435-470 \times 22 \mu$ . Receptacle  $90-110 \times 35 \mu$ . Appendage, without branches,  $110-125 \mu$ . Total length to tip of perithecium  $250 \mu$ .

On left inferior margin of abdomen of *Berosus* sp., Java; Rouyer, No. 1393.

A species most nearly related to *A. furcatus*, but differing in its small antheridial appendage and very large falcate perithecial appendage, as well as in other points.

## CERATOMYCES Thaxter.

A revision of the numerous forms which I have published under this name, and the examination of still further material, has led me to the conclusion that at least four distinct types are best separated generically in this assemblage. The largest of these to which the original name *Ceratomyces* may be applied, includes fifteen described species among which *C. mirabilis* may be taken as the type. All of these are parasitic on the aquatic genus *Tropisternus*, with the single exception of *C. terrestris*, which most certainly should be placed in a genus by itself, its antheridial branchlet (Monograph, Plate XXV, fig. 23) and its general characters being not closely comparable to those of any described genus. Until it can be reexamined in a fresh condition, or until other nearly allied forms are discovered, it seems best, however, to avoid a new generic name by retaining it provisionally in the present connection.



A second group of forms which, from the fact that they are all parasitic on species of a single aquatic genus, *Berosus*, may be appropriately called *Autoicomycetes*, is represented by the six described forms above enumerated, and a seventh as yet unpublished. The members of this section differ from *Ceratomyces* in having a small and determinate number (seven and eight) of wall-cells in the perithecia.

The third group, of which the form previously described as *C. rostratus* may be taken as the type, I have called *Rhynchophoromyces* from the monstrously developed necks which characterize the perithecia of the species. The receptacle in this genus is many-celled and indeterminate, the perithecium distinguished into neck and venter, and later confluent with the base of the appendage, and at maturity its axis is coincident with that of the receptacle.

Lastly the two species formerly described as *C. rhynchophorus* and *C. reflexus*, together with two or three others as yet unpublished, appears to differ very widely from all the other types, possessing a straight erect axis of many superposed cells indeterminate in number, from which the perithecium, the wall-cells of which are few in number and determinate, arises laterally. This type is further distinguished by the production of what at least appear to be definitely differentiated antheridial cells, which are produced much as in *Ecteinomyces* with which it has been provisionally associated above. To this genus from its aquatic habit and parasitism on the Hydrophilidæ I have given the name *Hydrophilomyces*.

Of these groups *Autoicomycetes* corresponds in all respects to *Ceratomyces*, except in its determinate perithecium, and is perhaps too closely allied to this genus. There can hardly be a difference of opinion, however, as to the desirability of separating the others.

Emended as above indicated, the genus *Ceratomyces* may be characterized as follows:

Receptacle consisting of three superposed cells above the foot, surmounted by a pair of cells which form the bases of the perithecium and of the appendage respectively. Cells of the perithecial wall-rows indeterminate, both in different species and individuals: perithecium usually appendiculate below the tip. Primary appendage consisting of a variably developed series of superposed cells, the lower members of which may become longitudinally divided, and some or all of which may bear secondary branched appendages arising from cells separated from their upper inner angles.

This is a typically American genus, all the species of which, with the exception of the doubtful *C. terrestris* found on *Lathrobium*, occur on species of the single hydrophilid genus *Tropisternus* and the allied *Pleurohomus* in North and South America. The species vary very greatly in the number of members which compose the rows of wall-cells in the perithecia, the extremes in this respect being well illustrated by *C. procerus*, in which there may be over sixty, and *C. minisculus* in which there are hardly more than a dozen. This variability is not only striking as between species, but the number in different individuals of a given species is by no means constant and may be very variable. All the species with the exception of the anomalous *C. terrestris* to which reference has been made above, and *C. filiformis*, are characterized by the possession of a subterminal perithecial appendage variably developed.

#### CERATOMYCES FILIFORMIS Thaxter.

This species which usually occurs among the bristles along the margins of the elytra of its host near the tip, is also found not infrequently between the terminal claws of the posterior leg. Material has been examined from Eustis, Florida and specimens have been obtained from Mexican *Tropisterni* in the Paris Museum, No. 50; and on *Pleurohomus obscurus* Sharp from Dueña, Guatemala; Sharp Collection, No. 1185. It is somewhat anomalous and less well marked than any of the other species, seldom shows the presence of branches on its appendage, produces very few spores and varies greatly in the length of its perithecium and in the numbers of cells which compose it.

CERATOMYCES PROCERUS Thaxter. Plate LXIX, fig. 6.

Proc. Am. Acad. Arts and Sci., Vol. XXXVII, p. 43. June, 1901.

Rather pale amber-brown. Perithecium very elongate, of nearly equal diameter throughout, the wall-cells in each row more than sixty in number; the conformation at the tip similar to that in *C. con-*



*fusus*; the perithecial appendage erect, short and stout, consisting of about ten cells, distally curved outward, tapering from its broad base to the bluntly pointed tip. Appendages (broken) and receptacle, much as in *C. confusus*. Perithecium  $800-850 \times 65 \mu$ , its appendage  $125 \mu$ . Total length to tip of perithecium more than one millimeter.

On the inferior surface of the abdomen (near the middle) of *Tropisternus* sp. San Fidelio, Brazil. Museum of Comparative Zoölogy, Cambridge, No. 1338.

This species is remarkable for its great length and large size, the number of cells in each cell-row of the perithecium being greater than in any other species. In general habit it resembles *C. filiformis* but differs in possessing a perithecial appendage.

CERATOMYCES CURVATUS Thaxter. Plate LXIX, fig. 1.

Proc. Am. Acad. Arts and Sci., Vol. XXXVII, p. 43. June, 1901.

Amber-brown. Perithecium relatively large, inflated toward the base; the distal half up to the perithecial appendage of about equal diameter throughout; about forty cells, more or less, in each row of wall-cells; the configuration at the tip very similar to that in *C. confusus*, the tip itself more prominent, the apex more pointed; the perithecial appendage about nine-celled, the distal half pale, curved or recurved, broader below, shorter and stouter. Receptacle much as in *C. confusus*, the basal cell black, the further suffusion somewhat less extensive. Appendage consisting of about six or seven cells, tapering distally, rather short. Spores about  $70 \times 4 \mu$ . Perithecia  $500-615 \times 75 \mu$  (below)  $\times 60 \mu$  (distally), the appendage  $150 \mu$ . Total length to tip of perithecium  $600-700 \mu$ , to tip of antheridial appendage about  $250 \mu$ .

On *Tropisternus Caracinus* N. on inferior surface of abdomen near the tip. Caracas? Berlin Museum, No. 1057.

Although one of the very largest of the genus, this species is not distinguished by any very striking peculiarities. The perithecial appendage is of an unusual form and the perithecium itself is enormous. It appears to be allied to *C. procerus* and *C. confusus*.

CERATOMYCES CLADOPHORUS Thaxter. Plate LXIX, fig. 2.

Proc. Am. Acad. Arts and Sci., Vol. XXXV, p. 444. April, 1900.

Perithecium very large with a slightly sigmoid curvature, the lower half conspicuously inflated above the rather narrow base, the outer margin of the inflated portion strongly convex, the inner slightly concave; the distal half or third more nearly isodiametric, bulging subterminally on the inner side, the margin curving thence abruptly outward to the short broad beak-like tip; the apex sometimes apiculate; about the fortieth cell of the outer row of wall-cells forming the base of a subterminal appendage which is curved upward, geniculate at its base, rather long slender and tapering, amber-brown becoming blackish below; the perithecium at first pale yellowish, the inflated portion becoming rich amber-brown, the distal portion much paler except in the region of the more deeply suffused subterminal elevation on the inner side. The narrowed base nearly hyaline, not differentiated from the receptacle. Receptacle consisting of three superposed cells, short, narrow below, abruptly very broad above; the foot relatively small, the basal cell small, at first hyaline, later becoming tinged with smoky brown; the two distal cells relatively very small and broadly blackened except along the nearly hyaline anterior margin, the opaque area extending obliquely so as to involve the geniculate base of the appendage. Appendage relatively very large and stout, tapering in very young individuals to a slender apex and consisting of from fifteen to twenty superposed cells, many of which may be once longitudinally divided, a subtriangular appendiculate cell being separated from the inner side, or also from the outer distally; the branches numerous, with very long and slender branchlets which may be several times branched. Spores  $95 \times 4 \mu$ . Perithecia  $475-550 \times 90-110$  (inflated portion)  $\times 70 \mu$  (distal portion). Receptacle including foot  $85 \mu$ . Total length to tip of perithecium (longest)  $635 \mu$ . Appendage  $275-475 \times 45 \mu$ , its longest branches  $550 \times 3 \mu$ .

On *Tropisternus nimbatus* Say. Eustis, Florida. On the inferior surface of the thorax on the left side.



This fine and very distinct species has been seen on two specimens, only, of its host, taken in Lake Eustis. It is distinguished by the great size of its perithecium, and especially of its primary appendage, the branches of which are more numerous than those of any other species. Its sigmoid curvature and pale color serve further to distinguish it.

CERATOMYCES BRAZILIENSIS Thaxter. Plate LXX, fig. 2.

Proc. Am. Acad. Arts and Sci., Vol. XXXVII, p. 44. June, 1901.

Dark amber-brown. Perithecium somewhat inflated just above the constricted base, the upper two-thirds broad and of about the same diameter throughout; about forty-five wall-cells in each row, the tip small, short, rather narrow, abruptly hunched externally, the hyaline lips turned abruptly toward the base of the perithecial appendage, which consists of a basal cell hardly differentiated from the wall-cell below it, though somewhat longer, the portion above it erect, slender, stiff, slightly curved outward, tapering but little, the subbasal cell bearing a characteristic basal enlargement which projects toward the lip-cells and lies just above them. The appendage and receptacle much as in *C. mirabilis*. Perithecium  $650 \times 95 \mu$  (basal)  $\times 87 \mu$  (distal). Appendage  $185 \mu$ , or more. Total length to tip of perithecium  $800 \mu$ .

On inferior thorax of *Tropisternus nitens* Cast. var. Rio de Janeiro. Sharp Collection, No. 1181.

This is decidedly the largest species of the genus, with the possible exception of *C. curvatus*, and is readily distinguished by the conformation of its tip, which resembles that of *C. Mexicanus*, and by the blunt projection from the base of the perithecial appendage just opposite the apex of the perithecium.

CERATOMYCES CALIFORNICUS Thaxter. Plate LXVIII, figs. 6-7.

Proc. Am. Acad. Arts and Sci., Vol. XXXV, p. 448. April, 1900.

Amber-brown. Receptacle relatively slender, consisting of three small superposed cells surmounted by two similar cells which form the base of the appendage and perithecium; the foot small, normal. Perithecium short and stout, from two to three times as broad distally as at the base; about twenty cells in each of the inner rows of wall-cells, the inner margin convex, distally abruptly bent inward to the short beak-like apex, so that the inner margin of the tip is thus horizontal, or even oblique, above the apex; about the eighteenth cell of one of the outer rows forming the base of the usually straight rather remotely septate perithecial appendage, which commonly diverges at an angle of forty-five degrees or even at right angles. Appendage small and slender (the extremities broken in the types) becoming lateral in position. Perithecia  $185-200 \times$  (base)  $30-40$ , (distal portion)  $70-85 \mu$ . Receptacle  $50-70 \times 25 \mu$ . Total length to tip of perithecium  $250-300 \mu$ .

On the left anterior inferior angle of the prothorax of *Tropisternus dorsalis* Brullé, California, and in the same position on *T. glaber* Herbst., from Cape Neddock, Maine (Bullard).

The single specimen of this species found by Mr. Bullard does not differ from the Californian material, and the species may prove to be not uncommon in the East, if looked for in the position indicated. It is closely allied to *C. camptosporus*, but differs in its considerably smaller size, in the character and suffusion of its foot and receptacle, in the antheridial appendage which lacks the characteristically enlarged subbasal cell and also in other minor points.

CERATOMYCES CAMPTOSPORUS Thaxter.

Further material of this rare species has been obtained from various localities in New England, and also on *Tropisternus limbalis* Lec., from Washington; *T. striolatus* Lec. from Texas, and *T. lateralis* Fabr. from Eustis, Florida. It is a well marked and constant form, closely allied to *C. Californicus*, but readily distinguished by its foot and appendage, as well as by its greater size.



## CERATOMYCES MEXICANUS Thaxter. Plate LXX, fig. 3.

Proc. Am. Acad. Arts and Sci., Vol. XXXVII, p. 43. June, 1901.

Dark amber-brown. Perithecium with a slight submedian inflation; distally broad, the outer margin turning abruptly inward distally to the inconspicuous retracted tip, which lies close at the base of the perithecial appendage, and is externally subtended by irregular inconspicuous papillate protrusions: the basal cell of the appendage slightly divergent several times as long as broad; the external margin straight, the inner strongly concave with a median blackish suffusion; the rest of the appendage slightly curved, about eight or nine-celled, tapering slightly and diverging strongly above the basal cell. The antheridial appendage and the receptacle much as in *C. mirabilis*. Spores  $85 \times 5 \mu$ . Perithecia  $400-475 \times 110-125 \mu$ , the appendage about  $290 \mu$ , its basal cell  $70 \times 26$  and  $36 \mu$ . Total length to tip of perithecium  $550-640 \mu$ .

On the left inferior margin of the abdomen of *Tropisternus nitidus* Sharp, Sharp Collection, No. 1177, and of *T. chalybeus* Cast., British Museum, No. 772, Oaxaca, Mexico.

The conformation of the tip of the perithecium in this species is not unlike that of *C. Californicus* and *C. Braziliensis*, but it is readily distinguished by its long geniculate appendage, large size and dark color. It is most nearly related to *C. Braziliensis* and to *C. mirabilis*.

## CERATOMYCES MIRABILIS Thaxter.

Additional material of this common and widely distributed species has been examined from the following sources. Paris Museum on *Tropisternus* sp., South America, Nos. 4a and 48; No. 50 from Mexico. Berlin Museum No. 1056 on *T. "umbrinus"*, Para. Dr. Sharp's Collection No. 1180 on *T. nitens* Cost., Cayenne; No. 1182 on *T. ebenus*, Rio de Janeiro; No. 1183 on *T. nigrinus* Sharp, Brazil; No. 1184 on *T. lateralis* Fabr., Brazil; No. 1186 on *T. xanthopus* Sharp, Mexico; No. 1185 on *Pleurohomus obscurus* Sharp, Dueñas, Guatemala. On *Tropisternus* sp. San Fidelio, Brazil and Eustis, Florida. The characters of the species appear to be decidedly constant and it is most readily distinguished by the external hunch which subtends the tip of the perithecium, and is usually bent in against the base of the appendage.

## CERATOMYCES CONFUSUS Thaxter.

This species which is closely allied to *C. mirabilis*, although much rarer, seems to be quite constant in its characters. It usually occurs near the tip of the abdomen on its right inferior margin. It has been found again on several *Tropisterni* in Lake Eustis, Florida.

**Ceratomyces ansatus** nov. sp. Plate LXIX, figs. 4-5.

Perithecium in general resembling that of *C. confusus*, larger, the anterior and posterior rows of wall-cells consisting of about thirty-five cells, the anterior forming a slight ridge below the tip on the left side; the free tip shorter more broadly papillate, the perithecial appendage stouter, conspicuously inflated above its base, erect; the distal portion more or less strongly curved outward and sometimes ending in a few fine hyaline branches; the whole often sickle-shaped, its basal cell more or less opaque strongly concave on its inner side. Receptacle as in *C. confusus*, but the blackened portion extending up beyond the base of the appendage and forming a free finger-like distally rounded projection, the appendage set between this and the base of the perithecium as in a socket. Appendage relatively small and narrow, usually short and terminated by a tuft of slender hyaline branchlets. Total length to tip of perithecium  $425-475 \mu$ . Perithecium to tip  $325-350 \times 75-80 \mu$ , its appendage  $220 \times 36 \mu$ . Receptacle to tip of its projection and including foot  $175-200 \mu$ .

On *Tropisternus* sp., Museum of Comp. Zool., No. 1336 (Type) San Fidelio, Brazil. On *T. striolatus* Lec., Eustis, Florida.

This species which is closely allied to *C. confusus* and *C. Floridanus*, appears to be characteristic of the striped *Tropisterni*, and is found on the inferior surface of the abdomen on the left side. It seems



to differ from its nearest ally, *C. confusus*, in the different conformation of the papillate apex of its perithecium, the tip of which is smaller and less prominent, in the even inflation and dark basal suffusion of the perithecial appendage and in the character of its antheridial appendage; but especially in the finger-like protrusion of its receptacle which, although it varies somewhat in length in different individuals, is very characteristic. The species appears to be rather rare, only a very small number of the very numerous hosts examined from Eustis being parasitized. Fig. 4 represents the Type from Brazil and fig. 5 a specimen from Eustis.

CERATOMYCES FLORIDANUS Thaxter. Plate LXX, fig. 4.

Proc. Am. Acad. Arts and Sci., Vol. XXXV, p. 444. April, 1900.

Purplish brown. Perithecium much as in *C. confusus*, the outer margin nearly straight, the inner somewhat convex, the lateral and posterior rows of wall-cells, about twenty-four in number, rich red-brown with a blackish tinge distally; the anterior wall-cells, about nineteen in number below the perithecial appendage abruptly and evenly paler, yellowish straw-color or faintly brownish; the twentieth cell (about) forming the base of the perithecial appendage which is black, quite opaque, curved outward and upward and geniculate near its base, the inner margin of which is abruptly distinguished (not continuous with the adjacent margin of the tip as in *C. confusus*); the tip distally hyaline, the apex forming a prominent symmetrical well defined rounded hyaline papilla. Receptacle marked by fine longitudinal striations consisting of three superposed cells almost wholly black and opaque except along their anterior margins and the distal margin of the upper cell, which are pale straw-yellow or amber-colored, the series surmounted by two small flattened cells from which arise the perithecium and appendage respectively. Appendage long tapering, consisting of seven or eight superposed cells, clear reddish brown with a blackish tinge, the inner margin as well as the distal portion yellowish or amber-colored. Perithecia  $300-325 \times 60 \mu$ , the appendage  $150 \mu$ . Receptacle  $150-160 \times 75 \mu$ . Appendage about  $175-200 \mu$ .

On the margin of left elytron of *Tropisternus glaber* Hb. (?), Eustis, Florida, October.

Although this species is closely allied to *C. confusus* it may be readily distinguished by its perithecial and antheridial appendages, the latter characteristic in appearance, abruptly distinguished and contrasting-black, the former straight stout, rigid, with much larger basal cells, and deep external suffusions. There is moreover a peculiar semi-olive caste to the deeper suffusions, which is not present in other species. The receptacle, like that of *C. spinigerus*, is marked by fine longitudinal striations, which are only visible in the translucent portion. There may perhaps be some doubt as to the determination of the host which is not certainly *T. glaber*, though very similar to that species.

CERATOMYCES SPINIGERUS Thaxter. Plate LXX, figs. 5-6.

Proc. Am. Acad. Arts and Sci., Vol. XXXVII, p. 42. June, 1901.

Bright amber-brown. Perithecium paler anteriorly, about twenty-eight wall-cells in each row; narrower at the base, the lower half bulging anteriorly, tapering distally where it is rather strongly curved away from the antheridial appendage: the tip hyaline, prominent, obtuse, about half as long as the curved tooth- or spine-like one-celled deep amber-brown appendage, which arises below and beside it. Basal cell of the receptacle large, long, mostly curved, broader distally, opaque; the portion above it relatively small and narrow, concolorous with the perithecium the upper cells marked by fine parallel longitudinal striations. The appendage erect, slightly divergent, stiff, long, slender, rather remotely septate, but the basal cell often broader than long, about seven-celled, tapering distally. Spores  $90 \times 4 \mu$ , in one small specimen  $165 \times 4.5 \mu$ . Perithecia  $425-500 \times 70-95 \mu$ , the appendage  $45-50 \mu$ . Receptacle  $175-220 \mu$ , the basal cell  $150-170 \mu$ . Antheridial appendage  $200-325 \mu$ .

On the inferior anterior margin of the thorax near the base of the right elytron of *Tropisternus apicipalpis* Cast., Jalapa, Mexico. Sharp Collection, No. 1178.

A very beautiful species abundantly distinguished by reason of its many peculiarities from all others. It is perhaps more nearly allied to *C. Floridanus* than to any other and has the same peculiar longitudinal



striations on the cells of its receptacle. Its clear amber-color is also peculiar. The occurrence of monstrous spores in one smaller specimen is noted above, and illustrates the danger of ascribing too much importance even to considerable variations in spore measurements.

#### CERATOMYCES MINISCOLUS Thaxter.

This species which always grows on the pale lower margin of the right elytron, has been found on *Tropisternus striolatus* Lec. and *T. lateralis* Fabr., at Eustis, Florida; on *T. limbalis* Lec. from Washington; on *T. dorsalis* Brullé from California. In the Sharp Collection from Brazil on *T. lateralis*, No. 1184; and in the Museum of Comp. Zool., No. 1337, on an undetermined *Tropisternus* from Brazil. It is always readily distinguished by its small size, and almost wholly opaque receptacle.

#### COREOMYCES Thaxter.

Proc. Am. Acad. Arts and Sci., Vol. XXXVIII, p. 56. June, 1902.

Mature individual consisting of a single series of superposed cells terminated by a single perithecium. Receptacle attached by a more or less rhizoid-like foot and consisting of three superposed cells, the upper of which becomes divided distally by successive transverse septa; these divisions resulting in a series of superposed cells, from each of which arises, on one side, a single, rarely two, branched antheridial, appendages; the members of the series thus resulting being superposed in a single vertical row. Perithecium consisting of an undifferentiated stalk-cell immediately above the appendiculate cells, which is followed directly by the ascigerous cavity, the basal and wall-cells being wholly obliterated in mature individuals, except at the tip.

The development of the individuals in this type is unlike that found elsewhere in the Laboulbeniales. The young individual, Plate LXXI, figs. 8 and 17, consists of a series of superposed cells, three in number, from the uppermost of which appendiculate cells are separated distally. The distal portion of the individual above these appendiculate cells, of which there may be one to several, consists of a simple series of from four to six superposed cells, terminated by a simple or branched erect appendage which might be taken for a trichogyne, but is merely a sterile termination. There are thus three regions, a basal, a distal and a middle region, of which the first forms the receptacle proper, the second produces the perithecium, and the middle gives rise to the antheridial appendages; an arrangement quite unlike that seen in any other instance. As the individual continues to develop, the subbasal cell of the distal series, which is finally quite obliterated, becomes proliferous distally, sending branches into the cavity of the cell immediately above it (fig. 9). At about this time the sterile terminal appendage already referred to, is broken or sloughed off. The penetrating branches are apparently primarily two in number, their bases, it would appear, corresponding to the "posterior basal cell" and the "secondary stalk-cell" of the perithecia of *Laboulbenia* and other genera, as described in my Monograph, pp. 219 and 232, Plate II, figs. 16-18, cells (o) and (h), which in these cases arise as branches from the stalk-cell (p). The further development appears also to correspond with that of the ordinary type of perithecium, in that these two cells give rise to a series of branches from which wall-cells, parietal cells, and procarp cells are formed.

Of the two original cells one, Fig. 12, (o), as in other cases, appears to form only one series of wall-cells and one of parietal cells; in other words it appears to branch only once, while all the rest of the essential cells of the perithecium and procarp are derived from three branches which arise from the second cell (h). As these branches develop, they penetrate and destroy the successive septa which separate the cells above, of which there may be from two to four; and finally the procarpic branch, reaching the tip of the terminal cell before the others, perforates it at a point corresponding to the base of the terminal sterile appendage above mentioned, and emerging forms the short irregularly branched trichogyne shown in figs. 11-12. I have found it impracticable to draw the exact conditions seen by focussing upon this plexus of penetrating branches and the figures given (figs. 11-12) represent only the structures seen in a single plane. In fig. 12 for example the branches are represented in a position a little below the median



plane, and other branches coming from cell (h) both above and below, are not shown. The parietal branches appear to be developed near the bases of the wall-cell branches, but are small and hardly distinguishable, their functions being usurped as will appear later, by the wall-cells themselves.

Even while this development of branches is taking place the two basal cells (o) and (h) begin to be pressed down by the structures to which they have given origin above, into the cell below from which they originated, and as the development of the ascogonium proceeds this cell, like the cells above it, loses its identity as a cell; the whole series being transformed to a continuous cavity within which the whole ascogenic apparatus eventually lies quite free. The procarp resembles other procarps of this group, consisting of an ascogonium, an inferior and a superior supporting cell, followed by a trichophoric cell; above which the unicellular, sparingly branched or lobulated trichogyne emerges, as has been already described (figs. 11–12). As the perithecium matures and the ascogenic cells become active, only two or three wall-cells which have become indurated and cohere closely to the inner surfaces of the cells within which they were formed, persist, as shown in the bent termination of fig. 7, to form the tip of the functional perithecium. The cavity of the perithecium is thus the cavity of the cell from which the perithecial branch system originated combined with the cavities of the cells through which these branches penetrated; and its walls, except at the tip, as above mentioned, are the walls of these cells. The structure may thus be termed a *pseudoperithecium*.

If then one examines the conditions found when the plant is fully mature it will be seen to consist of the same three regions distinguished in the young condition. The terminal region, however, above the appendiculate cells, excepting only its basal cell which acts as a false stalk-cell to the pseudoperithecium, has become transformed into a single chamber, the wall of which corresponds to the combined walls of the four or more cells which were superposed above the basal cell of the series comprising this distal region. Within this chamber have developed from the subbasal cell of the series, structures which correspond to *all* those found in the normal perithecium of the Laboulbeniales. Of these structures, however, all are eventually disorganized with the exception of a few small wall-cells, which persist distally and are functional in regulating the spore-discharge, and the ascogenic cells, of which there appear to be four. These ascogenic cells, then, together with the usual mass of asci and spores, float free within a structure resembling a perithecium and performing the same function, but which when viewed superficially has absolutely nothing in common with any of the structures seen in perithecia of the normal type.

Such an endogenous origin of the perithecium has no parallel in the other genera, unless it be in *Zodionomyces* and perhaps also in *Euzodionomyces*. In the former the perithecial area arises endogenously in a somewhat similar fashion, and if in the present instance the perithecial structures persisted, and the walls of the cells into which they penetrate were eventually destroyed, the conditions would be closely comparable: the differences depending merely on the differences in the general cell structure of the body of the plant in either case; the complicated multicellular body of *Zodionomyces* producing many perithecia where the present simple type gives rise to but one. The character and origin of the antheridial branches in the two cases are however totally different.

The antheridial appendages in the present genus are peculiar, from their position on the primary axis *below* the perithecium, a condition seen nowhere else unless possibly in *Chætomyces*; although such an arrangement, as in *Clematomyces*, is often seen in *branches* from this axis. The antheridial cells themselves are merely the lower cells of the appendage or its branches (fig. 13), from which short outgrowths arise that are converted into discharge-tubes through which the sperm-cells make their exit as in simple antheridia of the ordinary type. The conditions present in the antheridial appendages in this instance do not therefore appear to differ essentially from those seen, for example, in *Rhadinomyces*; except that the series of antheridial cells is not definitely differentiated. At the same time the conditions described are very similar to those in *Rhynchophoromyces* and illustrated in my Monograph, Plate XXIV, fig. 24: but whether the sperm-cells in the present instance possess a wall, as in *Rhynchophoromyces*, I am not able to say. The antheridial characters of *Coreomyces* thus tend to break down the distinction formerly assumed



to exist between the Exogenæ and the Endogenæ, from the fact that a discharge tube is developed and that the sperm cells appear to be quite free at the moment of exit, not remaining attached or cohering as they occasionally do in *Rhynchophoromyces*. Although in *Ceratomyces* and *Autoicomyces* the sperm cells appear to be segments of actual branchlets, and in *Zodiomyces* they arise, if my former observations are correct, by exogenous budding as in the spermatia of many lichens, it is evident from these intermediate conditions, that no hard and fast line can be drawn between the two types of origin.

The species occur on water bugs, Corisidæ, (often written Corixidae), and are the only forms known to be parasitic on hemipterous insects. The discovery of this very interesting genus is due to Mr. Charles Bullard who first observed it on *Corisæ* from the Cambridge region.

COREOMYCES CORISÆ Thaxter. Plate LXXI, figs. 16–18.

Proc. Am. Acad. Arts and Sci., Vol. XXXVIII, p. 56. June, 1902.

Curved or straight, pale dull brownish, nearly transparent. Cells of the receptacle distinguished by more or less distinct constrictions, the three lower somewhat variable in length, the basal smaller, usually tapering somewhat to the foot; the subbasal larger than either of the others, more or less inflated, often as broad as the perithecium; the upper cell somewhat narrower, followed by the two to four, usually flattened, appendiculate cells, which are successively longer, though usually slightly narrow from below upward, the uppermost becoming about half as long as broad. The appendages long slender hyaline, sparingly branched, slightly divergent; usually extending upward to, or considerably beyond, the tip of the perithecium. Stalk-cell of the perithecium not differentiated from the cells below it, large, as broad as the body of the perithecium above it, cylindrical or slightly inflated, about as long as broad or slightly longer: body of the perithecium usually straight, somewhat darker dull brown, especially where it tapers rather gradually to the small tip which becomes distinctly symmetrically four-papillate, and is usually slightly bent to one side. Spores  $85 \times 6 \mu$ . Perithecia  $100-110 \times 25-35 \mu$ , the stalk-cell  $30-33 \times 32-35 \mu$ . Receptacle, exclusive of the appendiculate cells,  $75-100 \mu$ . Appendages  $200-250 \mu$ . Total length to tip of perithecium  $275-290 \mu$ .

On inferior surface of abdomen of *Corisa Kennicottii* Uhler, Arlington (Bullard), on *Corisa* sp., Iowa, and on two species of the same genus collected near Fresh Pond, Cambridge.

This species, which sometimes occurs in company with *C. curvatus* on the same individual, is always found on the abdomen, usually near its extremity, on the under side. In a single instance a group of individuals was found on the upper margin of one of the anal plates which differ in several respects from the type form, having as many as seven appendiculate cells; a more elongate form and other slight differences which may prove of specific value. The material from Iowa corresponds in all respects with the ordinary type found about Cambridge. The name of the host-genus is sometimes written *Corixa*.

COREOMYCES CURVATUS Thaxter. Plate LXXI, figs. 7–15.

Proc. Am. Acad. Arts and Sci., Vol. XLI, p. 318. July, 1905.

Nearly hyaline, or but faintly tinged with brownish. Receptacle becoming narrow toward the small basal cell, the two cells above the latter subequal in length, the appendiculate cells usually four, broader than long, subequal or the lower shorter. Stalk-cell of the perithecium relatively long, slightly or not at all inflated; the base of the perithecium often slightly inflated, the upper third or more bent abruptly outward, tapering to the blunt curved apex, the concave side of which is edged with amber-brown, the convex marked by slight indentations due to the prominence of the persistent wall-cells in this region. Appendages as in *L. Corisæ*, usually distinctly shorter. Spores  $55 \times 4 \mu$ . Perithecium  $130-140 \times 36 \mu$ , its stalk-cell  $70 \times 25 \mu$ . Total length, average, about  $350-360 \mu$ . Appendages about  $125 \mu$ .

On under side of margin of left elytron of two species of *Corisa*. Near Fresh Pond, Cambridge.

Sufficient material of this form has been obtained on *Corisæ* from an old clay pit near Fresh Pond, to determine the constancy of its characters. Its occurrence on the left elytron appears to be invariable.



*ZODIOMYCES VORTICELLARIUS* Thaxter.

This species has been again found on Hydrophilidæ from Lake Eustis and Cocoanut Grove, Florida, and enormous individuals, some of them three millimeters in length, were obtained in the Paris Museum, No. 121, on a large species of *Hydrophilus* from Rosario, Argentina. Despite the size of the receptacles in these individuals, the perithecia and other structures seem identical with the smaller forms, and certainly cannot be separated specifically.

*EUZODIOMYCES* Thaxter.

Proc. Am. Acad. Arts and Sci., Vol. XXXV, p. 449. April, 1900.

Receptacle elongate, multicellular, terminated by a primary branched appendage, and consisting of a large and indefinite number of superposed cells which distally become divided longitudinally to form successive tiers of cells which become proliferous on one side and give rise to a unilateral series of perithecia and sterile (and antheridial ?) appendages. Perithecia having nine or ten wall-cells in each row and borne on two superposed cells which form a stalk.

The material illustrating this very peculiar genus is for the most part in very poor condition, and includes but one mature individual. The appendages and young perithecia are so matted together that I have found it impossible to determine accurately the character of the antheridial branchlets. In a few cases flask-shaped cells have been observed which are borne one to three together on short branches. Whether these are really antheridia, however, can only be determined by the examination of fresh material.

The genus is most nearly allied to *Zodiomyces* and to *Kainomyces*, the short stout blunt and very peculiar perithecium suggesting that of *Kainomyces*, while its two-celled stalk is similar to that of *Zodiomyces*. The receptacle ends in a primary appendage which bears a number of filamentous branches, and below its base the peritheciigerous area extends downward on one side for a variable distance. Whether this peritheciigerous region originates endogenously, as in *Zodiomyces*, I have been unable to determine from the material available; but such does not appear to be the case. The elements arising from this region, however, consist of sterile rarely branched filamentous appendages which form a double row enclosing the other structures within, somewhat in the same manner that the circular series in *Zodiomyces* encloses the region from which the perithecia and antheridial appendages arise. The strobil-like perithecium is quite unique and no lip-cells appear to be differentiated. In some specimens the receptacle is very slender while in others it may be stout and densely cellular.

The species does not appear to occur in America, but seems to be not uncommon in England where it is to be hoped that fresh material may be obtained, and more thoroughly investigated.

*EUZODIOMYCES LATHROBII* Thaxter. Plate LXXI, fig. 23.

Proc. Am. Acad. Arts and Sci., Vol. XXXV, p. 449. April, 1900.

Hyaline or faintly yellowish. Receptacle long and slender, or shorter and stouter, according as the longitudinal septa are few or abundant; the superposed cells and those composing the tiers sometimes nearly a hundred in number, the upper half or more producing a unilateral series of perithecia and appendages. Perithecia distinctly broader distally, the fourth or the fifth to the seventh wall-cells inclusive, of each row, growing upward and outward to form well developed prominences, giving the margin on either side in this region a bluntly serrate appearance; the lip-cells arched, forming a characteristic broad dome-like apex; the lower stalk-cell small, the upper much larger, stout somewhat inflated and nearly as broad as the base of the perithecium. Appendages long slender cylindrical, simple or sparingly branched, flexuous. Perithecia  $75 \times 28-30 \mu$  (including projections), stalk about  $40 \mu$ , the upper cell about  $22 \times 14 \mu$ . Total length of receptacle  $200-475 \times 25-70 \mu$ . Appendages  $125-230 \times 4 \mu$ .

On *Lathrobium punctatum* Zett., British Museum No. 442, Notting Hill, England; on *L. multipunctatum* Grev., British Museum No. 429, Europe; on *L. filiforme* Grav. British Museum No. 443, Notting Hill, England; on *L. brunneipes* Fab., Thornhill, England. Sharp Collection, No. 1144.



## KAINOMYCES Thaxter.

Proc. Am. Acad. Arts and Sci., Vol. XXXVII, p. 44. June, 1901.

Receptacle broad and flattened; consisting of a single basal cell and typical foot, above which the successive cells become variably divided by longitudinal septa into transverse cell-rows or tiers: a distal appendiculate portion more or less definitely distinguished and consisting of superposed cells, the lowest of which alone become longitudinally divided, all producing laterally antheridial (?) branches: several of the tiers below this appendiculate portion growing out laterally at right angles to the main axis of the receptacle, on one or both sides, to form indeterminate perithecial branches consisting of superposed cells and terminated by solitary perithecia. The perithecium of peculiar form, with six wall-cells in each row in addition to the lip-cells; the base of the trichogyne persistent in the form of a conical projection, associated in the type with a peculiar appendage inserted close beside it and shaped like a duck's bill.

It has proved impossible from an examination of the material available of this extraordinary form, to determine the character of the antheridia; and it is therefore placed provisionally near *Zodiomyces* and *Euzodiomyces*, although the resemblance which the single species bears to these genera may prove a superficial one. The distal appendiculate portion of the receptacle resembles the corresponding structure in the species of the two last mentioned genera as well as the so-called main appendage of *Ceratomyces* and its nearest allies. A similar comparison might also be made with the appendage of *Sphaleromyces* and its allies which, however, differ in possessing a few-celled receptacle.

The perithecia in the Type are extremely peculiar, both from their form and their two curious appendages, the smaller of which is evidently the indurated base of the trichogyne, and on account of their short stout form and the numerous members which compose the rows of wall-cells. The indeterminate cellular stalks of the perithecia have no parallel in any other genus, and although they may be called fertile branches, appear to represent stalk-cells which are distally subject to active intercalary division. How such a modification should be of advantage, it is difficult to see, since the growth of this branch carries the trichogyne far away from the assumed region of sperm-cell formation. The fact that the perithecia appear frequently to abort owing to lack of fertilization, would indicate that this relation is on the contrary a disadvantage as compared with the conditions usually observed, in which the trichogyne is closely associated with the sperm-cell producing structures.

KAINOMYCES ISOMALI Thaxter. Plate LXXI, figs. 20-22.

Proc. Am. Acad. Arts and Sci., Vol. XXXVII, p. 45. June, 1901.

Receptacle variably developed below the distal appendiculate portion, sometimes very broad, often much narrower: the cells above the basal cell becoming broader and flattened, and soon divided longitudinally by one or more septa, nearly hyaline and broadly edged wholly or in part below, especially on the posterior side, with contrasting brownish black, which may involve the whole of the cell, except the transverse septa; the blackened area usually characteristically indented above, and sometimes involving all but the uppermost tiers. Perithecial branches variably developed, the free portion curving upward, and consisting of from about twelve to thirty-five superposed hyaline cells, which are more or less flattened, usually separated by slight constrictions, the distal one similar to the others and followed directly by the basal cells of the perithecium. Perithecium becoming tinged with pale amber-brown, usually short, stout and broadly elliptical, often not distinguished from its basal cells; the distal end abruptly rounded, the pore subtended by a tooth-like outgrowth, the persistent base of the trichogyne, half as long as and paler than an appendage beside it, which bears a slight resemblance to a duck's bill, is dark clear brown, somewhat narrower distally and pale tipped, broader toward the base, where it is abruptly constricted and hyaline. Spores about  $30 \times 3.5 \mu$ . Perithecia  $72-80 \times 40-50 \mu$  exclusive of trichogynic appendage, which measures  $28-32 \times 11 \mu$ . Perithecial branch  $100-253 \mu$ . Receptacle  $150-220 \times 40-60 \mu$ . Antheridial branches about  $50 \mu$ . Total length to tip of perithecium  $250-460 \mu$ .

On *Isomalus Conradti* Fauvel. Derema, Usambara, East Africa. Berlin Museum, Nos. 847-848.



The appendages of this remarkable form are more or less matted and broken in the types which were obtained from pinned hosts that had apparently been in alcohol. The receptacle is very similar to that of *Zodiomyces*, and varies considerably both in the number of tiers, and in the number of cells in each tier, especially in the upper ones. The number of perithecia produced is also very variable, and in a few specimens these are formed on both sides, projecting in opposite directions. The transverse blackened areas, usually conspicuous and contrasting across the lower tiers which they may even involve completely, and which are peculiar for the indentations of their upper margins (fig. 20), also vary considerably, as is indicated in the accompanying figures. The host is a very insignificant staphylinid, which apparently lives under bark and would hardly have been suspected of harboring so large and peculiar a form.

---

### ERRATA.

- p. 269, line 5, for H. read M.
- p. 276, line 6, for *Catoscopi* read *Catascopi*.
- p. 314, line 12, for 13 read 14.
- p. 332, line 35, for *Dohrini* read *Dohrni*.
- p. 334, line 6 from bottom, for *Microxys* read *Micrixys*.
- p. 342, line 24, for *Calarhoides* read *calathoides*, line 17, for *Nitobia* read *Notiobia*.
- p. 345, line 44, for *Fairmaeri* read *Fairmairei*; line 36, for *Eberi* read *Erberi*; last line, for *punicatus* read *punicatus*.
- p. 354, line 6 from bottom, for *furcipes* read *fuscipes*.

The following Errata in Part I of this Monograph (Memoirs, Vol. XII, No. 3), have been brought to my attention:

- p. 267, line 26, for 17 read 18.
- p. 269, line 7, from bottom; p. 270, lines 11 and 31; p. 271, line 11; p. 273, line 25; p. 274, line 5,—for Plate V, read Plate VII.
- p. 279, line 19, for IV and 11 read VI and 9.
- p. 280, line 1, for 8: read VI.
- p. 289, line 10 from bottom, for VII and 27 read VIII and 28.
- p. 303, line 4 from bottom, for VII read IX.
- p. 314, line 10, for I read II.
- p. 322, line 19, for *Catoscopi* read *Catascopi*.
- p. 329, line 1, for XIV read XVI.
- p. 339, line 4 from bottom, for *McLean* read *McLeary*.
- p. 351, line 1, after 4 insert "and 12."
- p. 363, line 20, for 15 read 16.
- p. 369, line 1, for 19 read 18 and 26.
- p. 371, line 27, for 24 read 25.
- p. 392, for *Catoscopus* read *Catascopus*.
- p. 394, line 27, for *Catoscopus* read *Catascopus*.
- p. 403, after Fig. 17 add Fig. 18, Spore.
- p. 408, line 9, for 2a read 6a.
- p. 203, line 5, for XXIV read XXIII, and line 10, for 13 read 1.



## INDEX.

---

Since it has been necessary to omit a Host-Index, it has seemed desirable to separate the following Index of Host-Names from the Index of Plant-Names. It should be remarked in this connection that the host-names are those which were found on the labels of the specimens examined and in some cases were evidently unreliable. No attempt has been made to set right the synonymy of the insect-hosts, and the same form will thus be found in certain cases under two generic names. A complete Host-Index, with indications as to the synonymy, will be published at some later date.

### HOST-NAMES.

- |   |   |   |
|---|---|---|
| <p>Abacetus, 348.<br/>           costatus, 348.<br/>           quadraticollis, 342.<br/>           rubripes, 348.<br/>         Acanthogenius asteriscus, 345.<br/>         Acrogenys hirsuta, 362, 371.<br/>         Acrognathus mandibularis, 260.<br/>         Actobius cinerascens, 316.<br/>         Acylophorus, 315, 316.<br/>           aureus, 281.<br/>         Ærogenidion Bedeli, 340, 341, 342.<br/>         Agonoderus pallipes, 348.<br/>         Agra, 363.<br/>         Aleochara repetita, 281.<br/>           rufipes, 271.<br/>         Amichrotus, 425.<br/>           apicipennis, 425.<br/>         Anaplecta, 290.<br/>           Dohrinana, 290.<br/>         Anaplogenus, 348.<br/>           circumcinctus, 348.<br/>         Anchomenus, 345.<br/>           debilis, 345.<br/>           deplanatus, 345.<br/>           Faradayi, 345.<br/>           Helusi, 345.<br/>           latipennis, 345.<br/>           montivagus, 345.<br/>           Nicholsi, 345.<br/>           oblongus, 345.<br/>           Otagoensis, 345.<br/>           validus, 345.<br/>         Anchonoderus binotatus, 347.<br/>           concinus 358, 361.<br/>           pallipes, 347.<br/>           rugosus, 347.<br/>           subæneus, 347.</p> | <p>Anisodactylus, 347.<br/>           militaris, 338.<br/>           tricuspidatus, 341.<br/>         Anophthalmus, 336, 422.<br/>           Bilimeki, 422.<br/>           Carantii, 336.<br/>           Dalmatinus, 336.<br/>           Doriæ, 336.<br/>           hirtus, 422.<br/>           Lespezi, 423.<br/>           Motschulskyi, 336.<br/>           oblongus, 422.<br/>           Rhadamanthus, 423.<br/>           Schaumi, 336.<br/>           Schmidti, 336.<br/>         Antartia concinna, 342.<br/>         Anthicus, 294.<br/>           Californicus, 294.<br/>           floralis, 294, 295.<br/>         Antisphodrus Æacus, 345.<br/>           cavicolus, 345.<br/>           Erberi, 345.<br/>           Fairmairei, 345.<br/>           longicollis, 345.<br/>         Apenes, 383.<br/>           pallidipes, 383.<br/>         Aphænops cerberus, 422.<br/>         Apotomus rufus, 320.<br/>           xanthotelus, 320.<br/>         Aptinus, 351.<br/>           Boeticus, 352.<br/>           displosor, 352.<br/>           Italicus, 352.<br/>         Ardistomis, 246.<br/>           viridis, 246.<br/>         Argutor angularis, 345.<br/>           aquilus, 338.</p> | <p>Argutor elongatus, 342.<br/>           interstinctus, 345.<br/>           vernalis, 342.<br/>         Aspidoglossa, 411.<br/>         Atelothrus constrictus, 385.<br/>           depressus, 385.<br/>           erro, 383.<br/>           gracilis, 383.<br/>         Atomaria, 299.<br/>           ephippiata, 299.<br/>         Atranus pubescens, 277.<br/>         Belonuchus formosus, 259.<br/>           fuscipes, 251.<br/>         Bembidium, 345, 384.<br/>           Atlanticum, 335.<br/>           Grayanum, 335.<br/>           nigrum, 344.<br/>           sublimatum, 335.<br/>         Bembus gigas, 333.<br/>         Berosus, 434, 435, 436.<br/>           striatus, 434, 435.<br/>         Blabera, 291, 293.<br/>         Blattidæ, 241, 287, 290.<br/>         Bledius, 227, 275, 295.<br/>           annularis, 282.<br/>           basalis, 295, 359.<br/>           bicornis, 260, 275.<br/>           jacobinus, 359.<br/>           juvencus, 275.<br/>           nitidicollis, 282.<br/>           obtusus, 275.<br/>           opacus, 275.<br/>           subterraneus, 275.<br/>         Brachinus, 221, 330, 351, 352, 363,<br/>           364, 365, 366, 397, 401, 404,<br/>           406.<br/>           angustatus, 352.</p> |
|---|---|---|







- Dicranochus fractus*, 384.  
*salicivorus*, 384.  
*Dolichon Lathroboides*, 425.  
*Dolichos flaviventris*, 339.  
*Dromius longipes*, 341.  
*Drypta*, 276.  
*lineola*, 276, 361.  
*ruficollis*, 338, 361.  
*Dyschirius*, 430.  
*digitatus*, 430.  
*externus*, 430.  
*globosus*, 341, 430.  
*lavinsculus*, 430.  
*nigricollis*, 430.  
*palustris*, 430.  
*salinus*, 430.  
*thoracicus*, 344.  
*Echinoglossa Americana*, 269.  
*Ectobia*, 283, 289.  
*germanica*, 289.  
*Ega*, 328, 358.  
*Sallei*, 358.  
*Elachiptera longula*, 308.  
*Epilampra*, 291.  
*Episcosomus*, 334.  
*grossus*, 332.  
*laticollis*, 334.  
*Eucampesopa Hyrthi*, 313, 314.  
*Euchula flavilabris*, 376.  
*Euchlanius trochantericus*, 332.  
*Eudaha latipennis*, 357.  
*Eudema*, 331, 332.  
*arcuatocolle*, 332.  
*conicum*, 331.  
*Erichsoni*, 331.  
*grossum*, 332.  
*microcephalum*, 331.  
*sinuaticolle*, 332.  
*Symci*, 333.  
*vicinum*, 333.  
*Euproctus*, 383.  
*quadrius*, 277.  
*Eurysoma tenebrioides*, 410, 411.  
*Falagria*, 240.  
*Forficula*, 241.  
*tarniata*, 243.  
*Formica neogagates*, 359.  
*Galerita*, 233, 330, 363, 364, 387, 388, 391, 393, 394, 395, 397, 398, 399, 400, 401.  
*aquinoctialis*, 387, 397.  
*Africana*, 364.  
*Americana*, 387.  
*atripes*, 394.  
*attelaboides*, 363.  
*Californica*, 394.  
*carbonaria*, 387, 389, 391, 395, 396, 397, 398, 399.  
*Galerita erythrodera*, 387.  
*femorialis*, 363.  
*Forreri*, 394.  
*interstitialis*, 364.  
*Janus*, 394.  
*Lecontei*, 387, 401.  
*melanaria*, 397.  
*Mexicana*, 394.  
*Moritzi*, 395.  
*nigra*, 397.  
*pallidicornis*, 387, 395.  
*porcata*, 397.  
*rubricollis*, 387.  
*ruficollis*, 387.  
*striata*, 387, 397.  
*tenebriosa*, 394.  
*unicolor*, 387, 388, 390, 395, 397.  
*Gargus Schaumii*, 336.  
*Glyptomerus cavicolus*, 423.  
*Gnomotropis rufipes*, 402.  
*Gynandropus Mexicanus*, 427.  
*Gyretes*, 414, 416, 418.  
*acutangulus*, 416, 418.  
*Boreandri*, 416.  
*cinctus*, 416.  
*dorsalis*, 416.  
*Guatemalensis*, 416.  
*immarginatus*, 416.  
*leionatus*, 416.  
*minor*, 416.  
*proximus*, 416.  
*pruinosis*, 416.  
*pulverulentus*, 416.  
*sericeus*, 416.  
*Gyrinidæ*, 329.  
*Gyrinus*, 329, 412, 413.  
*bicolor*, 412.  
*striatus*, 412.  
*urinator*, 412.  
*Harpalus*, 339, 340, 342, 412.  
*aneus*, 341, 346.  
*neglectus*, 339.  
*rhoninus*, 339.  
*serripes*, 339.  
*sulphuripes*, 339.  
*tardus*, 339.  
*viridianus*, 346, 347.  
*Helluodes Nebrioides*, 349, 351.  
*Helluomorpha melanaria*, 393.  
*Hexagonia*, 349.  
*Homalota*, 259, 268, 269, 270, 275, 301.  
*insecta*, 269.  
*putrescens*, 268, 269, 275.  
*sordida*, 259.  
*Homothes*, 344.  
*elegans*, 341.  
*Hydrellia*, 303.  
*Hydrina*, 304.  
*Hydrobius*, 433.  
*Hydrocharis*, 263.  
*obtusatus*, 262.  
*Hydrophilidæ*, 433.  
*Hydrophilus*, 444.  
*Hydroporus*, 263, 264.  
*modestus*, 263.  
*Ina*, 383.  
*costulata*, 383.  
*Ischnoptera*, 288.  
*Isomalus Conradti*, 445.  
*Labia minor*, 242.  
*Laccophilus*, 263, 264, 265, 266.  
*hyalinus*, 264.  
*minutus*, 264.  
*proximus*, 265, 266.  
*Lasius Americanus*, 359.  
*Lathrobium*, 318, 326, 436.  
*angustatum*, 318.  
*apterum*, 422.  
*brunneipennis*, 318, 444.  
*filiforme*, 444.  
*fulvipenne*, 422.  
*Illyricum*, 326.  
*multipunctatum*, 336, 444.  
*punctatum*, 444.  
*quadratum*, 318, 323.  
*terminatum*, 318.  
*Latona Spinolæ*, 326, 353.  
*Lebia*, 360, 371.  
*Lecanomerus obsculus*, 342.  
*Leistus*, 351.  
*præustus*, 352.  
*rufescens*, 352.  
*Leptocheirus*, 249.  
*Javanicus*, 273.  
*minutus*, 273.  
*unicolor*, 273.  
*Leptotrachelus*, 363.  
*Lesteva*, 428.  
*pubescens*, 428.  
*sicula*, 428.  
*Limnophorus*, 310.  
*Limosina*, 304, 312.  
*fontinalis*, 311.  
*Lipterus microcephalus*, 345.  
*Loxandrus unistigma*, 342, 357.  
*Macrogyrus*, 417.  
*elongatus*, 418.  
*obliquatus*, 417.  
*Mauna frigida*, 383.  
*Mecyclothorax*, 384.  
*montivagus*, 384.  
*ovipennis*, 384.  
*pusillus*, 384.  
*Megalonychus*, 345.



- Megalonychus Angolensis**, 375.  
*Patrobioides*, 375.  
**Mesothriscus alternans**, 384, 385.  
*collaris*, 386.  
*Hawaiiensis*, 385.  
*musciola*, 383, 385.  
*tricolor*, 383, 386.  
**Metromenus**, 385.  
*aequalis*, 386.  
*caliginosus*, 385, 386.  
*epicurus*, 385.  
*ero*, 384.  
*fraudator*, 385, 386.  
*latifrons*, 385, 386.  
*mutabilis*, 386.  
**Micrixys robustus**, 334.  
**Microsomus vicinus**, 333.  
**Miscelus**, 369, 373, 375, 382.  
*Javanus*, 369, 373, 375.  
**Morio**, 329, 409, 410.  
*Braziliensis*, 410.  
*Georgiae*, 408, 410.  
*monilicornis*, 408, 410.  
*orientalis*, 409, 410.  
*simplex*, 408, 410.  
**Moriosomus sylvestris**, 410.  
**Mormolyce phyllodes**, 368.  
**Myrmeca laevinodes**, 248.  
**Myrmedonia**, 296.  
*flavicornis*, 241.  
**Nebria angustata**, 335.  
*angusticollis*, 335.  
*Gyllenhali*, 335.  
*rubicunda*, 335.  
**Notiobia cupreola**, 342.  
*disposita*, 356.  
*luroides*, 345.  
**Notonomus variicollis**, 345.  
*viridescens*, 333.  
**Nycteis**, 367.  
**Nycteribia Blasii**, 313.  
*Frauenfeldii*, 313.  
*Hermani*, 313.  
*vexata*, 313.  
**Nycteribidae**, 312.  
**Nyctobora latipennis**, 292.  
**Ochtheria mantis**, 310.  
**Edichirus**, 354, 424.  
**Edodactylus fuscobrunneus**, 336.  
**Omophron Americanum**, 411.  
**Onypterygia purpuratus**, 345.  
*pusilla*, 345.  
**Oopterus rotundicollis**, 343.  
**Ophionea**, 341.  
*cyanocephala*, 341.  
**Ophonus**, 339.  
*azureus*, 339.  
*brevicollis*, 339.  
*germanus*, 338.  
*obscurus*, 339.  
**Orectochilus**, 420.  
*cordatus*, 419.  
*discifer*, 420.  
*oblongusculus*, 419.  
*semivestitus*, 419.  
**Orectochirus**, 267.  
*specularis*, 267.  
**Orectogyrus**, 267.  
*glaucus*, 414, 415.  
*ornaticollis*, 415.  
*specularis*, 267, 415.  
*suturalis*, 415.  
**Orizabus**, 342.  
*calpidatus*, 342.  
**Orthomus aquilus**, 348.  
**Othius fulgidus**, 424.  
*fulvipennis*, 424.  
*melanocephalus*, 424.  
*myrmecophilus*, 424.  
**Oxypoda**, 271.  
**Oxytelus**, 290, 274, 275.  
*alutaceifrons*, 272.  
*luteipennis*, 272.  
*piceus*, 272.  
*rugosus*, 290.  
**Ozena angulicollis**, 403.  
*glabra*, 402.  
*levis*, 402.  
*parallela*, 402.  
*pedestris*, 402.  
*Reichii*, 402.  
**Pachyteles**, 242, 401, 402, 404.  
*Braziliensis*, 402.  
*longicornis*, 401.  
*Mexicanus*, 402.  
*parallelus*, 402.  
*porrectus*, 402.  
*seriatoporus*, 402.  
*testaceus*, 402.  
**Paderus**, 233, 330, 354.  
*australis*, 354.  
*coarctatus*, 354.  
*duplex*, 354.  
*erythroderus*, 354.  
*fuscipes*, 354.  
*longipennis*, 354.  
*luridiventris*, 354.  
*rutilicornis*, 354.  
**Panageus Symei**, 333.  
**Pangus**, 341, 342.  
**Patrobus excavatus**, 330.  
*rufipes*, 330.  
**Pelmatellus nitescens**, 342, 359.  
*obtusus*, 346.  
*variipes*, 342.  
*vexator*, 342.  
*brunneus*, 359.  
*flavipes*, 359.  
*fulvipes*, 359.  
*glaucus*, 359.  
*guttosus*, 359, 377, 378, 380.  
*hirsutus*, 359.  
*guttosus*, 359, 377, 378, 380, 382.  
**Pilobrytus**, 280, 286.  
*Americanus*, 286.  
*Austriacus*, 286.  
**Phaenocarpa americana**, 412.  
**Phaenopygus**, 267, 285, 401.  
*apicatus*, 401.  
*brunneus*, 401.  
*brunneus*, 401.  
*depressus*, 267.  
*fulvipes*, 285.  
*fulvipes*, 267, 401.  
*Hawaiiensis*, 411.  
*humilis*, 401.  
*Keenani*, 285, 404.  
*laticornis*, 401.  
*laticornis*, 267.  
*Madagascariensis*, 285.  
*marginalis*, 267.  
*marginalis*, 285.  
*obliquatus*, 401.  
*parallelus*, 285.  
*Yucatanus*, 267.  
**Phlaenothrips**, 234, 239, 252, 253, 254, 256, 257, 258, 259, 315, 319, 323, 358, 407, 425.  
*aridulus*, 258.  
*aridulus*, 253.  
*aridulus*, 252.  
*agilis*, 252.  
*alipes*, 259, 425.  
*atropis*, 256.  
*bipunctatus*, 252.  
*centralis*, 250.  
*cephalotes*, 257.  
*cruciatipennis*, 254.  
*cruciatipennis*, 252.  
*debilis*, 260.  
*decomis*, 253.  
*dimidiatus*, 252.  
*discoloris*, 250, 251.  
*obovatus*, 252.  
*exiguus*, 425.  
*flavolimbatus*, 252.  
*Floreni*, 358.  
*furvus*, 358.  
*gastralis*, 425.  
*gemellus*, 253.  
*incertus*, 358.  
*Lewisius*, 253.  
*longicornis*, 252, 257, 425.



- Phalanthus* *rectus*, 255  
*occultus*, 358  
*ochroleucus*, 358  
*oxypterus*, 259  
*parviventris*, 252  
*positus*, 353  
*proximus*, 253  
*punctus*, 353  
*rectangulus*, 251  
*scybalarius*, 252, 257  
*serenus*, 251  
*Sikora*, 254  
*sordidus*, 257  
*umbrahilis*, 254, 255  
*varians*, 252, 255  
*ventralis*, 253  
*xanthomerus*, 258  
*Phlaeothorax quadricollis*, 342  
*Phyllostroma*, 289  
*Physodera*, 383  
*Physocera porosa*, 342  
*Pimacodera*, 383  
*atrata*, 383  
*Pimplulus*, 324, 428  
*rufipennis*, 324  
*Pionycha*, 363  
*Planeta luniculatus*, 351  
*Platyderus calathoides*, 342  
*Platynus*, 345, 348  
*alboc.*, 345  
*alipes*, 345  
*dorsalis*, 330, 345, 346  
*extensicollis*, 381  
*levis*, 346  
*lugens*, 345  
*oblongus*, 346  
*Platyprosopus Beduinus*, 347  
*Platysma*, 342  
*caudicollis*, 411  
*Platystethus cornutus*, 282  
*Platyzosteria lugens*, 287  
*Pleuracanthus brevicollis*, 393  
*Pleurohomus*, 436  
*obscurus*, 436, 439  
*Pleurosoma sulcatum*, 345  
*Plociopterus latus*, 257  
*Pocilus Mexicanus*, 411  
*Polybirna*, 409  
*hamifera*, 409  
*Pristonychus Algerinus*, 345  
*punctulatus*, 345  
*Pseudomascus nigrita*, 343  
*Pseudopristonychus cimmerius*, 345  
*Pterolepta*, 342  
*Pterostichus*, 411  
*adoxus*, 342  
*sodalicus*, 342  
*Quedionarcus puniceipennis*, 257  
*Quedionuchus impunctus*, 325  
*Quedus*, 315, 317  
*basiventris*, 324  
*eruentus*, 315  
*dubius*, 315  
*flavicaudus*, 325  
*fulgidus*, 315  
*fuliginosus*, 315  
*graciliventris*, 324  
*impressus*, 315  
*insolitus*, 316  
*occultus*, 315  
*peregrinus*, 315  
*ruficollis*, 256  
*truncicollis*, 315  
*ventralis*, 315  
*Rhagodus laevipunctatus*, 345  
*Rhombus laevis*, 333  
*Rhopalomelus*, 332  
*angusticollis*, 332  
*Sarcophaga*, 309  
*Scaptomyza*, 306  
*graminum*, 306  
*Scatella stagnalis*, 303  
*Schizogenus*, 329  
*Selma Westermanni*, 328  
*Serrimargo guttiger*, 373, 377, 381, 382  
*Staphylinidae indet.*, 255, 256, 261  
*Stenognathus quadricollis*, 342  
*Stenolophus fuliginosus*, 348  
*Stilicus*, 319, 322, 335  
*angularis*, 319, 320, 322  
*geniculatus*, 336  
*orbiculatus*, 336  
*rufipes*, 319  
*similis*, 336  
*Stomis pumicatus*, 345  
*Stomonaxus*, 350  
*striaticollis*, 431  
*Stylopyga orientalis*, 286  
*Sumius longiusculus*, 429  
*Tachys*, 360  
*incurvus*, 360  
*Tachyusa*, 270  
*Tænodema*, 346  
*Tænodema cinerea*, 346  
*Temnopteryx*, 288  
*Tetracha*, 220, 411  
*fulgida*, 411  
*Horni*, 411  
*Thalpius rufulus*, 421  
*Thleopora corticalis*, 241  
*Thyreopterus*, 380  
*armatus*, 378  
*brevicollis*, 367, 370  
*flavosignatus*, 380  
*striatus*, 368  
*sublaevis*, 367  
*Trechus*, 335, 336  
*Asturiensis*, 421  
*flavomarginatus*, 421  
*laevipennis*, 336  
*micros*, 336  
*paludosus*, 336  
*rotundipennis*, 421  
*strigipennis*, 336  
*Trichognathus*, 390, 400  
*cinctus*, 390  
*immarginatus*, 390  
*marginatus*, 390, 401  
*marginipennis*, 390, 401  
*Trichophya pilicornis*, 300  
*Trichopteryx*, 297, 430  
*Haldemani*, 430  
*Trogophleus*, 268  
*Tropidopterus Duponcheli*, 342  
*Tropisternus*, 262, 435, 436, 437, 439, 441  
*apicipalpis*, 440  
*Caracinus*, 437  
*chalybeus*, 439  
*dorsalis*, 438, 441  
*ebenus*, 439  
*glaber*, 438, 440  
*lateralis*, 438, 439, 441  
*limbalis*, 438, 441  
*nigrinus*, 439  
*nimbatus*, 437  
*nitens*, 438, 439  
*nitidus*, 439  
*striolatus*, 438, 439, 441  
*umbrinus*, 439  
*xanthopus*, 439  
*Xantholinus obsidianus*, 257  
*Xanthophaea vittata*, 280  
*Xanthopygus Solskyi*, 261  
*Zuphium Mexicanum*, 421



## PLANT NAMES.

Note. Primary references and new names on combinations are indicated by bold face type, synonyms by italics.

- Acallomyces*, 229, 299, **300**.  
*Homalotæ*, **300**.  
*Acompsomyces*, 227, 229, 230, **297**,  
 299, 300.  
*Atomaria*, **299**.  
*Brunneolus*, **298**.  
*Corticaria*, 297, **298**.  
*pauperculus*, **298**.  
*Amorphomyces*, 221, 224, 226, 231,  
 281, **293**, 295.  
*Falagria*, 293.  
*Floridanus*, 221, 295.  
*Arthrohynchus*, 221, 222, 223, 227,  
 229, **312**, 317.  
*Cyclopodia*, 301, 312, **313**, 314.  
*Diesingii*, 312.  
*Eucampsipoda*, 312, 313, **314**.  
*Nycteribia*, **313**, 314.  
*Westrumbii*, 312.  
*Autoicomycetes*, 225, 228, 230, **434**,  
 436, 443.  
*acuminatus*, **434**.  
*falciferus*, **435**.  
*distortus*, 434, 435.  
*furcatus*, 434, 435.  
*humilis*, 434, 435.  
*ornithocephalus*, **435**.  
*Camptomyces*, 281.  
*Cantharomyces*, 227, **281**.  
*Bledii*, 282.  
*occidentalis*, 282.  
*Platystethi*, **282**.  
*pusillus*, 282.  
*Ceraomyces*, **327**.  
*Dahlia*, 222, 223, 314, **327**.  
*Selina*, 222, **327**.  
*Ceratomyces*, 224, 225, 226, 228,  
 230, 231, 234, 430, 431, 432,  
 433, 434, **435**, 436, 443, 445.  
*acuminatus*, 434.  
*ansatus*, 439.  
*Braziliensis*, **438**, 439.  
*Californicus*, **438**, 439.  
*camptosporus*, **438**.  
*cladophorus*, **437**.  
*confusus*, 436, 437, **439**, 440.  
*curvatus*, **437**, 438.  
*denticulatus*, 433.  
*deplantinus*, 433.  
*falciferus*, 435.  
*filiformis*, **436**, 437.  
*Ceratomyces Floridanus*, 439, **440**.  
*Mexicanus*, 438, **439**.  
*minisculus*, 436, **441**.  
*mirabilis*, 435, **439**.  
*ornithocephalus*, 435.  
*procerus*, **436**, 437.  
*reflexus*, 432, 436.  
*rhynchophorus*, 431, 436.  
*rostratus*, 436.  
*spinigerus*, **440**.  
*terrestris*, 435, 436.  
*Ceratomycetinae*, 431.  
*Chatomyces*, 225, 442.  
*Pinophili*, **429**.  
*Chitonomyces*, 226, 230, 261, 262,  
**263**.  
*Æthiopicus*, 263, **267**.  
*appendiculatus*, 265.  
*Bullardi*, 263, **265**.  
*dentiferus*, **264**.  
*Floridanus*, **264**.  
*Hydropori*, **263**.  
*Javanicus*, 263, **266**.  
*marginatus*, 263, 266.  
*melanurus*, 263, 266.  
*occultus*, **264**.  
*Orectogyri*, 263, **266**.  
*paradoxus*, 263, **264**.  
*psittacopsis*, 263, **266**.  
*rhyncostoma*, 263.  
*spinigerus*, 265.  
*spinosus*, **265**.  
*Clematomyces*, 226, **427**, 442.  
*Pinophili*, **427**.  
*Compsomyces*, 222, 225, 228, 272,  
 284, 427, **428**, 429.  
*Lestevi*, **428**.  
*verticillatus*, 226, 428.  
*Coreomyces*, 222, 227, 228, 229,  
 230, 231, 234, **441**, 442.  
*Corisæ*, **443**.  
*curvatus*, **443**.  
*Corethromyces*, 224, 229, 315, 317,  
**318**, 322, 323, 367, 369.  
*Brazilianus*, **318**.  
*Cryptobii*, 227, **318**, 319.  
*Latona*, 326.  
*longicaulis*, **319**.  
*purpurascens*, **318**.  
*Stilici*, 226, 280, 281, **319**, 320,  
 323.  
*Dichomyces*, 224, 226, 231, 233,  
**249**, 250.  
*Angolensis*, **257**.  
*Australiensis*, **256**.  
*Belonuchi*, **251**.  
*bifidus*, **255**.  
*biformis*, 226, 231, 250, **254**.  
*Cafianus*, 251, **258**.  
*dubius*, **252**, 253, 257.  
*exilis*, **258**.  
*furciferus*, 231, **250**, 251, 253,  
 257, 258.  
*Homalotæ*, **259**.  
*hybridus*, 231, 250, **253**, 254.  
*inaequalis*, 233, **260**.  
*infectus*, **257**.  
*insignis*, 254, **255**.  
*Javanus*, 250, **259**.  
*Madagascarensis*, **254**.  
*Mexicanus*, **256**.  
*Peruvianus*, **257**, 259.  
*princeps*, 233, 250, 252, 253,  
 256, **257**.  
*vulgatus*, 233, 250, **251**, 252,  
 253, 257.  
*Dichotomosiphon*, 235.  
*Dimeromyces*, 225, **241**, 297, 327.  
*Africanus*, 242.  
*coarctatus*, 222, 223, 241, **244**,  
 245.  
*crispatus*, **245**.  
*Forficulæ*, **242**.  
*Labiæ*, **242**.  
*minutissimus*, **242**.  
*nanomasculus*, **245**.  
*pinnatus*, 224, 225, **246**.  
*rhizophorus*, 222, 223, 241, **243**.  
*Dimorphomyces*, 224, 225, 226,  
**240**, 284, 297.  
*denticulatus*, 240.  
*infectus*, 240.  
*Myrmedoniae*, 225, 226, **240**.  
*Thleopora*, **241**, 284.  
*Dioicomycetes*, 221, 224, 227, 284, **293**.  
*Anthici*, **294**, 295.  
*Floridanus*, 294, **295**.  
*obliqueseptatus*, **296**.  
*onchophorus*, **294**.  
*spinigerus*, **295**.  
*Distichomyces*, 221, 226, 229, 230,  
 234, 240, **248**, 427.



- Distichomyces leptochiri*, 249.  
*Ecteinomyces*, 224, 225, 228, 429, 430, 431, 436.  
     *Trichopterophilus*, 429.  
*Enarthromyces*, 225, 227, 267, 294.  
     *Indicus*, 267.  
*Eucantharomyces*, 224, 227, 230, 275, 281, 301.  
     *Africanus*, 278, 279.  
     *Atrani*, 275, 277.  
     *Callidæ*, 277, 278.  
     *Casnoniæ*, 278.  
     *Catascopi*, 276, 279.  
     *Diaphori*, 276, 279.  
     *Euprocti*, 276, 277.  
     *Madagascarensis*, 278.  
     *spinosus*, 276.  
     *Xanthophææ*, 280.  
*Eucorethromyces*, 320.  
     *Apotomi*, 320.  
*Euhaplomyces*, 230, 281.  
     *Ancyrophori*, 281.  
*Eumonoicomycetes*, 230, 273, 276.  
     *Californicus*, 274.  
     *invisibilis*, 275.  
     *Papuanus*, 230, 273, 274.  
*Euzodiomyces*, 225, 226, 228, 230, 442, 444, 445.  
     *Lathrobii*, 444.  
*Haplomyces*, 227, 275, 276, 281.  
     *Californicus*, 275.  
     *Texanus*, 275.  
*Helminthophana*, 221, 312.  
     *Nycteribiæ*, 312.  
*Herpomyces*, 221, 222, 224, 241, 282.  
     *Anaplectæ*, 284, 289.  
     *arietinus*, 287, 288.  
     *chætophilus*, 283, 284, 285.  
     *Diplopteræ*, 288, 293.  
     *Ectobiæ*, 224, 283, 284, 289, 290.  
     *forficularis*, 290.  
     *Nyctoboræ*, 283, 290, 291, 292.  
     *Paranensis*, 283, 284, 290, 291, 292.  
     *Periplanetæ*, 283, 285, 293.  
     *Phyllodromiæ*, 288.  
     *Platyzosteriæ*, 286, 287.  
     *tricuspidatus*, 283, 290, 293.  
     *Zanzibarinus*, 287, 289.  
*Hydræomyces*, 226, 230, 264.  
     *Cnemidoti*, 267.  
*Hydrophilomyces*, 225, 228, 230, 429, 431, 436.  
     *reflexus*, 432.  
     *rhyncophorus*, 431.  
*Idiomyces*, 225.  
     *Peyritschii*, 314.  
*Kainomyces*, 224, 226, 228, 230, 444, 445.  
     *Isomali*, 445.  
*Kleidiomyces*, 226, 230, 280.  
     *furcillatus*, 271, 281.  
*Laboulbenia*, 227, 229, 233, 234, 241, 327, 328, 353, 430.  
     *acanthophora*, 372.  
     *Aerogenys*, 362.  
     *adunca*, 390, 391.  
     *Ærogenidii*, 340, 341.  
     *Anaplogenii*, 328, 342, 347, 348, 360, 361.  
     *Anchonoderi*, 347, 348.  
     *angularis*, 387, 388.  
     *anomala*, 334, 415.  
     *aquatica*, 329, 413.  
     *Argentiniensis*, 221, 397.  
     *aristata*, 376, 378, 379, 380, 392.  
     *armillaris*, 329.  
     *Asiatica*, 362.  
     *Assamensis*, 373.  
     *Atlantica*, 336.  
     *atrata*, 331, 332.  
     *Australiensis*, 371.  
     *barbata*, 408.  
     *bicolor*, 391, 396, 398.  
     *bicornis*, 227, 413.  
     *bidentata*, 343, 344.  
     *bilabiata*, 352.  
     *Bledii*, 358.  
     *Borneensis*, 380.  
     *brachiata*, 330.  
     *Brachini*, 345, 352, 353, 362, 363.  
     *Brachionychi*, 334.  
     *Caffi*, 353, 406.  
     *Casnoniæ*, 341, 350.  
     *Catascopi*, 382.  
     *cauliculata*, 329, 385, 386.  
     *celestialis*, 361, 362.  
     *ceratophora*, 328, 372, 373, 380.  
     *Ceylonensis*, 349, 351.  
     *chætophora*, 412.  
     *Chinensis*, 352.  
     *Chiriquensis*, 356, 357.  
     *cincta*, 331, 332.  
     *Clivinalis*, 329, 407.  
     *coarctata*, 329, 419, 420.  
     *Colpodis*, 398.  
     *Columbiana*, 358.  
     *concinna*, 366.  
     *constricta*, 414, 415, 420.  
     *Copteæ*, 343.  
     *Coptoderæ*, 370.  
     *corethroopsis*, 368, 369, 370.  
     *corniculata*, 388, 391, 396.  
*Laboulbenia corrugata*, 377.  
     *Craspedophori*, 333, 334.  
     *cristata*, 233, 330, 354, 355.  
     *Cubensis*, 414.  
     *curtipes*, 360.  
     *curvata*, 399.  
     *dactylophora*, 415.  
     *Darwini*, 330, 402.  
     *decipiens*, 221, 397.  
     *denticulata*, 417.  
     *dentifera*, 356.  
     *Dercylæ*, 410, 411.  
     *Dineutis*, 417, 418.  
     *Diopsis*, 354.  
     *Disenochi*, 384, 385, 386.  
     *distincta*, 372.  
     *divaricata*, 330, 333.  
     *drepanalis*, 416.  
     *Dryptæ*, 338.  
     *dubia*, 353.  
     *Ege*, 357.  
     *elongata*, 344.  
     *equatorialis*, 355.  
     *erecta*, 337, 379.  
     *Euchilæ*, 376.  
     *Eudaliæ*, 357.  
     *Europæa*, 351.  
     *exigua*, 333, 334.  
     *falcata*, 355, 356.  
     *fallax*, 418, 419.  
     *fasciculata*, 330.  
     *filifera*, 340, 341.  
     *finitima*, 380, 382.  
     *fissa*, 367, 370.  
     *flaccida*, 331, 349.  
     *flagellata*, 337, 342, 344, 346, 348, 349, 352, 362, 383.  
     *forficulata*, 367, 368, 370.  
     *Formicarum*, 248, 329, 359, 381.  
     *fusiformis*, 391, 396, 397.  
     *Galeritæ*, 394, 400.  
     *geniculata*, 390, 391.  
     *gibbifera*, 410, 411.  
     *Guerinii*, 416.  
     *Gyrinidarum*, 329, 412, 413.  
     *Hageni*, 222, 329.  
     *Hawaiiensis*, 383, 384, 385.  
     *Helluodis*, 349, 350, 351.  
     *Helluomorpha*, 390, 392, 393.  
     *heterocheila*, 416, 417.  
     *humilis*, 334.  
     *imitans*, 367, 368, 369.  
     *incerta*, 391, 396, 397.  
     *incurvata*, 405.  
     *inflata*, 232, 234, 359.  
     *insignis*, 370, 371.  
     *insularis*, 335.



- Laboulbenia intermedia*, 340, 341.  
*interposita*, 330, 331, 332.  
*Italica*, 364.  
*Japanensis*, 352, 363.  
*Japonica*, 329, 364, 365, 366.  
*Javana*, 373, 374.  
*Kunkeli*, 368.  
*Latonæ*, 326, 353.  
*Lebiæ*, 370.  
*lepada*, 340.  
*leucophæa*, 377.  
*Liberiana*, 332.  
*longicollis*, 363.  
*Loxandri*, 356, 357.  
*macrotheca*, 346, 347.  
*maculata*, 381, 382.  
*Madagascarensis*, 339.  
*Madeiræ*, 337.  
*Maylayensis*, 371, 378, 380, 382.  
*media*, 400.  
*Megalonychi*, 374.  
*melanaria*, 338.  
*melanopus*, 412.  
*melanotheca*, 233, 387, 388.  
*Mexicana*, 233, 330, 386, 387.  
*microscopica*, 359, 360.  
*microsoma*, 381.  
*minima*, 363.  
*minimalis*, 393.  
*Misceli*, 369.  
*Morionis*, 378, 408, 409.  
*Napoleonis*, 221, 329.  
*Nebriæ*, 335.  
*notata*, 348, 378.  
*Oaxacana*, 405.  
*obliquata*, 375.  
*obtusa*, 341.  
*Edichiri*, 354.  
*Edodactyli*, 336.  
*olivacea*, 328, 360.  
*Oopteri*, 343.  
*Ophoni*, 339.  
*Orectochili*, 419.  
*orientalis*, 329, 364, 365, 412.  
*Orthomi*, 337, 338.  
*Ozenæ*, 229, 401, 403, 404.  
*Pachytelis*, 330, 401, 402, 403, 404, 406.  
*pallescens*, 407, 408.  
*pallida*, 340, 407.  
*pallida*, 407.  
*palmella*, 368, 370.  
*Papuana*, 409.  
*parvula*, 346.  
*paupercula*, 337.  
*pedicellata*, 344.  
*pendula*, 405.  
*Pericalli*, 382.
- Laboulbenia perpendicularis*, 335.  
*perplexa*, 391, 392, 396, 397, 399.  
*Pheropsophi*, 233, 330, 401.  
*Philonthi*, 226, 233, 330, 358, 359.  
*Planetis*, 349, 350, 351.  
*Platyprosopi*, 347, 348.  
*platystoma*, 379.  
*Polyhirmæ*, 231, 408, 411.  
*polyphaga*, 335, 341, 342, 344, 348, 350.  
*producta*, 361.  
*proliferans*, 232, 328, 329, 330, 331, 332, 333.  
*prolixa*, 386.  
*prominens*, 371, 372.  
*protrudens*, 378.  
*Pseudomasci*, 340, 343.  
*Pterostichi*, 342, 345, 346.  
*punctata*, 395.  
*punctulata*, 401, 402, 403, 404.  
*pusilla*, 329, 364, 365.  
*pygmaea*, 399, 401.  
*Quedii*, 354.  
*retusa*, 406.  
*rhizophora*, 329, 364, 365, 366.  
*rostellata*, 404.  
*rotundata*, 418.  
*Rougetii*, 351, 352, 353, 363.  
*scelophila*, 381.  
*Schizogenii*, 378.  
*separata*, 368, 369.  
*Serrimatginis*, 381, 382.  
*speciosa*, 388, 389.  
*spectabilis*, 227, 386.  
*sphyriopsis*, 385.  
*spiralis*, 331, 348, 349, 351.  
*Stomonaxi*, 350.  
*strangulata*, 414, 419, 420.  
*subconstricta*, 376, 382.  
*subpunctata*, 394, 395.  
*subterranea*, 335, 336.  
*Sumatræ*, 373, 374.  
*Tachyis*, 360.  
*Tænodemæ*, 346.  
*tenuis*, 374, 375, 376, 378, 380.  
*Texana*, 231, 329, 330, 404.  
*Thyreopteri*, 380, 382.  
*tibialis*, 406.  
*tortuosa*, 401, 403.  
*Trichognathi*, 389, 393, 399.  
*triordinata*, 390, 392, 393, 397.  
*tuberculifera*, 376, 377.  
*umbonata*, 343.  
*uncinata*, 346.  
*variabilis*, 229, 229, 233, 329, 330, 410, 411, 412.
- Laboulbenia vancouveri*, 348.  
*— vulgata*, 335.  
*Laboulbeniæ*, 282.  
*Laboulbeniæ*, 240.  
*Lactarius*, 270.  
*Laminariomyces*, 226, 234, 261, 263.  
*— Hydrocharis*, 262.  
*— Tropsetera*, 262.  
*Misgonyx*, 228, 230, 429, 430.  
*— Dyrhæa*, 430, 431.  
*— Stomonax*, 431.  
*Monoblepharis misgonyx*, 235.  
*Monocomyces*, 224, 225, 230, 268, 271, 280.  
*— Alveolaris*, 270.  
*— Brittanensis*, 269.  
*— Echinoglossa*, 269.  
*— Jacquinæ*, 281.  
*— Homalota*, 268, 269, 270.  
*— nemoralis*, 275.  
*— Lepostichis*, 225, 268, 272.  
*— nigrescens*, 270.  
*— Oxyptera*, 271.  
*— St. Helensæ*, 225, 268, 272, 273.  
*— similis*, 269.  
*Moschomyces*, 222, 225, 281, 312, 427, 428, 429.  
*— insignis*, 429.  
*Pezizochalla*, 236, 239, 240, 241, 247, 248, 249, 250, 260, 261, 262.  
*— Amazonica*, 261.  
*— nigrescens*, 231, 241, 260.  
*— protea*, 260.  
*— Xanthopygi*, 261.  
*Pezizschallacæ*, 240.  
*Polyascaryces*, 230, 231, 299, 300.  
*— Trichophya*, 300.  
*Rhachomyces*, 225, 271, 286, 420, 429.  
*— anomala*, 297.  
*— Apharnopsis*, 422.  
*— arbusculus*, 425.  
*— Berlesiana*, 221.  
*— Canariensis*, 421.  
*— Cayennensis*, 423.  
*— Cryptobianus*, 424.  
*— Dolicaontis*, 420, 425, 426.  
*— furcatus*, 424.  
*— Glyptomeris*, 423.  
*— hypogæus*, 422, 423.  
*— Javanicus*, 426.  
*— longissimus*, 426.  
*— Edichiri*, 424, 425.  
*— Philonthanus*, 420, 424.  
*— pilosellus*, 422.  
*— stipitatus*, 422.  
*— tenuis*, 426.



- Rhizoglyphus* *fulvipes* 421 422  
*gibbus* 426  
*zebrinus* 421
- Rhizomyces* 301 317 318 322  
*albipes* 317  
*pallidus* 318
- Rhizomyces* 225 227 322 327  
*constrictus* 227 229 323  
*crispatus* 322  
*gibbus* 322
- Rhizoglyphus* 442
- Rhizoglyphomyces* 318 314 432  
*440 442 443*  
*denticulatus* 433  
*elephantinus* 433 434  
*rostratus* 318 433
- Rhizoglyphus* 225 226 227 228 247 249  
*Wasmannii* 248 249
- Smeringomyces* 226 226 296 321  
*anomalus* 297
- Sphaeromyces* 323 323  
*latro* 324 325  
*brachyotus* 324 325  
*clavipes* 325  
*testaceus* 324
- Sphaeromyces* *Lathrobii* 323.  
*Latro* 326  
*obtusus* 326.  
*occidentalis* 324.  
*propinquus* 326.  
*Quedionuchi* 326.
- Stachomyces* 321, 322  
*Conosomus* 297, 321.  
*Stilicoides* 320, 321.
- Stigmatomyces* 222, 224, 227, 229,  
 276, 297, 300, 301, 312, 314.  
*Racii* 309.  
*contractus* 229, 307, 308.  
*Dropsis* 304  
*dubius* 305, 310.  
*Elachiptera* 302, 308.  
*gracilis* 305  
*humilis* 310  
*Hydrellia* 303.  
*Linnocphora* 309  
*Linosoma* 311  
*macranodus* 306, 307.  
*Musca* 221  
*Papuanus* 311.  
*pauperculus* 306
- Stigmatomyces* *proboscideus* 308.  
*purpureus* 229, 301, 302, 303,  
 304.  
*rugosus* 307.  
*Sarcophagæ* 305, 309, 310.  
*Scaptomyzæ* 305.  
*spiralis* 303.  
*Venezuelæ* 304.  
*virescens* 229, 302.
- Symplectromyces* 225, 227, 229, 314.  
*vulgaris* 315.
- Teratomyces* 225, 227, 229, 314,  
 315.  
*Actobii* 316.  
*insignis* 317.  
*mirificus* 316.  
*petiolatus* 316.  
*Philonthi* 316.  
*vulgaris* 315.  
*Zealandica* 316.
- Vaucheria intermedia* 235.
- Zodiomyces* 222, 225, 226, 228,  
 231, 234, 442, 443, 444, 445,  
 446.  
*vorticellarius* 444.



## DESCRIPTION OF THE PLATES.

The figures have been reproduced by photo-lithography and somewhat reduced from original ink drawings, the approximate magnifications of which are indicated.

### PLATE XXVIII.

*Dimeromyces coarctatus* Thaxter. **Fig. 1.** Mature female individual with two perithecia, side view,  $\times 600$ . **Fig. 2.** Mature female individual with one perithecium, the male individual at right, a spore in process of discharge from the apex of the perithecium,  $\times 600$ . **Fig. 3.** The same, anterior view,  $\times 600$ . **Fig. 4.** Young female individual, lateral view showing young perithecia at left with terminal trichogyne,  $\times 950$ . **Fig. 5.** Mature male individual with three antheridia, lateral view,  $\times 1800$ . **Fig. 17.** Young perithecium with terminal trichogyne on which are two antherozoids,  $\times 1800$ .

*Dimeromyces rhizophorus* Thaxter. **Fig. 6.** Mature female individual; posterior view showing furcate rhizoid,  $\times 600$ . **Fig. 7.** Similar individual partly lateral view showing position *in situ* on small portion of the host integument beneath which the furcate rhizoid extends into its body cavity,  $\times 600$ . **Fig. 8.** Male individual with three antheridia showing its relation to integument of host, the simple rhizoid lying wholly within the body cavity,  $\times 1150$ .

*Dimeromyces Forficulae* Thaxter. **Fig. 9.** Mature female individual with a male at right showing relative position on the integument of host,  $\times 600$ . **Fig. 10.** Mature female individual; lateral view,  $\times 600$ . **Fig. 11.** Mature male showing relation to basal cell of female at right,  $\times 1150$ .

*Dimorphomyces Thleopora* Thaxter. **Fig. 12.** Female individual with male at right. **Fig. 13.** Distal portions of female (left) and male receptacles.

*Dimorphomyces Myrmedoniae* Thaxter. **Fig. 14.** Female individual with five perithecia seen from above (in relation to position of growth on host),  $\times 600$ . **Fig. 15.** Similar individual seen from below,  $\times 600$ . **Fig. 16.** Male individual,  $\times 950$ .

### PLATE XXIX.

*Dimeromyces Labiae* Thaxter. **Figs. 1-3.** Three female individuals seen from different positions,  $\times 600$ . **Fig. 4.** Female individual more highly magnified,  $\times 1150$ . **Fig. 5.** Male individual with three antheridia,  $\times 1150$ .

*Dimeromyces minutissimus* Thaxter. **Fig. 6.** Mature female individual more highly magnified,  $\times 1150$ . **Figs. 7-8.** Mature female individuals,  $\times 600$ . **Fig. 9.** Mature male individual,  $\times 1800$ .

*Dimeromyces nanomasculus* Thaxter. **Fig. 10.** Mature female individual,  $\times 600$ . **Figs. 11-12.** Female individual with a male individual (fig. 12) *in situ* at its base,  $\times 600$ . **Fig. 13.** Mature male individual  $\times 1800$ .

*Dimeromyces crispatus* Thaxter. **Fig. 14.** Mature female individual with male *in situ* on the right at its base,  $\times 600$ . **Fig. 15.** Male individual with the base of female seen at left,  $\times 1150$ .

*Dimeromyces pinnatus* Thaxter. **Fig. 16.** Well developed female individual with three perithecia,  $\times 600$ . **Fig. 17.** Female individual from leg of host,  $\times 600$ . **Fig. 18.** Male individual with three antheridia,  $\times 600$ .

### PLATE XXX.

*Dichomyces Cafianus* Thaxter. **Figs. 1-2.** Posterior and anterior views of mature individuals,  $\times 600$ .

*Dichomyces Peruvianus* Thaxter. **Figs. 3-4.** Anterior and posterior views of mature individuals,  $\times 600$ . **Fig. 5.** Tip of perithecium enlarged,  $\times 1800$ .

*Dichomyces Angolensis* Thaxter. **Figs. 6-7.** Posterior and anterior views of mature individuals,  $\times 600$ .

*Peyritschiella protea*. Thaxter. **Fig. 8.** Small individual on *Bledius bicornis* (England)  $\times 600$ . **Fig. 9.** Well developed individual on the same host.

*Peyritschiella Amazonica* Thaxter. **Fig. 10.** Posterior view of mature individual from Nanta, Amazon,  $\times 600$ .

*Peyritschiella Xanthopygi* Thaxter. **Fig. 11.** Anterior view of mature individual,  $\times 600$ .

### PLATE XXXI.

*Dichomyces exilis* Thaxter. **Figs. 1-2.** Two individuals showing variation in form of perithecia, anterior and posterior views respectively,  $\times 600$ .



*Dichomyces infectus* Thaxter. **Figs. 3-4.** Two variations showing anterior and posterior views respectively  $\times 600$ .

*Dichomyces vulgaris* Thaxter. **Figs. 5-6.** Anterior views illustrating two types of form,  $\times 600$ . **Figs. 7-8.** Posterior and anterior views of appendiculate tips of perithecia,  $\times 1800$ . **Fig. 9.** Anterior view of individual in which the perithecial appendages are absent. An adventitious perithecium developing from the second tier at the left,  $\times 600$ .

*Dichomyces furciferus* Thaxter, variety. **Figs. 10-11.** Anterior views of two individuals showing variation. Material from Cambridge,  $\times 600$ . **Fig. 12.** Posterior view of individual from Abyssinia,  $\times 600$ .

*Dichomyces Homalotæ* Thaxter. **Fig. 13.** Anterior view of pale individual,  $\times 600$ . **Fig. 14.** Posterior view of type form,  $\times 600$ .

*Dichomyces hybridus* Thaxter. **Fig. 15.** Anterior view of individual in which the perithecial appendages are absent,  $\times 600$ . **Fig. 16.** Individual having both types of perithecia,  $\times 600$ . **Fig. 17.** Posterior view of individual in which the perithecia are all of the appendiculate type,  $\times 600$ . **Figs. 18-19.** Posterior and anterior views of tips of perithecia of the appendiculate type,  $\times 1800$ .

## PLATE XXXII.

*Dichomyces Javanus* Thaxter. **Figs. 1-2.** Posterior and anterior views of typical forms,  $\times 600$ .

*Dichomyces insignis* Thaxter. **Fig. 3.** Posterior view of well developed individual,  $\times 600$ . **Fig. 4.** Antheridium much enlarged,  $\times 1800$ . **Figs. 5-6.** Anterior and posterior views of the appendiculate tips of two perithecia,  $\times 1800$ .

*Dichomyces dubius* Thaxter. **Figs. 7-8.** Two individuals with two (posterior view) and four (anterior view) perithecia respectively,  $\times 600$ . **Figs. 9-10.** Anterior and posterior views of the appendiculate tips of two perithecia,  $\times 1800$ .

*Dichomyces Madagascarensis* Thaxter. **Figs. 11-12.** Anterior and posterior views of well developed individuals,  $\times 600$ . **Fig. 13.** Anterior view of tip of perithecium,  $\times 1800$ .

*Dichomyces bifidus* Thaxter. **Fig. 14.** Anterior view of well developed individual,  $\times 600$ . **Figs. 15-16.** Posterior and anterior views of tips of perithecia,  $\times 1800$ .

## PLATE XXXIII.

*Dichomyces biformis* Thaxter. **Fig. 1.** Posterior view of well developed individual with seven mature and one immature appendiculate perithecium,  $\times 600$ . **Fig. 2.** Anterior view of a typical individual with six appendiculate perithecia (England),  $\times 600$ . **Fig. 3.** Anterior view of individual with perithecia of the second type bearing no appendages,  $\times 600$ . **Figs. 4-5.** Posterior and anterior views of tips of appendiculate perithecia,  $\times 1800$ .

*Dichomyces Belonychi* Thaxter. **Figs. 6-7.** Two individuals, posterior and anterior views respectively,  $\times 600$ . **Figs. 8-9.** Posterior and anterior views of the tips of appendiculate perithecia  $\times 1800$ .

*Dichomyces Australiensis* Thaxter. **Figs. 10-11.** Two individuals, posterior and anterior views respectively,  $\times 600$ . **Figs. 12-13.** Anterior and posterior views of appendiculate tips of perithecia.  $\times 1800$ .

*Dichomyces Mexicanus* Thaxter. **Figs. 14-15.** Two individuals anterior and posterior views respectively,  $\times 600$ . **Figs. 16-17.** Posterior and anterior views of appendiculate tips of perithecia,  $\times 1800$ .

## PLATE XXXIV.

*Rickia Wasmanni* Berlese. **Figs. 1-9.** Successive stages in the development of young individuals,  $\times 1100$ . **Fig. 10.** Mature individual,  $\times 290$ . **Fig. 11.** Mature individual more highly magnified,  $\times 600$ . **Figs. 12-13.** Antheridia illustrating compound character,  $\times 1400$ .

*Limnaiomyces Tropisterni* Thaxter. **Figs. 14-15.** Mature individuals. The pointed antheridium is shown at the left in fig. 5 just below the base of the perithecium,  $\times 290$ .

*Limnaiomyces Hydrocharis* Thaxter. **Figs. 16-17.** Two mature individuals,  $\times 290$ . **Fig. 18.** Young individual; the young antheridium at x,  $\times 600$ .

*Chitonomyces Orectogyri* Thaxter. **Figs. 19-20.** Two mature individuals,  $\times 290$ .

*Chitonomyces Aethiopicus* Thaxter. **Figs. 21-22.** Two mature individuals,  $\times 290$ .

*Chitonomyces psittacopsis* Thaxter. **Figs. 23-24.** Two mature individuals,  $\times 290$ . **Fig. 25.** Tip of perithecium more highly magnified,  $\times 600$ .

*Chitonomyces dentiferus* Thaxter. **Figs. 26-27.** Two mature individuals seen from opposite sides,  $\times 290$  and  $600$ .



*Chitonomyces Hydropori* Thaxter. **Fig. 28.** Mature individual,  $\times 290$ . **Fig. 29.** Mature individual more highly magnified,  $\times 600$ .

*Chitonomyces occultus* Thaxter. **Fig. 30.** Mature individual,  $\times 290$ . **Fig. 31.** Mature individual more highly magnified,  $\times 600$ .

*Chitonomyces Bullardi* Thaxter. **Figs. 32-34.** Two mature individuals,  $\times 290$ . **Figs. 35.** Tip of perithecium enlarged,  $\times 1100$ .

*Chitonomyces Floridanus* Thaxter. **Figs. 36-37.** Mature individuals,  $\times 290$ . **Fig. 38.** Mature individual more highly magnified,  $\times 600$ .

*Monoicomyces Leptochiri* Thaxter. **Fig. 39.** Individual with simple axis from abdomen of host,  $\times 600$ . **Fig. 40.** Branched individual growing on mouth parts of host,  $\times 600$ .

## PLATE XXXV.

*Monoicomyces similis* Thaxter. **Fig. 1.** Mature individual, anterior view,  $\times 600$ . **Fig. 2.** Posterior view showing primary appendage,  $\times 600$ .

*Monoicomyces Brittanicus* Thaxter. **Fig. 3.** Anterior view of mature individual,  $\times 600$ . **Fig. 4.** Posterior view of receptacle and primary appendages with perithecia and antheridia,  $\times 600$ .

*Monoicomyces Echidnoglossæ* Thaxter. **Fig. 5.** Anterior view of a somewhat irregularly developed individual,  $\times 600$ . **Fig. 6.** Young individual lateral view showing the primary appendage at right  $\times 600$ . **Fig. 7.** Antheridium,  $\times 1100$ .

*Monoicomyces Homalotæ* Thaxter. **Fig. 8.** Large individual from English type-material, anterior view,  $\times 600$ . **Fig. 9.** Smaller form from Maine, the bases of the perithecial stalks blackened,  $\times 600$ . **Fig. 10.** Young individual, lateral view showing primary appendage, at left, and antheridia,  $\times 1100$ .

*Monoicomyces Oxypodæ* Thaxter. **Fig. 11.** Posterior view of a pair of individuals,  $\times 600$ . **Fig. 12.** Lateral view of a single individual,  $\times 600$ . **Fig. 13.** Antheridium,  $\times 1800$ .

## PLATE XXXVI.

*Monoicomyces nigrescens* Thaxter. **Figs. 1-2.** Posterior view of mature individual,  $\times 600$ . **Fig. 3.** Anterior view of mature individual,  $\times 600$ . **Fig. 4.** Antheridium more highly magnified,  $\times 1100$ .

*Monoicomyces Aleocharæ* Thaxter. **Fig. 5.** Well developed individual posterior view,  $\times 600$ . **Figs. 6-7.** Anterior and posterior views of antheridia with four and two appendages respectively,  $\times 1100$ .

*Monoicomyces St. Helenæ* Thaxter. **Fig. 8.** Well developed individual showing three of its four peritheciigerous branches,  $\times 600$ . **Fig. 9.** Individual showing one of its three peritheciigerous branches with sterile appendages and antheridia subtending the terminal perithecium,  $\times 600$ .

## PLATE XXXVII.

*Polyascomyces Trichophyæ* Thaxter. **Figs. 1-2.** Two mature individuals the body of the perithecium in optical section showing the numerous ascogenic cells,  $\times 600$ .

*Kleidiomyces furcillatus* Thaxter. **Fig. 3.** Mature individual,  $\times 600$ . **Fig. 4.** Portion of a receptacle showing antheridium at the left,  $\times 600$ .

*Cantharomyces Platystethi* Thaxter. **Figs. 5-6.** Mature individual the branches of the primary appendage destroyed,  $\times 600$ .

*Eumonoicomyces invisibilis* Thaxter. **Fig. 7.** Mature individual,  $\times 600$ . **Fig. 8.** Young individual with immature perithecia subtended by an antheridium,  $\times 1100$ .

*Eumonoicomyces Californicus* Thaxter. **Figs. 9-10.** Two mature individuals,  $\times 600$ .

*Eumonoicomyces Papuanus* Thaxter. **Figs. 11-12.** Two immature individuals,  $\times 600$ . **Fig. 13.** Young individual, the primary appendage at the left with pointed terminal cell,  $\times 1100$ . **Fig. 14.** Young perithecium and trichogyne,  $\times 1100$ . **Figs. 15-17.** Anterior, posterior and obliquely lateral views of antheridia,  $\times 1675$ . **Fig. 18.** Anterior view of antheridium in optical section,  $\times 1675$ .

*Euhaplomyces Ancyrophori* Thaxter. **Figs. 19-20.** Two mature individuals,  $\times 285$ . **Fig. 21.** An antheridium, the discharge-canal at the left,  $\times 1100$ .

## PLATE XXXVIII.

*Eucantharomyces Atrani* Thaxter. **Figs. 1-2.** Two mature individuals,  $\times 225$ . **Fig. 3.** Antheridium,  $\times 600$ .

*Eucantharomyces Casnonia* Thaxter. **Figs. 4-5.** Two mature individuals,  $\times 225$ . **Fig. 6.** Antheridium,  $\times 600$ . **Fig. 7.** Spore,  $\times 600$ .



- Eucantharomyces Diaphori* Thaxter. **Figs. 8-9.** Two mature individuals,  $\times 225$ . **Figs. 10-11.** Two antheridia,  $\times 600$ . **Fig. 12.** Spore,  $\times 600$ .
- Eucantharomyces Catascopi* Thaxter. **Fig. 13.** Mature individual, the perithecium seen in optical section,  $\times 225$ . **Fig. 14.** Mature individual, the perithecium seen in surface view,  $\times 225$ . **Fig. 15.** Antheridium,  $\times 600$ . **Fig. 16.** Spore,  $\times 600$ .
- Eucantharomyces spinosus* Thaxter. **Figs. 17-18.** Two mature individuals,  $\times 225$ . **Figs. 19-20.** Two antheridia,  $\times 600$ .
- Eucantharomyces Xanthophææ* Thaxter. **Figs. 21-22.** Two mature individuals,  $\times 225$ . **Fig. 23.** Antheridium,  $\times 600$ .
- Eucantharomyces Madagascarensis* Thaxter. **Fig. 24.** Mature individuals,  $\times 225$ . **Fig. 25.** Antheridium,  $\times 600$ . **Fig. 26.** Spore,  $\times 600$ .
- Eucantharomyces Euprocti* Thaxter. **Figs. 27-28.** Mature individuals,  $\times 225$ . **Fig. 29.** Antheridium,  $\times 600$ . **Fig. 30.** Spore,  $\times 600$ .
- Eucantharomyces Callidæ* Thaxter. **Figs. 31-32.** Mature individuals,  $\times 225$ . **Fig. 33.** Antheridium,  $\times 600$ . **Fig. 34.** Spore,  $\times 600$ .
- Eucantharomyces Africana* Thaxter. **Figs. 35-36.** Two mature individuals,  $\times 225$ . **Fig. 37.** Antheridium,  $\times 600$ . **Fig. 38.** Spore,  $\times 600$ .

## PLATE XXXIX.

- Herpomyces Phyllodromiæ* Thaxter. **Fig. 1.** Partly lateral view of mature female individual seen *in situ* on spine of host,  $\times 625$ . **Fig. 2.** Male and female individuals *in situ* on spine of host,  $\times 625$ .
- Herpomyces Platyzosteriæ* Thaxter. **Fig. 3.** Female individual on spine of host showing penetration of the latter by rhizoids,  $\times 625$ . **Fig. 4.** Female individual *in situ* on spine of host. A male individual is present but concealed on opposite side. A germinating spore pair near tip of spine,  $\times 625$ .
- Herpomyces Nyctoboræ* Thaxter. **Fig. 5.** Male and female individuals *in situ* on antenna of host. The female has developed six secondary receptacles bearing perithecia,  $\times 290$ . **Fig. 6.** A single secondary receptacle of a female individual with its perithecium,  $\times 625$ . **Fig. 7.** Male individual producing very numerous antheridia,  $\times 625$ . **Fig. 8.** Terminal portion of the primary female receptacle,  $\times 1100$ .
- Herpomyces Anaplectæ* Thaxter. **Fig. 9.** Posterior view of female individual,  $\times 625$ . **Fig. 10.** Male individual,  $\times 625$ .
- Herpomyces Ectobiæ* Thaxter. **Fig. 11.** Female individual showing portion of integument of host bearing a spine to which the primary receptacle is attached. The latter has given rise to a branch which, creeping down the spine, has become furcate; each division giving rise to a secondary receptacle which creeps on the surface of the host and gives rise in both instances to five perithecia,  $\times 290$ . **Fig. 12.** A similar individual more highly magnified, the secondary receptacle at the left is broken; that at the right developing young perithecia,  $\times 625$ . **Fig. 13.** Female primary receptacle showing the origin of branch from its subbasal cell. The base of the male receptacle is shown at the left,  $\times 500$ . **Fig. 14.** Young perithecium with trichogyne,  $\times 500$ . **Fig. 15.** Two spores,  $\times 1100$ . **Fig. 16.** Male individual in which antheridia are being produced from the primary receptacle shown *in situ* on a spine, as well as in great numbers from the secondary receptacles which have developed from it,  $\times 625$ .

## PLATE XL.

- Herpomyces Paranensis* Thaxter. **Figs. 1-2.** Two perithecia with their secondary receptacles seen from opposite sides,  $\times 625$ . **Fig. 3.** Female individual showing the relation in position of the successively formed perithecia and their receptacles. A male individual is shown projecting from between the two first formed larger receptacles,  $\times 290$ . **Fig. 4.** Male individual with its characteristically elongated terminal cell below which four or five antheridia are produced,  $\times 1100$ . **Fig. 5.** Primary female receptacle with its characteristic elongated terminal cell, the branch from its subbasal cell shown at the right, the foot on the left,  $\times 1100$ . **Fig. 6.** A spore,  $\times 1100$ .
- Herpomyces arietinus* Thaxter. **Fig. 7.** Male and female individuals *in situ* on the integument of host; the female has produced three secondary receptacles, two of them mature, a younger one lying behind the right perithecium,  $\times 625$ .
- Herpomyces Zanzibarinus* Thaxter. **Fig. 8.** Female individual showing primary receptacle in the middle,  $\times 625$ . **Fig. 9.** Male individual,  $\times 1100$ . **Fig. 10.** Primary receptacle of female individual several cells of which appear to have produced branches,  $\times 1100$ .
- Herpomyces tricuspидatus* Thaxter. **Fig. 11.** Portion of a female secondary receptacle showing rhizoidal margin and four lobes which bear perithecia only one of which is shown,  $\times 625$ . **Fig. 12.** A similar receptacle viewed



from the opposite (posterior) side,  $\times 625$ . **Fig. 13.** A female individual *in situ* on the integument of host producing nine perithecia on two secondary receptacles between which in the centre a male individual projects,  $\times 290$ . **Fig. 14.** A male individual from which some of the antheridial branches have been removed,  $\times 625$ . **Fig. 15.** One of these antheridial branches enlarged,  $\times 1100$ . **Fig. 16.** Two spores,  $\times 1100$ . **Fig. 17.** Primary receptacle of a female individual showing branch at right,  $\times 625$ .

*Herpomyces forficularis* Thaxter. **Fig. 18.** Female individual with two secondary receptacles each bearing a perithecium; a male individual is shown between them,  $\times 290$ . **Fig. 19.** Secondary receptacle bearing perithecia showing connection at the right with branch from primary receptacle,  $\times 625$ . **Fig. 20.** Detail of tip of perithecium, a reverse view as compared with fig. 19,  $\times 625$ . **Fig. 21.** Spine with male and female primary receptacles *in situ*, the male at left has two antheridia; the female shows branch at left from its subbasal cell which becomes furcate below,  $\times 1100$ . **Fig. 22.** A spore,  $\times 1100$ .

## PLATE XLI.

*Herpomyces Diplopterae* Thaxter. **Fig. 1.** Female individual with two secondary receptacles,  $\times 290$ . **Fig. 2.** A similar female individual enlarged seen from behind showing the primary receptacle which gives rise to a branch which in turn branching to the right and left forms the two secondary receptacles. A male individual is shown beside the female primary receptacle at the left,  $\times 625$ . **Fig. 3.** Detail of tip of perithecium  $\times 1100$ . **Fig. 4.** Male individual bearing three antheridia,  $\times 110$ . **Fig. 5.** A spore,  $\times 1100$ .

*Herpomyces Periplanetae* Thaxter. **Fig. 6.** A group of five mature female individuals *in situ* on integument of host, the secondary receptacle having developed the characteristic shield-like covering from behind which the tips of the male individuals project in several instances,  $\times 290$ . **Fig. 7.** A single typical female individual a male shown projecting from behind the tip of the shield,  $\times 290$ . **Fig. 8.** A female individual *in situ* showing habit of the species when an individual grows wholly on a spine. Haustoria are shown penetrating to the medulla of the spine from the cells of the secondary receptacle and from the foot of the primary receptacle,  $\times 500$ . **Fig. 9.** Female individual with shield not well developed,  $\times 290$ . **Fig. 10.** Male (at left) and female individuals *in situ* on a spine; the primary receptacle of the female has developed an unusually long branch which, creeping to the base of the spine, has produced a secondary receptacle with a rudimentary shield,  $\times 625$ . **Fig. 11.** Two spores,  $\times 1100$ . **Fig. 12.** Part of a female primary receptacle four cells of which appear to have sent out branches to form secondary receptacles,  $\times 625$ . **Fig. 13.** Male individual,  $\times 625$ .

*Herpomyces chaetophilus* Thaxter. **Fig. 14.** Male and female individuals *in situ* on spine,  $\times 625$ . **Fig. 15.** Female individual *in situ*,  $\times 290$ . **Fig. 16.** A spore,  $\times 1100$ . **Fig. 17.** Germinating spore pair *in situ* on spine,  $\times 625$ . **Fig. 18.** Male (left) and young female individual showing the connection of the secondary receptacle with the branch from the primary receptacle,  $\times 625$ .

## PLATE XLII.

*Acallomyces Homalotæ* Thaxter. **Figs. 1-2.** Mature individuals,  $\times 600$ . **Fig. 3.** Antheridial appendage,  $\times 1100$ . **Fig. 4.** A spore,  $\times 1100$ .

*Acompsomyces Corticariæ* Thaxter. **Fig. 5.** Mature individual; the Type,  $\times 600$ .

*Acompsomyces Atomariæ* Thaxter. **Figs. 6-7.** Mature individuals,  $\times 600$ . **Fig. 8.** Young individual showing the antheridial appendage at the left: at the right the young perithecium (procarp) bearing a furcate trichogyne the swollen tips of which bear several receptive bladder-like outgrowths,  $\times 1100$ . **Fig. 9.** Detail of an antheridial appendage,  $\times 1100$ .

*Acompsomyces brunneolus* Thaxter. **Figs. 10-11.** Two mature individuals,  $\times 600$ . **Fig. 12.** Young individual with peculiar furcate trichogyne similar to that represented in fig. 8,  $\times 1100$ .

*Acompsomyces pauperculus* Thaxter. **Figs. 13-14.** Two mature individuals,  $\times 600$ . **Fig. 15.** A spore,  $\times 625$ .

*Dioicomycetes obliqueseptatus* Thaxter. **Fig. 16.** Female individual, the base broken off,  $\times 290$ . **Fig. 17.** A spore,  $\times 1100$ .

*Dioicomycetes Anthici* Thaxter. **Figs. 18-20.** Female individuals,  $\times 290$ . **Fig. 21.** Male individual,  $\times 290$ . **Fig. 22.** Mature male (at left) and young female developed from same spore-pair,  $\times 1100$ . **Fig. 23.** Mature male (at right) and young female the latter terminated by a two-celled trichogyne showing the small terminal thin-walled receptive portion. **Fig. 24.** Male spore,  $\times 1100$ . **Fig. 25.** Female spore,  $\times 1100$ .

*Dioicomycetes onchophorus* Thaxter. **Figs. 26-27.** Mature female individuals,  $\times 290$ . **Fig. 28.** Male individual,  $\times 1100$ . **Fig. 29.** Male (at right) and female spores,  $\times 1100$ .

*Dioicomycetes spinigerus* Thaxter. **Figs. 30-31.** Mature female individuals,  $\times 290$ . **Figs. 32-33.** Male individuals,  $\times 1100$ . **Fig. 34.** A female spore,  $\times 1100$ .



*Dioicomyces Floridanus* Thaxter. **Fig. 35.** Mature female individual,  $\times 290$ . **Fig. 36.** Male individual,  $\times 1100$ .

*Chitonomyces Javanicus* Thaxter. **Figs. 37-38.** Mature individuals,  $\times 600$ .

*Chitonomyces paradoxus* Peyritsch variety. **Fig. 39.** Mature individual from Java,  $\times 600$ .

*Chitonomyces spinosus* Thaxter. **Fig. 40.** Mature individual,  $\times 600$ .

*Smeringomyces anomalus* Thaxter. **Fig. 41.** Female individual *in situ* on bristle of host,  $\times 290$ . **Fig. 42.** Female individual *in situ* on bristle of host. The remains of a male (?) individual at right,  $\times 1100$ .

## PLATE XLIII.

*Clematomyces Indicus* Thaxter. **Fig. 1.** Well developed individual,  $\times 290$ . **Fig. 2.** Antheridial branchlet,  $\times 1100$ .

*Ceraomyces Dahlii* Thaxter. **Figs. 3-4.** Mature individuals: fig. 3 showing a complete rhizoidal apparatus and the relation of the basal cell to the integument and body cavity of the host,  $\times 290$ . **Fig. 5.** An insertion-cell bearing appendage with antheridial branches,  $\times 1100$ . **Fig. 6.** A spore,  $\times 1100$ .

*Ceraomyces Selenae* Thaxter. **Figs. 7-8.** The two type specimens,  $\times 290$ .

*Compsomyces Lesteræ* Thaxter. **Figs. 9-11.** Two mature individuals,  $\times 290$ . **Fig. 12.** Young individual showing a single subterminal antheridium,  $\times 1100$ .

## PLATE XLIV.

*Rhachomyces Canariensis* Thaxter. **Figs. 1-2.** Two mature individuals,  $\times 290$ .

*Rhachomyces Philonthinus* Thaxter. **Fig. 3.** Large individual on *Amichrotus* from Japan,  $\times 290$ . **Fig. 4.** Smaller specimen on *Philonthus*, England,  $\times 290$ .

*Rhachomyces stipitatus* Thaxter. **Figs. 5-6.** Two individuals from the type preparation on *Anophthalmus Rhadamanthus* Lind., the appendages much broken. **Fig. 5** showing individual *in situ* on bristle of host,  $\times 290$ .

*Rhachomyces tenuis* Thaxter. **Fig. 7.** Typical form,  $\times 290$ .

*Rhachomyces Dolicaontis* Thaxter. **Fig. 8.** A well developed typical individual,  $\times 290$ .

*Rhachomyces velatus* Thaxter. **Fig. 9.** Individual in which the perithecium has been partly exposed by the pressure of the cover glass,  $\times 290$ .

## PLATE XLV.

*Rhachomyces Javanicus* Thaxter. **Figs. 1-2.** Two mature individuals,  $\times 290$ .

*Rhachomyces velatus* Thaxter. **Fig. 3.** Typical form with appendages in normal position about the perithecium,  $\times 290$ .

*Rhachomyces Cayennensis* Thaxter. **Figs. 4-5.** Two mature individuals in which the longer appendage near the base are broken,  $\times 290$ .

*Rhachomyces Thalpii* Thaxter. **Figs. 6-7.** Two mature individuals,  $\times 290$ .

*Rhachomyces Oedichiri* Thaxter. **Figs. 8-9.** Two typical individuals,  $\times 290$ .

*Rhachomyces Zufi* Thaxter. **Figs. 10-11.** Two mature individuals,  $\times 290$ .

*Rhachomyces Aphænopsis* Thaxter. **Figs. 12-14.** Various developed individuals: the appendages in all more or less broken. **Fig. 13** a young individual showing the peculiar closely septate distal appendages,  $\times 290$ .

*Rhachomyces Cryptobianus* Thaxter. **Fig. 15.** The type specimen,  $\times 290$ .

*Rhachomyces Glyptomeræ* Thaxter. **Fig. 16.** The unique Type,  $\times 290$ .

## PLATE XLVI.

*Stigmatomyces constrictus* Thaxter. **Figs. 1-2.** Detail of antheridia seen from opposite sides,  $\times 1100$ . **Figs. 3-4.** Mature individuals,  $\times 290$ .

*Stigmatomyces Elachipteræ* Thaxter. **Figs. 5-6.** Two mature individuals,  $\times 290$ . **Fig. 7.** Detail of antheridium,  $\times 1100$ . **Figs. 8-8a.** Detail of tips of perithecia,  $\times 1100$ . **Fig. 9.** Basal cell of mature individual showing concentric thickenings below nucleus,  $\times 1100$ . **Fig. 10.** A spore,  $\times 1100$ .

*Stigmatomyces proboscidea* Thaxter. **Figs. 11-12.** Two mature individuals,  $\times 290$ . **Fig. 13.** Detail of antheridial appendage,  $\times 1100$ . **Fig. 14.** A spore,  $\times 1100$ .

*Stigmatomyces gracilis* Thaxter. **Figs. 15-16.** Two mature individuals,  $\times 290$ . **Fig. 17.** A spore,  $\times 1100$ . **Fig. 18.** Detail of antheridial appendage,  $\times 1100$ .

*Stigmatomyces Hydrelliæ* Thaxter. **Figs. 19-21.** Mature individuals, the first two typical,  $\times 290$ . **Fig. 22.** Detail of antheridial appendage,  $\times 1100$ . **Figs. 23-24.** Two views of the tip of the perithecium,  $\times 1100$ .



*Stigmatomyces spiralis* Thaxter. **Figs. 25-26.** Type forms of mature individuals,  $\times 290$ . **Figs. 27-28.** Two spores,  $\times 1100$ . **Fig. 29.** Detail of antheridial appendage,  $\times 1100$ .

*Stigmatomyces purpureus* Thaxter. **Figs. 30-31.** Typical form of mature individuals,  $\times 290$ . **Fig. 32.** A common variation,  $\times 290$ . **Fig. 33.** A spore,  $\times 1100$ . **Figs. 34-35.** Detail of tip of perithecium from different points of view,  $\times 1100$ . **Fig. 36.** Detail of antheridial appendage,  $\times 1100$ .

*Stigmatomyces Scaptomyza* Thaxter. **Figs. 37-39.** Mature individuals. **Fig. 37** from California, the rest from Maine,  $\times 290$ . **Fig. 40.** A spore,  $\times 1100$ . **Fig. 41.** Detail of antheridial appendage,  $\times 1100$ .

## PLATE XLVII.

*Stigmatomyces Limosinae* Thaxter. **Fig. 1.** A spore,  $\times 1100$ . **Fig. 2.** Small stout form of mature individuals,  $\times 290$ . **Figs. 3-4.** Two mature individuals of the typical form,  $\times 290$ . **Fig. 5.** Detail of antheridial appendage,  $\times 625$ . **Fig. 6.** Mature individual of Californian form,  $\times 290$ . **Fig. 7.** Young individual: a trichogyne at the right with adherent antherozoids,  $\times 1100$ .

*Stigmatomyces Papuanus* Thaxter. **Fig. 8.** A spore,  $\times 1100$ . **Figs. 9-12.** Mature individuals illustrating variations,  $\times 290$ . **Fig. 13.** Detail of antheridial appendage,  $\times 1100$ .

*Stigmatomyces dubius* Thaxter. **Fig. 14.** A Spore,  $\times 1100$ . **Figs. 15-17.** Mature individuals,  $\times 290$ . **Fig. 18.** Detail of antheridial appendage, 1100.

*Stigmatomyces micrandrus* Thaxter. **Fig. 19.** A spore,  $\times 1100$ . **Figs. 20-21.** Mature individuals,  $\times 290$ . **Figs. 22-23.** Detail of antheridial appendages from opposite sides,  $\times 1100$ . **Fig. 24.** Tip of perithecium,  $\times 1100$ .

*Stigmatomyces rugosus* Thaxter. **Figs. 25-26.** Type form from Ralum,  $\times 290$ . **Fig. 27.** Detail of antheridium from Ralum form,  $\times 1100$ . **Fig. 28.** Mature individual from Puyallup, Washington,  $\times 290$ .

*Stigmatomyces humilis* Thaxter. **Figs. 29-30.** Two mature individuals,  $\times 290$ . **Figs. 31-32.** Detail of antheridial appendages,  $\times 1100$ .

## PLATE XLVIII.

*Arthrorhynchus Cyclopedie* Thaxter. **Fig. 1.** Mature individual showing lateral view of ascogenic cells: the rhizoids broken from the haustorial cell,  $\times 290$ . **Fig. 2.** Mature individual showing its relation to the integument and body cavity of the host; a few of the rhizoids which form a tangled mass indicated semidiagrammatically,  $\times 290$ . **Fig. 3.** Detail of antheridial appendage,  $\times 625$ . **Fig. 4.** Detail of tip of perithecium seen partly in optical section showing the four papillæ which surround the ostiole,  $\times 625$ . **Fig. 5.** Detail of tip of perithecium showing outer bifid protuberances,  $\times 625$ . **Fig. 6.** A spore,  $\times 625$ .

*Arthrorhynchus Nycteribiae* (Peyritsch.). **Fig. 7.** Mature individual showing its relation to the integument of host; the perithecium shown in optical section except at its tip,  $\times 290$ . **Fig. 8.** Mature individual, the perithecium shown in surface view,  $\times 290$ . **Fig. 9.** Detail of antheridial appendage,  $\times 625$ . **Fig. 10.** Tip of perithecium in detail,  $\times 625$ .

*Arthrorhynchus Eucampsipodæ* Thaxter. **Fig. 11.** Mature individual from which the rhizoidal apparatus has been broken; the asci are seen end on in several rows the ascogenic cell lying behind,  $\times 290$ . **Fig. 12.** Tip of perithecium in detail,  $\times 625$ . **Fig. 13.** Detail of tip of perithecium seen in optical section,  $\times 625$ . **Fig. 14.** Detail of antheridial appendage.

## PLATE XLIX.

*Teratomyces Zealandica* Thaxter. **Figs. 1-2.** Anterior and posterior views of mature individuals,  $\times 290$ . **Fig. 3.** Portion of an appendage with branchlet bearing two antheridia,  $\times 1100$ .

*Teratomyces Philonthi* Thaxter. **Figs. 4-5.** Mature individuals,  $\times 290$ .

*Teratomyces petiolatus* Thaxter. **Fig. 7.** Mature individuals,  $\times 290$ .

*Stigmatomyces Diopsis* Thaxter. **Figs. 8-9.** Two mature individuals,  $\times 290$ . **Fig. 10.** Detail of antheridial appendage,  $\times 1100$ .

*Stigmatomyces Limnophoræ* Thaxter. **Figs. 11-12.** Two individuals not quite mature,  $\times 290$ . **Fig. 13.** Detail of antheridial appendage,  $\times 1100$ .

*Stigmatomyces Sarcophagæ* Thaxter. **Fig. 14.** Detail of antheridial appendage,  $\times 1100$ . **Fig. 15.** Mature individuals; short form,  $\times 290$ . **Fig. 16.** Mature individual of typical form,  $\times 290$ . **Fig. 17.** Unisexual individual (male) illustrating partial atrophy in one member of a spore pair,  $\times 290$ .

*Stigmatomyces pauperculus* Thaxter. **Fig. 18.** Mature individual,  $\times 290$ . **Fig. 19.** Detail of antheridial appendage,  $\times 1100$ .

*Stigmatomyces Venezuelae* Thaxter. **Figs. 20-21.** Two mature individuals,  $\times 290$ .

*Stigmatomyces Baeri* Peyritsch. **Fig. 22.** Detail of antheridium,  $\times 1100$ . **Figs. 23-24.** Two mature individuals (Vienna),  $\times 290$ .



## PLATE I.

- Sphaleromyces Latouæ* Thaxter. **Figs. 1-2.** Mature individuals,  $\times 290$ . **Fig. 3.** Immature individuals,  $\times 290$ .  
*Corethromyces purpurascens* Thaxter. **Figs. 4-5.** Two mature individuals,  $\times 290$ .  
*Corethromyces Stilici* Thaxter. **Figs. 6-8.** Mature individuals,  $\times 290$ . **Fig. 9.** Young individual showing seriate arrangement of antheridia,  $\times 600$ .  
*Corethromyces longicaulis* Thaxter. **Figs. 10-11.** Two mature individuals,  $\times 290$ .  
*Teratomyces insignis* Thaxter. **Fig. 12.** Typical form of mature individual,  $\times 290$ . **Fig. 13.** Variety with colorless receptacle,  $\times 290$ .  
*Symplectromyces vulgaris* Thaxter. **Figs. 14-15.** Mature individuals with one and four perithecia respectively,  $\times 290$ . **Fig. 16.** Young individual showing antheridia and sterile appendages,  $\times 600$ .

## PLATE LI.

- Corethromyces Brazilianus* Thaxter. **Fig. 1.** Large form from Columbia,  $\times 290$ . **Fig. 2.** Typical form from Brazil,  $\times 290$ .  
*Corethromyces Cryptobii* Thaxter. **Fig. 3.** Well developed individual from Kansas,  $\times 290$ .  
*Eucorethromyces Apotomi* Thaxter. **Figs. 4-5.** Mature individual from Europe. The appendages more or less broken,  $\times 290$ . **Fig. 6.** Appendage of younger individual from Celebes, showing solitary and clustered antheridia,  $\times 600$ .  
*Stichomyces Conosomæ* Thaxter. **Figs. 7-9.** Mature individuals variously developed,  $\times 290$ . **Fig. 10.** Young individual showing production of antheridia from primary axis,  $\times 625$ .  
*Stichomyces Stilici* Thaxter. **Figs. 11-12.** Mature individuals,  $\times 290$ . **Fig. 13.** Portion of axis showing antheridia,  $\times 1100$ . **Fig. 14.** Pair of spores,  $\times 1100$ .  
*Ecteinomyces Trichopterophilus* Thaxter. **Figs. 15-16.** Two normal somewhat elongated individuals,  $\times 300$ . **Fig. 17.** Small stout individual in which the receptacle has failed to elongate,  $\times 300$ . **Fig. 18.** Young individual showing trichogynes and antheridia,  $\times 300$ .

## PLATE LII.

- Sphaleromyces Chiriquensis* Thaxter. **Figs. 1-2.** Mature individuals, the appendages somewhat broken,  $\times 290$ .  
*Sphaleromyces Brachyderi* Thaxter. **Figs. 3-5.** Two mature individuals,  $\times 290$ .  
*Sphaleromyces atropurpureus* Thaxter. **Figs. 6-7.** Mature individuals; the appendages badly broken,  $\times 290$ .  
*Sphaleromyces Quedionuchi* Thaxter. **Figs. 8-9.** Two mature individuals,  $\times 290$ . **Fig. 10.** Detail of tip of perithecium,  $\times 625$ .  
*Sphaleromyces obtusus* Thaxter. **Figs. 11-13.** Mature individuals,  $\times 290$ .  
*Sphaleromyces propinquus* Thaxter. **Figs. 14-15.** Two mature individuals,  $\times 290$ . **Fig. 16.** Detail of tip of perithecium,  $\times 1100$ .  
*Sphaleromyces Indicus* Thaxter. **Figs. 17-18.** Two mature individuals the appendages somewhat broken,  $\times 290$ .  
*Rhizomyces crispatus* Thaxter. **Fig. 19.** Mature individual of Type form,  $\times 290$ . **Fig. 20.** A variety with differently shaped perithecium,  $\times 290$ . **Fig. 21.** Detail of antheridial branchlet,  $\times 625$ .  
*Rhizomyces gibbosus* Thaxter. **Figs. 22-23.** Two mature individuals. **Fig. 22** showing relation of basal cell to integument of host. The rhizoidal apparatus broken off in both specimens,  $\times 290$ .

## PLATE LIII.

- Laboulbenia exigua* Thaxter. **Fig. 1.** Mature type,  $\times 260$ .  
*Laboulbenia proliferans* var. *atrata* Thaxter. **Fig. 2.** Large form occurring on *Euchlænius trochantericus* Kolbe,  $\times 150$ .  
*Laboulbenia proliferans* var. *interposita* Thaxter. **Fig. 3.** Individual on *Chlænius* from Angola, Africa, showing partly blackened bases of appendages,  $\times 150$ . **Fig. 4.** Individual on *Chlænius* from Delagoa Bay,  $\times 150$ .  
*Laboulbenia proliferans* var. *cincta* Thaxter. **Fig. 5.** Type form on *Craspidophorus adequatus* Kolbe, Africa,  $\times 150$ .  
*Laboulbenia proliferans* var. *divaricata* Thaxter. **Fig. 6.** Type on *Chlænius* from Sandakan, N. Borneo,  $\times 150$ .  
**Fig. 7.** Individual on *Rhembus levis* Lesne from Java,  $\times 150$ .  
*Laboulbenia Craspedophori* Thaxter. **Fig. 8.** Individual on *Panagæus Symci* from Old Calabar Africa,  $\times 150$ .  
**Fig. 9.** Detail of antheridial branch with insertion cell,  $\times 625$ .



- Laboulbenia humilis* Thaxter. **Fig. 10.** Type on *Chlœnius cyaniceps* Bates from Hong Kong,  $\times 263$ .  
*Laboulbenia Brachionychi* Thaxter. **Fig. 11.** Individual on *Brachionychus* sp. from Cochin China,  $\times 150$ . **Fig. 12.** Detail of antheridial branchlets,  $\times 600$ .  
*Laboulbenia subterranea* Thaxter. **Fig. 13.** Form on *Stilicus geniculatus* from England,  $\times 263$ . **Fig. 14.** Individual on *Trechus micros* Herbst. from Hungary,  $\times 263$ . **Fig. 15.** Form on *Trechus* sp. Berlin Mus. No. 880,  $\times 263$ .  
*Laboulbenia Atlantica* Thaxter. **Fig. 16.** Type on *Lathrobium multipunctatum*,  $\times 263$ . **Fig. 17.** Form on *Gargus Schaumi*,  $\times 263$ .  
*Laboulbenia bidentata* Thaxter. **Figs. 18-19.** Mature individuals,  $\times 263$ . **Fig. 20.** Detail of tip of perithecium,  $\times 1100$ .

## PLATE LIV.

- Laboulbenia obtusa* Thaxter. **Fig. 1.** Mature Type,  $\times 280$ .  
*Laboulbenia intermedia* Thaxter. **Figs. 2-3.** Two type specimens showing the appearance of the tips of the perithecium from opposite sides, the blackened external branch broken in both,  $\times 260$ .  
*Laboulbenia Erogenidii* Thaxter. **Fig. 4.** Mature individual, the appendages considerably broken,  $\times 260$ . **Fig. 5.** Young individual with tuft of antheridia,  $\times 625$ .  
*Laboulbenia Pseudomasci* Thaxter. **Fig. 6.** Mature Type,  $\times 260$ .  
*Laboulbenia Madiræ* Thaxter. **Fig. 7.** Type form,  $\times 260$ .  
*Laboulbenia pallida* Thaxter. **Figs. 8-9.** Two individuals showing variation in appendages,  $\times 260$ .  
*Laboulbenia Oedodactyli* Thaxter. **Fig. 10.** The Type with simple outer appendage,  $\times 260$ .  
*Laboulbenia Ophoni* Thaxter. **Fig. 11.** The Type on *Ophonus sulphuripes*, Italy  $\times 260$ .  
*Laboulbenia Oopteri* Thaxter. **Fig. 12.** The Type: external branchlet broken off,  $\times 260$ .  
*Laboulbenia Coptæ* Thaxter.  $\times 260$ . **Fig. 13.** The Type.  
*Laboulbenia Orthomi* Thaxter. **Fig. 14.** The type form of compact habit,  $\times 260$ . **Fig. 15.** A more elongate variety,  $\times 260$ .  
*Laboulbenia Stomonaxi* Thaxter. **Figs. 16-17.** Two individuals, the perithecium of one containing mature spores,  $\times 260$ .  
*Laboulbenia melanaria* Thaxter. **Fig. 18.** The Type from *Ophonus germanus*, Portugal,  $\times 260$ .  
*Laboulbenia Dryptæ* Thaxter. **Fig. 19.** The Type,  $\times 260$ .  
*Laboulbenia erecta* Thaxter. **Fig. 20.** Individual from *Colpodes evanscens*, Mexico,  $\times 260$ . **Fig. 21.** Type on *C. agilis* from same locality,  $\times 260$ .

## PLATE LV.

- Laboulbenia dubia* Thaxter. **Fig. 1.** The Type,  $\times 260$ .  
*Laboulbenia Darwinii* Thaxter. **Fig. 2.** Type on *Pachyteles*, Brazil, Hope Collection No. 285,  $\times 260$ .  
*Laboulbenia olivacea* Thaxter. **Fig. 3.** The Type,  $\times 260$ .  
*Laboulbenia Anaplogeni* Thaxter. **Fig. 4.** The Type on *Anaplogeni*, China,  $\times 260$ . **Fig. 5.** Unusually well developed individual on *Stenolophus* from Cambridge, in which the segments of the branches are distally swollen, but which was associated with individuals normal in this respect,  $\times 260$ .  
*Laboulbenia Platyprosopi* Thaxter. **Fig. 6.** Type form,  $\times 260$ .  
*Laboulbenia Rougetii* Robin var. *Japanensis* Thaxter. **Fig. 7.** Typical form reduced as compared with other figures on the plate,  $\times 150$ .  
*Laboulbenia Rougetii* Robin var. *Chinensis* Thaxter. **Fig. 8.** Type form, reduced,  $\times 150$ .  
*Laboulbenia bilabiata* Thaxter. **Fig. 9.** The Type,  $\times 260$ .  
*Laboulbenia Anchonoderi* Thaxter. **Fig. 10.** Type on *Anchonoderus subæncus* from Panama,  $\times 260$ . **Fig. 11.** Form on *A. binotatus* from Guatemala,  $\times 260$ .  
*Laboulbenia Pericalli* Thaxter. **Fig. 12.** The Type,  $\times 260$ .  
*Laboulbenia Euchilæ* Thaxter. **Figs. 13-14.** Two type specimens,  $\times 260$ .  
*Laboulbenia Thyreopteri* Thaxter. **Fig. 15.** Variety from Borneo,  $\times 260$ . (See Plate LXIV, fig. 15, for normal type.)

## PLATE LVI.

- Laboulbenia insularis* Thaxter. **Fig. 1.** Mature Type,  $\times 260$ . **Fig. 2.** Young individual showing full development of outer appendage,  $\times 460$ .  
*Laboulbenia Latonæ* Thaxter. **Figs. 3-4.** Two well marked variations,  $\times 260$ .



- Laboulbenia Loxandri* Thaxter. **Fig. 5.** The Type,  $\times 260$ .  
*Laboulbenia Columbiana* Thaxter. **Fig. 6.** The Type on hairs from elytra of host,  $\times 260$ . **Fig. 7.** A large form from the abdomen of host, possibly a distinct species,  $\times 260$ .  
*Laboulbenia Bledii* Thaxter. **Figs. 8 & 10.** Individuals on *Bledius jacobinus* from California,  $\times 260$ . **Fig. 9.** Form on *B. basalis* from Florida,  $\times 260$ .  
*Laboulbenia pedicillata* Thaxter. **Fig. 11.** Form on *Dyschirius thoracicus* from Europe,  $\times 260$ .  
*Laboulbenia Egæ* Thaxter. **Fig. 12.** The Type,  $\times 260$ .  
*Laboulbenia notata* Thaxter. **Fig. 13.** The Type,  $\times 150$ .  
*Laboulbenia acanthophora* Thaxter. **Fig. 14.** The Type,  $\times 260$ .  
*Laboulbenia Tachyis* Thaxter. **Fig. 15.** Individual on *Tachys* from Cambridge,  $\times 260$ .  
*Laboulbenia verrucosa* Thaxter. **Fig. 16.** The Type,  $\times 260$ .  
*Laboulbenia microscopica* Thaxter. **Fig. 17.** The Type,  $\times 460$ .  
*Laboulbenia Chiriquensis* Thaxter. **Fig. 18.** The Type on *Callida scintillans*,  $\times 260$ .

## PLATE LVII.

- Laboulbenia Hawaiiensis* Thaxter. **Fig. 1.** Individual on *Colpodiscus tantalus* from Oahu,  $\times 260$ . **Fig. 2.** The Type on *Metromenus ero*, from Maui,  $\times 260$ . **Fig. 3.** Small form on *Mecyclothorax pusillus* from Maui,  $\times 260$ .  
*Laboulbenia sphyriopsis* Thaxter. **Fig. 5.** Type form on *Metromenus epicurus*,  $\times 260$ .  
*Laboulbenia Disenochi* Thaxter. **Fig. 4.** Form on *Disenochus sulcipennis* from Kauai of a type similar to that of *L. Hawaiiensis*,  $\times 260$ . **Fig. 6.** Form on *Anchonemus agonoides* from Maui,  $\times 260$ . **Fig. 7.** The Type on *Disenochus sulcipennis* from Kauai,  $\times 260$ .  
*Laboulbenia cauliculata* Thaxter. **Fig. 8.** Type on *Colpodiscus posticatus*, var. *concolor* Kauai,  $\times 260$ . **Fig. 9.** On *Metromenus* sp. (No. 1246) from Kauai,  $\times 260$ . **Fig. 10.** Individual from *Metromenus fraudator*, Maui,  $\times 260$ .  
*Laboulbenia cauliculata*, var. *prolixa* Thaxter. **Fig. 11.** Type on *Mesothriscus tricolor*,  $\times 260$ .  
*Laboulbenia cauliculata*, var. *spectabilis* Thaxter. **Fig. 12.** The Type on *Metromenus mutabilis*,  $\times 260$ .

## PLATE LVIII.

- Laboulbenia spiralis* Thaxter. **Fig. 1.** The Type,  $\times 260$ .  
*Laboulbenia Megalonychi* Thaxter. **Fig. 2.** The Type with pendent inner appendages,  $\times 260$ .  
*Laboulbenia obliquata* Thaxter. **Fig. 3.** The Type,  $\times 260$ .  
*Laboulbenia concinna* Thaxter. **Fig. 4.** Mature individual,  $\times 260$ .  
*Laboulbenia flaccida* Thaxter. **Fig. 5.** The Type,  $\times 260$ .  
*Laboulbenia Planetis* Thaxter. **Fig. 6.** The Type,  $\times 260$ .  
*Laboulbenia Eudaliæ* Thaxter. **Fig. 7.** Mature individual in which the primary branch of the outer appendage is broken off,  $\times 260$ . **Fig. 8.** Young individual showing structure of outer appendage,  $\times 260$ .  
*Laboulbenia Ceylonensis* Thaxter. **Fig. 9.** The Type in which part of the outer appendage is broken off,  $\times 260$ .  
**Fig. 10.** Part of young individual showing the outer appendage,  $\times 260$ .  
*Laboulbenia Helluodis* Thaxter. **Fig. 11.** The Type in which the outer appendage is partly broken,  $\times 260$ . **Fig. 12.** Young individual showing the appendages unbroken,  $\times 260$ .  
*Laboulbenia Tænodemæ* Thaxter. **Fig. 13.** The Type,  $\times 260$ .  
*Laboulbenia Formicarum* Thaxter. **Fig. 14.** The Type much enlarged,  $\times 625$ . **Fig. 15.** Individual magnified as in the other species represented on this plate showing its relatively small size,  $\times 260$ .

## PLATE LIX.

- Laboulbenia separata* Thaxter. **Figs. 1-2.** Two mature individuals the magnification greater than that of the other figures on this plate,  $\times 380$ .  
*Laboulbenia corethropsis* Thaxter. **Figs. 3-6.** Forms from *Miscelus Javanus* from Java showing variation,  $\times 225$ .  
*Laboulbenia protrudens* Thaxter. **Figs. 7-8.** Two type forms,  $\times 225$ .  
*Laboulbenia forficulata* Thaxter. **Figs. 9-10.** Mature individual in which the appendages are variously broken,  $\times 225$ . **Fig. 11.** Young individual.  
*Laboulbenia fissa* Thaxter. **Fig. 12.** The Type on *Pericallus flavoguttatus*. Hope Coll. No. 278,  $\times 225$ . **Fig. 13.** Individual on *P. guttatus*. Hope Coll. No. 301,  $\times 225$ .  
*Laboulbenia prominens* Thaxter. **Fig. 14.** The Type,  $\times 225$ .



- Laboulbenia distincta* Thaxter. **Figs. 15 16.** The Type and a young individual,  $\times 225$ .  
*Laboulbenia Maylayensis* Thaxter. **Figs. 17 18.** Mature Types seen from opposite sides,  $\times 225$ .  
*Laboulbenia Misceli* Thaxter. **Figs. 19 20.** The Types,  $\times 225$ .  
*Laboulbenia maculata* Thaxter. **Fig. 21.** Mature Type,  $\times 225$ . **Fig. 22.** Young individual,  $\times 225$ .  
*Laboulbenia Serrimarginis* Thaxter. **Fig. 23.** The Type,  $\times 225$ .  
*Laboulbenia imitans* Thaxter. **Figs. 24 25.** Types,  $\times 225$ . **Fig. 26.** Young individual,  $\times 225$ .

## PLATE LX.

- Laboulbenia tuberculifera* Thaxter. **Figs. 1 3.** Three individuals from different points of view,  $\times 225$ .  
*Laboulbenia Platystoma* Thaxter. **Fig. 4.** The Type,  $\times 225$ . **Fig. 5.** Detail of tip of perithecium,  $\times 650$ .  
*Laboulbenia corrugata* Thaxter. **Fig. 6.** The Type,  $\times 225$ . **Figs. 7 8.** Details of the tip of the perithecium from opposite sides,  $\times 650$ .  
*Laboulbenia leucophæa* Thaxter. **Figs. 9-10.** The Types seen from opposite sides,  $\times 225$ . **Fig. 11.** Detail of tip of perithecium,  $\times 650$ .  
*Laboulbenia microsoma* Thaxter. **Fig. 12.** The type,  $\times 225$ .  
*Laboulbenia Sumatrae* Thaxter. **Fig. 13.** Mature individual from *Catascopus cupripennis*, Borneo,  $\times 225$ .  
**Fig. 14.** The Type on same host from Sumatra,  $\times 225$ . **Figs. 15-16.** Detail of tips of two perithecia seen from opposite sides,  $\times 650$ .  
*Laboulbenia Jarana* Thaxter. **Figs. 17-18.** Mature individuals,  $\times 225$ . **Figs. 19 20.** Details of tips of two perithecia seen from opposite sides,  $\times 650$ .  
*Laboulbenia jinitima* Thaxter. **Fig. 21.** The Type on *Pericallus guttatus* from Java,  $\times 225$ . **Fig. 22.** Mature individual on *P. cærulescens* from Singapore,  $\times 225$ . **Fig. 23.** Variety found with the last on same host,  $\times 225$ .  
*Laboulbenia tenuis* Thaxter. **Figs. 24 25.** Types on *Misceclus* from New Guinea,  $\times 225$ . **Fig. 26.** Large form on *Catascopus* from Assam., India,  $\times 225$ .  
*Laboulbenia aristata* Thaxter. **Figs. 27-28.** The Types,  $\times 225$ . **Fig. 29.** Tip of perithecium enlarged,  $\times 650$ .  
*Laboulbenia subconstricta* Thaxter. **Figs. 30-31.** The Types,  $\times 225$ .  
*Laboulbenia Ceratophora* Thaxter. **Figs. 32-33.** The Types on *Misceclus* from New Guinea,  $\times 225$ . **Figs. 34 35.** Detail of tips of perithecia seen from opposite sides,  $\times 650$ .  
*Laboulbenia Assamensis* Thaxter. **Figs. 36 37.** The Types,  $\times 225$ . **Figs. 38-39.** Detail of tips of perithecia from different points of view,  $\times 650$ .

## PLATE LXI.

- Laboulbenia Papuana* Thaxter. **Fig. 1.** The Type,  $\times 260$ .  
*Laboulbenia insignis* Thaxter. **Fig. 2.** The Type: the tips of the branchlets are mostly broken,  $\times 260$ .  
*Laboulbenia Lebie* Thaxter. **Fig. 3.** The Type growing at the base of the posterior legs,  $\times 260$ . **Fig. 4.** Smaller form growing on legs,  $\times 260$ .  
*Laboulbenia Clivinalis* Thaxter. **Fig. 5.** The Type on *Clivina collaris* from England,  $\times 260$ . **Fig. 6.** An individual from *Clivina fossor* showing secondary divisions of cell V and of the lower cells of the appendages,  $\times 260$ .  
*Laboulbenia Oedichiri* Thaxter. **Fig. 7.** The Type,  $\times 260$ .  
*Laboulbenia dentifera* Thaxter. **Fig. 8.** Unique Type,  $\times 260$ .  
*Laboulbenia pullescens* Thaxter. **Fig. 9.** Type on *Clivina fasciata* from Guatemala,  $\times 260$ . **Fig. 10.** An individual from *C. dibutipennis* from Mexico,  $\times 260$ .  
*Laboulbenia barbata* Thaxter. **Fig. 11.** The Type on *Morio Georgiæ* from Mexico,  $\times 260$ .  
*Laboulbenia Madagascarensis* Thaxter. **Fig. 12.** The Type,  $\times 260$ .  
*Laboulbenia uncinata* Thaxter. **Fig. 13.** Individual on *Harpalus* sp. from York, Maine,  $\times 260$ .

## PLATE LXII.

- Laboulbenia Trichognathi* Thaxter. **Fig. 1.** The Type, a mature specimen,  $\times 150$ . **Fig. 2.** Younger individual,  $\times 150$ .  
*Laboulbenia media* Thaxter. **Fig. 3.** The Type,  $\times 260$ . **Fig. 4.** Detail of antheridial branch,  $\times 625$ .  
*Laboulbenia speciosa* Thaxter. **Fig. 5.** The Type on *Galerita unicolor* from Brazil,  $\times 260$ .  
*Laboulbenia pygmaea* Thaxter. **Fig. 6.** The Type,  $\times 260$ .  
*Laboulbenia adunca* Thaxter. **Fig. 7.** Type,  $\times 260$ . **Figs. 8-9.** Detail of the tips of the perithecium from opposite sides,  $\times 625$ .  
*Laboulbenia minimalis* Thaxter. **Figs. 10-11.** Two individuals on *Galerita* from Guyaquil,  $\times 260$ .



- Laboulbenia curvata* Thaxter. **Fig. 12.** The Type,  $\times 260$ .  
*Laboulbenia bicolor* Thaxter. **Fig. 13.** Form on *Galerita carbonaria* from Brazil,  $\times 260$ . **Fig. 14.** The Type on *Galerita* sp. from Venezuela,  $\times 260$ . **Fig. 15.** Detail of antheridial branch,  $\times 625$ .  
*Laboulbenia Colpodis* Thaxter. **Fig. 16.** The Type,  $\times 260$ .  
*Laboulbenia corniculata* Thaxter. **Fig. 17.** The Type,  $\times 260$ .

## PLATE LXIII.

- Laboulbenia Cafii* Thaxter. **Fig. 1.** Mature individual from southern California,  $\times 260$ . **Fig. 2.** Young individual with trichogyne,  $\times 260$ .  
*Laboulbenia Texana*, var. *pendula* Thaxter. **Fig. 3.** The Type,  $\times 150$ .  
*Laboulbenia Texana* var. *iucurvata* Thaxter. **Fig. 4.** The Type,  $\times 150$ .  
*Laboulbenia Texana* var. *rostellata* Thaxter. **Fig. 5.** Type on *Brachinus geniculatus* from Montevideo,  $\times 150$ .  
*Laboulbenia Texana* var. *retusa* Thaxter. **Fig. 6.** The Type from Florida,  $\times 150$ .  
*Laboulbenia Texana* var. *Oaxacana* Thaxter. **Fig. 7.** Unique Type,  $\times 150$ .  
*Laboulbenia Texana*, var. *suffusa* Thaxter. **Fig. 8.** The Type,  $\times 150$ .  
*Laboulbenia Texana* var. *tibialis* Thaxter. **Fig. 9.** The Type,  $\times 150$ .  
*Laboulbenia tortuosa* Thaxter. **Fig. 10.** The Type,  $\times 225$ .  
*Laboulbenia Ozenae* Thaxter. **Fig. 11.** The Type,  $\times 225$ .  
*Laboulbenia punctulata* Thaxter. **Fig. 12.** The Type,  $\times 225$ .  
*Laboulbenia Helluomorphae* Thaxter. **Fig. 13.** Individual from *Pleuracanthus brevicollis* from Surinam,  $\times 225$ .  
**Fig. 14.** The Type on *Helluomorpha melanaria* from the Amazon,  $\times 225$ .  
*Laboulbenia triordinata* Thaxter. **Fig. 15.** The Type on *Cordistes bicinctus* from Columbia,  $\times 150$ .  
*Laboulbenia angularis* Thaxter. **Fig. 16.** The Type,  $\times 225$ . **Fig. 17.** Detail of tip of perithecium from another individual,  $\times 625$ .  
*Laboulbenia perplexa* Thaxter. **Fig. 18.** Type form,  $\times 260$ .

## PLATE LXIV.

- Laboulbenia incerta* Thaxter. **Fig. 1.** Mature individual, Brazil,  $\times 260$ .  
*Laboulbenia geniculata* Thaxter. **Fig. 2.** The type from Rosario, Argentina,  $\times 260$ . **Fig. 3.** Tip of perithecium enlarged,  $\times 625$ .  
*Laboulbenia fusiformis* Thaxter. **Fig. 4.** The type from Brazil,  $\times 150$ .  
*Laboulbenia subpunctata* Thaxter. **Fig. 5.** Mature individual from the Amazon,  $\times 260$ . **Fig. 6.** Type from Rosario, Argentina,  $\times 260$ .  
*Laboulbenia punctata* Thaxter. **Fig. 7.** Type from Venezuela.  
*Laboulbenia Pheropsophi* Thaxter. **Fig. 8.** Eastern variety from Java,  $\times 260$ . **Fig. 9.** Group of antheridia of the same,  $\times 625$ .  
*Laboulbenia longicollis* Thaxter. **Fig. 10.** Perfect individual from Mt. Coffee, Liberia, Africa,  $\times 260$ .  
*Laboulbenia decipiens* Thaxter. **Fig. 11.** Variety from the Amazon,  $\times 260$ . **Fig. 12.** The typical small South American form from Columbia,  $\times 260$ .  
*Laboulbenia producta* Thaxter. **Fig. 13.** Fully matured individual from an undetermined host in the Museo Nacional at Buenos Aires,  $\times 260$ . **Fig. 14.** A younger individual from Columbia,  $\times 260$ .  
*Laboulbenia Thyreopteri* Thaxter. **Fig. 15.** The type from Port Natal, Africa,  $\times 225$ .  
*Laboulbenia heterocheila* Thaxter. **Fig. 16.** Detail of the tip of the perithecium of a mature individual from Timor, East Indies,  $\times 625$ .

## PLATE LXV.

- Laboulbenia Polyhirmæ* Thaxter. **Fig. 1.** Short stout form on *Polyhirma* sp. from Tangar, Africa,  $\times 260$ .  
**Fig. 2.** Form with peculiarly differentiated tip on *P. hamifera* from Zanzibar,  $\times 260$ . **Fig. 3.** The Type from Tangar,  $\times 260$ .  
*Laboulbenia orientalis* Thaxter. **Fig. 4.** Form with well developed appendages but not fully mature on *Brachinus scotomedes* from Japan,  $\times 150$ . **Fig. 5.** Small curved form on *B. Chinensis*, Hong Kong, on inferior surface of prothorax,  $\times 260$ .  
*Laboulbenia pusilla* Thaxter. **Fig. 6.** The Type,  $\times 260$ .  
*Laboulbenia Japonica* Thaxter. **Fig. 7.** The Type,  $\times 260$ .  
*Laboulbenia rhinophora* Thaxter. **Fig. 8.** The Type: a mature individual in which the appendages are almost wholly broken off,  $\times 260$ . **Fig. 9.** A young individual in which the appendages are almost intact,  $\times 260$ .



*Laboulbenia equatorialis* Thaxter. **Fig. 10.** The Type,  $\times 150$ . **Fig. 11.** Portion of appendage enlarged showing character and origin of the antheridial branchlets and the antheridia,  $\times 500$ .

*Laboulbenia falcata* Thaxter. **Fig. 12.** The Type,  $\times 260$ .

*Laboulbenia celestialis* Thaxter. **Fig. 13.** The Type on *Drypta lineola* from China,  $\times 260$ . **Fig. 14.** Variety on *Dichranonchus* sp. from Japan,  $\times 260$ .

*Laboulbenia Asiatica* Thaxter. **Fig. 15.** Typical form,  $\times 260$ .

## PLATE LXVI.

*Laboulbenia gibbifera* Thaxter. **Fig. 1.** The Type,  $\times 260$ .

*Laboulbenia Dercyli* Thaxter. **Fig. 2.** The Type,  $\times 260$ . **Fig. 3.** Insertion-cells of young individual showing detail of appendages,  $\times 461$ .

*Laboulbenia melanopus* Thaxter. **Fig. 4.** Mature individual with the appendages much broken,  $\times 260$ . **Fig. 5.** Distal portion of a young individual showing the appendages in better condition,  $\times 461$ .

*Laboulbenia Acrogenys* Thaxter. **Figs. 6-7.** The Types,  $\times 260$ . **Fig. 8.** Portion of an antheridial branch enlarged,  $\times 625$ .

*Laboulbenia Italica* Thaxter. **Fig. 9.** The Type,  $\times 260$ . **Fig. 10.** An antheridial branchlet enlarged,  $\times 625$ .

*Laboulbenia Cubensis* Thaxter. **Fig. 11.** The Type,  $\times 260$ . **Fig. 12.** Tip of the perithecium in a larger specimen seen from the opposite side,  $\times 260$ . **Fig. 13.** An appendage showing the insertions of numerous branchlets,  $\times 461$ .

*Laboulbenia anomala* Thaxter. **Fig. 14.** The Type: its appendages somewhat broken,  $\times 260$ . **Fig. 15.** Young individual from the Zambesi,  $\times 260$ .

*Laboulbenia constricta* Thaxter. **Fig. 16.** Mature individual,  $\times 260$ .

*Laboulbenia coarctata* Thaxter. **Fig. 17.** Mature individual,  $\times 260$ .

*Laboulbenia aquatica* Thaxter. **Fig. 18.** The Type,  $\times 260$ . **Fig. 19.** An appendage with antheridia,  $\times 615$ .

*Laboulbenia strangulata* Thaxter. **Fig. 20.** The Type from Timor,  $\times 260$ .

## PLATE LXVII.

*Laboulbenia bicornis* Thaxter. **Fig. 1.** The Type,  $\times 260$ . **Fig. 2.** Posterior view of tip of perithecium,  $\times 460$ .

*Laboulbenia dactylophora* Thaxter. **Fig. 3.** Small form on *Orectogyros ornaticollis* from Madagascar,  $\times 260$ .

**Fig. 4.** The Type on *O. specularis* from the Gold Coast, Africa,  $\times 260$ .

*Laboulbenia drepanalis* Thaxter. **Fig. 5.** The Type from the Amazon, its appendages almost wholly broken off. **Fig. 6.** A smaller form from Bugaba, Mexico,  $\times 260$ .

*Laboulbenia denticulata* Thaxter. **Fig. 7.** The Type,  $\times 260$ . **Fig. 8.** Branch of an appendage,  $\times 625$ . **Fig. 9.** Tip of the perithecium from opposite side to that seen in fig. 7,  $\times 625$ .

*Laboulbenia Orectochili* Thaxter. **Fig. 10.** Individual on *Orectochilus oblongiusculus* from Pedong having but two appendages,  $\times 260$ . **Fig. 11.** The Type on *O. cordatus*,  $\times 260$ .

*Laboulbenia denticulata* Thaxter Var. **Fig. 12.** Mature individual on *Macrogyrus elongatus* from New Guinea,  $\times 260$ . **Fig. 13.** Detail of tip of perithecium,  $\times 461$ .

*Laboulbenia fallax* Thaxter. **Fig. 14.** The Type. The tips of some of the appendages are supplied,  $\times 260$ .

**Fig. 15.** An appendages with the insertions of two broken branchlets,  $\times 625$ .

*Laboulbenia rotundata* Thaxter. **Fig. 16.** The Type,  $\times 260$ .

*Laboulbenia Dineutis* Thaxter. **Fig. 17.** The Type. A small individual on *Dineutes* sp. from Pondicherry,  $\times 260$ . **Fig. 18.** Detail of the tip of the perithecium,  $\times 625$ .

*Laboulbenia chætophora* Thaxter. **Fig. 19.** The Type,  $\times 260$ .

## PLATE LXVIII.

*Hydrophilomyces rhyncophorus* Thaxter. **Figs. 1-2.** Two mature individuals seen from different points of view and varying in the development of their receptacles. The terminal portions of the appendages are in part broken,  $\times 270$ . **Fig. 3.** Basal portion of an appendage in a young individual showing structures supposed to be antheridia. **Fig. 4.** A supposed antheridium enlarged.

*Rhyncophoromyces elephantinus* Thaxter. **Fig. 5.** The type,  $\times 230$ .

*Ceratomyces Californicus* Thaxter. **Fig. 6.** A perfect mature individual from Maine,  $\times 290$ . **Fig. 7.** The type from California,  $\times 290$ .

*Autoicomycetes acuminatus* Thaxter. **Fig. 8.** The type,  $\times 290$ .



## PLATE LXIX.

- Ceratomyces curvatus* Thaxter. **Fig. 1.** The type,  $\times 270$ .  
*Ceratomyces cladophorus* Thaxter. **Fig. 2.** Mature type,  $\times 270$ .  
*Hydrophilomyces reflexus* Thaxter. **Fig. 3.** The type showing bulbous insertion.  
*Ceratomyces ansatus* Thaxter. **Fig. 4.** The type from Brazil,  $\times 270$ . **Fig. 5.** Individual from Florida with distal branchlets developed from the appendages,  $\times 270$ .  
*Ceratomyces procerus* Thaxter. **Fig. 6.** The Type, from Brazil.  
*Autoicomyces ornithocephalus* Thaxter. **Figs. 7-8.** Mature individuals seen from opposite sides,  $\times 290$ . **Fig. 9.** Spore,  $\times 500$ .

## PLATE LXX.

- Rhynchophoromyces denticulatus* Thaxter. **Fig. 1.** Mature individual,  $\times 270$ .  
*Ceratomyces Braziliensis* Thaxter. **Fig. 2.** The Type,  $\times 270$ .  
*Ceratomyces Mexicanus* Thaxter. **Fig. 3.** The Type,  $\times 270$ .  
*Ceratomyces Floridanus* Thaxter. **Fig. 4.** The Type,  $\times 270$ .  
*Ceratomyces spinigerus* Thaxter. **Fig. 5.** The Type,  $\times 270$ . **Fig. 6.** Posterior view of the tip of the perithecium,  $\times 600$ .  
*Misgomyces Stomonaxi* Thaxter. **Figs. 7-8.** The Types,  $\times 290$ . **Fig. 8.** Young individual.  
*Misgomyces Dyschirii* Thaxter. **Figs. 9-10.** Mature individuals,  $\times 290$ .

## PLATE LXXI.

- Distichomyces Leptochiri* Thaxter. **Figs. 1-3.** Mature individuals of various form,  $\times 290$ . **Fig. 4.** Young individual with primary terminal appendage and single antheridial branch at left,  $\times 625$ . **Fig. 5.** An antheridial branch with terminal group of six antheridia,  $\times 1800$ . **Fig. 6.** Younger individual showing the first division in the subbasal cell,  $\times 1090$ .  
*Coreomyces curvatus* Thaxter. **Fig. 7.** Mature individual,  $\times 290$ . **Fig. 8.** Young individual. Portion above appendiculate cells before the endogenous formation of the procarp has begun,  $\times 625$ . **Fig. 9.** A later stage in which the branches destined to form the procarp and the endogenous perithecium have begun to arise distally from the third cell and are growing into the cavity of the fourth,  $\times 625$ . **Fig. 10.** A later stage of the same in which the procarpic branch having outstripped the others has grown through the cells above and is about to perforate the tip,  $\times 625$ . **Fig. 11.** A later stage showing the antheridial appendages below and the procarpic branch above, which has perforated the terminal cell and has formed a short branched trichogyne,  $\times 625$ . **Fig. 12.** A similar stage enlarged showing the origin of the procarp and of a sterile branch, wall-cell branch, from a common basal cell,  $\times 1060$ . **Fig. 13.** One of the antheridial branches showing the formation of antherozoids from undifferentiated cells of the branch,  $\times 1060$ . **Fig. 14.** Rhizoid-like foot spreading on surface of wing,  $\times 1060$ . **Fig. 15.** Spore,  $\times 615$ .  
*Coreomyces Corisæ* Thaxter. **Fig. 16.** Mature individual,  $\times 290$ . **Fig. 17.** Young individual before development of perithecial or procarpic branch,  $\times 500$ . **Fig. 18.** Spore,  $\times 625$ .  
*Autoicomyces falciferus* Thaxter. **Fig. 19.** Mature individual,  $\times 290$ .  
*Kainomyces Isomali* Thaxter. **Figs. 20-21.** Mature individuals,  $\times 290$ . **Fig. 22.** Young individual with two peritheciigerous branches beginning to develop at the right,  $\times 500$ .  
*Euzodiomyces Lathrobii* Thaxter. **Fig. 23.** The Type,  $\times 290$ .



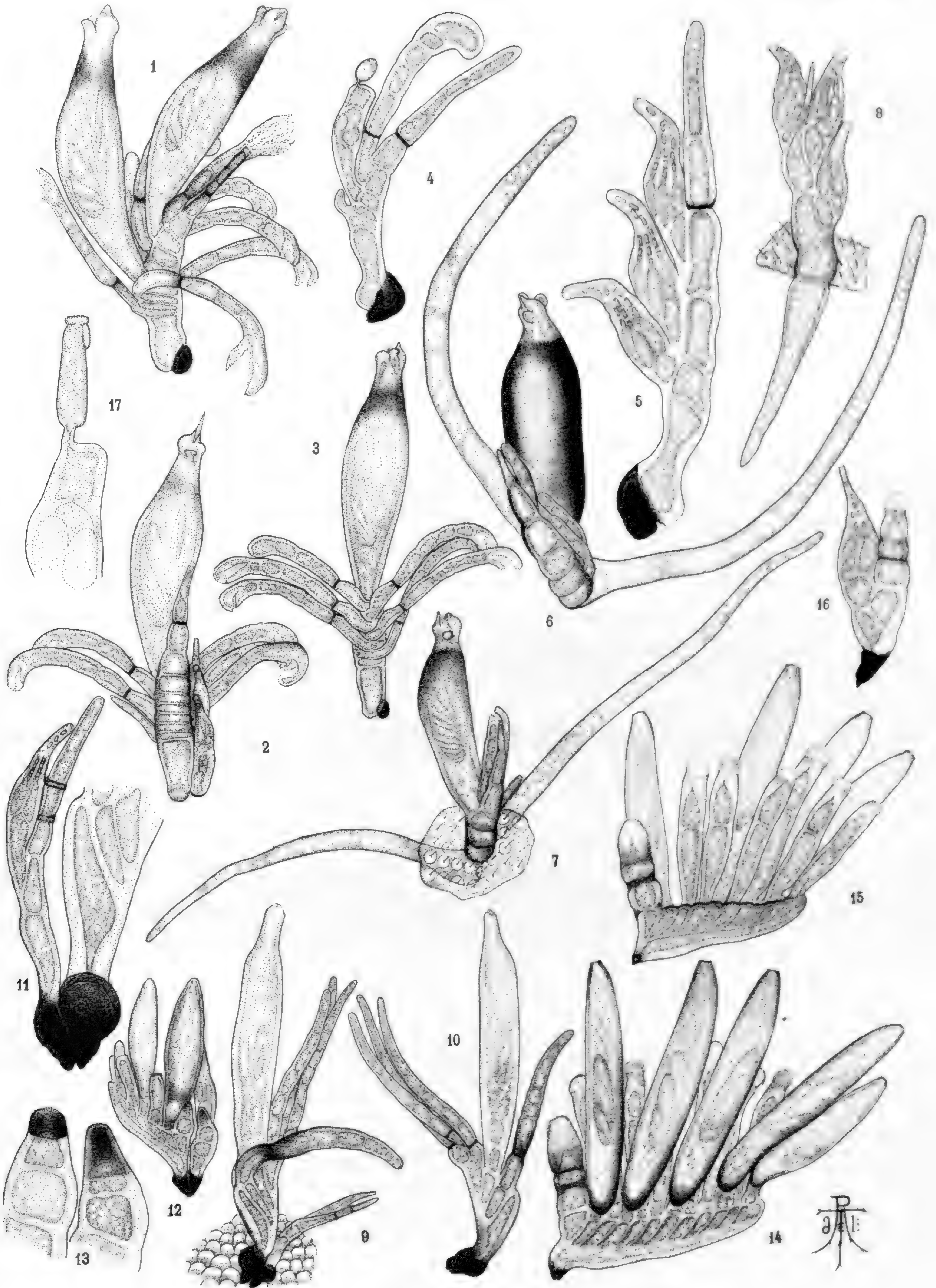

THAXTER.—LABOULBENIACEAE



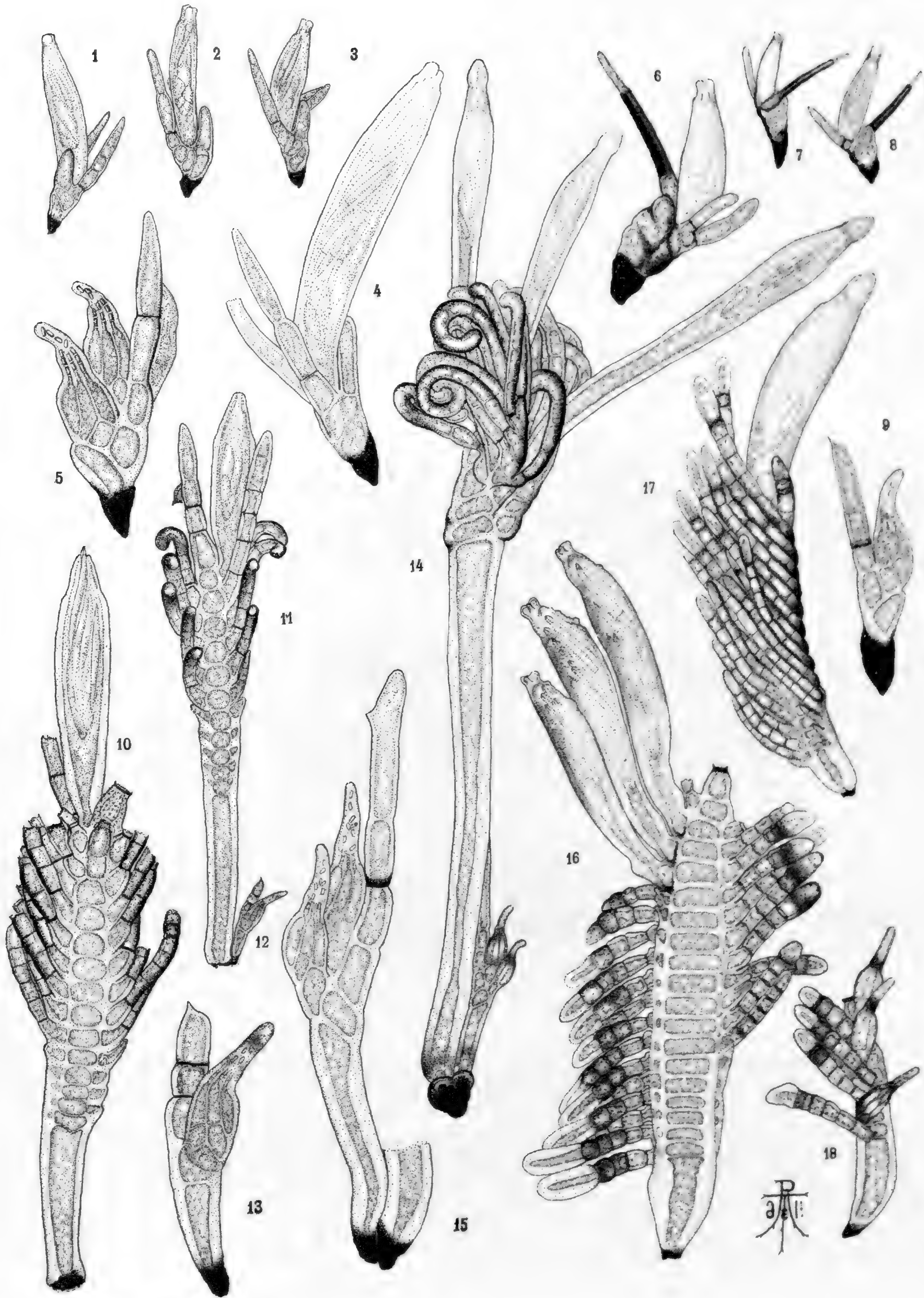



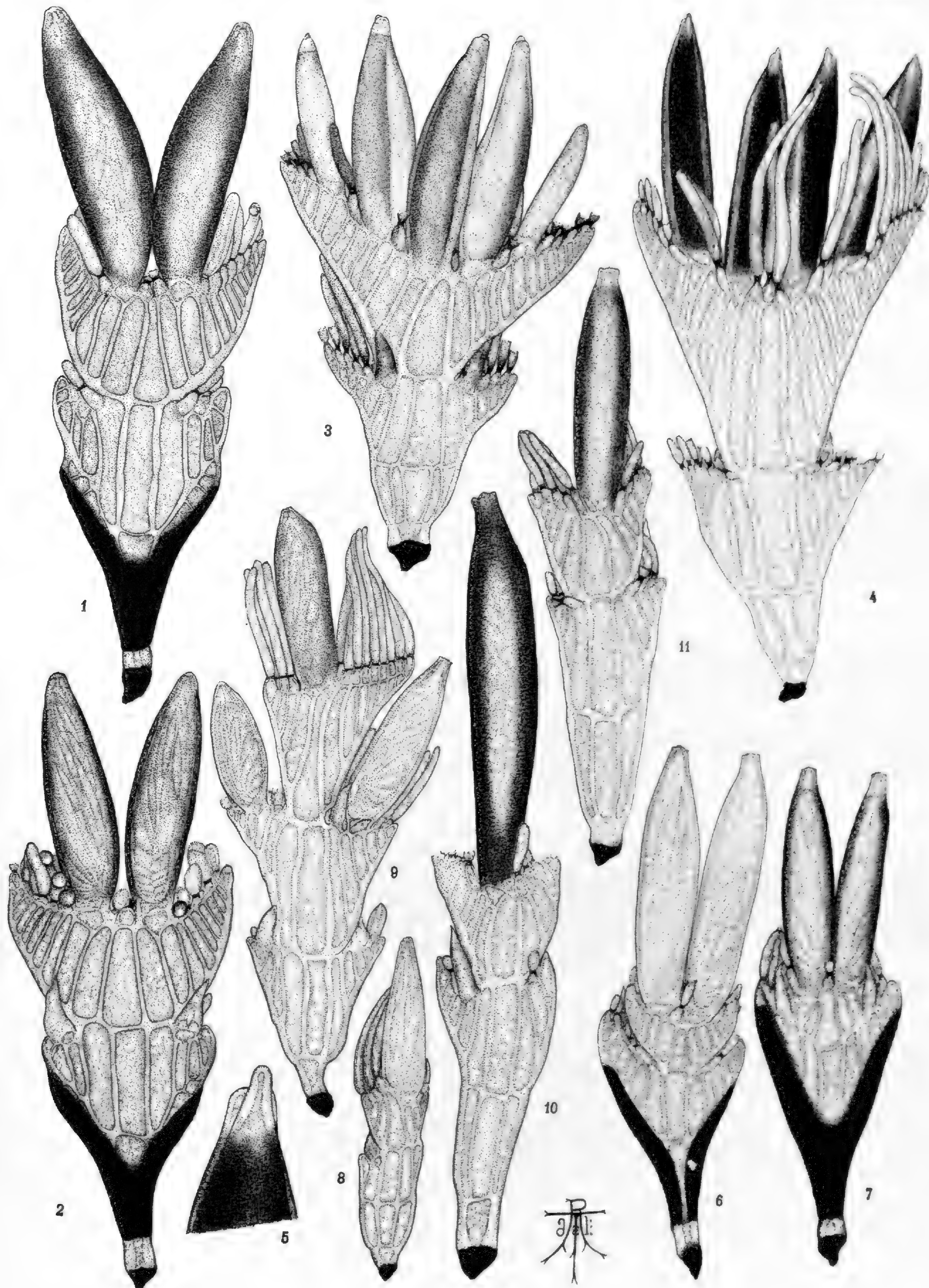



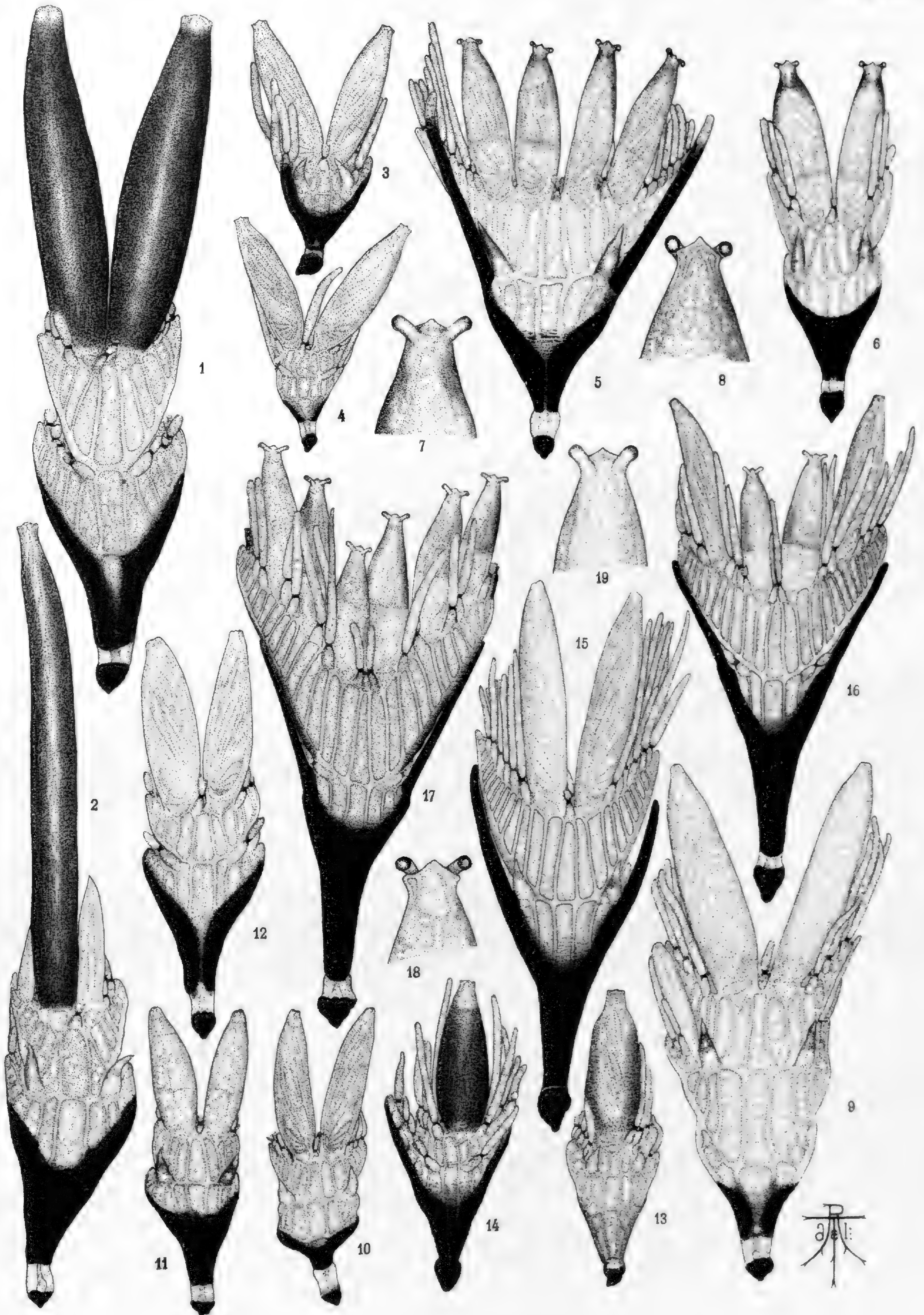



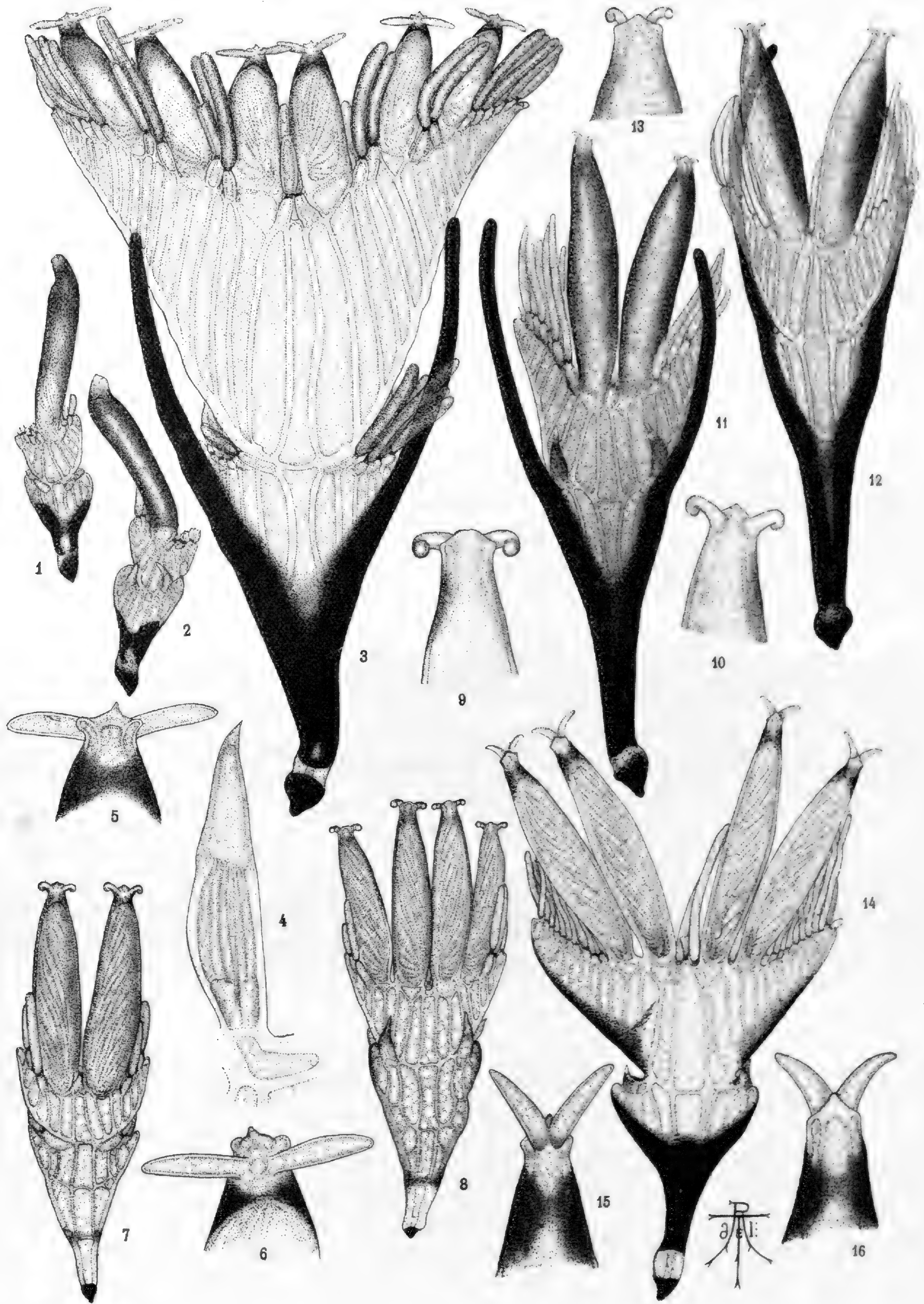



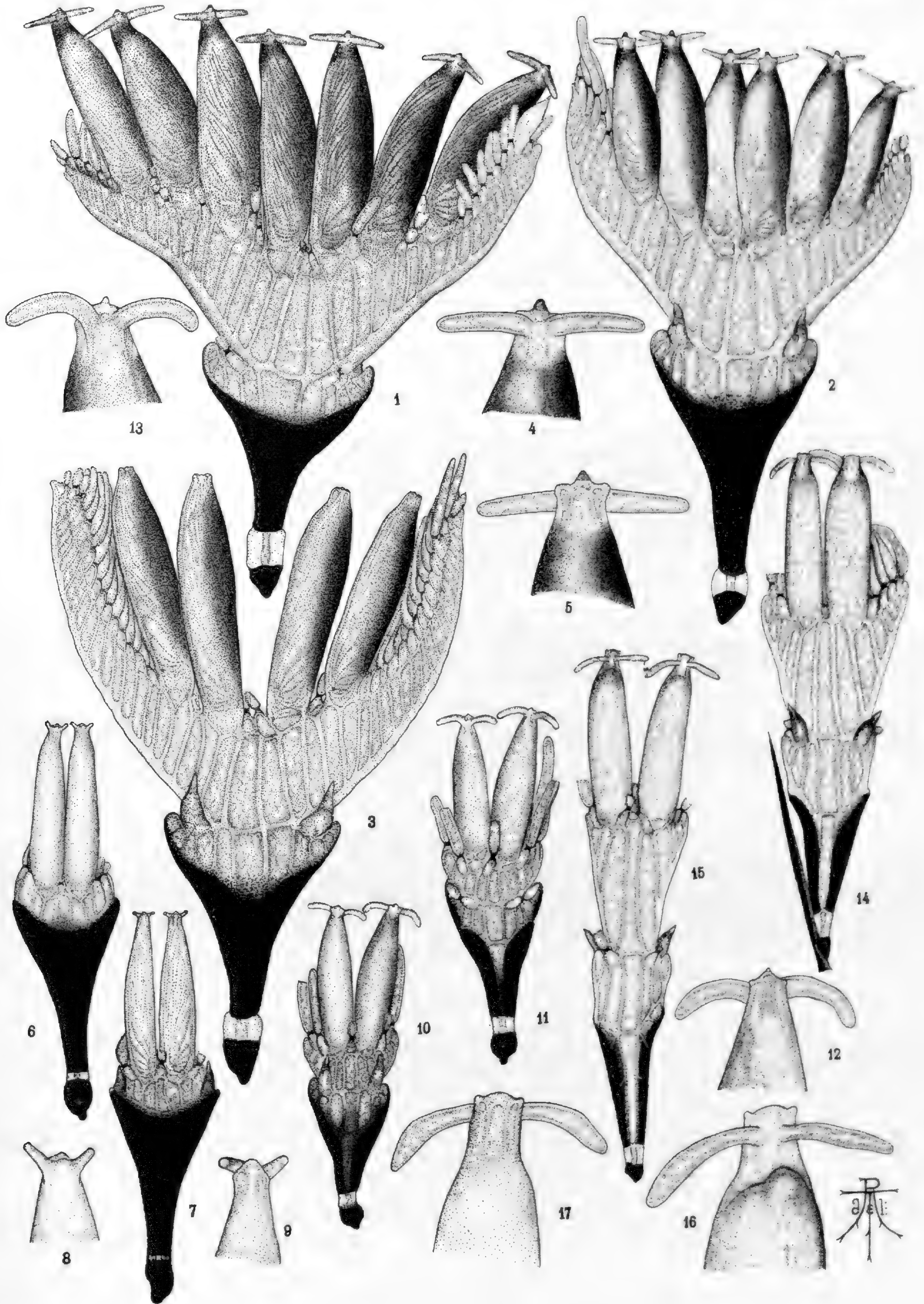



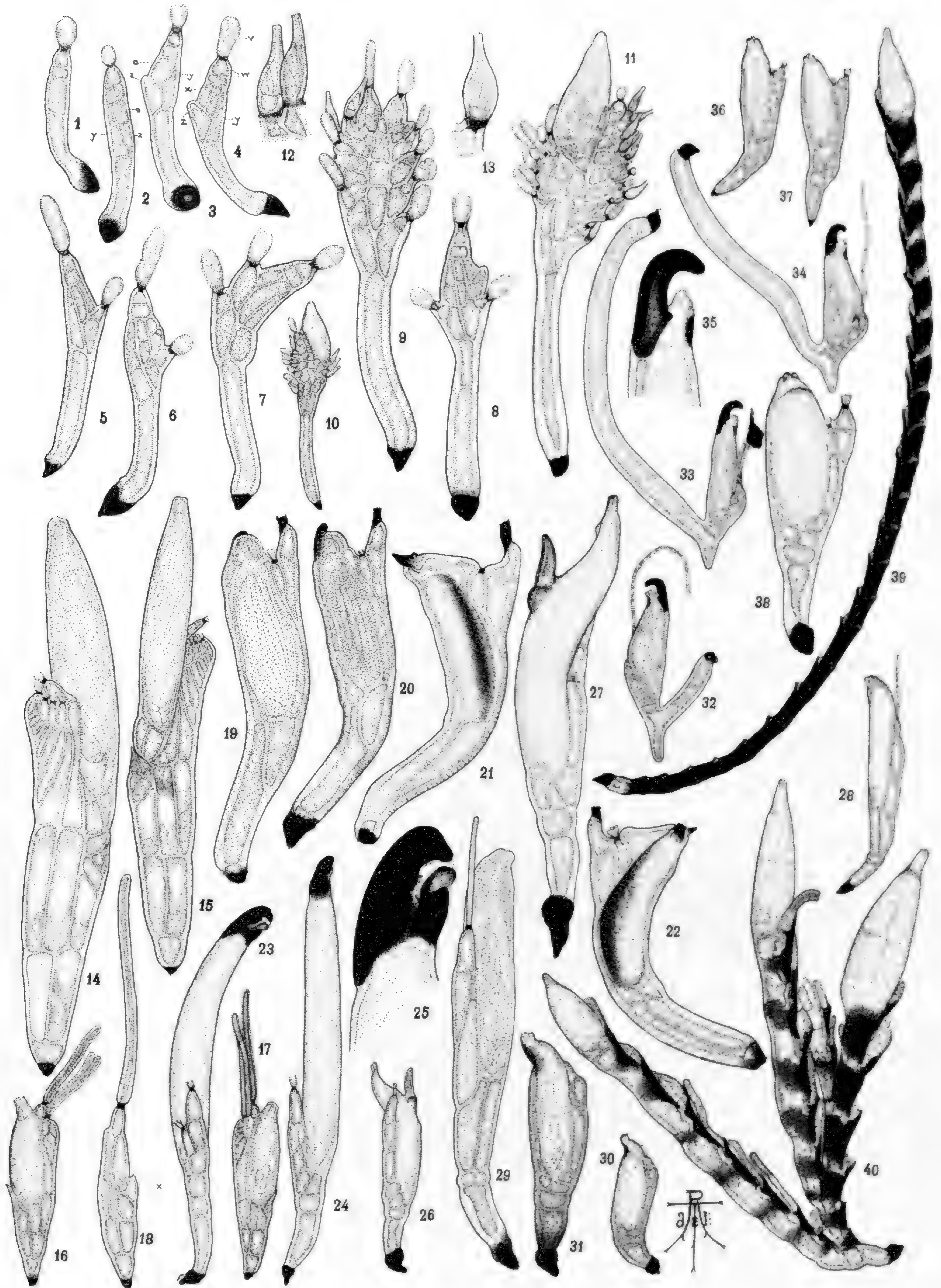







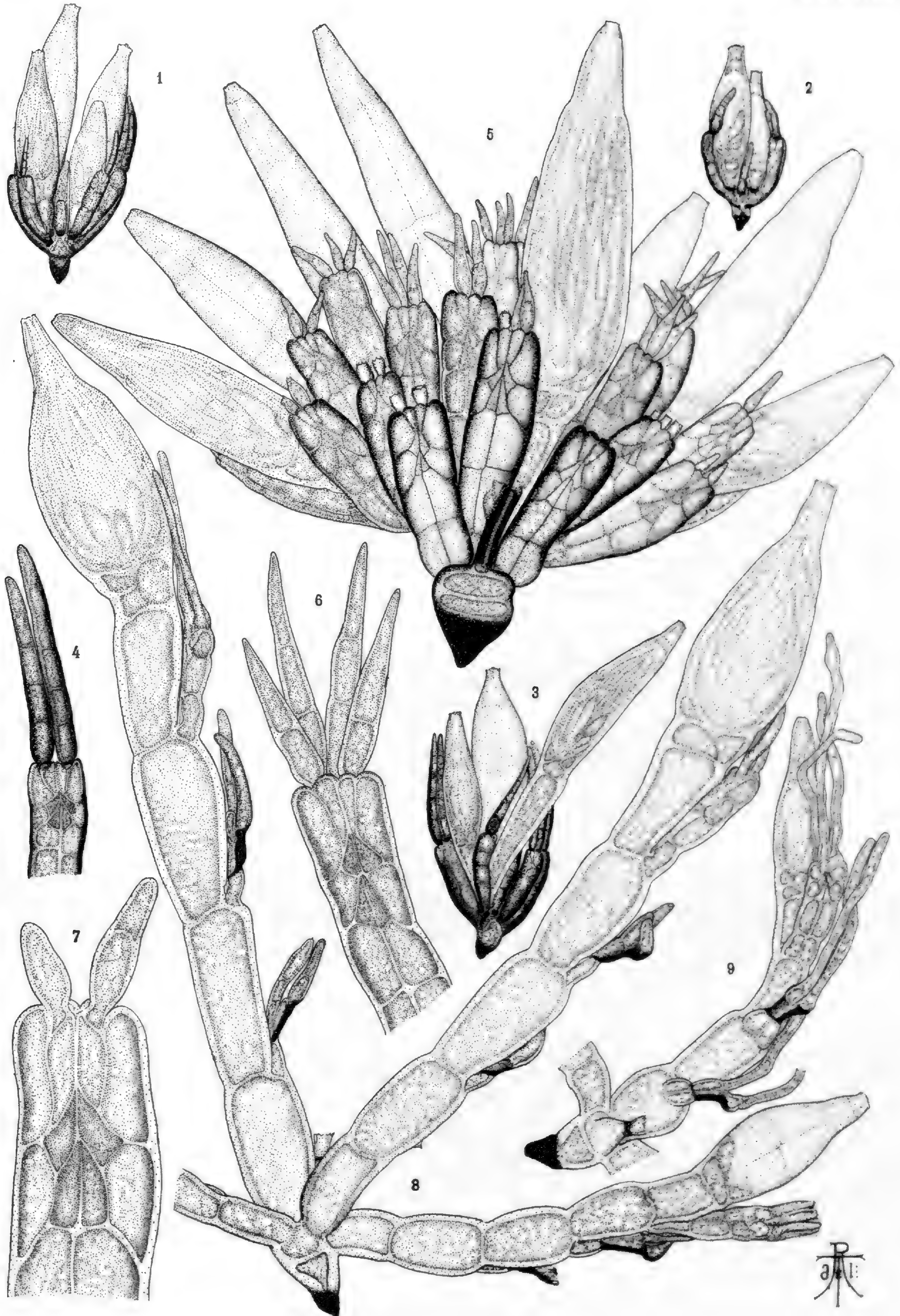



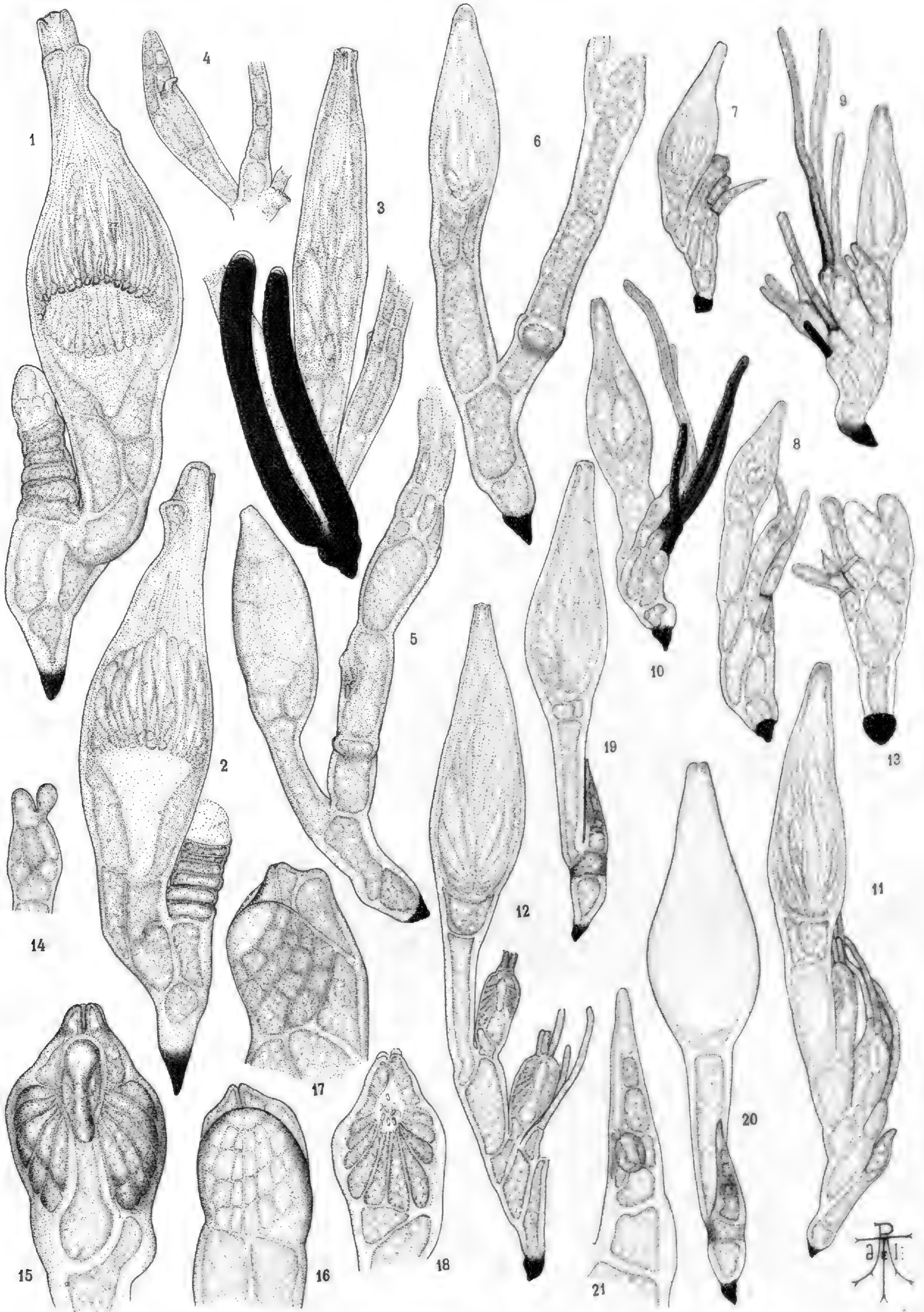



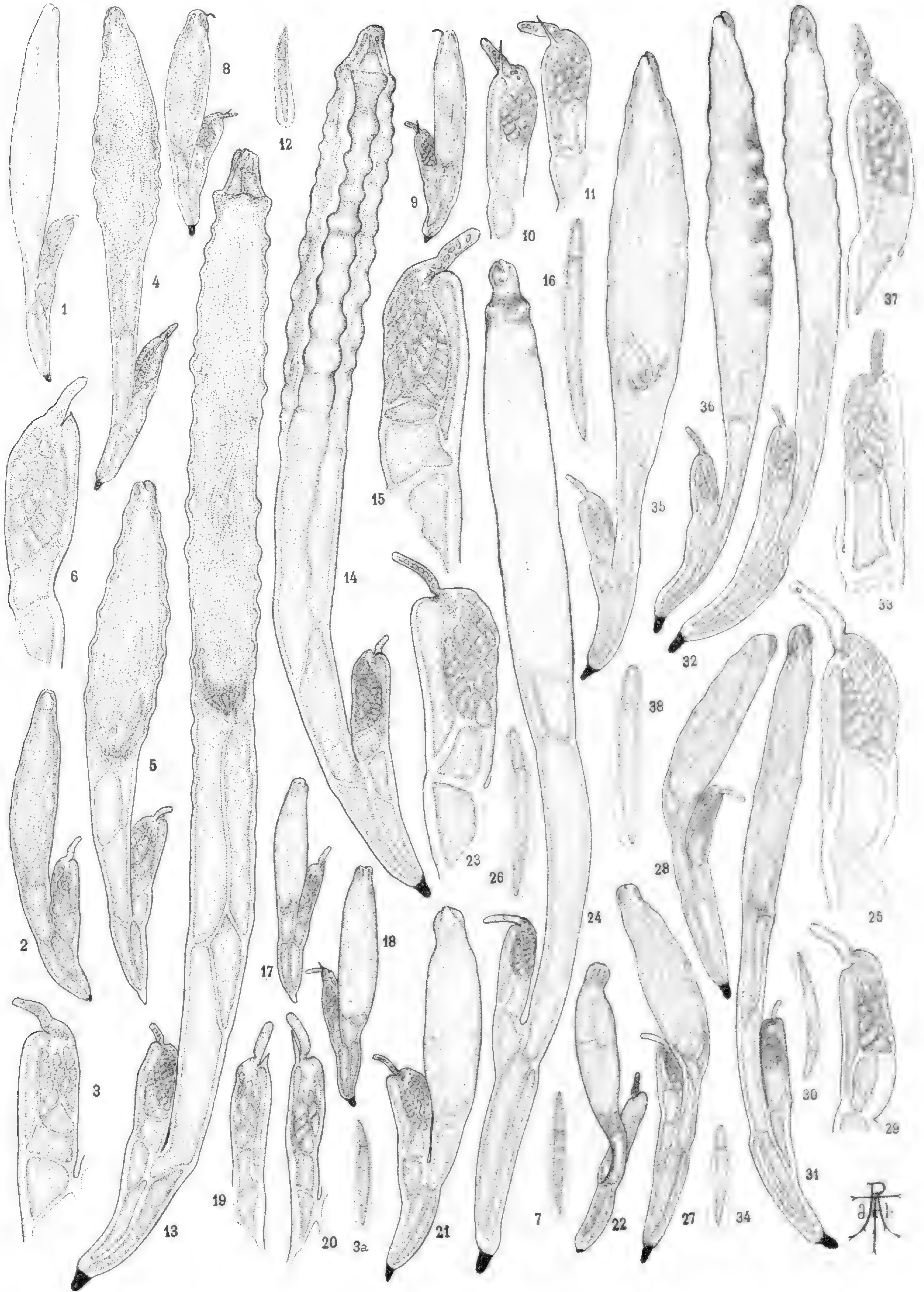



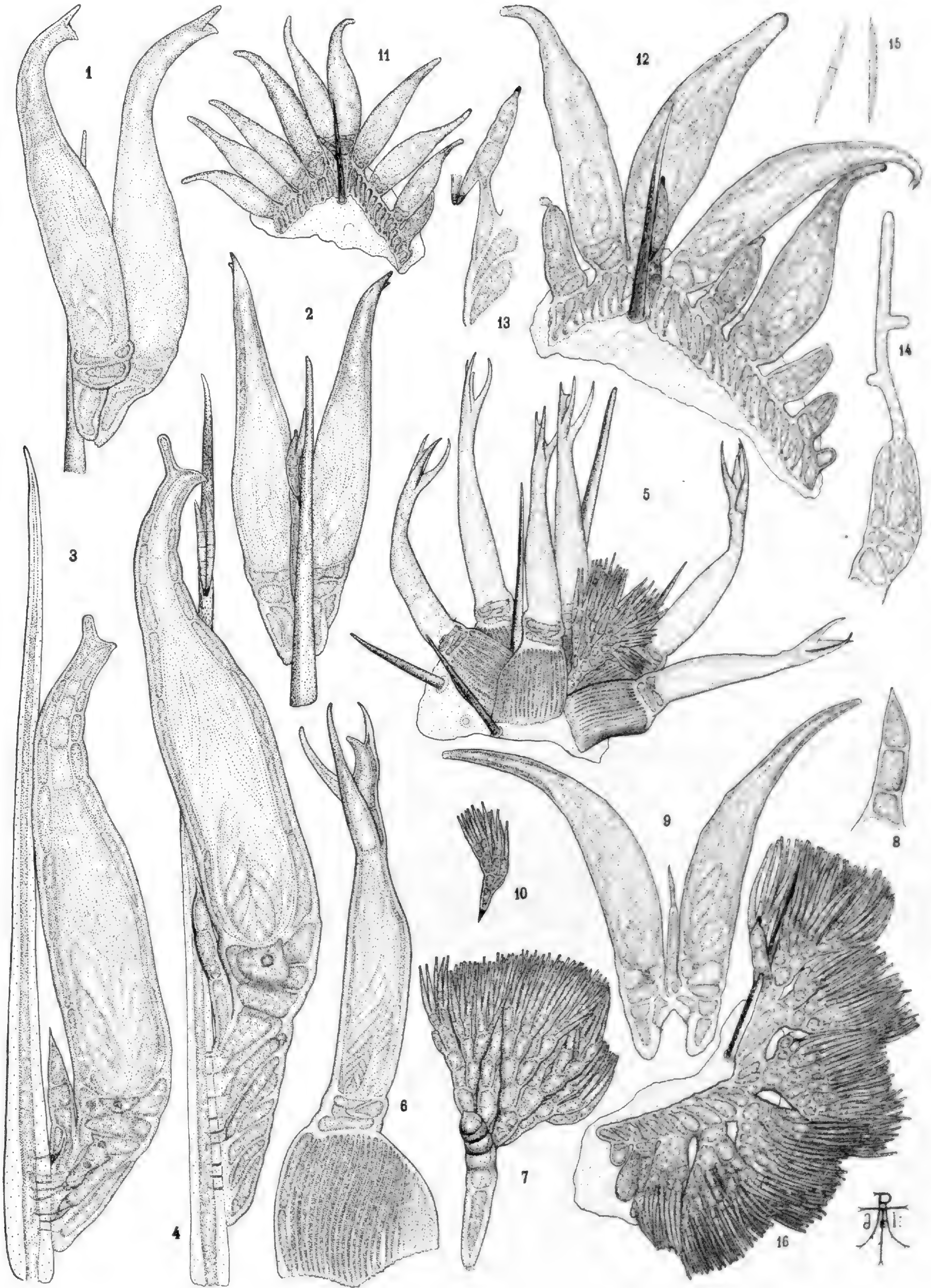



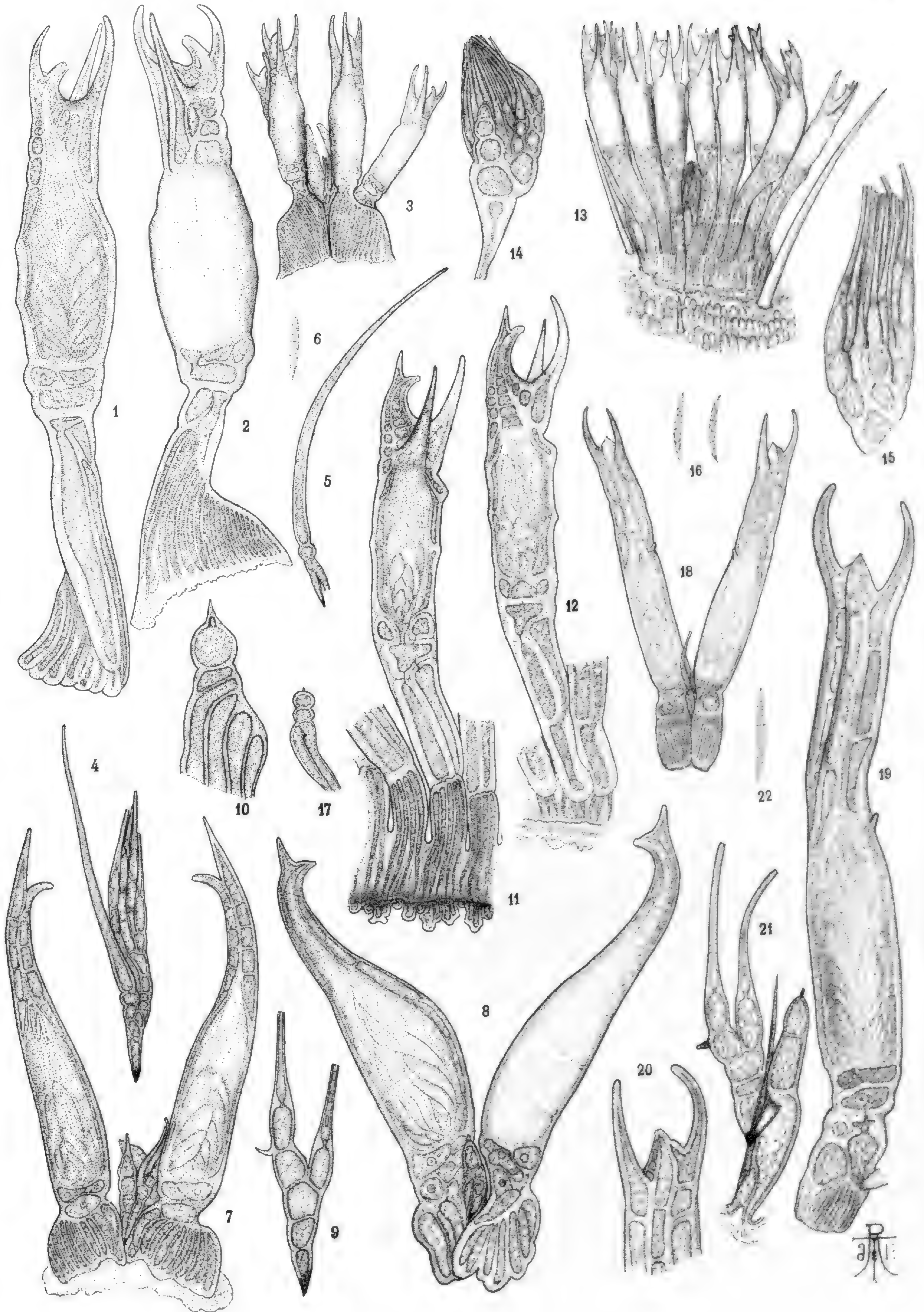



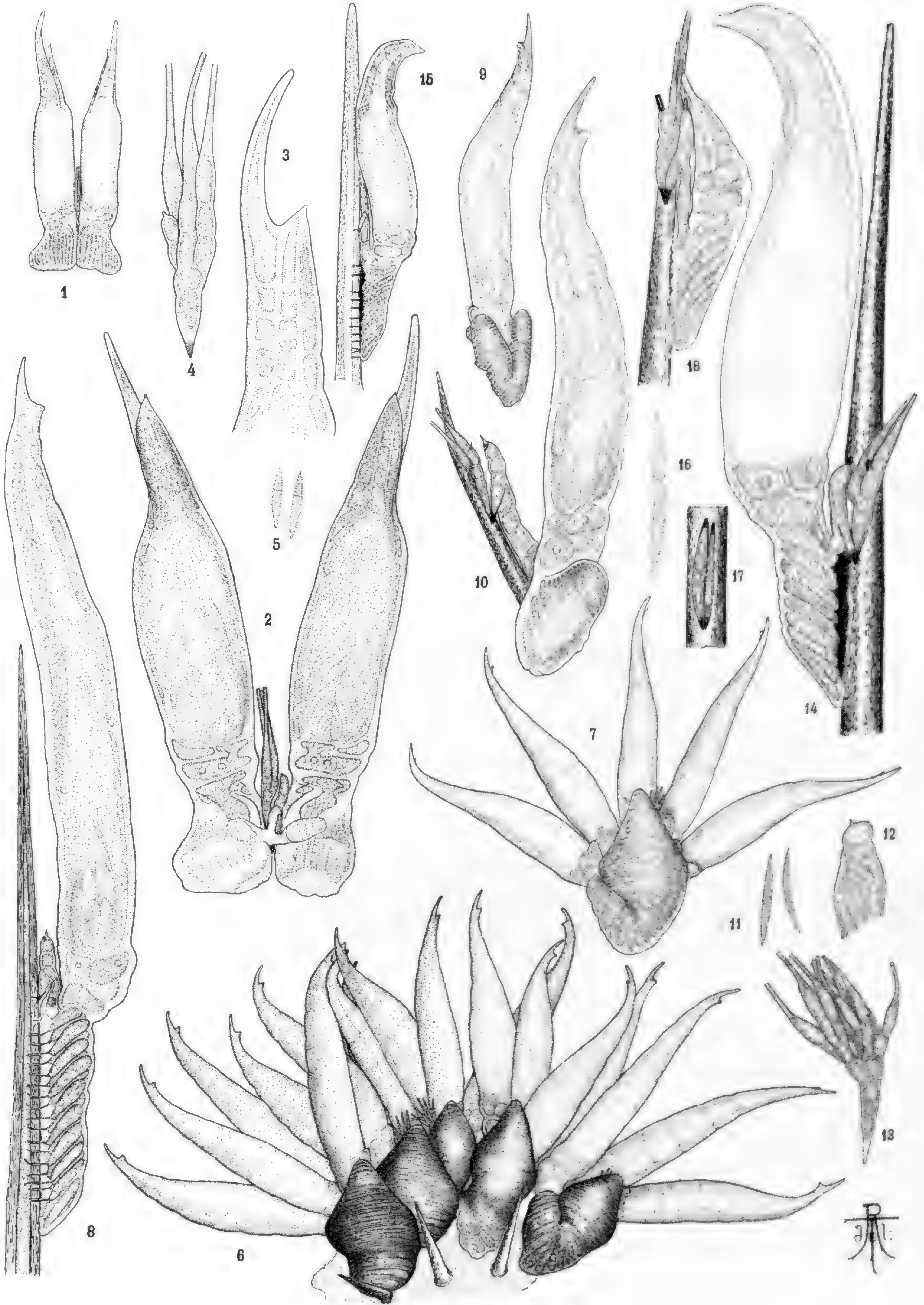



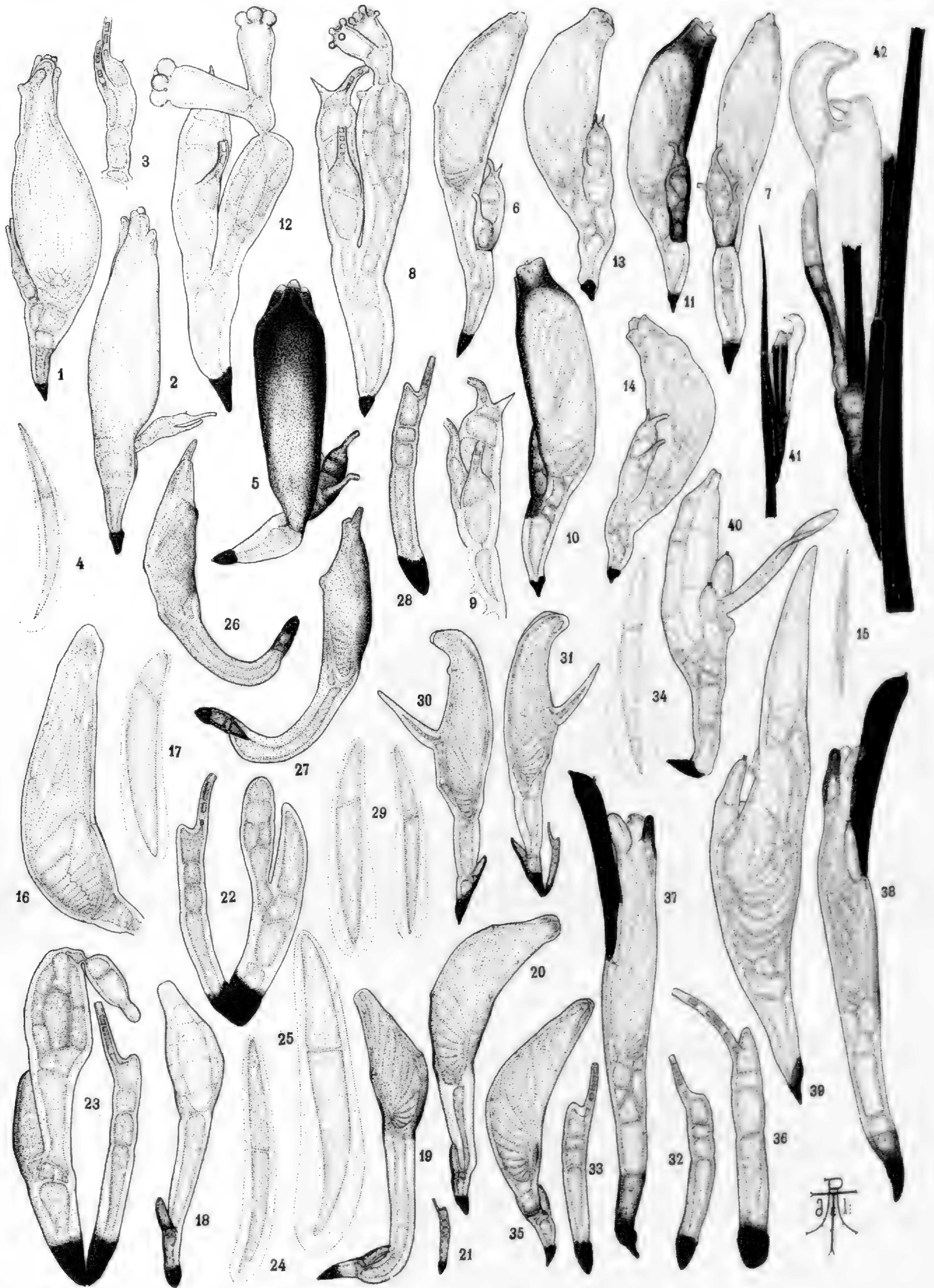



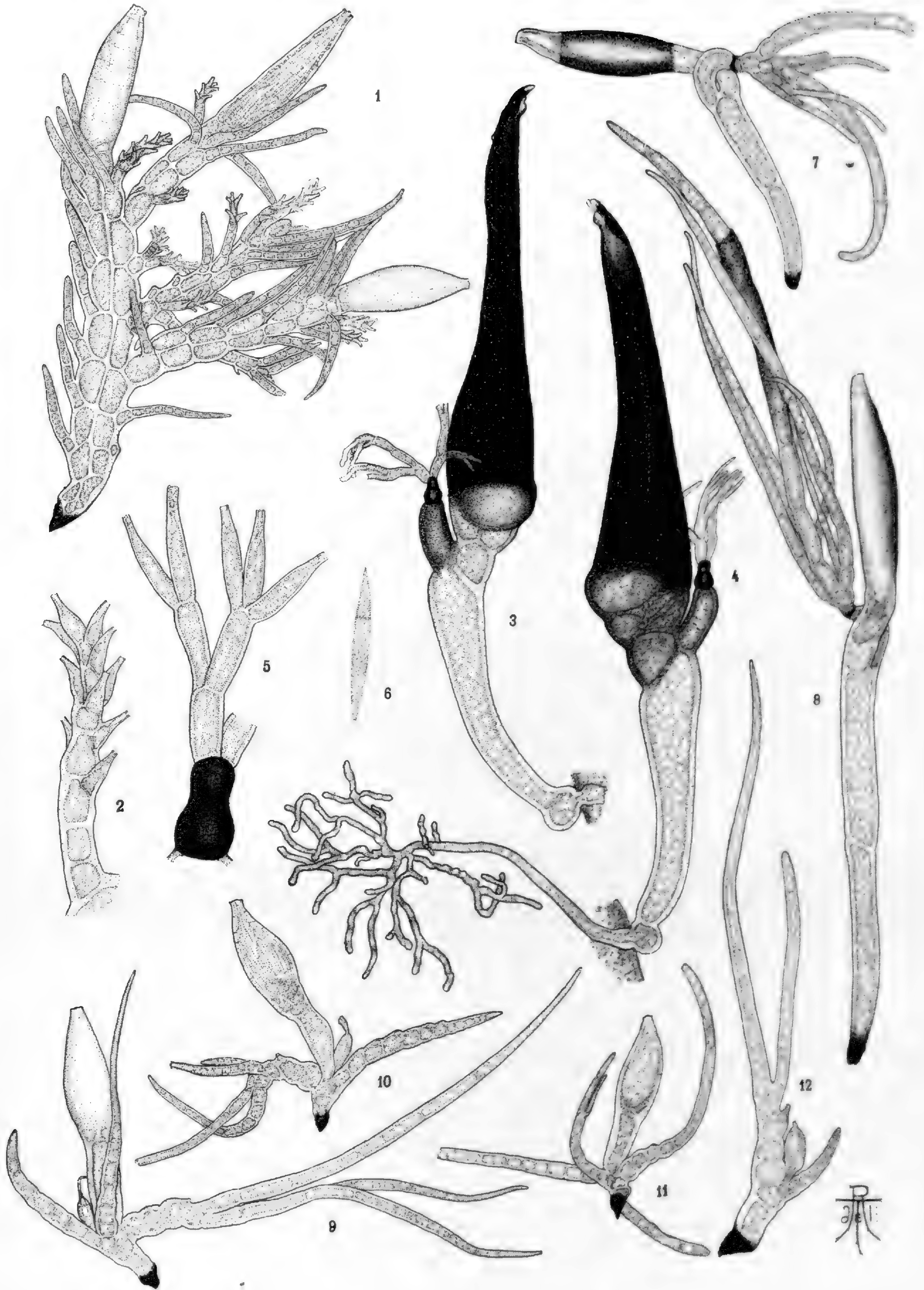









THAXTER.—LABOULBENIACEAE



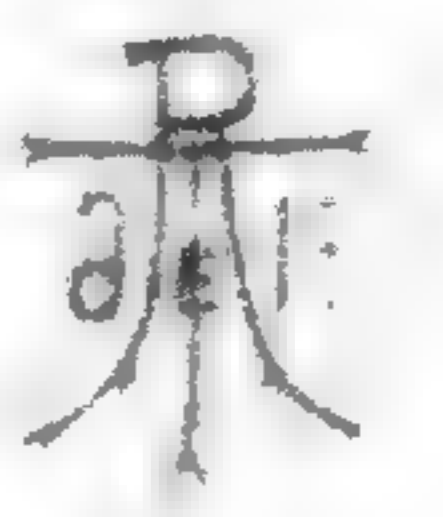
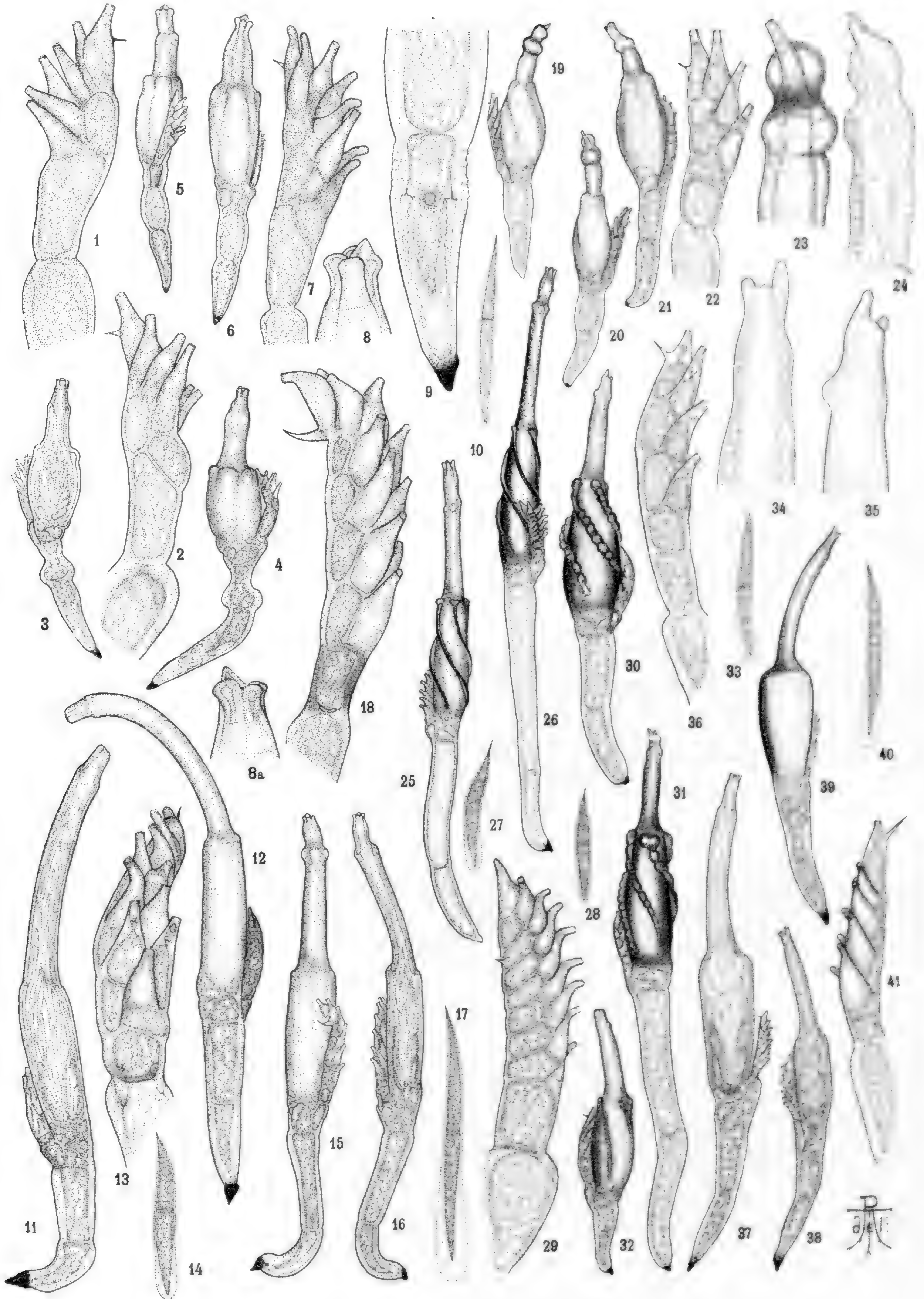





THAXTER.—LABOULBENIACEAE



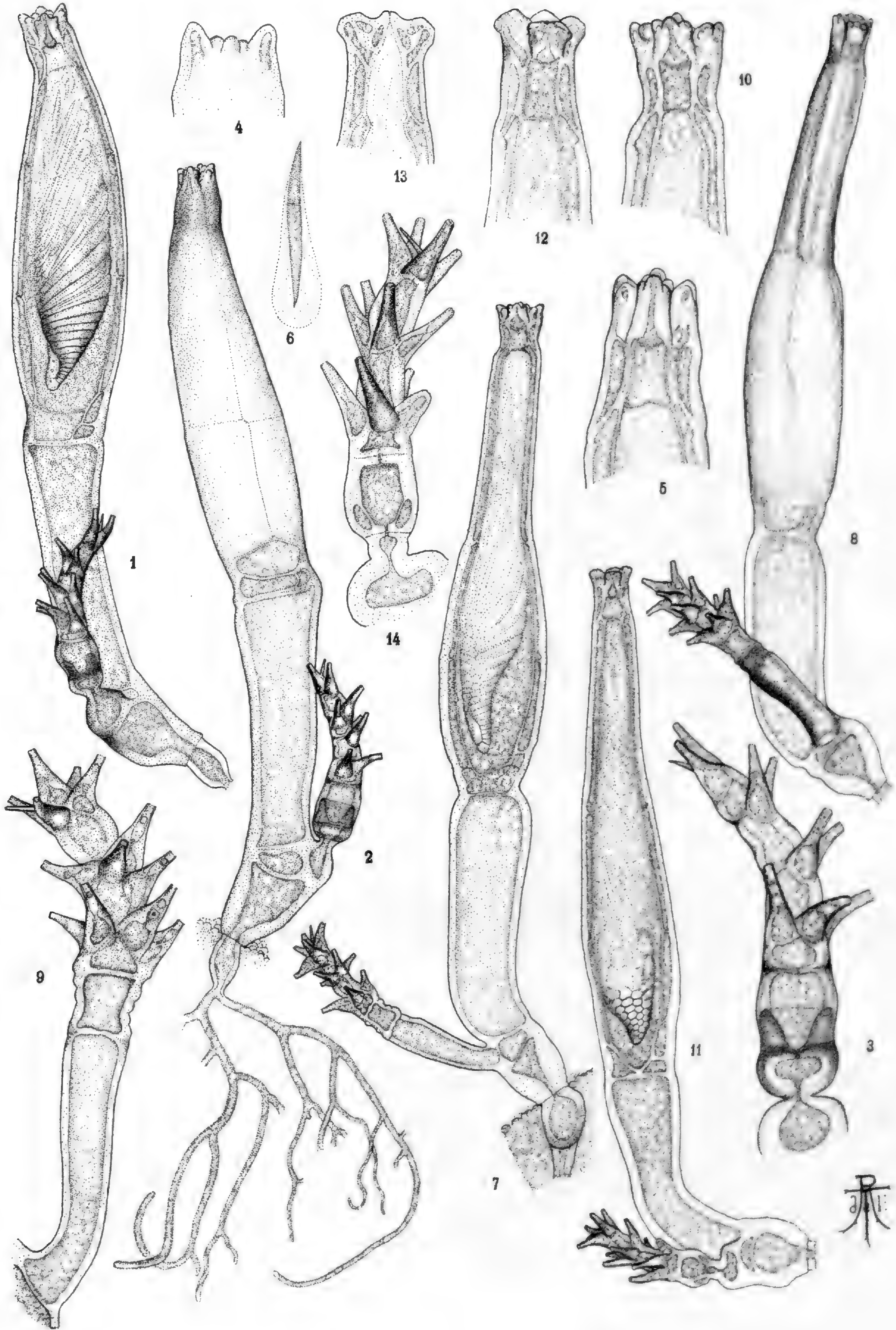



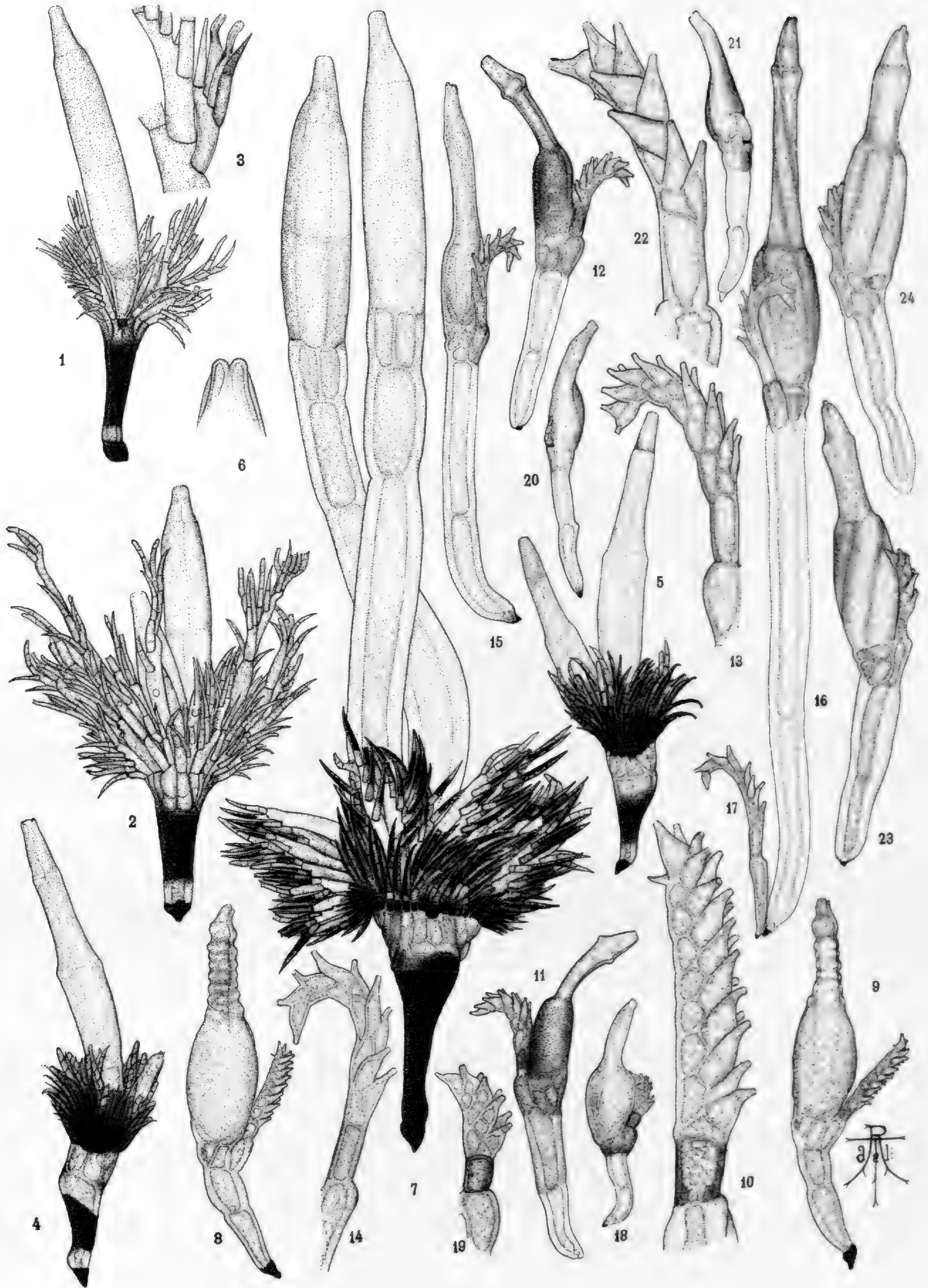





THAXTER.—LABOULBENIACEAE







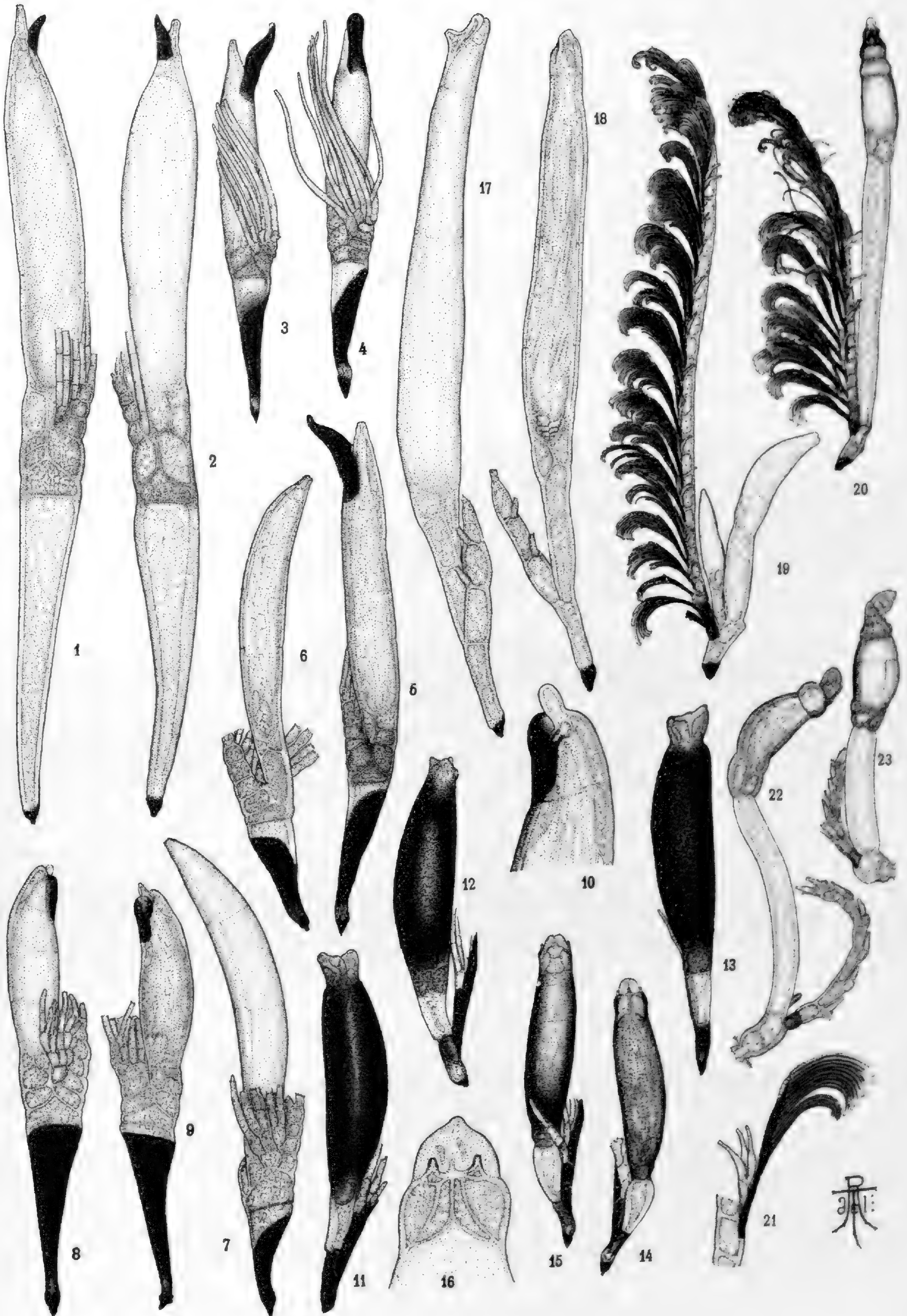

THAXTER.—LABOULBENIACEAE



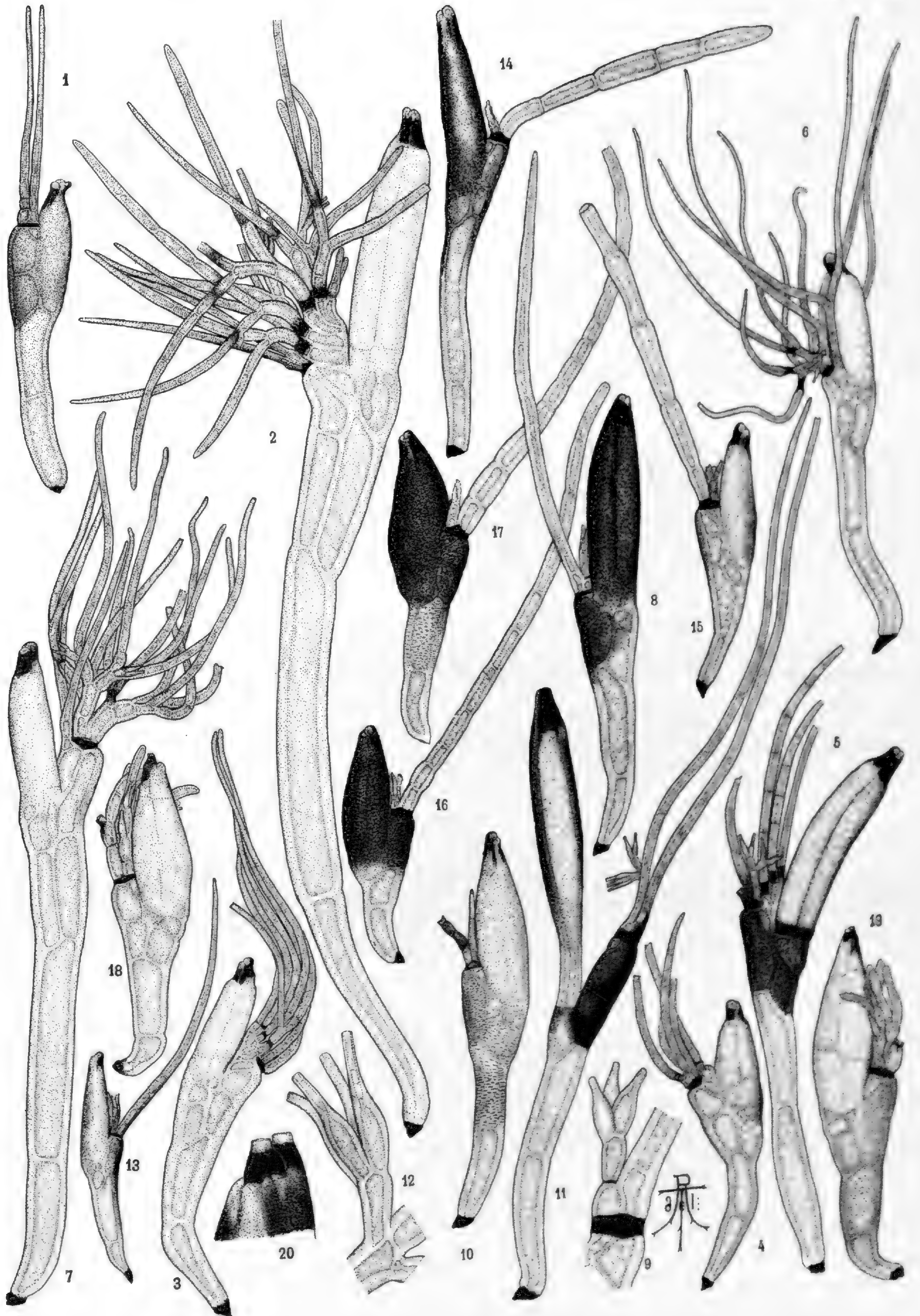





A small, stylized signature or logo located in the bottom right corner of the plate, consisting of a vertical line with a horizontal bar and a small hook-like element at the top.

THAXTER.—LABOULBENIACEAE

COCKAYNE, BOSTON.







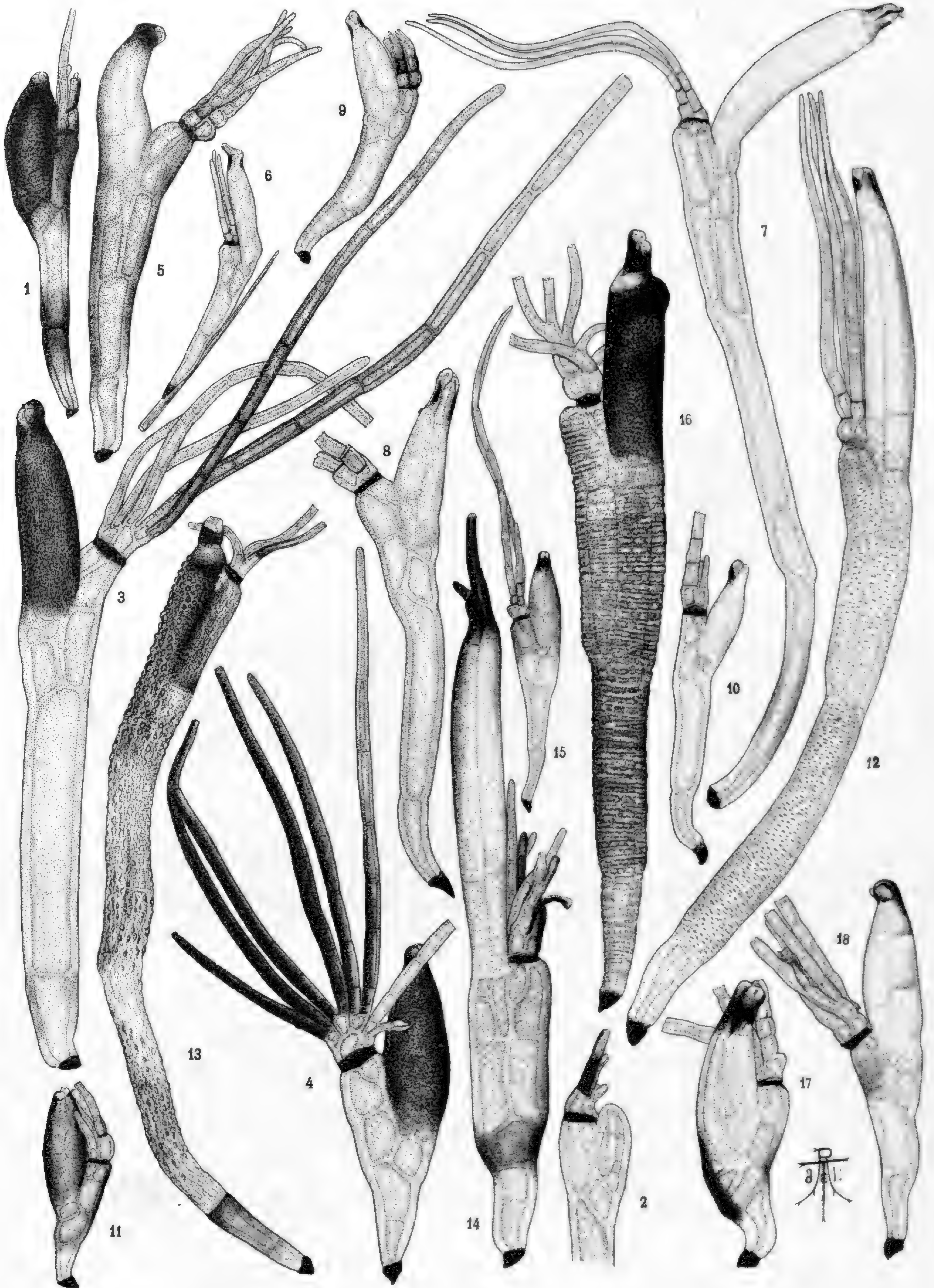

THAXTER.—LABOULBENIACEAE





THAXTER.—LABOULBENIACEAE





THAXTER.—LABOULBENIACEAE



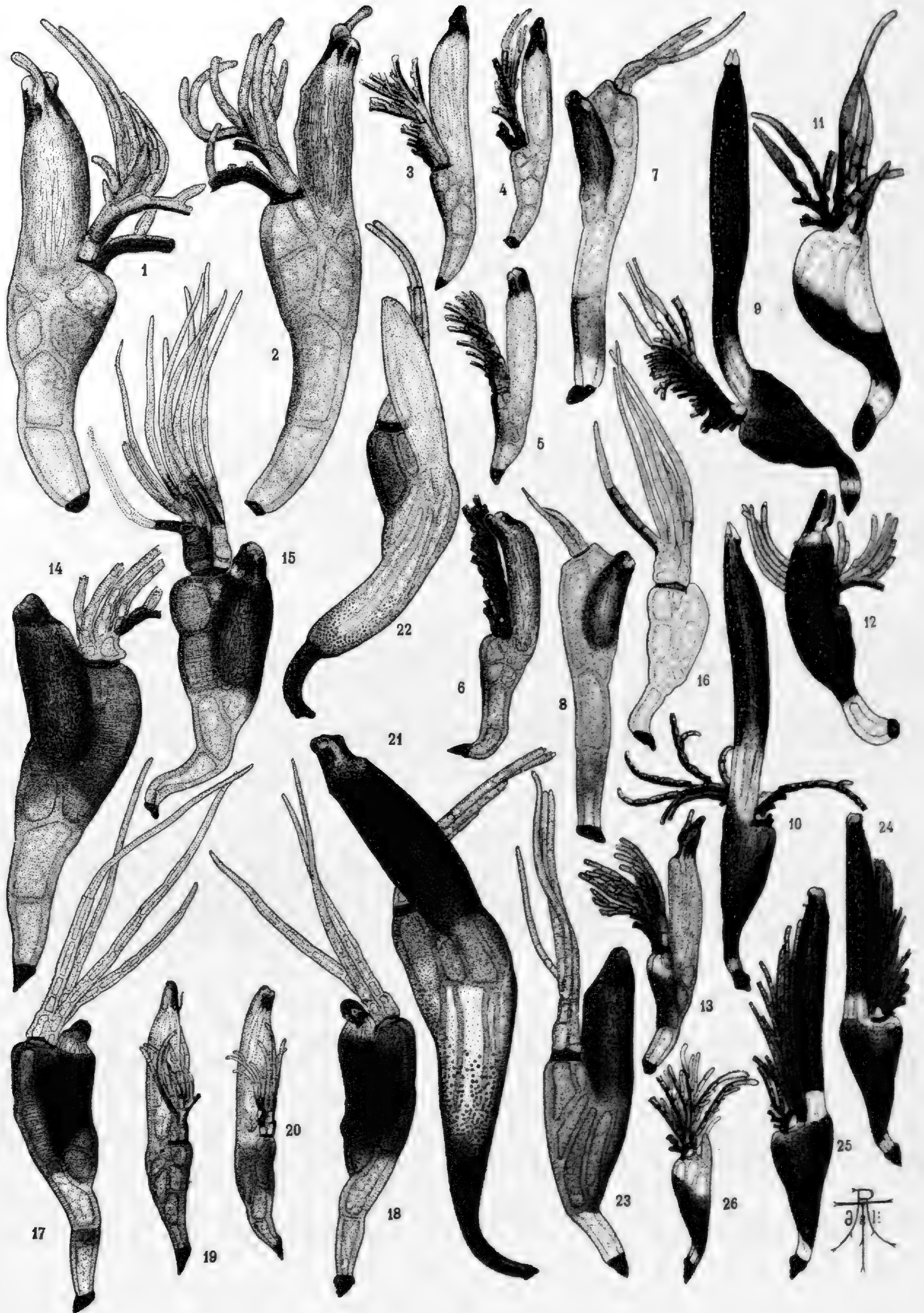





THAXTER.—LABOULBENIACEAE



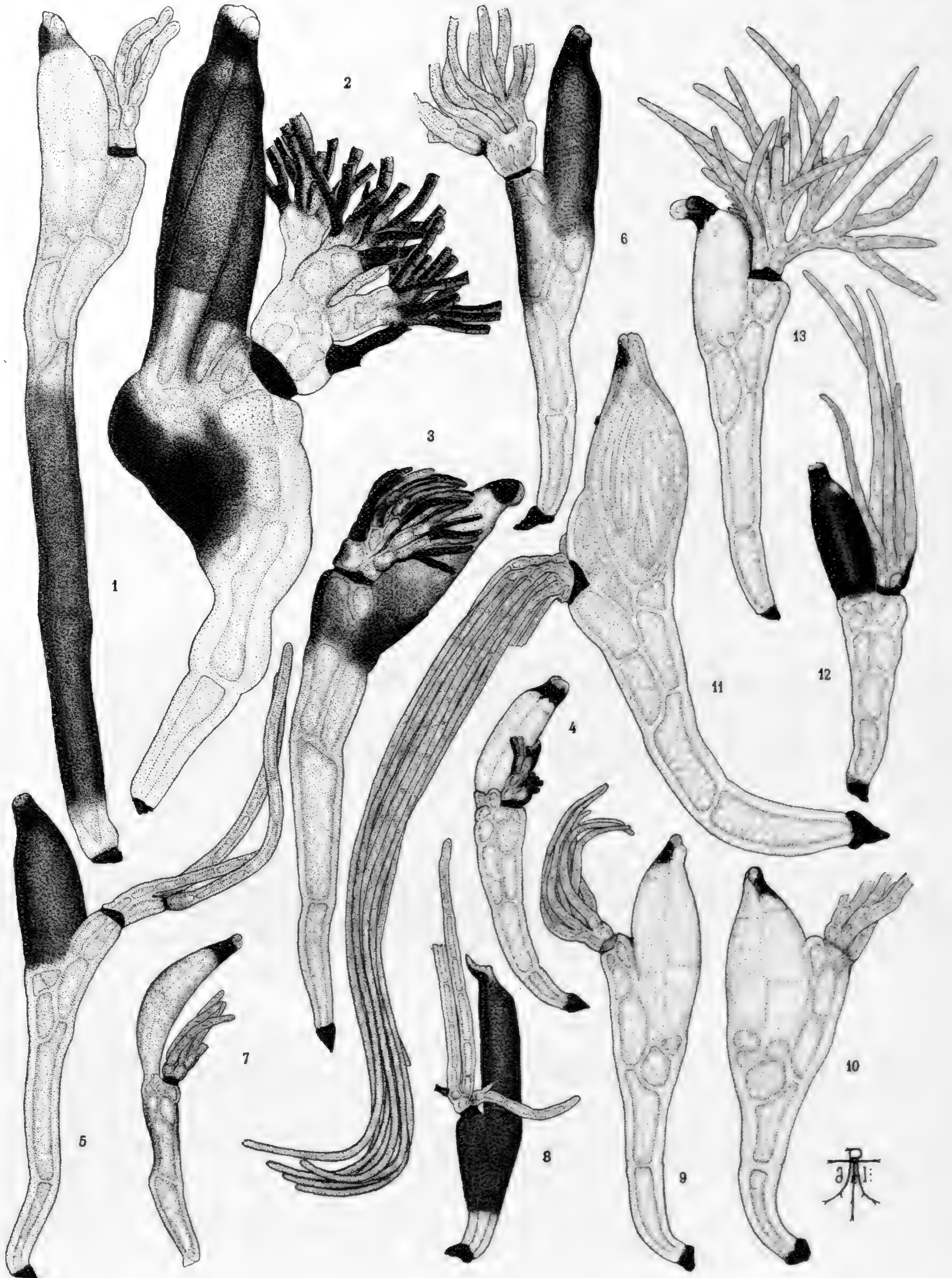



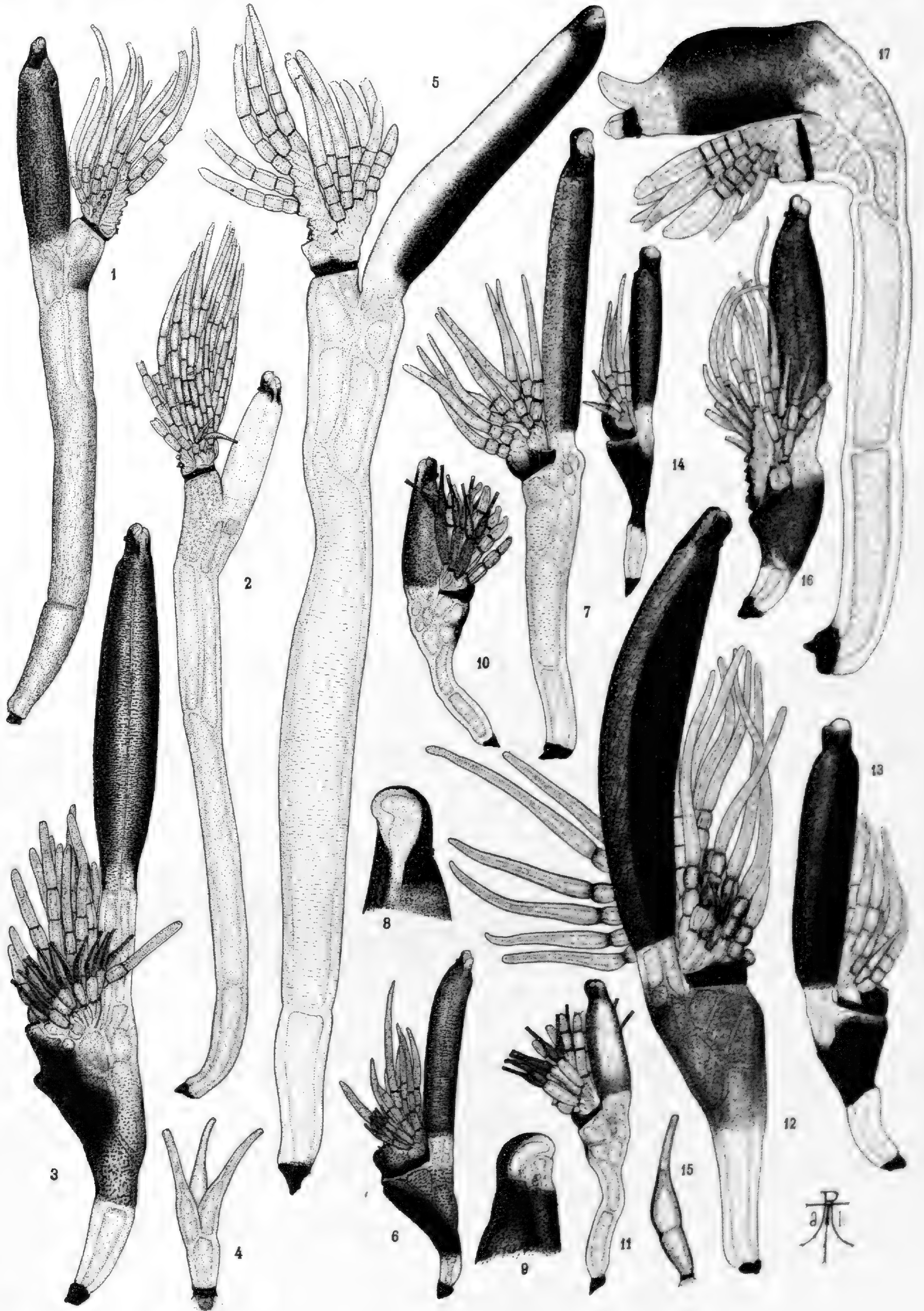

THAXTER.—LABOULBENIACEAE





THAXTER.—LABOULBENIACEAE









R  
a

THAXTER.—LABOULBENIACEAE









THAXTER.—LABOULBENIACEAE



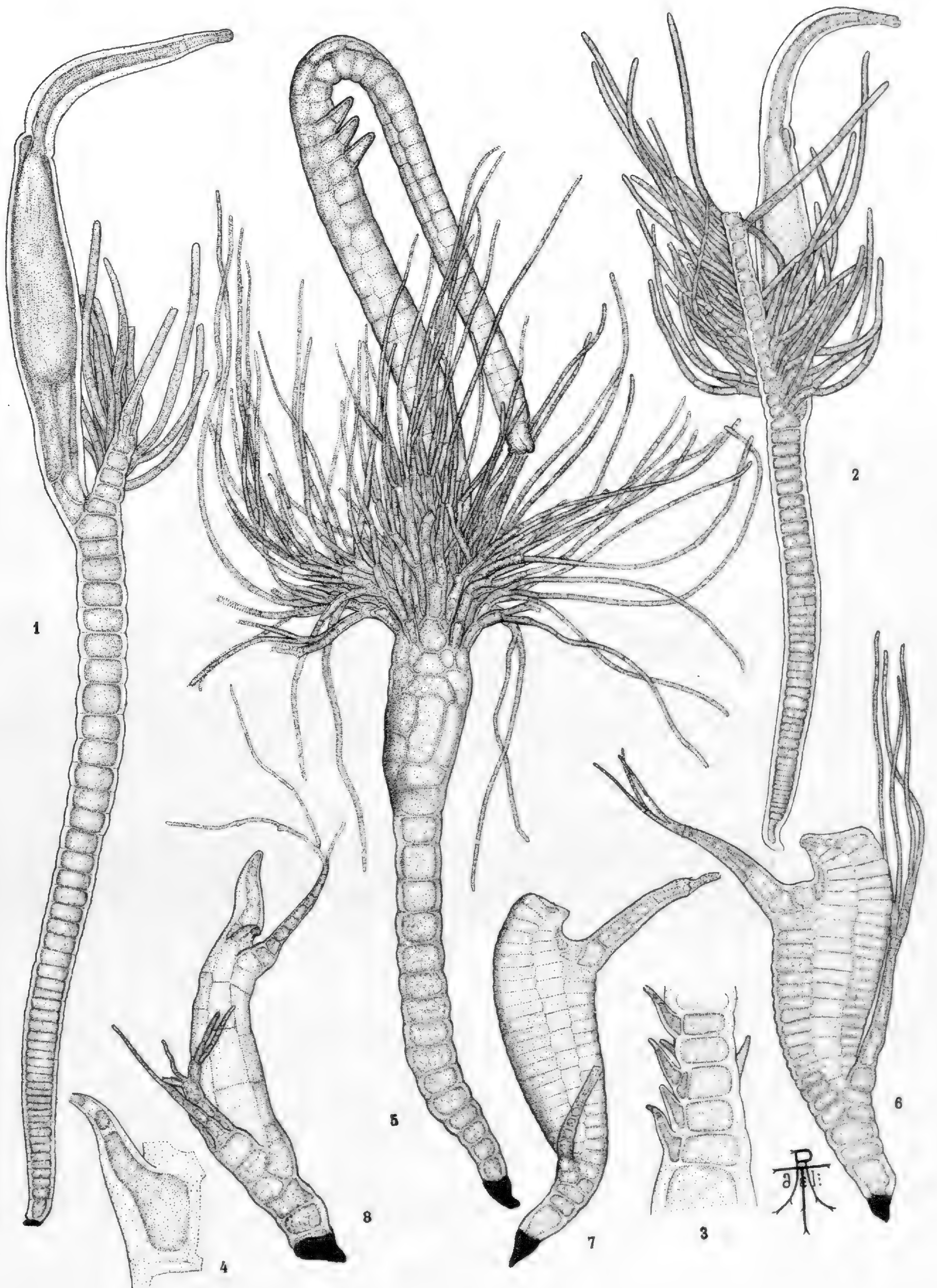



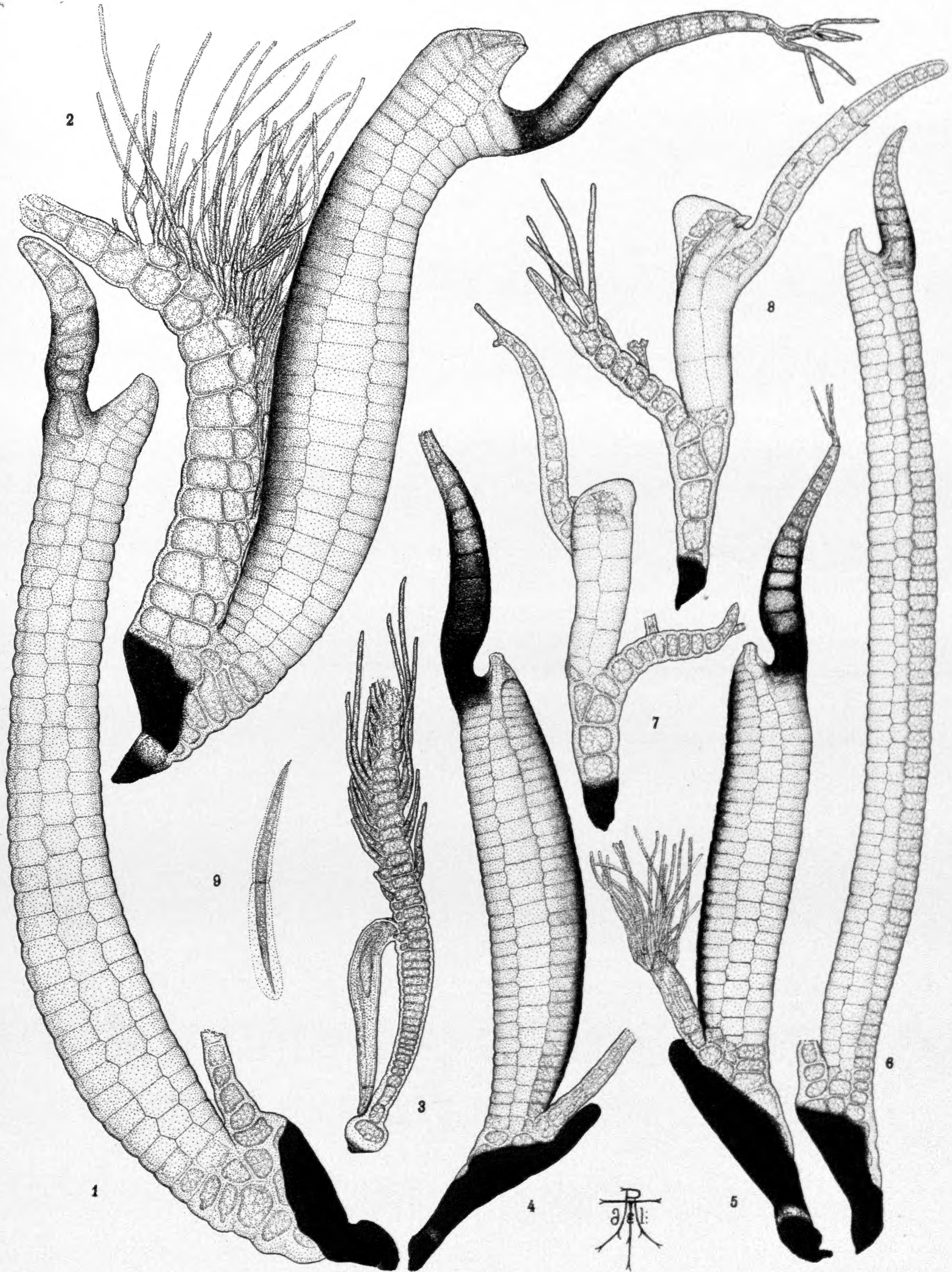





THAXTER.—LABOULBENIACEAE



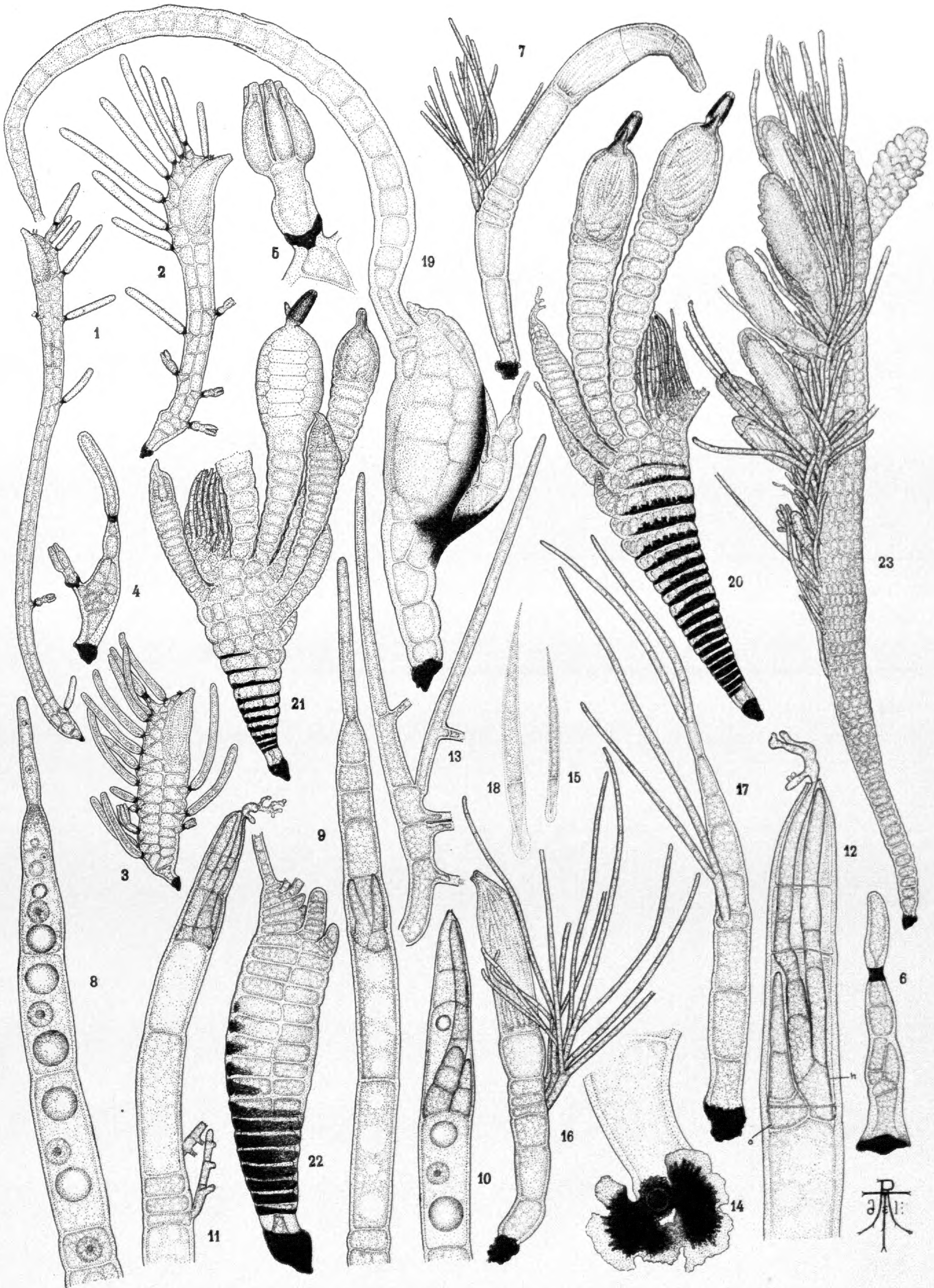

COCKAYNE, BOSTON.

THAXTER, — LABOULBENIACEAE





**PUBLICATIONS**  
OF THE  
**AMERICAN ACADEMY OF ARTS AND SCIENCES.**

MEMOIRS. OLD SERIES, Vols. 1-4; NEW SERIES, Vols. 1-12.  
16 volumes, \$10 each. Half volumes, \$5 each. Discount to  
booksellers 25%; to members 50%, or for whole sets 60%.

- Vol. 11.** PART 1. Centennial Celebration. 1880. pp. 1-104. 1882. \$2.00  
PART 2. No. 1. Agassiz, A.—The Tortugas and Florida Reefs. pp. 105-134.  
12 pls. June, 1885. (Author's copies, June, 1883.) \$3.00.  
PART 3. Nos. 2-3. Searle, A.—The Apparent Position of the Zodiacal Light.  
pp. 135-157 and Chandler, S. C.—On the Square Bar Micrometer. pp. 158-178.  
October, 1885. \$1.00.  
PART 4. No. 4. Pickering, E. C.—Stellar Photography. pp. 179-226. 2 pls.  
March, 1886. \$1.00.  
PART 4. No. 5. Rogers, W. A., and Winlock, Anna.—A Catalogue of 130 Polar  
Stars for the Epoch of 1875.0, resulting from the available Observations made  
between 1860 and 1885, and reduced to the System of the Catalogue of Publi-  
cation XIV of the Astronomische Gesellschaft. pp. 227-300. June, 1886. 75c.  
PART 5. No. 6. Langley, S. P., Young, C. A., and Pickering, E. C.—Pritchard's  
Wedge Photometer. pp. 301-324. November, 1886. 25c.  
PART 6. No. 7. Wyman, M.—Memoir of Daniel Treadwell. pp. 325-523. Octo-  
ber, 1887. \$2.00.
- Vol. 12.** 1. Sawyer, E. F.—Catalogue of the Magnitudes of Southern Stars  
from 0° to -30° Declination, to the Magnitude 7.0 inclusive. pp. 1-100. May,  
1892. \$1.50.  
2. Rowland, H. A.—On a Table of Standard Wave Lengths of the Spectral Lines.  
pp. 101-186. December, 1896. \$2.00.  
3. Thaxter, R.—Contribution towards a Monograph of the Laboulbeniaceæ, pp.  
187-430. 26 pls. December, 1896. \$6.00.  
4. Lowell, P.—New Observations of the Planet Mercury. pp. 431-466. 8 pls.  
June, 1898. \$1.25.  
5. Sedgwick, W. T., and Winslow, C. E. A.—(I.) Experiments on the Effect of  
Freezing and other low Temperatures upon the Viability of the Bacillus of Typhoid  
Fever, with Considerations regarding Ice as a Vehicle of Infectious Disease. (II.)  
Statistical Studies on the Seasonal Prevalence of Typhoid Fever in various Countries  
and its Relation to Seasonal Temperature. pp. 467-579. 8 pls. August, 1902.  
\$2.50.
- Vol. 13.** 1. Curtiss, D. R.—Binary Families in a Triply connected Region, with  
Especial Reference to Hypergeometric Families. pp. 1-60. January, 1904. \$1.00.  
2. Tonks, O. S.—Brygos: his Characteristics. pp. 61-119. pls. i, ii. November,  
1904. \$1.50.  
3. Lyman, T.—The Spectrum of Hydrogen in the Region of Extremely Short  
Wave-Length. pp. 121-148. pls. iii-viii. February, 1906. 75c.  
4. Pickering, W. H.—Lunar and Hawaiian Physical Features Compared. pp.  
149-179. pls. ix-xxiv. November, 1906. \$1.10.  
5. Trowbridge, J.—High Electro-motive Force. pp. 181-215. pls. xxv-xxvii.  
May, 1907. 75c.  
6. Thaxter, R.—Contribution toward a Monograph of the Laboulbeniaceæ. Part II.  
pp. 217-469. pls. xxviii-lxxi. June, 1908. \$7.00.

PROCEEDINGS. Vols. 1-43, \$5 each. Discount to booksellers  
25%; to members 50%, or for whole sets 60%.

The individual articles may be obtained separately. A price list of  
recent articles is printed on the inside pages of the cover of the  
Proceedings.

Complete Works of Count Rumford. 4 vols., \$5.00 each.  
Memoir of Sir Benjamin Thompson, Count Rumford, with Notices of  
his Daughter. By George E. Ellis. \$5.00.

Complete sets of the Life and Works of Rumford. 5 vols., \$35.00;  
to members, \$5.00.

For sale at the Library of THE AMERICAN ACADEMY OF ARTS AND  
SCIENCES, 28 Newbury Street, Boston, Massachusetts.