

1757/8
9 months
8 1/2 x 5 3/4

QK1
A 449
V. 37
Oct
1839

THE
AMERICAN JOURNAL
OF
SCIENCE AND ARTS.

CONDUCTED BY

BENJAMIN SILLIMAN, M. D. LL. D.

Prof. Chem., Min., &c. in Yale Coll.; Cor. Mem. Soc. Arts, Man. and Com., Cor. Mem. Met. Soc., and For. Mem. Geol. Soc., London; Hon. Mem. Br. and For. Abor. Protec. Soc., Mem. Geol. Soc., and Hon. Mem. Lin. and Statis. Socs., Paris; Mem. Roy. Min. Soc., Dresden; Nat. Hist. Soc., Halle; Imp. Agric. Soc., Moscow; Nat. Hist. Soc., Belfast, Ire.; Phil. and Lit. Soc., Bristol, Eng.; Hon. Mem. Roy. Sussex Inst., Brighton, Eng.; Cor. Mem. of the Nat. Hist. Soc., and of the Archæological Soc., Athens, Greece; Lit. and Hist. Soc., Quebec; Mem. of various Lit. and Scien. Soc. in the U. States.

AIDED BY

BENJAMIN SILLIMAN, JR., A. B.

Assistant in the department of Chemistry, Mineralogy and Geology in Yale College; Cor. Mem. of the Meteorological Soc., London; Sec. of the Yale Nat. Hist. Soc., Mem. of the Conn. Acad. of Arts and Sci.; Cor. Mem. of the Lyceum of Natural History, New York, &c.

VOL. XXXVII.—OCTOBER, 1839.

NEW HAVEN:

Sold by A. H. MALTBY and B. & W. NOYES.—*Philadelphia*, CAREY & HART and J. S. LITTELL.—*Baltimore, Md.*, N. HICKMAN.—*New York*, CARVILL & Co., No. 108 Broadway, and G. S. SILLIMAN, No. 44 William St.—*Boston*, C. C. LITTLE & Co.—*London*, JAMES S. HODSON, No. 112 Fleet St., and WILEY & PUTNAM, 35 Paternoster Row.—*Paris*, CHARLES DUPERRON, Rue Mabillon.—*Hamburgh*, Messrs. NESTLER & MELLE.

PRINTED BY B. L. HAMLEN.

CONTENTS.

	Page.
ART. I. Meteorological Observations during a Residence in Colombia, between the Years 1820 and 1830; by Col. Richard Wright,	1
II. Remarks on the Trilobite; by Prof. Green, M. D.,	25
III. Description of a New Trilobite; by Prof. Jacob Green, M. D.,	40
IV. On the Natural History of Volcanos and Earthquakes; by Prof. Gustav Bischof,	41
V. Reply of Dr. Daubeny to Prof. Bischof's Objections to the Chemical Theories of Volcanos,	78
VI. Mountains in New York; by E. F. Johnson,	84
VII. Account of a Tornado; by Willis Gaylord,	90
VIII. On Meteoric Stones—From the Annual Account of the Progress of Physics and Chemistry; by Berzelius,	93
IX. Terrestrial Magnetism; by J. Hamilton,	100
X. Explosion of Hydrogen and Oxygen, with Remarks on Hemming's Safety Tube; by Prof. J. W. Webster,	104
XI. On the Greek Conjugations; by Prof. J. W. Gibbs,	112
XII. Notice of Prof. Ehrenberg's Discoveries in relation to Fossil Animalcules; also Notices of Deceased Members of the Geological Society of London, being extracts from the Address of Rev. William Whewell, B. D. F. R. S.,	116
XIII. Account of a Meteor seen in Connecticut, December 14, 1837; with some considerations on the Meteorite which exploded near Weston, Dec. 14, 1807; By Edward C. Herrick,	130
XIV. Some Notice of British Naturalists; by Rev. Charles Fox,	136

MISCELLANIES.

1. Pictorial delineations by light; solar, lunar, stellar, and artificial, called Photogenic and the art Photography,	169
2. Correction of an Error—Cinnabar not found in Michigan,	185

	Page.
3, 4. An Essay on the Development and Modifications of the external Organs of Plants—Journal of the Essex County (Mass.) Natural History Society,	187
5. Transactions of the American Philosophical Society,	188
6, 7. Notice of the Journal of the Statistical Society of London.—Progress of the U. S. Exploring Expedition,	189
8, 9. Cold Bokkeveld Meteorites—Meteoric Iron from Potosi,	190
10, 11. Encke's Comet—Remains of the Mastodon in Missouri,	191
12. Latanium, a New Metal,	192
13. Biography of Scientific Men,	193
14, 15, 16. Note by Mr. E. F. Johnson, Civil Engineer—A Northern Lynx taken in Connecticut—Preservation of animal Fat for Soap Making,	194
17. Notice of <i>Vespertilio Pruinosus</i> and <i>Icterus Phœniceus</i> ,	195
18. Malaria,	196
19. Electrical Excitement in Leather by Friction,	197
20, 21. Great Scheme for Magnetical Observations—Action of Spungy Platina,	198
22. Formation of Metallic Veins by Galvanic Agency,	199
To our Subscribers and Readers,	200

THE
AMERICAN JOURNAL
OF
SCIENCE AND ARTS.

CONDUCTED BY

BENJAMIN SILLIMAN, M. D. LL. D.

Prof. Chem., Min., &c. in Yale Coll.; Cor. Mem. Soc. Arts, Man. and Com., Cor. Mem. Met. Soc., and For. Mem. Geol. Soc., London; Hon. Mem. Br. and For. Abstr. Prom. Soc., Mem. Geol. Soc., and Hon. Mem. Lin. and Stat. Soc., Paris; Mem. Roy. Min. Soc., Dresden; Nat. Hist. Soc., Halle; Imp. Agric. Soc., Moscow; Nat. Hist. Soc., Belfast, Ire.; Phil. and Lit. Soc., Bristol, Eng.; Hon. Mem. Roy. Sussex Inst., Brighton, Eng.; Cor. Mem. of the Nat. Hist. Soc., and of the Archaeological Soc., Athens, Greece; Lit. and Hist. Soc., Quebec; Mem. of various Lit. and Scien. Soc. in the U. States.

AIDED BY

BENJAMIN SILLIMAN, JR., A. B.

Assistant in the department of Chemistry, Mineralogy and Geology in Yale College; Cor. Mem. of the Meteorological Soc., London; Sec. of the Yale Nat. Hist. Soc., Mem. of the Conn. Acad. of Arts and Sci.; Cor. Mem. of the Lyceum of Natural History, New York, &c.

VOL. XXVII.—No. 1.—JULY, 1839. Bis

NEW HAVEN:

Sold by A. H. MALTBY and B. & W. NOYES—Philadelphia, CAREY & HART and J. S. LITTELL—Baltimore, Md., N. HICKMAN—New York, CARVILL & Co., No. 108 Broadway, and G. S. SILLIMAN, No. 41 William St.—Boston, C. C. LITTLE & Co.—London, JAMES S. HODSON, No. 112 Fleet St., and WILEY & PUTNAM, 35 Paternoster Row—Paris, CHARLES DUPERRON, Rue Mabillon—Hamburg, Messrs. NESTLER & MELLE.

PRINTED BY B. L. HAMLIN.

Published at New Haven, Aug. 15, 1839.

ACKNOWLEDGMENTS TO CORRESPONDENTS, FRIENDS
AND STRANGERS.

Remarks.—This method of acknowledgment has been adopted, because it is not always practicable to write letters, where they might be reasonably expected; and still more difficult is it to prepare and insert in this Journal, notices of all the books, pamphlets, &c., which are kindly presented, even in cases, where such notices, critical or commendatory, would be appropriate; for it is often equally impossible to command the time requisite to frame them, or even to read the works; still, judicious remarks, from other hands, would usually find both acceptance and insertion.

In public, it is rarely proper to advert to personal concerns; to excuse, for instance, any apparent neglect of courtesy, by pleading the unintermitting pressure of labor, and the numerous calls of our fellow-men for information, advice, or assistance, in lines of duty, with which they presume us to be acquainted.

The apology, implied in this remark, is drawn from us, that we may not seem inattentive to the civilities of many respectable persons, authors, editors, publishers, and others, both at home and abroad. It is still our endeavor to reply to all letters which appear to require an answer; although, as a substitute, many acknowledgments are made in these pages, which may sometimes be, in part, retrospective.—

Eds.

SCIENCE.—FOREIGN.

Important facts embracing many results in Chemistry, by Thomas Exley, A. M. London, 1837. From the Author.

Lethea Geognostica, by Prof. H. G. Bronn, the last Livraisons, with the index and table of contents. Author.

Observations on some new Organic Remains in Flint of Chalk, by Rev. J. B. Read, M. A., F. R. S. London, 1838. From G. Mantell, Esq.

Works of Confucius in Chinese, from the Rev. Mr. Dickinson, American missionary, for the Library of Yale College.

Notice of the Indian Archipelago, and adjacent countries, by J. H. Moor. Singapore, 1837, Vol. I, Quarto, for the Library of Yale College, from Rev. J. F. Dickinson, Singapore.

Chart, exhibiting the plan proposed by Lieut. John Fayer, R. N. Commander of the steamship Liverpool, for extinguishing by steam, fires arising from spontaneous combustion of coals in other parts of a vessel. January, 1838. From Messrs. Abraham Bell & Co., consignees of the Liverpool steamship, New York.

British Annual and Epitome of the Progress of Science, for 1839. Edited by Robert D. Thomson, M. D. London. Hippolyte Bailliere, 1838. From the Author.

Consistency of the Discoveries of Modern Geology with the Sacred History of the Creation and the Deluge, by Prof. Silliman of Yale College. Reprint by J. S. Hodson, 112 Fleet st. London, 1837. Mr. Hodson.

The Seventh Report of the British Association for the Advancement of Science, Vol. VI. From the Association. London. John Murray, 1838.

Transactions of the Society for the Encouragement of Arts, Manufactures and Commerce, Vol. LI, Part II, and Vol. LII, Part I. From the Society through A. Akin, Esq. London, 1838.

Institution of Civil Engineers. Minutes of Proceedings and Sessions 1838 and 1839, pp. 52 and 26. London, 1838, 1839. From the Institute of Civil Engineers.

Palmer's New Catalogue of Chemical and Philosophical apparatus. Several copies. London, 1838. From Mr. Palmer.

A Catalogue of Ancient and Modern Botanical Books, offered for sale by O. Rich. From O. Rich.

Henry Coxhead's Catalogues of New Scientific Books.

The Silurian System founded on Geological Researches, in the Counties of Salop, Hereford, &c., with descriptions of the Coalfields and overlying formations, by Roderick Impey Murchison, F. R. S., F. L. S., in two parts, 4to., including an atlas of drawings and large separate maps. From the author. London, John Murray, Albermarl st. 1839. A magnificent work.

Part of the Poissons Fossiles of Prof. Louis Agassiz. From the author. Neuchatel, Suisse, 1839.

Monographies D'Echinodermes Vivans et Fossiles, par L. Agassiz. 1 Livraison Contenant les Salenes. Neuchatel, 1838. From the author.

Bulletin de Soc. Geologique de France. Tome ix, pp. 145 to 508. From the Society.

On the Geological Relations of the South of Ireland, by Thomas Weaver, Esq., F. G. S., R. S., &c. From the author, 4to. (from the Trans. Geol. Soc., London, Vol. V, new series, pp. 68.)

Dr. Mantell's Wonders of Geology. 2d London edition, 2 Vols. large paper. From the author.

Railway Mag. and Steam Nav. Journal, No. 29, for July, 1838, to No. 40, June, 1839, inclusive. From the Editor, John Herepath, Esq.

SCIENCE.—DOMESTIC.

Contributions to Electricity and Magnetism, by Joseph Henry, Prof. of Nat. Phil. in the Coll. of N. Jersey. Philadelphia, 1839. From the author.

Catalogue of Recent Shells in the Cabinet of John C. Jay, M. D. of N. Y. 4to. with 10 plates of new and rare Shells; two copies, one for the Yale Nat. Hist. Soc. From the Author.

Transactions of the American Philosophical Society, Philadelphia, Vol. VI, Part II. Key & Biddle. 1839. From the Society.

Boston Journal of Natural History; containing papers and communications read before the Boston Society of Natural History, Part I, No. 3, and Vol. II, No. 1. Boston, 1836 and 1839. From the Society.

The Alabama State Almanac for the year 1839. Tuscaloosa, Alabama. From Prof. Barnard.

An Essay on the Development and Modification of the External Organs of Plants; compiled chiefly from the writings of J. Wolfgang von Goethe. By Wm. Darlington, M. D. West Chester Point, 2 copies. From the Author—one for Yale Nat. Hist. Society.

Annual Report of the Geologist of Maryland. 1838. From the Geologist, Dr. Ducatel.

First and Second Reports of the Progress of the Geological Survey of the State of Virginia, for the year 1836 and 1837; by and from Wm. B. Rogers, Prof. Nat. Phil. in the University of Va.

Report of the Progress of the Geological Survey of the State of Va. for the year 1838; by Prof. Wm. B. Rogers. From the Author.

A Chart of Cape May Roads, including Crow Shoal. From Major J. D. Graham, U. S. Army, for Y. C. Library.

Chart of the Entrance into Sandusky Bay; by and from Maj. Graham, U. S. Army, for Y. C. Library.

A Map of the Extremity of Cape Cod, including the townships of Provincetown and Truro, with a Chart of their Sea Coasts and Cape Cod Harbor, executed under the direction of Maj. J. D. Graham, U. S. Top. Engs. in 1833, 4 & 5, (in 4 large sheets) from Maj. Graham, for Y. L. Lib. The same to Prof. Silliman, from Maj. Graham.

Chart of the Mouth of Connecticut River. From Capt. Swift.

Letters to the Sec. of the Treasury, on the History and Causes of Steamboat Explosions, and the Manner of Prevention; by W. C. Redfield. Revised edition. N. York, 1839. From the Author.

Essay on Meteorological Observations; by J. N. Nicollet, Esq. Printed by order of the War Department, May, 1839. From Col. J. J. Abert, U. S. Engineer. Two copies.

New York Journal of Medicine and Surgery, July 1839. No. 1, Vol. I. From the Editors.

Third Annual Report of the Geology of Maine. From Dr. C. T. Jackson.

Address delivered on laying the Corner Stone of the Academy of Sciences of Philadelphia, May 25, 1839. From W. R. Johnson, Esq., Author.

Four plates of Dr. S. Morton's *Crania Americana*: Viz. 17, 28, 37 and 62. From the Author.

Account of a Tornado in Rhode Island; by R. Hare, M. D. From the Author.

Report of the Progress of the Geological Survey of New York, for 1839. One from Prof. Emmons, one from James Hall, and one from an unknown friend.

Second Annual Report on a Geological Survey of Ohio; by W. W. Mather. From Mr. Mather. Columbus, 1839.

Third Annual Report of the Geological Survey of Pennsylvania. From Hon. Judge D. Daggett; also one from N. Ellmaker.

Journal of the Essex County Nat. Hist. Soc. Vol. 1, No. II, 1839. From the Society.

Treatise on the Eye. By and from Dr. W. C. Wallace, oculist of New York.

MISCELLANEOUS.—FOREIGN.

Scotch Life Assurance. From Mr. Fox of Durham, England.
Synopsis of a System of Education Established by the University of Kings College. Fredericton. New Brunswick, 1838.

Views of Clapham Common Eng. From Dr. Gideon Mantell.

View of the present state of Thames Tunnel. From the same.

Report on the Indians of Upper Canada. London, 1839.

Reports and Proceedings of the British and Foreign Aborigines Society. Four pamphlets from the Society. 1839.

MISCELLANEOUS.—DOMESTIC.

Catalogue of Bowdoin College, New Brunswick, Me. From Prof. Cleaveland.

Prospectus of the New York Quarterly Journal of Medicine and Surgery.

Circular of Irwinton Literary Institute. Irwinton, Alabama, 1839. From O. P. Hammond.

Annual Announcement of the Medical Department of Transylvania University, Lexington, Ky. 1839.

Circular of Rutger's Female Institute, New York. From Mr. C. E. West.

New York Literary Gazette, No. 64, containing Retzsch's Game of Life.

Barber's Historical Collections. Massachusetts. From the Author. Svo, 1839. New Haven.

A Review of the Rev. Horace Bushnell's Discourse on the Slavery Question; by Francis Gillett. Hartford, 1839. From the Author.

Introductory Lecture to a Course of Chemistry delivered in Washington College, Lexington, Va. Feb. 21, 1838; by Geo. D. Armstrong, A. M., Richmond, 1838. From the Author.

History of the Old South Church in Boston; by Rev. B. B. Winslow, former Pastor of the Church. From Rev. J. W. Blagden, present Pastor.

Catalogue of a Collection of Rare, Curious and Valuable Books on Divinity, Classics, &c. to be sold 23d and 24th May at auction, by Bangs, Richards & Platt, N. Y.

Speech of the Hon. Thomas Morris of Ohio, in Senate of U. S. February 6th, 1839, in reply to Henry Clay. New York. From the Author.

D. Davis' Descriptive Catalogue of Apparatus and Experiments Illustrative of Galvanism, Electro-Magnetism, Magneto-Electricity. From D. Davis. Boston. Several copies from Maker.

United States Naval Lyceum Report on the State of the Institution for 1839. From the Lyceum.

Constitution and By-Laws of the N. Y. Historical Society, 1839. From G. Gibbs, Esq.

A Catalogue of Miscellaneous Books for sale by Little & Brown, Boston, 1839. From the Publishers.

Annual Catalogue of the New England Agricultural Warehouse. Boston, 1839. From Joseph Breck & Co.

The School Advertizer. Several Nos. from Marsh, Capen, & Lyon. Boston, 1839.

Dr. Noah Webster's Address to the friends of Literature. From the Author.

Minutes of the Medical Society of Tennessee. Held in Nashville, May, 1839. Columbia. From the Society.

Mitchell's School Geography (with an atlas,) 12mo. Philadelphia, 1839. From Mr. Mitchell.

A Manual of Useful Studies for the Instruction of Young Persons. By and from Noah Webster, LL. D. New Haven, 1839.

Address at the opening of the Rutger's Female Institute, by Dr. Isaac Ferris. From the Author, and 1 from C. E. West to B. S., Jr.

Burmese Tract, called the Ship of Grace.

Twenty Third Report of the Directors of the American Asylum at Hartford for the Deaf and Dumb. Hartford, 1839. From Mr. Weld.

First Annual Report of the Commissioners of Common Schools in Connecticut. Hartford, 1839. From H. Beardsley, Esq., Secretary.

Catalogue of Historical, Antiquarian, and Scientific Books, sold in N. York, June 6. From the Auctioneers.

Catalogue of an extensive collection of Old English Books sold in New York, June 20 and 21, 1839.

Analysis of Sounds, and System of Stenography, by C. P. Newton.

Report of Edwin F. Johnson, Civil Engineer, in relation to the the Survey of the Ogdensburg and Champlain Rail Road. From the Author.

Jubilee of the Constitution, by J. Q. Adams. From George Gibbs, Esq.

Second Report of the Foreign Evangelical Association. New York, 1839. From Rev. Mr. Baird.

Valedictory Oration before the Society of Brothers in Unity, by C. J. Stillè. From W. E. Robinson.

Proceedings of the President and Fellows of the Conn. Medical Society. Hartford, 1839.

Catalogue of Paintings, &c., at the Apollo Gallery, 410 Broadway, N. York.

List No. II, of English Books, by Wiley & Putnam.

Hartford Young Men's Society, Charter and By-Laws. From H. Barnard, Esq.

The Statutes of Emory College, and the By-Laws of the Faculty. Oxford, Ga. From Prof. A. Means.

Annual Report of the Regents of the University to the Legislature of the State of New York. 1839. From the Regents.

Annual Report of the A. B. C. F. M. for 1839. From the Board.

Proceedings of the American Philosophy Society. Philadelphia. Vol. 1. Nos. 4, 5 and 6. From the Society.

Second Annual Report of the Geology of Ohio. From C. B. Goddard, Esq. Also one to Yale Nat. Hist. Soc. From W. W. Mather.

13th Report of the Home Missionary Society, 1839.

NEWSPAPERS.—FOREIGN.

The Atheneum Journal, Nos. 584, 585, 596, and 601. From Charles Fox, Esq.

NEWSPAPERS.—DOMESTIC.

The Boston Atlas. Tuesday, April 16, with notice of sales of the late Dr. King's Electrical Apparatus.

New Era. Monday, March 25, 1839. From E. Williams. With a notice of Dr. H. H. Sherwood's memorial to Congress on Magnetism.

The Miner's Journal. Pottsville. March 30th, 1839. With a notice of the coal mines of the region. Mr. Wm. W. Selfridge.

N. Y. Daily Whig. Friday, April 12th.

East Tennessean. Rogersville. Tuesday, April 2d, 1839. No. 1. With a notice of the Marbles of Tennessee, by Dr. Troost.

New Orleans Commercial Bulletin. March 28, 1839. With a notice of J. S. Buckingham's Lectures.

Felicianan Republican and Louisiana Literary Messenger. Saturday, April 6, 1839. Containing Prof. Cabis' Temperance Speech. From Prof. W. M. Carpenter.

The Colored American. Saturday, Jan. 29, 1839.

Report of the Public proceedings in New Orleans to establish a Sailor's Home. N. O. Com. Bulletin of April 18th, 1839.

Boston Cultivator. May 11, 1839. From Hovey & Co. With a catalogue of new Dahlias, for 1839.

The Sun (of N. Y.) July 29. From Dr. Peck. Containing an account and drawing of the Steamer British Queen, and of Fitch's Steamboat of 1786, on the Delaware.

The Rockton Enterprise. Several Nos. From E. Griffing, Editor, Little Falls, (Rockton.)

The Cultivator for 1838-9. From Judge J. Buel. Albany.

The Weekly True American. N. Orleans. No. 59. Jan. 9, 1839.

Proceedings of the Broadway Tabernacle against Lewis Tappan.

Philadelphia North American. May 21st, 1839.

Friend of Man. July 3d, 1839.

N. Y. American. May 28th. With a notice of this Journal. From G. S. Silliman, Esq.

Family Schoolmaster. Richmond, Indiana, Jan 26th.

The Virginia Herald. Fredericksburg, Jan. 26th, 1839. With an account of the Russian mode of extracting gold. From James Williams, Esq.

Republican Farmer. Wilkesbarre, Pa. Jan. 26th, 1839. From E. J. Turner.

Norwalk Gazette, Conn. July 17. Containing remarks of Rev. John Noyes, on 4th July, 1839.

N. Y. Commercial Advertiser. June 7th, 1839. With a notice of Mr. Frelinghuysen's Inauguration as Chancellor of the University.

SPECIMENS—FOREIGN AND DOMESTIC.

Beautiful Quartz Crystals from Little Falls, N. Y. From E. M. Griffing.

Two caskets of dried plants from Indiana, for the Yale Natural History Society. From Mrs. L. W. Say.

Sulphate of Strontia from Sicily. Miss Pratt, Summer st., Boston.

Section of an Elephant's tooth. From Mr. J. E. Pratt, Boston.

A box of impressions of fossil plants from Alabama. From Prof. F. A. P. Barnard, Tuscaloosa, Alabama.

A box of Encrinites from the transition near New Echota, Ga. From W. J. Parvin, Esq., P. M.

A suite of Geological Specimens from S. Africa, near Capetown. From Rev. George Champion. The box also contained several other articles of interest in Botany and other parts of Nat. Hist.

Beautiful Beryls from Haddam, Ct. From Prof. J. Johnston, Wesleyan University.

A box of Chinese curiosities. From Rev. Dr. Parker, Canton, China. This box was detained in N. Y. Custom House, six mo's. or it would have been sooner noticed.

An Alligator in alcohol, from S. Carolina. W. T. Hatch, Esq.

Several rare Cape Bulbs *Gladiolus Ixia Sparaxis*, and also seeds and flowers of several species of *Zeranthemum Ammobum*, &c. From Rev. George Champion, through Mrs. J. Bliss, Boston.

A box of Fossils from Niagara. From Mr. Strong.

Box of Bituminized Wood from the banks of the Mississippi. From Prof. Carpenter, Jackson College, La.

Box of Fossils from Alabama. From Miss Shedden to Yale Nat. History Society.

NEW EDITION OF DR. MANTELL'S WONDERS OF GEOLOGY.

A full notice was given of this work in our Vol, xxxiv, p. 387, and we announced in Vol. xxxv, p. 384 that arrangements had been made with the author and his publishers, by which Mr. A. H. Maltby of New Haven would publish the new edition in this country as soon as it could cross the ocean, and that by the author's approbation it would appear under the direction of Prof. Silliman, with introductory remarks by him; the proper type and illustrations to be identical with those of the London edition. This work is now received in an enlarged and improved edition: it has 10 plates and sections, of which six are colored, and nearly 100 additional engravings. While it is full and exact in science, it is without doubt the most attractive and interesting work on Geology which has ever been published. It does not interfere with the excellent treatises of Bakewell, Lyell, Murchison, De la Beche, Daubeny and other eminent geologists; it occupies a peculiar niche of its own, and reflects both the image of geological nature and of the author's own elegant and accomplished mind. Without any other than a friendly interest in these volumes, we cordially recommend them, as being equally instructive and delightful.—*Eds.*

THE
AMERICAN
JOURNAL OF SCIENCE, &c.

ART. I.—*Meteorological Observations during a Residence in Colombia, between the Years 1820 and 1830.** By Colonel RICHARD WRIGHT, Governor of the Province of Loxa, and Confidential Agent of the Republic of the Equator, &c. &c.

IF the materials of science could be gathered only by the scientific, the following collection of observations would be a useless labor; but it frequently happens that, in distant countries, the opportunity of observing natural phenomena falls to the lot of those very ill fitted in most respects to profit by it. The genius of Humboldt, like an incantation of science, descends upon the New World but once in a series of ages. The most that can be done by an ordinary observer, is to offer his mite,—a single stone towards the pyramid of knowledge,—in the hope that he may casually prove useful; and with such humble pretensions can scarcely be deemed importunate. Should even this apology barely extenuate the sterility of a ten years' residence in a country so admirably varied and rich in natural phenomena as Colombia, something farther may be urged in excuse of the *military* traveller, obliged frequently to *hurry* through the most interesting parts, and to vegetate whole years in others of minor importance; without books, without instruments, without resources; fettered too often by the chain of his own daily wants and sufferings; and

* From the London and Edinburgh Philosophical Magazine and Journal of Science, Vol. 14, No. 85, January, 1839.

fallen on a time when every species of local and traditional information, every glimmering of philosophic research had been buried and obliterated amid the storms and struggles of the revolution.

The geographical features of Colombia have been portrayed by Humboldt with an accuracy which renders further description superfluous. It is, however, impossible to traverse this extensive territory, without being struck by the physical phenomena of a country where *height* produces the effect of *latitude*, and where the changes of climate, with all the consequent revolutions of animal and vegetable life, are brought about by localities to which we find little analogy in Europe. The equatorial seasons, as is well known, are merely the wet and dry; and though the Spaniards, influenced by European recollections, have given the former the name of winter *invierno*, it is during this period that nature revives from the vegetative torpor which the scorching tropical heats produce in the lowlands in almost an equal degree with the frosts of northern climates. In the vast plains which extend to the south and east of the great chain of the Andes, the rainy season observes an invariable order. The Orinoco begins to rise in April, and attains its maximum of increase in July and August, when the immense savannas which extend to the base of the Andes are converted into the appearance of an inland ocean. It decreases from this period, and the summer is reckoned from October to April. In the mountains, on the contrary, the rains commence about the former month, and predominate, with intervals of fair weather, till May or June. The winter of the low lands, to the west and north of the Cordillera, both on the Pacific and Atlantic coasts, is governed by that of the mountains, but with several curious localities. Thus, the rainy season of Guayaquil is nearly as regular as that of the plains, being reckoned from the middle of December to the middle of May; while the thick forests, which further to the north cover the provinces of Esmeraldas, Barbacoas, and Choco, produce, by their constant evaporation, an almost perpetual deluge. Wherever, on the contrary, the Cordillera recedes to some distance from the coast, as is the case with parts of the Venezuelan chain, the intermediate country is parched often by a drought of several years. Maracaybo, and a considerable part of the province of Coro, are instances where sandy plains, scantily shaded by *Mimosas* and

thick plants, afford shelter and subsistence only to flocks of goats and asses. The coast of Rio Hacha is equally dry and sterile, till it approaches the foot of the isolated ridge of Santa Marta; while the Goagira territory, situated betwixt Rio Hacha and Maracaybo, is regularly inundated every year, and consequently, though destitute of streams, maintains considerable herds of cattle and horses; a circumstance to be ascribed to the vicinity of the Ocaña branch of the Andes, which extends, with its clouds and thick forests, almost to the confines of this province. The whole Peruvian coast from Payta to Lima, is an additional instance of the same fact, where the recession of the Andes from the coast is marked by sandy deserts, which the industry of the Incas had rendered productive by artificial irrigation. In the valleys and on the table lands of the mountains themselves, the culminating summits produce great variations in the distribution of moisture. The city of Caraccas, situated at the foot of the Silla, has the benefit of a regular though mild rainy season, while within a league there are spots which suffer several years of drought. Popayan, placed at the head of a sultry valley of the Cauca, and surrounded by lofty *paramos*, has nine months of continued rains and tempests, attributable to the clouds which are driven in opposite directions from the mountains till they encounter the hot ascending air of the valley. In the ancient kingdom of Quito, now called the Republic of the Equator, the mass of Chimborazo interrupts the passage of the clouds from south to north; so that, while the western slopes are deluged with rain, the elevated plains of Riobamba to the east recall to the imagination of the traveller the deserts of Arabia Petræa. Following the same mountain chain towards the city of Quito, we observe the storms arrested between Cotopaxi and Pichinca, over the valley of Chillo; while two leagues farther to the north, the climate of the village of Pomasqui is so dry as to have given it the name of Piurita (little Piura.)

The manner in which rain is formed and precipitated at various elevations, seems to illustrate and confirm the theory of Leslie. In the region of *paramos*, i. e. from 12,000 feet upwards, the encountering aërial currents, unless in the case of some strong agitation of the mass of surrounding atmosphere, are of low and nearly equal temperature. The rains in consequence assume the form of thick drizzling mists, known by the name of *paramitos*.

On the elevated plains we find the showers more or less sudden and violent, according to localities which give rise to a mixture of currents more or less variably heated. Quito, for example, is situated on what may be called a *ledge* of the lofty mountain of Pichincha, and overlooks the valley of Chillo of Guailapamba, furrowing the adjacent table land, on which the thermometer often rises to 80° in the shade. The encounter of portions of the atmosphere, thus variously heated, produces showers as sudden and heavy as those which generally distinguish tropical climates. On the slopes of the Cordillera the rains are generally violent for the same reason. Looking to the hygrometrical state of the atmosphere, as it results from observations made on the table lands of the equator and the coast of the Pacific, we find it to vary from 0° in the damp forests of Esmeraldas to $97^{\circ}\cdot 1$ on the elevated plain of Cayambe; the experiments in both places being made during June and July, the summer months both of the coast and mountains. The average medium for the low lands is $23^{\circ}\cdot 85$; for the Cordillera $44^{\circ}\cdot 36$ of the hygrometer constructed upon Leslie's principle; but we are in want of sufficient *data* for those elevations which approach to the limit of perpetual snow. To judge, however, from a small number of observations made on the mountain of Cayambe at 12,705 and 14,217 feet of elevation, and at the hut of Antisana at 14,520 feet, where the hygrometer was found to give $16^{\circ}\cdot 5$, $13^{\circ}\cdot 9$, and $30^{\circ}\cdot 3$, it would not seem that the dryness of the atmosphere increases in ratio of the elevation; at least, in the neighborhood of snowy mountains, where a continual moisture is exhaled, and heavy mists sweep over the soil towards evenings even of the fairest days.

To estimate the general distribution of temperatures through the vast territory of Colombia, we may conveniently consider it as divided into five zones. 1st. That of the level, or nearly so, of the ocean. 2nd. That of the small elevations, from 500 to 1,500 feet. 3rd. That of the slopes of the Cordillera, from 2,000 to 7,000 feet. 4th. That of the elevated plains, or table lands, from 8,000 to 10,000 feet; and 5th, That of the *paramos*, from 11,000 feet to the limit of perpetual snow.

1. The degree of heat at or near the level of the ocean is modified by a variety of local circumstances, which may be ranged under the following heads: proximity of the sea; of great rivers and lakes; of lofty ridges of mountains; of extensive forests; of

contiguous elevations which impede the circulation of air, and produce reflected heat. The various combinations of these circumstances may be considered as affording a rule of the increase or diminution of temperature. Thus, La Guayra, situated on a sandy beach backed by a perpendicular wall of rocks, has no counterpoise to the excess of heat but the sea breeze, and the remote influence of the ridge of the Silla, which no where reaches the limit of perpetual snow. Humboldt considers it in consequence as the hottest place on the shores of the New World, (Personal Narrative, vol. iii, p. 386,) the mean annual temperature being $82^{\circ}\cdot6$; yet the observations I made during some months' residence in Maracaybo give an annual mean of $84^{\circ}\cdot63$. Nor is this surprising, when we consider the localities of both places. In Maracaybo the sun's rays are reflected from a barren sandy soil, scantily sprinkled with *Mimosas* and prickly plants. The mountain chains are too remote to have any influence on the atmosphere, so that several years frequently pass without any regular fall of rain. The vicinity of the lake, no doubt, acts slightly as a refrigerant; but the city is built on the border of its outlet to the sea, where it is both narrowest and shallowest, and is consequently heated nearly to the temperature of the incumbent atmosphere. Add to this, the small sandy elevations to the north, which intercept the partial effect of the sea-breezes, so that they are scarcely felt, except in the months of December and January, when the thermometer sometimes sinks to 73° ; yet the medium even of these two months is not less than 81° ; while that of La Guayra from November to December at noon, is, according to Humboldt, $75^{\circ}\cdot8$, and at night $70^{\circ}\cdot9$. (Personal Narrative, vol. iii, p. 387.) Rio Hacha is situated on a sandy beach; the sea-breeze blows with such violence that boats can scarcely land between ten in the morning and four in the afternoon. These winds, however, sweeping over the hot plains of Coro and Maracaybo, have but a partial effect in lowering the temperature, the annual mean of which is $1^{\circ}\cdot98$ less than that of Maracaybo. I never saw the thermometer lower than 75° , nor above 89° . In Santa Marta the average of the coolest months is $82^{\circ}\cdot25$. The thermometer, however, never rose during my residence there above 87° . The soil is sandy, and the city is surrounded by bare rocky heights to the north and south, which counterpoise the cooling influence of the *Sierra nevada*, (snowy mountains,)

from which it is but a few leagues distant. The temperature of Barranquilla, a village situated on the river Magdalena, about eighteen miles from its mouth, is nearly the same with that of Santa Marta; for if, on the one hand, the air is refreshed by the evaporation from a damp soil covered with luxuriant forests and the vicinity of a large river, on the other, it is beyond the reach of the sea-breeze, and the influence of the mountains which operate in Santa Marta. The annual mean is $82^{\circ}\cdot20$. That of Cumana is, according to Humboldt, 81° . The breezes which sweep from the gulf of Paria over the wooded Brigantine chain, probably contribute to lower the temperature.

We have thus, on a calculation of six points on the Atlantic coast of Colombia, a mean annual temperature of $82^{\circ}\cdot56$.* The shores of the Pacific, as far as the latitude of Payta, are subjected to other influences, being almost entirely covered by damp, luxuriant forests; while the ocean itself is cooled, as Humboldt observes, by the winds which blow continually from the south. This, however, is more perceptibly the case from latitude 8° to 13° , where the air is cooled to an average of $71^{\circ}\cdot8$ (Humboldt *De Distributione Geog. Pl.* p. 92.) Betwixt 9° N. lat. and 3° S. lat. if we may trust to observations made at the five points of Panamá, Esmeraldas, El Morro, the island of Puná, and Guayaquil, the annual mean is $80^{\circ}\cdot11$, being $2^{\circ}\cdot45$ less than the mean of the Atlantic coast. A notable difference also arises from the superior elevation of the Pacific chain of the Andes, and its more immediate vicinity to the coast, while the Venezuelan branch, with the exception of the Santa Marta ridge, is both lower and more inland. A curious exception to the general temperature of the Pacific coast, may be found on passing Punta Galera and Cabo San Francisco (lat. $50'$ N.) to the south. The sky is here almost perpetually clouded, and a drizzling rain falls through the greater part of the year. During a week I passed there I never saw the sun; and the average temperature was only $74^{\circ}\cdot14$. This was the more striking, as along the coast, immediately to the north of Punta Galera, the weather was constantly dry and the sky clear. The miry state of the road across the point of the Cape of

* I have not included Cartagena, because the number of observations is perhaps too limited to draw a conclusion as to the yearly temperature. If we take them into the calculation, the annual mean would be $82^{\circ}\cdot86$, which is probably too high.

San Francisco indicates the line of separation betwixt two distinct climates. It will be seen by the map, that from P. Galera the coast, after running nearly due west, turns abruptly to the south.

2. On penetrating into the interior of the country, and examining the temperature of small elevations, we may take, as forming an aggregate specimen of the whole country : 1. The damp wooded valleys of the Orinoco and Magdalena ; 2. The forests which border on the Pacific ; and 3. The immense plains of Venezuela, alternately flooded and parched with excessive heat. Humboldt assigns to the valley of the Orinoco a mean temperature of $78^{\circ}\cdot 2$. The small number of observations I have made on that of the Magdalena, would give a mean of nearly 83° , which I should scarcely think too high, considering the localities of the river, which, flowing from south to north, affords no channel to the sea-breezes. Its mass of water is also much less considerable than that of the Orinoco ; while its numerous sinuosities, and the low ridges which border it in the upper part of its course, contribute to render the air stagnant and suffocating. The temperature of Honda, at 1,200 feet of elevation, is as high as that of any part of the coast except Maracaybo. The unbroken forests which extend from the roots of the Quitenian Andes to the shores of the Pacific have a much lower temperature, caused by the proximity of the snow-capped Cordillera, and the humidity which prevails throughout the year. Accurate observations give an annual mean of $76^{\circ}\cdot 78$, or $1^{\circ}\cdot 42$ lower than the valley of the Orinoco, and $6^{\circ}\cdot 22$ lower than that of the Magdalena. The mean temperature of the plains of Venezuela is reckoned by Humboldt at $88\cdot 4$, (*De Distributione Geog. Plant.* p. 92. ;) yet several reasons may induce the belief that this calculation is excessive. This illustrious traveller performed his journey during the summer season, when the atmosphere is heated by the reverberations from a parched and naked soil. Persons who have resided near the Apure, state the climate in rainy weather to be cool, and refreshed by a constant breeze. It is only on the coast of the Pacific that the rainy season is the period of the greatest heat, when the air is still, and undisturbed by those electric explosions so common on the mountains and in the interior. The observations I made at Varinas and San Carlos, towards the beginning of the winter season, give a mean of 81° ; and averaging

the dry season at $88^{\circ}\cdot4$, we have a yearly mean of $84^{\circ}\cdot7$, which is probably the extreme, or something beyond it. There is no doubt it is in the plains of the interior we find the greatest heat during the dry season. In the level country, called the valley of Upar, betwixt the mountain ridges of Santa Marta and Ocana, I found the thermometer in the shade several times above 100° , and once as high as 108° . The average of nineteen observations made at different points of this district is $89^{\circ}\cdot9$; but we must allow a considerable decrease during the months when the soil is covered with thick vegetation, and drenched by continual rains. As a general mean of the interior, at small elevations, we may take $80^{\circ}\cdot67$, or nearly that of Cumanà.

3. The temperate mountain region lies nearly betwixt the elevations of 3,000 and 7,000 feet. Below this may be considered as a hot climate, such, for instance, as Valencia and the valleys of Aragua in Venezuela, the height of which is from 1,500 to 2,000 feet, and its mean temperature 78° , or $0^{\circ}\cdot24$ above that of Guayaquil on the Pacific; but the soil, stripped by cultivation of its ancient forests, imbibes freely the solar rays, which are besides reflected from the rocky elevations which every where surround the cultivated districts. The temperature of Caraccas (elevation 2904 feet) was fixed by Humboldt in his *Essay De Distributione Geographica Plantarum*, p. 98, at $69^{\circ}\cdot6$; but in his *Personal Narrative*, b. iv, c. xii, p. 460, he considers $17^{\circ}\cdot2$ of Reaumur = $70^{\circ}\cdot40$ of Fahrenheit, nearly as the true yearly mean. My own observations during a residence of some months give $71^{\circ}\cdot40$. The preference would be certainly due to Humboldt's calculation, but for some collateral circumstances deserving attention. I heard it generally remarked in the city, that the seasons had grown *hotter* since the earthquake of 1812. It would be difficult to explain how the temporary evolution of volcanic gases, supposing such to have taken place, could operate any permanent change on the surrounding atmosphere; yet other causes may have produced an effect falsely ascribed to the phenomenon most impressed on the imagination of the inhabitants. On looking over Humboldt's collection of observations for December and January, 1799, we find the thermometer seldom rise to 75° , and often sink to 59° ; so that the mean of these months is about 68° . During the same months in 1821, the daily range was from 65° to 76° . I never observed it lower than $61^{\circ}\cdot5$, and on one occa-

sion, at 5 a. m., it stood at $61^{\circ}\cdot 0$. The mean of these two months is $70^{\circ}\cdot 21$, or $2^{\circ}\cdot 21$ higher than the estimate of Humboldt. The clearness and beauty of the sky, during almost the whole period of my residence, is also a circumstance opposed to Humboldt's "*cælum sæpe nubibus grave quæ post solis occasum terræ appropinquant.*" *De Distributione Geog. Plant.* p. 98. I remember but once to have seen a fog in the streets of the city. Future observations will show whether any change of climate has really taken place, or whether the differences observed be only such variations as may be frequently remarked in the same place betwixt one year and another. The mean of the whole temperate mountain region may be reckoned at $67^{\circ}\cdot 80$; that is, if we limit ourselves to the districts partially cultivated and inhabited. The declivities of the Andes, still covered with vast and humid forests, have probably their temperature proportionably lowered. Thus the village of Mindo, on the western declivity of Pinchinca, embosomed in humid forests, at 3,932 feet of elevation has a medium temperature of $65^{\circ}\cdot 5$, the same with that of Popayan.

4. The elevated plains of the Andes, betwixt 8,000 and 11,000 feet, on which were anciently united the most powerful and civilized indigeuous nations beneath the dominion of the Zipas of Tunja and Bogotà and the Incas of Quito, and where the great mass of Indian population is still to be found, have a general medium temperature of $59^{\circ}\cdot 37$, modified however by local circumstances, and particularly by the proximity of the *Nevados*. Thus the village of Guaranda, placed at the base of Chimborazo, though nearly 500 feet less elevated, is at least one degree colder than the city of Quito, sheltered on all sides by the ramifications of Pichincha. The city again is above one degree warmer than its suburbs on the plains of Anaguito and Turupamba to the north and south. Riobamba is about two hundred feet below Quito; yet its situation on an open plain, bordered by the snowy mountains of Chimborazo, Tunguragua, and La Candelaria, renders the climate colder and more variable; while the town of Hamba-to, only 300 feet lower than Quito, but built in a nook of the river which runs near it, and shut in by dry, sandy elevations, has a climate about $2^{\circ}\cdot 0$ warmer; so that sugar-cane is cultivated in its immediate vicinity. The general uniformity of temperature, which spreads a certain monotony over tropical regions, is joined, at great elevations, to a daily variability which must

exercise a considerable influence both on vegetable and animal life. The thermometer, which often sinks at night to 44° , rises in the sun wherever there is a reflected heat, frequently to 120° , being equal to the heat of Jamaica; while in the shade, it seldom exceeds 65° ; so that, on passing from shade to sunshine, one is immediately exposed to a difference of above 50° , and, in the course of twenty-four hours, to nearly 80° . The shade, in consequence, even on the hottest days, imparts a feeling of chilliness; while the solar rays seem to scorch like the vapor of a heated oven. The same difference is perceptible on the *paramos*. At the foot of the *Nevado* of Santa Marta I observed the thermometer at 5 a. m. sink to 22° ; at 9 a. m. it rose to 73° in the sun. On the height of Pichan, betwixt Quito and Esmeraldas, elevation 12,986 feet, the thermometer stood at 53° in the shade, and 83° in the sun. On Antisana, the difference was 22° at the same time, but 34° betwixt 6 a. m. and 3 p. m. When the atmosphere is calm it is much more considerable.

5. Although at great elevations, i. e. from 12,000 to 16,000 feet, it is difficult to form a series of meteorological observations, such is the yearly equality of the temperature, that a single day may be safely taken as a sample of the whole year; nay, more, a collection of observations made at similar heights, though in different places, will give a similar result to a series taken on the same spot. Thus in the following table there is little difference betwixt the result of eight observations made on seven different mountains, and the six made on that of Antisana:

1.	Paramo of Santa Marta	15,000 ft.	22°	5 $\frac{1}{2}$	A. M.
2.	Paramo of Cayambe	12,705	$37^{\circ}.6$	"	"
3.	Paramo of El Altar	12,986	$42^{\circ}.8$	"	"
4.	Mine of Condorasto	14,496	$45^{\circ}.0$	12	"
5.	Volcano of Pichincha	15,705	$46^{\circ}.0$	1	P. M.
6.	Mountain of Atacaso	14,820	$41^{\circ}.0$	"	"
7.	Nevado of Cayambe	14,217	$43^{\circ}.0$	1 $\frac{1}{2}$	"
8.	Paramo of Antisana	14,520	$38^{\circ}.58$	6	" observations.
	General mean		39°		

Although it scarcely falls within the limits of a mere meteorological journal to expatiate on the wide field of inference which opens to our view, when we reflect on the influence of temperature, not merely on animal but on social life, yet the operation of local circumstances has been so striking, and will probably play so important a part in the future destinies of the South American continent, that it is difficult to forbear some remarks on so interesting a subject.

Climate is one of the first agents which operates upon the propagation of the human race over the face of the globe, presenting itself sometimes as a benignant conductor, at other times raising a hostile barrier which science and industry slowly overcome. The Spaniards who people that part of South America now under consideration, as soon as they had formed on the coast the establishments necessary to preserve their connection with the mother country, seem to have traversed hastily the fertile but insalubrious lowlands to meet on the Cordillera a temperature adapted to their habits and constitutions. The dominion of the Incas had, upon similar principles, extended itself along the immense ridge; and the descendants of the conquerors and conquered are, to this day, found united on the same elevations, from whence the population has descended gradually into the plains; and would have done so much more slowly, but for the importation of the African race, who find on the sandy coast and sultry savanna a climate congenial to their constitution. It may be a matter of curiosity to inquire, why that portion of the *bronzed race* which constituted the empire of the Incas and of the Lipas has constantly exhibited a constitutional type so different from the tribes of the same race now thinly scattered through the plains and valleys. The dominion of the Incas could scarcely be said to have established itself in the lowlands. With the exception of the dry narrow track of the Peruvian coast, their empire was exclusively of the mountains; and Indians who speak the *Quichua*, or general language of the Incas, still manifest the same preference for cold and elevated situations; sleeping in the open air rather than under a roof, and exhibiting an insurmountable repugnance to descend into the hot country, where they fall victims more rapidly than even the Europeans. The latter, although commercial interests have led them to form establishments on the coasts, and more partially on the great rivers, may be said to live in a state of perpetual hostility with the climate. Their complexions become sallow, their frames feeble; and although, where heat is uncombined with great moisture, as in Cumanà, Coro and Maracaybo, they are subject to few diseases of a violent character, the strength is gradually undermined, and the species may be rather said to vegetate than to increase. The individuals of African race, who complain of cold when the yearly mean is 75° , alone develop all the physical strength and energy of their character in the hot

lowlands of the coast and interior. The mixed race, or people of color, unite to bodily hardihood intrepidity, ambition, and a deadly feeling of those prejudices which, in spite of laws, continue to separate them from the *white* descendants of the Spaniards, who thus encounter, both in the high and lowland, two races in whom the seeds of hostility have been sown by injustice, and fostered by mistaken feelings of interest and vanity.* It is on the mountain slopes of from 3,000 to 7,000 feet that we encounter climates most analagous to our ideas both of health and pleasure. Raised above the noxious miasmata of the coast, we dwell in perpetual summer amid the richest vegetable productions of nature, amid a continued succession of fruits and flowers. This picture, however, must not be considered as universally exact. In those unbroken forests where population has made little progress, the sky is often clouded, and the soil deluged with continual rains. The western declivities of the Andes, which front the Pacific, are particularly exposed to this inconvenience.

It might be expected that with regard to human life and vigor, the elevated plains of the Andes would correspond to the northern countries of Europe. This, however, as far as regards the inhabitants of the European race, does not seem exactly to take place. It is true they escape the billious and intermittent fevers so prevalent in the lowlands; but they are generally subject to typhus, dropsy, goitre, and such complaints as indicate constitutional debility. Nor do we find among them either the muscular strength or longevity of the Indians or Africans; and still less of the nations of northern Europe. Are the diurnal changes of temperature to which they are exposed, less favorable to health than the alternation of European seasons which expose the frame to changes equally great but less rapid? Or must we rather look for the cause in their domestic habits, which exhibit a strange mixture of effeminacy and discomfort?

When we examine the social or political effects of climate and localities, we are struck with their powerful effects on the past struggles and present state of the country. The cities of the coast must be considered as the inlets both of European products and European ideas. Liberal opinions have extended themselves

* It is the people of color, or mixture of Africans with Whites and Indians, who on the plains form the most hardy and warlike part of the population of Colombia.

towards the interior in proportion to local obstacles, i. e. to the greater or less facility of communication. It is this circumstance which marks the difference betwixt Venezuela and the south and the centre of Colombia, indicating a distinct and more rapid career of civilization and prosperity. The branch of the Andes which traverses Venezuela is much inferior in elevation to the ridges of Quito and New Grenada. The whole of the inhabited part of it belongs to the hot country or temperate mountain zone. The following are the heights of the principal towns through its whole extent :

Caraccas	.	.	.	2903 ft.	Mean temp.	71°
Valencia	.	.	.	1495	—————	78
Barquisimeto	.	.	.	485	—————	78
Tocuyo	.	.	.	2058	—————	75
Truxillo	.	.	.	2684	—————	75
Merida	.	.	.	5280	—————	66
Cucuta	.	.	.	about 400	—————	83

The differences of climate and productions betwixt the different parts of the country are consequently trifling, and form no bar to general communication betwixt the coast and interior. There is therefore an amalgamation of ideas, an homogeneity, if we may use the term, in the mass of feelings and opinions on political subjects. The population is not only more enlightened, but, what is of more importance, more equally so. A different state of things presents itself, when we examine the centre and south. The main ridge of the Andes ascends rapidly from the frontier of Venezuela, and, by its direction from north to south, places the population at a continually increasing distance from the sea-ports of the Atlantic ; while its superior elevation producing a different climate and temperature, gives birth to new habits and a distinct nationality. To descend to the coast from these altitudes, is a matter both of risk and difficulty. The line betwixt the *Llaneros* and *Serranos* is strongly drawn, and a separation of character evident. The country from Cucuta to Bogotá through Pamplona and Tunja has a mean elevation of from 8,000 to 10,000 feet, and a temperature of about 59° Fahr. It is true that Bogotá communicates with Europe by the valley of the Magdalena ; but the length and inconvenience of this channel of intercourse render it accessible but to few. Hence the struggle of opinions in New Grenada, where the civilization of the superior class is out of proportion to that of the bulk of the people.

The Quitean Andes afford us another powerful illustration of this view of the subject. The following is the line of elevations between Quito and Chimborazo :

Quito	9,537 feet	59° Fahr.
Llactacunga	10,285	57°
Hambato		61°
Riobamba	9,377	57°
Guaranda	9,075	58°

The roads which descend to the coast of the Pacific are few, almost impassible, and lead to no seaport of importance except Guayaquil. Journeys thither are undertaken with fear and hesitation; and the character of the *Serranos* is marked with all the traits of isolation resulting from the geography of the country.

Next to the direct influence exercised by climate on the frame of man, we may consider it relatively to the facility it affords of nourishing him, and advancing his progress in civilization. The most important presents made by the Old to the New World are cattle and cerealia. The only domesticated quadruped known to the Indians was the llama, which furnished, like the sheep, with thick wool, unwillingly descends or is propagated in the sultry lowlands. The horned cattle of Europe, on the contrary, have multiplied almost equally on the plains as on the *paramos*. On the farm of Antisana, for instance, at an elevation of from 12,000 to 16,000 feet, there is no less than 4,000 head. The herds raised on the plains of Venezuela, as on the *Pampas* of Buenos Ayres, are, or were previous to the revolution, almost countless. Two immense magazines of animal food are thus placed at the two extremes of temperature, in situations uninterfered with by agricultural labor. The horse has been destined to figure in the political changes of the New World. The fear and respect with which he inspired the natives at the period of the Conquest is well known. Horses have since multiplied prodigiously in all parts of the country, but more especially in the plains of Venezuela. There, during the war of independence, Paez, and other guerilla chiefs, at the head of an irregular cavalry, and maintained by the cattle, defied the efforts of the Spanish infantry, and kept alive the embers of the revolution.

The best kinds of horses are those that are bred in the lowlands, and brought to the mountains at about four years old, where they acquire hardihood by the influence of a colder climate, and their

hoofs, accustomed only to soft pastures, are hardened on a stony soil.

The breed of sheep, like that of llamas, is limited to the loftier regions of the Cordillera; while goats multiply more readily on such parts of the low country as are both hot and barren, as in the province of Coro, where they form the chief wealth of the inhabitants.

But while nature facilitates the dispersion over the globe of certain species of animals, she seems to limit others by an impassible barrier. The dog undergoes the fate of his European master; his sagacity and strength decay in a hot climate, and the breed dwindles rapidly into an animal totally inferior in habits and organization. The foresters accordingly, and the Indians of the lowlands, who are accustomed to the chase of the wild hog, bring dogs for the purpose from the mountains, where, though the Spaniards are by no means curious in this particular, a strong species of greyhound, more or less degenerated, is to be met with, and is used in the highlands for stag-hunting.

The influence of temperature, and consequently of local elevation, on vegetable life, was first examined in Colombia by a native of Bogotá, the unfortunate and illustrious D. José Caldas, who fell a victim to the barbarity of Murillo in 1811, in consequence of which his numerous researches in natural history were almost entirely lost, with the exception of some papers published in the *Seminario de Bogotá* in 1808, and fragments still existing in MS. or casually preserved and printed in Europe, to one of which I shall presently have occasion to refer. Humboldt travelled through South America about the same time that Caldas was directing the attention of his countrymen to physical science, and his investigations have fortunately been subjected to a less rigorous destiny. His admirable treatise, "*De distributione Plantarum geographica*," has left for future observers little but to corroborate the accuracy of his views and multiply facts in illustration of his theories.

When we begin our observations from the level of the sea, we find certain families of plants which scarcely ever rise to above 300 or 400 feet: the "*Sandalo*," producing the balsam of Tolu, the *Lecythis*, the *Coccoloba*, the *Bombax*, the *Rhizophora Mangle*, the *Manchineel*. A second and more numerous class push on to about 2,000 feet of elevation; such are the *Plinia*,

the “*Copál*,” the “*Anime*,” the “Dragon’s blood,” the mahogany tree, the “*Guayacán*.” Among plants, the *Cæsalpinia*, *Ipomæa quamoclet*, most of the *Bignonias*, *Portlandias*, the *Vanilla*, *Cassia alata* and *riparia*, the *Pontaderia*, which forms the ornament of tropical rivers. The palms ascend to the height of 5,000 feet; the arborescent ferns, from the level of the sea, amid the damp forest of Esmeraldas, to 7,000 feet. Of cultivated plants the Cacao and indigo are most limited as to elevation, neither of which is cultivated with success at above 2,000 feet. An attempt to raise indigo at Mindo (3,960 feet) completely failed. It would seem that a dry climate is most favorable to indigo, such as is found in the valleys of Aragua near Valencia; while heat and moisture, as Humboldt observes, are particularly required for cacao. Yet cacao cultivated on lands which are flooded part of the year, as is the case with the greater part raised in Guayaquil, is of inferior quality, scarcely producing in the market a dollar per cwt. That of Esmeraldas, on the contrary, where notwithstanding the moisture of the climate, the waters never settle on the soil, is of equal or superior quality to that of the valley of Tuy near Caraccas. In Canigüe, at an elevation of about 1,000 feet, the trees are loaded with fruit in less than two years from the time of sowing the seed; while generally three years is the period at which they are reckoned to commence bearing.

Coffee is abundantly raised from the level of the sea to elevations of 5,000 or 6,000 feet, or even higher in favorable situations. There are plantations near the valley of Banos in Quito at above 7,000 feet.

Cotton requires, according to Humboldt, a mean temperature of not less than 64° — 60° , which would bring it to the elevation of Loxa.

The sugar cane is cultivated in Colombia from the level of the sea to an elevation, which may appear extraordinary, of 7,865 feet in the valley of Banos at the foot of Tunguragua, of 8,500 in the valley of Chillo below Quito, and of nearly 9,000 feet near the town of Hambato. It must be observed, however, with respect to the latter, that the *vegas* or nooks formed by the windings of the river, where alone it is raised, are so sheltered as to produce almost an artificial temperature. A palm tree brought young from Guayaquil flourishes there, and “*Aguacates*,” (the fruit of *Laurus persea*) ripen perfectly, with oranges, limes, and other

fruits which in general are not cultivated at above 6,000 feet. In proportion, however, to the elevation is the time required for ripening the sugar-cane, varying from nine months at the elevation of 1,000 feet, to three years at the elevation above cited.

Plantains and maize are the principal articles of food in the lowlands or hot country, "*tierra caliente*," to use the expression of the natives. The larger variety of plantain, "*Plantano harton*," cannot be cultivated at elevations above 3,000 feet, while the smaller variety "*Camburi*," will ascend to 6,000 feet, maize is perhaps the plant which, of all others, embraces the greatest variety of temperature and elevation. It is cultivated with equal advantage from the level of the ocean to the flanks of the Andes, 0 to 11,000 feet; temperature 80° — 59° . It is true, that in the lowlands it ripens in three months, whereas on the table lands of the Andes, it requires ten; but the grain is larger, and the ear fuller in the cold than in the hot country.

The central or temperate zone of the Andes is distinguished by the *Cinchonas*, the arborescent ferns which precede and accompany the palms nearly, and in the moist forests of the Pacific; entirely to the level of the sea.* At the back of the Pichincha they first appear about 8,500 feet. The *Alstræmerias* and *Calceolarias*, peculiar to the New World, belong to this zone, though the former ascend to 11,000 feet and the latter to 15,000.

The *Cerealia*, with almost all the varieties of European vegetables, belong to this region. Humboldt observes a peculiarity that wheat is grown near Vittoria at the elevation of 1,700 feet, and in Cuba near the level of the sea; (*Geo. Pl.*, p. 161) but it is probable that the reason why the cerealia are cultivated only at elevations where the *Muscæ* disappear, may be the natural inclination of the inhabitants of the warm country to prefer the cultivation of a plant which yields an equal abundance of food with infinitely less labor, not only in the mere cultivation, but in the subsequent preparation. The three great wheat districts in Colombia are the mountain chain of Merida, the elevation of which rarely reaches 5,000 feet; with a general temperature of 72° ; the plain of Pamplona, Tunja, and Bogotà, elevation 8,000 to 10,000 feet; temperature 58° ; and the Quitenian Andes of the same height and temperature. Humboldt has accurately observed,

* Humboldt, who had not visited these forests, confines them to betwixt 800 and 260 hexap. *De Geo. Pl.*, p. 185.

(*Geo. Pl.*, p. 152) that a comparison betwixt annual mean temperatures of Europe and the elevated tropical regions would by no means give a correct state of the climate. Thus, though the mean temperature of the south of France and of Quito be the same, (about 59°) such fruits as peaches, apricots, pears, figs and grapes, which ripen in perfection in the former, although abundantly produced in the latter, never attain their proper size or flavor. The reason is, that the temperature is equal throughout the year. There is consequently no period, as in Europe, of summer heat sufficient to ripen fruit requiring at this season a mean temperature of 65° or 70° . As far, however, as the height of 7,000 feet all kinds of fruit are cultivated with success; and the markets of the colder country are thus constantly supplied from the neighboring valleys or "*calientes*." Humboldt is mistaken in supposing the olive always barren (*semper sterilis manet*, p. 154.) On the Quitenian Andes near Hambato, it produces abundantly, though little attention is paid to its cultivation.

When we ascend above the extreme limit of cultivation, which may be placed at 11,500 feet, and pass the region of the *Barnadesia*, *Hyperica*, *Thibaudia*, *Gaultheria*, *Buddleia*, and other coriaceous leaved shrubs which, at this elevation, form thickets of perpetual bloom and verdure, we enter the region of *Paramos* (13,000 to 15,000 feet) properly so called, which present to the eye unvaried deserts clothed with long grass, constituting the pasture grounds of the Andes. Humboldt is inclined to fix below this region the limit of forest trees; (*Geo. Pl.*, p. 148) and in fact very few are generally met with near this elevation on those flanks of the Cordillera which join the inhabited table lands. But I have observed on crossing the side of Pichincha, towards the uninhabited forests of Esmeraldas, that the forests occur nearly through the whole space which, on the eastern slope, is a naked *paramo*. Is this owing to a difference of climate? Or has the practice of burning the *paramos*, universal in the Andes, together with the demand for fire-wood in the vicinity of large towns, contributed to give this region the bare aspect it has at present? Further observations on the mountain slopes towards Maynas and Macas are necessary to throw light on this point. It is certain from the present aspect of the inhabited plain of Quito, where we meet with a few scattered trees of *Arayan* (*Myrtus*) and artificial plantations of *Capuli*, (*Prunus salicifolia*) we should con-

clude that the region of forests had scarcely ascended to the height of 8,000 feet, yet some of the houses of Quito are still standing, built with timber cut on the spot.

A circumstance which cannot have escaped the notice of those who have ascended towards the limit of perpetual snow, is the variety and luxuriance of the Flora at the very point where the powers of vegetation are on the brink of total suspension. At above 15,000 feet the ground is covered with *Gentianas*, purple, azure and scarlet; the *Drabas*, the *Alchemillas*; the *Culatum rufescens* with its woolly hood; the rich *Ranunculas Gusmanni*; the *Lupinus nanus* with its cones of blue flowers enveloped in white down; the *Sida Pichinchensis* spotting the ground with purple; the *Chuqueraga insignis*; all limited within a zone of about 500 feet, from whence they seem scarcely to be separated by any effort at artificial cultivation. Several attempts I have made to raise the Gentians, *Sida*, and other plants of the summits of the Andes, at the height of Quito, have been invariably unsuccessful. The attempts indeed to domesticate plants in a situation less elevated, is attended with greater difficulties than the transport of plants from one climate to another. Besides the difference of atmospheric pressure, as Humboldt has observed, plants transferred from one elevation to another never meet, for a single day, with the mean temperature to which they have been accustomed; whereas, transferred from one latitude to another, the difference is rather in its duration than in its intensity. It is easier to accustom a plant of the lowlands to this elevation, than to bring down those of the *paramos*. Thus the orange and lemon trees, Aguacates (*Laurus persea*) *Ricinus communis*, *Datura arborea*, all natives of the hot lowlands, grow and flourish, more or less at an elevation of 8,000 feet above the level of the sea.

On the Method of Measuring Heights by Boiling Water.

It will be observed in the following Journal, that the indication of *heights* is, in most cases, joined with that of boiling water. The former is in fact a deduction from the latter; I had but a confused idea of this method, till, upon my arrival at Quito, I met with a pamphlet of the late D. Francisco José Caldas, (one of the most eminent victims sacrificed by the barbarity of Murillo on taking possession of Bogotá in 1816,) published in 1819 at Bourdeaux, in which he details the steps by which he arrived

at a knowledge of this principle, and the experiments by which he confirmed it. In the year 1801, during a scientific excursion in the neighborhood of Popayan, he happened to break his thermometer; and in attempting to mend it he was led to observe the variability of the extremity of the scale corresponding to the heat of boiling water. His reflections on this subject led him, after various experiments, to the following conclusions: "The heat of boiling water is in proportion to the atmospherical pressure: the atmospherical pressure is in proportion to the height above the level of the sea; the atmospherical pressure follows the same law as the risings of the barometer, or, properly speaking, the barometer shows nothing more than the atmospherical pressure. Boiling water therefore shows it in the same manner as the barometer. It can consequently show the elevation of places in the same manner, and as exactly as this instrument."

Ensayo de una memoria sobre un nuevo metodo de medir las montañas, etc. p. 10. His first experiment in Popayan gave b. w. $75^{\circ}.7$ of Reaumur, the height of the barometer being $22\text{ in. } 11\text{ l.}$ To find then the variation corresponding to one inch of the barometer:

$$28^{\text{in.}} - 22^{\text{in.}} 11^{\text{l.}} = 5^{\circ}.1 \text{ or } 61 \text{ lines.}$$

$$80^{\circ} - 75^{\circ}.7 = 4^{\circ}.3. \text{ Then}$$

$$61^{\text{l.}} : 4^{\circ}.3 :: 12^{\text{l.}} : \frac{4^{\circ}.3 \times 12}{61} = 0^{\circ}.8.$$

Then reversing the process

$$0^{\circ}.8 : 12^{\text{l.}} :: 4^{\circ}.3 : \frac{4^{\circ}.3 \times 12}{0^{\circ}.8} = 64.5 = 5^{\text{i.}} 4\frac{1}{2}$$

Difference betwixt this result and that of the barometer $3\frac{1}{2}$ lines. Satisfied with this commencement, or dawning of a new theory, he began a series of experiments in the mountains near Popayan, taking this city as the centre of his labors, and fixing the elevation of the barometer at $22^{\text{i.}} 11^{\text{l.}} 2$, and boiling water at $75^{\circ}.65$ of Reaumur.

At a spot named Las Juntas I made my first observation. The barometer stood at $21^{\text{i.}} 9^{\text{l.}}$, or $14^{\text{l.}}$ lower than at Popayan; the heat of boiling water was $74^{\circ}.5$ Reaumur. Then

Height of the barometer in Popayan $22^{\text{i.}} 11.2$ B. W. $75^{\circ}.65$

at Las Juntas $21\ 9$ ————— $74^{\circ}.50$

—————
1 2.2

—————
1°.15

1 2.2 = 14^l.2 : 1° .15 :: 12^l $\frac{12 \times 1^{\circ}.15}{14.2} = 0^{\circ}.971$ of Reaumur for 12^l. of the barometer.

I ascended to Paisbamba, a small farm five leagues south of Popayan. Barometer 20ⁱ 9^l.1. B. W. 73° .5.

Barometer in Popayan	22 ⁱ 11 ^l .2	B. W. 75° .65	
in Paisbamba	20 9.1	B. W. 73 .50	

	2 2.1	2° 15	
--	-------	-------	--

2 2.1 = 26^l.1 : 2° .15 :: 12 $\frac{12 \times 2.15}{26.1} = 0^{\circ}.988$ of Reaumur, for 12 lines of the barometer.

I ascended a hill E. of Paisbamba called Sombreros. Barometer 19ⁱ. 6^l.5. B. W. 72° .4.

Barometer in Popayan	22 ⁱ 11 ^l .20.	B. W. 75° .65	
on Sombreros	19 9.05.	B. W. 72 .40	

	3 5.15.	3 .25	
--	---------	-------	--

41^l.15 : 3° .25 :: $\frac{12 \times 3^{\circ}.25}{41.15} = 0.947$ for 12 lines barometer.

I ascended the hill of Tambores : barometer 18ⁱ 11^l.6. B. W. 71° .75.

Barometer in Popayan	22 ⁱ 11 ^l .2.	B. W. 75° .65	
on Tambores	18 11.6.	B. W. 71 .75	

	3 11 .6.	3 .90	
--	----------	-------	--

47^l.6 : 3° .9 :: 12 $\frac{12 \times 3.9}{47.6} = 0.983$ for 12^l barometer.

Proof that above $\frac{9^{\circ}}{10}$ of Reaumur is the true exponent of one inch of the barometer.

I then proceeded to take the observations of Las Juntas and Sombreros, and calculating the exponent anew.

Barometer in Las Juntas	21 9	B. W. 74.60	
in Sombreros	19 6.05	72.40	

	2 2.95	2.2	
--	--------	-----	--

26.95 : 2° .2 :: 12 $\frac{12 \times 2.2}{26.95} = 0^{\circ}.979$ Reaumur for 12 lines of the barometer.

Barometer in Paisbamba	20	9.1.	B. W. 73°.50
in Tambores	18	11.6.	71 .75
			<hr/>
Differences	1	9.5	1°.75

$1.9.5 = 21^l.5 : 1^\circ.75 :: 12 \frac{12 \times 1^\circ.7}{21.5} = 0^\circ.976$ of Reaumur for 12 lines of barometer.

The mean of the six quotients is 0.974, which may be assumed as the exact exponent of 12 lines of the barometer.

Given then the heat of boiling water in any place to find the corresponding elevation of the barometer, and consequently its height above the sea.

As $0^\circ.974 : 12$ lines, so is the difference of the heat of B. W. To ascertain at Popayan the number of inches, lines, &c. of the barometer. Ex. in Tambores, B. W. $71^\circ.15$, to find the corresponding height of the barometer.

B. W. in Popayan	75°.65
in Tambores	71 .75
	<hr/>
	3 .90

$$0.974 : 12 :: \frac{3.9 \times 12}{974} = 48^l.05 = 4.0.05.$$

As Tambores is above Popayan, deduct this quantity from the height of the barometer in that city.

Barometer in Popayan	22	11.20
Deduct	4	00.05
	<hr/>	
Remain	18	11.15 ht. of bar. in Tambores.
Barometrical height observed	18	11.60
Do. by calculation of B. W.	18	11.15
	<hr/>	
Difference		45

a result as exact as can be desired.

Upon this principle I calculated the elevation of the following eleven places :

Popayan,	Poblason,
Juntas,	Buenvista,
Paisbamba,	Hevradura,
Sombreros,	Pasto,
Tambores,	Quito.
Estrellas,	

Memoria, &c. p. 13. et seq.

Working upon the foregoing principle, Caldas adapted to his thermometer a barometrical scale. The product of $0^{\circ}.974$ of Reaumur by 19 is 18.506, or, in round numbers 18.5, i. e. $18^{\circ}.5$ of Reaumur corresponds to 19 inches of the barometer. Then measuring 18.5 from the summit, or 80° of Reaumur's scale, he transferred it to the opposite side of the thermometer, dividing it into 19 equal parts, or inches of the barometer, subdividing these by a nonius into 24 each = half a line of the barometer. In this manner the elevation of the thermometer by boiling water indicates the corresponding elevation of the barometer under the same atmospheric pressure. Caldas observes that Humboldt, to whom he had communicated these ideas, when they met in Popayan, objected the variability of the heat of boiling water under the same atmospherical pressure; to which he replies: "Long practice has taught me its invariability in this respect, using the requisite precautions in making the experiment: otherwise, how could there be equal thermometers? Is not the invariability of the heat of boiling water under the pressure of twenty-eight inches, the foundation of the superior term of all thermometrical scales? It is true that boiling water does not *immediately* acquire its extreme heat, but pushing the operation to its *maximum* its heat is always the same." p. 24.

Caldas did not consider an invariable exponent possible, on account of the variability of atmospheric pressure. The want, however, of a barometer induced me to make some experiments to this effect, by way of rendering this method of measuring elevations still more simple, and of more general use. Is the variability of atmospheric pressure such as to make any important difference in these calculations? Does not water boil constantly at 212° at the level of the sea? At Quito I found the same result as Caldas had several years before; and several times the same result in this and other parts of the Andes. The difference then, is scarcely perceptible in the thermometer, and consequently unimportant in the results of a calculation founded on the heat of boiling water. The thermometer besides, immersed in boiling water, is less liable to a variety of atmospheric influences to which the mercury of the barometer is necessarily subject. Hence the great differences in different barometrical measurements of the same elevations, and the differences observed betwixt different thermometers exposed to the air in the same place,

which I have observed on comparing three together to amount often to $1\frac{1}{2}^{\circ}$, and never to less than $\frac{1}{2}^{\circ}$.

I took the following method to obtain an exponent of the value in feet of each degree of the diminished temperature of boiling water.

The elevation of Quito is, according to Boussingault, 9524; and water boils at $196^{\circ}.25$; $212^{\circ} - 196^{\circ}.25 = 15^{\circ}.5$. $9524 \div 15.75 = 604$ ft. 6. in. nearly. Neglecting the fraction as unimportant, I assumed 604 for the value of the degree, and began my observation on the conical hill of Javirac, which backs the city, and is calculated at 729 feet in height. Water boiled here by two thermometers at 195° . Then $196^{\circ}.25 \div 195 = 1.25$, difference of boiling water between the hill and the city; and $1.25 \times 604 = 755$ feet; difference 26 feet. I next ascended the volcano of Pichincha, and found at the foot of the crater B. W. $186^{\circ}.212^{\circ} - 186^{\circ} = 26^{\circ} \times 604 = 15,730$ feet; and adding 246 feet, the difference between this point and the summit, reckoned at 15,976. There could be little error in the calculation. I next applied this formula to the heights of several places calculated by Humboldt, and where the heat of boiling water had been ascertained by Caldas.

Thus Bogotà, height according to Humboldt	-	-	-	8694 ft.
B. W. according to Caldas $197^{\circ}.6$	-	-	-	8712
				<hr/>
	Difference	-	-	18
Popayan, according to Humboldt	-	-	-	5823
B. W. $202^{\circ}.21$	-	-	-	5922
				<hr/>
	Difference	-	-	99
Pasto, according to Humboldt	-	-	-	8572
B. W. $197^{\circ}.6$	-	-	-	8712
				<hr/>
	Difference	-	-	140 ft.

The differences here are in four points 27 feet, 18, 99, 140. With respect to the hill of Javirac, commonly called *El Panecillo*, I suppose the measurement to have been made by the Academicians. But their calculations generally differ from those of Humboldt, as in the case of Quito; the former giving 9371 feet, the latter 9537; Pichincha 15,606 feet, Humboldt 15,976; Chimborazo 20,583, Humboldt 21,414. But even a difference of sites

is sufficient to account for the 27 feet on ground so unequal as that of Quito. The 18 feet in the height of Bogotà is so trifling a difference, that it rather proves the exactness of my calculation. In Popayan we have 99 feet ; yet the different barometrical measurements of that city differ still more widely. Caldas observes, p. 31, "The Baron de Humboldt's barometer stood in Popayan at 23 3.4, mine at 22 11.2, and Bouguer's at 22 10.7." The most accurate measurements of the peak of Teneriffe, selecting 4 out of 14, leaves a difference of 71 French toises, or rejecting the barometric measurements of Borda, of 18 toises.—*Humboldt, Pers. Nar.* v. 1, p. 160, 170. Saussure is said to have found water boil at 187° on the summit of Mont Blanc, being, according to Humboldt, 15,660 ft. It is 90 ft. only below the point on Pichincha, where I found it to boil at 186° . The elevations nearly equal the difference cannot amount to a degree ; and I consider the error less likely to be on my side, because I was aware of the probable cause of error, and had to deduce the height from the accuracy of the observation. Humboldt in the same manner suspects the accuracy of Lamouroux's observation on the peak of Teneriffe.—*P. Nar.* vol. i. p. 159.

[To be continued.]

ART. II.—*Remarks on the Trilobite* ; by JACOB GREEN, M. D., Professor of Chemistry in the Jefferson Medical College, Philadelphia.

Remarks.—We are informed by the author that the present communication was written originally for this Journal ; but some peculiar circumstances induced him to publish it (March 16, 1839) in the Friend, a weekly Journal of Philadelphia. By the author's request it is now republished with additions.—*Eds.*

THE anatomical structure and physiological history of the whole family of the trilobites are not only involved in great obscurity, but we can scarcely hope that the most persevering efforts of the naturalist will ever be able to penetrate the darkness, or unravel the mysteries, which involve the subject. No department in the science of organic remains has been pursued of late with more zeal and curiosity than this. The trilobite furnishes

the earliest example of an articulated animal found among the ancient inhabitants of our globe, and although in some few existing genera we find certain points of analogy in their organization, the whole race probably became extinct after the subsidence of the great coal formation. Dr. Buckland remarks, "No trilobites have yet been found in any strata more recent than the carboniferous series; and no other crustaceans, except three forms which are also entomostracous, have been noticed in strata coeval with any of those that contain the remains of trilobites; so that during the long periods that intervened between the deposition of the earliest fossiliferous strata and the termination of the coal formation, the trilobites appear to have been the chief representatives of a class which was largely multiplied into other orders and families after these earliest forms became extinct."

From the multitude of trilobites and fragments of trilobites which have been discovered in different parts of the world, most of which present nothing but portions of the upper shell of the fossil, the discovery of the figure of the under side of the animal, and of the form and arrangement of the organs of locomotion, seems almost hopeless. As the solid parts of the animal structure alone are for the most part susceptible of petrification, it is not to be expected the softer portions would leave any traces whatever in the rocks which have entombed and so perfectly preserved these ancient inhabitants of our planet; for these reasons, and some others which we shall presently mention, the legs of the trilobite have been supposed to be soft and very perishable paddles.

Although much controversy formerly existed as to the true nature of the trilobite, it is now admitted by all naturalists to occupy a place among crustaceous animals. The existing genera to which they are most analogous in their general structure are the *serolis*, the *limulus*, and the *branchipus*. In our monograph we announced the discovery of a recent trilobite in the southern seas, near the Falkland islands: this proves to be a species of the genus *serolis* established by Dr. Leach. In the configuration of its upper shell it approaches exceedingly near to that of some of the trilobites; the chief difference between the recent and fossil animal consists in the crustaceous legs and antennæ of the *serolis*. The analogies existing between the *limulus* and our fossil, as we mentioned in another place, have been shown by Dr. Dekay and others.

In further illustration of this subject, we here add, with some slight alterations, from Dr. Buckland's admirable Bridgewater treatise, a considerable part of his section on the trilobites, which exhibits in a very condensed form the facts and opinions which have any bearing on this inquiry. I have greater satisfaction and more confidence in referring to his remarks, than in attempting to offer any thing of a similar nature drawn up by myself. After mentioning that the serolis is the nearest approach among living animals to the external form of trilobites, he adds, the next "approximation to the character of trilobites occurs in the limulus or king crab,* a genus now most abundant in the seas of warm climates, chiefly in those of India, and of the coasts of America. The history of this genus is important, on account of its relation both to the existing and extinct forms of crustaceans; in it there are but slight traces of antennæ, and the shield which covers the anterior portion of the body, is expanded entirely over a series of crustaceous legs. Beneath the second, or abdominal portion of the shell, is placed a series of thin, horny, transverse plates, supporting the fibres of the branchiæ, and at the same time acting as paddles for swimming. The same disposition of laminated branchiæ is found also in the serolis. Thus while the serolis presents a union of antennæ and crustaceous legs, with soft paddles bearing the branchiæ, we have in the limulus a similar disposition of legs and paddles, and only slight traces of antennæ; in the branchipus we find antennæ, but no crustaceous legs; while the trilobite being without antennæ and having all its legs represented by soft paddles, is by the latter condition placed near branchipus

* In my boyhood I was very familiar with the habits of this crustacean, called in the northern States, horse fish—or horse shoe fish, from its form.

On the fine hard sea beach at Fairfield in Connecticut, I was in the habit of taking these animals in great numbers, for the purpose of feeding ducks: the ova being very abundant, and being greedily devoured by the young ducks, after the shell of the animal is crushed or cut open. Their fecundity must have been very great, since a large individual female, (the horizontal diameter of whose shell might have been nine or ten inches,) afforded several gills of spawn. The habit of these animals is to come in with the rising tide, and to walk on the bottom, ascending the shelving beach, until they arrive in shallow water. The pellucid sea at Fairfield, rippling over siliceous sand, enabled me and my puerile companions to see them through the waves, and by wading we easily secured them by seizing the spike or tail, their motion being too slow to admit of their escape. Hundreds of them might have been caught at a single tide, of every size from nearly a foot in diameter to an inch or less—these infants having also the power of travelling on the bottom.—SEN. ED.

among the entomostracous crustaceans, in the order of branchiopods, whose feet are represented by ciliated paddles, combining the functions of respiration and natation.

“In the comparison here made between four different families of crustaceans, for the purpose of illustrating the history of the long extinct trilobites, by the analogies we find in the serolis, limulus, and branchipus; we have a beautiful example, taken from the extreme points of time of which geology takes cognizance, of that systematic and uniform arrangement of the animal kingdom, under which every family is nearly connected with adjacent and cognate families. Three of the families under consideration are among the present inhabitants of the water, while the fourth has been long extinct, and occurs only in a fossil state. When we see the most ancient trilobites thus placed in immediate contact with our living crustaceans, we cannot but recognise them as forming part and parcel of one great system of creation, connected through its whole extent by perfect unity of design, and sustained in its minutest parts by uninterrupted harmonies of organization.

“We have in the trilobites an example of that peculiar, and, as it is sometimes called, rudimentary development of the organs of locomotion in the class crustaceans, whereby the legs are made subservient to the double functions of paddles and lungs. The advocate for the theory of the derivation of existing more perfect species, by successive changes from more simple ancient forms, might imagine that he sees in the trilobite the extinct parent stock, from which, by a series of developments, consecutive forms of more perfect crustaceans may, during the lapse of ages, have been derived; but according to this hypothesis, we ought no longer to find the same simple condition as that of the trilobite still retained in the living branchipus, nor should the primeval form of limulus have possessed such an intermediate character, or have remained unadvanced in the scale of organization, from its first appearance in the carboniferous series, through the midway periods of the secondary formations, unto the present hour.

“Besides the above analogies between the trilobites and certain forms of living crustaceans, there remains a still more important point of resemblance in the structure of their eyes. This point deserves peculiar consideration, as it affords the most ancient, and almost the only example yet found in the fossil world, of the preservation of parts so delicate as the visual organs of animals that

ceased to live many thousands, and perhaps millions of years ago. We must regard these organs with feelings of no ordinary kind, when we recollect that we have before us the identical instruments of vision, through which the light of heaven was admitted to the sensorium of some of the first created inhabitants of our planets.

“The discovery of such instruments in so perfect a state of preservation, after having been buried for incalculable ages in the early strata of the transition formation, is one of the most marvellous facts yet disclosed by geological researches; and the structure of these eyes supplies an argument, of high importance in connecting together the extreme points of the animal creation. An identity of mechanical arrangements, adapted to the construction of an optical instrument, precisely similar to that which forms the eyes of existing insects and crustaceans, affords an example of agreement that seems utterly inexplicable without reference to the exercise of one and the same Intelligent Creative Power.

“Professor Müller and Mr. Straus have ably and amply illustrated the arrangements, by which the eyes of insects and crustaceans are adapted to produce distinct vision, through the medium of a number of minute facets, or lenses, placed at the extremity of an equal number of conical tubes, or microscopes; these amount sometimes, as in the butterfly, to the number of 35,000 facets in the two eyes, and in the dragon-fly to 14,000.

“It appears that in eyes constructed on this principle, the image will be more distinct in proportion as the cones in a given portion of the eye are more numerous and long; that, as compound eyes see only those objects which present themselves in the axes of the individual cones, the limit of their field of vision is greater or smaller as the exterior of the eye is more or less hemispherical.

“If we examine the eyes of trilobites with a view to their principles of construction, we find both in their form, and in the disposition of the facets, obvious examples of optical adaptation.

“In the *asaphus caudatus* each eye contains at least 400 nearly spherical lenses fixed in separate compartments on the surface of the cornea. The form of the general cornea is peculiarly adapted to the uses of an animal destined to live at the bottom of the water: to look downwards was as much impossible as it was unnecessary to a creature living at the bottom; but for horizontal vis-

ion in every direction the contrivance is complete. The form of each eye is nearly that of the frustrum of a cone, incomplete on that side only which is directly opposite to the corresponding side of the other eye, and in which, if facets were present, their chief range would be towards each other across the head, where no vision was required. The exterior of each eye, like a circular bastion, ranges nearly round three fourths of a circle, each commanding so much of the horizon, that where the distinct vision of one eye ceases, that of the other eye begins, so that in the horizontal direction the combined range of both eyes was panoramic.

“If we compare this disposition of the eyes with that in the three cognate crustaceans,* by which we have been illustrating the general structure of the trilobites, we shall find the same mechanism pervading them all, modified by peculiar adaptations to the state and habits of each; thus in the branchipus, which moves with rapidity in all directions through the water, and requires universal vision, each eye is nearly hemispherical, and placed on a peduncle, by which it is projected to the distance requisite to effect this purpose.

“In the serolis, the disposition of the eye, and its range of vision, are similar to those in the trilobite, but the summit of the eye is less elevated; as the flat back of this animal presents little obstruction to the rays of light from surrounding objects.

“In the limulus, where the side eyes are sessile, and do not command the space immediately before the head, two other simple eyes are fixed in front, compensating for the want of range in the compound eyes over objects in that direction.

“In the above comparison of the eyes of trilobites, with those of the limulus, serolis, and branchipus, we have placed side by side, examples of the construction of that most delicate and complex organ, the eye, selected from each extreme, and from a midway place in the progressive series of animal creations. We find in trilobites of the transition rocks, which were among the most ancient forms of animal life, the same modifications of this organ which are at the present time adapted to similar functions in the living serolis. The same kind of instrument was also employed in those middle periods of geological chronology, when the secondary strata were deposited at the bottom of a warm sea,

* See annexed the plates of Dr. Buckland, which being important to the just comprehension of the subject, we have caused to be copied.—EDS.

inhabited by limuli, in the regions of Europe, which now form the elevated plains of central Germany.

“ The results arising from these facts, are not confined to animal physiology ; they give information also regarding the condition of the ancient sea and ancient atmosphere, and the relations of both these media to light, at that remote period when the earliest marine animals were furnished with instruments of vision, in which the minute optical adaptations were the same that impart the perception of light to crustaceans now living at the bottom of the sea.

“ With respect to the waters wherein the trilobites maintained their existence throughout the entire period of the transition formation, we conclude that they could not have been that imaginary turbid and compound chaotic fluid, from the precipitates of which some geologists have supposed that the materials of the surface of the earth to be derived ; because the structure of the eyes of these animals is such, that any kind of fluid in which they could have been efficient at the bottom, must have been pure and transparent enough to allow the passage of light to organs of vision, the nature of which is so fully disclosed by the state of perfection in which they are preserved.

“ With regard to the atmosphere also we infer, that had it differed materially from its actual condition, it might have so far affected the rays of light, that a corresponding difference from the eyes of existing crustaceans would have been found in the organs on which the impressions of such rays were then received.

“ Regarding light itself also, we learn from the resemblance of these most ancient organizations to existing eyes, that the mutual relations of light to the eye, and of the eye to light, were the same at the time when crustaceans endowed with the faculty of vision were first placed at the bottom of the primeval seas, as at the present moment.

“ Thus we find among the earliest organic remains, an optical instrument of most curious construction, adapted to produce vision of a peculiar kind, in the then existing representatives of one great class in the articulated division of the animal kingdom. We do not find this instrument passing onwards, as it were, through a series of experimental changes, from more simple into more complex forms ; it was created at the very first, in the full-

ness of perfect adaptation to the uses and condition of the class of creatures, to which this kind of eye has ever been, and is still appropriate.

“If we should discover a microscope, or telescope, in the hand of an Egyptian mummy, or beneath the ruins of Herculaneum, it would be impossible to deny that a knowledge of the principles of optics existed in the mind by which such an instrument has been contrived. The same inference follows, but with cumulative force, when we see nearly four hundred microscopic lenses set side by side, in the compound eye of a fossil trilobite; and the weight of the argument is multiplied a thousand fold, when we look to the infinite variety of adaptations by which similar instruments have been modified, through endless genera and species, from the long lost trilobites, of the transition strata, through the extinct crustaceans of the secondary and tertiary formations, and thence onward throughout existing crustaceans, and the countless hosts of living insects.

“It appears impossible to resist the conclusions as to unity of design in a common Author, which are thus attested by such cumulative evidences of Creative Intelligence and Power; both, as infinitely surpassing the most exalted faculties of the human mind, as the mechanisms of the natural world, when magnified by the highest microscopes, are found to transcend the most perfect productions of human art.”

We now proceed to the more immediate object of this communication, which is to describe a portion of the under side of the fossil animal, which we have named in our monograph *calymene bufo*.

Some time since, my attention was directed by Dr. J. J. Cohen, of Baltimore, to a number of fragments of the heads of this species, obtained from the vicinity of Berkley, Va., and which are still preserved in his cabinet. Three or four of these fragments seemed to disclose the configuration of the whole lower surface of the buckler, in a more or less perfect state. Within a few months, another friend brought for my examination, a fine large head of the same species, from the same locality, and which exhibited the under side or thorax, in quite a perfect state of preservation. All the fragments have precisely the same structure, so that there can be no doubt, we have now the external configuration of the entire head or buckler of the *calymene bufo*.

The anterior edge of the buckler of this species, as has been often observed, is marked by a deep groove or furrow, produced apparently by the junction of the upper and the under shell at this place, and which at first sight looks like the *mouth* of the animal; indeed, Professor Brongniart calls the elevated ridges on each side of this groove the *lips*. The *mouth* was, however, placed no doubt much farther beneath. These *lips*, perhaps, indicate the separation of the shell, through which the trilobite crept out, and left his cast-off covering in the same manner as recent crustaceans leave their exuviae. We know that the *limulus polyphemus* creeps through a somewhat similar opening, made along the whole anterior edge of his buckler.* In all our fragments, which exhibit the under surface of the buckler, the lower *lip* is reflected beneath, so as to form a kind of scroll or rolled edge, extending from one side or angle of the head to the other. Beneath this, and passing backwards towards the tail, the surface of the shell is not flat and horizontal as in the *isotelus* and *limulus*; but it swells up on each side, below the oculiferous prominences, into a kind of oval pouch, diminishing in breadth as it recedes, and at last terminates in a rounded point, below the second articulation of the vertebral column. This is the position of the gular pouch or plate, when the animal assumes a creeping or swimming attitude; but when rolled up in the form of a ball, for the purpose of defence, then the gular plate being composed of a single piece, and therefore not contractile, reached below the fourth articulation of the back. Some of our specimens illustrate this conformation in a very satisfactory manner. None of our fragments exhibit fairly the small surface on each side of the gular plate, and the edge of the buckler beneath the eyes. This space was probably slightly concave, and occupied with the mandibles and their palpi, as in the genus *serolis*—the mouth being no doubt placed near the rounded termination of the gular pouch.

Thus we have at last discovered nearly the whole inferior surface of the buckler of the genus *calymene*, a portion which includes about one third of the animal. Not the slightest impression or other vestige of antennæ can be perceived, and we may therefore pretty confidently conclude, that this genus of trilobites were destitute of those organs. Professor Demarest, in his his-

* See Dr. Dekay. *Annals of Natural History*, vol. 1.

tory of fossil crustacea, seems to have ascertained by his useful and ingenious researches, that the irregularities of the external shells in the living species of crustaceans have a constant relation to distinct compartments in their internal organization, and by the application of these distinctions to fossil species, he has been enabled to draw some highly curious, novel, and important conclusions respecting their internal and general structure. From my limited knowledge of the anatomy and the habits of our living crabs, I would merely suggest, that the peculiar organ in the animal economy of the trilobite, which the gullar plate above described, was intended to model and protect, was perhaps the *stomach*, and that the spaces on each side covered the anterior portions of the *liver*.

The upper shell of the genus *calymene*, like that of the *isotelus* and *depleuva*, naturally and obviously divides itself into three parts, the buckler or shield—the abdomen and the caudal end. This last portion in the *calymene* is not covered with a thick epidermis, as in the two genera above mentioned, the articulations being all visible and somewhat difficult, in some species, to distinguish from those of the abdomen. These articulations, which are generally ten in number, are composed of a variety of immovable plates as in the other genera. The inferior surface of the caudal end of the trilobite had never been observed by any naturalist, till my friend Dr. Cohen, obtained some fragments of the genus *calymene* from the neighborhood of Berkley Springs, in Virginia, in some of which that structure was developed. These were kindly sent to me for examination, along with those of the buckler just described.

From our researches we have ascertained, that the inflexible margin which surrounds the caudal end or tail of the *calymene bufo*, is not reflected beneath the body of the animal, as might be expected, but that there is joined to it by a structure a slightly concave horizontal surface. This surface is lunate, being broader below the articulations of the vertebral column, gradually diminishing on each side towards the horns of the crescent, which terminates just below the last articulations of the abdomen. This lunate surface is composed of a thick crustaceous plate or piece. Beyond this crescent shaped piece, directly below the vertebral column, there is a deep cavity in the under shell of the animal, which corresponds in figure and dimensions with the gullar pouch

or under surface of the buckler. By this peculiar mechanism, whenever the animal rolled itself into a ball, to give protection to the soft parts of the abdomen, the protuberance under the shield would be introduced into the cavity below the tail, and thus retain the whole shell in a fixed position. In this position, with the tail closed upon the buckler, the calymene is often found.

Professor Wahlenberg considers those trilobites only as perfect animals, which are found rolled, the others being merely exuded or cast-off shells, and in such alone, he remarks, can we expect to discover the organization of the inferior surface. Most of the fragments from Berkley Springs, which have occasioned my present remarks, are found rolled up or partially coiled animals. All trilobites have not, however, this power; indeed, it seems to be principally confined to those only whose extremities are rounded and nearly equal in size. The rolled position would afford to the paradoxides and to many of the asaphs, but little security against the attacks of their enemies, and we rarely if ever find them in this attitude. The remark of Professor Wahlenberg above cited, though illustrated by the specimens now under consideration, we think of far too general a nature.

The deep cavity beneath the tail in the fragments which we are describing, reaches forward towards the head as far as the ninth articulation of the back; in other words, a portion of it lies beneath the three last abdominal divisions. It will be recollected that the gular pouch reaches below the fourth articulation of the back, and that the whole number of divisions in the vertebral column in the genus calymene, is twelve; we have therefore discovered in these fragments almost the whole of the inferior surface, except the portion which lies below the five articulations of the back commencing with the fifth from the buckler or shield; what we shall offer in regard to this portion of the animal must be merely hypothetical, or founded on certain analogies of structure which probably existed between living crustaceous animals and the fossil remains of such as inhabited the most ancient seas.

Some of our fragments, we think, exhibit a transverse section of our trilobite, showing the position and figure of the abdominal cavity which once contained a portion of the viscera of the animal. One of the sections is through and parallel with the sixth articulation of the back: by this means we have discovered that

some of the viscera were placed in a cylindrical cavity running beneath the vertebral column, and that the side lobes were only a covering and protection to the soft paddles or feet placed below, as may be seen in a similar structure in the serolis. Each of the five articulations of the abdomen, the under side of which we have not yet discovered, was probably furnished below, on each side of the abdominal cavity, with organs, which performed the double office of feet and lungs. Now, as our fragments develop all the inferior surface except the portion beneath these five articulations of the abdomen, it is probable that our trilobite was a *decapodous animal*. Professor Brongniart long ago imagined, that the reason why no traces of these organs have yet been discovered, is that the trilobites held that place among crustaceous animals in which the antennæ disappear, and the legs become transformed into soft paddles incapable of preservation. If this supposition be true, we shall in vain look for any further discoveries below the upper shell of the trilobite. What affords, we think, increasing probability to the opinion we have just advanced with regard to the situation of the abdominal cavity, and the organs of locomotion below the five abdominal arches above mentioned, is, that when the animal rolled itself up for protection, this portion of the body would still retain nearly a rectilinear position; thus no interference would occur in the ordinary functions of the animal economy when the body was contracted.

Besides the organs of locomotion and respiration beneath the abdominal arches of the genus *calymene*, it is probable that on each side of the deep cavity under the caudal end there was placed a series of thin transverse plates, which also performed the combined functions of breathing and swimming: a similar disposition of laminated branchiæ may be observed also in the *limulus* and in the *serolis*. Beneath this deep cavity the heart of the animal was also probably placed.

What we have said with regard to the inferior mechanism of the trilobite, applies exclusively to the genus *calymene*. It is probable that this structure differs essentially in all the genera of this remarkable family. Dr. Dekay has described and figured in the first volume of the *Annals of the Lyceum of Natural History of New York*, the under side of the buckler of the *isotelus*, which is very peculiar in its configuration; he describes this inferior surface as being formed by the anterior part of the buckler

being reflected beneath the animal so as to form a flat horizontal plane, which terminates in a kind of lunate spine, the horns of the crescent being curved towards each other. These horns are six lines in length, and their points are sharp and translucent. We have received from Dr. Warder a specimen of this singular structure, which was found, with other fragments of the isotelus, near Springfield in Ohio. Although it lies on the rock, unaccompanied by any other fragment of the animal, its exact resemblance to the figure given by Dr. Dekay leaves no doubt that it once belonged to an isotelus. Among other conjectures respecting the uses of this crescent-shaped structure, it is observed that when the animal was attacked "it may roll itself up into a ball, as indeed it is often found, and by some mechanism these processes may be inserted into the corresponding cavities in the tail, and thus retain permanently a rolled position, presenting nothing but its calcareous covering to the enemy; or they may supply the place of antennæ, for which their form and contiguity to the mouth and brain would seem to render them peculiarly applicable." The first conjecture above noticed was ingenious, and will no doubt be confirmed when the lower surface of the tail is discovered. The inferior organization of the calymene bufo has at any rate given great plausibility to this opinion.

We have also carefully examined another fragment representing a similar structure. The original fossil was found in Ohio, and is now in the possession of W. Wagner, Esq. of Philadelphia. The rock on which it occurs is a gray limestone full of other petrifications. This lunate structure differs essentially from the one noticed by Dr. Dekay; the points of the crescent are rounded and do not curve towards each other; the terminations are not raised and translucent, but the whole surface is nearly flat. It however formed, undoubtedly, a portion of the under surface of some trilobite, whether that of an asaphus, an isotelus, or a dipleura, we are unable now to determine. In the Geol. Trans., No. 8, Vol. I, pl. 27, there is a figure by Mr. Stokes of what is said to be the under surface of the anterior portion of the shield of an asaphus platycephalus from Lake Huron. Dr. Buckland, whose copy of the figure we have only seen, observes concerning it, that the entrance to the stomach of the animal was between these lunate processes "analogous to that in recent crabs." The *A. phatycephalus* is synonymous with *I. gigas* of

Dr. Dekay ; and if Mr. Stokes's drawing and Dr. Dekay's figure be accurate representations of nature, we think they must be drawn from analogous fragments belonging to animals at least specifically distinct.

In Mr. Wagner's cabinet there is another fragment of the under surface with lunate processes, somewhat resembling the one just described ; but instead of being composed of a flat plate or surface, it forms one that is convex, very much resembling the figure given by Dr. Buckland from Mr. Stokes. From this fragment it is perfectly evident, that this lunate structure is composed of an upper and under plate, the one convex and the other plain or flat, so as to form, when united, a plano-concave, hollow, lunate box or cavity. The physiological relations of this structure I am unable to suggest ; but since the above remarks were penned, I have seen a copy of *Murchison's Silurian System, &c.*, from which the following extract is made, which may throw some light on this matter, and is otherwise interesting. "I have seen the work of *Pander* at too late a period to enable me to profit much by his views concerning the original structure of the trilobite or the adaptations of the tegumentary skeleton of the animal to its habits, into the consideration of which he enters at length. He certainly throws some new light on the nature of these creatures by exposing the interior or under surface—particularly that of their heads, in which he points out several divisions, and considers them to be the thoracic plate and jaws. The central portion, or that which was formerly described by Mr. Stokes from a North American specimen, he considers to have been connected with the head by cartilage only, and to have served as a *thoracic plate to protect the stomach*, the form of which varies in the different genera of trilobites found in Russia. On referring this subject to my friend Mr. W. Mc Lay, whose knowledge of invertebrated animals is so profound ; he assures me that this plate on the under side of the head, above alluded to, must be considered as the *labrum* or upper lip. The trilobite is thus brought into close analogy with certain entomostracha such as the *APUS CANCRIFORMIS, &c.*"

We have called the fossil remain which has occasioned the present remarks respecting the organization of the under surface of the trilobite, *calymene bufo*, a name which we proposed some years since in our little work on these interesting reliques. Other

writers have applied to it the term *calymene macrophthalma*, first given by Professor Brongniart, not only to this fossil, but to another, which differs essentially from it. He has given in his admirable work on this subject good figures of both animals, but his specific description refers only to plate 1, figure 4, A. B. He observes, "that the species is remarkable by the prolongation of the anterior portion of the buckler in the form of a snout, and that its middle lobe, or front, is marked on its sides by three *oblique plicæ* or wrinkles, like those on the *C. tristani*." This description applies very well to some reliques found in the Dudley rock, which we have examined, but it is perfectly obvious that the *calymene bufo*, which has a rounded front, and is entirely destitute of *plicæ* or wrinkles, cannot be included in it. We therefore took the liberty in our little work of calling by the name of *calymene bufo*, the fossil represented on his first plate at figure 5, and which is so common in the United States; and of restricting the *C. macrophthalma* to the animals represented on the same plate at figure 4, which are specifically distinct, and if not so called, must still remain nameless.

NOTE.—Mr. Murchison in his magnificent work styled the Silurian System, has proposed the name of *calymene Downingiæ* for one of Professor Brongniart's fossils, called *C. Macrophthalma*, and restricts the term *Macrophthalma* to the one which I have named *Calymene Bufo*. There are several objections to this nomenclature. 1st, The *C. Macrophthalma*, *Brong.* was long ago divided into two species by me for the reason above stated. 2d, In M. Achille Comptès large pictorial illustrations of the *Regne Animal*, the *C. Macrophthelma* is represented by Brongniart's figure 4, A. B.; naturalists therefore already know it under that name. The following are Mr. Murchison's remarks on this subject: "I have separated the *C. Macrophthalma*, *Brong.* into two species, believing that his figure plate 1, figure 4, B, is our common large eyed species, and that his figure 4, A, of the same plate, judging from the ovate, acuminate head and the tubercles on the forehead is our *C. Downingiæ*. The last mentioned species is infinitely rarer than that to which I would restrict the name of *Macrophthalma*. That species is at once recognized by its bald, plain, rounded head, as is well exposed in the drawings of Mr. Stokes. See *Brong.* plate 1, figure 5, A, B, C. I have named this species after Mrs. Downing, to whom I am indebted for the loan of it."

ART. III.—*Description of a New Trilobite*; by JACOB GREEN, M. D, Prof. of Chemistry in the Jefferson Medical College, Philadelphia.

Asaphus Diurus—GREEN.

Clypeo? costis striatis, tuberculatis; cauda bipartita; corpore depresso.

The fragments of this Asaph which I have examined, consist of nineteen articulations of the abdomen and tail. The costal arches of the lateral lobes are very peculiar. They are marked by a shallow groove, or impressed line on their upper surface, studded on each side with quite a regular row of bead-like granulations. On each division of the vertebral column, there is but a single row of pustulations. The lunate caudal end is more expanded than in the cognate species, the *A. Selenurus*, and the concave side of the cressent, is more regularly rounded; the whole animal is much more depressed, than that species, and the lateral lobes are much wider in proportion to the middle lobe of the back.

There are two specimens of this fine species in the cabinet of William Wagner, Esq., of Philadelphia, both of which were found in Green County, Ohio, in the neighborhood of Xenia. The largest which measures two inches long and two and a half inches wide, is a plaster cast from a weather beaten natural mould; the other occurs in a grey, sparry, argillaceous limestone rock. It is perhaps worthy of remark, that all the specimens of the Asaph, with a lunate tail which I have noticed, were natural moulds, made by the animal in the rock, the shell or body having disappeared.

I was informed some time since, by Mr. Abraham Sager, of New York, that he had discovered several fine specimens of an Asaph with a lunate tail at the foot of the Helderberg mountains near *the Caves*, in which the horns of crescent which forms the caudal termination were remarkably elongated and perfect. As the *A. Selenurus* is found at Glenn's falls and at Becroft's mountain near the city of Hudson, is quite a different rock from that which occurs at the Helderberg, and as this last formation seems analogous to the one in which the *Asaphus Diurus* is found, it is probable that Mr. Sager's species may be the one now described.

I am indebted to the kindness of Mr. Wagner, for the opportunity of making out this species.

ART. IV.—*On the Natural History of Volcanos and Earthquakes* ;* by DR. GUSTAV BISCHOF, Professor of Chemistry in the University of Bonn. Communicated by the Author. Concluded from Vol. xxxvi, No. 2, page 282.

EARTHQUAKES.

EARTHQUAKES, so closely connected with volcanic phenomena, are undoubtedly owing to the same causes. That the processes by which they are produced must take place at a great depth, is evident from the simultaneous occurrence of earthquakes at places far distant from one another. Some extraordinary examples in this respect are furnished by the memorable earthquake at *Lisbon*, on the 1st November 1755, which was not only felt over a great part of *Europe*, but extended to the northern coast of *Africa* and the *Antilles*; and farther, by the simultaneous shocks felt on the 16th November 1827, and *Ochotsk* and *Bogota*, which places are 1900 geographical miles distant from each other, and are separated both by land and sea.† Parrot‡ has calculated that about 700,000 German miles, that is, nearly one-twelfth of the whole surface of the earth, was shaken by the earthquake at *Lisbon*. Stukeley§ calculated from the extent of country over which earthquakes have been felt, that the force must, in some instances, be 200 English miles beneath the surface. But Daubeny|| pointed out that we must not lay any stress on his remarks, because we have reason to believe that the vibrations may be propagated latterly far beyond the immediate influence of the impelling force. In a former

* From the *Edinburgh New Philosophical Jour.*, Vol. xxvi, No. 52, April 1839.

† Von Humboldt's *Reise, &c.*, vol. i, p. 497, and vol. iii, p. 23 and 27. Von Hoff, *Verzeichniss Von Erdbeben, &c.* in Poggendorff's *Ann.* vol. xxi, p. 214.

‡ *Physik der Erde*, p. 289. See also Berghaus' *Almanack*, 1837, p. 106, on the great extent of this extraordinary earthquake. With respect to this, it is worthy of remark, that *Vesuvius*, which was in some excitement on the morning of the 1st November 1755, became suddenly quiet at the very hour of the shock; and that, as Von Hoff relates, the column of steam which rose, returned into the crater. The same happened during the earthquake in *Calabria*. The little volcano of *Stromboli*, which is continually active, subsided, and almost ceased smoking.

§ On the causes of earthquakes, *Philos. Trans.* for 1750.

|| *Loco cit.* p. 388.

place, I have also shown, that the seat of volcanic action may be looked for at depths far less than Stukeley supposes. But there is no reason to believe that earthquakes could go on at greater depths than volcanic actions. Supposing that the interior of the earth is still fluid, and that rents conducting water, extend from the surface to the fluid nucleus, it is easy to conceive that the actions of the steam may be felt at very remote distances.

We have already pointed out the close connection which exists between earthquakes and volcanic eruptions. Von Humboldt, in his travels near the Equator, gives several examples of this. It may not be superfluous to refer here to what this illustrious philosopher asserts generally with regard to these phenomena, at the end of the 4th chapter of the 2d volume of Part I, Book 2.*

Every thing seems to show that earthquakes are caused by the effort of elastic fluids seeking an outlet. On the coasts of the *South Sea* their action is often communicated almost instantaneously from *Chili* to the Gulf of *Guayaquil*, a distance of 600 geographical miles; and, what is very extraordinary, the shocks seem to be so much the stronger, the greater the distance from the active volcanos. The granite mountains of *Calabria*, the limestone chain of the *Apennines*, the county of *Pignerol*, the coast of *Portugal* and *Greece*, *Peru*, and the continent of *America*, furnish striking proofs of this assertion.† It might be supposed that the earth would be more violently shaken, the fewer the openings on the surface which communicate with the interior. At *Naples* and at *Messina*, at the foot of *Cotopaxi*, and the *Tunguragua*, earthquakes are dreaded only when vapors and flames do not issue from the mouth of the volcano. In the kingdom of *Quito*, the great catastrophe of *Riobamba* led many well informed persons to believe that this unfortunate country would be less often disturbed if the subterranean fire would succeed in destroying the dome of porphyry of *Chimborazo*, and if this colossal mountain should become an active volcano. At all times, analogous facts have given rise to similar hypotheses. The ancient Greeks, who, like us, attributed earthquakes

* See also what Von Buch says on *Vesuvius*. Geognostische Beobacht. vol. ii, p. 129.

† Fleuriau de Bellevue, Journ. de Physique, t. lxii, p. 261.

to the force of elastic fluids, brought forward, in support of their opinion, the total cessation of earthquakes in the island of *Eu-böa*, after the opening of a chasm in the Lelantic fields.*

The intimate connection of earthquakes with volcanos is not less clearly proved by the direction which the former take. With the assistance of a simple instrument (the sismograph) invented by Cacciatore, and erected at *Palermo*, it was found in twenty-seven cases that the shock was propagated in a fixed linear direction, which coincided remarkably with the cardinal points. In nineteen cases the shocks were transmitted in a direction from east to west, corresponding with the situation of Mount *Etna*, the source of all these subterranean concussions, which lies directly to the east of *Palermo*. In four cases it was from south to north; but, for want of corresponding observations, the seat of these shocks cannot be determined; and it certainly does not seem to have been the effect of chance, that three shocks, which were felt on the 9th February, 30th June, and 2d July 1831, traveled from the south-west to the north-east: for it was precisely in that direction, at a distance of about 70 Italian miles, that the small new volcano suddenly appeared in the sea, probably on the 2d July. The two latter shocks were also the very same that were felt with greater force at *Sciacca*, on the southern coast, opposite to the new volcano.†

On the other hand, Boussingault‡ asserts that the most memorable earthquakes in the New World, which ravaged the towns of *Latacunga*, *Riobamba*, *Honda*, *Caraccas*, *Laguayra*, *Merida*, *Barquisimeto*, &c., do not coincide with any well established volcanic eruption. The oscillation of the surface, owing to an eruption, is, as it were, local; whilst an earthquake, which is not subject (at least apparently) to any volcanic eruption, extends to incredible distances, in which case it has also been remarked that the shocks most commonly follow the direction of chains of mountains.

In favor of the hypothesis, that earthquakes are produced by aqueous vapor|| penetrating to great depths, the following circum-

* Strabo, lib. i, ed. Oxon. 1807, t. i, p. 85.

† F. Hoffman in Poggend. Ann. t. xxiv, p. 63.

‡ Annal. de Chim. et de Phys. t. lviii, p. 83.

|| A remarkable case which has taken place at the iron-foundery at *Sayn*, proves, that shocks of the earth may be several times repeated by the effect of elastic flu-

stances may be adduced. Firstly, as aqueous vapor is supposed to produce volcanic action, it must be presumed to be also the cause of earthquakes. Secondly, some hours before the first shock of the tremendous earthquake at *Algiers* and the neighborhood, the 2d to 5th March 1825, which entirely destroyed the town of *Blisa*, all the springs and wells are reported to have been dried up.* Thirdly, earthquakes, though undoubtedly felt even the centre of large continents, seem to produce their most frightful effects in countries not very far removed from the ocean. But perhaps, earthquakes may also be produced by gaseous exhalations in the interior of the globe. At least in many accounts of earthquakes, mention is made of the exhalation of gases from rents, produced by them,† and the smell of sulphuric acid, and of sulphurous vapors, which indicate the presence of sulphuret-

ids. A cylinder 14 feet in height, and 31,395 pounds in weight, was to be cast. The clay mould having been totally filled up by melted iron, the latter broke through the ground, and penetrated to the depth of 25 feet into the sandy soil, consequently 11 feet deeper than the lower part of the mould. Some time after an earthquake actually took place, which shook the whole building so violently, that the workmen feared it would be seriously injured. About half an hour after, an equally violent shock happened, and after more than 24 hours a third followed. The local circumstances of that iron-foundery lead to an explanation of these phenomena. There are at a depth of 23–24 feet under the ground of the said building, many inclined channels which communicate together, for the purpose of collecting the rain water. Immediately after the shocks, watery vapors issued abundantly from the mouth of the channels. These vapors were evolved by the heat of the melted iron from the water, being in the ground about two feet below the bottom of the channels; and penetrated through the joinings of their brick work. But these joinings being filled up with mud and sand, offered resistance, and consequently the vapors had to attain a certain elasticity before they were able to penetrate through them. It is, however, very probable that the vapors, bearing mud and sand with them, again stopped up the opening, when their elasticity gradually again decreased. During the shocks, the steam attained its greatest elasticity, and thickened the earth which surrounded the heated mass of iron; and this circumstance may have impeded a new afflux of water. Therefore, after the first shock, half an hour elapsed; and after the second, which still more obstructed the afflux of the water, even more than 24 hours elapsed before the third and latest shock took place.

* Berzelius, *Jahresbericht*, 1827, p. 310.

† Von Humboldt, *Reise*, t. i, p. 499. Von Hoff in *Poggend. Ann.* t. vii, p. 292, t. ix, p. 593, t. xxv, p. 76. V. Humboldt believes indeed, that during most earthquakes, nothing arises from the earth; but there are on the contrary, proofs that gases are often gradually evolved from the ground before and after the shocks. The uneasiness of small animals, or those whose organs of respiration are rather feeble, before and after earthquakes, leads us to infer this. Le Gentil (*Nouveau Voyage autour du Monde*, t. i, p. 172) has already observed, that animals living in

ted hydrogen.* These last may have occasioned also the destruction of the fish in the sea, and in lakes, during earthquakes; many instances of which are known. The bursting forth of flames from the earth and from the sea, which is so often mentioned,† also indicates the presence of inflammable gases. However, although this is corroborated by the fire-damp in mines, the disengagement of sulphuretted hydrogen while boring artesian wells, and the not uncommon exhalations of inflammable gas from the earth, yet it is difficult to account for their inflammation. This difficulty would disappear, if observation had found flames only to occur in really volcanic districts.‡ But at any rate, it is going rather too far to take the explosion of fire-damp for the cause of earthquakes, as Kries does.|| It is not impossible, that what has been taken for flames, if not altogether an illusion, was only an appearance of light, produced by the sudden expansion of highly compressed gases, exactly the same as is seen when an air-gun is discharged in the dark.

The heating and boiling up of the water in the sea and in lakes, the spouting up of streams of water, as well as the ejection of various substances from fissures in the earth,§ which have oc-

holes, as rats, mice, reptiles, &c., commonly quit their abodes shortly before earthquakes. Crocodiles quit their pools in the *Llanos*, and remove to the continent, *Relat. Hist.* t. v, p. 57. Von Humboldt moreover relates that dogs, goats, and particularly hogs, which have a keen smell, and turn up the ground, are suddenly affected, and a great number of these latter animals have been found suffocated during the earthquakes in *Peru*.

* Von Humboldt, *ibid.* t. i, p. 484, and t. ii, p. 73. Von Hoff, *ibid.* t. xii, p. 567, t. xviii, p. 46. See also *Philos. Trans.* t. xlix, p. 415.

† Von Humboldt, *ibid.* Gehler's *Physikal. Wörterbuch*, new edit., t. iii, p. 804. Also during the earthquake of *Lisbon* (*Philos. Trans.* *ibid.*) and on the island of *Matschian*, (*Hist. de la Conquête des Molluques*, t. iii, p. 318) the bursting forth of flames is reported to have taken place.

‡ Von Humboldt mentions flames which rise from time to time out of two extensive caverns in the ravine of the *Cuchivano*. This phenomenon was accompanied, during the last great earthquake at *Cumana*, with a continued hollow subterranean noise. The flames are more especially to be seen during the rainy season.

|| In his prize essay on the causes of earthquakes.

§ Von Hoff l. c. t. xxv, p. 73, t. xxix, p. 421. At the time of the earthquakes, which destroyed a part of *Italy*, (1702–1703,) many rents were formed in the *Abruzzi*, which emitted a large quantity of stones and then troubled water. The latter was thrown up higher than the trees in the neighborhood. Flames and a thick smoke rose from the neighboring hills, which continued three days with some interruptions. *Hist. de l'Acad.* an. 1704, p. 10. During the earthquake,

asionally been witnessed, may be satisfactorily explained by the rising of steam and gases, which may have the effect either of heating the water, or of throwing out solid bodies.* The same may be said of the concussions of the earth which take place, sometimes in horizontal undulations, sometimes in vertical shocks, and sometimes with a vibratory motion, backwards and forwards. The latter of these convulsions, called by the Neapolitans, *moto vorticoso*, is most common during the greatest earthquakes.

Von Humboldt has proved, by abundant examples, that the propagation of earthquakes is not confined to any particular rock, but that the most varied formations are equally favorable to it. We infer, therefore, that the seat of earthquakes must be below all known rocks. Although all the rocks may be agitated, yet the manner of extension of the shocks in them is different, according to their particular quality. The earthquakes, which

the 21st October 1766, which totally destroyed the city of *Cumana*, the earth opened at several places in the province, and vomited sulphureous water. These eruptions were particularly numerous in a plain, which extends towards *Casanay* two geographical miles eastward of *Cariaco*, and which is known by the name of the *hollow land* (*tierra hueca*) because it seems to be every where undermined by hot springs. Von Humboldt, *Reise*, t. i, p. 482. During the violent earthquake, which in one minute overthrew the city of *Caraccas*, on the 26th March 1813, so much water was thrown up through the cracks, that a new stream was formed. At the same time the ground was also found covered with a fine white earth, like volcanic ashes, which had been thrown up from fissures in the neighborhood. The eruptions of volcanic masses were still more considerable during the earthquake of *Riobamba*, 1797. The earth was fissured at innumerable places, and immense gulfs were formed in some places. Masses of water rose, filling up valleys 1000 ft. wide, and 600 ft. in depth; and also at the same time a peculiarly stinking mud, consisting of volcanic matter, accumulated so as to form considerable hills, now called *moya*. Wide rents were likewise opened during the violent earthquake in the north coasts of *South America*, last year, in order to give exit to streams of water which rose. It was often observed, that during the earthquakes, water with sand, mud, &c., was thrown up from wells, sometimes to a height of 30 ft. Von Humboldt relates, (*Relat. Hist.*, t. ii, p. 287,) that this phenomenon is generally observed during the earthquakes at *Cumana*. The same thing happened the 1st Nov. 1755 near *Colares*, (*Philos. Trans.* t. xlix, p. 416,) and also during the earthquake in *Calabria*. (*Journ. de Phys.* lxii, p. 263.)

* Thus, during the above-mentioned earthquake on the north coast of *South America*, columns of smoke were seen rising out of the sea, a league from the shore, and in a depth of about 210 ft.; and in the night, flames were seen issuing from the same spot, which illuminated all the coasts of the island. After each shock, the sea retired, left the ships which were in the bay aground, and laid bare the rocks to a great depth; the waves at the same time ran to a height of 16 ft. to 20 ft. During the shocks the earth opened and closed again very rapidly. When

have at different periods ravaged *Smyrna*,* *Messina*,† *Kingstown* in *Jamaica* 1792, the county of *Pignerol* 1808,‡ *Calabria*,|| *Talcahuano* in *Chili*,§ &c., have always had a greater effect on diluvium and alluvium, than on rocks. Houses, for instance, built on sandy ground, were demolished, while those which stood on rocks were but little damaged. The shocks therefore act less violently and destructively on solid and rocky ground than on loose soil, which is unable to resist, and propagates the shock irregularly. In *Calabria*, where the loose soil occurred lying on granite on the declivity of the hills, the latter threw off the former, which glided down. Lastly, there are also instances of shocks extending irregularly in rocks.¶

Many instances present themselves of earthquakes, which in extending longitudinally, follow the direction of the rocks. This is the case, according to Palassou,** in the *Pyrenees*. Remarkable instances are presented in the phenomena of the 28th Dec. 1779; the 10th July 1784; the 8th July 1791; the 22d May 1814, &c. The regions situated more to the south, are, however, more affected than the chain itself.†† Earthquakes in *South America* seem also to follow the direction of the mountains. Thus, that at *Caraccas* (1812) followed the direction of the littoral *Cordilleras* from E. N. E. to W. S. W.‡‡ That of *Cumana* 1797, presented an instance of the same fact. The predominant direction of the frequent earthquakes on the coasts of *Chili* and *Peru*, is also that of the large chain of the *Andes*, which is parallel to the coast.|||| All the older reports likewise state, that in these countries their direction is from S. to N., or *vice versa*; and Mrs. Graham remarked, that she felt, during the violent earthquake in *Chili* 1822, as if the whole ground from north to south

tranquillity was restored, a whirlpool was observed in the sea, as if the waters were being swallowed up in an immense gulf. The temperature of the sea in the bay was raised, and bubbles of gas were seen rising all over the surface.

* Hist. de l'Acad. des Sciences, an. 1688. Buffon, Hist. Nat. t. i, p. 515.

† Spallanzani, Voyage, t. iv, p. 138. ‡ Journ. de Phys. t. lxxvii, p. 238.

|| Oryktologische Bemerkungen über Calabrien &c., 1784.

§ Nautical Magazine, Nos. 49 and 51, March and June 1836.

¶ Berghaus' Almanack für das Jahr 1837, p. 72.

** Mém. pour servir à l'Hist. Nat. des Pyren., p. 260.

†† Ibid p. 916.

‡‡ Von Humboldt, Rel. Hist. t. v.

|||| That at *Cumana* followed the direction from N. to S., which is extremely singular, l. cit. t. iv, p. 16.

were suddenly raised, and then sunk again. Von Hoff* has also related the circumstance, that the shocks of earthquakes are most common in the same direction as that of the basaltic masses themselves, and around a certain distance on either side of the line in which they occur.

On the other hand, there are many instances of the countries of Europe having been agitated in all directions, without having been influenced by the mountains. Thus, earthquakes have extended from *Upper Italy* across the *Alps* to *Switzerland*. That at London (19th March 1750) followed the direction from W. to E., although the direction of the mountains in *England* is from S. S. W. to N. N. E. &c. Sometimes the earthquakes originate from a common centre in a radiating direction on all sides. That of *Lisbon*, (1755,) that in *Calabria* (1783,) and that at *Lima* (1746,) &c., offer instances of this kind.

With regard to the earthquakes in *South America*, it has been observed that they occur principally in the mountainous countries. The cause which produces them, seems, as Boussingault† believes, to be so constantly in operation, that, if all the earthquakes, which are felt in the inhabited countries of *America*, could be noted, the earth would be found to quake nearly without intermission. These frequent movements of the ground of the *Andes*, and the slight coincidence between these convulsions and the volcanic eruptions, induce us to adopt the opinion of Boussingault, that the former are, for the most part, independent of the latter. He ascribes the greatest number of the earthquakes in the *Andes* to the sinking of rocks in the interior, which is a consequence of the former elevations of these chains of mountains. In favor of these suppositions, he affirms that these gigantic rocks have been thrown up, not in a doughy, but in a solid and fragmentary state, but that the consolidation of these fragments of crystalline rocks might not at first have been so firm, as not to admit of some sinking after the elevation. He refers to the Indian tradition which preserves the memory of the sinking of the celebrated mountain of *Capac-Urcu*, near *Riobamba*, the name of which signifies the chief, *i. e.* the highest, of all the mountains near the Equator. It is said that the top of this

* *Geschichte der Veränderungen der Erdoberfläche*, t. ii.

† *Annal. de Chim. et de Phys.*, t. lviii, p. 83.

mountain has sunk in consequence of a subterranean shock which took place before the discovery of *America*. At the present time *Capac-Urcu* is lower than *Chimborazo*. Boussingault alludes to many instances, in which it is asserted, that the *Cordilleras* have sunk. Without taking into consideration the inferences drawn from barometrical measurements, made by Boussingault and his predecessors, which seem indeed to confirm that supposition, we will only mention the following circumstances. The French academicians, who, a century ago, were sent to *Quito* for the purpose of determining the form of the globe, were very much embarrassed in their station on *Guaguapichincha*, by the snow surrounding their signals. Now, for many years, no snow has been found on the summit of this mountain. The inhabitants of *Popayan* have also remarked, that the inferior limit of the snow covering the *Purace* is gradually rising, whilst the mean temperature has remained the same for the last thirty years, whence Boussingault infers, that the *Purace* is sinking down.

That masses thrown up in a state of igneous fusion sink again by degrees, in consequence of their consolidation and contraction, cannot be doubted. But even if their elevation had taken place in a solid state, yet the immense masses of the *Andes* have risen from depths, where a pretty high temperature prevails. Supposing the *Andes* to have risen 24,000 feet in height, that part of them which is now at the level of the sea, must have been before the elevation so many thousand feet below it. This part brought, therefore, with itself from beneath, a temperature which was $\frac{24000}{51} = 470^{\circ}$ F. higher than that which existed at the level of the sea before the elevation. The same holds good of each part of the *Andes*, in any depths, so that every where in erupted masses the temperature surpassed that of the adjacent rocks by 470° F. Whilst now these masses gradually lost their surplus of heat, they were contracted. But this cooling of these masses can, as far as they are within the earth, only be affected by conduction, therefore a long period will elapse for that purpose. That part of the *Andes*, which is elevated above the surface of the earth, and is exposed to the atmosphere, will of course cool a little more quickly. If the bases of the rocks thrown up be at a great depth below the surface, their contraction in consequence of their cooling may be very considerable, and as the elevation

of the *Andes* is said to be one of the latest, this cooling and contraction may continue even at the present time in that part which is within the earth. It is therefore possible to conceive that these effects are the cause of the frequent earthquakes in the *Andes*.

Besides, there is nothing opposed to the hypothesis, that the powers, whatever they may be, which produced so remarkable a phenomenon as these elevations, may not even now operate in a less degree, and occasion the earthquakes so frequent in the *Andes*. The later these elevations are supposed to have taken place, the more probable will such a hypothesis be.

If further proofs are still necessary to show that the causes of earthquakes are only to be sought in the interior of the earth, we certainly find them in the fact, that these phenomena are totally independent of external circumstances. They take place whether the sky be clouded or serene, in hot as well as in cold weather,* before or after rain, sometimes with rain, and sometimes without it. Even the strength and direction of the wind seem to have no kind of connection with them.† Nor do they seem to be

* Many observers allude, indeed, to variations of temperature of the atmosphere before and after earthquakes; but the academicians of *Turin* only have actually made observations on the temperature in the county of *Pignerol*. (*Journ. de Phys.* t. lxxvii, p. 292.) They found that their thermometer always descended as soon as shocks had been felt. Thus they felt a vehement shock in the morning at half-past ten, on the 10th of April, and their thermometer descended till noon from 26° to 22°. In fact it is to be desired, that farther observations should be made on other occasions, in order to confirm or refute the assertion of so remarkable a phenomenon.

† The late F. Hoffman in vain endeavored to discover in the *Meteorological Journal* of the Observatory of *Palermo*, (which included a series of years from 1792 to 1832, and where particular attention had been paid to the observation of earthquakes, of which no less than fifty-seven had there been accurately observed,) some peculiarity of weather, which might, with any degree of plausibility, be supposed to have been connected with the earthquakes. The same result was obtained by Domenico Scinà in his memoir on the numerous earthquakes, which, in the years 1818 and 1819, caused so much apprehension in the neighborhood of the *Madonian* hills—*Poggendorff's Ann.* t. xxiv, p. 50 and 60. In contradiction to this are the traditions current in many countries. See among others, *Berghau's Almanack*, 1837, p. 97, and following. There seems to be in fact, some truth in the opinion, that earthquakes are most frequent and vehement at the beginning of rainy weather, and this phenomenon is even ascribed in *Jamaica* to a locking up of the pores in the crust of the earth by water, which impedes the rising of gases. On the other hand, cases have occurred in which earthquakes, were preceded by a long continued drought.—*Barham* in the *Philos. Trans.* t. xxx, p. 837, y. 1718, and t. xlix, p. 403; *Relat. Hist.* t. ii, pp. 273, 281, and t. v, p. 15, and 57; *Hans*

confined to any particular season of the year, although it is certainly remarkable, that of fifty-seven earthquakes, which were felt at *Palermo* during a period of forty years, almost a fourth part happened in the month of March.* Perhaps the best means of ascertaining whether any connection exists between earthquakes and meteorological phenomena, is the observation of the barometer. But Hoffman was unable to discover anything peculiar or extraordinary, either in the relative height of the barometer, in the direction of its motion, or in the extent of the oscillation, during the fifty-seven earthquakes above alluded to. The oscillations never went beyond their ordinary limits; indeed, in most cases they were very inconsiderable.† Von Humboldt also says that between the Tropics, on days when the earth is agitated by violent earthquakes, the regularity of the hourly variations of the barometer is not disturbed.‡

If aqueous vapors and compressed gases are the cause of earthquakes, there can be no doubt that hot springs and exhalations of

Sloane's Letter with several accounts of the earthquake in Peru, October 20th, 1687, at Jamaica, 10th February, 1688, 7th June, 1692; *ibid*, y. 1694, p. 78; *Hist. des Trembl. de Terre*, t. ii, p. 442; *Collect. of the Massachusetts Hist. Soc.*, t. v, p. 223.

* Hoffman, *loco cit.* p. 52. It is also well known that in other countries, especially in *Chili* and the *Moluccas*, the periods of the equinox, for reasons of which we are ignorant, are considered as those most favorable to earthquakes. During the above named period of forty years, this law does not seem to have been applicable to the autumnal equinox in that part of *Europe*.

† During the earthquakes the barometer stood decidedly oftener above the mean than under it. However, Hoffman remarks, p. 56, that during the only shock of importance which occurred in this period at *Palermo*, viz., in March, 1823, the barometer remained the whole month constantly below the monthly mean.

‡ *Reise*, t. i, p. 487; also *Relat. hist.* t. iv, 19. Likewise Boussingault in *Ann. de Chim. et de Phys.* t. liii, p. 82. Other observations have also proved that the height of the barometer is totally unconnected with the cause of earthquakes, as for instance those of Don Felixe Castillo Albo, during the earthquake in *Chili* in the year of 1822. See also Meyen in his "*Reise um die Erde*," t. i, p. 210. Those also made in the county of *Pignerol* in *Savoy*, by the committee of the academy of *Turin*, during the earthquakes in the year 1808. The state of the barometer was also invariable, whilst the shocks at *Lisbon*, the 9th December, 1755, were very strongly felt at *Turin* *Philos. Trans.* t. xlix. The observations made on the island of *Meleda*, near the coast of *Dalmatia*, from the 15th November, 1824, to the 28th February, 1826, which likewise prove, that no connection exists between earthquakes and the pressure of the atmosphere, are very important, the shocks felt on this island having been the only ones of their kind as regards length of duration.—*Die Detonations-Phänomene auf der Insel Meleda* von P. Partsch, *Wien*, 1826, p. 204.

steam and gases, may act as vents, and thus serve as a protection against them.*

Indeed, the ancients endeavored to diminish the violence of subterranean explosions by means of wells and excavations. What Pliny,† the great Roman naturalist says of the efficacy of these expedients, is repeated by the ignorant inhabitants of *Quito*, when they point out to the traveller the *Guaicos*, or clefts of the *Pichincha*.‡ But this is by no means confirmed by experience.

Farther reasons in support of the hypothesis which attributed volcanic phenomena to increased temperature of the interior.

However distinct natural philosophers may consider the causes of volcanic action, and those of hot springs, yet the close connection of these two classes of phenomena refers us to one and the same cause. In proportion as satisfactory grounds can be adduced in support of any hypothesis, which explains one class of phenomena, so much the more probable does the hypothesis appear when applied to the other class. Though the seat of hot springs be concealed deep in the interior of the earth, and be as little accessible to immediate observation and investigation as volcanic action is; yet we may pursue and examine the phenomena of the former on the surface of the earth, and every point of time selected by the observer for this purpose proves equally favorable.

* Hoffman is inclined to ascribe the rarity and weakness of the earthquakes at *Sciacca* to the numerous exhalations of aqueous vapors, and to the great number of hot sulphurous springs, which occur in that neighborhood, compared with other parts of *Sicily*, that are so often and so terribly visited by these destructive phenomena. *Poggendorff's Annal.* t. xxiv, p. 70.

† Lib. ii, c. 82 (ed Par. 1723 t. i, p. 112)

‡ Von Humboldt, *Reise*, t. i, p. 491. In *Peru*, the earthquakes are less frequent than in *Latacunga*, which is ascribed to the great number of deep hollows which intersect the ground in all directions in the neighborhood of the town. Leonhard's *Taschenbuch*, 1822, p. 917. Von Hoff quotes many instances, in which several wells in *Rome*, *Naples*, and *Capua*, are said to have diminished or totally paralyzed the effects of earthquakes. But, in my opinion, an undue importance is ascribed to this effect of wells, for it is hardly to be conceived, that the effects of a cause, existing so deep in the interior of the earth, should be modified in any considerable degree, by an opening which penetrates the crust of the earth to so slight a depth.

Their wide distribution, the invariableness of their phenomena, the evolutions of gases from many of these, present to every attentive observer, matter of investigation and consideration on their origin, duration, and connection with other phenomena. If, then, we can succeed in proving that chemical processes can with much less probability be assigned as the cause of their being heated, that on the other hand, the most convincing reasons show that their heat is acquired at the expense of the interior of the earth: then will the hypothesis, which endeavors to explain volcanic phenomena from the same causes, gain no little increased weight. And in fact if hot springs be heated to such a degree as to attain the boiling point at a certain depth in the earth, we have but one step to make, by supposing this heat increased up to the fusing-point of volcanic stony masses, in order to attribute with equal probability, volcanic phenomena and hot springs to the central part of our earth.

I must observe, in the first place, as was formerly remarked, that, by thermal springs, I understand nothing more than springs whose average temperature exceeds that of the soil at the level at which they rise. It is therefore indifferent whether this excess consists in 1° or less, or in 50° or more. I can form no other idea of the meaning of the word thermal springs; at least, I do not know what degree of temperature can be laid down as the boundary between cold and thermal springs, unless the distinction were to be perfectly arbitrary. Thermal springs (taken in this sense,) are very widely distributed over the globe, as I think I have formerly shown. Nay, I am convinced that, if we take any district of nearly equal height above the level of the sea, several of the springs will be found to exceed in average temperature that of the soil. An exception to this rule will certainly be found only in those situations where springs arise at the foot of hills more or less high and which have acquired a cooler temperature from the higher regions.

If, like Professor Daubeny,* we regard chemical processes going on in the earth as the cause of thermal springs, then must these processes be as universally distributed as the thermal springs. Those who entertain these views, however, do not surely con-

* Report on the present state of our knowledge with respect to mineral and thermal waters. *London*, 1837.

tend, that these processes take place near to the surface, else how could we explain the fact, that, in boring Artesian wells, the greater the depth, from which the water rises, the higher is its temperature. As little explanation could be given of the circumstance, that springs rising in a small district near one another, often present no inconsiderable difference in their average temperature. In proof of the former assertion, I will cite out of many other instances that of the hole bored at *Rüdersdorf* near *Berlin*, where water at $74^{\circ}.3$ F. was drawn by boring to a depth of 880 feet; and in proof of the latter, the numerous springs in *Paderborn*, whose temperature varies from 49° to 61° F. In the former case, then, these presumed chemical processes must take place far below the depth of 880 feet; in the latter they must be supposed to be going on, either entirely below the situation of the springs at a nearly equal depth, or at various depths beneath each separate spring. In the previous case, their different temperatures would be occasioned by one spring running nearer, the other at a greater distance from, the common source of heat.

Daubeny speaks, in general terms only, of chemical processes; if we may, however, judge from a note,* he seems to allude to the same processes as those which he assumes as the cause of volcanic phenomena, viz., the oxidation of metals of alkalies and earths by water. We may pause a little to consider these hypothetical chemical processes, as they ought to inform us whence the agent, viz., heat, is derived, which is the point in question.

As the presence of thermal springs is so universal, these metals must be equally so. This hypothesis, especially in the extent given it by those who maintain it, viz., that the whole nucleus of the earth consists of an unoxidized mass, cannot be reconciled with the proportionate density of our earth, as I have already shown. Yet, let us admit for a moment the existence of these metals in a more limited proportion. Their oxidation requires the access of water; we must, therefore, suppose as many channels to conduct the water from the surface as there are thermal springs, or at least groups of thermal springs. Granting all this, the question yet remains to be answered, why the effects of

* Report, &c., p. 68 and 69.

these subterraneous oxidations are seen on the surface, in and near volcanos only; and why not even a trace of such processes can be detected in other places, which yet present innumerable thermal springs? Surely no one will bring forward the scanty evolutions of sulphuretted hydrogen gas from sulphurous waters as proofs of such processes. But, were the conditions necessary for volcanic activity fulfilled by the access of water to the interior in each of these channels, then would the occurrence of volcanic phenomena be much more frequent on our earth. Or, it must at least be assumed that they were at a former period, as universally distributed as thermal springs now are; and that they have left behind a high temperature in the interior, which warms the springs, and, as Daubeny also assumes, extricates from the limestones, in the interior, the carbonic acid gas so universally present. That this is occasionally the case, namely that springs do acquire their heat at the expense of volcanic masses elevated at a distant period, is certainly true, and has probably been of still more frequent occurrence in former times. I have myself already adduced instances of this kind. With the cooling of these masses, however, the thermal springs dependent on them must of course also cool, and whether this cooling take place in a longer or shorter time, must depend on the greater or less extent of those masses.

After the preceding remarks, the question remains, whether it be necessary to assume, in explanation of the universal distribution of thermal springs, a volcanic activity once so universally distributed; or whether their existence cannot be both more simply and more satisfactorily explained by an increased temperature in the interior, which is by no means merely hypothetical, but is supported by innumerable facts.

Daubeny says,* “That (the supporters of my views) should explain to us why primary rocks, traversed, as they so frequently are, with fissures of all descriptions, should not in every part of the world, and in every kind of situation, give rise to hot springs, by evolving steam from their interior, and why they never appear to give issue to that class of thermal waters which I have noticed in *Ischia*, as being unaccompanied with gaseous products.”

* Report, p. 70.

A spring arising from beneath, leads us to conclude that meteoric water penetrates through clefts which communicate low down with the former. The experience gained in boring artesian wells, shows that a succession of strata is most favorable for such processes, and from causes easily explained. In what are called primary rocks, however, no such alteration of strata is found, because they are not stratified. The usual occurrence, viz., the flowing of meteoric water down inclined surfaces of stratification which appear at elevated situations, and the rising of this water, by means of natural or artificial channels, after having been forced down to a more or less considerable depth, cannot then happen in unstratified rocks. It appears, nevertheless, that there are granitic rocks traversed by clefts more or less perpendicular, and communicating low down. Thus at *Aberdeen*, in *Scotland*, water has been drawn by boring in granite 180 feet below the surface, which, according to Robison, came from a cleft filled with sand and gravel, and rises six feet above the level of the earth.* Such a communication of the clefts low down, must, however, occur but rarely.

If the primary mountain rises above its environs and the clefts at its base lie exposed, then will the springs flow out of the clefts. Such an origin of springs, which are not naturally rising springs, is often observed at the foot of basaltic and trachytic cones, &c.

On the other hand, on the limits between stratified and unstratified rocks, where the latter have traversed the former, and where channels extending to a great depth have been formed in consequence of the contraction of the traversed masses during their cooling, circumstances favorable to these rising springs exist, and it is easy to conceive, therefore, that thermal springs may be found on the limits of these interrupted masses, but not in their interior.

Let us imagine a stratified chain of mountains consisting of several formations in a perfectly horizontal position, whose newest portion (*jüngstes Glied*) is much fissured, and under which an impervious stratum lies, then the meteoric water will penetrate the former fissured stratum, but be retained by the latter. As long as this horizontal position remains undisturbed, no rising

* *Compt. Rend.* 183 No. 24, p. 575, and t. ii, No. 20, p. 583.

springs can be supposed to exist in the whole of this district, and the inhabitants of such mountains could only supply their want of water by wells (Senkbrunnen.) We will now suppose, that at two points of this district, volcanic masses are thrown up, and that, in consequence, a partial elevation of the strata takes place, as is shown in the diagram, fig. 1. In this case, the hydrographic relations undergo considerable alterations. The consequence will be not only a movement of the water on the impervious stratum, in the direction of its inclination, but meteoric water will also penetrate at A between the older strata, where, during their undisturbed horizontal position, not a drop of water could penetrate, and this water will continue to flow in the direction of the inclination of the elevated strata.* At B, where these strata

Fig. 1.

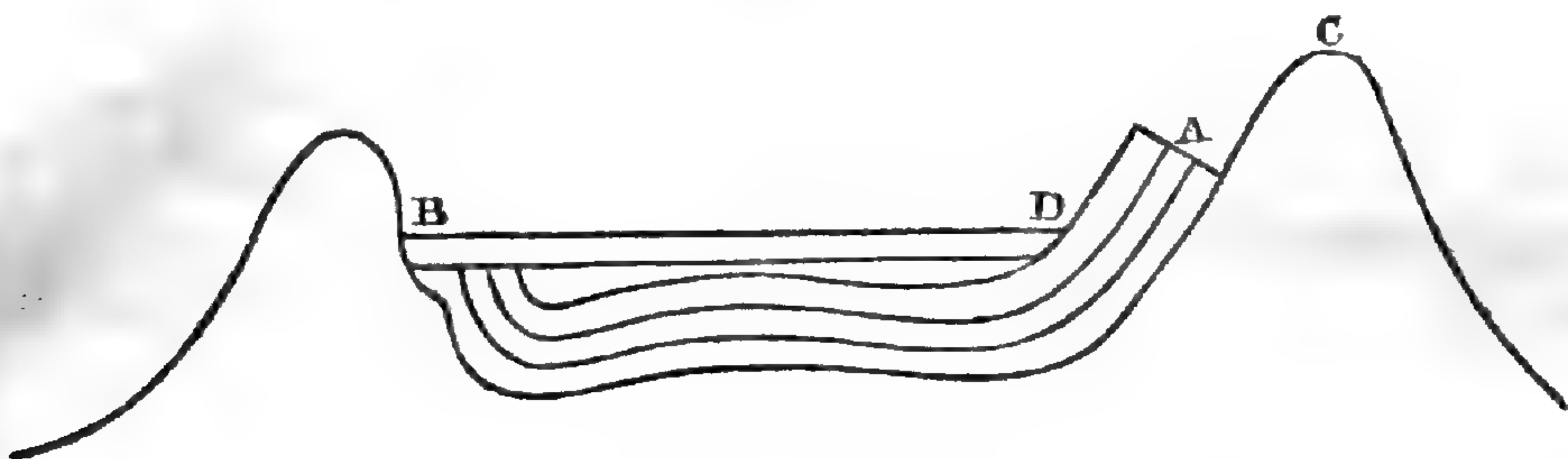

are also elevated, but to a lower level, springs will commence rising; and as many of such springs may be supposed to exist in a district, as there are alternations of impervious and pervious strata in these mountains. The most copious springs, however, will be found between the mass that has been broken through, and the oldest formation of the stratified mountain, because here, in consequence of the contraction of the former mass during its cooling, a cleft has been formed, which receives the meteoric water flowing down on that side of the elevated mountain C, which lies next to the raised strata. The meteoric water which flows down through the newest fissured stratum, will now as little give origin to rising springs as during its earlier horizontal position. If, now, after the period of this elevation, a stratum of a new formation should occur, covering the extremities of the older raised

* The same holds good with regard to the springs of fresh water. Thus on the *Schwäbisch Alp* springs are always found there where cones of basalt or basaltic tufa have been elevated on the jura-formation. Plieninger in Poggendorff's *Annal.* t. xl, p 493.

strata, and extending from B to D, and if, lastly, the new formation contain impervious strata, then the conditions will undergo a change. The meteoric water, which penetrates at A, between each separate portion, will now all issue in the form of rising springs at B, between the elevated mountain and the new stratified formation which lies at its side. Should any obstacle here present itself to its exit, the water will even take a retrograde course B D, and issue at D, in which case the water between the last formed horizontal stratum and the impervious stratum lying under the newest raised ones will unite with it. We will not, however, enter into farther particulars, as many circumstances may be supposed to exist which modify the course of the springs; and still more complicated relations naturally arise, when, after the deposition of the latest formed stratum, the elevation and raising are repeated. It will be sufficient to have called attention to the circumstance, that rising springs can exist only when the originally horizontal position of the stratified formations has been destroyed by elevations; and that the most copious springs, and those which arise from the greatest depths are found precisely at the limits between the elevated masses and the raised strata.

Numerous instances can be cited in proof of this assertion. The *Pyrenées* and *Alps*, present very characteristic circumstances. Thus Pallasou* shows, that not only are the majority of the hot springs in the *Pyrenées*, situated in the great granitic district at the eastern side, but also, that all the others issue only from hollows of the newer formations, where the granite rises from beneath, at the foot of the declivities. He shows also, that even the degree of temperature of these springs depends on the greater or less exposure of their source; for the thermal springs nearer the principal granitic mass are warmer, while those more remote are colder.

Professor Forbes has likewise pointed out, in an interesting memoir on the temperatures and geological relations of certain hot springs, particularly those of the *Pyrenées*,† that, in the departments of the *Arriège* and the *Pyrenées Orientales*, where granite formations preponderate, in almost every case which he

* Mém. pour servir à l'Hist. Natur. des Pyrenées, 1815, p. 435, 459.

† Philos. Transact. for 1836, p. 575.

has examined, if springs rise in granite, *it is just at the boundary of that formation with a stratified rock.* In a great many cases it happens, that part of the springs rise from granite, and part from the slate or limestone in contact with it; and, he correctly observes, a more striking instance of the immediate connexion between thermal waters and disturbed strata could not be desired.*

According to the observations of several geologists, the tertiary rocks in the *Pyrenées* extend horizontally to the foot of this chain, without entering, as the chalk, into the composition of any part of its mass. Elie de Beaumont thence infers that the *Pyrenées* received their position, relatively to the neighboring parts of the earth's surface, between the period of the deposition of green sand and that of chalk (a formation, whose raised strata, according to Dufrenoy's observations, ascend to the crest of this chain,) and before the deposition of the tertiary strata of various ages.† We can very well explain, according to this supposition, why the springs in the *Pyrenées* issue between the elevated granite and the raised strata of slate and limestone. The circumstance above quoted from Pallasou, viz., that the temperature of springs becomes lower, in proportion to their distance from the principal granite-mass, may perhaps be of little importance, since, according to the remark of Forbes, cold sulphureous springs are to be found, even within not many yards of others, having a high temperature, and almost an identical mineral composition. Of this he has met with two examples in very different parts of the chain, one at the *Eaux Bonnes*, where a perfectly cold spring rises within two hundred yards of the principal hot spring of the place, has similar medicinal properties, and is even more strongly impregnated with sulphur. The other example occurs at *Las Escaldas*, on the southern declivity of the *Eastern Pyrenées*, where a most efficacious cold sulphureous spring rises within about one hundred yards of a hot one. When, Forbes continues, to these facts we add others scarcely less curious, of springs of totally different mineral composition issuing from nearly the

* At *St Saureur* and *Thuez*, we have the co-ordinate, and, as Forbes p. 602, rightly thinks, connected phenomena of intrusive rocks, dislocations or fissures, metalliferous impregnation, and hot springs.

† See Poggendorff's *Annalen*, t. xxv, p. 26, also p. 58.

same spot, and with temperatures from 160° to 180° Fahr., as we see at *Ax* and at *Thuez*, we are forced to conclude that the source of mineralization must be independent, to a great extent, of that high temperature, and that the arguments, as to the origin of thermal springs founded upon their chemical composition, must be to a certain degree fallacious.

The origin of the sulphureous waters in the Pyrenées can scarcely be sought for in the granite, since no substances are contained in it which can be supposed to produce such springs. If such springs are formed by the decomposition of sulphates by means of substances containing carbon, it is very probable,* then we must look for the origin of the *Pyrenean* sulphureous waters in the secondary formations, perhaps in some coal stratum, or even possibly in the tertiary formations. This inference holds, even if the sulphureous springs are formed in a manner opposite to this view. If, now, the origin of the springs in question, in other words, if the materials necessary for their formation be present in one of the newer parts of the secondary formations, then warm or cold sulphureous springs will result, according as warm or cold water penetrates to this point. The granite plays, then, no other part here, than that of rendering possible the descent of meteoric water to great depths, and its re-ascent in consequence of the raising of the strata effected by the granite, which circumstance causes the heating of these waters.

In this point, I think both theories agree; viz., that which attributes the heat of springs to chemical processes, and that which refers its origin to central heat: for those who hold the former opinion will doubtless not assign the stratified formations as the seat of these chemical actions, but the granite, or the parts beneath it. According to both theories, then, the meteoric water will become warmer in proportion as it approaches nearer to the source of heat, which can be sought for only at great depths.

As the subterraneous course of springs is subjected to many kinds of local impediments, so veins of springs of similar origin may flow out at points very remote one from another; and, *vice*

* See my memoir in the *Neues Jhrbuch der Chemie and Phys.* t. vi, p. 251, year 1832. The proportionally large quantity of organic matter in the *Pyrenean* sulphureous springs (among which that of Barégine, so called from the valley of *Bareges*, is remarkable) speaks but little in favor of their origin from a mountain produced by volcanic fire.

versa, veins of very dissimilar local origin may issue very near one another. Nothing is therefore easier to conceive, than that any stratum in which the materials requisite for the formation of sulphureous springs at present, may be traversed by springs arising from very various depths, and therefore possessing very unusual temperatures, which circumstance would give rise to springs of similar chemical composition, but dissimilar temperature.

Forbes* remarks that the hot springs at *Baden-Baden*, on the border of the *Schwarzwald*, have a position almost identical with that which we have so invariably remarked in the *Pyrenées*. They occur just where the slate rocks have been violently upraised by a curious granitoid porphyry, which forms the picturesque elevations near the *Alte Schloss*, and which passes into a true granite. Upon the slate, red sandstone lies unconformably. The elevation is among the older of M. Elie de Beaumont's systems: he expressly states that the *Grès bigarré* is undisturbed.

Relative to the thermal springs in the *Pennine Alps*, Baskwell† remarks, that, according to his observations, the exits of all of them lie partly in the primitive mountains of the central chain itself, partly, and indeed most frequently, at their extremities, at the boundary between the primitive mountains and the secondary formations.

According to the beautiful investigations of De Beaumont, two different systems are to be distinguished in the Alps, viz., that of the Western Alps, and that of the principal chain from the *Valais to Austria*. *Mont Blanc* lies at the point of intersection of these two systems, which here meet at an angle of 45° – 50° ; also *Leuk*. The period of elevation of these two systems falls somewhat late. That of the strata belonging to the first system took place after the deposition of the newest tertiary formations of these regions, and that of the strata belonging to the second system between the deposition of the earlier diluvium (*des ältesten aufgeschwemmten Landes*) and the flowing of the diluvial streams, and at the time of the transport of the erratic Alpine rocks. The most favorable conditions for the origin of thermal springs evidently exist when the upraising, caused by the masses

* L. c., p. 609.

† Philos. Magazine, January, 1828, p. 14.

thrown up, extends to the newest formations. Therefore we are justified, under these circumstances, in expecting to find many thermal springs in this district, and especially at those points where two different systems of elevation have intersected each other at different periods, and admitted the meteoric water to penetrate to the interior. The thermal springs in the *Pennine Alps* are found partly in the direction of the principal chain of the *Alps*, partly, and more abundantly, in the points of intersection of this system with that of the *Western Alps*, and in this last system. Thus at *Naters* in the *Upper Valais*, (86° Fahr. ;) at *Leuk* (115° – 124° ;) in the valley of *Bagnes* at *Lavey*, southeast of *Bex* (113° ;) *Saute de Pucelle*, between *Moutiers* and *St. Maurice*, in *Chamouni* ; *St. Gervaise* on *Mont Blanc* (94° – 98° ;) *Courmayeur* and *St. Didier*, on the southern declivity of *Mont Blanc* (93° ;) *Aix les Bains* in *Savoy* (112° – 117° ,) with numerous hot springs in the neighborhood ; *Moutiers* in the *Tarentaise*, *Brida* in *Tarentaise*, and some at *Grenoble*.

It certainly deserves particular notice, that at one point of intersection (*Mont Blanc*) so many, and at the other (*Leuk*) the warmest springs are met with. Moreover, many thousand springs present themselves, some in the glacier streams, some under the glaciers themselves, and some may be stopped up. Thus, most of the above mentioned thermal springs have been discovered only since *Saussure's* journeys ; a few very lately, such as that at *Lavey* in the bed of *Rhone* in 1831 ; and others again have become filled up.

Among those which occur in the continuation of the principal Alpine chain, I will mention only the two most celebrated, *Pfeffers* and *Gastein*. They are distinguished by their very small proportion of solid and volatile ingredients. In fact they are scarcely any thing more than warm glacier-water.* It seems to me that these thermal springs, and probably many others also in the *Alps*, resemble exactly those in *Ischia*, which *Daubeny* supposes to be purely the result of the infiltration of water to spots in the interior of the earth retaining a high temperature, with this difference only, that these spots lie somewhat deeper in the

* Of the thermal water of *Gastein*, 10,000 parts contain only 3.5 solid matter ; the same quantity of water from the *Lüttschine*, which flows immediately out under the glacier, contains only one, and that from the *Aar* at *Bern* only, 2.2.

Alps than at *Ischia*, where the hot masses approach nearer to the surface in consequence of volcanic activity.

In regions where, after the earlier general elevations, later partial fractures and elevations have been produced by volcanic action, remarkable phenomena also present themselves, with regard to the existence of thermal springs; as for instance, in *Auvergne*, and in the vicinity of the *Laacher See*.

In regard to the former, it is worthy of remark, that the baths of *Mont-Dore* are situated almost at the geographical centre of that group of hills, and also at the position of greatest dislocation; two of the centres of elevation, which *Elie de Beaumont* and *Dufrénoy* have pointed out, being found on one side, and one on the other. The springs issue immediately from trachyte, which is most remarkably and beautifully columnar just at the baths. These columns have an extremely slaty cleavage perpendicular to their axes.* Although the clay-slate rocks in the district of the *Laacher See* are very massive, and so far unfavorable to the penetration of meteoric water to great depths, yet the number of mineral springs here is very considerable. They belong, in general, to the class of thermal springs, although their temperature is for the most part but little (often only $1^{\circ}.5$) above the mean of the soil. The strata of these rocks are raised, and thereby produce a descent of the meteoric water to deeper points; nevertheless, springs of this kind are very rare, where no volcanic masses have been broken through. In these rocks slate-surfaces (*Schieferungs Flächen*) are often found, which do not coincide with the direction of the strata, but intersect them at an acute angle. These slate-surfaces give origin here and there to mineral springs, and a copious disengagement of carbonic acid gas.

By far the greater number of the mineral springs take their rise in valleys more or less deeply hollowed, on both sides of whose declivities, conical volcanic rocks, chiefly of a basaltic nature, have broken through. Some of them rise immediately from the clay-slate rocks, frequently from the cleavage surfaces which separate the strata of clay-slate and greywacke, and some come from volcanic masses (trass and volcanic ashes) which cover these rocks. The circumstance that these mineral springs seldom, perhaps

* Forbes, loco cit, p. 607.

never, flow out at the boundary between the erupted masses and the fundamental rocks, gives us an indication where to seek their origin. If the strata of the fundamental rocks, A, A, Fig. 2, are

Fig. 2.

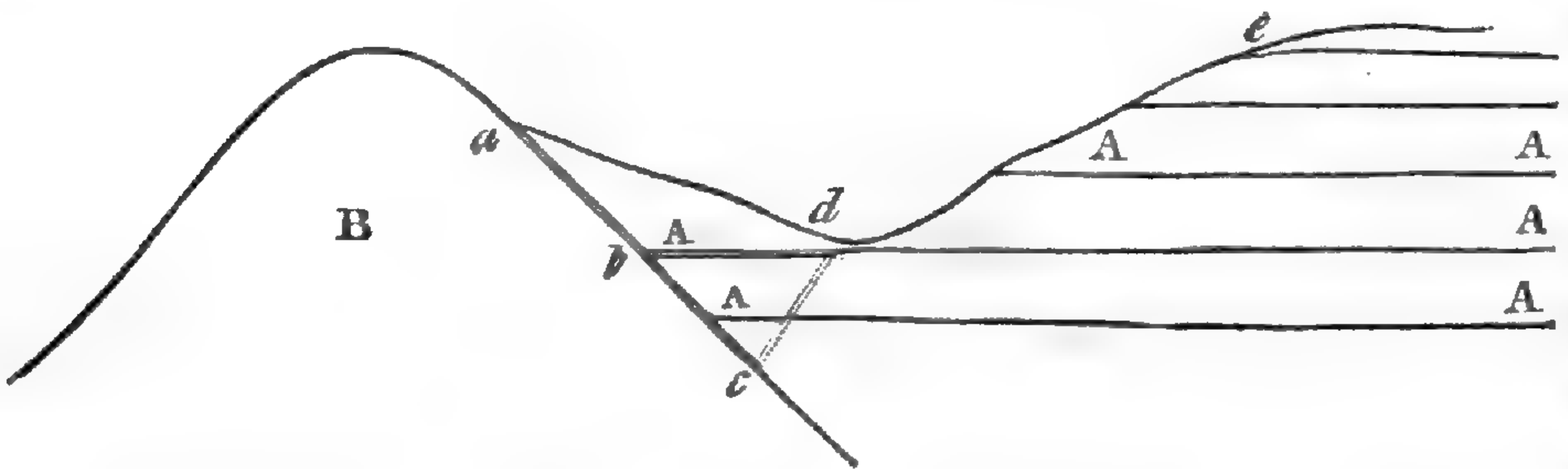

inclined from the erupted volcanic mass B, then a cleft will be formed to a great depth in the interior of the earth at the boundary between this cone and the fundamental rocks, in consequence of the contraction of the former during its cooling. Down this cleft the meteoric water penetrates and meets the streams of carbonic acid gas developed in the interior. This latter is absorbed by the water, owing to the strong hydrostatic pressure exerted at so great a depth. This forms a water impregnated with carbonic acid, which effects a decomposition and solution of the stone, and hence arises an acidulous spring, rich in carbonic acid and carbonates. The deeper the meteoric water penetrates, the warmer it becomes. Rising springs of water are then produced in this cleft, through which the concentrated mineral water formed beneath at *c*, rises to *b*. If here the direction of the slaty or stratified surface (Schieferungs oder Schichtungs Fläche) leads down to *d*, which either has an immediate exit in the section of the valley *a b e*, or runs at a slight depth below the surface, then the mineral spring will issue, owing to the pressure of the column of water *a b*. While the rising streams of warm water take the course *c b d*, the originally concentrated mineral water becomes diluted by the fresh water flowing down from above; the carbonic acid gas, absorbed in great quantity beneath, is gradually disengaged as the water rises, and consequently the hydrostatic pressure is diminished, and thus free carbonic acid gas is evolved at *d* with the acidulous spring. It is clear, that the carbonic acid gas, which is constantly disengaged from the rising water during its whole course, not only moves on with the water on the surface of the stratum *b d*, but fills all the intervals

of the clefts in the whole clay-slate rocks so that the gas will be evolved wherever these clefts are open at the surface. If these fissures open above the bottom of the valley, and therefore are not filled with water, at least not up to the opening, then the gas will escape from them with a hissing noise. If, on the other hand, they open from beneath the bottom of the valley, and are therefore filled with water, then the gas will escape bubbling through the water, and present entirely the appearance of a mineral spring. If, lastly, these fissures be covered by alluvium, which, nevertheless, does not form an air-tight covering, then the gas will escape silently from the ground, and such places are recognized from the scanty vegetation which exists there. I know but one of the first description of fissures in that district, which is found close to the first mineral spring, called *Fehlenbor*, in the valley of *Burgbrohl*, between *Tönnisstein* and *Burgbrohl*. Such a fissure is also found in the *Eifel*, in the *Brudeldreis*, as it is called, not far from *Biresborn*. Fissures filled with water, from which gas is evolved, are tolerably numerous, as, for example in the valley of *Burgbrohl*. I formerly considered these spots (which are constantly met with in the vicinity of the brooks, and consist of little basins filled with water) to be actual mineral springs. If, however, the basin be emptied out, or the water drained off, it is at once perceived that no water springs up, but that merely an escape of gas takes place. I have had an opportunity of causing such gas-springs to be enclosed, and found the disengagement of carbonic acid gas to be extremely copious.* Fissures, covered by accumulated earth, are very frequently met with. If such a place presents a slight excavation, in which the gas collects, suffocated animals, as birds, mice, frogs, &c., are commonly found in it.

As springs run in the most different directions between the surfaces of strata, and through the fissures of the strata, so also do these disengaged gases. I have often had occasion to cause excavations to be made, in places where a scanty vegetation rendered the disengagement of carbonic acid gas at some depth probable. Fissures were often met with in the trass, out of which rose abundant streams of this gas. Sometimes natural canals in the trass were found under a covering of *Sphärosiderit*, which

* *Jahrb. der Chemie et Phys* t. lvi, p. 129. (1829.)

could be pursued from ten to twenty feet in a horizontal direction, or nearly so, and which doubtless were prolonged still farther.*

If the carbonic acid gas arises from below with considerable elasticity, and the cleft contracts very much from *b* to *c*, then it may easily happen that the meteoric water may penetrate but little below *b*. In this case, the column of water *a b*, will be as it were supported by the column of gas,† and at the point of contact, a constant absorption of the gas will be going on. In this manner, probably, are those mineral springs formed, which abound in carbonic acid gas, but contain very little solid matter, and whose average temperature exceeds but little that of the neighboring wells. It must frequently be the case, moreover, that many springs which rise from a greater depth, and therefore are originally warm, become cooled by mixture with cooler springs.

The warmest of the mineral springs in the environs of the *Laacher See* exceed the mean temperature of the ground by 7° to 10° Fahrenheit. What is worthy of remark is, that they rise from the deepest spots of the valley, where, therefore, their subterraneous channels are proportionably deepest under the rock, and possess already a relatively higher temperature. On pursuing the mineral springs up the valley, we find that their temperature decreases in a somewhat regular ratio.‡

The proportionably small number of clefts in the clay-slate rocks may certainly account for the circumstance, that, in the *Laacher See*, the *Eifel*, and the *Taunus*, so few springs of considerable high temperature occur, though the channels of the carbonic acid gas lead down to such great depths, probably to points where a red heat exists. Such warm springs may perhaps owe their existence to the favorable circumstance of a cleavage surface, which intersects the strata at an obtuse angle, leading up from the cleft between the volcanic cone and the clay-slate rock, and opening at a valley, as *c d*. Perhaps the warm springs at *Bertrich*

* Neues Jahrbuch de Chem. et Phys. t. viii, p. 423, year 1833.

† The rising and falling of the periodic spring of the salt-work at *Kissingen*, is doubtless a consequence of the elasticity of carbonic acid gas. See Poggendorff's Ann. t. xl, p. 495.

‡ So in the chain of *Taunus* mountains, the warm springs rise deep in the valley, the cold acidulous springs on the heights.

and *Ems*, which rise in deeply hollowed valleys in clay-slate rocks, are thus produced.

We may also easily conceive the possibility of obtaining a thermal spring by boring. A slight glance at the figure will show that a hole bored into a clay-slate rock in a valley, in the vicinity of a volcanic cone, will probably give exit to a thermal spring, if the borer reach the surface of a stratum or a slate surface communicating with the cleft between the volcanic and the clay-slate rock. A successful attempt of this kind was actually made a few years ago, by boring into the clay-slate rock at the foot of the basaltic hill, the *Landskrone* in the *Ahr* valley, about three German miles north of the *Laacher See*, when a copious mineral was obtained of the temperature of 58° F., affording considerable disengagement of carbonic acid gas. Indications prognosticating a favorable result of this undertaking were indeed present, inasmuch as a mineral spring already existed at the distance of but a few steps from the spot.*

Phenomena, perfectly resembling those which are observed where volcanic masses have actually broken through, present themselves very frequently. A cleavage, reaching to great depths, may also be a consequence of a preceding elevation and fracture of the component strata, without an actual breaking through having taken place. These phenomena are found in formations of all ages. Thus Hoffmann† has pointed out, in the north-west of *Germany*, some peculiar valleys which, originally perfectly closed, are surrounded on all sides by a precipitous escarpment, whose component strata incline from the centre downward, in every direction. He has given to these valleys the name of

* A joint-stock company is also at this moment employed in boring into clay-slate rock at *Thal-Ehrenbreitstein*, near *Coblentz*, in order to procure thermal springs. Since this spot lies scarcely two German miles distant from the well-known hot springs of the temperature of 75° to 131° F. at *Ems*, and at a lower level, and since an acidulous spring already exists there, the possibility of the success of this undertaking is as little to be despaired of, as a favorable result can be promised. Leop. von Buch's remarks on this subject in *Nöggeraths Ausflug nach Böhmen*. Bonn. 1838, p. 5. The instance of the salt work of *Nauenheim*, near *Friedberg*, where a salt spring of 100° F. with immense disengagement of carbonic acid gas was obtained by boring, proves that success is more likely to attend by boring into secondary formations, where a more frequent alternation of various strata exists. At *Hofgeismar*, near *Cassel*, a new thermal spring with copious disengagement of carbonic acid gas was also obtained by boring, in May, 1834.

† Poggendorff's *Ann.* t. xvii, p. 151.

valleys of elevation. The most remarkable of these, are those of *Pyrmont*, *Meinberg*, and *Driburg*, where the well-known chalybeate springs rise, accompanied by a considerable disengagement of carbonic acid gas. *Pyrmont* and *Meinberg* lie precisely at those places where the directions of the northeastern system of mountains and of that of the *Rhine* intersect.

Here, therefore, we find also a considerable disengagement of carbonic acid gas; yet no volcanic masses which have broken through; but only the secondary strata of shell limestone, of keuper and variegated sandstone, raised up and fractured. The mineral springs are of another kind, and the alkaline carbonates are wanting, while sulphates and metallic chlorides supply their place. We may easily explain this by the absence of rocks containing alkalis; for instance, basalt or any other volcanic rocks. The clefts produced by these fractures reach certainly to great depths; carbonic acid gas may be evolved from them, but its elasticity seems to prevent the penetration of meteoric water. The mean temperature of the mineral springs there, exceeds, therefore, but little that of the place of their occurrence. This is especially the case with the mineral springs at *Meinberg*, whose considerable annual variations of temperature prove that they take their origin very near the surface. The considerable elasticity with which the carbonic acid gas escapes, and which is greater than I have observed at any place where gas is evolved, prevents, no doubt, the deep penetration of meteoric water. Moreover, we may remark, that the inclination of the strata, from the centre downwards in every direction, carries the meteoric water away from the seat of the evolution of the carbonic acid gas. Even supposing, then, that the water could penetrate to the depth of the channels of carbonic acid, it would not rise, owing to the

Fig. 3.

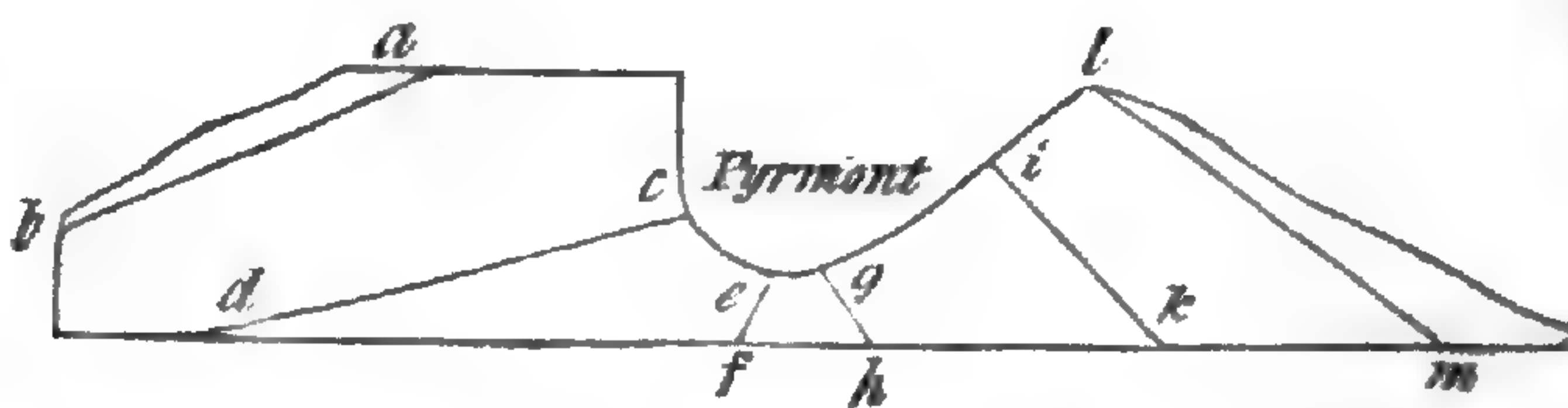

absence of the pressure of a column of water. The section of the valley of elevation of *Pyrmont*, taken from Hoffmann's work, Fig. 3, distinctly shows the inclination of the strata *ab*, *cd*, *ef*, *gh*, *ik*, *lm*, from the centre downwards.

It is possible that the raising and fracture of the secondary strata in such valleys of elevation, was the consequence of the elevation of volcanic masses from beneath, which masses have not appeared at the surface. Supposing this to be the case, we can easily imagine that at such places, mineral springs may be produced which contain carbonates of alkalies, because the meteoric water only can penetrate to these masses. But the low temperature of the acidulous springs in question, shows that meteoric water penetrates to very small depths only at these places.

Valleys of elevation of the kind described, seem to be of tolerably frequent occurrence; thermal springs and disengagements of carbonic acid gas are not, however, always met with, either for want of sufficient depth of the clefts, or for want of materials which give rise to the disengagement of carbonic acid gas. Instances of three of such valleys at the eastern end of the basin of *London*, are given by Buckland.* See also his and Conybeare's† description of the structure of the country at *St. Vincent's* rocks; and the example at *Matlock* long ago pointed out by Whitehurst.‡ Many other instances of this kind occur in Daubeny's report.§ Stiff§ also has long ago shown, that the rocks in the neighborhood of the mineral springs of the *Nassau* territory manifest evident changes in the direction and inclination of their strata, especially saddle-shaped elevations, often accompanied with fractures.

Finally, dislocations or faults produced by elevations and intersecting stratified rocks, may direct the subterranean course of springs in a very different manner. Buckland¶ has given many instances of springs originating from causes of this kind.

If we take a summary view of all that has been said on the subject of thermal springs, we shall find it impossible to avoid recognizing a relation between elevations of Plutonic masses, the upraising of Neptunian formations, and thermal springs. Cause and effect have, however, been frequently confounded here. Thermal and mineral springs are seldom, perhaps never, the cause of those effects. Where, however, these effects are observed,

* *Geological Transact. sec. ser. vol. ii, part i, p. 119.*

† *Theory of the Earth, 1786.*

‡ *Rullmann Wiesbaden, &c. 1823, p. 103.*

¶ *Geology and Mineralogy, &c. London, 1836, Vol. ii, p. 106 and 110.*

† *Ibid, vol. i.*

‡ *P. 66.*

where, in consequence, the penetration of meteoric water into the interior of our earth has been rendered possible, and where natural hydraulic tubes have been formed by the upraising of strata, there the phenomena of thermal and mineral springs were the consequence.

We should transgress our limits, were we here to pursue the subject of thermal springs in their chemical relations, since the general aim of these remarks is to show that their degree of heat depends on the greater or less depth of their origin, consequently wholly and solely on central heat. The following remarks, however, upon their chemical constitution, may perhaps not be entirely superfluous.

The chemical ingredients of those springs which take their origin at the boundary between volcanic and Neptunian formations, are derived in some springs from the former, in others from the latter formations, in others again from both. The following conjecture is probable. If considerable quantities of carbonic acid gas are disengaged from the interior, which are absorbed under strong hydrostatic pressure by the water, and thus act on the volcanic stone, decompositions ensue. The alkalies which are found in all stony masses of igneous origin, are extracted by the carbonic acid, and taken up by the water as carbonate of alkalies, and especially carbonate of soda. In the same manner are formed the bicarbonates of lime, magnesia, and of protoxide of iron. Metallic chlorides and sulphates may perhaps be less frequently derived from volcanic matter, and more so from the Neptunian formations. In this matter probably, are formed the great number of springs, which rise in the neighborhood of basaltic hills. Where there is no disengagement of carbonic acid gas from the interior, no such mineral springs are found; at least we cannot assume that in this case the volcanic rock contributes anything essential to the constituents of the springs. Thus, probably, neither in the *Pyrenées* nor *Alps* do the springs take up anything essential from these rocks. The circumstance, that springs of very various chemical composition arise in the vicinity of the granite of different mountains, might here serve as an indirect proof. At the same time, the nearly similar composition of the springs occurring in the neighborhood of the basaltic cones, where carbonic acid gas is disengaged, however different may

be the Neptunian formations, is an argument in favor of these springs deriving their ingredients principally from the basalt.

The organic matter found in such abundance in the sulphureous springs of the *Pyrenées* (baregine, glairine, animal matter) proves, that their chemical constituents must be derived, at least in part, from the Neptunian formations. Since no carbonic acid escapes from the rocks there, the granite in the interior may, indeed, suffer but slight decompositions. The formation of the sulphureous springs there, probably by the decomposition of sulphates by organic matter, is certainly much favored by the high temperature of these springs; and this again is a consequence of the great depth to which the clefts extend in the strata, which are piled up one on another in considerable masses, and partly raised up, with many strata-surfaces between them. The coincidence of various circumstances may thus produce one class of thermal springs in preference to another.

In the *Alps*, where, on account of the absence of escapes of carbonic acid gas, decomposition of the granite and other volcanic rocks does not take place, and where even the Neptunian formations contain few soluble substances, we find thermal springs, which are scarcely any thing more than ordinary warm water.

On the other hand, we see thermal springs issuing, to all appearance, from erupted masses, which springs contain ingredients apparently peculiar to those which can be proved to issue from Neptunian formations. This is, for instance the case with the salt-spring, which rises at *Kreuznach* out of porphyry. This rock is but little fissured, and yet the high temperature of the springs, 58° to 83° , indicates a deep origin. Since the porphyry has penetrated the variegated sandstone, the latter, and also the shelly limestone, lie in close contact with the springs, so that this volcanic rock has no other share in the formation of these springs, than the production of deep clefts between itself and the Neptunian formations, which have permitted meteoric water to penetrate into the strata containing the salts. We must not pass over one circumstance, which induces us to attribute to these saline springs a totally distinct origin, viz., that sulphate of lime, which otherwise so generally accompanies the common salt, is here entirely absent, and that these springs are remarkable for their abundance of bromine and iodine.

As escapes of steam (fumaroles) show themselves in regions (Tuscany for example) where hot masses have approached the surface of the earth by volcanic activity, one might perhaps be induced to expect evolutions of steam from clefts penetrating deep into the interior. It must, however, be observed, that between these two cases a wide difference exists. In regions where volcanic action still manifests itself, clefts can with ease extend in masses which are of a boiling heat or even hotter. Meteoric water penetrating these clefts will be converted into vapor and exhaled. Were, however, such a phenomenon to show itself in regions where the increase of temperature follows the progression, which we have found it to do in accessible depths, then must such clefts extend perpendicularly to a depth of about 8280 feet in our country. But are any rocks, even the unstratified masses, traversed by continuous clefts of so great a depth? In granite the prismatic separation is very frequent. The columnar structure is most distinct in basalt, aphanite, and all dense and homogeneous rocks. The columns are sometimes traversed and disjointed by traverse clefts. The surfaces of separation (*Absonderungs Flächen*) in the smaller masses, always lie perpendicularly on the adjacent ones, as do also the columns, when present. Let us assume that such a jointed separation extends to the requisite depth, and that meteoric water penetrates so far, and then it will certainly rise converted into steam; when, however, it attains the higher colder regions, it will become condensed again, and resume the same course or circulation.

Since the volcanic masses, when thrown up, form, generally, the greatest heights, we must look in them for the compressing columns of water, which render the rising of the springs possible. The possibility of such a case is conceivable, when the surface of the unstratified rock is inclined in one or more directions, and the columnar separations are jointed by transverse clefts. It is, however, even then, possible only when the transverse clefts have no continuation outwards, for in this case the water will take a side course, and either issue on the slope of the rocks as springs, or, if raised strata exist, it will take the course designated in the preceding remarks. These two last cases seem to be the most usual, as the circumstances above explained, prove, viz., that thermal springs most frequently present themselves between the unstratified and stratified rocks. I have imagined the

last case, in order to exhibit the possibility of hot springs rising in the *Alps*, when water descends from great heights to the interior of the rocks, flows through warmer strata of earth, and then makes its exit in the valleys. It is clear that such springs merely flow from above downwards, when the raised strata make their appearance externally, but that they will, on the other hand, rise again, if the strata are upraised in the form of a trough on the opposite side.

Phenomena lately observed, may perhaps present cases, where the effect of the internal heat of the earth nearly approaches the surface. Marcel de Serres,* for instance, describes a cave near *Montpellier*, situated in the Jura limestone, in which, at depths of 135 and 150 feet, a constant temperature of $72^{\circ}.5$ F. prevails, which exceeds by 10° the mean temperature of *Montpellier* ($62^{\circ}.5$.) He shows that no accidental circumstance, such as decompositions, the burning of tapers, or the respiration of those who visit the cave, can be the cause of this phenomenon; but believes it is to be sought for in the central heat, which rises through clefts and affects one point more, another adjacent one less. Thus, at the distance of about 1200 feet from this cave is found a cleft in the same formation, from which issue watery vapors, whose temperature, $73^{\circ}.5$ (that of the external air being 52° – $54^{\circ}.5$,) is nearly the same as of an artesian well close in the vicinity of the cave (70° – 72° .) These vapors, which probably rise from thermal springs existing beneath, are constantly disengaged, and maintain a temperature of $73^{\circ}.5$, though in constant contact with the external air. The cleft from which they issue, communicates with other wider clefts, which expand into caves, into which the inhabitants of the estate of *Astier* have already penetrated. The laborers on this estate are in the habit of warming themselves pretty frequently in the hole where these vapors are formed. On examinations, this vapor has all the purity of distilled water. At an earlier period there existed, at the distance of 150 to 180 feet N.E. of the grotto of *Astier*, another opening from which an equally warm vapor was evolved, which could be perceived at some distance off. This opening has, however, been since filled up. This constant vaporization of water, in the middle of the same rock in which the cave

* Des Cavernes chaudes des environs de Montpellier in *Annal. de Chim. et de Phys.* t. lxxv, p. 280.

is found, shows pretty evidently the cause of the warmth in the latter.

It is scarcely to be doubted, but that, on closer investigation, the phenomenon of local heat in caves in the limestone rocks, which are fissured to such great depths, would be found to be of more frequent occurrence. The spring of the *Orbe* in the Jura mountain, formerly mentioned, which is nothing more than the discharge of the lakes situated 680 feet higher in the valley of the *Joux*, proves among others, to what a depth the clefts in the limestone rocks descend.

The whole ridge of the chalk hill of the *Teutoburger Wald* near *Paderborn*, is fissured to depths exceeding 800 feet, so that, on this whole ridge, either no springs at all, or but a few very scanty ones, are met with, which probably owe their existence to partial beds of marl in the chalk rocks. In three villages which lie on this ridge, there is but one well 80 feet deep. On account of this almost total want of water, these are called the "Dry Villages." The cleavage continues in the valleys, which traverse these hills, consequently the brooks and rivers which flow through them gradually sink and flow out of the openings of these valleys only in the wet season of the year. At the foot of these chalk hills on the other hand, where the fissured limestone is covered by a stratum of marl, a very great number of copious springs issue, several of which form considerable rivers, as the *Lippe*, *Pader*, *Heier*, &c., immediately after their exit. The cleavage of the chalk rocks is doubtless continued in the *Quader Sandstein*, which lie below and probably is limited by the lias (*gryphitenkalk*) and variegated marl, which follow immediately below the green sand, and which are remarkable for their large strata of clay marl (*thonmergel*), that are impermeable, unless broken or dislocated by elevations. This whole chain of hills, then, from the clay-marl strata to the level of the springs which issue on the western declivity of the *Teutoburger Wald*, is, therefore, saturated with water like a sponge. Not merely geognostical reasons, but also physical relations, furnish incontestible proofs of the existence of these considerable subterraneous reservoirs of water. For instance, while the water of the above-mentioned sinking brooks and rivers penetrates into the interior of the hills with the variable temperature of the seasons, the waters of the numerous springs of *Paderborn*, whose

mean temperature is $50^{\circ}.6$ F, and exceeds the mean temperature of the soil by about $1^{\circ}.7$, present already a uniform degree of heat. Thus, on the 21st May, 1834, I found the temperature of the *Alme* at *Brenken*, where considerable masses of the water of this river flow down through the clefts of the chalk, to be 63° , while the springs at *Geseke*, at the distance of 22,000 feet, which doubtless receive their supply from this river, were of the temperature of 49° to 51° . The miller there, whose mill is turned by one of these springs (what is called the *Völmeder* spring,) told me he had often opened the holes found on the banks of the *Alme*, and let in as much water as would have been alone sufficient to turn his mill, but that he never perceived the slightest increase of the streams. This also proves the great extent of the subterraneous reservoir of water, whose discharges are not perceptibly increased by an addition of water. If, indeed, these additions are continued by continued wet weather, and the level of the subterraneous reservoir rises, then, not only will those springs become more copious, but water will also issue from high situated channels, which contained no water during the dry season. Lastly, the same miller assured me that the muddiness of his mill streams by no means depended on that of the *Alme*, since they always become so after rain. Opinions were, however, divided on this point, as other inhabitants of *Geseke* maintained, that, within twelve or sixteen hours after rain, the *Alme* became muddy, and the *Völmeder* springs became so too, while this had no influence on the springs in the town. Be this as it will, thus much is certain, that all the springs there do not become muddy after rain, but that many always remain clear, as the warmer among the *Pader* springs. This circumstance is also a satisfactory proof of the great extent of the subterraneous reservoir, because, notwithstanding the fact, that the sinking rivers and brooks, as well as the rain-water and snow-water, which penetrate into the fissures of the fissured rock, are all muddy in rainy weather, yet the warmer springs, those consequently which rise from a greater depth, run out clear.

I have instituted some experiments in order to ascertain what must be the extent of a single mass of water, which retains a uniform temperature, when a given quantity of water is added to it, whose temperature varies with the variable temperature of the rivers of our latitude, and when from it is discharged an equal

quantity of water, whose annual variations of temperature are limited to those observed in the coldest of the *Pader* springs.* The water district (Wassergebiet) of these springs is about 216 millions of square feet, and the quantity of water which they afford in one minute 16,530 cubic feet, according to measurements, as accurate as the nature of the thing would admit. It was calculated, from these numerical data, that a mass of water, 120 feet in depth, must be present in this district where the springs rise, if all the water which sinks here in half a year produce an alteration of temperature of $2^{\circ}.25$ F., presupposing that a mean difference of $22^{\circ}.5$ exists between the temperature of the water which sinks, and of that which lies in the fissured rock. Since, however, the presupposition that *all* the springs in *Paderborn* undergo this variation of temperature of $2^{\circ}.25$ in a half year, applies only to those whose average temperature does not exceed $50^{\circ}.6$ F.; while the warmer springs, which are by far the more numerous, exhibit no variation of temperature during the whole year; the size of the subterraneous reservoir must be much vaster, if such *considerable* quantities of water of a *uniform* temperature flow from it, while the water which sinks and is added to it, suffers variations of temperature dependent on those of the atmosphere.

Calculations of this kind can, from the nature of the subject, give but approximations to the real size of that of which we could otherwise form no estimate at all. The preceding calculation shows, at least, that all the clefts and caverns in the chalk rock of the *Teutoburger Wald* must be filled with water from the level of the springs, down to some impermeable stratum. How otherwise can we explain the fact, that considerable quantities of water of the varying temperature of the atmosphere constantly sink into the rock, and that as considerable quantities flow out at the slope of the rock, presenting a uniform tempera-

* It is really a remarkable fact to see so considerable a number of springs rise in so small a compass as the lower part of the town of *Paderborn*. Their number is said to amount to 130, several of which constantly appear close together, often at the distance of but one or two paces, and immediately form considerable brooks, which by their union form the *Pader*, so large a river, that its different branches turn no less than fourteen undershot water-wheels of the town situated near together. Almost equally large masses of water, however, derive their sources from *Lippspring*, *Kirchborchen*, and *Upsprung*, not to mention the many other springs which lie dispersed at the foot of that chain of hills.

ture, or at all events, one which varies only $4^{\circ}.5$ Fahr., in a whole year. Since the conjecture is probable that the lias and the variegated marl present the first entirely impermeable strata, we may also conclude, that not only the chalk formation, but also the green sand, which is equally fissured, are filled by the reservoir, and that its bottom is formed by the above mentioned impermeable strata. Lastly, the high temperature of what are called the warm Pader springs ($54^{\circ}.5$ – $61^{\circ}.25$ Fahr.) indicates also an origin from a greater depth, if they do not flow in distinct channels, but come from warm streams, which rise from the base of the reservoir.

The copious springs, which rise on the western declivity of the *Teutoburger Wald*, owe their abundance of water, even in dry seasons, to these vast subterraneous reservoirs; and what is derived from these reservoirs, is abundantly replaced in the rainy seasons, when nearly all the water collected in a district so much fissured, penetrates into the interior.

These large masses of water, whose temperature exceeds, by several degrees the average one of the district under which they are collected, and which brings so much the more heat to their surface the deeper they penetrate, have doubtless the effect of warming the hills under which they exist. It is therefore perhaps a phenomena of universal occurrence, that all chalk hills, which are much fissured, and into which brooks, rivers, and most of the meteoric water sink, maintain a relatively higher temperature. The *Pader* springs alone, however, show how inexhaustible must be the sources which warm such vast masses of water. These springs furnish in a year at least 8688 millions of cubic feet of water, whose average temperature exceeds by at least $6^{\circ}.75$ Fahr., the average temperature of the ground at *Paderborn*, and this excess would melt a cube of ice, having a side of 934 feet. This heat is irrevocably withdrawn from the interior, and yet the thermal springs of *Paderborn* have sustained no diminution of heat from time immemorial.* Chemical processes, which could there give rise to such inexhaustible sources of heat in the youngest secondary formations, must be, or have been, carried on to a great extent indeed!

* By far the greater number of the remaining copious springs, which rise on the western declivity of the *Tutoburger Wald*, are also thermal ones. Some, for instance, in *Lippspring* attain a temperature of $54^{\circ}.5$.

ART. V.—*Reply of Dr. DAUBENY to Prof. Bischof's Objections to the Chemical Theory of Volcanos.*—Edinb. New Phil. Jour. for April, 1839.

Prof. DAUBENY after referring to an article of his in the Edinb. Jour. for 1832, and to the article Volcanic Geology, in the Encyclop. Metro., proceeds to vindicate his own views in regard to the chemical theory of volcanos, by replying as follows, to the objections against it.

1st Objection.—It is not true that volcanos are always near the sea.

Pesckan, in the centre of Asia, is 260 geographical miles from any great sea, and yet has given rise to streams of lava within the period of our history. It also lies 25 geographical miles from the lake of Timartu or Issikul, which is not twice as large as the lake of Geneva.

The volcano of Turfan also is surrounded by very inconsiderable lakes.

Answer.—The general connection of volcanic action with, or a proximity to, large masses of salt or fresh water, is all that seems required by the conditions of our theory.

Now, in proof of this general proximity, it may be remarked, that out of a catalogue of no less than 163 active vents enumerated by M. Arago, as occurring in various parts of the known world, all excepting two or three in different parts of America, and about the same number of which we possess very imperfect information, in Central Asia, are within a short distance at least of the ocean. It is even found that the very excepted cases, when examined, tend to confirm the rule, being so situated, that their connection, either with the ocean or with inland seas that may supply its place, becomes a matter of fair inference. In proof of this, we need only refer to the descriptions given by Humboldt of Jorullo; from which it appears, that distant as this mountain may be both from the Atlantic and Pacific Oceans, it is nevertheless connected with one or both through the medium of a chain of volcanic eminences; and even the volcanos of Tartary, whose existence in an active condition is more problematical, may be connected with some of those extensive salt lakes which seem to abound in the depressed portion of Central Asia.

2d Objection.—Atmospheric air cannot gain admittance to the focus of a volcano, because there must be an enormous force act-

ing outwards to protrude the liquid lava to so great a height, and as this pressure continues for *many years*, during which time the phenomena by no means abate in activity, it is impossible that air should in any way contribute to it.

Answer.—The very conditions of our theory imply the existence near and about the focus of the volcano of vast caverns, caused originally by the heaving up of the softened rocks, owing to the elastic vapors disengaged, and consequently filled in the first instance by these matters. But the amount of these vapors must be undergoing continual oscillation. 1st, Owing to differences of temperature caused by the constantly varying intensity of the volcanic action. 2dly, By the reaction of the gases upon each other, as for instance, sulphuretted hydrogen upon sulphurous acid, muriatic and carbonic acids upon ammonia, the fixed alkalies and the earths. 3dly, By the ever-varying proportion between the amount of water decomposed by the alkaline or earthy metals, and generated by the union of hydrogen to the oxygen present. Hence, unless the passages between these caverns and the external atmosphere were hermetically sealed (which no one contends), air must at times enter the latter to fill the vacuum thus occasioned.

3d Objection.—If the oxidation of the earthy and alkaline metals were to take place at the expense of water, enormous quantities of hydrogen would be evolved, which has never been observed.

Answer.—Hydrogen could hardly be expected to escape in a free state from a spot which contained so many elements for which it possesses a strong affinity, and to which it would be presented under the influence of the pressure and temperature so well calculated to promote its combination with them.

Thus, sulphur and chlorine we *know* to be generally present in volcanos, and oxygen and nitrogen, we may fairly *assume* to be so. But, although hydrogen may not be disengaged alone, large quantities of it, in combination with sulphur, appear to be almost universally evolved from volcanos, and it is probable that the great beds of sulphur which exist in most volcanic districts (*viz.* Sicily) are the result of the decomposition of the sulphuretted hydrogen evolved. Nor, indeed, does it seem possible to explain the presence of this hydrogen, without having recourse to the chemical theory.

4th Objection.—The evolution of carbonic acid by volcanos is not explained, and these disengagements of carbonic acid gas could not take place in the presence of atmospheric air in those vast subterranean cavities without their mixing together. Now, the carbonic acid evolved by volcanos (Vesuvius, Eifel, &c.,) contains but little atmospheric air.

Answer.—The evolution of carbonic acid in countries exposed to the influence of volcanic heat, would seem to be a necessary result of the existence of calcareous matter in the rock formations. Its continuance for so long a period after the volcano has ceased to be in activity, seems to show, that it is not derived directly from the chemical processes which produce the phenomena in question, but is only caused by the heat which these processes tend to diffuse through the adjacent rocks. Hence there seems no reason why it should be intermixed with any large proportion of common air, though, as I have shown, this ingredient is rarely altogether absent in any samples which it has fallen to my lot to examine.

5th Objection.—No nitrogen, according to Boussingault, is evolved from the volcanos under the equator, as would be the case if any process of oxydation were going on in which atmospheric air co-operated.

Answer.—The nitrogen remaining after the atmospheric air had been robbed of its oxygen, by the inflammable bodies present, may reach the air either in a separate condition, or united with hydrogen in the form of ammonia. The former I have generally found to be the case in thermal springs connected with volcanos in an extinct or languid condition—the latter in the craters or fumaroles of those still in a state of greater or less activity. I do not wonder, therefore, that Boussingault should have rarely detected nitrogen in the volcanos of the equator,* but I should expect that sal-ammoniac may, nevertheless, be exhaled from some of them. If this be not the case, it is still possible that the sal-ammoniac sublimed may have been accumulated within some of the vast cavities existing in the interior of the volcano, so that the occasional absence of nitrogen seems less difficult of explanation in accordance with the chemical theory,

* In two instances it was present.

than the frequent associations of it with volcanos is, if we do not have recourse to this hypothesis.

6th Objection.—The metals of the earths are not sufficiently oxidizable to kindle on the access of water, and to produce the intense heat which would be necessary for producing and liquefying lavas.

Answer.—Silicon, though when pure it is incapable of decomposing water, and is incombustible in oxygen, yet kindles readily when united either with a little hydrogen or with alkaline carbonates. Aluminium, even by itself, burns brilliantly when heated above redness, and dissolves with the evolution of hydrogen in very dilute solutions of potassa.

Calcium and magnesium appear to be still more inflammable, and the bases of the alkalies, present along, and perhaps in combination with them, might, whenever water obtained access, generate heat sufficient to cause the other bases to enter into combination with oxygen. Besides, we know that aluminium and magnesium enter readily, with an evolution of heat and light, into combination with chlorine, a body which (as we shall see) there is good reason for supposing present in volcanos.

7th Objection.—The slight specific gravity of the metals of the alkalies proves fatal to Davy's hypothesis, for, if the mean density of the earth surpass that of all kinds of rocks, these metals cannot exist, at least not in great quantities, in the interior of the earth.

In reply to this I cannot do better than extract the remarks which I made in reply to the self same objection in my article on volcanos, published in the *Encyclopædia Metropolitana* in the year 1833.

“An objection against our hypothesis has also been sometimes deduced from the mean density of the Earth, which is calculated at five times that of water; and hence it has been concluded, that bodies so light as potassium and sodium are, cannot make a part of its nucleus.

But we are not obliged to imagine a larger proportion of these alkaline bases to be present, than would be implied by the composition of the lava emitted. and probably we shall find not more than four or five per cent. of potassa or soda to exist, in the average of volcanic productions.

On the other hand, the specific gravity of the basis of silica, and probably, also, of that of the other earths which predominate in lava, is sufficiently considerable to warrant the conclusion. that a mass of matter, containing these principles in the proportions indicated, and united with as much metallic iron as we know to exist in the state of an oxide in the generality of lavas, would form an aggregate pos-

sessing a higher specific gravity than that of the compound resulting from the oxidation of the entire mass.

Let us take for instance, the analysis given by Dr. Kennedy, of the lava from Etna, which he states to consist of

Silica,	52 per cent	\times Sp. gr. 2.65	= 127.8
Alumina,	19 per cent	\times Sp. gr. 4.20	= 79.8
Lime,	10 per cent	\times Sp. gr. 3.00	= 30.0
Oxide of Iron,	15 per cent	\times Sp. gr. 5.00	= 75.0
Soda,	4 per cent	\times Sp. gr. 2.00	= 8.0
	<u>100</u>		<u>320.6</u>

We here find that 100 parts of this lava have a specific gravity equal to 320.6, and consequently that the specific gravity of the mass would be no more than 3.2, supposing it divested of water.

Now, let us contrast this with the specific gravity of 100 parts of the metallic principles, which would give rise to a mineral possessing the above chemical composition.

Silica,	52, contains of base, 26	\times Sp. gr. 2.0	= 52.0
Alumina,	19, contains of base, 10	\times Sp. gr. 2.0	= 20.0
Lime,	10, contains of base, 7	\times Sp. gr. 4.0	= 28.0
Oxide of Iron,	15, contains of base, 12	\times Sp. gr. 7.8	= 93.6
Soda,	4, contains of base, 3	\times Sp. gr. 1.0	= 3.0
	<u>100</u>	<u>58</u>	<u>196.6</u>

Now as 58—196—100—340.

Consequently the specific gravity of the whole would be no less than 3.4. The specific gravity of aluminium appears not to be ascertained, but probably it is not inferior to that of silicon, which sinks in the strongest sulphuric acid, and therefore is more than 1.83.

The theory, therefore, we have been advocating, leaves the question, with respect to the cause of the Earth's density, just on the same footing as before. Those who are of opinion, that the latter may be explained by the mere condensation of such rocks as are found near the surface, in consequence of the superincumbent weight, as certain metals may be rendered heavier by pressure, are entitled to extend this explanation to the case of the alkaline and earthy bases; whilst those who regard the density of the Earth to be a proof that some heavier matter must exist below, are not precluded from such a supposition, as our theory implies merely the existence of such a quantity of metallic ingredients, as would be sufficient to produce the materials ejected, leaving the constitution of the remainder just as open to conjecture as it was before.

It is curious indeed, that whilst some have argued that the kind of materials found near the surface is inadequate to account for the density attributed to the Earth in general; others, as the late distinguished Professor Leslie, have contended, that these substances would have their specific gravity so much increased by the enormous pressure from above, that void internal spaces must be necessarily supposed. On this he has founded his singular hypothesis, that the centre of the Earth is filled only with light, the rarest substance known; an idea, the mere mention of which is sufficient to show how little we can be justified in rejecting an explanation of facts, merely because it appears to militate against the conjectures that may be conjured up with regard to the internal condition of our planet."

8th Objection.—If, according to Gay-Lussac, the hydrogen of the decomposed water goes to form muriatic acid with chlorine, the above mentioned acid ought to be general in volcanos. Now, it is wanting, according to Boussingault, in the volcanos under the equator in the New World, and according to Bischof, in those near the Rhine.

Answer.—I believe, that muriatic acid will be found pretty constantly present in volcanos now in activity. Sir H. Davy found it at Vesuvius on both the occasions he visited that volcano, viz. 1815 and 1829. I myself in 1834, detected it there in great abundance; and in 1825, found it at the Solfatara, in the Island of Vulcano, and near Mount Etna. It has been discovered also in the volcanos of Iceland; in those of Java, at Mount Idienne; and of South America, at Puracè. The sal-ammonia which so abounds in the volcanos of Tartary, shows, that it is also present there; and the existence of it in the trachytic rock of the Puy de Sarcouy in Auvergne, proves, that it was a concomitant of volcanic action in days that have gone by.

All therefore that Bischof is warranted in inferring from its absence in the case of the volcanos of the Rhine and Equatorial America, is, that it ceases to be disengaged when the action becomes languid or extinct. Now there are many ways of accounting for this. In the first place, granting the acid to be derived from the sea-salt present in the water which originated the volcanic action, it would cease to be generated when this fluid no longer obtained admission; or, when the heat was inadequate to cause the union of the alkali of the sea-salt with the earths present; and even if it were still generated, it might be prevented from rising to the mouth of the crater, by combining in its way with the calcareous rocks through which it had to pass. Hence the carbonic acid, which Professor Bischof remarks as so abundantly evolved by the volcanos of the Rhine, may perhaps represent an equal volume of muriatic acid, by whose agency it had been evolved from the limestones that contained it.

Thus have I replied *seriatim* to all the objections, which an acute and learned opponent has been able to adduce against the chemical theory of volcanos; and having done so, might be expected perhaps to proceed to some remarks on the one to which he himself has given the preference.

But in order not to occupy too much of your space, I will merely here remark, that Professor Bischof appears (at least in the portion of his memoir yet published) to pass over without any attempt at explanation, certain chemical phenomena of constant occurrence, which follow directly from the principles of the theory to which he has objected.

These are, 1st, The evolution of sulphuretted hydrogen, in quantities far exceeding what are to be explained by the reaction of carbonaceous matter upon sulphates, or any of those other processes which sometimes produce it on the surface of the earth.

2dly, The disengagement of sal-ammoniac, for although one of the constituents of this compound, the muriatic acid, might arise from the decomposition of sea-salt by aqueous vapor, the other one, the ammonia, implies the presence of free hydrogen as well as of nitrogen gas, near the focus of the volcanic action.

3dly, The circumstance, which I have substantiated in so many cases, that I begin to believe it almost universally true, that the atmospheric air exhaled from volcanos, and indeed generally from the interior of the earth, is deprived in a greater or less degree of its proper proportion of oxygen. That processes, therefore, by which this principle is abstracted, are going on extensively within the globe cannot be denied, and hence I conceive that any theory, which attempts to account for volcanic action, without taking notice of so essential a phenomenon, ought to be regarded as imperfect and unsatisfactory.

ART. VI.—*Mountains in New York*; by E. F. JOHNSON, Civil Engineer.

In a report recently made, by the author of this article, of a survey of a route for the proposed Ogdensburgh and Champlain railway, the elevations above tide of the highest of each of the three distinct groups of mountains divided by the valleys of the Saranac and Au Sable rivers, are given as follows:

Lyon Mountain, - - - - -	3,864 feet.
Whiteface do. - - - - -	4,666 "
Mt. Marcy, - - - - -	4,907 "

To this statement of elevations, the following note was appended:

“The altitudes here given, were deduced from the angular elevations observed from a point near Lake Champlain, whose elevation was known, and the distances as determined from the map. I mention this to account in part, perhaps, for the discrepancy between the results above given and those contained in the geological report as derived from barometrical measurement.”

Prof. Emmons, State Geologist for the Northern District of New York, in his last annual report, in reference to the above, has the following :

“In a report to the Legislature this present session, Mr. E. F. Johnson, the Engineer of the Ogdensburgh and Champlain railroad, questions the accuracy of the measurements of Mt. Marcy. In reply to his suggestions, I shall merely remark, that it is quite doubtful whether the mountain in question is distinguishable from those of the same group, especially by one who has never visited the interior of this section, and if visible, his measurement is not entitled to consideration except as a very imperfect approximation.”

The observations made by myself were taken, as stated, from an elevated point near Lake Champlain.

The instrument used was of a superior kind, and, graduated, so as to give, with the aid of the nonius, fractions of degrees as small as $7\frac{1}{2}$ seconds. On the day when the observations were made it was carefully adjusted.

Not only the peaks above mentioned, but the elevations of from 30 to 40 other points were observed, several of which had been previously measured. Among the latter number were the two most elevated peaks of the Green Mountains, Camels Hump and Mansfield ; these were found, the former to be 4,220 and the latter 4,359 feet above tide.

These peaks, as measured barometrically by Capt. A. Partridge, (see Gazetteer of Vermont,) were found, the former to be 4,188 and the latter 4,279 feet above tide ; *less* in both cases than the results by trigonometrical measurement. The barometrical elevations of Mt. Marcy and Whiteface, as given by Mr. Emmons, were on the contrary *greater* than the trigonometrical ; the former by 687 and the latter by 189 feet ; the first being 5,594 and the second 4,855 feet above tide.

It was this great discrepancy, that induced the remark of distrust, as to the entire correctness of Mr. Emmon's barometrical

measurement; a discrepancy which cannot be attributed to any inaccuracy of adjustment in the instrument used by me, since if by any error in this respect, the angle of elevation was too great or too small in one case, it was also too great or too small in the other, producing a corresponding elevation or depression in both. Neither can it be attributed to a difference in the estimated allowance for refraction, for this allowance was the same in both cases; hence if too great or too small, the elevations of both were similarly affected and to the same amount. The observations were also made from the same spot at nearly the same time of the same day; hence there could probably be no great difference in the refractive power of the atmosphere.

Again, so great a difference could not well result from an error in the distances, for although these were obtained as stated from the map, they were tested by comparing with known distances upon the same map, the latter having been projected on a large scale and compiled from actual surveys, with the positions of the several peaks, as is believed very accurately defined, that of Mt. Marcy in particular, coinciding *very nearly* with the location and bearing of it from Whiteface and other points, as described by Mr. Emmons. That some other peak was taken for Mt. Marcy, as is intimated by Mr. Emmons, is therefore scarcely possible, more especially as it is *certain* that the one observed was the *highest* of the group in which Mt. Marcy is situated. Had the peak in question been a *lower* instead of the *highest* one of the group, its not being "distinguishable" could be urged by Mr. Emmons with more propriety.

Assuming therefore, as is proper to do under these circumstances, that the trigonometrical measurement exhibits very nearly the *relative* elevations of the high peaks in Vermont and New York, it follows, that to place Mr. Emmons's barometrical measurements of Whiteface and Mt. Marcy upon a *par*, as it regards accuracy, with the barometrical measurements of Camels Hump and Mansfield, that the former should be reduced, the first about 290 and the second about 800 feet; or in other words, these are the differences in the barometrical measurements by the two observers. Both surely cannot be correct; and it is equally certain also, that both may be incorrect. Until, therefore, Mr. Emmons shall have proved, that his measurements are entitled to a higher degree of confidence, he must submit to have their accuracy ques-

tioned. It is granted that it is possible he may be after all nearest the truth, but so long as the evidence in the case is more against than for such a conclusion, his claim to *superior* accuracy cannot be allowed. Capt. Partridge has had perhaps more experience than any other individual in the United States in measuring mountain elevations with the barometer. In two measurements made by him of Mt. Washington in New Hampshire, the first gave 6,103 feet and the second 6,234 feet. The measurement of the same mountains by Prof. Bigelow, as computed by Prof. Farrar of Cambridge, gave as the height above tide 6,225 feet, a coincidence somewhat remarkable, considering the very great elevation of Mt. Washington.

Mr. Emmons states that the distance from Mt. Marcy to Whiteface is about 16 miles, and that the depression of the latter from the former is 15 minutes of a degree. If the instrument used by Mr. Emmons in taking this angular depression was a suitable one and in a proper state of adjustment, and if he is correct as to the distance, the *difference* in elevation of those two summits would have been obtained therefrom with more accuracy than from the barometrical measurements. No one capable of appreciating all the causes of error in the two modes of measurement would probably deny this. Assuming, therefore, the data above given as correct, of which I cannot but express some doubt, it gives a difference in elevation of the two peaks of 578 feet, nearly, whereas the difference shown by Mr. Emmons's barometrical measurements is 739 feet, or nearly 30 per cent. greater, being nearly as much *greater* as the result by my measurement is *less*, showing that, if the 578 feet is taken as the standard, there is about as near an approximation to the truth in the one case as in the other.

The barometer I consider a very valuable instrument, and have made much use of it, as being a cheap and expeditious mode of arriving at an approximate knowledge of the general features of a country; but that it will afford, by a single observation, in the hands of practiced or unpracticed observers, and under all circumstances, results as much to be depended on for their accuracy as would be inferred from Mr. Emmons's statement, cannot be conceded.

The principal sources of error in the use of this instrument are its great liability, particularly the mountain barometer to get out of repair. The difficulty also of arriving at a correct knowledge of the change of pressure, or condition of the atmospheric column

which sustains the column of mercury, arising from fluctuations, that are independent of temperature, and for which no provision is made in most formulas, and the discrepancy in the results as given by different formulas, all claiming to be equally correct.

Errors from these sources when they occur so as to affect the result *differently*, may neutralize each other, but when they operate the *same way*, may produce a very considerable deviation from the truth. In the observations of Mr. Emmons, the barometer at Whiteface was compared with the barometer at Burlington and Albany, and if I rightly understand him, the mean of the two was taken, the difference being about 100 feet less at the former than at the latter. The time of making the observations was 6, A. M. of the same day, Sept. 21. In the record which he gives of the state of the barometer at the two latter places at noon of the same day, the fact is made known that while the barometric column *fell* at the one place it *rose* at the other, causing a difference equivalent to upwards of 100 feet of elevation. Computing the elevation of the place of observation at Burlington at 6, A. M. above tide from the observation at Albany at the same time, and it gives 500 feet, nearly. Taking the observations made at the same places at 12, M. of the same day, and the result is 390 feet, nearly. Which of these is correct, or whether either is only known from the fact that the elevation in question has been ascertained by the common mode of levelling to be 372 feet, nearly, giving a maximum deviation from the truth in two observations only, of 128 feet, nearly. In the case of the observation on the summit of Whiteface, there exist no data by which the *relative* conditions of the atmospheric column as compared with the same column at Burlington and Albany can be ascertained.

Whiteface is about 35 miles west of Burlington, the nearest of the points mentioned, but far enough, it is believed, for considerable difference to exist. But *one* observation is recorded as having been made on its summit and that not under the most favorable circumstances, since it is stated that the "wind was strong from the northeast and cloudy." In the case of Mt. Marcy, the comparison was made with the barometer at Albany. In consequence of the greater distance of the places of observation, a much greater error might result than in the case of the observations at Whiteface and Burlington. That the greater discrepancy between the barometric and trigonometric elevations of Mt. Marcy

compared with Whiteface is attributable in some degree to this cause, it is most certainly not unreasonable to suppose.

Again, a considerable discrepancy in barometric results may arise from the difference in the different formulas used in making the computations. Mr. Emmons makes the elevation of Mt. Marcy above tide 5,594 feet. Mr. Redfield, by another formula, makes it from the same observations 127 feet less, and by yet another formula which has been found by comparison with the known elevation of objects by levelling to give results quite near the truth, it is somewhat less than the elevation obtained by Mr. Redfield. In the case of the Whiteface Mt. the elevation by this latter formula, computing from Mr. Emmons's observations, is less than that given by him by about 290 feet, or about 100 feet *lower* than the elevation as derived from trigonometrical measurement.

If these causes of error exist, and the tendency of all combined is to affect the altitude in the same way, of which there is no evidence to the contrary, it is not difficult to imagine, that Mr. Emmons's barometric measurement of Mt. Marcy may be farther from the truth than he is willing to admit.

The propriety of this conclusion, independent of all other considerations, is I conceive most fully warranted in the great discrepancy of the *relative barometric* altitudes of the peaks in New York and Vermont already described, as shown by the trigonometrical measurement.

The statement made by me in the report alluded to at the head of this article, was, I believe, clearly warranted by the circumstances of the case, and as such was entitled to a degree of consideration in no respect inferior to that which can be reasonably claimed in behalf of Mr. Emmons's measurement. It was most certainly no wish or intention of mine, in making that statement, to disparage, in the least, the labors of Mr. Emmons; and it was not imagined that he could consider the statement as having that tendency; but since, from the tenor of his remarks, he has thought proper to construe it in that light and to pronounce so unequivocally (to use a very mild term) in respect to the superiority of his barometrical measurements, I am compelled, very reluctantly, I confess, to state the facts in detail which influenced my judgment and which I believe fully justify me in all I have advanced upon the subject.

New York, May, 1839.

ART. VII.—*Account of a Tornado*; by WILLIS GAYLORD.

HAVING visited and examined the scene of the tornado, so well described by Mr. Willis Gaylord of Otisco, Onondaga Co., N. Y., in the *Genesee Farmer*, Nov. 10, 1838, we also can bear witness to the tremendous devastation which that whirlwind produced.

We were on the ground in September, about two months after the event. Before the tornado, a region of 4 or 500 acres had been covered by a dense forest of pine trees, many of them very tall and large; roads had been cut through this forest and a few solitary houses were planted in it, here and there. Now we looked in vain over the whole tract for a single perfect tree. Those which had not been uprooted or broken in two near the ground, were shivered and twisted off at different elevations, leaving only a portion of a shattered trunk, so that not a single tree top, and hardly a single branch were found standing in the air: there were instead only mutilated stems, presenting a striking scene of desolation wherever our eyes ranged over the now almost empty aerial space. On the ground the appearances were still more remarkable. The trees were interwoven in every possible way so as to form a truly military abattis of the most impassable kind, nor immediately after the gale, could any progress be in fact made through the gigantic thickets of entangled trunks and branches, without the labor of bands of pioneers, who cut off the innumerable logs that choked every avenue. We had before seen many avenues made through forests by winds, prostrating the trees and laying them down in the direction of its course: but never had we seen such a perfect desolation by a gyratory movement, before which the thick and lofty forest and the strongest framed buildings vanished, in an instant, and their ruins were whirled irresistibly around like flying leaves or gossamer.

Still it was truly wonderful that people were buried in the ruins of their houses, and travellers with their horses and cattle, were exposed to this driving storm of trees which literally filled the air, and still not a single life was lost, although some persons were wounded.

We were assured that this wind had marked a track of devastation for twenty miles or more, but this was the scene of its greatest ravages. Two or three miles from this place, we saw a

wing of a house which had been moved quite around so as to form a right angle with its former position, and still the building was not broken.—*Eds.*

“On the afternoon of the 25th of July, 1838, (says Mr. Gaylord,) a violent tornado passed over part of the county of Allegany, N. Y., rarely equalled in its destructive effects, and giving a most striking illustration of the peculiar movements of the wind in these aerial currents. It was noticed in some of the journals at the time; but happening to cross its route, in passing up the Genesee valley in the succeeding month, we were so much interested with the appearance as to be induced to prepare the following sketch for the readers of the Farmer.

“The first appearance of severe wind, was, as we learned, in the town of Rushford, some fifteen miles from the place where we observed its effects. The day was hot and sultry, and the course of the gale was from the N. of W. to S. of East. At its commencement in Rushford, it was only a violent thunder gust, such as are frequently experienced, but it soon acquired such force as to sweep in places every thing before it. In its passage the same violence was not at all times exerted; some places seemed wholly passed over, while in the same direction and at only a small distance whole forests were crushed. In the language of one who had suffered much from the gale, ‘it seemed to move by bounds, sometimes striking and sometimes receding from the earth,’ which indeed was most likely the case.

“It passed the Genesee river in the town of Belfast, a few miles below Angelica, and its fury was here exerted on a space of country perhaps a mile or a mile and a half in width. The country here is settled and cleared along the river, but the road passes at a little distance from the river, and at this point wound through one of the finest pine woods to be found on the stream. Of course when it came over the higher lands from the N. W., the tornado crossed the river and the plain before encountering the groves of pine. In the space occupied by the central part of the tornado, say three-fourths of a mile in width, nothing was able to resist its fury. Strong framed houses and barns were crushed in an instant, and their fragments and contents as quickly scattered to every point of the compass; while those out of the direct line were only unroofed, or more or less damaged. Large oaks and elms, were literally twisted off, or crushed like reeds.

“The road from the north approached the pine woods on what was the northern verge of the tornado, and the first appearance of the country in front was that of woodlands in which all the trees had been broken off at the height of 20 or 30 feet, leaving nothing but countless mutilated trunks. On entering the narrow passway, however, which with immense labor had been opened through the fallen trunks, it was perceived that much the largest part of the trees had been torn up by the roots, and lay piled across each other in the greatest apparent confusion imaginable. Fortunately for our view of the whole ground, a few days before our arrival, fire had been put in the ‘windfall,’ and aided by the extreme dry weather, the whole was burned over so clean, that nothing but the blackened trunks of the trees were remaining, thus disclosing their condition and position, most perfectly. This position was such as to demonstrate beyond the possibility of a doubt, the fact that the tornado had a rotary motion against the sun, and in perfect accordance with the course which we in a former volume of the Farmer have ascribed to such electric aerial currents, a theory first developed by Mr. Redfield of New York.

“The first tree met with, prostrated by the tornado, was a large pine, which lay with its top exactly to the N. of W. or precisely against the general course of the storm. Hundreds of others lay near in the same direction on the outer part of the whirl, but immediately after entering the fallen timber the heads of the trees began to incline to the centre of the space torn down, and south of this the inclination was directly the reverse until the outside of the whirl was reached, when they all lay with their tops to the east. This almost regular position of the fallen timber, was most distinct in the bottom courses, or that which was first blown down, those that resisted the longest, being, as was to be expected, pitched in the most diverse directions. That there was also an upward spiral motion, causing a determination of the rushing air to the centre of the whirl would appear probable from the fact that articles from the buildings destroyed were carried high in the air, and then apparently thrown out of the whirl, into the common current; and also from the fact that a large majority of the trees both to the south and the north of the centre of the gale, lay with their heads inclined to that point, while the centre was marked by the greatest confusion imaginable. A diagram formed of a continued succession of circles moving from the right to the

left would illustrate the position of the trees first uprooted, as these lay as when first crushed by the approach of the whirlwind.

“Many curious facts illustrative of the force of the wind was related by the inhabitants in and near the place. A farmer attempted to drive his team of horses to the barn, but the tempest was too soon upon him. When the rush was over, and it was but seemingly a moment, he found the barn torn to pieces; himself about thirty rods in one direction from it, and his horses as many rods the other, and what was most remarkable with scarcely a fragment of the harness upon them. A wagon was blown away, and a month afterwards one of the wheels had not been found. A house standing near the Genesee river, and a little out of the line of the gale, was completely covered with mud that must have been taken from the bed of the river. And appearances render it very evident that near the centre of the whirl the water was entirely taken from the channel.”

ART. VIII.—*On Meteoric Stones*.*—From the Annual Account of the progress of Physics and Chemistry, by BERZELIUS, in the Annual Reports of the progress of the sciences by the members of the Royal Academy of Science in Sweden.

Arsberättelser om Vetenskapernas Framsteg. D. 31. Mars, 1835. Stockholm.
Translated for this Journal, by REV. W. A. LARNED.

METEORIC stones, as inorganic masses occurring on the surface of the earth, present also an object for mineralogy, the more interesting since they give us information of the mineral products

* Berzelius published a paper on Meteoric Stones in the Transactions of the Royal Academy of Science, for 1834, pp. 115—183. This was translated in several Scientific Journals in Europe. An abstract appeared in the London and Edinburgh Phil. Mag. vol. ix, pp. 429—441, from which an account of the fall of the meteoric stone at Blansko, and of its analysis, was published in this Journal, vol. xxx, pp. 175—176. Berzelius himself, made an abstract of his paper in the Reports of the progress of the sciences for 1835, pp. 230—238, which is here translated entire. As a recent analysis of meteoric iron from Clairborne, Ala., by Dr. C. T. Jackson, published in this Journal, vol. xxxiv, pp. 332—337, made known the existence of chlorine, and a still more recent one of meteoric iron from Ashville, N. C., by Prof. C. U. Shepard, detected not only chlorine, but also uncombined silicon, neither of which are mentioned by Berzelius, it was thought a translation of the present paper would be interesting.—*Tr.*

of other planetary bodies, and of their likeness or unlikeness to those of the earth. I have communicated in a paper addressed to the Royal Academy of Science,* examinations of various meteoric stones, undertaken with the design of studying them as mineral species, and of thereby enabling myself to determine of what different minerals they are composed. The occasion of the investigation was afforded by the friendly commission which Reichenbach of Blansko gave me to examine the composition of a meteoric stone, whose glancing apparition within the atmosphere of the earth, on the 25th of November, 1833, about 6 o'clock in the evening, he himself had witnessed, and of which, with very great expense and labor, he finally succeeded in collecting the scattered fragments in the region about Blansko. The meteoric stones which I examined, have fallen near Blansko in Moravia, Chantonnay in France, Lautolax in Finland, Alais in France, and Ellenbogen in Bohemia, and I have also analyzed the meteoric iron made known by Pallas from the region between Abekansk and Krasnojarsk in Siberia. From the analyses referred to, I believe I have discovered that the meteoric stones are minerals; as it is absurd to suppose that minerals can be formed in the air out of the elements of the air, they cannot be atmospheric products, and the less so, as many of them present cavities, which are filled with a mineral of another color and probably of a different composition, which it were a plain absurdity to consider as being possibly formed in them during the few moments the attraction of the earth would suffer so heavy a body to remain in the atmosphere. They become such elsewhere. They are not cast out from the volcanos of the earth, for they fall everywhere, not merely nor oftenest in the near or remote neighborhood of a volcano; their external appearance is unlike a terrestrial mineral, unlike any thing which the volcanos eject. Their containing unoxidized malleable iron, proves that water is not found, and perhaps, not air, in their former abode. They must, therefore, come from some other planet, which has volcanos. The one nearest us is the moon, and the moon has gigantic volcanos compared with the earth. The moon has no atmosphere to retard the volcanic projectiles. Collections of water do not appear to exist on it, in a word, among the probable sources, the moon is

* Kongl. Vetensk. Acad. Handl. 1834, p. 115.

the most probable. To get an idea of the elements of another planetary body, were it only the one lying nearest us, the moon, gives to such an examination an interest which in itself it would be destitute of.

The general results of my investigations have been, that meteoric stones of two sorts have fallen on the earth. Those which belong to the same kind, have a like composition and appear to come from the same mountain. The one sort is rare. Hitherto there have not been observed more than three meteoric stones belonging to it, which fell in Stannern in Moravia, in Jonzac and Juvenas, in France. They are thus characterized; they do not contain metallic iron, the minerals of which they are composed are more distinctly crystalline, and magnesia is not a prevailing element of them. Of these I have not had any specimen to examine. The other sort is made up of the great number of meteoric stones, which have been hitherto examined. They are frequently so like one another in color and external appearance, that we might believe them to have been struck out of one piece. They contain malleable metallic iron in variable quantity. We have an example of an enormous block, which was constituted of a mere continuous web of iron, the cavities of which the mineral fill up, and which came down whole in the fall, solely because the iron-web held them together. Some are composed more of the mineral and less of iron, in which case they do not cohere, but burst apart from the heat, which the extreme compression of the atmosphere by means of their irresistible velocity, moving with the rapidity of a heavenly body towards the earth, has produced in the few moments they are passing through the air, and from which their outermost covering is continually melted to a black slag thinner than the thinnest post-paper. We may say then, that the meteoric stones supposed to proceed from the moon, come entirely from two unlike volcanos, the eruptions of one of which either take place oftener than the other, or are projected in such a direction as that they oftener reach the earth. Such a circumstance agrees well with the fact, that a certain part of the moon has the earth continually in the zenith and directs all its projectiles straight towards the earth, though they do not proceed straight thither, because they must also suffer the motion, which they had before as parts of the moon. If that is the part of the moon which sends to us the meteoric iron

masses, and if the other parts of the moon are not so full of iron, then we see a reason why that point turns continually towards the magnetic globe of the earth.

The mineral portion of meteoric stones consists of various minerals. 1. Olivine. It contains magnesia and protoxyd of iron, is colorless or grayish, but is sometimes streaked with yellow or green like all the terrestrial olivine. This shows that oxygen is wanting for a higher oxidation of the iron. Like the terrestrial, it is soluble in acids, and leaves the silicious earth in the form of gelatine. It contains like some of the terrestrial, a trace of oxyd of tin and oxyd of nickel. Olivine, however, in the meteoric iron found by Pallas, makes an exception to this, for it is without nickel, and its color is yellow approaching to green; but it contains tin. Olivine comprises about one half the quantity of the unmagnetic minerals. Olivine separates by treating with acids, and the silicious earth is then set free by boiling in carbonate of soda.

Then there remain, 2. *silicates of magnesia, lime, protoxyd of iron, protoxyd of manganese, alumina, potash, and soda*, which are not separated by acids and in which the silicious earth contains two species of bisilicates. These are probably blended with more, which I was not able to separate. We may conjecture

a species of pyroxene $\left. \begin{array}{l} Mg \\ f \\ C \end{array} \right\} S^2$ and a species of leucite where

lime and magnesia in the first terms replace a portion of potash

and soda. $\left. \begin{array}{l} Mg \\ C \\ N \\ K \end{array} \right\} S^2 + 3AS^2$. The pyroxene not having so much

color as the terrestrial, is to be attributed to the same cause as the want of color in meteoric olivine.

3. *Chrome-iron*.—This is contained in both kinds of meteoric stones, in both in like small quantity, is never wanting, and is the source of the chrome in meteoric iron. It can be obtained undecomposed if the unmagnetic portion of the meteoric stone is separated with hydro-fluoric acid, and is then, after all the silicious earth is removed, treated with sulphuric acid, after which the sulphates and the gypsum are boiled out, when the chrome iron remains in the form of a black burnt powder. This is the cause of the greyish color in meteoric stones when they are seen in the mass.

4. *Oxyd of tin.*—This is mixed with the chrome-iron. One can satisfy himself of its presence when the last named metal is separated by bi-sulphate of potassa, and the solution in water is treated with sulphuretted hydrogen, when the sulphuret of tin is thrown down. It has a trace of copper.

5. *Magnetic Iron-ore.*—This does not perhaps occur in all. It is taken out with the magnet, when it again manifests its property of dissolving in hydro-chloric-acid with a yellow color and without a disengagement of hydrogen.

6. *Sulphuret of Iron.*—This is found in all. It has been impossible for me to separate any for a distinct examination. All the circumstances seem to show that it consists of one atom of each of the elements. A surplus of sulphur in a mass, where a surplus of iron prevails throughout, is not supposable. One part of it follows the magnet together with the iron, the other part remains in the powder of the stone, as nothing more is given up to the magnet. This is sometimes a larger percentage. Whether this is by a chemical union, as is the case, for example, with the sulphuret of manganese in helvin, or is merely by adhesion to the powder of the stone, my researches could not decide; the latter is the more probable when FeS is weakly magnetic, but the former is not impossible. The sulphuret of iron causes the pulverized meteoric stone to develop sulphuretted hydrogen gas when it is mixed with hydro-chloric-acid.

7. *Native Iron.*—This iron is not pure, although it is altogether malleable. It contains carbon, sulphur, phosphorus, magnesia, manganese, nickel, cobalt, tin and copper. But it is moreover blended with small crystals within the mass, of a union of phosphuret of iron with phosphuret of nickel, and phosphuret of manganese. These are insoluble in hydro-chloric-acid and fall down while in the solution. Their quantity varies. The iron of Ellenbogen gives $2\frac{1}{2}$ per cent., but the Pallasian iron not $\frac{1}{2}$ per cent. of it. A part is so finely divided in the mass of the iron, that what falls down in the solution resembles a black powder. The cause of the Widmanstätten* figures is, that the foreign metals are

* This refers to figures of a crystalline shape on the surface of some meteoric iron, as of Agram, Siberia, Mexico, &c. first noticed by Widmanstätten. See *Beiträge zur Geschichte und Kenntniss meteorischen Stein-und Metall-Massen* von D. Carl von Schreibers. p. 70.—*Tr.*

not equally blended, but separate into imperfectly formed crystalline series. If the iron is dissolved in an acid solution of sulphate of iron, the pure iron is set free almost by itself and its laminae fall down in flakes.

The elementary bodies hitherto found in the meteoric stones make up just a third of those we are acquainted with, namely, oxygen, hydrogen, sulphur, phosphorus, carbon, silicon, chrome, potassium, sodium, calcium, magnesium, aluminium, iron, manganese, nickel, cobalt, tin and copper.

The following analyses of the meteoric iron may be cited; some conducted at the same time by Wherle are added.

	Iron of Pallas.	Iron of Ellenbogen. Berzelius.	Wherle.*
Iron, - - - -	88.042	88.231	89.90
Nickel, - - -	10.732	8.517	8.44
Cobalt, - - -	0.455	0.762	0.61
Magnesium, -	0.050	0.279	—
Manganese, - -	0.132		98.95
Tin and copper,	0.066		
Carbon, - - -	0.043	a trace.	
Sulphur, - - -	a trace.		
Metallic phosphurets	0.480	2.211	

The metallic phosphurets were found to contain :

	Of the Pallas Iron.	Of the Ellenbogen.
Iron, - - - -	48.67	68.11
Nickel, - - -	18.33	17.72
Magnesium, - -	9.66	
Phosphorus, - -	18.47	14.17
	—	—
	95.13	100.00

This last result cannot possess entire precision, for the whole quantity of the metal, which I was able to take for analysis, was of the former only 3, and of the latter 2.8 centigrammes. Wherle's analysis will be seen to agree more exactly with mine, when I add that he had in the iron the alloy of phosphorus and manganese, and also of magnesia, which fell as the ammonio-phosphate of magnesia with the oxide of iron.

Wherle has cited (in the forementioned Journal) still other analyses of meteoric iron which I here communicate.

* Baumgartners Zeitschrift III, 222.

	Agram.	Kap.	Lenarto.
Iron,	89.784	85.608	90.883
Nickel,	8.886	12.275	8.450
Cobalt,	0.667	0.887	0.665 trace of copper.
	<hr/>	<hr/>	<hr/>
	99.337	98.770	99.998

Wherle has sought the constant proportions in the metals ; this inquiry I regard as fruitless.

But before I conclude this subject, perhaps already sufficiently long for my report, I must subjoin one result more of my examination. The meteoric stone from Allais falls to pieces in water, to an earth, which smells of clay and hay and contains carbon in an unknown union. This shows that in the region of the meteoric stones, minerals fall to pieces to a clay-like mixture as on the earth. Now arose the inquiry, whether this carboniferous earth from the surface of another planetary body contains the organized products, whether indeed organized bodies are thus discovered there, more or less analogous with those of the earth. It is easy to conceive with what interest the answer would be sought. It was not in the affirmative, but to decide in the negative would be to conclude more about it than we are authorized to do. The earth was found to be olivine, containing ferro-sulphate of nickel and of tin. The magnet took up the compound oxide of iron in black grains, along with which the microscope detected flitters of metallic iron. Water brought out sulphate of magnesia with small quantities of sulphate of nickel ; but nothing organized, as none of the alkalies could be extracted. In a dry distillation were developed carbonic acid gas and water, together with a black gray sublimate, but no burnt oil, no carburetted hydrogen ; in a word, the carboniferous substance was not of the same nature as the soil on this earth. There were besides a carbonate and black soot. The sublimate heated in oxygen gave no trace of carbonic acid or of water, and changed to a white, uncrystallized, volatile body, soluble in water, which did not become acid in the process and was not precipitated by nitrate of silver. What this body is I did not know ; it remains unknown to me. Is it indeed an elementary body not originally pertaining to our planet ? To answer this question in the affirmative would be too hasty.

ART. IX.—*Terrestrial Magnetism*; by J. HAMILTON of Carlisle, Penn.

IN the 22d volume of this Journal I suggested the idea, that the magnetic poles coincided with the coldest points in the northern hemisphere, but did not assign the grounds for such a conclusion.

In 1837, Dr. Brewster published his *Treatise on Magnetism* at Edinburgh, originally prepared for the *Encyclopedia Britannica*, which contains very full details of the latest researches on that subject.

In the 42d page of this *Treatise* it is stated, “the discovery of two poles of maximum cold on opposite sides of the north pole of the earth, which was announced by Sir David Brewster in 1820, led him and other authors to the opinion, that there might be some connection between the magnetic poles, and those of maximum cold.” The opinion advanced by Dr. Brewster, “that there are two poles of greatest cold in the northern hemisphere,” it appears, was published in the 9th volume of the *Edinburgh Transactions* of 1821, and Dr. Dalton in remarking on it, considers it as a probable supposition, and Mr. Kupffer in a memoir read in 1829 to the Russian Academy, explicitly adopts the opinion.

Of all this I knew nothing when I wrote the letter above referred to in 1832, nor until I met with Dr. Brewster’s *Treatise* published in 1837; but drew the inferences therein stated, from the views I entertained of the nature of light and heat,* and from observing a certain correspondence of climate at similar distances from the magnetic poles.

I regard light and heat *in the common acceptation* of these words, as not only material in their nature, but as *compounds* of other simple elements, and suppose the magnetic fluids to be two of those simple substances which enter into their constitution.

From the refined nature of light and heat, we cannot subject them to experiment like other forms of matter, and the difficulty would necessarily be increased, if we have to do with the simple elements of which they are here supposed to be compounded.

That matter exists in such states of refined minuteness of atoms, as to be imperceptible to such senses as we possess, is

* By the word “heat” I always mean *sensible heat*, and not the unknown principle.

proved by the miasmata, which sometimes impregnate the atmosphere, and yet baffle the skill of the chemist to detect them, although the disease which follows in their train establishes their existence.

If we examine what are termed the magnetic fluids on the poles of the loadstone, it appears that we can neither see, feel, nor taste them, they are not easily disengaged from the particles of the iron, and the only proof of their existence is the attraction they exert. May not this difficulty in perceiving them, arise from their atoms being so exceedingly small, as to be appreciable only to a higher order of senses than we are endowed with. Light and heat will pass through transparent bodies without much difficulty, but Mr. Haldat has shown that the magnetic fluids will not only pass through transparent substances, but through all bodies, even the most dense;—and from this I argue, that they are of greater tenuity than either light, heat, or electricity.

The sun is continually emitting rays which reach the earth in immense quantities, and the question has been significantly asked, but not so easily answered, if they are material bodies, what becomes of this flood of light and heat? They do not accumulate on the earth's surface like snow, but disappear as fast as they arrive. It may be said they become latent. This supposes that light and heat, as usually understood, are perceptions of the mind, and that the exciting causes of these sensations are unknown principles or substances, as evanescent and difficult to apprehend as the magnetic fluids themselves. Now, may it not be, that these substances hitherto incognita, are the identical elements or fluids, whose attraction causes the phenomena of magnetism, and that instead of light and heat being mere sensations, excited by we know not what, they are real material bodies, compounded of these and other elements.

I here suppose, that there are three elements; one of which is common to light and also to heat; that light and heat are each composed of two simple elements; and that when the sun's rays reach the earth, they are decomposed by the attraction of the bodies on its surface, with which their elements unite, and from which they can be again extricated by different processes.

We know that light and heat can be obtained from almost every form of matter, and the idea here offered to explain their disappearance and reappearance, by a decomposition into simpler

elements, and a recombination of those elements through a play of attraction, is not an unphilosophical suggestion.

Colomb has ascertained that "gold, silver, glass, wood, and all substances, whether organic or inorganic, obey the power of the magnet;" so that all substances are susceptible of magnetism. Here then is a striking coincidence between light and heat, and the magnetic fluids; they pervade or influence all terrestrial bodies, and friction will develop light and heat as well as magnetism.

That the violet ray imparts the magnetic virtue to iron, is shown by the experiments of Mrs. Somerville, and by the still more striking experiments of Prof. Zantedeschi, who exposed a horse-shoe artificial loadstone, carrying $13\frac{1}{2}$ ounces, to a strong light of the sun, and after three days it carried an additional weight of three ounces, and ultimately its power was so increased as to carry 31 ounces. These experiments being repeated under an exhausted receiver did not succeed, hence a doubt has arisen as to the source whence the magnetic virtue was derived, but it must be conceded that the sun's rays had some agency in evolving the magnetism, let it come from what source it may, and this is readily explained if we suppose one or more of the magnetic fluids as entering into their composition.

That a compound body should differ not only in its appearance, but in its most striking qualities, from either of the ingredients entering into its composition, is accordant with every day's observation of the chemist; it ought not therefore to be considered so extraordinary, that invisible fluids, such as we find on the poles of the magnet, should, when combined, produce radiant matter, such as either light or heat. In fact, what is the magnetic spark, unless it be the result of the union of the two fluids. But electricity and galvanism also evolve light and heat; and may not there also be different combinations of the three elements, which would account for the evident connexion existing between galvanism, electricity, and magnetism, and also their relation to light and heat.

It is said, however, that light and heat are evolved from the atmosphere by condensation, and this indeed cannot be controverted; nor does it conflict with this hypothesis, for by condensing the air, these elements which are diffused throughout the atmosphere, are brought in contact, a union is effected, and light and heat are the result. The same effect would be produced by

the rapid passage of one of the elements through the air, but with increased energy, for the element itself would enter into the combination. Still I contend that light and heat, or one of them, is the result of the combining of the fluids of either magnetism, electricity, or galvanism, *without the aid of any other body*. This is shown by passing electricity through the exhausted receiver of an air pump, when we have beautiful displays of light, and the effect is the more striking, the more perfect the vacuum.

If there are three simple elements such as I have here supposed, two of which are the fluids on the poles of the loadstone; then let these three be so unequally diffused over and in the earth, as severally to predominate, one at or near the north pole, another at the magnetic equator, and the third at the south pole; each attracting the others, but repelling itself; and we have an elucidation of terrestrial magnetism.

If one of the elements entering into the constitution of light, but not necessary to heat, abounded in the arctic regions, so as to predominate in all terrestrial forms to the exclusion of the elements constituting heat, and this element is identical with one of the fluids on the poles of the loadstone, then it must follow, that the poles of greatest cold would coincide with the magnetic poles, and the isothermal lines have some accordance to the magnetic intensities of different latitude.

The frequent occurrence of the aurora borealis in the northern regions would be explained on this hypothesis, from one of the constituents of light predominating in the arctic circle; and the reason of its affecting the needle be at once shown: so I think a solution may be afforded, for the curious facts, that heat while it imparts the magnetic virtue to soft iron, diminishes with its increase the power of the loadstone, while a white heat entirely destroys it, and a red heat reverses the poles.

I admit that these views are merely hypothetical, but they are part of a more extended theory, which runs its ramifications through all the phenomena of nature, according with so many facts, that I cannot regard it as merely visionary; but I admit that much deliberation and caution are requisite in advancing such positions, lest we should disturb science with unfounded speculations.

ART. X.—*Explosion of Hydrogen and Oxygen, with remarks on Hemming's Safety Tube*; by Prof. J. W. WEBSTER of Harvard University.

THE occurrence of several explosions of the compound blow-pipe of Dr. Hare, in the hands of experienced chemists, is well known; and the student can take up none of the modern chemical books without being made aware of the danger of using an imperfect or ill contrived form of the apparatus. In the use of two separate reservoirs for the gases, and the double concentric jet, it is impossible that explosion can occur. But it has, as those accustomed to use this splendid instrument* are well aware, been modified in various ways, with the desire to render it more portable, safe or convenient. The repetition of the early experiments of Dr. Hare and Prof. Silliman, by the late Dr. Clarke, of Cambridge, (Eng.) and his disregard of the claims of these gentlemen, are also well known; but it is somewhat singular, that so many of the British chemical writers should still incline to give the credit of these brilliant results to him who but repeated what had been long before accomplished in this country. As every chemist must deem the compound blow-pipe, in some form, an essential portion of his apparatus, and as it has even become one of the constituent parts of the cheap, and too often imperfect, "sets of apparatus," manufactured in all parts of the country, for the use of schools of all grades, not unfrequently to be used by beginners or inexperienced persons, it is highly important that every one should be aware of the danger of operating with the *single* vessel as a reservoir of the mixed gases. The convenience of transportation, and the small space it occupies, are great temptations to make use of the single vessel and compressed gases, as in the form first employed in England in the blow-pipe of Mr. Brooke. The tremendous explosions which took place with this instrument in the hands of Dr. Clarke, and of several others, the defences erected by the operators for personal protection, and the modifications in the jets, *ad infinitum*, with which the philosophical journals teemed, are too well known to be described. But

* For this invention our distinguished countryman, Dr. Hare, has recently been most deservedly honored by the American Academy of Arts and Sciences with the Rumford medals.

the encomiums bestowed upon the contrivances of Gurney, the oil cylinder of Prof. Cumming, the layers of wire gauze as suggested by Wollaston, &c., have now given place to the safety tube of Mr. Hemming, which is in fact a modification of the faggot of capillary tubes proposed by Wollaston.

This tube was first publicly exhibited by Mr. Hemming at the meeting of the British Association for the advancement of Science, in 1832, and is fully described in the published report. The description is quoted by the late Dr. Turner in his *Elements*, with the remark that all previous modifications of the apparatus "are rendered unnecessary by the Safety Tube lately proposed by Mr. Hemming." An authority like this, and one which has become the guide of so many, will undoubtedly lead to the employment of this tube, as well as to its construction, by inexperienced persons; and without previous care to test its safety in the severest manner, its use may be attended with the destruction, not only of apparatus, but of life.

I have been induced to make these remarks in consequence of a terrific explosion which occurred in my laboratory a few days since; and to show how much care was taken to test the safety of the instrument before it was exhibited to my class, the following notes of some of the test experiments are taken from my record.

The tube was constructed of sheet brass, 6 inches in length and $\frac{3}{4}$ ths of an inch in diameter, the size recommended by Hemming. This was closely packed with iron wire (No. 22), each wire extending through the entire length of the tube. The close approximation of the wires was increased by the introduction of a pointed rod of the same metal and same length; this was driven forcibly through the centre of the bundle of wires. Thus the spaces between the wires were exceedingly minute, and it was with difficulty that air could be forced through by blowing with the mouth. It is hardly necessary to remark, that a large cooling surface was thus produced, and that flame applied at one extremity would be far more effectually cooled down by it, than by the wire gauze when held over a gas flame, or when surrounding ignited gaseous matter, as in the safety lamp.

The tube was terminated at each end by a female screw to receive stop cocks. In my first experiments, the Hemming's tube was prolonged at each end by a leaden tube about four feet

in length, to increase the cooling surface; and bladders, containing hydrogen and oxygen gases in the proportions that compose water, were attached to the two extremities. The stop cocks being opened, the gases were forced from one bladder into the other several times through the leaden tubes and that of Hemming's interposed, thus ensuring their mixture both in the bladders and tubes. The apparatus was now placed in the open air, and an arrangement made which allowed me to explode one of the bladders and observe the effect without danger. The one bladder alone exploded. This experiment was repeated many times, shortening the leaden tubes each time, until they were entirely removed, and bladders were attached directly to the Hemming's tube. One of them was then exploded, but the flame was arrested as completely as in the previous trials.

Having repeated the experiment with the Safety Tube alone several times, and uniformly finding it impossible to explode both bladders, I now did not hesitate to hold the tube in my hand, and to apply a flame to one bladder; this was repeated several times, and in no instance was explosion communicated from the one bladder to the other. Mr. Hemming is stated to have operated before the members of the British Association with the bladder under his arm; and Dr. Hare in his letter to Dr. Dalton,* states that he has employed the mixed gases with safety, more than an hundred times, allowing them to explode as far into the tube of efflux as where the contrivance in question† was interposed, without explosion extending beyond it.

The safety of the tube having been so thoroughly tested with the bladders, I now substituted for one of them a strong globe 12 inches in diameter, made of 22 oz. copper; this, as well as the bladder was filled with the mixed gases. The apparatus was placed out of doors, and, with the necessary precautions as to personal safety, the mixture in the bladder was fired, but that in the copper globe did not explode. The same result always occurred in repeating this, and in no trial could I cause the flame to traverse the Hemming's tube.

My next experiments were made without the bladder. A small jet, having an orifice of about $\frac{1}{20}$ of an inch diameter,

* Amer. Jour. Vol. xxxiii, p, 196.

† Dr. Hare alludes to some improvement he has made in Hemming's tube, but has not informed us in what it consists.

was screwed into the tube, the mixed gases were condensed in the globe by a syringe, until on opening the stop cock they issued out with considerable velocity. The globe thus charged was again placed in the open air, with arrangements for igniting the gases as they issued from the jet and for protection, should explosion occur. They were ignited without explosion, and continued to burn quietly. The experiments were repeated with different proportions of the gases and under different pressures, always without explosion.

The safety of the tube had thus been severely tested, and there was apparently no cause to apprehend accident, so that I saw no objection to exhibit it to my class in connection with the usual illustrations of the properties of hydrogen gas and the compound blow-pipe. Accordingly, two bladders, filled as before, were attached to the two ends of the tube, the stop cocks opened, and one bladder being fired, the other did not explode. This latter, by applying a flame to an orifice and exploding it, was afterwards proved to have retained the mixture.

A few days after this, I exhibited the gases burning at the jet on the copper globe, to several gentlemen who happened to visit the laboratory; and subsequently employed the same apparatus, filled with the mixed gases, before the audience usually attending the lectures at the Cambridge Lyceum. It was used as a compound blow-pipe, and particularly for obtaining the intense light from lime in the focus of a reflector, as proposed by Lieut. Drummond. No accident or inconvenience occurred. On the following day, as the gases had not been entirely consumed, it was used on my lecture table before the class.

It may be thought that unnecessary precaution was taken to ascertain the safety of an apparatus that had come to us with the sanctions I have already alluded to; but we cannot be too careful in experiments of danger, especially with new apparatus, and when made in this country from description only, and by artists not always aware of its applications, or not prepared to put it to the test to which such instruments are usually subjected by the best English makers.*

* An instance occurred under my own observation a few years since, where a person was compressing air into a copper globe, made in this vicinity, when it burst, wounding the operator very severely in the hand and face.

Having occasion to exhibit the compound blow-pipe in my lecture on the 16th of May, in addition to my usual method with two separate gas holders, and the double, concentric jet, the copper globe was charged with the mixed gases, but with a smaller proportion of hydrogen, viz. $1\frac{1}{2}$ vols. to 1 vol. of oxygen, for the purpose of making some comparative experiments. After using the gases in the separate vessels, I proceeded to operate with the new instrument; the jet was ignited and a few experiments made with confidence and safety. Having closed the stop cock, I removed (as I had often done before) a very short piece from the end of the jet for the purpose of obtaining a somewhat larger flame, to be directed upon a lump of magnesia. The orifice exposed was now $\frac{1}{16}$ th of an inch in diameter and about 6 inches from the end of the Hemming's tube, being at the extremity of a small brass tube bent upwards at an angle of 45° , the same which had been used in all the previous experiments. The globe was nearly in contact with my person, the jet and Hemming's tube projecting horizontally in front of me from right to left. With the right hand the stop cock was opened, and the emission of the gases adjusted; with the left the jet was ignited. The slight crackling noise, which all must be familiar with who have operated with the compound blow-pipe, occurred several times, and the gases were extinguished, but no communication of flame or explosion of the gases in the globe took place.

On again applying a lighted paper to the jet, however, the copper globe exploded with tremendous noise and force, shattering several glass vessels standing upon the table and shelves in the rear, and projecting the torn copper, stop cocks, and tubes, in different directions. My fingers, resting upon the stop cock, were bruised; and the right shoulder severely, by a large fragment of the copper, which in its course robbed me of no small part of the coat sleeve, and the cuff was entirely carried away. The force of the explosion was exerted principally in the direction of the tube and jet in front of me, or I should not probably have escaped with so little injury. The noise and concussion were deafening, and my hearing was not perfectly restored for several hours. No one, fortunately, of the class was injured; the usual good order and attention were but momentarily interrupted; the lecture was proceeded with, and the remaining experiments performed.

On examination afterwards, it appeared that a large fragment of the globe had been projected behind me, striking a shelf in which it caused a large indentation, and a fissure of more than two inches in length, and of nearly one in depth. One large piece of copper was projected over the heads of some persons present out of an open window several yards distant from the table. The windows being open, but one pane of glass was broken; but the sound was heard in all the college buildings, and at a very considerable distance beyond.

The question now arises, how could this explosion have occurred with an apparatus which had been subjected to such apparently thorough and severe tests? I have carefully examined the tube and every fragment of the apparatus, and recalled all the circumstances and arrangements, without being able to discover any imperfection or assignable cause. I have made experiments with the tube and bladders since the accident, and with the same results as before the explosion: the tube is as perfect as ever, and as incapable of transmitting explosion.

That the stop cocks and every part of the globe were perfectly tight, and allowed of no leakage by which a stream of the gases might have come in contact with the flame at the jet, I cannot but feel confident, as nothing of the kind was observable during the condensation or in the previous trials. The apparatus was new and very faithfully made.

It was found by Mr. Hemming, that when the gases contained a portion of water mechanically suspended in them, the flame would return through the tube proposed by Mr. Gurney, where layers of wire gauze, &c. are employed, and even in its improved form, where layers of asbestos are interposed. But with the tube filled with wires, exhibited before the British Association, it is stated to have been *impossible* to produce explosion, even when the gases were made to recede by withdrawing the pressure on the bladder. In the present case no recession could have taken place from diminution of pressure, as the compressed gases were rushing out with great velocity.

How far the compression of the gases may have aided the combination of their bases, we are unable to say; but from the experiments of Biot, we know that it must be made suddenly and violently, for when gradually applied, as in the sinking of a mixture of the gases to the depth of one hundred and fifty fathoms,

where the compression would be about thirty atmospheres, no such effect was produced. And in the present case, the condensation had been made rapidly, and two hours before the explosion occurred. It is not impossible that the state of compression and close approximation of the particles of the gases may have aided the rapid combination, and but a slight increase of temperature have been required to produce explosion, which may have been caused in the tube, by the slight explosions to which I have before alluded as so often occurring in the jet. The capacity of the jet and stop cock, in front of the safety tube, was sufficient to contain but about one cubic inch of the gases, and the combustion of so small a quantity could have had but little influence in raising the temperature of the safety tube; probably none, when we consider that the compressed gases were expanding as they passed out, and no doubt attended with the usual effect, the absorption of caloric.

In a letter now before me, Dr. Hare has suggested the heating effect of the previous slight explosions, as the most probable cause of the final explosion; but for the reasons just stated, I am constrained to seek for some more satisfactory explanation.

Although it would be difficult, if not impossible, to prove that electricity, from the presence of the different metals entering into the construction of the various parts of the apparatus, or developed by, or evolved from the gases, or the products of their first partial combustions, was not the immediate cause of this explosion, it would be equally difficult, in the present state of our knowledge, to prove that it was. The ignition of platinum sponge, and the combination of oxygen and hydrogen which it effects, it is well known, were, when first observed, attributed by Dobereiner to electricity, which has not been disproved, or satisfactorily explained, even by the researches of Faraday.

Having communicated to the distinguished inventor of the compound blow-pipe a brief notice of the occurrence which I have described, it will not, I trust, be deemed an undue liberty to remark, that in the letter above referred to, Dr. Hare appears to consider all explosions as dependent on "a mysterious electrical reversal of polarities," and that we are not as yet able to determine all the modes by which such reversals may be induced.

From the first experiments made with the Hemming's tube, it is obvious that it cannot be said that the wires were not of

sufficiently small size to arrest explosion. Neither can it be supposed that the outlet at the extremity of the jet was insufficient for the expansion of the exploding mixture, and that in consequence of that expansion, the inflamed gases were driven back into the copper globe. This expansion must have been far greater than 15 or 18 times, as deduced from Davy's experiments, to have overcome the force exerted by the gases, which at the moment were issuing from the globe, under a pressure probably of nearly two atmospheres.

The expansion of hydrogen and oxygen gases by explosion, has not, I think, been satisfactorily determined; and Davy, whose results are most commonly adopted, does not appear to have deemed his own conclusive. I have made some experiments on the subject, and should not have offered the preceding remarks until more satisfactory results had been obtained, had it not been necessary to defer the investigation to an interval of more leisure.

When water is mechanically suspended in the gases, the danger of retraction and explosion is undoubtedly increased, but the influence of the small quantity formed in the jet on the occurrence of the slight explosions already alluded to, must have been in a great measure, if not altogether, counteracted by the elasticity of the issuing gases.

The cause of this explosion is certainly mysterious; but in whatever manner we may attempt to explain it, it must be regarded as additional evidence of the danger of employing the gases in a state of previous mixture, and of the importance of adhering to the use of two separate vessels and the concentric jet. With these, although less convenient on some accounts, there are other advantages; their perfect safety, however, is alone sufficient to induce us to recommend them, and them alone, to the chemical student.

The trials with the tube of Hemming *previous* to the occurrence of this explosion, seemed to warrant the statement in its favor which has been made in a note in the edition of my *Manual of Chemistry*, now passing through the press.

Laboratory of Harvard University, Cambridge, June 5th, 1839.

ART. XI.—*On the Greek Conjugations*; by Prof. J. W. GIBBS.

THE conjugations found in our common grammars, have usually been formed by writers directing their attention to a single language, and are probably the best for merely practical purposes.

It often happens, however, that there is another arrangement of the conjugations which enters more deeply into the nature of the verb, separates more closely between primary and derivative forms, and prepares the way for more successful comparisons with other languages.

The classification to which I allude is based, for the most part, on the broad distinction between internal or strong inflection which takes place within the root itself, and external or weak inflection which consists in the addition of new syllables and leaves the root untouched.

As the internal inflection, which consists principally in the change of the vowel or in the reduplication of initial letters, is found in radical or primitive verbs, and has a manifest analogy in different languages, it has of late engaged the attention of philologists.

These remarks apply more or less to Greek, Latin, and Teutonic, including English, verbs. I shall confine my attention at present to the Greek.

Strong Inflection.

Strong verbs in Greek are divided by philologists, for the sake of exhibiting their vocalic changes, into four classes.

The tenses chosen for the purpose of showing these vocalic changes are the 2 aorist, which usually exhibits the radical vowel, the 2 perfect, and the present.

Class I.

This class includes verbs whose radical vowel undergoes no change in inflection.

2 aor. ἐγράφην,	perf. γέγραφα,	pres. γράφω.
2 aor. εἶπον,	perf. ———	pres. εἶπω.
2 aor. ἐῤῥίφην,	perf. ἐῤῥίφα,	pres. ῥίπτω.
2 aor. ἐκόπην,	perf. κέκοπα,	pres. κόπτω.
2 aor. ἐκρούβην,	perf. κέκρουφα,	pres. κρούπτω.
2 aor. ἔδαον,	perf. δέδαα,	pres. δάω.
2 aor. ἔδιον,	perf. δέδια,	pres. δίω.
2 aor. ἐφύην,	perf. πέφυα,	pres. φύω.

Here belong a few verbs with α made and continued long by position, one verb with η , and a few doubtful examples with τ .

2 aor. ἔμαρπον,	2 perf. μέμαρπα,	pres. μάρομαι.
2 aor. ———	2 perf. λέλαμπα,	pres. λάμπω.
2 aor. ἐπλήγον,	2 perf. πέπληγα,	pres. πλήσσω.
2 aor. ἐβριθον,	2 perf. βέβριθα,	pres. βριθω.

The Latin language exhibits examples not only of *a*, but of other vowels, made and continued long by position; as, *lambo*, pret. *lambi*; *verto*, pret. *verti*; *mordi*, pret. *momordi*; *curro*, pret. *cucurri*.

Class II.

This class includes verbs whose radical vowel *α* is changed in the course of inflection into other vowels.

2 aor. ἔτραπον,	2 perf. τέτροπα,	pres. τρέπω.
2 aor. ἔλεγον,	2 perf. λέλογα,	pres. λέγω.
2 aor. ἔδαρκον,	2 perf. δέδορκα,	pres. δέρομαι.
2 aor. ἐστάλην,	2 perf. ἔστολα,	pres. στέλλω.
2 aor. ἔταμον,	2 perf. τέτομα,	pres. τέμνω.
2 aor. ἔκτανον,	2 perf. ἔκτονα,	pres. κτείνω.
2 aor. ἐφθάρην,	2 perf. ἐφθορα,	pres. φθείρω.

This second class has a striking analogy to the I. and II. Teutonic conjugations; as,

CONJUGATION I.		
Goth. past <i>brak</i> ,	part. <i>brukans</i> ,	pres. <i>brika</i> .
Germ. past <i>brach</i> ,	part. <i>gebroschen</i> ,	pres. <i>breche</i> .
Eng. past <i>brake</i> ,	part. <i>broken</i> ,	pres. <i>break</i> .
CONJUGATION II.		
Goth. past <i>halp</i> ,	part. <i>hulpan</i> ,	pres. <i>hilpa</i> .
Germ. past <i>half</i> ,	part. <i>geholfen</i> ,	pres. <i>helfe</i> .
Eng. past <i>holp</i> ,	part. <i>holpen</i> ,	pres. <i>help</i> .

This second class of Greek verbs, like the I. and II. Teutonic conjugations, has its radical vowel usually either preceded or followed by a liquid.

Class III.

This class includes verbs whose radical vowel *α*, *ι*, *υ*, is lengthened or doubled in certain tenses, *η* being equivalent to double *α*.

2 aor. ἐκράγον,	perf. κέκραγα,	pres. κράζω.
2 aor. ἐκλάγον,	perf. κέκληγα,	pres. κλάζω.
2 aor. ἐτάκην,	perf. τέτηκα,	pres. τήκω.
2 aor. ἔδακον,	perf. δέδηκα,	pres. δάκνω.
2 aor. ἐφᾶνον,	perf. πέφηνα,	pres. φαίνω.

2 aor. ἐκρίγον,	perf. κέκριγα,	pres. κρίζω.
2 aor. ἔβρουχον,	perf. βέβρουχα,	pres. βρουχω.
2 aor. ἔμυκον,	perf. μέμυκα,	pres. μυκαω.

This third class has a striking analogy to the IV. Teutonic conjugation, where however *ā* has been changed into *ō* or *ū*; as,

Goth. past <i>sloh</i> ,	part. <i>slahans</i> ,	pres. <i>slaha</i> .
Germ. past <i>schlug</i> ,	part. <i>geschlagen</i> ,	pres. <i>schlage</i> .
Eng. past <i>slew</i> ,	part. <i>slain</i> ,	pres. <i>slay</i> .

Class IV.

This class includes verbs whose radical vowel *ι*, *υ*, is made a diphthong by Guna in the perfect and present; as,

2 aor. ἐπίθον,	perf. πέποιθα,	pres. πείθω.
2 aor. ἔλιπον,	perf. λέλοιπα,	pres. λείπω.
2 aor. ἔφυγον,	perf. πέφευγα,	pres. φεύγω.
2 aor. ἔτυχον,	perf. τέτευχα,	pres. τεύχω.

In the first and second examples the radical vowel *ι* is made a diphthong by prefixing *ε* or *ο*, as in Sanscrit the same vowel is made a diphthong by prefixing *a*. In the third and fourth examples the radical vowel *υ* is made a diphthong by prefixing *ε*, as in Sanscrit the same vowel is made a diphthong by prefixing *a*. This mode of forming a diphthong out of *i* or *u* by prefixing *a*, is called *Guna* by the Sanscrit grammarians.

This fourth class has a striking analogy to the V. and VI. Teutonic conjugations; as,

CONJUGATION V.

Goth. past <i>draib</i> ,	part. <i>dribans</i> ,	pres. <i>dreiba</i> .
Germ. past <i>trieb</i> ,	part. <i>getrieben</i> ,	pres. <i>treibe</i> .
Eng. past <i>drove</i> ,	part. <i>driven</i> ,	pres. <i>drive</i> .

CONJUGATION VI.

Goth. past <i>baug</i> ,	part. <i>bugans</i> ,	pres. <i>biuga</i> .
Germ. past <i>bog</i> ,	part. <i>gebogen</i> ,	pres. <i>biege</i> .
Eng. past <i>bow</i> ,	part. <i>bowed</i> ,	pres. <i>bowed</i> .

In Conj. V. the radical vowel *i* is made a diphthong in Gothic by prefixing *a* or *e*. In Conj. VI. the radical vowel *u* is made a diphthong by prefixing *a* or *i*.

The fourth class of Greek verbs, like the V. and VI. Teutonic conjugations, has the radical vowel usually followed by a single consonant and that not a liquid.

The verbs belonging to these four classes are all primary or radical verbs.

Weak Inflection.

Weak verbs in Greek, or verbs externally inflected, include some primary verbs whose root or theme ends with a vowel or diphthong, and all derivatives or secondary formations.

Primary Verbs.

pres. δράω,	fut. δράσω,	perf. δέδρακα.
pres. πταίω,	fut. πταίσω,	perf. πέπταικα.
pres. παύω,	fut. παύσω,	perf. πέπαυκα.
pres. δέω,	fut. δήσω,	perf. δέδεκα.
pres. σείω,	fut. σείσω,	perf. σέσεικα.
pres. νείω,	fut. νείσω,	perf. νένευκα.
pres. τίω,	fut. τίσω,	perf. τέτικα.
pres. βόω,	fut. βώσω,	perf. βέβωκα.
pres. λούω,	fut. λούσω,	perf. λέλουκα.
pres. πτύω,	fut. πτύσω,	perf. πέπτυκα.

Secondary Verbs.

In άω ; as, τιμάω from τιμή, and this from τίω ; κομάω from κόμη.

In έω ; as, πονέω from πόνος, and this from πένω ; κοιρανέω from κοίρανος.

In εύω ; as, πομπεύω from πομπή, and this from πέμπω ; δουλεύω from δούλος.

In όω ; as, στεφανόω from στέφανος, and this from στέφω ; δουλόω, from δούλος.

In ύω ; as, τανύω from τείνω.

In άζω ; as, στενάζω from στένω ; δωριάζω from δῶρος.

In ιζω ; as, βαπτίζω from βάπτω ; μηδίζω from μῆδος.

In ύζω ; as, έρπύζω from έρπω.

In αινω ; as, σημαίνω from σῆμα.

In ύνω ; as, ήδύνω from ήδύς.

In ω directly, from nouns or adjectives ; as, ποικίλλω from ποικίλος.

ART. XII.—*Notice of Prof. Ehrenberg's Discoveries in relation to Fossil Animalcules*; also Notices of Deceased Members of the Geological Society of London, being extracts from the Address of Rev. WILLIAM WHEWELL, B. D. F. R. S., President of the Society; delivered at the Annual Meeting, Feb. 15, 1839.

THE Council have adjudged the Wollaston medal for the present year to Prof. Ehrenberg, for his discoveries respecting fossil Infusoria and other microscopic objects contained in the materials of the earth's strata. We all recollect the astonishment with which, nearly three years ago, we received the assertion, that large masses of rock, and even whole strata, are composed of the remains of microscopic animals. This assertion, made at that time by Professor Ehrenberg, has now not only been fully confirmed and very greatly extended by him, but it has assumed the character of one of the most important geological truths which have been brought to light in our time: for the connection of the present state of the earth with its condition at former periods of its history, a problem now always present to the mind of the philosophical geologist, receives new and unexpected illustration from these researches. Of about eighty species of fossil Infusoria which have been discovered in various strata, almost the half are species which still exist in the waters: and thus these forms of life, so long overlooked as invisible specks of brute matter, have a constancy and durability through the revolutions of the earth's surface which are denied to animals of a more conspicuous size and organization. Again, we are so accustomed to receive new confirmations of our well-established geological doctrines, that the occurrence of such an event produces in us little surprise; but if this were not so, we could not avoid being struck with one feature of Prof. Ehrenberg's discoveries;—that while the microscopic contents of the more recent strata are all fresh-water Infusoria, those of the chalk are bodies (*Peridinium Xanthidium*, *Fucoides*,) which must, or at least can, live in the waters of the ocean. Nor has Prof. Ehrenberg been content with examining the rocks in which these objects occur. During the last two years he has been pursuing a highly interesting series of researches with a view of ascertaining in what manner these vast masses of minute animals can have been accumulated. And the result of

his inquiries is,* that these creatures exist at present in such abundance, under favorable circumstances, that the difficulty disappears. In the Public Garden at Berlin he found that workmen were employed for several days in removing in wheelbarrows masses which consisted entirely of fossil Infusoria. He produced from the living animals in masses, so large as to be expressed in pounds, tripoli and polishing slate similar to the rocks from which he had originally obtained the remains of such animals; and he declares that a small rise in the price of tripoli would make it worth while to manufacture it from the living animals as an article of commerce. These results are only curious; but his speculations, founded upon these and similar facts, with respect to the formation of such rocks, for example, polishing slate, the siliceous paste called *keiselguhr*, and the layers of flint in chalk, are replete with geological instruction.

As the discoveries of Prof. Ehrenberg are thus full of interest for the geological speculator, so they have been the result, not of any fortunate chance, but of great attainments, knowledge, and labor. The author of them had made that most obscure and difficult portion of natural history, the infusorial animals, his study for many years; had travelled to the shores of the Mediterranean and the Red Sea in order to observe them; and had published (in conjunction with Prof. Müller) a work far eclipsing any thing which had previously appeared upon the subject. It was in consequence of his being thus prepared, that when his attention was called to the subject of fossil Infusoria, (which was done in June, 1836, by M. Fischer) he was able to produce, not loose analogies and insecure conjectures, but a clear determination of many species, many of them already familiar to him, although hardly ever seen perhaps by any other eye. The animals (for he has proved them to be animals, and not, as others had deemed them, plants) consist, in the greater number of examples, of a staff-like siliceous case, with a number of transverse markings; and these cases appear in many instances to make up vast masses by mere accumulation without any change. Whole rocks are composed of these minute cuirasses of crystal heaped together. Prof. Ehrenberg himself has examined the microscopic products of fifteen localities, and is still employed in extending

* Abhandl. Kön. Ak. Wissensch. Berlin. 1838.

his researches; and we already see researches of the same kind undertaken by others, to such an extent, as to show us that this new path of investigation will exercise a powerful influence upon the pursuits of geologists. We are sure therefore that we have acted in a manner suitable to the wishes of the honored Donor of the medal, and to the interests of the science which we all in common seek to promote, in assigning the Wollaston medal to Prof. Ehrenberg for these discoveries.

Although it is not necessary as a ground for this adjudication, it is only justice to Prof. Ehrenberg to remark, that his services to geology are not confined to the researches which I have mentioned. His observations, made in the Red Sea, upon the growth of corals, are of great value and interest; and he was one of the distinguished band of scientific explorers who accompanied Baron von Humboldt in his expedition to the Ural Mountains. And I may further add, that even since the Council adjudged this medal, Prof. Ehrenberg has announced to the Royal Academy of Sciences of Berlin new discoveries; particularly his observations on the organic structure of chalk; on the freshwater Infusoria found near Newcastle and Edinburgh, and on the marine animalcules observed near Dublin and Gravesend; and, what cannot but give rise to curious reflections, an account of *meteoric paper* which fell from the sky in Courland in 1686, and is found to be composed of *Confervæ* and Infusoria.

I now proceed to notice some of the most conspicuous names, both among our own countrymen and foreigners, which have been removed by death from our lists since last year.

In Sir Abraham Hume the Society has lost a member who was at all times one of its most strenuous friends and most liberal supporters, and especially in its earliest periods, when such aid was of most value. Indeed he may in a peculiar manner be considered as one of the Founders of the Society. English geology, as is well known, evolved itself out of the cultivation of mineralogy, —a study which was in no small degree promoted, at one time, by the fame of the mineralogical collections of Sir Abraham Hume and others. The Count de Bournon, exiled by the French revolution in 1790, brought to England new and striking views of crystallography, resembling those which Haüy was unfolding in France; and was employed to arrange and describe the mineralogical collections of Sir John St. Aubyn and Mr. Greville, and

especially the collection of diamonds of Sir Abraham Hume, of which a description, illustrated with plates, was published in 1816. Some years before this period a few lovers of mineralogy met at stated times at the house of Dr. Babington, whose influence in preparing the way for the formation of this Society was mentioned with just acknowledgment in the President's Address, in 1834, by Mr. Greenough; and certainly he, more fitly perhaps than any other person, could speak of the merits and services of his fellow laborers. Of the number of these Sir Abraham Hume was one; although not, I believe, one of those who showed their zeal for the pursuits which associated them by holding their meetings at the hour of seven in the morning, the only time of the day which Dr. Babington's professional engagements allowed him to devote to social enjoyments of this nature.

Out of the meetings to which I refer this Society more immediately sprung. The connection of mineralogy with geology is somewhat of the nature of that of the nurse with the healthy child born to rank and fortune. The foster-mother, without being even connected by any close natural relationship with her charge, supplies it nutriment in its earliest years, and supports it in its first infantine steps; but is destined, it may be, to be afterwards left in comparative obscurity by the growth and progress of her vigorous nursling. Yet though geology now seeks more various and savoury food from other quarters, she can never cease to look back with regard and gratitude to the lap in which she first sat, and the hands that supplied her early wants. And our warm acknowledgments must on all due occasions be paid to those who zealously cultivated mineralogy, when geology as we now understand the term, hardly existed; and who, when the nobler and more expansive science came before them, freely and gladly transferred to that their zeal and their munificence.

The spirit which prevailed in the infancy of this Society, and to which the Society owed its permanent existence, was one which did not shrink from difficulties and sacrifices; and among the persons who were animated by this spirit Sir Abraham Hume was eminent; his purse and his exertions being always at the service of the body. He gave his labors also to the Society by taking the office of Vice-President, which he discharged with diligence from 1809 to 1813. He died in March last at the great age of ninety, being then the oldest person both in this and in the Royal Society.

Mr. Benjamin Bevan was a civil engineer, and throughout his life showed a great love of science, and considerable power of promoting its purposes. He instituted various researches, theoretical and practical, on the strength of materials;* and it was he who first proved by experiment the curious proposition, that the Modulus of Elasticity of water and of ice is the same. In 1821 he wrote a letter to the secretary of this Society, recommending that the form of the surface of this country should be determined by barometrical measurements of the heights of a great number of points in it,—the barometer which was to be used as a standard being kept in London. Mr. Bevan and Mr. Webster were commissioned to procure a barometer, and Dr. Wollaston recommended one of Carey's barometers, but it does not appear that any further steps were taken. I may remark that recent researches have further confirmed the wisdom of Mr. Bevan's suggestion, that heights should be measured, as all other measurements are made, from some fixed *conventional* standard, instead of incurring the vagueness and inconsistency which result from assuming the existence of a natural standard, such as the level of the sea.

Nathaniel John Winch was born at Hampton Court in the year 1769, and after a voyage into the Mediterranean, and travels in various countries in Europe, settled at Newcastle-upon-Tyne as a merchant. He had early paid great attention to botany, which he continued to cultivate during a long life, and kept up a correspondence with all the leading botanists in Europe. He was one of the earliest, and always one of the most active members of the Literary and Philosophical Society of Newcastle; and, in conjunction with a few of his friends, gave to that town a scientific and cultured character, which still distinguishes it. He was one of the honorary members of this Society; and contributed to its meetings, in 1814, "Observations on the Geology of Northumberland and Durham," and in 1816, "Observations on the Eastern Part of Yorkshire,"† which were printed in the fourth and fifth

* To Mr. Bevan our Journal is indebted for many valuable communications.—*Ed. Lon. Phil. Mag.*

† Besides these papers, Mr. Winch published: "The Botanist's Guide through the Counties of Northumberland and Durham. By N. J. Winch, J. Thornhill, and R. Waugh." 2 vols. 1805.—"Flora of Northumberland and Durham." In the *Transactions of the Newcastle Natural History Society*, vol. 2.—"Essay on the Geographical Distribution of Plants through the Counties of Northumberland, Dur.

volumes of our Transactions. In these he stated his object to be to combine with his own observations much interesting information on the subjects of the quarries, and coal and lead mines, of those districts, which had long been accumulating, and was widely diffused among the professional conductors of the mines. And these memoirs, though not containing much of originality in their views and researches, were, at the time, of considerable utility. He died May 5th, 1838, and, by his will, left to this Society a very considerable and valuable mineralogical collection, now in our Museum.

Mr. William Salmon of York, was one of the persons who was most zealously and actively engaged in the examination of the celebrated Kirkdale Cavern. He measured and explored new branches of the cave in addition to those first opened, and made large collections of the teeth and bones, from which he sent specimens to the Royal Institution of London, and to Cuvier at Paris. The bulk of his collection was deposited in the Philosophical Society at York, then newly established.

I now proceed to notice our deceased Foreign Members.

François-Dominique de Reynaud, Comte de Montlosier, was born at Clermont in Auvergne, April the 16th, 1755, the year of the celebrated earthquake of Lisbon. He was the youngest of twelve children of a family of the smaller nobility of that province, and was remarkable at an early age for the zeal with which he pursued various branches of science and literature.

Count Montlosier must ever be considered as one of the most striking writers in that great controversy respecting the origin of basaltic rocks, which occupied the attention of mineralogists during the latter half of the last century; and to which, in so large a degree, the progress and present state of geology are to be ascribed. The theory of the extinct volcanos of Auvergne, the subject of his researches, was the speculation which gave the main impulse to scientific curiosity on this point. It is true that he was not the originator of the opinions which he so ably expounded. Guettard, in 1751, had seen, vaguely and imperfectly, that which it now appears so impossible not to see, the evidences

ham, and Cumberland." First edition, 1820; second edition, 1825.—"Contributions to the Flora of Cumberland." 1833.—"Addenda to the Flora of Northumberland and Durham." 1836.

of igneous origin in the rocks of that district: and the elder Desmarest, whose examination of them began in 1763, had made that classification of them, which is the basis, and indeed the main substance, of the views still entertained with regard to the structure of that most instructive region. His map of the district, published in 1774 (in the Transactions of the Academy of Paris for 1771, according to a bad habit of that body still prevailing,) exhibits the distinction of modern currents of lava, ancient currents, and rocks fused in the places where they now are, which distinction supplies a key to the most extraordinary phenomena, while it reveals to us a history more wonderful still. But striking and persuasive as this view was, and fitted, apparently, to carry with it universal conviction, the theory which it implied, collected, as it seemed at the time, from one or two obscure spots in Europe, was for a while resisted and almost borne down by the opposite doctrine of the aqueous origin of basalt; which came from the school of Freyberg, recommended by the power of a connected and comprehensive system,—a power in science so mighty for good and for evil. Montlosier's Essay on the Volcanos of Auvergne, which appeared first in 1788, was, however, not written with any direct reference to this controversy, but was rather the exposition of the clear and lively views of an acute and sagacious man, writing from the fullness of a perfect acquaintance with the country which he described, in which, indeed, his own estate and abode lay. In its main scheme, although Desmarest's is mentioned with just praise,* the object of this Essay is to criticise and correct a work of M. Le Grand d'Aussy, entitled *Voyage en Auvergne*. But as the main additions to sound theory which this work contains, (a point which here concerns us far more than its occasion and temporary effect,) we may, I think, note the mode in which he traces in detail the effects which the more recent currents of lava (those which follow the causes of the existing valleys) must have produced upon the courses of rivers and the position of lakes; and the idea, at that time a very bold and, I believe, a novel one, that lofty insulated ridges and pinnacles of basalt, which tower over the valleys, have been cut into their present form by the long-continued action of fluviate waters,

* After mentioning Guettard, he says, "Les mémoires de M. Desmarest, publiés quelques années après, entraînent tout-à-fait l'opinion publique." (p. 20.)

aided by a configuration of the surface very different from the present. The striking and vivid pictures which Montlosier draws of such occurrences, are to the present day singularly instructing and convincing to those who look at that region with the geologist's eye. After publishing this essay, M. Montlosier, a man of varied and commanding talents, became involved in the political struggles of his time, and was an active member of the National Assembly, to which he was sent as Deputy of the Noblesse of Auvergne. In his place there he resisted in vain the proposals for the spoliation of the clergy; and one speech of his on this subject was very celebrated. After witnessing some of the changes which his unhappy country had then to suffer, he became an exile, and resided in London, where for some years he was the editor of the *Courier Français*, a royalist journal. Under the empire, he returned to France, and was employed in the Foreign Office of the Ministry, but recovered little of his property except a portion of a mountain, which was too ungrateful a soil to find another purchaser. The situation however could not but be congenial to his geological feelings; for his habitation was in the extinct crater of the Puys de Vaches. The traveller, in approaching the door of the philosopher of Randane, had to wade through scoriæ and ashes; and from the deep basin in which his house stood, a torrent of lava, still rugged and covered with cinders, has poured down the valley, and at the distance of a league, has formed a dike and barred up the waters which form the lake of Aidat;—a spot celebrated by Sidonius Apollinaris, Bishop of Clermont in the fifth century, as the seat of his own beautiful residence, under the name of Avitacus. It is curious to remark that Sidonius does not overlook the resemblance between his own mountain and Vesuvius:

“*Æmula Baiano tolluntur culmina cono,
Parque cothurnato vertice fulget apex.*”

In this most appropriate abode M. de Montlosier was, in his old age, visited at different times by several distinguished English geologists, some of whom are now present; and invariably delighted them with his unfading interest in the geology of his own region, his hospitable reception, and I may add, his lofty and vigorous presence, according well with his frank and chivalrous demeanor. His ardor of character had shown itself in early age: “From my first youth,” thus his Essay opens, “I occupied my-

self with the natural history of my province, in spite of repulse and ridicule." The same spirit involved him in other struggles to the end of his life ; and, indeed, we may almost say, beyond it. He took a prominent part in the political controversies of his day ; and few works on such subjects, which appeared in France in modern times, produced a greater fermentation than his "*Mémoire à consulter*" on the subject of the Jesuits. In this work he maintained that the position of the Jesuits in France was dangerous and illegal ; and he must be considered as the originator of that movement in consequence of which their body was, a few years later, suppressed by the government. The expression of his opinions respecting the conduct and influence of the clergy of his country was condemned by the ecclesiastical authorities, and was deemed by them of a nature to exclude him from that recognition of his being a son of the Catholic Church, which is implied by the performance of the funeral rite according to its ordinances. This, however, did not prevent the inhabitants of the neighborhood and the military stationed at Clermont from showing the regard which his intercourse with them had inspired, by attending his sepulture in great numbers. He was buried in a spot previously selected by himself, in the crater of the extinct volcano in which his abode was, in the middle of the scenes which he had from his earliest years loved and studied, and taught others to feel a deep interest in. He died at the age of 83, on his way to Paris in order to take his seat in the Chamber of Peers, of which he was a member.*

Anselme-Gaëtan Desmarest, honorary member of the Royal Academy of Medicine, and Professor of Zoology at the Royal Veterinary College of Alfort, was the son of Nicolas Desmarest, who has just been mentioned as the predecessor of Montlosier in his theory of the volcanic origin of Auvergne. The son also employed himself upon the same district ; and published an enlarged

* Besides his "*Essay on the Extinct Volcanos of Auvergne*," M. de Montlosier was the author of the following works : "*Mémoire à consulter sur un Système Religieux et Politique tendant à renverser la Religion, la Société et le Trône*" (1826.) "*Dénonciation aux Cours Royales relativement au Système Religieux et Politique signalé dans le Mémoire à consulter*," (1826.) "*Mémoires de M. le Comte de Montlosier sur la Révolution Française, le Consulat, l'Empire, et les principaux Evénements qui ont suivis 1755-1830.*" Of this work two volumes have appeared, which bring the narrative down to the author's quitting the National Assembly in 1790.

and improved edition of his father's map of Auvergne;—a work which is still spoken of with admiration, for its fidelity and skillful construction, by all who explore that country. But the labors of the younger Desmarest were principally bestowed upon the other parts of natural history. We possess in our Library, extracted from various journals, and presented us by the author, his "Notes on the impression of marine bodies in the strata of Montmartre," published in 1809; his "Memoir on the Gyrogonite," published in 1810; to which he added, 1812, the recognition of the analogy of this fossil with the fruit of the Chara, pointed out by his brother-in-law M. Léman; his review of a work by M. Daubebard de Ferussac, on the Fossils of Freshwater Formations, in 1813; his memoir on Two Genera of Fossil Chambered Shells, in 1817; and his "Natural History of Proper Fossil Crustaceans," published in 1822 along with M. Brongniart's "Natural History of Fossil Trilobites." In the "Dictionnaire d'Histoire Naturelle," the article Malacostracés, which contains a complete account and classification of Crustaceans, is by M. Desmarest, with others on the same subject. In this work all the articles on Crustaceans had originally been assigned to Dr. Leach; but when the lamented illness of that distinguished naturalist prevented his finishing this task, it was committed to Desmarest, who carefully studied the labors of his predecessor; and, with most laudable industry and self-denial, made it his business to follow his method as closely as possible. He also published a separate work on Crustaceans in 1825.

Count Kaspar Sternberg was one of those persons, so valuable in every country, who employ the advantages of wealth and rank in the cultivation and encouragement of science. He belonged to a younger branch of one of the best and oldest families in Bohemia; and was closely connected with the persons of most elevated station in that country. He was born the 6th of January, 1761, and received a distinguished education at Prague; not only, as was then common among the Bohemian nobility, through private tutors, but by following the public course of the university. He was created Canon of the Chapter of the metropolitan church at Ratisbon, which, obliging him to receive the lower degree of holy orders, bound him to celibacy. At Ratisbon, then a considerable place, and the seat of the Diet of the German empire, he formed friendships with several eminent persons, and especially

with Count Bray (afterwards Bavarian minister at various courts,) a man of letters, and a distinguished botanist. Count Sternberg also cultivated botany, and became an active member of the Botanical Society of Ratisbon. During the time that Germany was a prey to the miseries of war, he retired to his hereditary country seat Brzezina, in the circle of Pilsen, in the northwestern part of Bohemia. Here his attention was early drawn to the coal formation, of which mineral he possessed an extensive estate at Radnitz. He soon formed the intention of publishing representations of the fossil vegetables belonging to the coal strata. These had already begun to excite the attention of geologists. Some of these works, containing notices on such subjects, preceded the existence of sound geology, as the *Herbarium Diluvianum* of Scheuchzer, the *Sylva Subterranea* of Beutinger, and the *Lapis Diluvii Testis* of Knoop.* At the beginning of the present century, Faujas de St. Fond had published in the *Annales du Muséum* some impressions of leaves, not indeed belonging to the coal, but to a later formation. These impressions were examined and determined by Count Sternberg, in the *Botanical Journal of Ratisbon*, in 1803. In the following year appeared the first truly scientific work on this subject, the "*Flora der Vorwelt*" of Schlotheim, in which the great problem which was supposed to demand a solution was, Whether the vegetables of which the traces are thus exhibited belong to existing or to extinct kinds? Count Sternberg was in Paris when he received the work of Schlotheim, and he studied it carefully by the aid of the collections which exist in that metropolis. He published in the *Annales du Muséum* a notice on the analogies of these plants, but concluded with observing, that a greater mass of facts was requisite; and that, these once collected, the general views which belong to the subject would come out of themselves.

Bearing in mind this remark of his own, when fortune, after the storming of Ratisbon in 1809, set him down in the midst of the great coal formations of Bohemia, he proceeded forthwith to manage the working of his mines, so as to preserve as much as possible the most remarkable impressions of fossils. Combining his

* To the earlier works on this subject we may add Martin's *Petrificata Derbicensis*, published 1809; and Parkinson's *Organic Remains*, (1804,) which contains many plates of vegetables.

own specimens with those found in other places, he began to publish, in 1820, his "Essay towards a Geognostic-botanical Representation of the Flora of the Pre-existing World." In this work he not only gave a great number of very beautiful colored engravings of vegetable fossils, but also attempted a systematic classification of them. But he stated, in the first portion of his work,* that the problems, important alike for botany and geology, which offered themselves, could only be solved by combined labors on a common plan; and after mentioning the various European Societies to which he looked for assistance (among which he includes this Society,) he adds, "Bohemia and the hereditary states of the Austrian empire, I am ready, with some friends of science, to make the subject of continued investigation." The specimens of which he published representations, with many more, formed the Count's collection at his castle of Brzezina; but he declared in the outset, that as soon as the National Bohemian Museum at Prague was provided with the means of receiving and displaying this collection, the whole should be transferred from Brzezina to the capital. This was afterwards done; and in this and other ways he was one of the principal founders of the Museum at Prague. He also gave notice, that while the collection continued in his own residence, it was open to the inspection of every lover of science, even in the absence of the Count himself.

The publication of Sternberg's *Flora der Vorwelt* went on till 1825, after which it was discontinued till 1838, when two parts appeared, terminating the work. In this last publication he states that he is compelled to give up this undertaking, having been in a great measure deprived of sight for two years, so that he was obliged to devolve the greater part of such labors upon MM. Corda and Presl. His hearing also failed him. He adds, however, that though thus no longer able to pursue the path which he has trodden for twenty years, he shall not fail to render to the science, of which he was one of the founders, any service which may be in his power. This publication was the crowning labor of his life, for he did not long survive it; he retained, however, to the last the elasticity and activity of his mind. He died very suddenly at his country seat already mentioned, on the 20th of December, 1838, being carried off by apoplexy in his 78th year.

* *Erster Heft*, p 16.

In his own country his influence was highly salutary: he directed his attention especially to the improvement of the national education; and we cannot be surprised at finding such a person very soon at the head of nearly all the institutions for literary and public purposes. He founded the National Museum of Bohemia, of which he was the President; gave to it his library and his various collections, and further enriched it at various periods of his life. He was, indeed, zealous in all that concerned Bohemian nationality, and was an accomplished master of the language and literature of his country: since his death I am assured that there is hardly one Bohemian of any class who does not mourn for him as for a most respected benefactor. Throughout Germany, he was looked to by all who felt an interest in science with a respect and regard which he well merited. The emperor Francis held him in the highest esteem; he gave him the title of Privy Councillor, and the Grand Cross of St. Leopold, held in that monarchy as a distinguished honor.

In the preceding sketch I have mentioned Schlotheim as one of the predecessors of Count Sternberg in fossil botany. Although this writer died in 1832, and was an honorary member of this Society, he has never been noticed in the annual address; I may therefore here add a few words with reference to him. Baron E. F. von Schlotheim was Privy Councillor and President of the Chamber at the court of Gotha, and his collection of Petrifications has long been celebrated throughout Germany. Besides his *Flora of a Former World, or Descriptions of remarkable Impressions of Plants*, which appeared in 1804, he published, in 1820, '*Petrifactionkunde, or the Science of Petrifications according to its present condition, illustrated by the Description of a Collection of petrified and fossil remains of the animal and vegetable kingdom of a former world.*' And in 1822 and 1823 he published Appendixes to this work. His collection was also further made known by articles in Leonhard's *Mineralogical Pocket Book* and in the *Isis*. After his death a new description of this collection was announced, but whether it appeared I am not able to say. Schlotheim's introduction to his account of his collection contains some extensive geological views.

It is only justice to M. de Schlotheim to add here what is said of him by M. Adolphe Brongniart, whose own labors on fossil vegetables have been of such inestimable value to the geologist, and

are every year increasing in interest. "Almost half a century," he says, "elapsed, during which no important work appeared on this subject. It was not till 1804 that the 'Flora of the Ancient World', by M. de Schlotheim, again turned the attention of naturalists to this branch of science. More perfect figures, descriptions given in detail and constructed with the precision of style which belongs to botany, and moreover some attempts at comparison with living vegetables, showed that this part of natural history was susceptible of being treated like the other branches of science: and we may say, that if the author had established a nomenclature for the vegetables which he described, his work would have become the basis of all the succeeding labors on the same subject."

The following gentlemen were elected, Feb. 15, 1839, Officers and Council of the Society for the year ensuing.

President.—Rev. W. Buckland, D.D., Professor of Geology and Mineralogy in the University of Oxford.

Vice-Presidents.—G. B. Greenough, Esq. F.R.S. and L.S.; Leonard Horner, Esq. F.R.S. L. & E.; Charles Lyell, jun. Esq. F.R.S. & L.S.; Rev. Adam Sedgwick, F.R.S. and L.S., Woodwardian Professor in the University of Cambridge.

Secretaries.—Charles Darwin, Esq. F.R.S.; William John Hamilton, Esq.

Foreign Secretary.—H. T. De la Beche, Esq. F.R.S. & L.S.

Treasurer.—John Taylor, Esq. F.R.S.

Council.—Professor Daubeny, M.D. F.R.S. & L.S.; Sir P. Grey Egerton, Bart. M.P. F.R.S.; W. H. Fitton, M.D. F.R.S. & L.S.; Prof. Grant, M.D. F.R.S.; Rev. Prof. Henslow, F.L.S.; W. Hopkins, Esq. M.A. F.R.S.; Robert Hutton, Esq. M.P. M.R.I.A.; Sir Charles Lemon, Bart. M.P. F.R.S.; Prof. Miller, M.A.; R. I. Murchison, Esq. F.R.S. & L.S.; Richard Owen, Esq. F.R.S.; Sir Woodbine Parish, K.C.H. F.R.S.; George Rennie, Esq. F.R.S.; Rev. Prof. Whewell, F.R.S.

ART. XIII.—*Account of a Meteor seen in Connecticut, December 14, 1837; with some considerations on the Meteorite which exploded near Weston, Dec. 14, 1807; by EDWARD C. HERRICK, Rec. Sec. Conn. Acad.*

ON the evening of Thursday, the 14th of December, 1837, a meteoric fire-ball of great splendor, was seen by many persons in this vicinity. At the time of its appearance, Mr. A. B. Haile and myself were abroad here, engaged in making observations on shooting stars in concert with Messrs. F. A. P. Barnard, J. D. Dana, and J. H. Pettingell, in New York. Our attention was exclusively directed to the northeastern part of the heavens, and the western quarter, in which the meteor appeared, was unfortunately concealed from view at our station by a contiguous building. A brilliant flash suddenly illuminated the roof on which we stood, and concluding at once that the unseen source of the light must be a meteor of uncommon splendor, we noted the time. It was 7h. 39m. 32s. P. M.

I was not able, after much inquiry, to ascertain the position of the meteor at its first appearance. The testimony of two independent witnesses several rods distant from each other, near the middle of this city, coincided as to the azimuth of the point of extinction, and furnished me with data for fixing it at S. 89° W. The altitude was less certain, but appeared to be about 9° .

The meteor was much more splendid than Venus. It was apparently, according to the estimates of different observers, from one fourth to three fourths as large as the full moon. It moved downwards from a point between S. and W. at an angle of from 30° to 50° with a vertical, to the point before indicated, where it appeared to explode, and to throw down one or more large fragments. The time of flight was 1 or 1.5 seconds. It was attended by a long and broad train of scintillations, some part of which remained visible for about ten seconds, and of course, long after the meteor was extinct. It is uncertain whether the report of the explosion was heard here. If audible at this distance, the sound would not have arrived until two or three minutes after the disappearance of the meteor, and unless very heavy, it might easily have passed unnoticed amidst the noise of the city.

Thinking it probable that some portion of this meteor had fallen in the southwestern part of this State, I made inquiries by letter in various towns in that region. At Wilton, (28 miles, about W. by S. from this city,) the meteor was seen by several persons, and their testimony was kindly collected for me, by Mr. Hawley Olmstead. Mr. Edward Baldwin, one of the observers at that place, has given me some additional details. For observations at a spot about seven miles S. W. from Wilton, I am indebted to Rev. Theophilus Smith of New Canaan. At *Wilton*, the meteor passed a little south of the zenith, in a westerly direction. It gradually enlarged until just before the explosion, and at the largest, it was of "the magnitude of one fourth of the moon." The brilliancy of the meteor was exceedingly great, and rendered minute objects on the ground distinctly visible. Its light was so intense that it arrested the attention of a person engaged in study in his room with two candles burning before him. The train was long, and remained in sight several seconds after the explosion. When 25° or 30° above the horizon, the meteor exploded with a heavy report, which, according to the mean of various estimates, reached the ear in about thirty seconds afterwards. One or more of the observers saw luminous fragments descend towards the ground. Most of the witnesses imagined that they heard a whizzing noise, as the meteor passed over their heads; but this could not have been noticed until several seconds after the meteor's passage.

After collecting numerous observations from witnesses in various places, I found that they were not sufficiently exact and concordant to enable me to give a satisfactory account of the meteor, and I was for some time uncertain whether it was worth while to publish them. The following are the results which were obtained. The *direction* of the path of the meteor while visible, was probably one or two degrees N. of W. and inclined downwards. The *length of its path*, and its *relative velocity*, can only be roughly conjectured, as I do not find that any one saw the meteor at its earliest appearance. Its path while visible may have been from 15 to 20 miles long. On account of the direction of the earth's motion at the moment, the relative velocity of the meteor was probably less than the absolute, but how much less cannot be determined, as we do not know the angle which its path made with our horizon. When it exploded, it was three or four miles above the surface of the earth, and probably over the

town of Poundridge, Westchester County, N. Y.* The fragments which fell, doubtless lie buried somewhere in that region,—to be discovered, perhaps, in future ages. The larger part of the meteor appears to have passed on, in its path around the sun. The *size* of the meteor can be ascertained in the present instance with about as much certainty as in most similar cases. Respecting this particular there is always abundant room for fallacious results. The observer is commonly too unskillful to make a just comparison of the angular size of the meteor with that of any celestial body; and he is moreover, without being conscious of it, often prone to exaggeration. He rarely sees the bare nucleus, but only the envelope of flame and sparks, and that, greatly enlarged by irradiation. Hence, there is danger of making the size of the body much too large, especially when the calculation is based on observations taken at the distance of 50 or 100 miles. The nearer the observer is to the meteor, the less is the probability of error in this respect. In the present instance, an estimate of the apparent size of the meteor by an observer at North Branford, (nearly 40 miles from the place of explosion,) would make the diameter of the meteor ten or twelve times as great as that resulting from the observations at Wilton, only about six miles from the place of explosion. The data from Wilton make the diameter of the meteor about 150 feet, and it was probably a little less than this. The distant observations on the apparent size of the meteor must be rejected.

On the velocity of the Weston Meteorite.

The meteor which cast down stones in several places in and about Weston in this State, on the morning of Monday, December 14, 1807, excited uncommon attention far and wide, and full accounts of its interesting phenomena, were published in the highly valuable memoirs of Professors Silliman and Kingsley,† and of Dr. Bowditch.‡ To the elaborate calculations of the lat-

* I did not succeed in obtaining any observations on this meteor from the State of New York, but I was not able to make thorough inquiry in that quarter.

† Trans. Am. Phil. Soc. vi, 323; Mem. Conn. Acad. i, 141; Med. Repos. xi, 202. See also a paper in the Churchman's Monthly Mag. New Haven, v, 35; account by Messrs Bronson and Holley in N. Y. Spectator, Jan. 2, 1808; Med. Repos., xi, 418; ib. xiv, 194, (1811.)

‡ Mem. Amer. Acad. iii, 213.

ter we are indebted for our knowledge concerning its height, direction, velocity and magnitude.

The case of the Weston meteor is one of exceeding importance, because it is probably the only instance where a meteor from which stones are known to have come to the earth, has been sufficiently well observed for the determination of its velocity. This element is of great value, on account of its bearing on the relation between meteorites and shooting stars. There can indeed be no reasonable doubt, that many of the meteors which have been seen and heard to explode, and whose phenomena have been submitted to calculation, were true meteorites; but this is a case where there is absolute certainty.

Dr. Bowditch ascertained that the course of the Weston meteor "was about S. 7° W., in a direction nearly parallel to the surface of the earth, and at the height of about eighteen miles." It was about a mile further from the earth's surface when it exploded, than when it first appeared. The length of its path from the time it was first seen until it exploded, as determined from the observations made at Rutland, Vt., and at Weston, was at least 107 miles. This space being divided by the duration of the flight as estimated by two of the observers, viz. thirty seconds, we have for the meteor's relative velocity, about three and a half miles a second. The observations made at Wenham, Mass., are probably less exact in this respect, and need not be mentioned here. Every one accustomed to observations on meteors, knows how difficult it is accurately to determine the duration of their visible flight. An inexperienced observer, however intelligent, will frequently give the time, ten or even twenty fold too large. The apparent motion of the Weston meteor, was probably much slower than that of most meteors, but it seems to me highly improbable that its visible flight could have exceeded fifteen or twenty seconds. Mr. Page, the observer at Rutland, Vt., says,— "motion very rapid, probably thirty seconds in sight." The arc traversed by the meteor as there seen, was not over 15 degrees. Now it is scarcely credible that any man could consider as *very rapid*, the motion of a meteor at the rate of one degree in two seconds of time. It will perhaps be deemed improper to introduce here, at this distant period, the recollected observation of one not unversed in science, who saw the meteor from a spot a few miles northwest of this city, and who is confident that it could not have been in sight as long as ten seconds. I will

therefore make no further use of his testimony. There are, however, two considerations which may throw some light on this point.

1. The meteor if a satellite, must have moved with a velocity greater than three and a half miles per second, because if it did not, the earth's attraction would soon have brought the whole mass to the ground. But it is certain that much the greater portion passed on. In order to have done this, through the air, at the height of eighteen miles, it must have had a velocity not less than five miles per second.

2. According to Mr. E. Staples, (one of the observers at Weston,) "when the meteor disappeared, there were apparently three successive efforts or leaps of the fire-ball which grew more dim at every throe, and disappeared with the last."* Soon after the meteor disappeared, were heard three principal heavy reports, which "succeeded each other with as much rapidity as was consistent with distinctness, and all together, did not occupy three seconds." Professors Silliman and Kingsley, who thoroughly examined the region where the stones fell, a few days after the event, say, "We think we are able to point out three principal places where stones have fallen, corresponding with the three loud cannon-like reports, and with the three leaps of the meteor." The account given by Mr. Isaac Bronson, of an investigation made Dec. 19, 1807, by himself and Rev. Horace Holley, confirms this position.

(1.) The most northerly fall was in Huntington, on the border of Weston, near the house of Mr. Merwin Burr. (2.) The second principal deposit was near the house of Mr. William Prince "in Weston, distant about *five miles* in a southerly direction from Mr. Burr's." (3.) The third and probably the largest collection, fell near the house of Mr. Elijah Seeley, "at the distance of about *four miles* from Mr. Prince's."

Although it is not certain that these several masses came in the same direction from the meteoric body, yet until the contrary appears, it may, not unfairly, be assumed that they did; and consequently the interval of space at which they struck the earth,

* Observers in Wallingford, Meriden, Cheshire, &c., "all agree that its motion was not uniform either in velocity or direction, but that it seemed to bound, or as one of them expresses it, *to move scolloping*." Ch. Mo. Mag., v. 36. This is probably due to the resistance of the air, which, in such cases, must be exceedingly great.

furnishes some measure of the velocity of the meteor relative to the earth's surface. The statement will permit us to allow not quite a second of time between each report, and we thus obtain a velocity as great as four or five miles a second. This result is of course no more than a rude approximation to the truth.

The velocity thus far spoken of, is only the velocity *relative to the earth*. Here the question arises,—if the meteor was not a satellite of the earth, what was its *absolute* rate of motion? Now it will be noticed (p. 133, lines 14, 15) that the path of the meteor must have been nearly in the same direction with that of the earth at the time. Their directions in azimuth were almost identical; the direction of the meteor's path in altitude, appears to have been a little below that of the earth. If the meteor was moving around the sun, then nearly the whole of the earth's velocity (at that season) of rather more than nineteen miles a second,—must be added to the meteor's relative velocity to obtain the true velocity. In this view, its absolute rate of motion will be found to have been at least *twenty miles a second*.

It remains only to inquire, whether it is more probable that the Weston meteorite was a satellite of the earth, or a primary body moving around the sun. If this meteor had passed the earth's surface in the direction opposite to that of the earth's motion, with about the relative velocity which it exhibited, then we might be compelled to consider it a satellite of the earth. But the peculiar direction in which it moved, makes it an ambiguous case. We must therefore resort to other instances, for a solution of the question. Numerous observations on meteoric fire-balls which were without doubt real meteorites, have been made and computed. It has most generally been found, that whenever they come in a direction more or less opposed to that of the earth's motion, their velocity is greater than ten miles a second; which proves them to be in revolution about the sun and not about the earth. Their velocity has indeed more than once, exceeded thirty miles a second. It is then from analogy altogether probable that the Weston meteor was a body revolving around the sun, and that if it had approached the earth from the contrary direction, it would have been found moving with a relative velocity of not less than forty miles a second.

New Haven, Conn.

ART. XIV.—*Some Notice of British Naturalists*; by Rev. CHARLES FOX, Cor. Mem. of the N. Y. Lyc. of Nat. Hist.

Continued from Vol. XXXVI, No. 2, p. 230.

RAY had two contemporaries whose names are still remembered with respect. To the first we owe the origin of British Conchology.

MARTIN LISTER was descended from an old and respectable Yorkshire family; but his parents, having removed from their own county, had settled in Buckinghamshire, where he was born in 1638. His earlier education was superintended by his uncle, Sir Matthew Lister, Physician to King Charles I, and President of the Royal College of Physicians in London. At the usual age he entered the University; and in 1658, being then but 20 years of age, he took his degree at St. John's College, Cambridge. Like Ray he appears to have distinguished himself here by his abilities and his classical attainments; and two years after, he was created by the royal mandate, a fellow of his College. The profession which he now chose to pursue was that of medicine; and having traveled for some time upon the continent, in order to perfect himself, as was then usual for persons of his education, about five years after he had become a fellow, he settled at York to practice as a physician. Whether he had heretofore, paid any attention to the study of Natural History, further than his profession required, does not appear; but it was not till 1671 that he first became an acknowledged writer upon the subject. The only periodical work of importance, the pages of which were at this time open to accounts of miscellaneous scientific discoveries, was the Philosophical Transactions of the Royal Society of London. In this work we find Lister's first paper,—“*Observations on an acid liquor obtained from ants and perhaps other insects.*” After having thus once began, he was a frequent contributor; and he appears to have been not only an acute observer, but likewise a careful collector of miscellaneous facts on a variety of subjects. His papers in the Philosophical Transactions amount, in the whole, to about forty; several of which are upon antiquities, and one or two upon the anatomy of Testacea. But his principal works, and those upon which his fame and usefulness as an author chiefly rest, are—I. *Historiæ Animalium Angliæ, tres*

Tractatus ; Unus de Araneis ; alter de Cochleis, tam terrestribus tam fluviatilibus ; tertius de Cochleis Marinis. Adjectus est quartus de lapidibus ejusdem Insulæ, ad cochlearum imaginem figuratis. London, 1678. 4to. II. *Historiæ, sive Synopsis Conchyliorum quorum omnium Picturæ ad vivum delineatæ, exhibentur.* Lond. 1685–92, and a third edition at Oxford, 1770. This latter edition consists of 1059 plates, exclusive of the anatomical ones ; but there is very little letter press connected with it. Mr. Granger informs us that the drawings were executed chiefly by his two daughters, Anna and Susanna, and some think that these ladies engraved the plates likewise.

III. *Exercitatio Anatomica de Cochleis maxime terrestribus et Limacibus.* 1694. 8vo.

IV. *Exer. Anat. altera de buccinis fluviatilibus et marinis.* 1695. 8vo.

V. *Exer. Anat. tertia Conchyliorum bivalvium.* 1696. 4to.

The plates are remarkable for their fidelity and excellency. In his first work he confines himself chiefly to the shells of the northern counties, and describes sixty-three species. In his second work a large number, not before noted, are added. His other writings, some of which are upon medicine, are numerous ; but may be said, in general, to be marked with a propensity to hypothesis, and too strong an attachment to ancient doctrines. He now became well known in the scientific world ; his practice as a physician was constantly increasing ; and his fame was generally extended. In 1684 he was persuaded to remove to London, in order that he might enjoy the advantages which the metropolis alone could afford him ; and in 1698 he was sent on an embassy, with the Earl of Portland, to the Court of France. On his return he published an account of his journey, which was severely satirized, as containing some things which were supposed to be puerile and frivolous. He was elected a fellow of the Royal College of Physicians ; and in 1709 he was appointed Physician in Ordinary to Queen Anne. This honor, however, he did not long live to enjoy ; for he died February, 1711,—having reached the highest point in his profession. When we read over the list of his numerous writings, we are surprised at his great and unceasing industry. He is a remarkable instance of what a person may do who makes use of *all* his time ; for Natural History seems to have been but a recreation to him ; and all he did on this subject he

appears to have accomplished during his leisure hours. His professional practice was large ; he was by no means unacquainted with the writings of preceding Physicians, and his information on general topics was such as might be expected from one holding the high station in society which he did. What has been justly remarked of those among the ancients who wrote on Natural History, we may apply, without much change, to Lister,—that they were men of enlarged minds, who were far from being confined to one study ; that their views were elevated, and their knowledge various and profound ; and that while no object appeared too minute for their consideration, their depth of thought preserved them from trifling or unimportant investigations. Lister may be said to be the father of Conchology in England ; and his anatomical examinations prove how correct a view he took of the subject. In these writings he has displayed both great accuracy of observation, and indefatigable industry in detecting the most minute particulars of the economy of this part of creation ; and we may still refer to his works with profit, instruction, and interest.

SIR ROBERT SIBBALD.—The principal source of information respecting him, is from an autobiography written in 1695, recently published, with other scraps of Scottish history* under the title of “*Analecta Scotica.*” He was descended from a noble family of great antiquity, and enjoyed the influence of a judicious and excellent mother, who was very careful of his education. He was born at Edinburgh, April 15, 1641, and received his education in the high school and university of that city. He then spent two years and a half on the continent, studying medicine at Leyden and in Paris, and cultivating the acquaintance of the leading savans of the day. Having obtained a French diploma of medicine he travelled in various parts of France, and returned through England to Edinburgh in October, 1662. There was in those days no public coach north of York, whence he travelled to Newcastle on horseback with a guide, whom he retained through the remainder of his journey.

On his return to his native country, he projected the plan for establishing a Royal College of Physicians in Edinburgh, and was active in carrying it into effect. In 1686 he is said to have embraced Popery ; from which, in a few years, he again recanted.

* *Naturalist's Library*, vol. ix, p. 18.

His practice was extensive, and it was chiefly as a recreation from his severer duties that he pursued the study of Antiquities and Natural History. He was a man of an active, investigating mind; he had before him a field hitherto altogether unexplored, and in his profession, as well as in these pursuits, he rose to eminence. In the latter part of his life he was knighted, and appointed Physician in Ordinary to King Charles II. He died in 1712. His writings are numerous, as appears by the following list of his works:

- Disputatio Medica de variis Tabis speceibus, Lugduni Batavorum; 1661. 4to.
 Nuncius Scoto Britannus; Edin. 1683. Folio.
 An Account of the Scottish Atlas; Edin. 1683. Folio.
 Scotia Illustrata, sive Prodrromus Historiæ Naturalis, &c. Edin. 1684. Folio.
 Again. 1696. Folio.
 Phalainologia Nova, &c.; Edin. 1692. 4to.; reprinted at the instigation of Pen-
 nant in 1773.
 An Advertisement anent the Xiphias, or Sword Fish, exposed at Edinburgh.
 An Essay concerning the Thule of the Ancients; Edinburgh, 1693. 12mo.
 Camden's Britannia, Additions to edition of 1695. Folio.
 Introductio ad Historiam rerum a Romanis gestarum, &c.; Edin. 1696. Folio.
 Auctarium Musæi Balfourani, e Museo Sibbaldiano, &c.; Edin. 1697. 8vo.
 Memoria Balfouriana, &c. Edin. 1699. 8vo.
 Provision for the Poor in Time of Dearth, &c.; Edin. 1699. 8vo.
 An Advertisement anent a rare sort of Whale come in near Cramond; 1701.
 Coelii Sedulii Scoti poemata sacra ex MSS. &c.; Edin. 1701. 8vo.
 Georgii Sibbaldi, Regulæ bene et salubrita vivendi, &c.; Edin. 1701. 8vo.
 Commentarius in Vitam, G. Buchanani; Edin. 1702. 8vo.
 The Liberty and Independence of the Kingdom and Church of Scotland Asser-
 ted. Three Parts. Edin. 1703. 4to.
 An Answer to the Second Letter to the Lord Bishop of Carlisle, &c.; Edin.
 1704. 8vo.
 In Hippocratis legem et in ejus Epistolam ad Thessalum, &c.; Edin. 1706. 8vo.
 Historical Inquiries concerning the Roman Monuments, &c. in N. B.; Edin.
 1707. Folio.
 The Histories, Ancient and Modern, of the Sheriffdoms of Linlithgow and
 Stirling; Edin. 1710. Folio.
 An Account of the Writers, &c. which treat of N. B. Two Parts. Edin. 1710.
 Folio.
 Miscellanea quædam eruditæ Antiquitatis, &c.; Edin. 1710.
 Vindicæ Prodrromi Historiæ Naturalis Scotiæ; Edin. 1710.
 History, Ancient and Modern, of the Sheriffdoms of Fife and Kinross; Edin.
 1710. Folio.
 Reprinted, Cupar Fife; 1803. 8vo.
 Commentarius in Julii Agricolæ Expeditiones; Edin. 1711. Folio.
 Conjectures concerning the Roman Ports, &c. in the Friths of Forth and Tay;
 Edin. 1711.
 Specimen Glosiarii de Populis et Locis N. B.; Edin. 1711. Folio.
 Series rerum a Romanis, post avocatum Agricolam, &c.; Edin. 1711. Folio.
 Description of the Isles of Orkney and Zetland; Edin. 1611. Folio.

The "Scotia Illustrated," although the labor of twenty years, manifests but a small acquaintance with the natural arrangement of the subject; and it contains many of the errors of system of the older writers. Each general term is not only strictly defined, but each genus and order are traced back to their original cause. Thus we find one chapter, to introduce an account of the Scotch rivers and brooks, headed, "*De aquâ dulci*"—"On Fresh Water," and informing us that "the necessity for fresh water is very great, that both men and wild beasts, and even plants themselves, may drink thereof and be irrigated." Another, the first chapter on animals, is headed, "*De hominum dignitate et præstantiâ*," and includes an account of the creation of man, and his superior worth and dignity in comparison with the inferior orders.

But Sibbald was not only a naturalist, he was a physician by profession; and it was not to be expected that he would omit all mention of a subject to which he had dedicated his life. At that time there was scarcely any production of the earth, the air, or the water, which was not pressed into service. In this respect, and in this department, we are perhaps more deeply indebted to the new and enlightend laws of science, than in any others whatever.

Absurd and ridiculous remedies were still in vogue in the time of Sibbald. In one instance, he recommends the foam of a horse, taken fresh from its mouth, and mixed with oil of roses, as a cure for the ear ache. In another, the liver of a mad dog eaten cooked, as a preservative against the fear of water. Again he prescribes the skin of a mad dog in the same rabid state, prepared with galls and alum, as a preventive against the gout.

We do not think, that *as a science*, Natural History owes much to this work; and it is not only an instance, how little can either be accomplished without *fixed* principles; but also of the many errors into which any one must fall, who for himself neglects to reflect upon his own observations. It is interesting to observe the then medical condition of Scotland, when so few appeared to see for themselves whatever is either beautiful or excellent in the world around them, and to form conclusions from their own experiments and remarks. He who has succeeded in exciting a more general attention to any given subject, has opened the way to improvement. When men are once induced to think, some will both reason correctly, and strike out new ideas. The great

difficulty is to fix their attention, and to give it a particular direction ; this once done, the rest must naturally follow.

On the patronage of the public, the progress of science must necessarily depend. If no one will buy books, none will write them, and where there is no reward, there will be no laborers. If we *as a nation* aspire to eminence in science, and thus to command the respect of the world, we must *as a nation*, cherish every species of scientific investigation, and the talents by which they are sustained.

A nation is but a collection of individuals, and consequently a degree of this responsibility falls upon *each person*, in his own appropriate sphere. The aggregate of grains of sand forms the beach of the sea, and each globule of water contributes to form the resistless wave, that breaks on the shore. It is true that ardent minds, impelled by their own innate energy, will sometimes advance in science without assistance, and that thus talents of a high order and peculiar cast, may force their way into notice, notwithstanding all discouragements and difficulties ; and being wholly dedicated to one subject, will finally achieve great results. Intense desire may produce intense action ; but minds capable of such excitement and energy are rare ; and it cannot be doubted, that had they been encouraged by efficient aid, and warmly cherished by favor, they would have attained still more noble ends. The strength which would carry them successfully through their journey, is spent in overcoming the difficulties that thicken in the early part of the way. But all the various degrees of mental power are necessary in science ; sound and unpretending as well as brilliant minds may be usefully employed. Most men will however, labor only on such subjects as promise them final rewards. Even genius may encounter peculiar discouragements ; and, necessity often directs its efforts to such pursuits as are most in request among mankind. It is probable, that even of those few who have, perseveringly labored against hope, there was not one whose imagination did not hold out to him, however delusively, honor, emolument or posthumous fame, as his exceeding great reward ; nor perhaps could he without this support have continued to struggle with opposing difficulties.

This country is full of active minds, and science commands a portion of them to labor in its cause. The names of Wilson, Bar-

tram, Audubon, Say,* Conrad, Nuttall and many others testify to our successful cultivation of Natural History, and the works which have been published within the last few years in the United States, evince an increasing taste for natural science.†

We now come to a new era in Natural History.

In 1735 LINNÆUS published in Sweden the first edition of his '*Systema Naturæ.*' The great and most obvious improvements which he made, were the introduction of the binomial nomenclature, and the natural classification of all departments of nature,—beginning with man and gradually descending as he could trace similitudes. And here he appears to have had some idea, but which he did not live fully to elucidate, of the circular theory, since brought more clearly into notice by Mr. Mac Leay, Mr. Vigors, and Mr. Swainson, of London.

The discovery of new truths is the peculiar province of an original genius. Linnæus, absorbed in the studies of nature, carefully reviewed all former systems, thus laying his foundations deep; and collecting what he held to be true in each, he then digested, rearranged, modified, and invented, according to one general plan. As the greatest genius is unavailing without strenuous industry, Linnæus labored incessantly either in his closet or in the fields. The grandest as well as the most correct views, are those which have been gained by minute observations, and by the application of all the more precise and accurate methods of study. He regarded all Nature as a grand unity, infinite in detail, but consistent in execution and end; and with Bacon for his guide, he examined each

* The greater part of his library and collections he left, on his death, to the Academy of Natural Sciences in Philadelphia. We are truly glad to find a late English writer speak as follows of this really excellent man: "How few form an adequate idea of that ardent zeal, that untiring energy, that perseverance under the most depressing circumstances, that indefatigable industry in collecting, that laborious accuracy in describing with precision and clearness; and above all, that high moral worth, that kindness of heart and gentleness of disposition, which make Say the object of veneration to all who knew him, and cause his memory to be cherished with fondness by all who had once the happiness of calling him their friend." Doubleday, in *Mag. of Nat. Hist.*, No. xxvii, new series.

† Among the signs of this, which we rejoice to see, may be named the increasing demand in our great cities, and even in our smaller towns, for lectures. "Not, as Dr. Channing justly observes, that these and other like means of instruction, are able of themselves to carry forward the hearer; but they stir up many, who, but for such outward appeals, might have slumbered to the end of life." And they not only do, as we find by experience, impel many on to deeper research, but they are forming an elevated national taste.

species by itself, with the double view of noting its own peculiarities, and its connection with the one great whole.

If, as has been said, he took the first hint of his zoölogical system from Ray, and if he owes to Aristotle and Aldrovandi many of his materials, he yet claims the praise of originally elucidating and fixing the most important principles of nature. What the inventor of the watch owes to the miner, and to the worker in metals, and to him who first observed the elasticity of the steel spring, so much does Linnæus owe to those who preceded him. The material world lay before him, and he made himself its master.

As regards England, his influence was at once perceptible and became ultimately very great. His pupils dispersed themselves over the world to collect specimens, and with their master's science extended both his fame and their own. The Travels of these students were translated, and given to the British public as early as 1771. The *Amœnitates Academicæ** were quickly printed both in Holland and Germany, parts of them, being translated, were published in England. A new interest in Natural History was thus created. It became not only the amusement of men of leisure, but the diligent pursuit of the learned; and Societies and Professorships were everywhere instituted for its promotion. The *Systema Naturæ* now became the universal Text Book, and having been enlarged, although perhaps scarcely improved, by Professor Gmelin, it was used as a basis by contemporary and subsequent writers. In 1778 Linnæus died, having produced a greater and more lasting effect upon the mind of Europe, and having roused in the world with more effectual energy than perhaps any literary man had ever done before or has done since.

From this period we may date the *general* establishment of museums in England.* We do not mean to say there were no museums previous to that period. The first on record was formed about 1650, by John Tradescant, who was either a Fleming

* The following extract from the paper '*Cui bono*,' now rare, contains a fine, and, for those times, a very enlarged view of the subject:—

“ Tandem quoque ex contemplatione rerum creatarum, visuri sumus, quod omnia creata ad nostram utilia sint necessitatem, licet non immediatè, sed sæpè per secundum et tertium. Immò ita, quod maximè nobis nocere putamus, sæpè plurimum nobis expediat. Absque his vita nostra longè nobis difficillima, adeò ut, si cardui et spinæ non crescerent, terra nostra multò esset sterilior, &c.

or a Dutchman, and Gardener to King Charles I, of England. He travelled over a great part of Europe and Asia Minor, and into Barbary, Greece, and Egypt; chiefly with a view of improving himself in natural science. He introduced a considerable number of exotic plants into England, and was the first to prove that they might be rendered useful, and made to thrive by due cultivation. He was followed in his pursuits by his son, John, who inherited the museum, and to which he made considerable additions. On his death it was sold to Mr. Ashmole, "the greatest virtuoso and curioso that was ever known or read of in England." We may form some idea of what it contained from the "*Museum Tradescantianum*," a catalogue of it, published in 1656, and which is divided into the following heads: 1. Birds with eggs. 2. Four footed Beasts. 3. Fish. 4. Shells. 5. Insects. 6. Minerals. 7. Fruits, Drugs, &c. 8. Artificial curiosities. 9. Miscellaneous curiosities. 10. Warlike Instruments. 11. Habits. 12. Utensils and household stuff. 13. Coins. 14. Medals. Isaac Walton likewise makes mention of some of its contents in his *Complete Angler* (part I, chap. I). "I know we Islanders are averse to the belief of these wonders; but there be so many strange creatures to be now seen, many collected by John Tradescant, and others added by my friend, Elias Ashmole, Esq., who now keeps them carefully and methodically arranged at his house at Lambeth, near London, as may get some belief of some of the wonders I mention. I will tell you some of these wonders that you may now see, and not till then believe, unless you think fit. You may see there the Hog-fish, the Dog-fish, the Dolphin, the Coney-fish, the Parrot-fish, the Sword-fish and not only other incredible fish, but you may there see the Salamander; several sorts of Barnacles; of Solan Geese; the Bird of Paradise; such sort of snakes, and such birds' nests, and of so various forms, and so won-

* Reamur, the celebrated French Naturalist, was the first person who formed an extensive collection of animals in France. He was born in 1683 and died in 1757; so that the era of Museums in that country was nearly the same as in England. The well known Brisson, who was the keeper of his Museum, derived from it the principal materials for his work on quadrupeds and birds. These last afterwards constituted the basis of the Royal Museum at Paris. The earliest considerable Museum in this country owes its origin to the late Mr. Peale of Philadelphia. In this museum was first seen a complete skeleton of the mastodon. Many of Wilson's birds, and not a few of the animals procured in the Rocky Mountains, being also there, it has become classical from the frequent reference to these and other specimens.

derfully made, as may beget wonder and amazement in any beholder," &c. The Dodo was preserved in this collection. Mr. Ashmole presented the whole to the University of Oxford, where it still remains; and it has of late been much enlarged by the munificence of its present Curator, Mr. Duncan.

The next collection was Dr. Woodward's, which became the foundation of Sir Hans Sloane's; and the whole was purchased, in 1753, by the British Parliament, and is now known as the British Museum. Another collection, once much celebrated, was that in possession of Sir Ashton Lever,* who died in 1788, and which was sold by auction in lots, and dispersed in 1806.

But still museums were very far from being common or popular in any part of Europe. London was, at the period we refer to, as now, a place of general resort for scientific men, and a large number of such persons were collected there. The celebrated Bishop Horsley, the learned and able antagonist of Dr. Priestley, was an active member of the Royal Society. Sir Joseph Banks, possessing the advantages not only of great abilities, but of fortune and a high station in society, constantly exerted himself in this cause. He and his friends, convinced that without extensive collections it is very difficult, if not altogether impossible, to make any great progress in Natural History, were diligently employed in forming Societies, and in collecting specimens for examination from different countries. The eminent men of that day, likewise deeply felt the importance of bringing together those who pursue the same studies, and they understood that, especially in physics, union is power; that the first thoughts and more transient discoveries of individuals, made known to a circle of scientific friends, may, and often do, both save the labor of many, and draw out the energies of many more, and that particular subjects being allotted to different observers, on the principle of the division of labor, the examinations are more exact and availing. The Royal Society had already proved the advantages of such meetings. We owe very much to the publication of their '*Transactions*,' in which, each contributing a little, where otherwise none would have contributed at all, the result is an immense mass of facts, thoughts, and experiments. And indeed the British Association for the Ad-

* For a notice of this museum, see *Journal of Travels in England, &c.* 1805-6. Vol. I, by B. Silliman.

vancement of Science may be said to be but the carrying out of this principle on a grander and more enlightened scale.*

In this country much has been done both in forming scientific and popular museums and societies. It must, however, be allowed that few of our societies are efficient, and too many exist only in name; but the Philosophical Society, the Academy of Natural Sciences, of Philadelphia; the Lyceum of Natural History, of New York; similar institutions in Baltimore and Charleston; the American Academy, and the Natural History Society, of Boston; the Institute, of Albany; the young Natural History Societies of Salem† and Yale College; and a still more youthful Society in Harvard University, evince that all are not asleep, or in a state of suspended animation. Several of these institutions have valuable collections, most of which are rapidly increasing. Among the most distinguished, are those of the Academy of Sciences and the Franklin Institute, of Philadelphia; of the Lyceum of New York, and the Natural History Society, of Boston.

Among our popular Museums are several of great merit in our principal cities, at the head of which is deservedly placed the fine museum of the late venerable Peale—with its colonies in other cities,—and several others, in all our larger towns.

Our living Naturalists are numerous. Audubon, Nuttall, Harlan, Morton, and Torrey are not without coadjutors, and it would require a long catalogue to enumerate them all. The early publication of Wilson's Ornithology, with its continuation in later years, and of Holbrook's Herpetology, still going on, affords sufficient proof that this country is alive to the claims of Natural History.

The next great writer upon British Zoölogy is THOMAS PENNANT. We should wish to depict Pennant's character as that of

* Among the earlier collections formed in England, the Wyckliffe Museum may be particularly noticed as one much celebrated in its day. It was formed and owned by Marmaduke Tunstall, an independent gentleman, of old family, at Wickliffe, in Yorkshire. He was the friend and correspondent of the greatest naturalists of the day. To this collection the writers of those times owe much; and from unique specimens contained in it, Edwards, Brown, Pennant, Latham, and Bewick, illustrated their works. At his death it was sold; and having passed through the hands of Mr. Alian, of Darlington, in the county of Durham, it became in 1822 the foundation of the excellent collection in Newcastle upon Tyne, where it still remains.

† The East India Museum of Salem is an unique and most interesting collection; and the Chinese Museum at Philadelphia, although having little relation to science, is rich beyond all example, in illustrations of China.

a man, a father, and a Christian, (for as such he appears eminently to have fulfilled his duties,) rather than as merely a literary and scientific person; but unfortunately our materials are very scanty. The chief source from which all the biographies of Pennant have been drawn, is a work which was published by him in 1793, under the fanciful idea of writing after his death, '*The Literary Life of the LATE Thomas Pennant*;' and which contains a few circumstances of his private life, and peculiarly shows the bent and tone of his mind.

He was born in 1726 at Downing, in Wales. His family was old and respectable, possessing some landed property, and having for some generations held honorable situations under Government. He appears to have been an only child. When properly prepared, and at the usual age, he entered Queen's College, Oxford; but afterwards he changed to Oriel, and on taking his degree, assumed the law gown. He is here described as conspicuous for his general intelligence, and for the progress he made in classical knowledge. But his taste for Natural History was formed at a very early period, and long before he was able to indulge it to the extent which he afterwards did. It is, indeed, not uncommon that those who, when young, have evinced a taste for this science, neglect it altogether in after life; their feelings being, in this respect, like those of children pleased with the first sight of a beautiful object. It is extremely rare that a person who has neglected this study in youth, becomes fond of it in after years. Pennant says, "a present of the Ornithology of Francis Willoughby, when I was about twelve years of age, by my kinsman, John Salisbury (father of Mrs. Piozzi, known as the Biographer of Dr. Johnson,) first gave me a taste for that study, and incidentally a love for Natural History in general, which I have since pursued with my constitutional ardor."

On leaving college he probably returned to his home, and there pursued his studies in the law. In these, however, he never made much progress. His station in life was one which is, perhaps of all others, the least adapted for nourishing common ambition, or for stirring up a person to diligence in the business of life. It was a saying of the late Lord Eldon, that if a man be desirous of rising to eminence in the legal profession, he should be dependent solely upon his own endeavors for a maintenance. Now the contrary was exactly Pennant's case. He knew that he

should inherit a handsome property on his father's death ; and in the mean time his allowance was such, that while it afforded him a comfortable competence, it prevented his indulging in luxuries ; or seeking, in a more expensive sphere, for a higher standard of mind and action. The law he never practiced ; and a few years after leaving college, he married, and settled down as a quiet country gentleman. It was not till he was about forty years of age, that he came into possession of his patrimony. His mind however, was naturally active ; and he was constantly employed in laying a foundation, in other studies, for his future eminence in the walks of natural science. Intimate social intercourse he appears particularly to have enjoyed. He was far from shutting himself out from the society of his friends ; he mixed freely with such as his neighborhood afforded ; and with the marked politeness of the old school of manners, he highly relished the company of the fair sex. He has left a few sonnets of his own composing, which he addressed to particular ladies ; and while the verse is neither very polished, nor manifests much study or care, the whole is marked by a pleasing playfulness of fancy ; an enlightened conception of the beauties of nature, (the constituents of poetry,) and a high moral delicacy. During this time, his attention seems to have been turned to the practical and economical uses of natural science ; and he thus refers to the subject in his preface to *British Zoology* ;—" At a time when the study of natural history seems to revive in Europe, and the pens of several illustrious foreigners have been employed in enumerating the productions of their respective countries, we are unwilling that our island should remain insensible to its peculiar advantages ; we are desirous of diverting the astonishment of our countrymen at the gifts of nature bestowed on other kingdoms, to a contemplation of those which (at least with equal bounty) she has enriched our own. Why then should we neglect inquiring into the various benefits that result from these instances of the wisdom of our Creator, which his divine munificence has so liberally and so munificently placed before us ?"*

* The study of the *economical uses* of natural history has been, hitherto, very little cultivated, and requires more general attention. As a true science it has, of course, an *art* in natural connection with it ; and the full elucidation of this art is still wanting. The most obvious application of it is to agriculture, taking the word in its widest sense ; but there is scarcely a physical subject of ordinary occurrence which might not be more or less indebted to it. The distribution of

Previous to 1757, his only publications of consequence were two papers in the Philosophical Transactions. In that year, Linnæus seeing one of the productions, was so much pleased with it as to procure his election as a member of the Royal Society of Upsal; an honor which appears to have had its appropriate effect upon his mind, in stirring him up to still greater endeavors; and this is indeed, the principal benefit of such literary distinctions. In 1761, being then thirty-five years of age, he began his first great work on *British Zoology*. It was published in folio at his own cost, and contained one hundred and thirty-two plates.

shell-fish and other animals, of reptiles, and insects; the various important duties which they perform in the economy of the world; and the possibility of procuring their assistance, or avoiding their ravages, are all subjects which have been very slightly investigated. As a singular instance in point, we may mention the cultivation of figs in the island of Malta: "The peculiar process in the treatment of this fruit, is worthy of remark; and the necessity of its adoption in some countries, to the exclusion of others, is a subject which the curious may find interesting to determine. Where the figs are advancing towards maturity, in order to prevent their falling off, and to hasten their ripening, a cluster of male figs is suspended upon the branches of the female tree, by means of a plant, (*Ammi majus*), which effectually secures them from the danger, and soon effects the desired end. Many small winged insects are generally found in the male fruit upon opening it. The most rational way for accounting for this effect is, that these small flies, entering into the male fig, yet clothed with the pollen with which the stamina on the inside are covered, and carrying it with them into the female fig, produce that natural coalition which is necessary for the effectual generation of the fruit." Again, the production of cattle and birds for food, is a portion of the *art* of natural history, and requires farther study. A society, which promises to be successful in its results, has lately been established in London, on this principle, for the introduction in the poultry yards of various animals and birds which have hitherto been neglected. Again, much improvement in some branches of mechanics might be expected from an accurate investigation of this subject. The writer contributed a few years since, an anonymous article to this Journal, (Vol, xxxii, pp. 73, 235,) on the "*Economical uses of some species of Testacea*," with the view of showing that even in a branch generally supposed to be least capable of any practical benefit, this principle might be much extended, and greatly carried out; and if so, that then in others, universally confessed to be more capable of it, it need not to be neglected for fear of failure. Natural science is, still, too little considered as a *whole*. It cannot be said by any means yet to have arrived at its climax; but when it is perfected, it will, it appears to us, combine in one grand circle, natural systematical arrangement, founded on anatomical distinction; a minute description of the generic, individual and social habits of each species; a knowledge of the uses to which they may be made available; the purposes of their creation, and the place which each holds in the great chain of nature; a vast mass of materials has been indeed collected; but much is still wanting to finish so great a work. Nature is still viewed not as a whole, but only limb by limb; and the next great marked improvement in this science, will probably be the conjunction of the different parts into one general intimate union; and the combination of the science with the art.

The profits of it he had dedicated to a Welsh charity school in London, of which he was the patron; but the expense of the undertaking was so great, and the sale comparatively so limited, that he lost considerably by the work. As the editions were multiplied he added to it, and improved it; and it was afterwards published in octavo with profit. The first one hundred pounds that he realized from it, he presented to the school. Two years after this, his wife, to whom he appears to have been much attached, and of whom he speaks in the warmest terms of affection, died; leaving him two young children; and to relieve his mind from the grief natural to such an event, he paid a visit to the continent.

We may imagine with what pleasure Pennant, with a mind constituted as his was, found himself surrounded by the great naturalists and literati of his day. Among them he visited, and became intimate with Buffon, Voltaire, Baron Haller, the two Gesners, and Dr. Pallas. The intimacy thus formed, with Pallas, continued through life; their correspondence was frequent; and Pennant tells us that to this gentleman he owed the first hint of his *Synopsis of British quadrupeds*. But Buffon was then the most noted naturalist in that part of the continent; and naturally therefore, the person in whom Pennant felt the greatest personal interest. He spent a week with him at his country residence. Buffon was born in 1707, of a noble family, and at an early age inherited a large property. He dedicated his life to the pursuit of science. In 1749 he began to publish his "*Histoire naturelle*," and completed it in 1767. He died about 1780. His talents were original, and of high order; and by the beauty and eloquence of his style, the earnestness with which he insisted upon the advantages of this study; and the magnificence of his published works, he attracted great attention to the science. As a *practical* naturalist, he was, however, exceedingly deficient. He depended in a great measure upon the information afforded by others; and like Goldsmith, in a somewhat similar undertaking, his brilliant imagination worked this up into an interesting and most popular book. He pursued no regular system, although he had his own peculiar views. Whether he already saw the danger which was likely to arise from too servile an adherence to Linnæus; or whether it was owing to a want of sufficient knowledge of scientific detail; and an affected independence of mind, he merely grouped his

subjects according to a coarse, outward resemblance ; and ridiculed a more accurate system of classification.

The mind of man is ever more inclined to follow some one leader, and to lean upon the labors of others, than to strike out truths for itself. Thus it has always happened, that a fondness for certain popular systems has chained down the general intellect to one point. Buffon perceiving the popularity of the writings of Linnæus, foreseeing to what it would lead, and endeavoring to avert this evil, in this way rushed into the contrary extreme ; he thus discarded all system but what *he* chose to call the natural one, “ *ne seroit—il pas,*” says he, “ *plus naturel, et plus vrai de dire qu’un âne est un âne, et un chat, un chat que de vouloir, sans savoir pourquoi, qu’un âne soit un cheval, et un chat un loup—cervier ?*”

On Pennant’s return home in 1767, he was elected a fellow of the Royal Society ; and in 1768, we find him engaged in publishing a second edition of his British Zoology. Like Ray, he was, throughout life, celebrated for his frequent tours through Great Britain, accounts of which he published from time to time. His object in these journeys was to study natural history in the different parts of the country ; but he paid attention to every thing of interest ; and especially to antiquities. In 1770 he visited Scotland, with the condition of which, strange as it may seem at the present day, the English were then almost unacquainted. “ I had the hardiness,” says he, “ to venture on a journey to the remotest part of North Britain, a country almost as little known to its southern brothers as Kamtschatka. I brought home a favorable account of the land. Whether it will thank me or not, I cannot say, but from the report I made, and showing that it might be visited with safety, it has ever since been *inondée* with southern visitors.” In 1772, he made another visit to that country, and went as far as the Hebrides. His only companion in these journeys was a self taught artist, whom he supported, and who illustrated his different works with views, engraved in a very excellent style. Besides these trips to Scotland, he visited Ireland, as well as the north of England and Wales, and published an account of the Topography of London. All these tours he performed on horseback ; a mode of travelling to which he attributed the excellent health which he enjoyed through life. By thus moving about, he acquired much information for his va-

rious works; and he discovered many novelties, which perhaps were novelties only, because no one had hitherto taken the trouble to look for them. Since his day, England has been diligently explored, and he is fortunate who succeeds in discovering there any thing new. In this country there is altogether as good a field, if not better, for original discovery, as Pennant enjoyed; and the experience of our travelling naturalists and of the scientific and exploring expeditions proves sufficiently, that he who takes the trouble of observing, will be fully rewarded for his pains. The accounts which Pennant published of these tours, are perhaps the most instructive and interesting of the kind which we possess.

It is a common remark, that the climates of both Europe and America are gradually changing. To decide whether this is the case or not, or whether the difference arises only from a higher state of cultivation, is a work of great difficulty. The data on which to proceed, are in a great measure wanting. Well conducted meteorological observations, although we now have some of great value, have not been recorded in numerous places and for a sufficient length of time, to form the basis of general conclusions; and without some such certain and well known experiments, from which sound deductions may be drawn, it is not possible to arrive at any satisfactory opinion.

It is a circumstance worthy of observation, that both in the United States, and in Great Britain, many birds appear to have changed their habitations within the last one hundred years. In his first tour to Scotland, Pennant visited the Fern Islands, a group of barren rocks off the Coast of Northumberland, and there found the little Auk, (*Mergulus alle*, Selby,) and the Black Guillemot, (*Uria Grylle*, Lath,) not unfrequent; while, according to Mr. Selby, the first does not now occur at all, and the latter is only occasionally met with in that location. Another instance is that of the Crane, (*Grus cinerea*, Bechst,) which, according to Ray, was in his time found, in some counties, in large flocks, but which now ranks among the rare visitors. Others again, once scarce, have taken their places, and become comparatively common; among which we may particularly remark, as of very recent date, the Honey Buzzard, (*Buteo Apivorus*, Ray.) A long list of such changes might be given. We must now revert a few years, to trace Pennant's literary labors.

In 1769, he published a volume on British fishes; and in the same year he began a work on *Indian Zoology*, which however, proceeded only to twelve plates, and was afterwards republished in Saxony. Of this he observes:—"my mind was always in a progressive state; it could never stagnate; this carried me further than the limits of my own Islands; and made me desirous of forming a zoology of some distant country, with which I might relieve my pen by the pleasure and variety of the subjects." In 1770, he was elected a Fellow of the Royal Academy of Drontheim. In 1771, the honorary degree of doctor of law, was conferred upon him by the University of Oxford. About this period, he married a second wife; the fortune he now possessed, allowed him to indulge his natural taste for hospitality; and being thus comfortably settled, he entirely lost, as he informs us, his desire of rambling. In 1785, appeared his great work on the "*Arctic Zoology*"; which was shortly after translated both into German and French. He was now elected a member of the American Philosophical Society of Philadelphia, an attention which was peculiarly gratifying to him; and he observes on the occasion, that "there science of every kind began to flourish, and among others of natural history."

From this time he continued to print other occasional works; among them a pamphlet entitled, '*American Annals; an incitement to Parliament men to inquire into the conduct of the commanders in the American war*;' and he was now much engaged in his duties as a magistrate and a landlord. His health continued good till within two years of his death, when, in 1798, he quietly sank into the grave at the age of seventy-two. In person he was rather above the middle height, well proportioned, and somewhat inclined, in the latter part of his life, to corpulency. His complexion was fair; and his countenance peculiarly open and benignant.

While many may stand higher in general estimation for their genius and abilities, few surpass Pennant in his unceasing industry and his continual endeavors to be useful to his fellow men. Mild and amiable in temper he avoided politics as far as he could, in an age peculiarly subject to political excitement; and this, refined a disposition originally tender and gracious. He fulfilled his domestic duties in a manner truly exemplary; and his writings abound in passages which prove that he never forgot his con-

stant dependence upon his Creator. The distresses in which his poor neighbors were involved, gave him unfeigned uneasiness; and he endeavored to relieve them by every means in his power. His name was long remembered by them with love and respect. But we cannot do better than to let him speak for himself, as regards his occupations and character. "I still haunt the bench of justices (1793). I am now active in hastening levies of our generous Britons into the field. However unequal, I still retain the same zeal in the services of my country, and have grown indignant at injuries offered to my native land; or have incited a vigorous defence against the lunatic designs of enthusiastic tyranny, or the presumptuous plans of fanatical atheists to spread their reign or force their tenets on the contented moral part of their fellow creatures." "I am often astonished at the multiplicity of my publications, especially when I reflect on the various duties which it has fallen to my lot to discharge, as a father of a family, landlord of a small but very numerous tenantry, and not an inactive magistrate. I had a great share of health during the literary part of my days: much of this was owing to the riding exercise of my extensive tours, to my manner of living, and to my temperance. I go to rest at ten; and rise, summer and winter, at seven; and shave regularly at the same hour. I avoid the meal of excess—a supper; and my soul rises with vigor to its employments, and I hope does not disappoint the end of its Creator." "Thus far has passed my active life, even to the present year, 1792, in which I have passed half way of my sixty-seventh year. My body may have abated its wonted vigor, but my mind still retains its wonted power, its longing for improvements, its wish to receive new lights through chinks which nature has made."

In his zoölogical works he includes the whole of the British vertebrated animals—*testacea*, *crustacea*, &c. His arrangement is founded upon that of Linnæus; but he occasionally alters his plan to that which seemed to him better adapted to the subject. Instead of confining himself to mere description and classification, which was a prominent fault in previous works on natural history, and one which has not been avoided by succeeding British Naturalists, he, as far as he is able, both introduces notices of habits and manners, and indulges in detail. His writings are still considered as standard works, and are still constantly referred to and quoted. In some departments, very little has since been added,

but of course in the more intricate subjects we can scarcely expect to find him perfect. The plates are numerous, and executed with great fidelity. Those of the Testacea have seldom been surpassed. From his life we may learn that the busiest station does not preclude attention to this study; and while it relieves and graces narrow circumstances, it adds increased lustre and honor to the highest stations.

The British Conchologists of this period were EMANUEL MENDES DA COSTA, who published at London, in 1778, a very beautifully executed quarto volume under the title of '*Historia naturalis Testaceorum Britannicæ; or the British Conchology, containing the descriptions, and other particulars of the Natural History of Great Britain and Ireland.*' The plates are very faithful, and are colored. The text is both in French and English. His system was peculiar to himself, and has never been adopted. It was in conformity to a system which he had proposed shortly before in a thin octavo volume, called '*Elements of Conchology.*' His work is still often referred to for the plates.

The other writer, who is less generally known, is WALKER, who published a volume in 1784, on the intricate subject of the minute British Shells. '*Testacea minuta rariora.*'

Ten years before Pennant's death, in 1788, appears the first edition of REV. GILBERT WHITE'S '*Natural History and Antiquities of Selborne;*' a work which ever has been, and ever will be, read with pleasure. Born in 1720, at Selborne, a little country village, the surrounding scenery diversified with hills and woods, he passed through the ordinary routine of education; and in due time became a Fellow of Oriel College, Oxford; and one of the Senior Proctors of the University. "Being of an unambitious temper, and strongly attached to the charms of rural scenery, he early fixed his residence in his native village, where he spent the greater part of his life in literary occupation, and especially of the study of Nature. This he followed with patient assiduity, and a mind ever open to the lessons of piety and benevolence which such a study is so well calculated to afford. Though several occasions offered of settling upon a college living, he could never persuade himself to quit his beloved spot, which was indeed a peculiarly happy situation for an observer. He was much esteemed by a select society of intelligent and worthy friends, to whom he paid

occasional visits. Thus his days passed tranquil and serene, with scarcely any other vicissitude than those of the seasons, till they closed at a mature age, on the 26th June, 1793." His work, consisting of letters addressed to Mr. Pennant, and which, in the original edition, is a thick quarto volume, illustrated with plates, is a singular instance how much may be effected in a very small sphere by a joint habit of observation, and of noting down every thing as it occurs. We lose constantly many interesting particulars, from neglecting to make a memorandum of them at the time; they may at the moment appear to be of very slight importance, but each year will add to their value, and each separate circumstance connects the foregoing with some general principles. He who tries this plan is soon surprised to discover what a large mass of curious information he brings together. It is the foundation of the success of fictitious writings, that human nature, depicted exactly as it is,—the manners and sayings either of individuals or great classes of men, faithfully recorded—always prove highly interesting and popular. This, if the description be but graphic and faithful, is equally true as regards the habits and instincts of the inferior creatures; and what White did, all persons of any literary taste are equally capable of accomplishing. As a clergyman, confined to his parish, which he seldom appears to have left, and diligently engaged in his duties, the only time in which he could indulge this taste, was during the hours of relaxation and exercise; and having once attained the habit of daily making notes, the time required for doing so was very little and such as every one has at his disposal. It is to such observations, rather than from the labors of professed naturalists, that for the present at least, we must look for the progress of natural history in this country. We must depend upon individual effort for combined results; and it is an encouragement that one need not be an accomplished naturalist, or one by profession, in order to make useful observations. Pennant, in a short essay attached to his zoölogy, has particularly pressed the attention of clergymen to this study. There certainly is no reason why they should neglect, and there are many cogent reasons why they should cultivate it. Country clergymen often enjoy many facilities for its successful prosecution; while classical knowledge and literary habits render them peculiarly fit for making discoveries and

improvements. It falls in very happily with their professional knowledge. The mysteries of the creation of God, as well as his attributes, and his government of the world in his dispensations to man, it is their duty to study and to exemplify; but while they confine themselves to the revealed word alone, they shut out of sight a volume which speaks not less forcibly of the love and excellencies of the Creator, and of his mighty wisdom and perfections. There is no reason why persons of this profession should be less sensible to, or less well informed in regard to physical objects, than the other educated classes of society, but rather the contrary; and the greater their knowledge is, the greater likewise will be their capabilities of fulfilling the end of their lives. The Jesuits,* whose system of education is perhaps, as a means, one of the very best adapted for producing the required results, are very far from neglecting the study of these subjects; and they have exemplified in practice, what the good George Herbert has asserted in theory, that “the country parson is full of all knowledge. They say it is an ill mason that refuseth any stone: and there is no knowledge but in a skilful hand,—serves either positively as it is, or else to illustrate some other knowledge. He condescends even to the knowledge of tillage and pasturage, and makes great use of them in teaching, because people, by what they understand, are best led to what they understand not.”†

Some of the greatest living naturalists of Great Britain are clergyman, among whom we may mention Dr. John Fleming, minister of Flisk, Fifeshire, Rev. Leonard Jenyns, and Professors Buckland and Sedgwick, to whom Geology owes much of its present eminence.

The following extracts from White’s original preface, are not unworthy of repetition:—

“The author is also of opinion that if stationary men would pay some attention to the districts in which they reside, and would publish their thoughts on the objects which surround them, from such materials might be drawn the most complete county

* “Sic etiam quoniam artes, vel *Scientiæ Naturales* ingenia disponunt ad Theologiam, et ad perfectam cognitionem et usum illius inserviant, et per seipsas ad eundem finem juvant; qua diligentia par est, et per eruditos Præceptores, in omnibus sincere honorem et gloriam Dei quærendo, tractentur.”

Constitutiones Societatis Jesu. 1558. Pars 4. Cap. XII. § 3.

† “A Priest in the Temple.” Chap. IV.

histories which are still wanting in several parts of this country.”*
 “If the writer should at all appear to have induced any one of his readers to pay a more ready attention to the wonders of creation, too frequently overlooked as common occurrences; or if he should, by any means, have lent a helping hand towards the boundaries of historical and topographical knowledge, his purpose will be fully answered. But if he should not have been successful in any of his intentions, yet there remains the consolation behind, that these pursuits, by keeping the body and mind employed, contributed to much health and cheerfulness of spirit, even to old age.”

But while writers were thus arising on all sides, and were diligently employed in illustrating the zoölogy of their own country, this science could not yet be said to have become, in the proper sense of the word, *popular*. Illustrated books are peculiarly necessary in the pursuit of this study. Such were still expensive, and difficult of attainment. The works of Linnæus were still concealed in the Latin tongue; and the majority, those for whom such a refining study is chiefly to be desired, were thus shut out from the most efficient means of acquiring a philosophical knowledge of the subject. This difficulty was now to be removed.

In 1790, THOMAS BEWICK first appeared conspicuously before the public, both as a naturalist, and the reviver of the art of engraving on wood; and we may justly be allowed to consider the publication of his works as an era in this science, so far as it rendered the subject more easily available to the mass of the people. In this year came out the first edition of his ‘*General History of Quadrupeds*’; a book which went through nine editions before the year 1824. Although he does not confine himself to British animals, he gives, with his usual accuracy of delineation, engravings of all the species which were then known. The improvement, however, which he afterwards made in his art, will be readily observed by those who compare his earlier style in this work, with the softness and spirit which characterize his birds in the later editions. Thomas Bewick was born in 1753, at Cherryburn, in Northumberland. His parents were far from being in

* The intelligence, accuracy, and fullness of Sir John Sinclair’s great work, ‘*The Statistical History of Scotland*,’ are well known. It was formed on this principle, and the account of each parish and district contributed by its respective minister.

affluence, and moved in a humble although respectable station of life. At an early age he was sent to a dame's school, and he afterwards completed his English education under a better instructor. Here he strongly manifested his love for the picturesque, and his taste for drawing. So evident, indeed, were those traits of character, that his father was induced to bind him, at the age of fourteen, an apprentice to a copper-plate engraver, at Newcastle upon Tyne. Of this part of his life nothing particular is known, except his dislike to his business, which was chiefly the coarse and dirty work of cutting brass dial-faces for clocks; but he appears to have worked industriously, and to have been steady and diligent in his habits. In 1770 he first proved his talents for wood-engraving, while his employer was engaged in executing the cuts for *Hutton's Mensuration*. The mathematical diagrams requiring greater correctness than could be attained by the use of the ordinary chisel, he invented a double-edged instrument which answered every purpose in making a very fine and straight line. His attention once turned in this direction, he made rapid progress. Till 1787 he was employed in illustrating some volumes of fables, and other small books; and, as in such works, birds and animals were the frequent subjects of his graver, he acquired an excellent accuracy in their delineation. By degrees he improved. With this progress he made new experiments and inventions, and with the growing facility of execution, his mind was daily more fixed upon his subject.

In 1786 he was married; and in 1789 he published his celebrated print of the Chillingham wild Bull, the largest and most highly finished wood engraving which he ever executed.

In 1790 he published, as we have said, his work on quadrupeds; and in 1797, after nearly six years of constant labor, the first volume of his '*British Birds*,' appeared. After the lapse of nearly a similar period, in 1804, the second volume, that on water birds, was presented to the public—the whole term proving, if any proof were wanting, his great perseverance, and that the work was not hastily nor crudely executed. The book went through six editions before 1826. The Wycliffe or Tunstall Museum, of which we have already made mention, was the occasion of this popular work; for Mr. Tunstall perceiving Bewick's great abilities as an engraver, first proposed the subject to him, and offered him all the facilities of which he afterwards made use. While this gentleman lived he was the constant and liberal patron of Bewick.

From this time he was chiefly occupied in adding to, improving, and carrying through the press the various editions of his works on natural history; but he likewise found time to illustrate many smaller and less popular books for the publishers.

He died in 1823, at the age of seventy-five. His character as a naturalist cannot be rated very high. Nearly all that he knew of natural history he derived from the observation of others; and his education had not been such as to prepare his mind for pursuing the subject philosophically. He possessed a strong love for nature, but he expended it, in a great measure, on drawing and engraving the dead specimens. We owe but few original remarks to his works. For the greater part of his life he resided in Gateshead, the suburb of Newcastle upon Tyne, and consequently he had fewer opportunities of personal investigation, than if his life had been passed in the country.

In appearance and character he was not unlike the celebrated Dr. Johnson. Large and uncouth in person, unpolished in his manners, and, at times unpleasantly rough in his demeanor; he was yet possessed of strong good sense; much perseverance and ingenuity; and in all his actions and all he said, there were apparent a sterling warm-heartedness, and a talent for wit and humor which could not fail to please. "When animated in conversation, and he was seldom otherwise, his eye was peculiarly fine, and imparted a vivacity to his countenance very difficult to describe or forget. There was more of intelligent benevolence and candor in it, than I ever saw in another; but it was mixed with an earnest gravity, almost bordering on severity when speaking in disapproval; and with the brightest animation, when discussing the beauties and wonders of nature, or subjects of equal interest. His humanity was very extensive, cherishing continually some scheme for the improvement of his fellow creatures, or the better treatment of the animals intrusted to them. His language was extremely forcible; and the words he made use of, those calculated in the plainest and most familiar manner to convey his meaning; but unfortunately this love of *simplicity*, oftentimes led to a degree of coarseness which no one could hear without reprobating."* His dialect was broad Northumbrian.

* Mr. George Atkinson, in the *Transactions of the Natural History Society of Newcastle upon Tyne and Durham*.

He mixed a rough, sound good sense, and some times an originality of remark in his conversation, which always rendered what he said interesting. His pleasantries were less remarkable for true wit and delicacy, than for the union of strong sense and honest merriment.

His engravings are distinguished by their extreme fidelity, and for the truth with which he has caught and transferred to paper the peculiar air and habit of his subject; while he reduced it from its natural size to a small wood cut. But his improvements in the art of cheap and correct engraving, have had a much more extensive influence than in natural history. Those who may remember, or have seen the books put into the hands of children during the last century, will perceive how much, in the present day, this all-important class of books owes to Bewick; and how the distorted representations of nature, have given place to correct and graceful figures; and those who reflect upon the variety of subjects which now owe their illustrations to the art, will feel inclined to give Bewick the credit of being truly a benefactor of mankind. He left several children. One of his sons is now an artist of no small ability.

In 1800 appeared TURTON's translation of Gmelin's edition of the *Systema Naturæ* of Linnæus. This work is printed in seven thick octavo volumes; but at a comparatively low price; and although it is now fallen both in value and estimation, yet at the time it did great good in opening the science to the mere English reader. It has been accused, and justly, of faults, both derived from Gmelin, and from its own author. Varieties are given as species, synonyms as distinct species, and hypothetical and fabulous animals are occasionally obtruded as existing. Too much dependence was placed upon preceding writers. But considering the vastness of the work; the difficulties to be encountered; and the doubt which hung over many parts of it, it is well executed. It is now of value only to the historian of science, the annalist, or the professed system maker; being as faithful a record of the errors, as of the real science of its period.

WILLIAM TURTON, M. D., was through life, a zealous naturalist; and besides this book, he published some smaller volumes on conchology. His favorite pursuit was the investigation of British shells. His industry and perseverance were great; but his circumstances being narrow, and he not possessing much originality

of thought, he was unable to take a high stand in the scientific world. He died in Cornwall, where he had chiefly resided, about 1834, at an advanced age.

In 1802, appeared the "*Ornithological Dictionary*," of that most industrious observer and writer, Col. GEORGE MONTAGUE, of Knoule House, Devonshire. We have in vain searched for any biographical notice or memoir of him; and it is much to be desired, if materials exist, that some account of his active and scientific life might be given to the public. This work is only upon *British birds*; and the plan is well adapted for reference, as he threw his materials into the form of an alphabetical catalogue. He presents much original information, the greater part of which he collected himself. His object was to render the subject popular; and he appears to have written expressly for "such as might wade through columns, before they could find the object of their inquiry, but who are desirous of being better acquainted with the most beautiful part of the animal creation." He corresponded with the most eminent naturalists of his day. He was the first to observe, as *British*, several birds which had previously been overlooked; among which we remark the *Macroramphus griseus*,* (*Leach.*) of the United States and the *Ardea lentiginosa*, (*Mont.*) which naturalists have hitherto been in the habit of considering the *Ardea minor*, (*Wils.*) likewise of this country.

In 1813, Montague published a supplement to his dictionary, which is nearly as large as the original book. But his great work was that on British conchology, "*Testacea Britannica, or natural history of British shells, marine, land, and fresh water, including the minute, &c.*" a quarto volume of upwards of six hundred pages, and published in London, in 1803. This is an invaluable work. As a describer of shells, he probably stands at the head of English writers on the subject; and his book is still unsurpassed. He spared neither pains nor expense in procuring specimens; and he was enabled both to add many new species, and clearly to distinguish between such as had hitherto been considered merely as varieties. In 1808, he published a supplement, in which many new species are given. He follows in general, the Linnæan arrangement, but has made one new

* *Scolopax Novoborocensis*, (*Wils.*)—Eds.

genus, (*Balanus*,) and followed Pennant in some cases in preference.

The only other work of which he appears to have been the author, is entitled, "*The Sportsman's Dictionary, or Tractate on Gunpowder*," which we have never seen. His collection of shells, is, we believe, now deposited in the British Museum of London.

In 1804, appeared the "*Natural History of British shells, including figures and descriptions of all the species hitherto discovered in Great Britain, systematically arranged in the Linnæan manner, with scientific and general observations on each*," by E. DONOVAN, in five octavo volumes. This is a beautiful work, and was among the first of the kind which was issued in periodical numbers. The figures are the size of life, well engraved on copper, and faithfully colored. The letter press is, however, of comparatively small value; and the volumes are chiefly referred to at present, for the plates. He describes in all, two hundred and nineteen species.*

Shortly after, in 1808, there followed by the same author, "*The Natural History of British fishes, including scientific and general descriptions of the most interesting species, &c.*" This work is likewise in five octavo volumes; and as he appears to have limited it to that number, he excluded many of the commoner species. The figures are one hundred and ten in all, whereas it is ascertained that *two hundred and twenty-six* exist in the British seas and rivers. The work is beautifully executed, and the same remarks as are made on the above may apply to this.

* The researches of Lea, Conrad, Say, Totten, Morton, Vanuxem, Binney, Couthouy, Kirtland, Ward, Hildreth and others, in relation to our recent and fossil conchology, have disclosed most interesting treasures, and we highly appreciate their labors: while it is still much to be desired, that some general work on the conchology of this country were published; were it but a list of what has already been described, with references to the periodical works in which the descriptions may be found. As it is, the student is without a guide to American conchology. A great variety of transactions and journals must be searched through, to collect the scattered fragments, and as this is in the power of very few, an insurmountable barrier is thrown in the way of farther improvement. Upwards of 600 species, have, we believe, been described as belonging to the United States; the number might, we well know, be greatly increased; but from want of an acquaintance with what has hitherto been noted, every student is at a loss whether to consider the species he may find as new, or at present known. Would not such a work be patronized?

From this period, for several years, we have no great work especially dedicated to *British Zoology*. In 1815, Lamarck, by the publication in Paris, of his *Histoire naturelle des animaux sans vertèbres*, created a new interest in this study, and placed conchology on a new basis; one, however, of which Lister previously appears to have seen the propriety. In 1817, appeared, likewise in Paris, Cuvier's *Regne Animal*. So strong a hold, however, had the system of Linnæus taken on the minds of the British naturalists, that neither of these great works was as cordially received as they ought to have been; and it has required some years fully to attract attention to them; and to show the effect which they have produced on the study of the natural sciences.

While therefore, this study was gradually gaining ground in England; materials were being collected, and many provincial museums and societies, were both formed, and maintained with spirit. We must pass on to the year 1825, when Mr. PRI-DEUX JOHN SELBY, published the first volume of his magnificent work on British birds. It is in large folio. The plates are drawn from nature; frequently from the living specimen, and are lithographed. Where the dimensions will admit of it, the figures are of the size of life; and all are beautifully colored with much precision and accuracy. Two volumes of letter press accompany this work. These are confined chiefly to the mere description and habitat; nor indeed, however much we may lament that the admirable sketches, which Mr. Selby is capable of giving, should be omitted, was it intended to be otherwise. For he says in the preface, "I have contented myself with referring by occasional notes, to any anecdotes particularly interesting as to the species under consideration." In the first edition of his first volume, he had chiefly followed the natural arrangement proposed by the celebrated French ornithologist, M. Temminck; but finding it to be imperfect, and not adapted to the natural order, at least of British birds, in his second edition he has rewritten the work, and had adopted that system which is proposed by Mr. Vigors.

Mr. Selby is living, and is still ardent in his favorite pursuit. He is a gentleman of property and of education; and his untiring industry is manifested by the various works which he has either edited or published, and the various papers which he has

supplied for the transactions of different scientific bodies. But he is scarcely less celebrated among those who knew him, for his thorough knowledge of British ornithology, than for his liberality of feeling; and many of the museums of his neighborhood are indebted to him for valuable and rare donations. He resides at Twizel House, Northumberland; a situation well adapted from its neighborhood to the sea, for observing and procuring rare birds. He established, two years since, in conjunction with his brother-in-law, Sir William Jardine, Bart.—likewise a zealous naturalist,—the “*Magazine of Natural History*,” a periodical work which has presented some valuable essays on the subject. He is also editor of the “*Library of Natural History*.”

In 1828, appeared the “*History of British Animals*,” by JOHN FLEMING, D. D., minister of Flisk, Fifeshire, a synopsis, printed in one thick octavo volume, chiefly a compilation from previous writers.*

In 1835, Rev. LEONARD JENYNS of Swaffhaur Bulbeck, near Cambridge, published a “*Manual of British Vertebrate animals, or descriptions of all the animals belonging to the classes Mammalia, Aves, Reptilia, Amphibia, and Pisces*,” &c. He had previously published in a pamphlet form, a “*Systematic catalogue*,” containing the ground work of this larger book.

The materials are nearly all original; on the subject of classification, no individual author has been rigidly adhered to; although he tends towards the opinion held by Mr. Mac Leay, of the circularity of natural groups. He was much assisted by Mr. Yarrell, as well as by Mr. Gray of the British museum, so that he had every facility for producing correctness, and performing the work in a good manner. Besides those species now found, he enumerates all the extinct species. “The object of the author is to present naturalists with a manual in this department of our Fauna, adapted to the existing state of our knowledge, and such as shall be calculated to meet the wants of science in that advanced age, to which it has attained since the publication of former works of this nature. In furtherance of the end, two

* I should desire to speak more particularly of this gentleman and his work, but am unable to find any particulars concerning him; and I have it not in my power to meet with a copy of the book at present. It is, in part, superseded by the later work of Jenyns.

points appeared necessary to be attended to. One was to ascertain, as far as practicable, the additions which had been made, of late years, to our list of British animals. * * * The other important point, was to take care that the descriptions should, as far as possible, be obtained from the animals themselves, and nothing inserted upon the credit of other writers, which was capable of being verified by personal observation. The day is forever gone by, in which unscientific compilations will be thought to be of any service to Zoology; so far from advancing its progress, it may be said unhesitatingly, that they tend only to retard it."

Hitherto, however much the birds themselves might have been attended to, their eggs and nidification, had been in a great measure neglected. Beautiful as are the former, and wonderful in their construction as are the nests; no one had as yet thought this branch worthy of separate attention. A French writer had, we believe, attempted a work, on this portion of the natural history of his own country; but had never completed it; and it was left to Mr. WILLIAM HEWITSON, to present the public, with the first original and well executed book, on this interesting topic. About 1831, he began to publish by subscription, in numbers, "*British Oology, being illustrations of the eggs of British birds,*" &c. It is in octavo, and consists of colored lithographic plates of the eggs, each one the natural size, and colored with great fidelity. A short description of the nest and eggs, accompanies each plate. To draw an egg, so that on paper it may appear natural, is no easy task, but being an excellent artist, he has accomplished his labors with great credit. The work now finished, is in three thin volumes, and contains *all* the British eggs, with the exception of a few of the very rarest.

Mr. Hewitson, who is still a young man, is descended from an old and highly respectable family in Newcastle upon Tyne. When a mere child he manifested a strong taste for drawing, and was fond of copying the figures and vignettes in Bewick's works. To these books, thus early put into his hands, he owes, we believe, his fondness for this science. He had the advantage of a liberal education, and became a civil engineer. As he grew up, his taste for drawing connected with natural history increased, and all his leisure hours he spent in the fields and woods. Like most boys he was fond of taking birds' nests; but unlike most boys, he became intimately acquainted with the species and varieties, and he

turned this knowledge to a good account. When he entered upon his profession, although his time was chiefly occupied with that, he yet found or made leisure not to neglect that which had afforded him so much satisfaction in his youth; and what time he could spare was spent in this absorbing pursuit. While engaged in publishing his work on Oology, he made a tour through Norway, for the purpose of procuring the eggs of such birds as are only migratory in Great Britain, and added several important facts to those with which we were already acquainted.

Although, as we have seen, Pennant had figured and described many of the British fishes, Mr. Donovan had given about one half of the species, and Mr. Jonathan Couch, of Cornwall, had established a high reputation as the Ichthyologist of that county; yet no one had hitherto treated this branch as one altogether national; and this is the more surprizing, when we consider that this country is entirely surrounded by the sea, that these animals form a very important part of food, and that the coast is comparatively very limited in extent, and unchangeable in climate.

For many years Mr. WILLIAM YARRELL, of London, had been forming a collection of Fishes; and his possessing the advantage of being able to search the London markets, put him in possession of all such species as are more common, and many of the rarer ones. In 1836 appeared the first number of his '*History of British Fishes*,' which is completed in two thick octavo volumes. While this work is altogether popular, and the price moderate, as a scientific production it is invaluable; and it contains all that is known upon the subject, including a great variety of curious, and original information. It is printed in the same shape and style as Bewick's works, and each species is illustrated by a wood cut, executed in a manner perhaps unsurpassed in this art.

Mr. Yarrell is still alive, and is well known, equally for his urbanity of manners, his connection with science, his very valuable private collection in some branches of natural history, and his papers in the Linnæan and other Transactions. He is now engaged in publishing, in the same form as his volumes on fishes, a general work on British birds.

About the same time Dr. BELL, of London, published in like form a volume on the '*British Quadrupeds*' which includes all that are known, with a great variety of information concerning them.

The last writer upon British Testacea is Mr. JOSHUA ALDER, of Newcastle upon Tyne, in the Transactions of the Natural History Society of Northumberland and Durham. He describes 71 species of land and fresh water shells as belonging to his neighborhood, many of which are new.

We have thus traced the gradual progress of natural science, as connected with Great Britain, from the days of Ray to our own times. We have seen how by degrees it has gathered strength, and how accuracy and scientific power also advanced. We have likewise seen that nearly all which has been accomplished has been done by those who had higher and more important duties to fulfil, but who, when weary, refreshed their minds by the observation of the works of God, instead of wasting in idleness or frivolous amusement, these their leisure hours. A complete account of the higher order of the zoology of that country, it is now in the power of any one to possess; and as regards the mammalia and birds, little probably remains to be added. But when we consider how each successive writer has thought that he had exhausted the stores of nature; how Ray supposed that the world did not contain above 150 species of beasts and reptiles, 50 of birds, and 500 of fishes, although now, in our own days, we have described 1200 species of mammalia, 6500 of birds, 8000 fishes, and 1500 reptiles, we may justly suppose and hope, that many more both of shells and fishes may be added to the list of the British Fauna. And as regards the United States we may learn how much is to be accomplished; although much has been done, and from what we do know, we may be incited to additional endeavors. Of this we may be assured, that as this study becomes more popular, so shall we see the mind of the people improving; simplicity of heart, and love of the works of God multiplied; and a thousand intellectual pleasures opened to those who, under Providence, are obliged to spend a larger part of their lives in harassing and fatiguing employments. We shall find that this study forms a bond of union between the lower and the higher classes of society,—the practical mechanic and the man of science; that it increases human happiness, by enlarging the sphere of intellectual pleasure; for every new development of intelligence is a source of pure enjoyment. The bond of union will be the love of knowledge. There is an equality in science, for the great requisite is not the *amount* of information, but the *desire* to be informed.

MISCELLANIES.

DOMESTIC AND FOREIGN.

1. *Pictorial delineations by light; solar, lunar, stellar, and artificial, called Photogenic and the art Photography.*

Remark.—The great interest excited by this subject induces us to postpone the greater part of the miscellany which we had prepared and even set up for the present number, that we may make room for general notices from foreign Journals—detailing the history of the processes as far as known, and the most perfect state of the art, as far as it has gone.

I. *Photogenic Drawings.**

Public attention has been called of late to a mode of drawing said to have been invented at Paris by M. Daguerre, and by which he fixes upon a metallic plate the lights and shadows of a landscape or figure solely by the action of the solar light. The interest thus excited has been increased by the publication of a series of experiments made by our countryman Mr. Talbot, directed towards the same object, and producing nearly similar results. In describing this interesting invention it will be well to commence with the first discoveries made by Mr. Wedgwood about the year 1800, and afterwards extended by Sir Humphry Davy.

The attention of these two eminent chemists was directed to the subject by the extraordinary effect produced by light upon the nitrate of silver, which led them to hope that the purposes of the artist might be assisted by the susceptibility of the metallic oxide. The first experiment was made by Mr. Wedgwood for the purpose of copying paintings upon glass, and was eminently successful; the copy obtained possessing all the figures of the original, in their native shades and colors; it was also in a high degree permanent, so long as it was preserved from the action of the light. The same gentleman discovered that the shadow of an opaque object thrown upon the paper was copied in outline with great correctness; but though both these celebrated chemists were constant and persevering in their endeavors to render the drawing permanent, they were entirely unsuccessful; the lighter shades darkening by exposures and thus obliterating the impression.

Their failure in this important object was published with their experiments in the Philosophical Transactions, and both having given up the attempt, their discoveries have since remained unimproved. But in the meanwhile M. Daguerre, it appears, struck by some hints he had received from a friend, has steadily pursued his experiments for the last twenty

* Foreign Quarterly Review, No. 81.

years, and having at length attained his object has declared his discoveries and claimed the invention as his own. Full and satisfactory descriptions are promised by M. Arago and two other scientific engineers appointed to report on the subject, and in the interval a slight outline has been given in the French papers, from which the following account is taken.

A polished metallic plate is the substance made use of, and being placed within the apparatus is in a few minutes removed and finished by a slight mechanical operation. The sketch thus produced is in appearance something similar to aquatint, but greatly superior in delicacy; and such is the extraordinary precision of the detail that the most powerful microscope serves but to display the perfection of the copy. The first efforts of the inventor were directed towards architectural subjects, and a view of the Louvre and Notre Dame are among the most admired of these engravings. In foliage he is less successful; the constant motion in the leaves rendering his landscape confused and unmeaning; and the same objection necessarily applies to all moving objects, which can never be properly delineated without the aid of memory. But in the execution of any stationary subject, buildings, statues, flowers, the leaves of plants, or the bodies of animals, the fac-simile is perfect; and the value of the invention may therefore be easily conceived.

Several eminent artists have examined the designs, and were equally delighted with the precision and delicacy of the representation. Among the sketches exhibited by the projector was a marble bas-relief and plaster imitation; the first glance was sufficient to detect the difference between these two; and in three views of a monument taken in the morning, noon, and evening, the spectators easily distinguished the hours at which they were executed, by the difference of the light, though in the first and last instances, the sun was at an equal altitude.

But perhaps the anatomist or zoologist will derive the greatest advantages from the discovery, the form of the animal being as easily studied from the drawing as from the original, and the most powerful microscopes not having hitherto detected the smallest deficiency in the details. Nor is the invention devoid of interest to the astronomer, for the light of the moon is sufficient to produce the usual results, requiring only additional time for its operations. The following extract from "*Le Commerce*" is sufficient to substantiate its value in this respect:—"The experiments on the light of Sirius have confirmed the testimony of natural philosophy, and abundantly proved that the stars are bodies of the same nature as the sun; at the request of M. Biot, M. Daguerre has submitted his apparatus to the influence of the light of the moon, and has succeeded in fixing the image of that luminary. We observed that the image had a trail of light something like the tail of a comet, and we ascribe it to the movement of the body during the operation, which is of much longer duration than that by the light of the sun."

In the spring of 1834, Mr. Talbot began a series of experiments, with the hope of turning to useful account the singular susceptibility evinced by the nitrate of silver when exposed to the rays of a powerful light; but not being acquainted with the researches of former chemists on the subject, he commenced with the same disadvantages which had baffled the skill and perseverance of Sir Humphry Davy. The plan he at first proposed was, to receive a well-defined shadow upon a sheet of paper covered with a solution of nitrate of silver, by which means the part shaded would remain white, while the surrounding portion was blackened by exposure to the light. But he was well aware that the sketch thus obtained would require to be protected from the rays of the sun, and examined only by an artificial light. He had carried these inquiries to some extent, and become possessed of several curious results before he learned the steps which others had taken to attain the same object: and the decided terms in which Sir Humphry Davy expresses his failure might perhaps have discouraged his less experienced follower, had he not fortunately already conquered the difficulty which had destroyed the hopes of the former chemists.

Mr. Talbot continues:—"In the course of my experiments directed to that end, I have been astonished at the variety of effects which I have found produced by a very limited number of different processes when combined in various ways; and also at the length of time which sometimes elapses before the full effect of these manifests itself with certainty. For I have found that images formed in this manner, which have appeared in good preservation at the end of the twelve months from their formation, have nevertheless somewhat altered during the second year." He was induced from this circumstance to watch more closely the progress of this change, fearing that in process of time all his pictures might be found to deteriorate; this, however, was not the case, and several have withstood the action of the light for more than five years.

The images obtained by this process are themselves white, but the ground is differently and agreeably colored; and by slightly varying the proportions, and some trifling details of manipulation, any of the following colors were readily obtained:—light blue, yellow, pink, brown, black, and a dark green nearly approaching to black.

The first objects to which this process was applied were leaves and flowers, which it rendered with extraordinary fidelity, representing even the veins and minute hairs with which they were covered, and which were frequently imperceptible without the aid of a microscope. Mr. Talbot goes on to mention that the following considerations led him to conceive the possibility of discovering a preservative process. Nitrate of silver, which has become darkened by exposure to the light, is no longer the same chemical substance as before; therefore, if chemical re-agents be applied to a picture obtained in the manner already mentioned, the dark-

ened parts will be acted upon in a different manner from those which retain their original color, and after such action they will probably be no longer affected by the rays of the sun, or, at all events, will have no tendency to assimilate by such exposure; and if they remain dissimilar, the picture will continue distinct, and the great difficulty be overcome.

The first trials of the inventor to destroy the susceptibility of the metallic oxide were entirely abortive; but he has at length succeeded to an extent equal to his most sanguine expectations. The paper employed by Mr. Talbot is superfine writing paper; this is dipped into a weak solution of common salt, and dried with a towel till the salt is evenly distributed over the surface: a solution of nitrate of silver, is then laid over one side of the paper, and the whole is dried by the heat of the fire. It is however, necessary to ascertain by experiment the exact degree of strength requisite in both the ingredients, for if the salt predominates, the sensibility of the paper gradually diminishes, in proportion to this excess, till the effect almost entirely disappears.

In endeavoring to remedy this evil, Mr. Talbot discovered that a renewed application of the nitrate not only obviated the difficulty, but rendered the preparation more sensitive than ever: and by a repetition of the same process the mutability of the paper will increase to such a degree, as to darken of itself without exposure to the light. This shows that the attempt has been carried too far, and the object of the experimentalist must be to approach, without attaining this condition. Having prepared the paper and taken the sketch, the next object is to render it permanent, by destroying the susceptibility of the ingredients for this purpose. Mr. Talbot tried ammonia and several other re-agents with little success, till the iodide of potassium, greatly diluted, gave the desired result; this liquid, when applied to the drawing, produced an iodide of silver, a substance insensible to the action of light. This is the only method of preserving the picture in its original tints, but it requires considerable nicety, and an easier mode is sufficient for ordinary purposes. It consists in immersing the picture in a strong solution of salt, wiping off the superfluous moisture, and drying it by the heat of the fire; on exposure to the sun, the white parts become of a pale lilac, which is permanent and immovable. Numerous experiments have shown the inventor that the depth of these tints depends on the strength of the solution of salt; he also mentions that those prepared by iodide become a bright yellow under the influence of heat, and regain their original color on cooling. Without the application of one of these preservatives the image will disappear by the action of the sun; but if inclosed in a portfolio, will be in no danger of alteration: this, Mr. Talbot remarks, will render it extremely convenient to the traveller, who may take a copy of any object he desires, and apply the preservative at his leisure. In this respect Mr. Talbot's system is greatly superior to that of M. Daguerre, since it would be scarcely pos-

sible for a traveller to burden himself with a number of metallic plates, which in the latter process are indispensable.

An advantage of equal importance exists in the rapidity with which Mr. Talbot's pictures are executed; for which half a second is considered sufficient; a circumstance that gives him a better chance of success in delineating animals or foliage; and although our countryman has not thought it necessary to adorn his invention with his own name, nor to keep it a secret till he could sell it to advantage, his claim to originality is equal to M. Daguerre's, and can only be rivalled by that of Mr. Wedgwood, the real discoverer and originator of the art.

Since the publication of the above discoveries, numerous candidates have appeared in the field, all claiming the palm of originality, while philosophers of every grade and county have eagerly pursued the investigation of the subject. The first we shall notice is M. Niepce, who claims priority even over M. Daguerre; and the account he publishes, if correct, will undoubtedly determine the question in his favor. A letter from M. Bauer is the principal evidence for M. Niepce, who it appears mentioned his discovery to this gentleman in the year 1827, while on a visit at Kew, and by the advice of his friend he drew up a memoir on the subject, and caused it to be forwarded to the Royal Society. This document was, however, returned, it being contrary to the rules of the Association to receive accounts of scientific discoveries unless they detailed the process employed. M. Neipce shortly afterwards returned to France, having presented to his friend several specimens of the newly discovered art, which are still in the possession of M. Bauer. The pictures taken, are of two kinds, copies from engravings, and copies from nature; the best of the former is in the possession of M. Cussel, and is considered nearly equal to those of M. Daguerre, with suitable allowance for twelve years' exposure; the specimen taken from nature, is however, by no means so successful, and is considered inferior to the earliest attempts of his countryman. There can be little doubt that the principle of both processes is precisely the same, though greatly improved by diligent experiments, the material employed in each being a metallic plate, apparently covered with transparent varnish; but whether intended to receive or to fix the impression is not at present made public. We now come to a statement of M. Bauer, which, if not founded on error, will raise the invention of Niepce far above those of both his rivals; he distinctly asserts that he possessed copies of engravings produced solely by the action of light, which were capable of being multiplied in the same manner as an ordinary copper-plate; if this be the case, the greatest secret still remains unknown, even to M. Daguerre himself. It is much to be regretted that M. Niepce did not at once publish his extraordinary discovery, with a full detail of the process employed, as he would then have retained the indisputable right to the merit of the invention, but having preserved the secret so long, and

the process being in every respect so different, we cannot see that it in any way interferes with the position of Mr. Talbot.

We must leave this question and now proceed to analyze the claims of two of our countrymen, Messrs. Havell and Wellmore, who are said to have introduced an important addition to the process pursued by Mr. Talbot, a full description of which is contained in a letter to the editor of the *Literary Gazette*. The first attempt of this gentleman was directed towards an etching, by Rembrandt, of an old man reading, and the result was a reversed fac-simile; a negro face surmounted by locks of silver; the disappointed artist discovered that a second transfer entirely destroyed the spirit of the picture. To remedy this evil he had recourse to a new process, by which this defect was indeed removed, but the great merit of the art, namely, self-acting power, was lost. A thin plate of glass was laid on the subject to be copied, upon which the high lights were painted with a mixture of white lead and copal varnish, the proportion of varnish being increased for the darker shading of the picture. The next day Mr. Havell removed the white ground with the point of a penknife, to represent the dark etched lines of the original, and a sheet of prepared paper having been placed behind the glass and thus exposed to the light, a tolerable impression was produced; the half tints had, however, absorbed too much of the violet ray, an imperfection which was remedied by painting the parts over with black on the other side of the glass; if allowed to remain too long exposed to the sun's rays the middle tints became too dark, and destroyed the effect of the sketch; about ten minutes in a powerful sun was considered sufficient. Another method employed by Mr. Havell was to spread a ground composed of white lead, sugar of lead, and copal varnish, over a plate of glass, and having transferred a pencil drawing in the usual manner, to work it out with the etching point till it bore the appearance of a spirited ink drawing, or in the hands of an engraver a highly finished engraving. The above process Mr. Havell made public under the impression that it had been hitherto overlooked, but Mr. Talbot, hearing that he was about to apply for a patent, laid claim to the improvement as his own, and not only pointed out some parts of his former memorial where it was distinctly mentioned, but also produced several drawings made precisely in the manner described; he has also laid before the Royal Society a new method of preparing the sensitive paper, which consists in immersing it in a solution of nitrate of silver, and after washing it with bromide of potassium, the nitrate of silver is again applied, the preparation being dried by the fire between each operation; the paper thus treated is extremely sensitive, changing with the feeblest daylight, first to a bluish green then to olive green, and finally to black.

A letter to Mr. Talbot from his friend M. Biot has also been published, and contains many interesting experiments. After commenting on the value of the discovery, he continues—"The interest with which I viewed

this circumstance, engaged me to make some experiments upon your preparation, in order to vary its application to the researches in which I am occupied. First, I wished to know whether the change of color was in any degree influenced by the paper itself; I therefore spread the substance on a piece of white unglazed porcelain instead of paper, taking care to operate by night, and drying it each time at the fire, as you say, I thus obtained a dry solid coating upon the porcelain, which I shut up in a dark place until the morning. In the morning I took it out, and found it of a pale sulphur yellow color: I then presented it to the daylight at an open window looking north; the weather was then very cloudy; yet no sooner had I so presented it than already it was turned green, and soon afterwards it became black. I then wished to know whether the preparation would succeed equally well if not dried at the fire; I therefore, in a darkened room, mixed the aqueous solution of bromide of potassium with that of nitrate of silver; a precipitate fell, which I spread on a porcelain plate and left it to dry in the dark; the next day I wrapped it in several folds of paper, and brought it into another room to show it to a friend; but having taken off the covers in a dark corner of the room in order to exhibit the original color, pale lemon yellow, instantly we saw its tint become green, and I had hardly time to present it to a window opening to the north before its color had passed to dark olive green, after which it almost immediately became nearly black. I do not think it possible to find any substance more sensitive to light." Had M. Daguerre or M. Niepce published their experiments at the commencement, Mr. Talbot would have appeared merely as an improver of a foreign discovery.

We must notice here that, by possibility, this art may not be altogether unknown to jugglers in India. It is many years since an offer was made, in our presence, by one of them, to show any gentleman his portrait taken by a single look alone. The master of the house, however, deeming the proposal an insult on the credulity of the company, ordered the man of science to be instantly expelled with the rattan.

II. *Photographic processes, by Andrew Fyfe,* M. D., F. R. S. E., &c.*

Photography may be divided into three parts: the preparation of the paper,—taking the impressions,—and preserving them.

1. *Methods of preparing the Paper.*

Though paper besmeared with solution of lunar caustic is darkened by exposure to light, it is by no means *sensitive*; other methods have therefore been recommended for preparing it for photographic purposes. That originally given by Mr. Talbot is to soak it first in a weak

* Read before Soc. of Arts Edinb. Mar. and Apr. 1839. From the New Edinb. Phil. Jour. April to July, 1839.

solution of sea-salt, and when dry, to rub it over on one side with solution of lunar caustic, by which *chloride of silver* is formed, and adheres to the paper. As thus prepared, it acquires a dark color on exposure to light; the depth of color depending on the strength of the solutions; hence it may vary from lilac to deep purple, approaching to black.

In preparing paper by this method, it is very difficult to get the chloride uniformly spread over the surface, and accordingly, when exposed to light, it often gives a variety of shades; indeed, in many places it continues white. It was this that induced me to try the use of other salts of silver; and the one which I have found to answer best is the *phosphate*, procured in the usual way, by the addition of the phosphate of soda to the solution of lunar caustic. In preparing the paper by this method, I generally employ one part of phosphate of soda dissolved in about eight of water, and the nitrate of silver dissolved in about six of water. The paper is first soaked in the phosphate, and then dried, after which the nitrate is put on on one side by a brush, the paper again dried and afterwards again put through the salt, by which any excess of silver is converted to phosphate. As thus prepared, it acquires a yellow tinge, which becomes black by exposure to light. It is equally *sensitive* as the chloride, and, in my opinion, gives a much more pleasing variety of shades.

Instead of preparing the paper by the process described, I frequently employ the phosphate precipitated before applying it, for which purpose the nitrate solution is dropped into that of the phosphate of soda, the yellow precipitate is allowed to fall to the bottom, and the supernatant fluid is poured off; what remains must be kept in stone bottles or in a dark place, as it is extremely sensitive to light. In preparing the paper with it, it is put on with a broad flat brush, and then dried in the usual way. Though there is a little difficulty at first in getting the phosphate uniformly spread over the surface, yet by a little practice a uniform ground is easily given, and when once acquired, the method has the advantage of being much cheaper than those previously recommended. I sometimes add a little mucilage to the fluid, which keeps the phosphate suspended in it. There are other methods of preparing the paper, which though they do not give it so sensitive, yet are cheaper than those stated; I allude to the use of the phosphate in solution in ammonia, or, which is cheaper, in the carbonate of ammonia which is procured by adding concentrated solution of carbonate of ammonia to the phosphate collected by precipitation as already described. A still cheaper fluid may be prepared by adding a strong solution of nitrate of silver to a concentrated solution of carbonate of ammonia, by which a *carbonate of silver* is obtained in solution, and

which can be applied to the paper on one side by means of a brush. Paper thus prepared is white; it has the advantage of being easily prepared, and of giving, on exposure to light, a uniform ground which is of a brownish color.*

2. *Methods of taking the Impressions.*

From what has been already stated, it must be evident that the most direct mode of taking the impressions is, by placing on the paper the object, the delineation of which is wished, and then exposing it to the light. For this purpose it ought to be kept as close as possible on the paper, and the best method of doing so is to place it in a frame with glass in front, and a stuffed cushion behind it. The time required depends, of course, on the intensity of the light, and the density of the object; and it is of the utmost consequence to take care that it is long enough exposed, and that, at the same time, the exposure is not too long continued, for if not long enough, though the outline will be given, yet the representation will not be distinct in all its parts; whereas if too long continued, the fainter parts begin to darken, and the representation is indistinct. The time required must be found by practice. In bright sunshine one minute will be sufficient for some objects: when there is no sunshine an hour or two may be required, and in this case there is little or no danger of destroying the impression by too long exposure, as the light is not of sufficient intensity to darken too much the fainter parts.

Impressions from Engravings may likewise be got in the same way; and for this purpose, instead of using those thrown off on thin paper, by which it is supposed the light is most easily transmitted, it is, I think, better to take those on thick paper, because, though the light is not so easily transmitted, yet the impression of the engraving is much bolder, so that a more distinct delineation is given by the photographic process.

Camera Obscura.—The use of the camera obscura for photographic purposes, has been described by Mr. Talbot. Though representations may be got in this way, yet, so far as I have found, they have not the minute distinctness of those got by the method already noticed. Owing to the interference of the lens, the light does not act nearly so powerfully on the paper, as when it has to permeate merely a frame of glass. The same is the case when the light is reflected,

* Instead of purchasing lunar caustic of commerce, a cheaper method of procuring it is to dissolve pure silver in nitric acid diluted with its own bulk of water, taking care to have in the vessel more silver than the acid can dissolve; and after it has taken up as much as it can, to dilute the solution with four or five parts of water, or thereabouts, according to the color required.

and hence the necessity of getting quit of the mirror placed in cameras, for throwing the representation in such a way as to allow of its being traced by the artist. Hence, in taking impressions by the camera, the prepared paper must be fixed *on the back of the box*, directly opposed to the lens, and the focus properly adjusted. I have found great advantage, in taking impressions by the camera, in using the paper moist, and keeping it so all the time it is exposed. For this purpose, after moistening it, I place it between a cushion and a pane of glass, tied tightly together, to prevent, as much as possible, the escape of moisture. In this way I have succeeded in a few minutes in getting a faint outline of the object exposed to the lens.

I may here mention that the camera affords a good method of taking profiles from busts, not by the reflected light from the bust, but by interposing it between the lens and the source of light. The bust, for instance, may be placed, during sunshine, at an open window, and the image from it thrown on the prepared paper; using the precaution, of having the face slightly inclined towards the source of light, so as to give its outline as distinctly as possible.

Etchings.—A method of taking impressions of etchings on glass by the photographic process was described by Havell of London. For this purpose the glass is covered with etching varnish, and after the figure is etched on it, it is smoked, so as to darken the varnish to prevent the transmission of light; of course, the smoke does not adhere to those parts of the glass exposed by the etching needle, and is therefore easily wiped off with a cloth, thus leaving the etching free for the light to pass through. On exposing this with the prepared paper behind it, a beautiful impression is taken. In taking impressions in this way, the *varnished side* must be placed *next the paper*, which must be kept close upon the etching by means of a cushion, otherwise the impression is not well defined. When the glass side is next the paper, the impression is very indistinct, owing to the light, when it passes through the exposed parts of the glass, being diffused, and by which the lines run into each other.

From the ease with which impressions can be got in this way, it occurred to me that the process might be still farther extended, so as to enable us to take copies of oil paintings, or of drawings on boards, through which the light does not penetrate, and for this purpose I have followed different methods. One of these is to cover the glass with a transparent varnish, as with a thin solution of Canada balsam in oil of turpentine, and, after laying it down on the oil painting, to etch it out on the varnish, in the usual way; after this, the glass is to be slightly heated, so as to soften the varnish, which is then to be smoked, by holding it in the flame of an argand gas lamp, taking care

not to soften the varnish too much; when cold, the smoke is wiped off with a cloth from the parts of the glass exposed by the etching needle. Another method is to cover one side of the glass with starch solution, of such strength, that when dry it is transparent, and it is then to be laid down with the glass side next the paintings, which can be traced with a pencil on the starch, and then etched on the other side, as already described. From glass etchings thus procured, impressions are taken in the usual way.

This process of transparent etching is applicable to the camera obscura; for, instead of using ground glass, as is commonly done, the representation may be thrown on starched glass, on which it is traced and then etched on the other side, as above described.

Before finishing this part of the subject, I may here allude to a method of taking the impressions, by which I have succeeded in giving them a resemblance to oil paintings.

By the method noticed, paper, or some absorbing substance, is used. I have already stated that the phosphate suspended in water may be employed, which suggested to me the use of the same substance along with a varnish, in the hopes of being able to take the impression on panel-board or metal. I have found this to answer as well as with paper. The varnish I have used is Canada balsam and turpentine, with which the phosphate, dried by the cautious application of heat, and excluded from light, is thoroughly incorporated; with this the panel-board, previously prepared as for an oil painting, is varnished; when dry, the impression is taken on it in the usual way. It will be found to have all the richness of an oil painting.

By this process, impressions equally distinct and brilliant may be taken on metal. Perhaps this may be of service in saving engravers the time and trouble of laying down on the metal the figure to be engraved.

The impressions received by the modes now described are taken by exposure to the solar ray. It is well known that the paper may be darkened by other means, as by the oxyhydrogen blowpipe; but there is no necessity for having recourse to so intense an artificial light. I have found that, by concentrating the light of a common fire by metallic mirrors, the paper is darkened, and the same also occurs with the flame of a gas lamp. Of course, the time required is much longer than when exposed to sunshine. In this way I have succeeded in getting impressions of dried leaves almost as distinct as by solar light; indeed we may dispense altogether with the mirror, for, by exposing the paper with the leaf on it, in a frame, to the light of a common fish-tail gas-burner, at the distance of a few inches, I have procured specimens, some of which, though on a small scale, have all the richness of those taken by solar light.

The concentration of the rays by a metallic mirror, so as to get quit of the interference of the lens, would no doubt be a great improvement in the camera obscura, provided it could be accomplished. May not something of this kind be the method followed by Daguerre in getting his camera representations?

3. *Preservation of the Impressions.*

It is evident that, as the impression is produced by the agency of light on the compound of silver, when the paper is again exposed, the light will begin to act, and ultimately darken the whole, thus effacing the impression; hence the necessity of a preservative process. Two methods have been recommended by Mr. Talbot, as applicable to the *chloride*, one by the iodide of potassium, the other by sea-salt. When solution of iodide of potassium is added to that of lunar caustic, a yellow iodide of silver is thrown down. The same is the case when the iodide is put on paper, previously covered with the chloride, and, provided the solution is strong, it acts also on the chloride when darkened, thus converting it to yellow iodide, which is not in the least affected by light; hence, by putting the paper with the impression through solution of the iodide, provided it is weak, the white chloride only is acted on, and being converted to iodide, is no longer liable to change. As, however, the iodide will act on the dark chloride, it is of the utmost consequence to attend to the strength of the solution, which should be such that it will not attack the faint parts of the impression. After the paper is passed through it, it should be kept for some time in water, to wash off the superfluous iodide of potassium, which, if left on, would gradually destroy the whole of the impression; indeed, even with this precaution, I find it extremely difficult to preserve them. The second method recommended by Mr. Talbot is merely immersing the paper in solution of sea-salt. This process does not, however, seem to answer well; I have repeatedly failed in preserving the specimens in this way, and even when they are preserved, they are completely altered in their appearance, and deprived of their original brilliancy.

I have already stated, that I prefer the phosphate of silver for taking the impressions, not only because it is equally sensitive as the chloride, but gives a greater variety of shades. In addition to these, it has another advantage; the impressions are easily preserved. After various fruitless attempts, I at last found that the darkened phosphate is not soluble in ammonia, though, as is well known, the yellow phosphate is easily dissolved. I had, therefore, recourse to this for their preservation, and though I did not completely succeed at first, yet I at last did so, by attending to the precaution of washing off the ammoniacal solution, because, when left on, the impression gradu-

ally becomes darker and darker, and is ultimately destroyed, owing to the action of the light on it. The method I now follow is to put the paper into a diluted solution of water of ammonia (one of the spirit of hartshorn to about six of water,) and leave it there till the yellow parts become white, showing that the phosphate is dissolved, after which it is washed with water to carry off the whole of the ammoniacal solution. It should then, when nearly dry, be subjected to pressure till dried, by which it is prevented from wrinkling, and the impression retains its original sharpness, which, unless this is done, it is apt to lose, by the fibre of the paper being raised by the repeated moistening.

Though the phosphate specimens may be preserved in this way, yet they do not retain exactly their original appearance. Those parts whitened by the ammonia, owing to part of the silver being united with the paper, gradually acquire a faint reddish tinge,—but, though altering the appearance, it does not affect the brilliancy; indeed, in some cases it rather improves it, by giving a pleasing tint, which contrasts well with the darker parts, and gives the appearance of coloring. I have also found that carbonate of ammonia answers equally well, and, being much cheaper, it will of course be preferred. I generally employ a solution, prepared by dissolving one part of salt in about four of water, in which the paper is kept for a minute or so, and then afterwards washed, and subjected to pressure, as already noticed. Impressions thus preserved acquire the same reddish tinge as those acted on by ammonia.

I have before stated that the paper may be prepared by washing it over with a solution, procured by adding nitrate of silver to carbonate of ammonia. The impressions taken with that paper are easily preserved by merely washing them with water, to carry off the part not acted on by the light, which is another advantage, in addition to those stated, for using the carbonate solution. Like the phosphate specimens, they also acquire a reddish tint.

Other preservative methods have been recommended, as, by covering the impressions with a yellow color, to prevent, as much as possible, the transmission of the chemical ray of the light; but those above stated, particularly when the phosphate or carbonate is used, are so simple and efficacious that it is unnecessary to allude to them.

Before finishing this part of the subject, I may here allude to a valuable practical application of photography, in diminishing the labors of the lithographer. In communicating the impression of any object to the stone, as of a dried plant, or in copying an engraving, it is necessary to trace them on paper, and after again tracing them with the transfer ink, transfer them to the stone. Now, by receiving the impression on paper by the photographic process, all the labor of the

first tracing is avoided. But there is no necessity for using paper, as the impression may at once be communicated to the stone, which easily receives the phosphate, and which may therefore be prepared in the same way as the papers, and the impression also taken in the usual manner, after which it is traced over with the transfer ink. By this process not only is a great deal of labor saved, but the representation must be much more exact than when traced; for though by the latter the outline is correct, yet much is left to be afterwards filled in by the eye, whereas, by the photographic process, every, even the most minute filament, is distinctly and accurately laid down on the stone.*

Method of taking Impressions in which the lights and shades are not reversed.

By the different methods now described for getting photographic impressions, the lights and shades are always reversed, because, as it is by the action of the light that the compound of silver is darkened, wherever it is prevented from penetrating, the paper retains its original color. Though the impressions thus procured are accurate as to outlines, yet in many cases the representation is far from being pleasing; it is therefore a great desideratum to have a method of getting impressions in which there is no reverse; in fact, to give a true representation of the object, and in this I have succeeded by the use of the iodide of potassium. I have already stated, that when the darkened phosphate is exposed to the iodide, it is instantly converted to yellow, provided the solution is of sufficient strength; if weak, the action goes on slowly. In some impressions which I had attempted to preserve in this way, I observed that when exposed to light they began to fade, which induced me to try the effect of light on darkened paper, soaked in solution of iodide, of such strength that it just failed to attack it instantly. In my first attempt I succeeded in bleaching the paper, but in my next I failed. On considering the circumstances under which these trials were made, I found that the only difference between them was, that in the first the paper was moist, in the last it was dry. Accordingly, on repeating the experiment with the paper moist, I again succeeded in getting a delineation of the object placed on the paper, as distinct and altogether as brilliant as those obtained by the other process.

* For this method of applying the photographic process I am indebted to Mr. Nichol, lithographer, by whom lithographic impressions, thus taken, were exhibited to the Society of Arts. As a proof of the value of this process, I may also mention, that on the evening of the 17th of April, when I exhibited a photographic specimen of dried ferns, it was, by Mr. Forrester, lithographed, and impressions taken from it, in the course of two hours; had this been done in the usual way, it would have required many hours of labor, and after all not have given such accurate delineations.

The method which I now follow is, after preparing the phosphate paper, to darken it, then immerse it in solution of iodide of potassium, of such strength that it does not act instantaneously, and, *when still moist*, to expose it to light with the object on it, and continue the exposure till the exposed part of the paper becomes yellow. In this case, there is a tendency in the iodide to convert the dark phosphate to yellow iodide, which go on slowly, but is hastened by the light; of course, if the object on the paper is impervious to light, the impression is black throughout, but if it is of different density, so as to allow the light to be differently transmitted, the impression presents the lights and shades as in the object itself; because those places behind the dense pieces retain their original blackness, while those behind the less dense are more or less bleached, just according to the transmission of the light. When impressions thus procured are kept, they begin to fade, owing to the slow but continued action of the iodide of potassium; hence the necessity of a preservative process. After repeated trials, I have found, that by far the simplest and the best is merely immersion in water, so as to carry off the whole of the iodide of potassium not acted on by the phosphate, and by which any farther action is completely prevented. By this method, the specimens do not lose in the least their original beauty, and they may be exposed to continued sunshine without undergoing the slightest alteration.

I have succeeded also in taking impressions with the chloride in the same way—but it is necessary for the success of the process, to use the solution of the iodide much weaker than for the phosphate, because the chloride is more easily acted on. In both cases it ought to be made of such strength that it just acts, and then, before using it, it must be weakened by the addition of a little water. For the phosphate, it will be found, in general, that 1 of salt to 10 of water, and for the chloride, that about 30 of water, will give a solution of the requisite strength. Of course, in preserving the specimens, the precautions as to washing and pressure must be attended to.

III. *Perfection of the Art, as stated in Notes on Daguerre's Photography.* By SIR JOHN ROBISON.*

Sir—In compliance with the request, that I should commit to writing and put into your hands the substance of what I communicated to the Society of Arts in reply to the questions put to me at the last meeting, I beg to state, that circumstances having led to my being included in a small party of English gentlemen who were lately in-

* Secretary to Royal Society of Edinburgh, &c. &c. (Communicated by the Society of Arts.) Edinb. Jour.

vited to visit the studio of M. Daguerre, to see the results of his discovery, I had an opportunity of satisfying myself, that the pictures produced by his process have no resemblance to any thing which, as far as I know, has yet been produced in this country; and that, excepting in the absence of color, they are as perfect images of the objects they represent, as are those which are seen by reflection from a highly polished surface. The perfection and fidelity of the pictures are such, that on examining them by microscopic power, details are discovered which are not perceivable to the naked eye in the original objects, but which, when searched for there by the aid of optical instruments, are found in perfect accordance: a crack in plaster, a withered leaf lying on a projecting cornice, or an accumulation of dust in a hollow moulding of a distant building, when they exist in the original, are faithfully copied in these wonderful pictures.

The subjects of most of the numerous specimens which I saw, were views of streets, boulevards, and buildings, with a considerable number of what may be termed interiors with still life; among the latter were various groups made up of plaster-casts and other works of art. It is difficult to express intelligibly a reason for the charm which is felt in beholding these pictures; but I think it must arise, in some measure, from finding that so much of the effect which we attribute to color, is preserved in the picture, although it consist only in light and shade; these, however, are given with such accuracy, that, in consequence of different materials reflecting light differently, it is easy to recognize those of which the different objects in the groups are formed. A work in white marble is at once distinguished from one in plaster-of-Paris by the translucency of the edges of the one, and the opacity of the other. Among the views of buildings, the following were remarkable: A set of three pictures of the same group of houses, one taken soon after sunrise, one at noon, and one in the evening; in these the change of aspect produced by the variations in the distribution of light, was exemplified in a way which art could never attain to.

One specimen was remarkable from its showing the progress made by light in producing the picture. A plate having been exposed during 30 seconds to the action of the light and then removed, the appearance of the view was that of the earliest dawn of day; there was a grey sky, and a few corners of buildings and other objects beginning to be visible through the deep black in which all the rest of the picture was involved.

The absence of figures from the streets, and the perfect way in which the stones of the causeway and the foot-pavements are rendered, is, at first sight, rather puzzling, though a little reflection satisfies one that passing objects do not remain long enough to make any

perceptible impression, and that (interfering only for a moment with the light reflected from the road,) they do not prevent a nearly accurate picture of it being produced.

Vacillating objects make indistinct pictures, *e. g.* a person getting his boot cleaned by a *decrotteur* gave a good picture, except that having moved his head in speaking to the shoe-black, his hat was out of shape, and the *decrotteur's* right arm and brush were represented by a half-tinted blot, through which the foot of the gentleman was partially visible.

There can be no doubt that when M. Daguerre's process is known to the public, it will be immediately applied to numberless useful purposes, as by means of it, accurate views of architecture, machinery, &c., may be taken, which being transferred to copper or to stone, may be disseminated at a cheap rate; and useful books on many subjects may be got up with copious illustrations, which are now too costly to be attainable: even the fine arts will gain, for the eyes accustomed to the accuracy of Daguerrotype pictures, will no longer be satisfied with bad drawing, however splendidly it may be colored. In one department, it will give valuable facility. Anatomical and surgical drawings, so difficult to make with the fidelity which it is desirable they should possess, will then be easily produced by a little skill and practice in the disposition of the subjects and of the lights.

It is a curious circumstance that, at the same time that M. Daguerre has made this beautiful and useful discovery in the art of delineation, another Parisian artist* has discovered a process by which he makes solid casts in plaster of small animals or other objects, without seams or repairs, and without destroying the model, (*Moulage d'une seule pièce, sans couture ni reparage, et avec conservation parfaite du modele*). I am in possession of several specimens of his work, among which are casts of the hand of an infant of six months, so delicately executed, that the skin shows evident marks of being affected by some slight eruptive disease. I am, dear Sir, very faithfully yours,

JOHN ROBISON.

JAMES TOD, Esq., Secretary to the Society of Arts.

Edinburgh, 1st June, 1839.

2. *Correction of an error—Cinnabar not found in Michigan.*—In Vol. I, at page 33, of this Journal, it is stated in a letter to Dr. J. L. Comstock by B. F. Stickney, that "a black and garnet colored sand is found on the shores of Lake Erie and Michigan which is a sulphuret of mercury and yields about 60 per cent. of that metal." No confirmation of this too

* Hippolyte Vincent, Mouleur, Rue Neuve St. François No. 14 (au Marai).

hastily accredited report having been given, we have long supposed that it was a mistake, and that credence had been too easily given by us to a result which if true, would have been extremely important, and which we confess we ought not to have admitted without the most rigorous proof. It is now in our power to settle this matter on the authority of Mr. Stickney himself, and through the kindness of our friend Josiah Thompson of Philadelphia, from whom we have received a letter dated June 29, ult., and covering a letter to him from Mr. Stickney dated Dec. 21, 1831, thirteen years after the first publication of the supposed discovery of cinnabar. Mr. Thompson remarks: "When in the west some years ago I visited the localities mentioned, (on the shores of lakes St. Clair and Erie,) and soon found that the sand in question contained no mercury, but was probably composed of garnets either broken up or in very small crystals. I afterwards wrote on the subject to Mr. Stickney who gave me the substance of his subsequent researches in the annexed communication."

"I should not have thought of reviving the thing at so late a period had I not heard it alluded to by a very distinguished scientific lecturer, whose authority for the assertions had been derived from the communications originally appearing in your widely circulated Journal, and which have been transferred to several standard works both American and European."

We now quote Mr. Stickney's statement:

"Some nine or ten years since I lay wind bound on the western shore of Lake Erie, with a small craft for several days, near the mouth of Otter Creek, a little south of Pleasant Bay, where the black and garnet colored sand is abundant. It struck me as probable, that it was a sulphuret of mercury. I levigated a few grains of the latter between two stones; the bright, opaque, red appearance when broken tended to confirm me in the opinion. Having no other employment, I mixed clay, water, and sand, with my hands and formed it into a retort and receiver; dried them in the sun; and afterwards baked them in the hot sand and ashes when we had a fire on the beach. I then introduced a small portion of the red sand into the retort; it could be but a small portion, as it did not hold more than half a pint. I set up my apparatus with small stones; fitting on and luting the receiver with some of the same clay and sand. Thus prepared, I put charcoal from our fire into the little furnace, and blowed them with a blowpipe made of a hollow weed. After continuing it for a time at a low red heat and permitting it to cool moderately, I broke the receiver, and discovered, as I then conceived, minute globules of mercury. I now concluded I had determined the presence of mercury in the sand. I took with me quantities of the sand; and when I returned home I submitted some of the red sand pulverised to nitro-muriatic acid, and precipitating the solution with carbonate of potash, I had a copious white precipitate. I weighed the sand; but having accidentally spilled some of the solution, I did not weigh the result. I made minutes at the time which

I now refer to. About eighteen months since, making some experiments on iron ore, I obtained a white precipitate,* so near resembling that from the sand, that I was led to suspect my mistake. I now undertook another and more minute examination of the sand. I obtained the same white precipitate, and submitted it to sublimation, but found no mercury, but every appearance of iron. I have examined the sand with the magnet and glasses. The black I think is a rich iron ore, highly magnetic; the red and reddish we may consider, and perhaps with safety, garnet and carnelian. In some places about the shores of these lakes there are large quantities of the black and red sand; some nearly all black, and others mostly red. I have specimens from Lake Michigan that are all black and all magnetic. When we commit an error, it is more important that it should be corrected than to develop a new truth. I therefore have a desire that this correction should be as extensively known as the error."

3. "*An Essay on the Development and Modifications of the External Organs of Plants. Compiled chiefly from the writings of J. Wolfgang Von Goethe, for a public lecture to the class of the Chester County Cabinet of Natural Science. By William Darlington, M. D.*" West Chester, Penn. 1839. 12mo. pp. 38.—The object of this essay, is, in the words of its author, to give "an exposition of the views which are entertained by some of the most eminent naturalists of the age, respecting the successive development and modification, or transformation, of the external organs of Plants; showing that all their appendages,—from the crude cotyledons of the germinating seed, to the most delicate component parts of the perfect flower,—are nothing but modified forms of that expansive tissue which envelopes the tender shoots of plants, and is the principal seat of vegetable life; or, in other words, that the organized covering, called the *bark* of plants, is the original *raw material*, (if I may so term it,) from which are formed and elaborated all those multiform organs, or appendages to the stem and branches, known by the names of Leaves, Stipules, Bracts, Involucres, Glumes, Calyces, Corollas, Nectaries, Stamens and Pistils." The germ of this doctrine is found in the writings of Linnæus, but it was first fully developed in 1790, by Goethe, whose fame as a poet has eclipsed his reputation as a naturalist. The labors of succeeding botanists have established its truth. Dr. Darlington has presented this curious subject in an interesting and lucid manner, and with his accustomed scientific accuracy.

4. *Journal of the Essex County (Mass.) Natural History Society*, Svo., Salem.—The first number of this Journal was published in 1836,

* An equivocal inconclusive result.—Eds.

and comprises 44 pages. Its contents are: Anniversary Address, by John L. Russell, M.D.; the Act of Incorporation, Constitution and Bye-Laws of the Society; Catalogues of its Officers and Books, and of the Donors to the Library and Cabinet.

The second number was published a few weeks since, and extends from page 45 to page 108. It comprises the following papers:

1. Familiar notice of some of the shells found in the limits of Essex County, Mass., with reference to descriptions and figures; by John L. Russell, page 47 to page 76.

2. Notice of the occurrence of specimens of *Vespertilio pruinosus*, Say, (Hoary Bat;) by H. Wheatland. 76, 77.

3. A sketch of the Geology and Mineralogy of the southern part of Essex County in Mass. communicated to the Essex Co. Nat. Hist. Soc. April 24, 1839; by Wm. Prescott. 78—91.

4. Two new species of Musci, with figures; by John L. Russell. 92, 93.

5. Remarks on *Hyla femoralis*, observed in the north parish of Danvers, Mass.; by Andrew Nichols. 93—96.

6. Notice of rare plants; with a description of a curious variety of *Cladonia Uncialis*; by John L. Russell. 96—100.

7. Remarks upon *Scarabæus Goliatus* and other African beetles allied to it; by Thaddeus Wm. Harris. 101—107.

The Society was incorporated in February, 1836, by the Legislature of Massachusetts. From the prefatory remarks in the second number it appears that the institution is in a prosperous condition, and has already collected a considerable cabinet and library. Of the industry and ability of the members, we have good evidence in the numbers before us. We gladly welcome every new laborer in American Natural History; for notwithstanding what has been already accomplished, the field of discovery is yet very far from being exhausted, and we hope that the honor of gathering in the harvest may not pass from our own shores.

July, 1839.

5. "*Transactions of the American Philosophical Society, held at Philadelphia for promoting useful knowledge. Part 2, of Vol. 6, new series (or Vol. 12, of the entire series):—p. 155 to p. 337. 4to. Philadelphia, 1839.*"

This part of the Transactions of our most ancient and active scientific body has just made its appearance. It contains several papers of much importance, and well sustains the high character of the Society from which it emanates. We annex a list of all the communications comprised in it.

Art. II. Descriptions of New North American Insects, and Observations on some already described. By [the late] Thomas Say. Continued from Vol. IV, N. S., p. 470. pp. 155—190.

III. Notice of a Vein of Bituminous Coal, recently explored in the vicinity of the Havana, in the island of Cuba. By Richard Cowling Taylor, and Thomas G. Clemson. 191—196.

IV. Observations on the changes of color in Birds and Quadrupeds. By John Bachman, D. D. 197—239.

V. Determination of the Longitude of several stations near the Northern Boundary of Ohio, from Transits of the Moon, and Moon-culminating Stars, observed in 1835, by Capt. Andrew Talcott. By Sears C. Walker. 241—266.

VI. On the magnetic Dip at several places in the State of Ohio, and on the relative Horizontal Magnetic Intensities of Cincinnati and London. By Prof. John Locke. In a letter to John Vaughan. 267—273.

VII. New formulæ relative to Comets. By E. Nulty. 275—295.

VIII. Account of a Tornado, which, towards the end of August, 1838, passed over the suburbs of the city of Providence, in the State of Rhode Island, and afterwards over a part of the village of Somerset. Also an extract of a letter on the same subject from Zachariah Allen, of the city of Providence. Communicated by Robert Hare. 297—301.

IX. Contributions to Electricity and Magnetism, No. III. On Electro-Dynamic Induction. By Joseph Henry. 303—337.

6. *Notice of the "Journal of the Statistical Society of London."* 8vo. 18s. per year.—This society was established at London in the spring of 1834, and has prosecuted with great vigor the objects for which it was instituted. The journal of the society, (the first number of which appeared in May 1838) is published monthly, and contains an account of the proceedings of the Statistical Society of London, and of other societies, communications on statistical subjects; queries and tabular forms for prosecuting original inquiries; copies or abstracts of parliamentary reports and papers relating to statistics; reviews and lists of new statistical works, &c. The work is in our judgment, one of very great value: as a specimen of the papers contained in it, we may mention the following: Account of the changes and present state of the population of New Zealand; Statistics of the copper mines of Cornwall, England; Statistical Illustrations of the principal Universities of Great Britain and Ireland; Statistical table of crime in Ireland; Moral Statistics of three parishes in the city of Westminster; Account of Algeria, or the French provinces in Africa; Statistics of the city of New York. It is not necessary to say anything here of the importance of authentic statistics to all classes of philosophic inquirers and men of business. To these the work in question cannot fail to be highly acceptable and useful. We hope it may gain a general circulation throughout our country.

7. *Progress of the U. States Exploring Expedition.*—The exploring squadron, of which we have given accounts in Vols. 35 and 36, arrived at Orange Harbor, Terra del Fuego, on the 17th of February, 1839, in forty days from Rio Janeiro. Commt. Wilkes then transferred himself from the *Vincennes* to the brig *Porpoise*, in which, attended by the schooner *Sea Gull*, he sailed from Orange Harbor on the 25th February, 1839, with the intention of penetrating as far south as circumstances

might permit. The *Peacock*, commanded by Lieut. Hudson, attended by the schooner *Flying Fish*, departed at the same time, on a similar voyage, but by a different route. No tidings concerning their success have yet reached us. The *Vincennes*, under command of Lieut. Craven, is to be employed during their absence, in surveying in the vicinity of Orange Harbor. The *Relief*, having on board several members of the scientific corps, was dispatched for a like period, on a cruise through the straits of Magellan, but in making the attempt to enter by the Cockburn Channel, she encountered a succession of violent winds, and about the last of March, narrowly escaped shipwreck in a storm near Noir Island. On this occasion the *Relief* lost four anchors. For this reason she did not continue the cruise, but sailed for Valparaiso, where she arrived on the 15th April, 1839. Throughout the squadron, health and harmony have prevailed, among both officers and men.

8. *Cold Bokkeveld Meteorites*.—Our last number contained a brief account of the fall of a large meteorite at Cold Bokkeveld, near the Cape of Good Hope, October 13, 1838. By notices in the *Lond. and Ed. Phil. Mag. May*, 1839, it appears that instead of a single meteoric mass, great numbers of stones were thrown down, and according to one statement they were scattered in one line of direction throughout the space of 150 miles. The explosion was “louder and more appalling than the strongest artillery, causing the air to vibrate for upwards of 80 miles in every direction.” The following analysis by Sir M. Faraday, of a piece of one of these meteorites forwarded to Sir J. F. W. Herschel, was communicated by the latter to the Royal Society, at its session of March 21, 1839.

“The stone is stated as being soft, porous and hygrometric; having, when dry, the specific gravity of 2.94; and possessing a very small degree of magnetic power irregularly dispersed through it. One hundred parts of the stone, in its natural state, were found to consist of the following constituents, namely:

Water, - - -	6.50	Alumina, - - -	5.22
Sulphur, - - -	4.24	Lime, - - -	1.64
Silica, - - -	28.90	Oxide of Nickel,	.82
Protox. of Iron,	33.22	Oxide of Chromium,	.70
Magnesia, - -	19.20	Cobalt and Soda,	a trace.

9. *Meteoric Iron from Potosi*.—H. M. Juben, a lieutenant in the French Navy, among other minerals which had been presented to him, brought from Peru a piece of meteoric iron found near Potosi in Bolivia; it was stated to him to be meteoric iron of great purity; it is cavernous, being filled with vacuities, most of which are irregular, but some have the form of a rhombic dodecahedron; some of them also are filled with a greenish vitreous substance similar to the Olivine of Pallas. No traces whatever

of fusion appear, although the mineral evidently indicates the action of a high temperature. The tenacity of this iron is extremely great, but it is readily hammered and filed. It does not oxidize even when exposed to a moist atmosphere. Its specific gravity is 7.736. The mean of three analyses performed by M. Morren give us its composition—

Iron,	-	-	-	-	-	90.241
Nickel,	-	-	-	-	-	9.759—100.

This iron is remarkable on account of the large quantity of nickel; no trace either of copper, cobalt or manganese was discoverable. The specimen is deposited in the museum of Angers.—*Chronique Scientifique*, 24 Feb. 1839, in Lond. and Ed. Phil. Mag. May, 1839.

10. *Encke's Comet*.—During its recent return to the perihelion, this comet has been carefully watched by observers in various parts of Europe. At Breslau, it was first detected as early as the 19th of August, 1838, by M. Boguslawski. At Berlin, it was first seen on the 16th of September, and in England and France about the same time. At Marseilles, M. Valz observed with much attention the changes of the comet's dimensions: He estimates its volume on the 10th of October to have been 826 times as great as on 24th of November following. He obtained a view of the body as late as the morning of the 12th of December, two days before its perihelion passage. The differences between the observed and the calculated places of the comet have been found very slight. According to Gautier, they indicate that the mass of Mercury was assumed too large by M. Encke.

11. *Remains of the Mastodon in Missouri*.—In various parts of this vast continent, remains of the *Mastodon* have been occasionally disinterred.* I have recently obtained an uncommonly large, entire, head of the *Mastodon*, together with many of the other bones. The circumstances attending its discovery are these:

A few weeks since, receiving information from a friend that many large bones were found on the land of Captain Palmer & Co., about 22 miles south of St. Louis, I immediately proceeded to the spot; and through the politeness and encouragement of Captain Palmer, commenced operations, which proved more successful than my most sanguine anticipations. The outside formation and peculiar construction of the upper part of the head is different from that of any quadruped in Natural History that I am acquainted with. It is composed of small cells about three quarters of an inch square, and about three inches deep, covered by a thin cranium; attached to the upper jaw is the snout which projects

* We have omitted a few lines in this place as being erroneous in fact, since several entire skeletons have been made up, and an entire head is described and figured in our Vol. 36, page 189.

about eighteen inches over the lower jaw, and which has never been described before.

The position of the tusks in the head, has been a subject of discussion among Naturalists, and they have been placed in the same manner as those of the Elephant. It gives me pleasure to state, that I can now settle this question—for in the head which I discovered, I found a tusk firmly implanted in the socket, and had it conveyed with great care to my museum, but owing to the ignorance and carelessness of a laborer, in carrying it up stairs, it was broken off, but its position can be proved by a number of gentlemen of the highest respectability. The tusks are not situated in the same position as those of the Elephant, as was supposed by some. They diverge outwards from the head with the convexity forward, and the point turning backwards in the same plane with the head; the tusk found in the head measures ten feet one inch, from the base to the tip, following the outside of the curvature, and two feet in circumference near the socket. The other tusk measures only nine feet—part of the roof is wanting. When placed in the head in their original position, the distance from tip to tip, measures sixteen feet. I may add, that it required two stout men to carry the largest tusk, and two yoke of oxen to carry the head and tusks from the place of disinterment to the museum.

Besides the *mastodon's* head, I have found near the same place, several highly interesting remains of antediluvian animals, one of which especially merits attention. It is the head of a nondescript animal, which appears to have been superior in size to the largest elephant, and which resembles somewhat the mastodon in the hind part of the head, but the front part is entirely different; and until it is recognized or proved to have been previously discovered, I shall name it Koch's Missouriian, in honor of the State it is discovered in, and intend, in a very short time to give a minute description of it, as well as of a great many relics not herein mentioned.

A. KOCH, *Proprietor of the St. Louis Museum.*

St. Louis Com. Bulletin of June 25, quoted in Phil. Nor. Am. July 11, 1839.

12. *Latanium, a new metal.*—Berzelius, in a letter to M. Pelouze, dated Feb. 22, 1839, states that M. Mosander in submitting to analysis the cerite of Bastnaes, in which cerium was met with 25 years ago, has discovered a new metal. The oxide of cerium, separated from the mineral by the usual process, contains nearly two fifths of its weight of the oxide of the new metal, merely altered by the presence of the cerium, and which, so to speak, is hidden by it. This consideration induced M. Mosander to give the new metal the name of *latane* or *lantane*.

It is prepared by calcining the nitrate of cerium, mixed with nitrate of latanium. The oxide of cerium loses its solubility in weak acids,

and the oxide of lanthanum, which is a very strong base, may be separated by nitric acid, mixed with 100 parts of water.

Oxide of lanthanum is not reduced by potassium; but by the action of potassium on the chloride of lanthanum, a gray metallic powder is obtained, which oxidises in water with the evolution of hydrogen gas, and is converted into a white hydrate.

The sulphuret of lanthanum may be produced by heating the oxide strongly in the vapor of oxide [sulphuret?] of carbon. It is of a pale yellow color, decomposes water with the evolution of hydrosulphuric acid, and is converted into a hydrate.

The oxide of lanthanum is of a brick-red color, which does not appear to be owing to the presence of oxide of cerium. It is converted by hot water into a white hydrate, which destroys the blue color of litmus paper reddened by an acid; it is rapidly dissolved even by very dilute acids; and when it is used in excess, it is converted into a subsalt. The salts have an astringent taste, without any mixture of sweetness; the crystals are wholly of a rose-red color. The sulphate of potash does not precipitate them, unless they are mixed with salts of cerium. When digested in a solution of hydrochlorate of ammonia, the oxide of lanthanum dissolves, with the evolution of ammonia. The atomic weight of lanthanum is smaller than that assigned to cerium; that is to say, to a mixture of the two metals.

Berzelius has repeated and verified the experiments of M. Mosander.—*L'Institut*, May 14, 1839. *Lond. and Ed. Phil. Mag.*, May, 1839.

13. *Biography of Scientific Men*.—Professor Webster of Harvard University has nearly ready, from the press, a selection from the biographies of eminent scientific men in Europe, more particularly of those who have largely contributed to the progress of chemical science. The work will comprise translations from the admirable "Eloges" delivered before the French Academy of Sciences, by Cuvier, Arago, &c., and from the memoirs published in the various philosophical Journals and Transactions of other learned societies in Europe. A copious list of the writings of the individuals will be connected with the biography of each, and great facilities be thus afforded to the student for reference to original papers.

The size of the volume will be between four and five hundred pages, and the price not to exceed three dollars. We cannot doubt that this work will prove both valuable and interesting. Few persons in this country can have access to the original sources of information; and Prof. Webster is therefore performing an acceptable service by bringing the history, the labors, and the personal traits of many eminent men before the American public. It is superfluous to add that he will acquit himself with good

judgment and ability; and we wish him that full success which we trust he will obtain as he deserves it well. Subscribers' names will be received by the editor of this Journal, by James Munroe & Co., booksellers, Boston, and S. Colman, 8 Astor House, New York.

The volume will contain biographical notices of—Ray, Priestley, Fourcroy, Wollaston, Cuvier, Leslie, Van Swinden, Knight, Young, Henry, Peron, Hutton, Playfair, Piazzzi, Fraunhofer, Breguet, Fourier, Herschel, Pallas, Count Romford, Vauquelin, Volta, &c. &c.

14. *Note by Mr. E. F. Johnson, Civil Engineer.*—In the article in the present number of this Journal, entitled "Mountains in New York," the angular depression of Whiteface Mountain from Mt. Marcy is quoted erroneously from the report of Prof. Emmons at 15'. The depression of 15' applies according to Prof. E. to Whiteface as seen from Dial Mountain, a high peak situated a short distance S. E. from Mt. Marcy. At the time of writing the article I had not access to the report of Prof. Emmons. The error originated in the use of some rough and imperfect notes in pencil made nearly a year since, and which were in consequence partially defaced. The depression of 15' of Whiteface from Dial Mt. corresponds very nearly with the difference (234 ft.) in elevation of those two peaks, comparing the height of the latter as given "approximately by levelling," by Prof. E., and the former as determined trigonometrically by myself.

15. *A Northern Lynx taken in Connecticut.*—A wild animal of the genus *Felis*, was trapped at Southington, Conn., during the night of March 21, 1839, and was shot the next morning by the person who found it in the trap. It weighs thirty-two pounds. Its length is nearly three feet; tail about four inches long and tipped with black. The species to which it belongs is probably the *F. borealis*, Temm., although it does not entirely agree with the description given in Richardson's *Fauna Boreali-Americana*. Further investigation is requisite to settle the species satisfactorily, especially as the *Lynxes* of North America are not yet well determined. The animal in question, doubtless strayed from the north, and its like is rarely seen within the limits of this State. E. C. H.

16. *Preservation of animal fat for Soap Making, by D. Tomlinson, Schenectady, July, 1838.*—Fat saved for making soap soon passes, especially in hot weather, to a spoiled and offensive condition; sometimes with the loss, in this manner, of the fat, or it is devoured by rats. None of these occurrences happen in my house: nor is the fat boiled in lye to make soft soap. The fat, as it is saved from time to time, is put into a prepared cask, and strong lye is added to it. As it accumulates in quantity, lye is added, and occasionally stirred by a stick. When the cask is full, the soap is already made and ready for use. The lye cask

is filled with ashes for leaching, and the lye is drawn off to add to the soap cask, and more water is added; and thus by filling water and draining, the solution becomes weak, when it is used for bleaching, &c. When the lye cask is emptied, it is filled immediately with ashes, to be used as above mentioned, so that the cask is always in use; by which means it is kept in order, and lasts many years. When left empty, as some persons practice, it shrinks and soon becomes useless. Some quick lime put into the ash cask, near the bottom, causes the lye to be more caustic.

Cedar and white pine make the best casks for lye or soap. The pine should be free from knots and resin, as the lye will incorporate with the resin, convert it to soap, and leave the wood porous and leaky.

When soap has accumulated beyond the wants for soft soap, it is converted into hard soap, by adding one quart of salt to three gallons of soap; it is then boiled and put into tubs, &c., to cool. It is then cut into pieces, the froth scraped off—then melted again to a boiling heat, leaving out the lye at bottom, put it in a box to cool, and cut into bars for drying. A little rosin or turpentine added before boiling, improves the color and quality of the hard soap.

N. B. In winter, the leach tub should be set in the cellar, or where it will not freeze—or, when filled, the ashes should be only dampened with water, not to freeze, and it should stand till spring, before it is leached, to prevent freezing.

I omitted to say, that this mode of making soap relieves from the Pagan practice of boiling soap at a certain state of the moon.

17. *Notice of Vespertilio pruinosus* and Icterus Phœniceus.*—Sir:—I improve this opportunity to inform you that on the 8th inst., (July, 1839,) I obtained in my garden the *Vespertilio pruinosus*, (Hoary Bat,) of Say, and answering perfectly to the description of Dr. Godman in his Natural History, Vol. I, page 68. It is the first instance that I have learned of its being found north of Pennsylvania.† One was captured by Barton some years since near Philadelphia and presented to the museum in that city. “Mr. T. Nuttall also observed it at Council Bluffs.” Upon capturing the animal, I found to my surprise, two young ones attached to the breasts of the mother, nearly equal to her in size. It indeed required a number of violent efforts to shake them off, and they then again immediately attached themselves to the breasts of the mother as before. The latter measured $4\frac{1}{2}$ inches in length and $11\frac{1}{2}$ inches in alar extent. The

* Extract of a letter from Rev. James H. Linsley, to the junior editor, dated Stratford, July 22d, 1839.

† We presume our correspondent has not seen the Journal of the Essex Co. Nat. Hist. Soc. No. ii, where a similar occurrence is recorded Vid. this No. p. 187-8.

young measured each $3\frac{1}{2}$ inches in length and 3 inches across the wings. The old was a light yellow, and the young about the color of the chinchilla, of S. A. I immediately prepared the three for my cabinet, and while so doing, noticed that the stomachs of the young were remarkably distended with milk.

Before I close this article, allow me to add that I have observed the red wing (*Icterus Phoeniceus*) to be carnivorous. No writer that I have seen makes any mention of flesh in describing the food of the *red wing*. A friend assures me that while riding out the first week in June last, he saw a female bird of this species feeding very intently on the ground, and as he passed near she laid hold of something nearly as long as her own body, and made several unsuccessful attempts to rise with it in her bill. It proved to be the skeleton of a bird completely cleaned of flesh, which by a few of the primaries attached to the wings, appears to have been the semi-palmated Ringed Plover.

18. *Malaria*.—Thomas Hopkins, Esq., at the conclusion of a memoir read before the Lit. and Phil. Society of Manchester, England, Nov. 15, 1838, presents the following summary of the effects of water in generating malaria.

It may be presumed that in those parts of the world which have a high temperature, malaria will be found, and especially when the air has been sometime stagnant, in the following situations, viz :

1. Over the open sea. It will be mild here, because the temperature is not very high.

2. Over slowly moving rivers. They will be somewhat more heated by the sun than the sea is, and will therefore evaporate more freely.

3. Over meadows and woods. The great extent of moist surfaces admits of great evaporation from these.

4. Over shallow stagnant water. The temperature of the water will be high, and evaporation consequently great.

5. Over tide sands and muds. These become very hot, and consequently evaporate copiously.

6. Over marshes. These combine great heat, extensive surface for evaporation, and abundant moisture.

The author proposes that hygrometrical, barometrical and thermometrical tables should be kept at various places, in order to judge how far moisture and heat with variations of pressure affect the production of malaria. He gives the following table of mortality to illustrate local agencies on health.

“A Table of the Deaths per 1000 of Strength, and the portion of those who died of Fever, per Annum, of the White Troops in the West Indies, being the average of the returns for the Twenty Years

from 1817 to 1836, arranged in the order of the Mortality. Taken from the Official Report from Twenty-two Stations.

	Deaths in 1000.	Deaths by Fever,
1. The Bahamas,	200	
2. Savannah la Mar,	200	
3. Montego Bay,	178-9	150-7
4. Spanish Town,	162-4	141-1
5. Tobago,	152-8	104-1
6. Port Antonio,	149-3	126-0
7. Up Park Camp,	140-6	120-8
8. Dominica,	137-4	49-3
9. St. Lucia,	122-8	63-1
10. Port Royal,	113-1	93-9
11. Trinidad,	106-3	61-6
12. Falmouth,	102-6	80-0
13. Stony Hill,	90-2	70-5
14. British Guiana,	84-0	59-2
15. Lucea,	84-9	63-2
16. Fort Augusta,	73-5	55-5
17. St. Kits, Nevis and Tortola,	71-0	42-1
18. Grenada,	61-8	26-3
19. Barbadoes,	58-5	11-8
20. St. Vincents,	54-9	11-2
21. Antigua and Montserrat,	40-6	14-9
22. Maroon Town,	32-7	15-3

Lond. and Edin. Phil. Mag., Jan. 1839."

19. *Electrical Excitement in Leather by Friction.*—The Rev. Thos. Drury, under date of Dec. 17, 1838, at Keighley Rectory, Yorkshire, England, communicates the following fact to Dr. Faraday.

He speaks of what he terms an extraordinary electrifying machine, which is no other than a leather strap which connects two drums in a large worsted mill in the town of Keighley. "The dimensions and particulars of the strap are as follows:

It is in length	24 feet
Breadth	6 inches
Thickness	$\frac{1}{8}$ do.

It makes 100 revolutions in a minute.

The drums, over which it passes at both ends, are two feet in diameter, made of wood fastened to iron hoops and turning on iron axles; these drums are placed at 10 feet distance from each other, and the strap crosses in the middle between the drums, where there is some friction; the strap forming a figure of eight. There is no

metal in connexion with the strap, but it is oiled. If you present your knuckle to the strap above the point of crossing, brushes of electrical light are given off in abundance, and when the points of a prime conductor are held near the strap, most pungent sparks are given off to a knuckle at about two inches; I charged, says Mr. D., a Leyden jar of considerable size in a few seconds by presenting it to the prime conductor. The gentleman who told me of this curious strap has frequently charged his electrical battery in a very short time from it, and he informed me that it is always the same, generating electricity from morning to night without any abatement or alteration. If this strap had the advantage of silk flaps and a little amalgam, it would rival the machine in the lecture room in Albemarle-street."—*Ib.*

20. *Great Scheme for Magnetical Observations.*—The Joint Physical and Meteorological Committee of the Royal Society of London—of which Sir J. F. W. Herschel is president—have agreed to recommend to her majesty's government the establishment of regular observations of the magnetical intensity, dip and variation on the following stations:

In Canada, St. Helena, Van Dieman's Land, Ceylon, and the Cape of Good Hope.

The observations to be made hourly with magnetometers during three years from their commencement.

That on certain selected days, and upon a common plan concerted with each other and with European observatories, "the fluctuations of the same elements shall be observed during twenty-four successive hours, strictly simultaneous with one another, and with intervals of not more than five minutes," &c. &c.

As it is uncertain whether the government will adopt the plan proposed, we omit the remaining details.—*Ib.*

21. *Action of Spongy Platina.*—M. Kuhlmann has described several new reactions determined by spongy platina. Among which are the following:

1st. Ammonia mixed with air on passing at a temperature of about 572° Fahr. over spongy platina is decomposed, and the azote which it contains is completely converted into nitric acid by combining with the oxygen of the air.

2nd. Cyanogen and air, under similar circumstances, occasion the formation of nitric acid and carbonic acid.

3rd. Ammonia, when combined so as to form a salt, acts in the same way as free ammonia.

4th. Free azote cannot in any case be combined with free oxygen, but all the compounds of azote, under the influence of spongy platina, yield nitric acid.

5th. Nitrous and nitric oxides, hyponitric, and nitric acids mixed with a sufficient quantity of hydrogen, are converted into ammonia by their contact with spongy platina, and frequently without even the assistance of heat. The action is frequently so energetic that violent explosion ensues. All the azote of these oxides or acids passes to the state of ammonia, by combining with the hydrogen. An excess of nitric acid gives nitrate of ammonia.

6th. Cyanogen and hydrogen give hydrocyanate of ammonia.

7th. Olefiant gas and excess of nitric oxide, when hot and passed over spongy platina, produce carbonate and hydrocyanate of ammonia and water.

8th. With nitric oxide and excess of the vapor of alcohol, there are obtained under the same circumstances, the same compounds as above, and olefiant gas and a deposit of carbon.

9th. Free azote could not be combined with free hydrogen, but all the compounds of azote were converted into ammonia by hydrogen, either free or carburetted.

10. In the last mentioned reactions, the presence of carbon in combination with azote or with hydrogen, occasions the formation of hydrocyanic acid.

11th. All the gaseous or vaporizable metalloids, without any exception, combine with hydrogen under the influence of spongy platina.

12th. The vapors of nitric acid mixed with hydrogen are totally converted into acetic æther, and water, at a moderate temperature.

M. Kuhlmann remarks that when precipitated platina (noir de platine) is substituted for spongy platina, the action is infinitely less energetic in the greater number of cases, which is the reverse of what might be expected. The precipitated platina has indeed no power in producing nitric acid, it is very weak in producing ammonia, and it never becomes incandescent as happens with spongy platina; but in converting acetic acid into æther, the action of precipitated platina is on the contrary more quick, and produces it even at common temperatures.

It has been subsequently remarked that Berzelius has before stated that when nitric oxide is mixed with hydrogen gas, and the mixture exposed to partly calcined spongy platina, water and ammonia are gradually formed, on account of the union of the hydrogen with both the elements of the nitric oxide.—*Traité de Chimie*, ii, 43—44; *L'Institut*, No. 261—262.—*Ib.*

22. *Formation of Metallic Veins by Galvanic Agency.*—Mr. Fox says, that he has succeeded not only in forming well-defined metalliferous veins in a crack in the middle of masses of clay by means of vol-

taic agency, but also in imparting to the clay a laminated or schistose structure; the veins and laminae being perpendicular to the voltaic forces. In some instances only a pair of plates, or in preference copper pyrites and zinc, were employed to produce the voltaic action; but a constant battery consisting of several pairs of plates was much more effective. Among the veins thus produced in clay, Mr. Fox mentions oxide and carbonate of copper, carbonate of zinc, oxides of iron and tin. Veins of carbonate of zinc were formed, sufficiently firm to admit of being taken out in plates of the size of a shilling. Mr. Fox then describes a vein formed in pipe-clay, by Mr. Jordan, by five pairs of cylinders, in three weeks. The clay divided an earthenware vessel into two cells, in one of which, containing the copper plate, a solution of sulphate of copper was put; and in the other, or zinc cell, a solution of common salt. Well-defined veins were thus produced of carbonate and oxide of copper, and carbonate of zinc, parallel to the laminae into which the clay divided; as well as another of carbonate and oxide of copper at right angles to them. On dividing the mass of clay in the direction of the principal horizontal vein, the carbonate of zinc was found on the negative side, or towards the copper plate: and the carbonate of copper nearest the zinc plate: and as the former must have been derived from the zinc plate, it is curious to observe such a complete transposition of the respective metals.

Mr. Fox is of opinion that these results have a strong bearing on the numerous mineral veins and beds which are found conformable to the direction of the laminae of the containing rocks, as well as on those veins which traverse the laminae of the conformable veins.—*Ib.*

TO OUR SUBSCRIBERS AND READERS.

In No. 73, April 1839, we gave notice that we should publish a duplicate No. in July, and the present No. being the second for that month, appears in fulfillment of our promise. The reason assigned was to avoid linking together two years by the same volume,—that in future we may finish a volume in the last quarter of the year, and begin a new volume with a new year,—thus avoiding a degree of confusion which had been often experienced in the orders for the work. Our subscribers will therefore please, on the appearance of the October No., to pay up to that time, including both Nos. of Vol. 37, and making 5 Nos. instead of 4 for the year 1839. In January, with the appearance of No. 1 of Vol. 38, payment may be made in advance for the year 1840. Thenceforward the Journal year will go along with the calendar year.

Notices of several valuable works received from authors and publishers are omitted for want of room.

NOTICE TO SUBSCRIBERS AND AGENTS.

The Editors will pay \$1 00 in cash per No. for the following numbers of the American Journal of Science. Or if preferred, they will credit them to the account of any subscriber at the rate at which recent numbers are charged. Or they will exchange for them such other numbers as may be desired of which they have a supply. The Nos. wanted are shown below in a tabular form. If any No. is sent by mail, the word RETURNED must be put on the envelope.

Vol.	V.	XI.	XIII.	XIV.	XVI.	XVII.	XXII.	XXVII.
Number	2.	1.	1, 2.	1, 2.	1, 2.	1, 2.	1, 2.	1, 2.
Entire No.	12.	24.	27, 28.	29, 30.	33, 34.	35, 36.	45, 46.	55, 56.

TO EDITORS OF NEWSPAPERS.

We regret that for important reasons we must generally decline the exchanges that are frequently offered us ; but occasionally we are happy to receive newspapers containing interesting notices, and we may sometimes send a single No. of this Journal in acknowledgment, and to be shown as a specimen of the work.—*Eds.*

New Haven, Conn. Aug. 8, 1839.

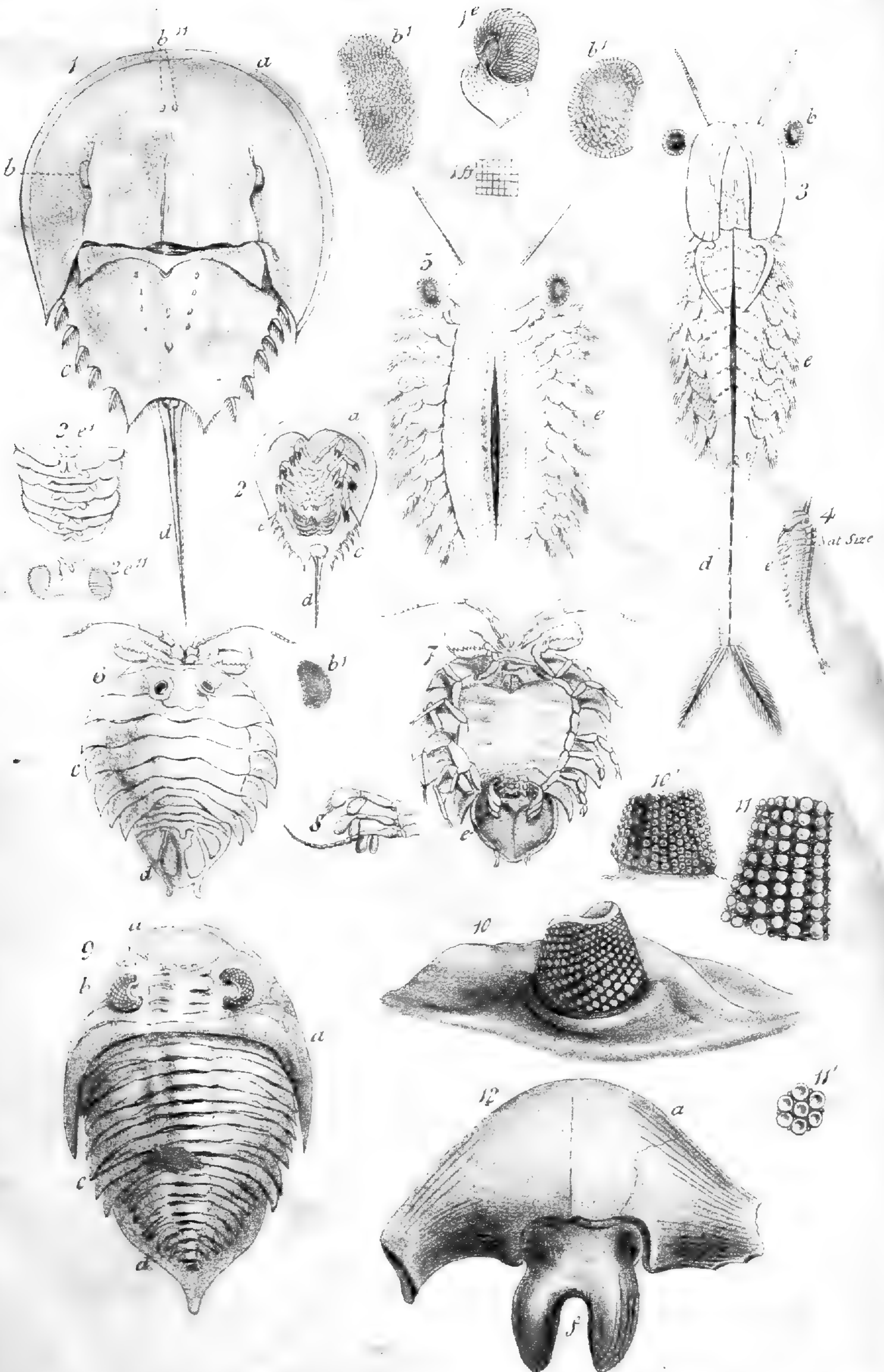

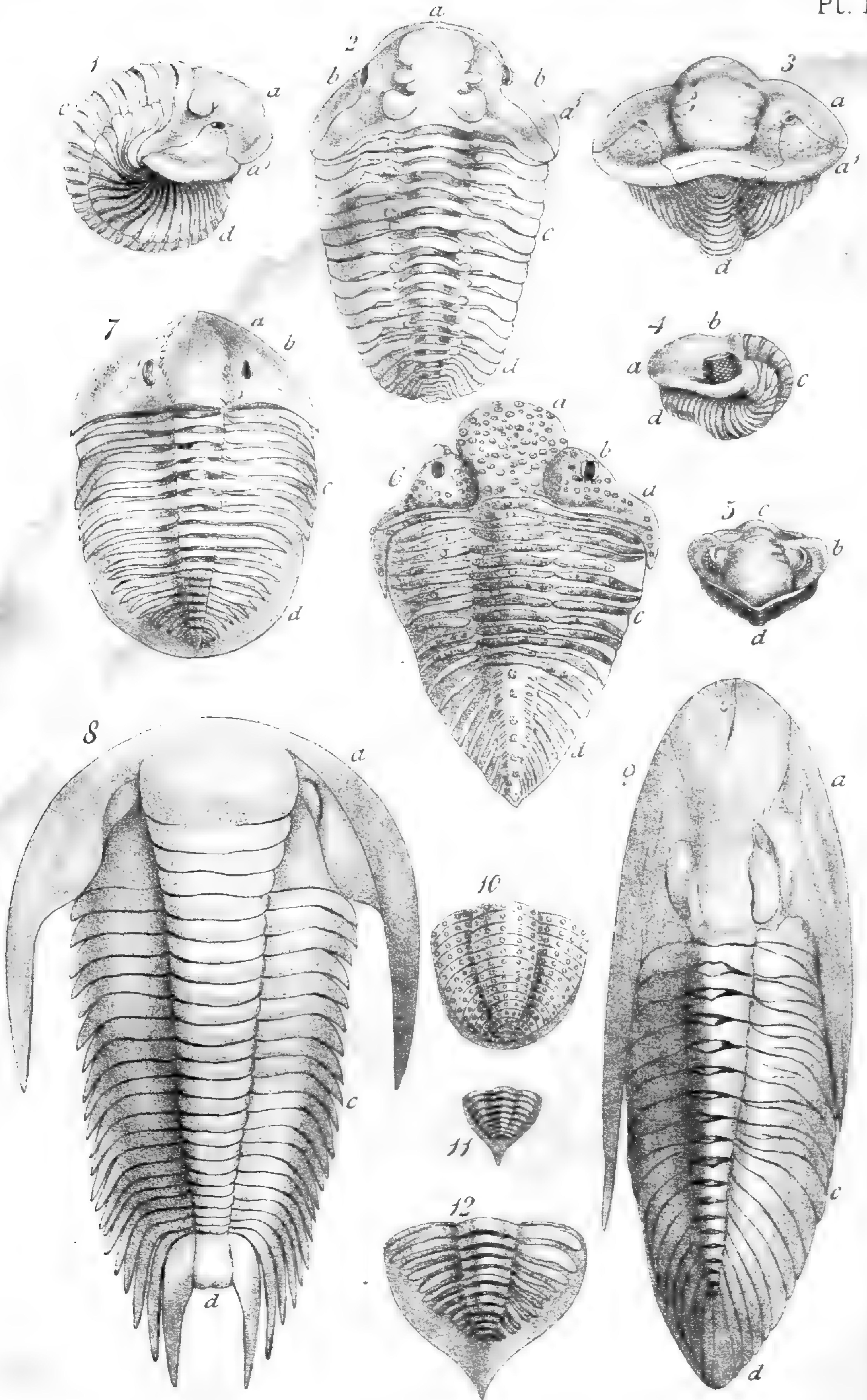

TRILOBITES.

Lith. of D W Kellogg & Co

110 Main St Hartford, Conn.

From Buckland's Bridgewater Treatise

THE AMERICAN JOURNAL, &c.—AGENTS.

MAINE.
 Saco, Rufus Nichols.
 PORTLAND, Colman, Holden, & Co.
VERMONT.
 BRATTLEBORO', G. H. Peck.
NEW HAMPSHIRE.
 Dart. Coll. HANOVER, { Prof. Oliver P. Hubbard.
MASSACHUSETTS.
 NEWBURYPORT, Charles Whipple.
 SALEM, Henry Whipple.
 NEW BEDFORD, William C. Taber.
 SPRINGFIELD, G. & C. Merriam.
 NORTHAMPTON, S. Butler & Sons.
 AMHERST, J. S. & C. Adams.
 WORCESTER, { Dorr, Howland, & Co.
 { Charendou Harris.
 LOWELL, D. Dixby.
RHODE ISLAND.
 PROVIDENCE, B. Cranston & Co.
CONNECTICUT.
 HARTFORD, Canfield & Robins.
 NORWICH, Thomas Robinson.
 MIDDLETOWN, Luke C. Lyman.
NEW YORK.
 NEW YORK, A. T. Goodrich.
 WEST POINT, John DeWitt.
 NEWBURGH, H. P. Bestham.
 ALBANY, W. C. Little.
 TROY, Elias Gates.
 ITHACA, D. D. Spencer.
 CANANDAIGUA, Morse & Harvey.
 AUBURN, L. Briggs.
 LITTLE FALLS, Edward M. Griffing.
 ROCHESTER, Hoyt, Porter & Co.

BUFFALO, O. G. Steele & Co.
PENNSYLVANIA.
 PITTSBURGH, John J. Kay & Co.
MARYLAND.
 BALTIMORE, N. Hickman.
DISTRICT OF COLUMBIA.
 WASHINGTON, Frank Taylor.
NORTH CAROLINA.
 CHAPEL HILL, Prof. F. Mitchell.
SOUTH CAROLINA.
 COLUMBIA, B. D. Plant.
 CHARLESTON, John P. Beile.
VIRGINIA.
 RICHMOND, R. I. Smith & Co.
 WHEELING, J. Fisher & Sons.
 NORFOLK, Richard Worthington.
ILLINOIS.
 PEORIA, Silas W. Robbins.
OHIO.
 COLUMBUS, I. N. Whiting.
GEORGIA.
 SAVANNAH, Wm. T. Williams.
 AUGUSTA, Th. I. Wray.
 COLUMBUS, J. C. Plant & Co.
TENNESSEE.
 NASHVILLE, Wm. A. Eichbaum.
 MEMPHIS, Fowkes & Pugh.
ALABAMA.
 HUNTSVILLE, Irby & Smith.
 MOBILE, Woodruff, Fiske & McGuire.
MISSISSIPPI.
 GRAND GULF, Wm. M. Smyth.
CANADA.
 QUEBEC, Samuel Nelson.
 MONTREAL, Armour & Ramsay.

TERMS.

Six dollars per annum; published in four Quarterly numbers, making two volumes a year, of from eight to nine hundred pages for both volumes, which are fully illustrated by plates.

Terms of credit to general agents, six months from the publication of No. 1, of each volume.

The Editor will draw on the agents, semi-annually, i. e. on the publication of No. 2 of each Vol., payable, six months from the publication of No. 1, in all cases, where payment is not otherwise provided for.

Complete sets, now 36 vols., are furnished at a suitable discount.

The expense of this Journal being greater, and the patronage less than that of the literary journals, the price is necessarily one dollar more per annum.

TO CORRESPONDENTS.

This work is most safely and expeditiously transmitted to distant subscribers by mail. This No. contains 13 sheets; postage, under 100 miles, 20 cents, over 100 miles, 32½ cents.

The titles of communications and of their authors, to be fully given.

When extra copies are desired, the notice should be placed at the head of the MS.

Notice always to be sent of discontinuance, removals and deaths of subscribers.

Return proofs, not to be sealed, or inscribed with any thing except corrections.

Notice to be given when communications are intended, also, for other Journals.

THE
AMERICAN
JOURNAL OF SCIENCE, &c.

ART. I.—*Chemical Examination of the Fire-Damp from the Coal Mines near Newcastle.** By [the late] EDWARD TURNER, M. D., F. R. S. London and Edinb., V. P. G. S., Professor of Chemistry in the University of London.†

THE gases subjected to examination were collected under the direction of Mr. Hutton, by emptying Winchester quart bottles filled with water, at the spot where it was designed to collect the gas, and then inserting a well-greased ground-glass stopper, which was afterwards secured in position by cement, and a covering of bladder. About half an ounce of water was left in each bottle, and the bottles were sent to me packed in boxes in an inverted position. In most instances, when the stoppers were withdrawn

* From the London and Edinburgh Philosophical Magazine and Journal of Science, Vol. 14, No. 85, January, 1839.

[† From the Transactions of the Natural History Society of Northumberland, Durham and Newcastle-upon-Tyne, vol. ii. Part ii.] From the period of its institution, the Natural History Society had directed particular attention to the evolution of gas in coal mines, and many papers had been read from time to time, when the feelings of the public were most painfully excited to the subject by the awful calamity at Wallsend Colliery, on the 18th of June, 1835, described by Mr. Buddle in the preceding paper [in the Society's Transactions.] At this time an inquiry was in progress before a Committee of the House of Commons, which soon after published its report. It was given in evidence before this Committee, that both free hydrogen and olefiant gas occur in the atmosphere of some coal mines; this, as striking at once at the efficacy of the Davy lamp in preventing explosions, seemed to be a matter requiring immediate attention in a district where that instrument is so extensively used, and where its safety is so entirely relied upon. With this view, immediately after the publication of the Parliamentary Report, the Natural History Society determined to institute such an inquiry, and Mr. Hutton was directed to

in the pneumatic trough, a portion of water instantly rushed in, showing both that the means of securing the gases had proved effectual, and that the gases within the mine were in a more rare state than in my laboratory.

As one of the principal objects of the inquiry was to determine in how far the gas of different mines varied in chemical constitution, it was material to multiply as much as possible the samples of gas submitted for examination. The number of samples actually received and examined by me, amounted to twelve. The result of this analysis will be given in a tabular form at the close of this communication. The general conclusion deducible from them is, that the essential and sole inflammable material of fire-damp, as formerly found by Dr. Henry and Sir Humphrey Davy, is the light carburetted hydrogen, or marsh gas of chemists, which issues in a state of purity from coal, wholly free from admixture with hydrogen, carbonic oxide, or olefiant gases, and but rarely

communicate with the committee of the coal trade to ask their valuable co-operation and assistance; for this purpose he addressed the following letter to Robert William Brandling, Esq., the chairman.

Copy.

“Newcastle, January 9th, 1836.

“Sir,—I beg leave respectfully to state, that at the last meeting of the Natural History Society, after reading a paper on the gas of mines, it was resolved that the Society should do all in its power to promote an investigation into the nature of the gas evolved in our different collieries, for the purposes of ascertaining if any other, and what gas, occurs besides the common carburetted hydrogen, it having been stated in evidence before the late Parliamentary Committee, that free hydrogen and olefiant gas are both to be found in the mines of Wales. I was directed by the Society to bring the matter before the Committee of the Coal Trade, and request their valuable co-operation and assistance in obtaining an extensive analysis by one of the first chemists of the day, so as at once to set at rest the question as to the nature of coal gas spontaneously evolved in this district. Dr. Turner was mentioned as the person best fitted for the task, not only from his great skill as an analyst, but from his extensive knowledge as a geologist, and the attention he has paid to the chemistry of nature, so to speak.

“This investigation will not be an expensive one, and it was thought, from the deep importance of the question as connected with the safety-lamp, that the Coal Trade would have no objections to join the Society in the cost. The Society are anxious that the investigations should be made speedily, as they are about going to press with a conclusion of the second volume of their Transactions, where they would wish this to appear as forming an appropriate Appendix to the many valuable papers in the work connected with our local geology and mining. If the Committee of the Coal Trade agree to give their assistance in this matter, the Society will furnish them with any number of copies of the results of the investigation they may require; and, individually, I most respectfully beg to offer my per-

containing a trace of carbonic acid gas.* The sole difference in the explosive gas of different mines must hence be referred to the degree of admixture with air. If diluted with nineteen or twenty times its volume of air, the mixture does not detonate or take fire at all; on diminishing the proportion of air below this term the mixture becomes inflammable, and on the approach of a lighted candle, a pale blue flame appears, which passes slowly through the mixture when the air is in large excess; rapidly when the ratio is favorably adjusted for combustion. The most explosive mixture, as Davy correctly states in his "Essay on Flame,"† is formed of one measure of pure fire-damp, and about seven measures of air. Such mixture, unlike an explosive mixture made with air and hydrogen or carbonic oxide gas, is not kindled by incandescent solid matter, such as a mass of hot iron; but it burns rashly [rapidly?] in contact with flame, and detonates readily with the electric spark. As the proportion of pure fire-damp rises above a sixth, the mixture burns less and less readily, and the tint of the flame changes at the same time from blue to yellow or brown. The phenomena receive a ready explanation from the well known principles established by Davy.

sonal services in collecting the specimens of gas, and making such arrangements as will secure their conveyance to London unadulterated.

"I have the honor to be, &c. &c.

"WILLIAM HUTTON, Secretary.

"To Robert William Brandling, Esq."

The Coal Trade Committee immediately adopted the suggestion, and appointed John Buddle, George Johnson, and Nicholas Wood, Esq's, to make the necessary arrangements, for collecting the specimens of gas.

* Extract of a letter from Major Emmett, Royal Engineer, to Mr. Hutton, dated Hull, 19th February, 1836.

"I send you the following extracts from a letter from Dr. Dalton of the 13th. As regards Wallsend Pitt, they are important, and to me conclusive. I sent him three bottles Mr. Buddle had collected for me about three months ago, also one of water from the old working at Gateshead Park Pit, forwarded to me by Mr. Wood. Respecting the Wallsend gas he says: 'I received your letters and bottles of gas safely, and soon after opened the bottles under water. The air in each bottle was very much alike. It was constituted of some two or three per cent. of carbonic acid, about one tenth common air rather short of oxygen, and the rest, about eighty-five per cent., was pure carburetted hydrogen, or pond gas, without a trace of either pure hydrogen or olefiant gas.' Respecting the Gateshead water he says, 'The bottle of water from the old waste I also examined; it contained about one per cent. of soluble matter, chiefly common salt, with some carbonic acid, sulphurous acid, sulphuretted hydrogen and lime.'"

[† See Phil. Mag. First Series, vol. xlvi, p. 448.]

The analysis of fire-damp was performed by detonation with oxygen gas over mercury. In successful analysis with all the gases, the diminution in volume subsequent on detonation with the electric spark, and due to gaseous matter condensed as water, was precisely twice the volume of carbonic acid gas which was generated, and equal to the oxygen gas which disappeared. The volume of carbonic acid gas sometimes fell short of half the diminution due to production of water, but this only took place when the combustion was incomplete. Sometimes the gaseous mixture, after detonation, was more or less obscured by a deposit of carbonaceous matter, and in such instances, as already remarked by Dr. Henry, there is always a deficiency of carbonic acid gas, which deficiency is less considerable the more completely the mixture at the moment of detonation approximates to perfect transparency. I have occasionally observed this cloud, even when ample oxygen for complete combustion was present; but with a decided excess of oxygen it generally does not occur at all, or at most in so slight a degree as not to be appreciable. To show the course of the inquiry, I quote three analyses, in the first of which an error, from deposited carbon, is apparent.

I. *Analysis of fire-damp from Jarrow Colliery, which issued from a seam of coal eleven fathoms below the Bensham seam.*

Specific gravity as found by weighing the gas = 0.6209. Tested by nitrous gas it was found in one experiment to contain 2.25 per cent. of oxygen, and in a second 2.1 per cent., indicating as a mean 2.2 per cent. of oxygen, equivalent to 11 per cent. of air. This gas, which was quite free from carbonic acid gas, may be considered as a mixture of 89 measures of real marsh gas with 11 measures of air. A gas so constituted, and assuming 0.5595 as the specific gravity of marsh gas, should have a specific gravity 0.6079; for $0.5595 + 0.89 + 0.11 = 0.6079$. Of this gas 12.3 measures, containing 0.3 of oxygen and 11 of real marsh gas, were fired with 32.7 measures of a sample of oxygen gas, which contained 31 of real oxygen gas:—

Loss due to condensed water	= 22.3
Carbonic acid gas generated and absorbed by potassa	= 9.4
Residual oxygen, determined by firing with hydrogen gas	= 10.5

Deducting $10.5 + 9.4$, the oxygen above accounted for, from 31.3, the whole oxygen gas originally

present, there remain, as Oxygen gas which went to the production of water = 11.4

II. *Analysis of a gas from the Bensham coal seam, Jarrow Colliery, collected from a blower, which caused the accident in 1826.*

Specific gravity actually observed = 0.6381.

This gas was quite free from carbonic acid gas. In two trials with nitrous gas, it was found to contain 3.7 per cent. of oxygen, equivalent to 18.5 of air. A gaseous mixture of 18.5 air, and 81.5 real marsh gas, should have a specific gravity of 0.641, since $0.5595 + 0.815 + 0.185 = 0.641$.

Of this gas 13.5 measures, inferred from the foregoing premises to contain 0.5 of oxygen and 11 of real marsh gas, were fired with 30 measures of oxygen, which contained 28.8 of real oxygen gas.

Loss of volume due to production of water = 22.8

Carbonic acid gas generated = 11.2

Residual oxygen = 6.4

Deducting 17.6 from 29.3 there remain, as Oxygen gas which went to the production of water = 11.7

III. *Analysis of a gas from the Eppleton Jane Pit, Hutton Seam, Hetton Colliery, collected at a depth of 175 fathoms below the surface.*

Specific gravity actually observed = 0.78.

This gas was quite free from carbonic acid. Two experiments with nitrous gas agreed in indicating the presence of 4.6 per cent. of oxygen, equivalent to 23 measures of air. Analysis indicated the presence of 50 per cent. of real marsh gas, leaving 27 per cent. as nitrogen, independently of that already considered as atmospheric air.

Of this gas 11 measures, containing 0.5 of oxygen, were fired with 28 of oxygen gas, which contained 26.9 of real oxygen.

Loss of volume due to the formation of water = 10.5

Carbonic acid gas generated = 5.5

Residual oxygen = 16.4

Deducting $5.5 + 16.4 = 21.9$ from 27.4 there remain as

Oxygen gas which went to the formation of water = 5.5

A gaseous mixture, consisting of 50 measures of real marsh gas, 23 of air, and 27 of nitrogen, should have a specific gravity of 0.7724, since $0.5595 + 0.5 + 0.23 + 0.9727 + 0.27 = 0.7724$.

The first of the foregoing analyses supplies an instance where the loss of carbon was decisive. In the second and third, as in

the whole series of successful analyses, the carbonic acid gas may be taken as exactly equal to half the condensation due to the formation of water, and as containing half the oxygen which was required for complete combustion. The quantity of marsh gas present was equal to half the oxygen required for its complete combustion, to half the condensation due to generated water, and to the volume of carbonic acid gas which was produced. As this was a uniform result in all the samples, it is manifest that the constitution of the inflammable principle of fire-damp is identical with that of marsh gas or light carburetted hydrogen. The proportion of carbon and hydrogen indicated by analysis, sufficiently demonstrate the absence of such gases as hydrogen, carbonic oxide, and olefiant gas. Their absence, however, was proved by other methods. A portion of fire-damp was mixed in a tube with chlorine of known purity, and the mixture kept for a quarter of an hour in a dark place, when the chlorine was absorbed by milk of lime; the original quantity of fire-damp was always recovered, except a slight loss due to the mere washing to absorb the chlorine. The absence of olefiant and carbonic oxide gases was also proved by means of spongy platinum. In 1824, soon after the curious action of spongy platinum in causing the combination of oxygen and hydrogen gases was made known by Dæbereiner, both Dr. Henry and myself pointed out the obstacles to that action, occasioned by carbonic oxide, olefiant gas, and some other gases.* (Philosophical Transactions, and Edinburgh Philosophical Jour. for 1824.) And Dr. Henry at the same time showed that marsh gas differs remarkably in this respect from carbonic oxide and olefiant gases, as it offers scarcely any impediment to the action of platinum. Agreeably to those researches, it follows that, if fire-damp contained merely marsh gas, oxygen and nitrogen, spongy platinum introduced at common temperature, or even heated to 300° Fahr., would not produce any sensible effect; and that if a small quantity of an explosive mixture† made with one measure of oxygen and two measures of hydrogen gases, were added to the fire-damp, spongy platinum should cause a produc-

[* Dr. Henry's paper on this subject, from the Philosophical Transactions, will be found in Phil. Mag. First Series, vol. lxxv, p. 269.—EDIT. PHIL. MAG.]

† By the expression "explosive mixture," I hereafter mean a mixture made with one measure of oxygen and two measures of hydrogen gases.

tion of water corresponding to the quantity of explosive mixture so introduced, without the production of any carbonic acid. But if carbonic oxide or olefiant gas were present, then cold spongy platinum would not act at all, a small proportion of explosive mixture being employed; and if the action were forced by using hot spongy platinum, or by the free introduction of explosive mixture, then would carbonic acid as well as water be generated.

To apply these facts to the case in point, some very active platinum balls, of the size of peas, were made from a mixture of pipe-clay, spongy platinum and the yellow ammoniacal chloride of platinum, the materials being mixed with water so as to form a plastic mass, which after receiving the required size and form, was gently dried, and ignited for an instant before the blow-pipe,* and were introduced into the gaseous mixture over mercury, sometimes cold and at others warm, ten or twenty seconds after incandescence. Their action on all the samples of fire-damp was precisely of the same character with fire-damp, oxygen being previously added or not; the platinum balls, whether cold or warm, were completely inactive. On adding some explosive mixture to the fire-damp, the platinum balls acted readily to their full extent. To give some instances:

I. *With fire-damp from the yard coal seam Burraton Colliery, the specific gravity of which was 0.600.*

With 46.5 measures of this gas, and 12.5 of explosive mixture, a platinum ball, nearly cold, caused in ten minutes a loss of volume equal to 12 measure.

In a second trial the loss in ten minutes was 13.6 in a mixture of 49 measures of fire-damp, and 14.1 of explosive mixture.

II. *With fire-damp from the Bensham coal seam, Wallsend Colliery, the specific gravity of which was 0.6024.*

In a mixture made with 34.3 measures of fire-damp, and 13.1 of explosive mixture, a platinum ball introduced warm, caused in six minutes a loss of volume equal to 12.4 measures.

With 43.5 measures of the same gas, and 22.9 of explosive mixture, the loss in eight minutes was 21.7, the platinum ball being introduced warm.

With 55 measures of the same gas, and 7 of explosive mixture, a cold platinum ball caused a loss of 6.3 in six minutes.

* Before use the little balls were always ignited.

The action was equally rapid with the other gases; nearly the whole explosive mixture disappearing within the first or second minute after the introduction of the platinum ball, whether warm or cold. In no instance did barytic water, subsequently admitted, detect in the residue a trace of carbonic acid gas.

When to any specimen of fire-damp hydrogen was added, the action of platinum always revealed the presence of air. When the quantity of air was small, the action of platinum was of course slow; nor did it in that case indicate with fidelity the quantity of air present, a portion of oxygen not uniting with hydrogen. Thus in the fire-damp from the yard coal seam, Burraton Colliery, nitrous gas, indicated the presence of 6·2 per cent. of air, and platinum only 3·3 per cent. In the gas from the Bensham Seam, Wallsend Colliery, nitrous gas indicated the presence of 9 per cent. of air; whereas platinum detected only five per cent. in one trial, 8·5 per cent. in a second, and 6 per cent. in a third. A certain degree of impediment to the action of platinum by marsh gas is thus rendered apparent. But when the fire-damp was freely mixed with air, then after the hydrogen gas platinum acted freely; and I have found under such circumstances the indications from platinum to coincide with those from nitrous gas. Thus in fire-damp from the low main coal seam, Killingworth Colliery, of specific gravity 0·8226, platinum and hydrogen indicated 9·4 per cent. of oxygen, equivalent to 46·5 of air; and in two experiments with nitrous gas precisely the same result was obtained. A ball of platinum may hence be applied to determine the air in fire-damp, even when its quantity is small, by first diluting the gas with a known quantity of air, or enlivening the action of the platinum by adding some explosive mixture.

To those chemists who chance to be practically conversant with the action of platinum on gaseous mixtures, the evidence above adduced as to the freedom of fire-damp from hydrogen, carbonic oxide, olefiant gas, sulphuretted hydrogen, and similar inflammable gases, will, I doubt not, be quite satisfactory. To myself they do not leave the shadow of a doubt on the question. Those who are not familiar with such researches, may be warned that, in repeating my experiments, they will certainly fail of witnessing the same phenomena, unless they are very scrupulous in having pure gases, and in employing platinum balls with their full energy. The influence of platinum on gases is modified by

such very slight circumstances, that a small matter will cause a ball to be wholly inert which would otherwise have acted with effect.

In applying nitrous gas to determine the quantity of oxygen in fire-damp, I employed the method of Dr. Dalton, as described by Dr. Henry's Elements of Chemistry. A measured quantity of fire-damp was added to the nitrous gas contained in a graduated tube half an inch wide, and the gases were allowed to act on each other over water, without agitation. The diminution of volume had attained its maximum in five or six minutes, and in general much sooner. Of the total loss, $\frac{1}{2}$ ⁰/₇th were taken as oxygen. This method is not in all cases rigidly correct, but its indications were sufficiently exact for my purpose, controlled as they were by the action of platinum, by the analysis of the gas by detonation with oxygen, and by the specific gravity of the gases. Before relying at all on this method, however, I applied it in the analysis of gaseous mixtures containing known quantities of oxygen gas. On applying it to the analysis of atmospheric air it indicated 20·4 per cent. of oxygen. On agitating the air and nitrous gas, just after admitting them into the same tube, the diminution in volume was excessive. In a specimen of nitrogen gas, to which so much air was admitted that the whole mixture contained 3 per cent. of oxygen, nitrous gas indicated 3·3 per cent. of oxygen in one experiment, and 3·2 in a second. With nitrogen, which contained 3·6 per cent. of oxygen, nitrous gas indicated 4·4 in one trial, and in a second 4·1 per cent. of oxygen. In nitrogen gas, with 4·7 per cent. of oxygen, nitrous gas indicated 4·7 per cent. in one trial, and 5·2 in the second. In nitrogen containing 7·3 per cent. of oxygen gas, nitrous gas indicated 7·4 in the first experiment, and 8·4 in the second. In the last case a large excess of nitrous gas was employed. In nitrogen gas in one experiment, and 11·5 in a second.* In this last case also nitrous gas was used in large excess.

In these experiments the error is very uniformly such, that more oxygen was indicated than was actually present. The causes of error appear to be especially twofold,—agitation, and a large excess of nitrous gas. By permitting the action to ensue tranquilly, and avoiding much excess from nitrous gas, the indi-

* There appears to be some omission here.—EDIT. PHIL. MAG.

cations in my trials were uniform, and very nearly true. Applying the same method to fire-damp, I found that in two or more trials with the same gas the indications hardly ever differed so much as 1 per cent. of oxygen; and in general, as in several instances already given, the coincidence in different experiments was exact. Having now mentioned all that appears necessary to elucidate the chemical nature of the different samples of fire-damp from the mines of Newcastle, I conclude this account of the examination by inserting a tabular view of the composition of all the gases which have been analysed.

	Mines in which the Gas was collected.	Specific Gravity.		Marsh Gas.	Air.	Nitrogen.	Carb acid.
		Observed	Calculated				
1.	Bensham Coal Seam, Wallsend Colliery,	0.6024	0.5991	91	9	0	0
2.	Yard Coal Seam, Burraton Colliery,	0.600	0.5903	93	7	0	0
3.	High Main Seam, Killingsworth Colliery,	0.6196	0.6236	85	8	7	0
4.	Low Main Seam, Killingsworth Colliery,	0.8226	0.8325	37	46.5	16.5	0
5.	Marquis of Londonderry's Pensher Colliery, from the Hutton Seam Waste, 125 fathoms deep,	0.966	0.9662	7	82	11	0
6.	Marquis of Londonderry's Pittington Colliery, Adelaide Pit, Hutton Seam, 45 fathoms below the surface,	0.866	0.8755	28	67.5	4.5	0
7.	Eppleton Jane Pit, Hutton Seam, Hetton Colliery, 175 fathoms below the surface,	0.747	0.7677	50	6	44	0
8.	Blossom Pit Main Coal Seam, Hetton Colliery, 100 fathoms below the surface,	0.78	0.7724	50	23	27	0
9.	Bensham Coal Seam, Jarrow Colliery,	0.6381	0.641	81.5	18.5	0	0
10.	Jarrow Colliery Seam, 11 fathoms below No. 9,	0.6209	0.6079	89	11	0	0
11.	Bensham Seam, Willington Colliery, 145 fathoms from the surface,	0.7278	0.7175	68	28.7	0	3.3
12.		1.	1	0	100	0	

The gas, No. 12, proved to be unmixed air. I have no remarks to offer respecting the nitrogen found in some samples of the fire-damp beyond what will readily occur to other chemists, who, I apprehend, will consider its presence as a simple consequence of oxidizing processes, especially of metallic sulphurets, abstracting oxygen from atmospheric air.

ART. II.—*Observations on the Geology of the Trinity Country, Texas, made during an excursion there in April and May, 1839.* By J. L. RIDDELL, M. D., Professor of Chemistry in the Medical College of Louisiana.

It is well known that, as you proceed inland from the Gulf of Mexico in Eastern Texas, to the distance of eighty or ninety miles, the face of the country presents a general plain, almost as level as the surface of the ocean. As it is elevated thirty or forty feet above tide water, it is necessarily furrowed by water courses; but its most remarkable feature where prairies prevail is the existence of multitudes of wet places, each covering from a few rods to an acre or two in extent, and having a depression of one or two feet below the general level; while always around the margins of these low places are several rounded mounds, having a base of ten or twelve feet, and a height perhaps one fourth as great.

Compared with the age of the main American continent, all this land may be considered as having quite recently emerged from the dominion of the sea. It is essentially a vast deposit of sea sand, so completely identical in all its characters with the sands of the present shores and shallows of the gulf, that its origin cannot well be mistaken. Occasionally it embraces extensive beds of a red earthy marl. For instance, this marl may be seen in great abundance where excavations have been made for constructing a road in the bank, near a hundred yards northwest of the steamboat landing at Houston. By chemical examination I find a sample of this marl to consist mainly of carbonate of lime, red oxide of iron and silex. I believe it may be found of incalculable value to the city of Houston, and to the whole country above alluded to, inasmuch as limestone is not therein known to occur.

This marl, if calcined after the manner of burning lime, will become converted into a very good quicklime, of a reddish brown color. Nothing can be more efficient as the calcareous ingredient in all kinds of mortar, for laying bricks, making underground water tanks, and plastering houses internally and externally, where the color is no objection to its use. In fact it might be universally substituted for white lime, the iron or coloring material having only the effect to render it more hard and enduring than it otherwise would be.

The arable soil in this region consists of a basis of marine sand, mixed superficially with vegetable mould, but destitute of lime or saline matter. The application of this marl could not fail of greatly increasing its productiveness; and as the marl appears to be pretty generally distributed over the country, it will no doubt hereafter prove a cheap and efficient means of ameliorating the soil.

In travelling north from Houston, immediately after crossing Spring Creek, thirty miles distant, we come into a region gently rolling. Here we meet with small, rounded diluvial pebbles interspersed in the soil, some of jasper, others of quartz, flint, hornblende, &c. In my excursion, which extended as far north as the Mustang prairie, eighteen miles above Robbin's ferry, on the Trinity, these pebbles constantly presented themselves in the hills, but I saw none of greater size than a pigeon's egg. They are perhaps indicative of the nature of the rocks in the mountainous districts lying to the northwest, having been transported and worn by ancient marine currents. The eminences of the rolling region rise from one hundred to three hundred feet above the valleys. It is evidently of more ancient formation than the level region just described; nevertheless its outline or contour is most obviously the same as when the ocean left it, excepting the narrow gorges usually from ten to thirty feet deep, occupied by the present fresh water streams. Many of the high rolling prairies have their surfaces, especially their southern declivities, curiously marked with ridges and furrows five or six feet broad, as though they had been rudely tilled by some former race of giant plowmen. They have received the euphonical appellation of *hog-wallow* prairies. Those who have observed the small, regular ripple marks, impressed by the waves on the sands of a shallow bay, or seen fluted and indented sandstone strata, high, dry, hard and a thousand miles inland perhaps,—the petrified ripple marks of an ancient sea, will have a correct idea in miniature of the appearance in question. May not these ridges and depressions in the sandy soil be the remains of successive ridges thrown up by the waves of a former sea? If not, whence came they?

Still more ancient than the beds of diluvial sand and pebbles, a formation of sandstone here and there presents itself at the surface, yet obviously underlying the whole of the rolling country. In some situations it has the hardness and all the other good qualities of a freestone, most valuable for building purposes. In other

places it passes insensibly to the condition of incoherent sand. Often on the banks of the Trinity, the indurated sandstone alternates with mere sand beds. Several valuable quarries of free-stone on and near the Trinity river, as at New Cincinnati and at the site of Osceola above the mouth of Bidais creek. At the latter place a most excellent building stone, of a light gray color and homogeneous texture, coming out in large oblong blocks, presents itself in a high bluff overhanging the river, in quantity apparently inexhaustible. The strata dip very slightly to the northwest, perhaps one foot in thirty. As large flat-boats may easily be laden with the free stone, and floated securely down the Trinity, it is not improbable that the future city of Galveston may be largely indebted to these and other neighboring localities for the materials of construction. In reference to its geological age, I may here remark, that between the limits of high and low water mark of the Trinity, this formation embraces extensive beds of lignite or brown coal, in which the woody structure is obvious. In places, huge logs and branches of opalized wood also occur, as do likewise the imperfect impressions of minor cauline plants. Those conversant with geology will therefore perceive that the Trinity sandstone belongs to the Tertiary series of formations.

The Trinity country, when its resources are developed, will in my opinion prove to be especially rich in salt springs. Only two localities came under my inspection; one of these is on Mr. Young's plantation, east side of the Trinity, near two miles higher than the mouth of Bidais creek; the other, similar to it but apparently more extensive, is on the Salinilla creek, a branch of Salt creek, west side of the Trinity, some four or five miles higher up, on the lands belonging to Dr. F. B. Page. Here are the unerring indications of an extensive subterranean deposit of salt or saliferous strata. Many acres of sand are here so constantly imbued with the saline transudation from below, as to be partially denuded of the usual vegetation, presenting here and there those succulent plants peculiar to salt marshes and other saline districts. If in some places a depression of a foot or so be made in the sand, a strong brine soon collects therein. I tasted of water thus procured, and it seemed to me to be nearly saturated with salt. I regret I had not the means of ascertaining its exact strength. I have visited several salt works in Ohio, Pennsylvania

and New York. This salt water I think was more concentrated than even the Salina water; and no doubt wells of a moderate depth would command an inexhaustible supply of brine. The manufacture of salt in this place would of course prove exceedingly lucrative; for the country is well wooded, and the river banks, less than a mile distant, contain vast quantities of brown coal. The concentration might be accomplished with wood, or by solar evaporation upon the spot, or the water might be conveyed in a leaden tube to the banks of the Trinity, where the brown coal might easily be quarried out for supplying the furnaces with fuel. The salt could then, with very little expense, be floated down the river to Galveston, where it must always bear a fair price.

This region is well supplied with perennial springs, many of them seemingly pure as the water which falls from the clouds near the close of a rain storm, and many others imbued with diverse mineral qualities. A variety of mineral springs occur near Carolina and New Cincinnati, generally in wild ravines or embowered in picturesque groves; but those which I most particularly examined, rise on the Salinilla creek in an elevated and beautiful situation, in the midst of the singular saline prairie before mentioned, with the forest clad banks of the Trinity, half a mile or so to the east, and a noble prospect of high rolling prairie lawn and woodland, bearing away to the southwest. The Salinilla carbonated spring is sufficiently copious to yield nearly half a barrel per minute. Though its temperature as carefully ascertained is but 68° Fahr., yet it has some claim to be called a boiling spring, on account of the incessant bubbling up of nitrogen and carbonic acid gases; with which latter, the water itself is strongly impregnated. I find the specific gravity of this water at 60° Fahr., to be 1.00 67. Four parts in a thousand by weight are saline mineral matter which can be obtained by evaporation. By means of numerous careful experiments with chemical reagents, I find the water to contain the following ingredients, viz. carbonic acid, chlorine, iodine, soda, lime, magnesia, organic matter a trace. We may therefore infer, that the gaseous and mineral contents of the spring are,

Carbonic acid,
Nitrogen,
Muriate of soda,

Muriate of magnesia,
Bicarbonate of soda,
Bicarbonate of lime,
Hydriodate of soda.

Experiments indicate the absence of sulphuric acid, iron and potash. The presence of iodine confers upon this water medicinal qualities of a most valuable kind. The same element has been detected in the Saratoga water, New York. The taste of the Salinilla water is unusually grateful and pleasant.

Near a quarter of a mile lower down the Salinilla creek, is a small sulphur spring, in the water of which I detected

Sulphuretted hydrogen,
Carbonic acid,
Muriate of soda,
Muriate of magnesia,
Bicarbonate of iron, } mere traces.
Silica,

The dark sediment which subsides from this water upon standing, is mainly sulphuret of iron. The specific gravity of the water is 1.00 66. By evaporating 1000 grains of water, a saline residue is obtained weighing $2 \frac{3}{10}$ grains.

Embellished as this site is with the most beautiful of Texas scenery, it may some day become a place of fashionable resort. To me the whole seemed like a landscape garden. The prairies every where presented a bewildering variety of flowers, rare, beautiful and nameless. Deer, and wild turkeys are numerous in the surrounding solitudes, and the clear lakes a few miles to the south abound with fine large fish.

In the banks of the Trinity, I often noticed deposits of a reddish brown iron stone, apparently a good iron ore; but my investigations respecting its extent or abundance, and the facilities which it might offer for the manufacture of iron, were not such as to allow me to speak decisively. Most of the small fountains which issue at frequent intervals from the steep banks of the river, above the brown coal formations, are strongly tinged with iron, a circumstance which would seem to indicate abundance of iron ore.

This whole region abounds to an extent perhaps unexampled in silicified or opalized wood:—wood changed to stone. Small oblong pieces are constantly met with on the higher portions of

land, while in the banks of the Trinity, associated with the iron ore, and overlying the brown coal whole trees and fragments of trees, piled sometimes one upon another, present themselves completely transformed to stone. In some logs a diversified metamorphosis is observable: one portion of the vegetable structure having been replaced with silex, another with brown oxide of iron, and a third is bitumenized or converted to coal.

In concert with Dr. F. B. Page, I took considerable pains in the exploration of the Trinity brown coal formation. As no excavations for working have yet been made, the best places for inspecting the formation, are where the Trinity cuts its way through the high lands, or where its banks present themselves in bold high bluffs, as at New Cincinnati, and near the site of the projected town of Osceola. The coal lies in horizontal strata, dipping about one foot in thirty to the northwest. The main stratum at the latter place, just above Bidais creek, is represented by the concurrent statements of W. C. Brookfield, surveyor, Mr. James S. Hunter of Huntsville, Texas, Dr. Page, and some other persons whom I consulted, as between six and seven feet in thickness, the lower portion being three or four feet above low water mark. Unfortunately, during my sojourn there, the river was unusually high and turbid for the season of the year; I could not consequently verify the same by personal observations and measurements. The most considerable coal beds which I had opportunity fully to inspect, were in the Trinity bluffs, southwest side, at New Cincinnati, six miles lower down, and just below the mouth of Salt creek, near six miles above. The workable stratum of brown coal in each of these localities is about five feet thick, and situated some fifteen feet or so above low water mark. In quality it is said to be precisely similar to the coal of the seven feet bed.

Specimens of average quality which I took from the bed near the mouth of Salt creek, have a specific gravity of 1.326. The proportion of carbon or coke, is forty seven parts in one hundred ($\frac{47}{100}$.) The volatile portion consists of bitumen, creosote, pyroligneous acid and water. Upon burning 100 parts of the coal, there remains a trifle more than one part by weight of white ashes. The color of this coal is a dark umber brown, nearly black. Its ligniform structure is almost always easily discernible. It is readily ignited, burns with a pleasant flame, and with almost the same

facility as charcoal. Although it has much less bitumen in its composition than the Pittsburgh or cannal-coal, it will yet prove valuable for nearly all purposes to which coal is applied; such as parlor use, the reduction of ore, and the generation of steam power. It is however ill adapted for the manufacture of inflammable gas.

This sort of coal is denominated *brown coal* or *brown lignite* by mineralogists. Sometimes it is called Bovey coal, because a thick bed of it has long been wrought at Bovey near Exeter in England. It occurs in many parts of the world, in some places in vast abundance, but generally in beds of far less extent than those of the Trinity. It is worthy of remark, that iron pyrites commonly so abundant and detrimental in coal, is here unusually scarce.

In estimating the value of these beds of lignite, it must be remembered, that the Trinity is a navigable stream, and almost the only one in Texas, which at this time deserves to be so ranked: that the city of Galveston, now with a population of 2000 and rapidly increasing, is situated on an island virtually destitute of timber. Hence Galveston needs fuel, and nothing is more probable than that the Trinity country will supply her. Each steamship plying between Galveston and New Orleans, consumes during the voyage both ways near one thousand barrels of coal, which at present costs them in New Orleans, an average of seventy or eighty cents a barrel. During twelve months past, the steamship Columbia is said to have expended \$25,000 for coal alone. It is by no means improbable that coal might be profitably furnished to steam vessels at Galveston, from the Trinity, at one third or even one fourth this cost. If the demand can be supplied, Galveston will be one of the best coal markets in the world; for besides the requirements of ordinary commerce, steamships of war cruising in the Gulf of Mexico, will always find it a convenient place to lay in fuel.

New Orleans, July 15, 1839.

Vol. xxxvii, No. 2.—July-October, 1839.

23

ART. III.—*Extracts from the Anniversary Address of the Rev. Wm. WHEWELL, before the Geological Society of London.—Continued from p. 129 of this volume.*

IN attempting a sketch of the subjects which have occupied the attention of the Society during the year, I should wish to retain that distribution of the science of geology according to which I arranged my remarks in the Address which I had last year the honor of reading to the Society ; I mean the primary division into *Descriptive Geology* and *Geological Dynamics* ; the former implying a description of the rocks of the earth's surface according to an established classification of strata and formations ; and the latter dealing with the study of those general laws and causes of change by which we hope to understand and account for the facts which Descriptive Geology brings before us ; in short, the present condition and the past history of the earth's crust. But as the laws of permanence and change, with regard to organized beings, differ very widely from the dynamics of brute matter, we may conveniently make a separate study of the relations of organic life to which geology conducts us, and may mark it by the name *Palæontology*, by which it is commonly known. I will add, that it still appears to me convenient, for the present, to divide Descriptive Geology into two portions,—the Home circuit, in which the order of superposition has already been established with great continuity and detail ; and the Foreign region, in which we are only just beginning to trace such an order. I shall also, as before, take the ascending order of strata. According to this arrangement of the science, I shall venture to bring to your recollection a few of the points to which our attention has mainly been called during the past year.

DESCRIPTIVE GEOLOGY.

1. *Home (North European) Geology.*—When I stated that Descriptive Geology has for its task the reference of the rocks of some portions of the earth's surface to an established classification into strata and formations, it was implied that the more common employment of the descriptive geologist must be to refer the rocks which he examines to some classes *already fixed and recognized* ; but it could hardly fail to occur to you, that from time to time the

leaders in this study will be called upon to execute a more weighty and elevated office, in framing the classifications which other observers are to apply ; in drawing the great lines of division and subdivision which fix the form of the subject ; in setting up the type with which examples are to be compared ; in constructing the language in which others are to narrate their facts. Steps of this kind have formed, and must form, the great epochs in the progress of all sciences of classification, and especially in ours ; and I need not remind you how great the importance and the influence of such steps amongst you have been, to pronounce at once upon the success of such steps must always be in some degree hazardous ; since their success is in fact this, that they influence permanently and powerfully the researches, descriptions, and speculations of future writers ; and there are few of us who can pretend to the foresight which might enable us to say, in any special case, how far this will be so. Yet the great works of Messrs. Murchison and Sedgwick, tending to the establishment of a classification of the strata below the old red sandstone (works which, on all accounts, we must consider as a joint undertaking), appear already to offer an augury which can hardly be doubtful, of this influence and permanence. Mr. Murchison's appellation of the "Silurian System" has already been adopted by MM. Elie de Beaumont and Dufresnoy, who have given it currency on the continent : M. Bouè and M. de Verneuil announce the diffusion of "Silurian" rocks in Servia and the adjacent parts of Turkey in Europe ; our own members, Mr. Hamilton and Mr. Strickland, have extended their range to the Thracian Bosphorus ; M. Forchhammer, of Copenhagen, visited the "Silurian region" to endeavor to recognize the rocks of Scandinavia ; and MM. Omalius D'Halloy and Dumont have just explored it, to establish a parallel between its deposits and those of Belgium. It will be observed that some of the districts thus mentioned are out of the limits of our geological Home circuit ; and if the identification be really and permanently established in these cases, will extend the limits within which the parallelism of geological series can be asserted : and this is, in effect, what we have a right to look for, sooner or later, in the progress of geological science. As we must be careful not to apply our domestic types without modification to other regions, so must we take care not to despair of modifying our scheme, so that it shall be far more extensively applicable

than it at first appeared to be. Of this progress of things examples are too obvious and too recent to require to be pointed out.

The labors of Professor Sedgwick refer to the "Cambrian System," which lies beneath the Silurian System, occupying much of North Wales, Cumberland, and a great part of Scotland; while the Silurian System spreads over a great part of South Wales and the adjoining English counties. The classification of the rocks of this portion of our island to which Professor Sedgwick has been led, though laid before you only at a recent meeting, is the fruit of the vigorous and obstinate struggles of many years, to mould into system a portion of geology which appeared almost too refractory for the philosopher's hands; and which Professor Sedgwick grappled with the more resolutely, in proportion as others shrank away from the task perplexed and wearied. I need not attempt any detailed view of his system: his First Class of Primary Stratified Rocks occupies the Highlands of Scotland and the Hebrides, and appears in Anglesea and Caernarvonshire; the crystalline slates Skiddaw Forest, and the Upper Skiddaw slate series come next. Above these is his Second Class, or Cambrian and Silurian. The Cambrian is divided into lower and Upper Cambrian, of which the former includes all the Welsh series under the Bala limestone; the two great groups of green roofing slate and porphyry on the north and south sides of the mineral axis of the Cambrian mountains (of which groups the position had previously been misunderstood), and parts of Cornwall and South Devon. The Upper Cambrian System contains a large part of the Lammermuir chain; a part of the Cambrian hills, commencing with the calcareous slates of Coniston and Windermere; the system of the Berwyns and South Wales; all the North Devon, and a part of the South Devon and Cornish series. Ascending thus through a series of formations distinguished and reduced to order by the indefatigable exertions and wide views of Professor Sedgwick, we arrive at the Silurian system; and here we must seek our subdivisions from the rich results of the labors of Mr. Murchison. These subdivisions were published in the summer of 1833. Like the Cambrian, the Silurian is divided into a Lower and an Upper System, the former including the Llandeilo flags and the Caradoc sandstones; the Upper Silurian Rocks being the Wenlock shale and limestone, the Lower Ludlow, the Aymestry limestone, and the Upper Ludlow,

which finally conducts us to the Tilestones or bottom beds of the Old Red Sandstone.

That these various series of Cambrian and Silurian rocks are really superposed on one another; that they are justly separated into these groups; and that the smaller groups are truly of a subordinate nature, divided by lines less broad than those which bound the great series of formations;—these are points, of which the evidence must be sought in the works to which I refer. The evidence produced by Prof. Sedgwick is mainly to be found in the great fact of superposition, supported by the circumstances of dip, strike, cleavage, mineral character, and all the great incidents of mountain masses. To proofs of this kind Mr. Murchison is able to add the testimony of organic fossils, of which a vast and most instructive collection is figured in his work. These fossils of the Silurian system, amounting in all to about 350 species, are essentially distinct from those of the Carboniferous System and Old Red Sandstone. This being so, the establishment of these great divisions is supported by that geological evidence which properly belongs to the subject.

In detecting order and system among the monuments of the most obscure and remote periods of the earth's history; it may easily be supposed that it has been necessary to employ and to improve all the best methods of geological investigation. Prof. Sedgwick's classification of the oldest rocks which form the surface of this island has of course been obtained by a careful attention to the position and superposition of the mineral masses, and by tracing the geographical continuity of the strata, almost mile by mile, from Cape Wrath to the Land's End. In this manner he has connected the rocks of Scotland with those of Cumberland; these again with those of Wales; and the Welsh series, though more obscurely, with that of Devonshire and Cornwall. In this survey he has constantly kept before his eyes a distinction, known indeed before, but never before so carefully and systematically employed, between the slaty cleavage of rocks and their stratification; for the directions of these two planes, though each wonderfully persistent over large tracts, never, except by accident, coincide. He has taken for his main guide the direction of the strata, or, as it is called, the *strike* of the beds; and in such a course, the theory of Elie de Beaumont respecting the parallelism of contemporaneous elevations, whether true or false, could not fail to give

an additional interest to geological researches, conducted on so large a scale as those of Prof. Sedgwick. Mr. Murchison's mode of investigation may be described thus: that he has applied, for the first time, to the rocks below the Old Red Sandstone, the method of classification previously employed with so much success for the Oolites. It is truly remarkable, that Nature has placed in this our corner of the world, series, probably the most complete which exist, of both these groups of strata; and as the Oolites of England have long been the type of that portion of European geology, the Silurians of Wales may perhaps soon be recognized, as the standard members of a still more extensive range of deposits. As if Nature wished to imitate our geological maps, she has placed in the corner of Europe our island, containing an *Index Series* of European formation in full detail.

The Carboniferous, Old Red, Silurian, and Cambrian systems have, by many writers, up to the present time, been all comprehended in the term "transition rocks," so far as that term has been used with any definite application at all. The analysis of this vague group into these distinct portions removes the confusion and perplexity which have hitherto prevailed in this province of geology. Prof. Sedgwick has further proposed to apply the term *Palæozoic*, and Mr. Murchison that of *Protozoic*, to the rocks which constitute the Cambrian and Silurian systems.

How far these appellations are useful, we shall see when we have had speculations presented to us in which they are familiarly used; for necessity is the best apology, and convenience the best rule, of innovations in scientific language. In the names applied to the members of the Silurian system, Mr. Murchison, following those examples of geological nomenclature which have been most clearly understood and most generally adopted, has borrowed his terms from localities in which standard types of each stratum occur. If the Silurian system be as exclusively diffused as some indications seem to imply, we may find the Ludlow Rocks in Scandinavia, and the Caradoc Sandstone even in Patagonia. Whether a like identification of the more ancient rocks of the Cambrian series with the lowest formations of other countries be possible, may perhaps be (for the present) more doubtful.

I have spoken of Mr. Murchison's work as if it had formed part of our Proceedings, as indeed almost every part of it has done, although it now appears in a separate form. And I will

add, that it is impossible not to look with pleasure upon the form in which the work appears, enriched as it is in the most liberal manner, with every illustration, map and section, picturesque view and well marked fossil, which can aid in bringing vividly before the reader, all the instructive and interesting features of the formations there described. The book must be looked upon as an admirable example of the sober and useful splendor which may grace a geological monograph.

Having been tempted to dwell so long on this subject from my conviction of its importance, I must the more rapidly proceed with the remainder of my survey. Mr. Bowman sent us, "Notes on a small patch of Silurian Rocks to the west of Abergele." In this investigation, which is interesting to us as the first application of Mr. Murchison's Silurian System, the author found strata of which some could be, by means of fossils, identified with the Ludlow rocks. Mr. Malcolmson has, by the remains of fossil fishes, shown that the calciferous conglomerate of Elgin represents the old red sandstone of Clashbinnie, as the Rev. G. Gordon had already supposed. Finally, proceeding to higher strata, we have to notice a trait of the fossil history of the coal strata near Bolton-le-Moors, contributed by Dr. Black. A stem of a tree thirty feet long, and inclined at an angle of 18° in a direction opposite to the strata, was discovered, having upon it a *Sternbergia*, about an inch in diameter, extending the whole length of the stem, which had been, while living, a parasite plant, like the mighty existing creepers of the tropical regions.

The most curious addition to our fossil characters of strata, are the footsteps discovered on the surface of beds of the new red sandstone. It is well known that several years ago such marks were discovered at Corncockle Muir, in Dumfries-shire. Since that time similar discoveries have been made at various places, and especially in 1834, in the quarries of Hesseberg near Hilbergshausen; and to the animal which had produced the impressions then discovered, the name of *Chirotherium* was provisionally applied by Professor Kaup. In the quarries of Storeton Hill, in the peninsula of Worrall, between the Mersey and the Dee, marks were discovered strongly resembling the footsteps of the *Chirotherium* of Kaup: these were described by a committee of the Natural History Society of Liverpool, and drawn by J. Cunningham, Esq. Mr. James Yates has also described foot-

steps of four other animals from the same quarries; and Sir Philip Egerton has given us a description of truly gigantic foot-steps of the same kind, which he terms the *Chirotherium Herculis*.

Mr. Strickland gave us a notice of some remarkable dikes of calcareous grit which occur in the lias schist at Ethie in Ross-shire, and which had already been remarked by Mr. Murchison, in his examination of the coast of Scotland, in 1826. They appear not to have been injected from below, but filled in from above.

Mr. Williamson's "View of the Distribution of Organic Remains in part of the Oolitic Series on the Coast of Yorkshire," was the welcome continuation of a labor of the same kind already executed for the lower portions of the series, and promised to be continued for the upper. Among the contributions to the fossil history of the oolites, we must also place Dr. Buckland's "Discovery of the fossil wing of an unknown Neuropterous Insect in the Stonesfield slate." This stratum, the Stonesfield slate, has, during the past year, occupied the Society in the consideration of its fossils in no small degree; but the speculations thus suggested belonging to Palæontology rather than Descriptive Geology. Mr. Murchinson's notice of a specimen of the Oar's rock, which stands in the sea off the coast of Sussex, nine miles south of Little Hampton, shows it to agree with some of the rocks in the greensand or Portland beds; and its thus belonging to the strata below the chalk falls in which the remark of its occurring between the parallels of disturbances which traverse the Wealden of Sussex on the north, and the Isle of Wight on the south; for these disturbances and other facts agree well with the notion of protruded strata between. The Wealden strata themselves have been observed by Mr. Malcolmson, at Linksfield, near Elgin. It is remarkable, that these strata had already, very unexpectedly, been found by Messrs. Murchison and Sedgwick in the Isle of Skye.

I have also to notice Dr. Buckland's account of the discovery of fossil fishes in the Bagshot Sands at Goldworth Hill, near Guilford. As these fossils resemble those of the London clay, Mr. Lyell's opinion that the Bagshot Sands were deposited during the eocene period is strongly confirmed.

The fresh water beds of the Isle of Wight, which had already supplied specimens of some of the Pachydermata of the Paris basin, have furnished an additional supply of rich fossils, which have been examined by Mr. Owen. He has found them to contain bones of four species of Palæotherium, and two species of Anoplotherium; also a jaw of the Chæropotamus, a fossil genus established by Cuvier; and another jaw closely resembling that of a Musk Deer, which Mr. Owen refers to the genus Dicobune, a genus also established by Cuvier upon the fossils of the Paris basin. Such discoveries, falling in with the conclusions obtained by the researches of previous philosophers respecting the tertiary period of the earth's history, and supplying what they left imperfect, cannot fail to give us great confidence in the results of those investigations, and to enhance our admiration of the sagacity which opened to us this path of discovery.

Dr. Mitchell gave an account of his attempts to trace the drift from the chalk and strata below the chalk, as it exists in the counties of Norfolk, Suffolk, Essex, Cambridge, Huntingdon, Bedford, Hertford, and Middlesex. This drift I had occasion to notice in my Address last year, in reference to Mr. Clarke's elaborate geological survey of Suffolk; and I then stated that this diluvial deposit is known in the neighborhood of Cambridge by the name of *brown clay*. Dr. Mitchel has shown that this deposit is of greater extent than we were before aware. But still to determine with precision its principal masses, total extent, and local modifications, would be a valuable service to the geology of the eastern part of our island.

As my order requires me to take the igneous after the sedimentary rocks I must here notice Dr. Fleming's "Remarks on the Trap Rocks of Fife," which he distinguishes into three epochs;—those of the eastern extremity of the oolites, which are variously associated with the old red sandstone;—those which run from St. Andrew's to Stirling, which were produced after the coal measures;—and those which occur along the shores of the Forth, which occur in the higher coal measures.

2. *Foreign (South European and Trans-European) Geology.*—In the survey of the progress of our labors which I offered to your notice last year, I stated, that in proceeding beyond the Alps, and I might have added the Pyrenees, we no longer find that multiplied series of strata, so remarkably continuous and

similar, when their identity is properly traced, with which we have been familiar in our home circuit. Yet the investigations of Mr. Hamilton and Mr. Strickland appear to show, that we may recognize, even in Asia Minor, the great formations, occupying the lowest and highest positions of the series, which are well marked by fossils, namely, the Silurian and Tertiary formations; and also an intermediate formation corresponding in general with the Secondary rocks of the north, but not as yet reduced to any parallelism with them in the order of its members. Besides these sedimentary rocks, in this as in most other countries, there are found vast collections of igneous rocks of various kinds, which interrupt and modify, and may mask and overwhelm, the fossiliferous strata. A paper has been communicated to us by Mr. Hamilton, "On a part of Asia Minor," namely, the country extending from the foot of Hassan Dagh, to the great salt lake of Toozla, and thence eastwards to Cæsarea and Mount Argæus, and thus occupying a part of the ancient Cappadocia.

It appears that in this district the igneous rocks occupy a large portion of the surface, and the sedimentary strata which are associated with these are not easily identified with those which occur in countries already examined. The district examined by Mr. Hamilton contains a limestone belonging to the vast calcareous lacustrine formation of the central part of Asia Minor, and beneath this, a system of highly inclined beds of red sandstone, conglomerates, and marls, which are perhaps connected with the saliferous deposits of Pontus and Galatia; but which could not be satisfactorily compared with the beds of the south of Europe, for want of the occurrence of organic remains. In only one instance did Mr. Hamilton observe the trace of organic bodies in the sandstone; these were impressions resembling fucoids, and similar to those found in the Alpine limestone near Trieste. Mr. Hamilton ascended to the summit of Mount Argæus, which had not previously been reached by any traveller, which rises abruptly from the alluvial plain of Cæsarea to the height of 13,000 feet.

We have another contribution to the geology of the countries exterior to the Alps and Pyrenees in Mr. Sharpe's memoir on the geology of Portugal. He has examined with great care the neighborhood of Lisbon, and has traced the superposition of the strata, naming the most conspicuous of them from the places in

which they are well exhibited. His series (exclusive of igneous rocks) consists of San Pedro limestone (which rests upon the granite,) slate clay and shale, Espichel limestone, red sandstone, hippurite limestone, and lower tertiary conglomerate, the Almada beds, and the upper tertiary sand. In the Memoirs of the Royal Academy of Sciences of Lisbon, for 1831, Baron Eschwege had examined a geological section taken across the mouth of the Tagus, and passing from the granite of the Serra of Cintra, to that of the Serra of Arrabida. But his identifications of the Portuguese beds do not agree with those of Mr. Sharp, and have indeed the air of proceeding on the arbitrary assumption of a correspondence between this and other parts of Europe. Thus Baron Eschwege has referred both the San Pedro and the Espichel limestones to the magnesian limestone; the red sandstone formation he considers as Bunter Sandstein, while Mr. Sharpe refers it to the age of our Oolites: the hippurite limestone (now acknowledged to be the equivalent of our chalk and greensand) M. Eschwege makes to be the Jura limestone; and the Almada beds he would have to be Plastic Clay and Calcaire Grossier. Mr. Sharpe is very properly attempting, by a further study of the organic fossils which he has procured, to confirm or correct the identifications to which he has been led. It is only by thus starting from different points, and tracing strata by their continuity, that we can hope to cover the map of Europe, and finally the world, with geological symbols of a meaning fully understood.

PALEONTOLOGY.

The portion of our subject which we term Palæontology, might at first sight seem to form a part of zoology rather than of geology; since it is concerned about the forms and anatomy of animals, and differs from the usual studies of the zoologist only in seeking its materials in the strata of the earth's crust instead of upon its surface. Yet a moment's thought shows us how essential a part of our science the zoology of extinct animals is; for in order to learn the history of the revolutions which the earth has undergone, we must seek for general laws of succession in the remains of organic life which it presents, as well as in the position and structure of its brute masses. And since such general laws must necessarily be expressed in terms of zoology,

it becomes our business to define those terms, so that they shall be capable of expressing truths which include in their circuit the past as well as the present animal and vegetable population of the world.

An example of this process has occupied a large portion of our attention during the past year. It appeared to be a proposition universally true, that the oldest strata of the earth's surface contained cold-blooded animals only ; and that creatures of the class mammalia only began to exist on the surface after the chalk strata had been deposited and elevated. And when, to a rule of this tempting generality, a seeming exception was brought under our notice, it became proper to examine, whether the anatomical line, which enables us to separate hot-blooded from cold-blooded animals, had really been rightly drawn ; and whether, by rectifying the supposed characteristic distinction, the exception might not be eliminated. The exception on which this very instructive point was tried consisted in a few jaw-bones of a fossil animal, which, though occurring in the Stonesfield slate near Oxford, a bed belonging to the oolite formation, had been referred by Cuvier to the genus *Didelphys*, and thus placed among marsupial mammals. In August last, M. de Blainville stated to the Academy of Sciences of Paris, his reasons for doubting the justice of of the place thus assigned to the fossil animal. Founding his views principally upon the number and nature of the teeth of the fossil, he asserted that the animal, if a mammal, must come nearest the phocæ ; but he rather inclined to believe it a saurian reptile ; following, as he conceived, the analogies offered by a supposed fossil saurian described by Dr. Harlan of Philadelphia, and termed by him *Basilosaurus*. M. Valenciennes, on the other hand, asserted the propriety of the place assigned by Cuvier to the fossil animal, although he made it a new genus ; and gave to the species the name *Thylacotherium Prevostii*. The controversy at Paris had its interest augmented when Dr. Buckland in September carried thither the specimens in question. From Paris the controversy was transferred hither in November, and principally occupied our attention at our meetings till the middle of January.

One advantage resulting from the ample discussion to which the question has thus been subjected, has been, that even those of us who were previously ignorant of the marks by which zoo-

logists recognize such distinctions as were in this case in question, have been put fully in possession of the rules and the leading examples which apply to such cases. And hence it will not I trust be deemed presumptuous, if, without pretending to any power of deciding a question of zoology, I venture to state the result of these discussions. It appears, then, that some of the marks by which the under jaws of Mammals are distinguished from those of Saurians are the following: (1) a convex condyle; (2) a broad and generally elevated coronoid process, (3) rising near the condyle; (4) the jaw in one piece; (5) the teeth multicuspoid, and (6) of varied forms, (7) with double fangs, (8) inserted in distinct sockets, but (9) loose and not ankylosed with the jaw. In all these respects the Saurians differ; having, for instance, instead of a simple jaw, one composed of six bones with peculiar forms and relations, and marked by Cuvier with distinct names; having the teeth with an expanded and simple fang, or ankylosed in a groove, and so on. Of course, it will be supposed, by any one acquainted with the usual character of natural groups, that this line of distinction will not be quite sharp and unbroken, but that there will be apparent transgressions of the rule, while yet the unity of the group is indubitable. Thus the Indian Monitor and the Iguana, though Saurians, violate the *second* character, having an elevated coronoid process; but then it is narrow, and this seeming defect in our second character is further remedied by the third; for in those Saurians there is a depressed space between the condyle and the coronoid process quite different from that which a mammal jaw exhibits. Again, the teeth of Crocodiles, Plesiosaurus, and the like, are inserted in distinct sockets; but then they have not double fangs. The *Basilosaurus* was supposed to be a saurian with double fanged teeth, but that exception was disposed of afterwards. And as there are thus saurians which trench upon the characters of mammals, there are mammals in which some of the above characters are wanting: thus the condyle is slightly or not at all convex in the Ruminantia; there is no elevated coronoid process in the Edentata; the Dolphin and Porpois have not multicuspoid teeth; the Armadillo has not varied forms of teeth, nor has it double fangs to its teeth, which also the fossil *Megatherium* has not. Still, upon the whole, the above appears to be the general line of distinction. Even if one or two of the above nine marks were

wanting to prove the animal a mammal, still if the great majority of them were present, our judgment could not but be decided by the preponderance of characters. But if all the above characters of mammals are present, and all those of saurians absent, it seems to be a wanton skepticism to doubt that the animal was really warm blooded.

Now it was asserted by Mr. Owen, who brought this subject before us, that this is the case ; that all the characters which I have enumerated above exist in the Stonesfield jaws. If we satisfy ourselves that this is the case, I do not see how we can avoid assenting to his opinion,—that the animal belonged to the class Mammalia.

Every such question of classification must resolve itself into two ; that of the *value*, and that of the *existence* of the characters. If we assent to Mr. Owen in his view of the former, we are then led to consider the latter.

M. de Blainville, at least in his first examination, had labored under the disadvantage of forming his judgments from casts and drawings only of the Stonesfield bones. Under these circumstances, he had denied several of the above characters ; he had held that the teeth in the *Thylacotherium* are uniform ; and that they are confluent with the jaw ; and that the jaw is compound. These statements Mr. Owen, resting upon a careful examination of the specimens, contradicts. The assertion of the compound nature of the jaw is occasioned by a groove near the lower margin of the jaw, which however, is not so situated as to represent the saurian sutures, but is completely explained by supposing it to be a vascular canal, such as exists in the Wombat, Didelphys, Opossum, and similar animals.

Another specimen, at that time the property of Mr. Broderip, but now very properly placed in the British Museum, exhibits a jaw similar indeed to the *Thylacothere*, but belonging to a different genus ; and to this species Mr. Owen has given the name *Phascolotherium Bucklandi*. Both these generic names imply that the animals are pouched animals ; and in addition to the reasons which led Cuvier to this opinion, Mr. Owen has noticed in the fossils an inflection of the lower edge of the jaw, which, so far as has been hitherto observed, occurs in Marsupials, and in them alone.

As if this question had been destined to be settled at this time, the only remaining doubt with regard to the possible existence of double fangs in the teeth of a saurian was removed by the arrival in London of Dr. Harlan with his "Basilosaurus." That gentleman, with great liberality and candor, allowed sections of the fossil to be made in such a manner as to expose the structure of the teeth. And these being examined by Mr. Owen, and compared with the general laws of dental structure which he has lately discovered, it appeared that Dr. Harlan's fossil was by no means a saurian, but an animal nearly allied to the Dugong, to which Mr. Owen proposes to apply the generic name of Zeuglodon, expressing the conjoined form of its teeth.

I have not hesitated to lay before you the view of this subject to which I have been led by the discussions in which we have been engaged, notwithstanding the very great authorities which incline to the other side of the balance. Among these I hardly know whether I am to reckon Mr. Ogilby, who laid before us a very instructive communication, in which, without deciding the point, he pointed out the difficulties which appear to him to embarrass both views, and especially to contradict the opinion of the marsupial nature of the animal.

I have dwelt the longer on this controversy, since it involves considerations of the most comprehensive interest to geologists, and, we may add, of the most vital importance. For—*de summâ reipublicæ agitur*—the battle was concerning the foundations of our philosophical constitution; concerning the validity of the great Cuvierian maxim—that from the fragment of a bone we can reconstruct the skeleton of the animal. This doctrine of final causes in animal structures, as it is the guiding principle of the zoologist's reasonings, is the basis of the geologist's views of the organic history of the world; and, that destroyed, one half of his edifice crumbles into dust. If we cannot reason from the analogies of the existing, to the events of the past world, we have no foundation for our science; and you, Gentlemen, have all along been applying your vigorous talents, your persevering toil, your ardent aspirations, idly and in vain.

Besides the important investigations thus referred to, we owe to Mr. Owen other palæontological contributions. The genus *Chæropotamus*, established by Cuvier from an imperfect fragment of the bone of a skull, was asserted by him to be a Pachyderm

most nearly allied to the Peccari. A fragment of a lower jaw of the same genus, found by Mr. Darwin Fox in the Isle of Wight, confirms this view, but indicates in some points an approach to the carnivorous type. And it was remarked as interesting, that the living genus of the hog tribe which most resembles the Chæropotamus, the Peccari, exists in South America, where the Tapir, the nearest living analogue of the Anoplothere and Palæotherium, the associates of the Chæropotamus, also occur. Another jaw, found by Mr. Pratt in the Binstead quarries in 1830, and resembling that of the Musk Deer, Mr. Owen refers to a new species of Cuvier's genus Dicobune, under the name *Dichobune cervinum*. Mr. Owen has also given us a description of Lord Cole's specimen of *Plesiosaurus macrocephalus*, which he compares with Mr. Conybeare's *Plesiosaurus Dolichodeirus*, by establishing an intermediate species, founded upon a specimen existing in the British Museum, and termed by him *Plesiosaurus Hawkinsii*. Besides tracing the analogies which connect these with each other, and comparing them with the two great modifications of the saurian tribe, the crocodiles and the lizards, Mr. Owen presented his remarks on the form of the Plesiosaurian vertebræ, founding them upon a general view of the elements of which all vertebræ are constituted.

To the communications thus made to us, we may add Mr. Owen's determination of another animal, of which the remains brought from the neighborhood of Buenos Ayres, are among the many treasures of this kind which we owe to Sir Woodbine Parish. This animal, of gigantic dimensions, appears to have been allied to the Megatherium, but with closer affinities to the Armadillos; and it probably possessed the characteristic armor, of which, in the Megatherium, the existence is perhaps problematical. Mr. Owen has termed it *Glyptodon*, from the furrowed shape of its teeth.

In another communication, Mr. Owen endeavored to account for the dislocation of the tail of the Ichthyosaurus at a certain point, which is observable in many of the fossil skeletons of that animal. This circumstance, so remarkable from its general occurrence, and which Mr. Owen was the first to observe, he is disposed to account for, by supposing a broad tegumentary fin to have been attached to the tail for a portion of its length, the position of which fin must, he conceives, have been vertical.

I cannot close my enumeration of the valuable contributions for which we are indebted to Mr. Owen, without remarking how well our anticipations have been verified, when, in awarding him the Wollaston medal last year, we considered the labors which we thus distinguished as only the beginning of an enlarged series of scientific successes; and how well also Mr. Owen's own declaration, that he should lose no available time or opportunity which could be applied to palæontological research, has been borne out by the services he has rendered that branch of our science.

In the remainder of my review of what has been done among us in Palæontology, I must necessarily be very brief. I have already mentioned the discovery of fossil fishes in Bagshot sand. These fishes have supplied three new genera, which Dr. Buckland has distinguished and has named *Edaphodon*, *Passalodon*, and *Ameibodon*; of which the two first offer combinations of the characters of bony and cartilaginous fishes. Mr. Stokes has given us his views of the structure of the animal to which belonged those fossils with which we are so familiar under the name of Orthoceratites. He is of opinion, that these fossils, in their living condition, existed as a shell, enveloped within the body of the animal to which they belonged. He has distinguished three genera of these shells, to which he assigns the names *Actinoceras*, *Ormoce-
ras*, and *Huronica*. The Marquis of Northampton also has examined those minute spiral shells which occur in the chalk and chalk flints, and have been termed Spirolinites. And, finally, under this head I must mention Mr. Alfred Smee's paper, on the state in which animal matter is usually found in fossils.

Mr. Austen's hypothesis of the origin of the limestone of Devon, though belonging in some measure to Geological Dynamics, may perhaps be mentioned here, since he explains the position of those beds by reference to the habits of the coral animal. Mr. Austen has already shown himself to us as an excellent observer; and in constructing geological maps, a task requiring no ordinary talents and temper, he has earned our admiration. We shall therefore not be thought, I trust, to depreciate his labors if we receive with less confidence, speculations in their nature more doubtful. As we can hardly suppose the calcareous beds of Devon to have had an origin different from those of other countries, we cannot help receiving with some suspicion, a doctrine which would subvert

almost the whole of our existing knowledge of the relations of fossiliferous beds of limestone.

In that part of geology which I have termed Geological Dynamics, and which investigates and applies those causes of change by which we may hope to explain geological phenomena, we may still observe that fundamental antithesis of opinion which has long existed on the subject;—the division of our geological speculators into *Catastrophists* and *Uniformitarians*;—into those who read in the rocks of the globe the evidence of vast revolutions, of an order different from any which those of man has survived;—and those who see in the condition of the earth the result of a series of changes which are still going on without decay, the same powers which produced the existing valleys and mountains being yet at work about us. Both these opinions have received their contributions during the preceding year: Mr. Darwin having laid before us his views of the formation of mountain chains and volcanos, which he conceives to be the effect of a gradual, small, and occasional elevation of continental masses of the earth's crust;* while Mr. Murchison gathers from the researches in which he has been engaged, the belief of a former state of paroxysmal turbulence, of much deeper rooted intensity and wider range than any that are to be found in our own period; and M. de Beaumont, in France, has endeavored to prove that Etna and many other mountains must have been produced by some gigantic and extraordinary convulsion of the earth. Both Mr. Darwin and M. de Beaumont refer to the same examples; and while M. de Beaumont conceives that the cones of the Andes must have been formed by an abrupt elevation, caused by subterranean force, Mr. Darwin has maintained the opinion, that these lofty summits have been gradually thrust into the place which they occupy by a series of successive injections of molten matter from below, each intruded portion of fluid having time to harden into rock before it was burst and again injected by the next molten mass. For how otherwise, he asks, can we conceive the strata to be thrust into a vertical position by a liquid from below, without the very bowels of the earth gushing out? Without attempting to answer this question, we may observe, that when

* An abstract of Mr. Darwin's paper was given in L. and E. Phil. Mag., vol. xii, p. 584.

we suppose, as Mr. Darwin supposes, a vast portion of the earth's crust, the whole territory of Chili for example, to rest on a lake of molten stone, there is considerable force in M. de Beaumont's argument:—that when such a fluid is raised to the top of a mountain ten or twenty thousand feet high, the pressure upon the crust which is in contact with the fluid must be more than a thousand atmospheres; and who, *he* too asks, flatters himself that he knows enough of the interior machinery of volcanos, to be certain that this vast pressure, acting upon a large surface, may not, by some derangement of its safety valve, the volcanic vent, produce effects to which we cannot assign any limit?

In speaking of Mr. Darwin's researches I cannot refrain from expressing for myself, and I am sure I may add for you, our disappointment and regret that the publication of Mr. Darwin's journal has not yet taken place. Knowing, as we do, that this journal contains many valuable contributions to science, we cannot help lamenting, that the customs of the Service by which the survey was conducted have not yet allowed this portion of the account of its results to be given to the world.

Although not communicated to us, but to our Alma Mater the Royal Society, I may notice Mr. Hopkin's endeavors to throw light upon such subjects as this by the aid of mathematical reasoning. The researches of Mr. Hopkins respecting the effects which a force from below would produce upon a portion of the earth's crust, have already interested you, and would be of still greater value if the directions of faults and fissures which result from his theory did not depend very much upon that which in most cases we cannot expect to know, the form of the area subjected to such strain. Mr. Hopkins has since been employing himself in tracing the consequences of another idea, truly ingenious and philosophical, and which a person in full possession of the resources of mathematics could alone deal with. Some of the effects which the sun and moon produce upon the earth (as the precession and nutation,) include the attraction of those bodies upon the interior portion of the earth, and have hitherto been deduced from the theory by mathematicians, upon the supposition that the earth is solid. But what if the central portion of the earth were fluid! What if it appeared, by calculation, that the fluid internal condition would make the amount of the precession of the equinoxes, or of the nutation of the axis, different from

that which the solid spheroid would give? What if it appeared that the precession and nutation thus calculated for a fluid interior agreed better with observation than the result hitherto obtained by supposing the earth solid? If this were so, we should have evidence of the earth's interior fluidity, evidence, too, of a perfectly novel and most striking nature. But to answer these questions is far from an easy task; the precession of the solid earth is a problem in which Newton erred, and in which the greatest mathematicians of modern times have not found their greatest strength superfluous. Yet how incomparably more difficult in all cases is the mechanics of fluid than of solid bodies! It may, therefore, require more than one trial before any satisfactory solution of the problem can be obtained. Mr. Hopkins has attacked it by the aid of certain hypotheses, and the result is, so far, not favorable to the decisiveness of this test of the interior condition of the earth; but notwithstanding this state of things, I venture to say on your behalf, Gentlemen, that an idea so full of promise, of that which we so much desire, and which seems to be so utterly out of our reach, the knowledge of the condition of the centre of the earth,—that such an idea is not to be lightly abandoned.*

M. Necker of Geneva, offered an addition to the causes of convulsions of the earth, which are contemplated by our Geological

* The following are the results at which Mr. Hopkins has arrived, supposing the earth to consist of a homogeneous spheroidal shell filled with a fluid mass of the same density as the shell:—

1. The precession will be the same, whatever be the thickness of the shell, as if the whole earth were solid.

2. The lunar nutation will be the same as for the solid spheroid; to such a degree of approximation, that the difference would be inappreciable to observation.

3. The solar nutation will be sensibly the same as for the solid spheroid; unless the thickness of the shell be very nearly of a certain value, something less than one fourth the earth's radius, in which case this nutation might become much greater than for the solid spheroid.

4. In addition to the above motions of precession and nutation, the pole of the earth would have a small circular motion, depending entirely on the internal fluidity. The radius of the circle thus described would be the greatest when the thickness of the shell should be least; but the inequality thus produced, would not, for the smallest thickness of the shell, exceed a quantity of the same order as the solar nutation; and for any but the most inconsiderable thickness of the shell, would be entirely inappreciable to observation.

Mr. Hopkins intends hereafter to consider the case of variable density.

[See our present volume, p. 364.—Ed. Lon. and Ed. Phil. Mag.]

Dynamics, in a paper in which he ascribed the earthquakes which took place in the southern provinces of Spain, in 1829, to the falling in of strata, the subjacent gypseous and saliferous masses being washed out by subterraneous currents.* Without denying all influence to such a cause, we may observe that it does not appear likely that there would be thus produced, simultaneously, any greater effects than those which are known to have occurred from the falling in of unsupported mines; and these have never approached in their scale to any except the smallest earthquakes.

While geologists are thus looking in all directions for causes which may produce the phenomena which they study, it is natural that the powerful, but as yet mysterious influences of electricity should draw their attention. Mr. Robert Were Fox has endeavored to show, that by voltaic agency, a laminated structure, and deposits of metal in cracks, resembling metallic veins, may be produced in masses of clay. The experiments are of an interesting kind, and it can hardly be doubted that voltaic agency had some influence in such cases as those described by Mr. Fox; although Mr. Henwood and Mr. Sturgeon have failed in attempting to reproduce his results, and although results much resembling these occur in cases where no electrical action is suspected. But we may remark that the conditions under which such voltaic effects are produced have not yet been attempted to be defined with any accuracy; and that till this is done, the reality of such agency can neither be verified nor applied to geological speculations.

A reflection which naturally offers itself upon this review of our recent career, is this:—that different portions of the science of geology advance with very different rapidity. Descriptive Geology is constantly and actively progressive: facts are accumulated by observers in every land; and though facts are, in truth, of no value, at least for any purpose of science, except so far as they are reduced to some classification, yet on the other hand, sound classifications are perpetually, almost necessarily, suggested, when observation is vigilant and persevering. Even if we at first express our facts in terms of a false classification, we find afterwards

[* An abstract of M. Necker's paper has appeared in the present volume, p. 370.—Ed. Lón. and Ed. Phil. Mag.]

the means of translating them into the language of a true one. And the spirit of geological observation is so widely diffused, and so thoroughly roused, that I trust we need not anticipate any pause or retardation in the career of Descriptive Geology. I confess, indeed, for my own part, I do not look to see the exertions of the present race of geologists surpassed by any who may succeed them. The great geological theorizers of the past belong to the *Fabulous Period* of the science; but I consider the eminent men by whom I am surrounded as the *Heroic Age* of geology. They have slain its monsters, and cleared its wildernesses, and founded here and there a great metropolis, the queen of future empires. They have exerted combinations of talents which we cannot hope to see often again exhibited, especially when the condition of the science which produced them is changed. I consider that it is now the destiny of geology to pass from the heroic to the *Historical Period*. She can no longer look for supernatural success, but she is entering upon a career, I trust a long and prosperous one, in which she must carry her vigilance into every province of her territory, and extend her dominion over the earth, till it becomes, far more truly than any before, an universal empire.

Such are the prospects of Descriptive Geology; of the geology of facts and classifications. To our knowledge of causes we can look with no such certainty of its progress being steady and rapid; or rather, we are certain that the advance must be slow, and may be often and long interrupted. For it is not an advance, to suggest one or another hypothetical cause of change, without assigning the laws and amount of the change: it is hardly an advance even to calculate the results of our hypotheses on assumed conditions. To obtain by induction, from adequate facts, the laws of change of the organic and inorganic creation,—this alone can lead us to those discoveries which must form the epochs of Geological Dynamics. And we have yet to learn, whether man's past duration upon the earth, whether even that which is still destined to him, is such as to allow him to philosophize with success in such matters;—whether, not individuals only, not a generation alone, but whether the whole species be not too ephemeral, to penetrate, by the unassisted powers of its reason, into the mystery of its origin;—whether man, placed for a few centuries on the earth as in a school-room, have time to strip the wall of its

coating, and count its stones, before his Parent removes him to some other destination.

And now, Gentlemen, I approach the close of my task, and of the office which has imposed it upon me; an office which has been to me a source of unmingled gratification. The good opinion implied by your selection of me, the good opinion of such a body of men, was an occasion of sincere and earnest self-congratulation,—a self-congratulation hardly damped by my consciousness of an imperfect acquaintance with your science;—since I trusted that you, though not unaware of my defects, had judged that good will, and a disposition to look at the subject in its largest aspect, might in some measure compensate for them. And if I needed other grounds of satisfaction in the employment which I am thus bringing to its close, I might find them in the reflections I have just been led to make in the progress and prospects of the science with which you are concerned. For it has ever been one of my most cherished occupations, and will, I trust, long be so, to trace the principles and laws by which the progress of human knowledge is regulated from age to age in each of its provinces. To have had brought familiarly under my notice, in a living form, the daily advance of a science so large and varied as yours, has been, as it could not but be, a permanent and most instructive lesson;—perpetually correcting lurking mistakes, and suggesting new thoughts. And if, while I have looked at your science in this spirit, you have thought me worthy to be called to preside over your body for two years; and if, during that time, you have not repented of your choice, as I have not found my views inapplicable to the subjects which have come before you; I may, I would believe, find in this some ground for confiding in the trains of thought which have thus led me to such a position; and may hope that, however arduous be the task of framing a philosophy of science suitable to its present condition, and of using such a philosophy as a means of furthering knowledge in general, still, that in this task, to which our age is so manifestly called, I too may be a helper.

I trust that you will excuse these few words uttered with reference to my own peculiar pursuits, since these include yours also, and are my only claim to your indulgence. And now, Gentlemen, that I may trespass upon that indulgence no longer, I

once more thank you in all earnestness and sincerity for your good opinion which placed me in this chair, and for the kindness and support which I have on all occasions received from you; and with my best wishes for your prosperity, and that of your science, I resign my office into abler hands.

ART. IV.—*On the Polished Limestone of Rochester*; by Prof.
CHESTER DEWEY.

TO THE EDITORS.

ONLY a partial notice has been given of this limestone, found in and about this city. The *upper* surface of the transition limestone through which the Genesee river here passes, is in many places *found* polished at various depths under the diluvial deposit and soil. A small surface of *natural* polish might pass unregarded; but a surface of many acres, and over a space miles in length and breadth, is no ordinary fact, and one not admitting of the most ready explanation. The fact has been merely mentioned in the geological reports of this State. Beginning three miles west of the Genesee in the town of Gates, the railroad is cut through the polished limestone for more than a hundred rods in width; the stone being covered with earth from two to eight feet deep. The polished layer is commonly at this place three or four inches thick, bituminous strongly, rather brittle, breaking into irregular fragments. The polish is often so fine as to show faintly, objects by reflection of the light. It would be a beautiful article for window sills, if it could be obtained readily of the proper dimensions, as it is already smoothed for this use. Half a mile north, the polished rock was struck in digging a well, and half a mile east of this in digging a cellar, and half a mile farther east in digging a well, and afforded beautiful specimens; this was seven feet below the surface. More than a mile farther east, about half a mile west of the Genesee, it was struck at the depot of the railroad, nineteen feet below the surface. Half a mile south of this, the Genesee valley canal is dug through this rock for thirty rods; the upper layer being a foot or more thick, and four or five feet under ground. Though the polished surface ceases at each ex-

tremity, the rock continues at nearly the same level; it may be that the direction is oblique to the line of the canal. In another place, however, we are able to trace the edge of the polish, and can see no reason why the polished surface should not continue, unless it is a slight depression of the surface. The Erie canal is cut through this polished rock for many rods, near the Bethel church. These are the chief localities on the west side of the Genesee, till we ascend a mile and a half southwards to the rapids.

In excavating the Genesee valley canal, many rods of the polished surface have been exposed and blasted through. It is the same, but a darker limestone, and some of the polish is exquisitely fine. It extends westwards, under soil ten to fifty feet deep. The polished surface extends along the river by the rapids, from ten to fifteen feet above the bed of the river, and descends from the south towards the north, as the rocks in the rapids. The polished surface descends slightly a few feet or a rod or more, and then polishes a descent of six to twelve inches; passes on slightly descending, till it forms another polished descent like the former. Sometimes a surface is polished which gradually rises on all sides to a few inches above the general level of the surface. On the east side of the Genesee, the polished rock may be seen just below the falls, and at the level of the rock over which the waters fall ninety six feet into the abyss, where Sam Patch lost his life in leaping from the top of the falls. At eighty rods south and up the Genesee, the same occurs perhaps fifteen feet above the river, and twenty above the last mentioned. At sixty rods still farther south, and at the depth originally of more than twenty feet, it forms the bottom of the *sewer* in Main street for several rods; and at sixty rods east on the same street, has been struck in sinking for a well. At half a mile south of this, and nearly the same east of the Genesee, the Erie canal was excavated through this polished surface for perhaps sixty rods. The rock here is two feet thick, and is the rough, ragged, *geodiferous* limestone of Eaton, as it has been commonly called, though it is by some doubted, as it lies at a lower level, whether it is the same rock which passes by this name at Lockport. A fine polish was often given to this rough surface. To speak of no more places, this rock, already polished, is found at various depths, and in large surfaces, over a tract three and a half miles in length from east to west, and one mile and a half in breadth from north to

south; it does not underlie all of this area, because the surface is not every where of this polished rock, but it may underlie no small portion of it, and cover hundreds of acres.

The surface of this polished rock is often marked with grooves, as if a rough and heavy body had moved over it and left deep traces. These are nearly parallel with each other, and on the west side of the river are found to lie nearly from N. E. to S. W. in the rock at the rapids. On the east side of the river below the falls, the direction is but little different from the other, but some degrees more towards the west.

Such are the facts: what can be the cause? The surface was not made thus originally; it has been done *artificially*, though by nature, by some mighty power. The rock often presents the same appearance as that of a *board planed* only on one edge or towards one side. There is the same kind of evidence that the one *has been planed*, and the other *polished*. There is on some of the darker surfaces a *glazed* appearance, although nothing can be removed from the stone without destroying the polish, and is owing to the bitumen in the stone. To the eye the appearance is, that it has been polished like our common marble, by the friction of a hard and smooth surface upon it.

The friction of the water and earth in the Genesee wears somewhat smooth surfaces on the same rock, but nothing like the polished surface now described.

What is the power or cause which could have moved any hard body so as to have produced this result?

It is said that the polished surface has been found over a much larger district, but I have not the evidence to offer.

Rochester, Aug. 9th, 1839.

ART. V.—*On the Temperature of Lake Ontario; by Prof.*
CHESTER DEWEY.

IN Vol. xxxiii, p. 403, of this Journal, I gave some account of the temperature of this lake during the warm months of 1837. The results were so curious that I began to repeat them the next year. The results so perfectly agreed, that the observations were

repeated only twice. The water was a little colder in 1838 than at the same time in 1837. The following are the observations. They were made at each shore, and from five to seven miles distant across the lake, by the same individual, Mr. McAnslan.

Obs. No		1838. May 14.	1838. May 21.
1.	Air,	55°	72°
	Water,	52	60
2.	Air,	53	72
	Water,	48	55
3.	Air,	42	59
	Water,	40	50
4.	Air,	40	52
	Water,	38	40
5.	Air,	39	46
	Water,	37	38
6.	Air,	39	44
	Water,	36	37
7.	Air,	39	43
	Water,	36	37
8.	Air,	40	42
	Water,	37	38
9.	Air,	40	42
	Water,	38	38
10.	Air,	42	47
	Water,	40	42
11.	Air,	45	46
	Water,	44	44
12.	Air,	49	52
	Water,	48	48

American shore in the morning.

In 1837, about the middle of September, the temperature of the lake was about 60° at most of the points across it. On Oct. 16th, it was colder at the shore than in the middle of the lake.

Coburg on the Canada shore.

The mean temperature of the 14th at Rochester, was 59°
 " " " 21st " " " 72

It is hardly necessary to remark that the observations were taken from the mouth of the Genesee, in a nearly direct line to Coburg on the Canada shore. The influence of so great a body of water as that of Lake Ontario, at so low a temperature as 36°, or only 4° above the freezing point in the middle of May, must be palpable on the adjacent country.

ART. VI.—*On the Effects of Light and Air in restoring the faded Colors of the Raphael Tapestries*; by Mr. TRULL,—communicated by *Michael Faraday*, Esq., D.C.L., F.R.S.*

April 21, 1839.

To the Editors of the Philosophical Magazine and Journal:

GENTLEMEN,—You probably remember an exhibition in July last of certain Raphael Tapestries in the Haymarket, and the extraordinary effect the exposure to light and air had had in restoring and altering colors which had faded during centuries of exclusion from these mighty agents. I have received letters from the proprietor Mr. Trull, and if you think parts of them worth publication at this time, when the action of light in the service of the fine arts is so much dwelt upon, they are entirely at your service.

I am, Gentlemen, yours, &c.,

MICHAEL FARADAY.

Warwick-row, Coventry, March 12, 1839.

To Professor Faraday:

SIR,—The interest you took in observing the changes of color in the Raphael Tapestries, after being exposed to light in London last July, made me anxious to communicate to you the extraordinary effects since produced, by the simple means suggested by yourself and other scientific gentlemen, of a more perfect exposure to light and air, which have for the last seven months been obtained, in a finely situated factory here.

I feared to trespass on your valuable time, but could not resist, after hearing of the great public interest now excited by the new process, called, I believe, “sun painting.”

Light and air have done wonders for my tapestries, in dispelling the damp, clearing up the colors, and reproducing others, obscured by the effects of many years' close packing up in boxes. I regret not to be able to make scientific remarks on the progress of the recovery, which others acquainted with chemistry might have done.

The results cannot fully be appreciated but by those who recollect the work when up in London, where the first effects of change unexpectedly commenced.

The greens had all become blue; you, Sir, anticipated a return to the original tints, which has, almost throughout, taken place.

* From the Lon. and Edin. Phil. Mag. and Jour. of Science, June, 1839.

The robes and full colors generally had become dull and heavy ; this has gradually gone off, and left a brilliancy of color and beauty of effect hardly to be excelled. The gold also, as you hinted, has become more clear and bright.

The flesh parts of the figures, which had become pallid, almost to white, have recovered the high tint and deep shadow, and the strong anatomical effect of Raphael.

A renewed freshness now reigns over the whole, and the clearing up of the light in many of the landscape parts is most extraordinary, giving a depth and breadth the cartoons themselves do not *now* convey, particularly in the Keys to St. Peter, St. Paul at Athens, and the Death of Ananias ; where extensive landscape, ranges of buildings, and foliage have sprung up, like magic, on parts *quite obscured* when up in London eight months back, much of which is either worn, or torn out of Raphael's patterns at Hampton, and painted over, and known only through the means of these Leo Tapestries.

I should have much pleasure in giving you any further information on the subject I am capable of, or in showing the works to any persons taking an interest in them.

I am, &c.

WM. TRULL.

Coventry, April 17, 1839.

My former letter in regard to the extraordinary changes the Raphael Tapestries had undergone the last seventh months, use as you think proper. I regret not being able to give you a scientific description from the first, and the progress ; and the absence of a gentleman acquainted with the chemical effects of light and air, to have noted the changes, is much to be regretted both for science and art. The works themselves being unique, and of above three centuries, so placed for so many years in continued damp to effect such mischief to the colors, are circumstances never to occur again.

Some colors entirely changed, others in confusion and apparently gone, yet by the *mere* effects of light and air, slowly and quietly resume the chief of their original tints ! Flesh reappears, hair on the head starts up ; the grand muscular effect and unique power of expression, only found in Raphael and Michael Angelo, are finely developed where a few months back appeared a plain surface ! *Here* are the works, and the facts may be *now* ascertained.

I have applied to the directors of the British Institutions, Pall Mall, to permit one or two of these Tapestries to be exhibited with the old masters in June; thus those who saw them last year, may be able to see what they now are, and both science and art may be served; for a comparison has never yet been made, since the Cartoons were repaired and painted upon, with the tapestry.

I think, Sir, you will recollect my subject of the stoning St. Stephen, the large masses of blue cloud-like appearance hanging about and over Jerusalem: these have nearly disappeared, and mountain scenery taken the place! The olive grove, which only showed a few trees in front all blue, and a heavy blue-like curtain was over all of the grove; the curtain has disappeared, and a fine deep grove is now seen; the natural green and mossy bank have nearly taken their original state; fresh lights keep breaking out and showing even deeper in the grove! and throughout the works, the original lights are working their way, from the heavier color.

I remain, Sir, yours, &c.,

WM. TRULL.

ART. VII.—*Of the Reaction of Sulphuric Acid with the Essential Oil of Hemlock*; by CLARK HARE, of Philadelphia.*

If equal parts of sulphuric acid and oil of hemlock be mingled together, refrigeration being employed to prevent too great a rise of temperature, a black acid resinous mass results. By the addition of carbonate of lead and water, the unaltered sulphuric acid, present in great quantity, is converted into an insoluble sulphate, which, mingling with the resin, gives rise to a yellow mass resembling putty in its consistency, while there will be found dissolved in the water two soluble salts of lead.

The presence of a very large quantity of coloring matter, interferes with the examination of these salts. This, however, in a great measure disappears on precipitating the lead by sulphydric acid gas, resaturating the liberated acids by the carbonate, and again throwing down the lead in the state of a sulphide. The partially decolorized acids thus obtained may then be saturated with barytes, and the resulting salts evaporated to dryness, when they assume the appearance of an amorphous mass. By washing

* Eldest son of Dr. Hare.

with absolute alcohol, one of the salts present in this mass is dissolved. On the solution of the other in water, and subsequent crystallization, it proves to be the acetate of barytes.

The salt dissolved in the alcohol does not appear susceptible of crystallization, probably on account of its extreme solubility. On drying it assumes a gummy appearance, and by still farther desiccation, may be obtained in the state of a dry mass destitute of cohesion, and susceptible of being with facility reduced to the state of a powder.

When exposed to heat in a retort, this salt resists an elevated temperature without alteration, but at length, if heated rapidly, carbonizes, giving off sulphurous acid and a small quantity of essential oil and water. There remain in the retort a spongy carbonaceous substance, and a large quantity of sulphite of barytes. As this result proved the acid united with the barytes to consist of organic matter, combined with sulphuric acid and modifying its properties, in order to ascertain the quantity of the latter present, barytes was precipitated by carbonate of potash, the precipitate weighed and the resulting potash salt evaporated to dryness. It was then intimately mingled with the black oxide of copper and nitrate of potash, nitric acid added, and the whole mass gradually heated to redness. Red fumes are given off during the whole of the process, and while the nitric acid at the beginning of the operation prevents the deoxidation of any portion of the sulphuric acid; at the end, the oxide of copper prevents the explosive reaction which would ensue, were nitric acid and nitrate of potash alone present.

The result of two experiments made in this manner, the mass after ignition being washed with diluted chlorohydric acid, and the solution precipitated by barytes, was as follows:—
Carbonate of barytes $12\frac{1}{2}$ gr's. Sulphate of barytes $16\frac{1}{2}$ gr's.
Carbonate of barytes $13\frac{1}{4}$ gr's. Sulphate of barytes $16\frac{1}{2}$ gr's.
The quantity of sulphuric acid as calculated from the quantity of sulphate precipitated, is in each case, 5.59 gr's., while as calculated from the precipitate of carbonate of barytes, on the supposition that one atom of it is present in the barytes salt for each atom of base, it would be 5 gr's. in the first instance, and 5.3 gr's. in the second. It will therefore be perceived that in both experiments the quantity of sulphuric acid, as calculated from the results, exceeds the quantity necessary for forming an equivalent with

the base present. This must be attributed either to some inaccuracy in performing the analysis, or to the presence of a small quantity of some sulpho-organic acid, containing in its neutral salts, two atoms of sulphuric acid for each atom of base. The former explanation is by far the most likely to be true, and it seems probable that the composition of a neutral salt of this acid may be represented by one atom of sulphuric acid, one atom of organic matter, and one atom of base.

A number of compounds possessing the properties of acids have been discovered, consisting of an acid of sulphur modified by some organic substance. These compounds may be divided into two classes. In one are comprised those acids which are composed of two atoms of sulphuric acid, united to one of organic matter acting as a base, and which consequently, in forming neutral salts, unite with but one additional atom of base. In the neutral salts formed by the other class, two atoms of sulphur are also present for each atom of organic matter and each atom of base, but are combined with oxygen in such proportion as to form hyposulphuric acid, so that the organic matter present cannot be considered as acting the part of a base. Under the first of these heads may be enumerated the sulphovinic, sulphetheric, sulphomethylic, and sulphocetic acids; under the second the benzosulphuric, sulphonaphthalic and probably the sulphovegetic and several others. For the acids contained in the first class, custom seems to have assigned as a nomenclature, a name derived from the organic matter entering into their composition, modified so as to terminate in ic and having the term sulpho prefixed. For the second, no fixed rule seems to have been laid down. The German chemist who discovered one of the two acids whose composition has been ascertained with sufficient accuracy to enable us with certainty to place them under this head, gave to it the name of benzosulphuric, while the other acid still retains the appellation of sulphonaphthalic which it received when its composition and properties were still supposed to be analagous to those of the sulphovinic and other acids which belong to the first class. The acids described in this article, if the view given of its composition be correct, must be considered as belonging to a division of the second class hitherto unoccupied unless by the sulphindigotic acid of Berzelius. In the hemlosulphuric, as in the other acids of this class, there is present one atom of an oxacid of sul-

phur modified by an atom of organic matter which does not, as in the first class, act as a base, or diminish the saturating power of the acid. If, therefore, we should adopt the nomenclature of the German chemists, with the change of sulphuric into hypsulphuric as necessary to designate with precision the acid of sulphur in question, for the acids of the second class, calling them benzohypsulphuric and naphthalohypsulphuric; and applying the same idea to the acid described in this article, name it hemlohypsulphuric, the ends to be attained in forming a nomenclature would perhaps be as well answered, as is practicable without departing too widely from established custom.

Hemlosulphuric acid possesses a sour taste and peculiar odor. It does not appear susceptible of crystallization, either when free or as far as I have examined its compounds, when combined with bases. The salts which it forms with potash lime and barytes leave in the mouth a decided and long continued impression of sweetness. Though extremely soluble they are not deliquescent. If the hemlosulphate of barytes be kept for a length of time at a temperature between 500° and 600° , the sulphate of barytes and organic matter of which it is composed separate, the latter in the shape of a resinous powder insoluble in water, though soluble in alcohol and ether. This seems a singular instance of a body very soluble in water, affording by the mere separation of its constituents, two others eminently insoluble in that liquid:

In the resinous yellow mass into which the greater part of the hemlock oil is converted by the action of the sulphuric acid, there is present a yellow oil which contains sulphuric acid combined with it in a neutralized state. By the action of ether, this oil may be dissolved, and by subsequent evaporation, deposited, but when thus obtained it is contaminated by so much resin that though the presence of sulphuric acid may be ascertained, it is impossible to determine the atomic composition.*

From the reaction of sulphuric acid, with oil of turpentine, nothing more appears to be produced than a reciprocal decomposition;

* It is well known that by the reaction between chouchyrie acid and pure oil of turpentine, two species of artificial camphor are generated, one solid, the other liquid. Having obtained both of these compounds a few years since, Dr. Hare subjected the oil of hemlock to chlorohydric acid by the same process, but could not thus obtain any concrete camphor. That which he did obtain was analogous to the liquid artificial camphor above mentioned.

though a different result might have been anticipated from the close analogy which appears to exist between this essential oil and that of hemlock. Caoutchouchine, however, reacts with sulphuric acid in a manner quite analogous to the oil of hemlock, giving rise to a yellow resin and an acid compound of sulphuric acid and organic matter, which forms soluble salts with lead and barytes. An oil, however, separates and floats on top, which appears insusceptible of farther attack from the acid.

ART. VIII.—*On Water-Spouts*; by HANS CHRISTIAN ØRSTED, Professor of Natural Philosophy in the University of Copenhagen.*

ALL naturalists, except those who have themselves proposed an explanation of the water-spouts,† are agreed in thinking that science has hitherto given us but little satisfactory information on the phenomenon. This may, in some measure, long continue to be the case, if we desire a perfect explanation of the first change in our atmosphere by means of which a water-spout is caused. It appears, that, owing to the overstrained regard paid to this higher demand, which must so often be left unsatisfied, the simpler but yet fruitful labor has been neglected, of bringing together the remarkable appearances with which observations on the subject have furnished us, and by this means ascend gradually from the effect to the *proximate* cause, until at last we may perhaps succeed in ascertaining clearly the bearings of the whole matter, although, at the same time, much in reference to the *ultimate* cause, may still remain wanting to satisfy our desire of information. It appears to me, that, by following this less ambitious course, we may advance nearly as far in our knowledge of water-spouts as we have done in respect to thunder-storms, wind, rain, and many other natural phenomena; inasmuch as we can probably specify with tolerable certainty the power by which they are produced, although we cannot accurately determine all the circumstances connected with the principles by which the action is caused at a given place with a given degree of intensity.

* From *Jameson's Edinb. Journal*, July, 1839.

† As we have no English term exactly equivalent to the German *Wettersaule*, we have employed the name of *water-spout* in its place, throughout the present article.—ED. JAMESON'S ED. JOUR.

I have collected the chief features for my description of the phenomenon, from numerous scattered descriptions, for which we are indebted to observers in different ages and in different quarters of the globe; and I venture to hope that the combination of facts thus elicited will keep us free from many errors, in which most of those have been involved, who have hitherto endeavored to explain water-spouts. It is quite possible that I may have overlooked circumstances which would tend to explain the subject, or that I may have misunderstood some of the facts contained in the descriptions; but this can easily be remedied by the obliging communications of others, whenever we possess a general analysis of the facts.

General Nature of Water Spouts.—The water-spout is a strongly agitated mass of air, which moves over the surface of the earth, and revolves on an axis, of which one extremity is on the earth and the other in a cloud. From this cloud a continuation proceeds downwards, which forms the upper portion of the water-spout; while the lower portion, besides air, consists sometimes of water, sometimes of solid portions, according as the water-spout passes over land or over water. Some have separated water-spouts over the land and over the water from each other, but this creates confusion, for water-spouts have been observed which were formed over water and advance over land; and *vice versa* we have accounts of water-spouts which were formed over land, and afterwards were suspended over the surface of water. They have also been seen cutting right across a river, and then continuing their course over the land; or crossing straight over an island, and then proceeding over the sea. The hitherto generally employed term *wasserhose* (water-spout) seems to me to be not altogether a correct one, and I have therefore made use of the less common one "*wettersäule*" (literally storm-pillar,) although perhaps the name *wirbelsäule* (whirl-pillar) or *luftwirbel* (whirlwind, air-whirl or vortex) might be equally appropriate.

Form of the Water-Spout.—The uppermost portion is almost always wider above than below; and has sometimes the form of an inverted cone, sometimes of a funnel, and sometimes of a somewhat twisted horn. The middle portion is commonly much narrower, is frequently bent, and sometimes exhibits opposite sinuosities. The lower portion is apparently much widened, but probably only apparently so, owing to the portions of water and

earth hurled round itself by the vortex. Occasionally water-spouts present expansions or contractions, but these instances are only exceptions from the general rule. Generally there is only one water-spout suspended from one cloud, and it is only now and then that there are several; on one occasion no less than fourteen were noticed, all of which seemed to belong to one and the same cloud.

Dimensions of Water-Spouts.—The height of water-spouts has been very variously estimated. I have been able to meet with no actual measurements, and have only seen accounts founded on mere calculations by the eye. A height of from 1500 to 2000 feet has been assigned to most water-spouts; but some have been seen at such distances, that the height cannot have been less than from 5000 to 6000 feet. Some observers have given a low estimate of the height, reducing it even to 30 feet; but, in such cases, the lower part of the pillar has been undoubtedly mistaken for the whole. This might easily happen to a person who was not possessed of proper information regarding the phenomenon; for when a water-spout begins to be formed, especially over water, there is often seen a pillar of water or of drops of water, rising from the surface, without a particular connection with a cloud being observable; but this connection is to be found, if it is sought for, and supposing we do not imagine that the cloud must necessarily be perpendicularly above the water-spout. Should such a water-spout in the act of formation be afterwards interrupted in its development, its base might easily be mistaken for the whole. It is apparent from all the circumstantial accounts we possess of water-spouts, that their upper portion is a cloud.

The diameter of water-spouts is very various. The lower portion has generally a diameter of some hundred sometimes above a thousand feet, but often much less. The vortex of drops or solid particles which the water-spout whirls along with it, has however, been sometimes included in the mass forming the lower portion. But those cases are to be regarded as exceptions where the diameter of water-spouts has been measured by the hollows they have formed in the earth, which afford a much less considerable size. The diameter of the middle portion is often estimated at only a few feet, but this has been chiefly by inexperienced observers. It will be made probable from what is to follow,

that the middle portion of the water-spout is surrounded by a whirlwind, which does not allow of observation, owing to its containing no opaque particles.

Color and Transparency of Water-Spouts.—The color most frequently assigned to water-spouts is grey, dark blue, also dark brown, and fire red; from which it would seem that the colors are the same which the clouds assume in their different states of illumination.

The middle portion of water-spouts is often transparent, but this holds good only in those which occur over water. One water-spout was noticed whose middle portion was opaque while it traversed the land, but became transparent when it proceeded over a river. The transparency of this portion at the sea has sometimes been observed to so great an extent, as to allow of those clouds being seen through it which were lighted up by the sun. When an opaque water-spout begins to become feeble, the cloud-like portions, which had descended into it, retire, and as the drops of water, the foam, the dust, &c. which caused the opacity, are no longer driven upwards to so great a height, the middle portion becomes transparent.

Duration and Movements of Water-Spouts.—Water-spouts generally last longer the larger they are; but they rarely continue for half an hour, and there is hardly one example of an hour's duration.

Water-spouts seldom, if ever, remain the whole time at one place. There is great inconstancy in their rapidity and direction. They sometimes have so great a rapidity as to move seven or eight German miles (thirty two to thirty seven English miles) in an hour; at other times they advance so slowly, that pedestrians can easily follow them, and occasionally they remain quite stationary for a time. Their course is sometimes quite straight for a long distance, but not unfrequently it is interrupted; in some instances it is zig-zag. Their course, however, has for the most part a principal direction or bearing. It has been asserted that the direction of water-spouts is most frequently from southwest to northeast, and certainly the data hitherto collected go to confirm this opinion.

Water-spouts do not remain uniformly at the surface of the earth, but alternately rise and fall; and hence we see, that, during their progress, they have in some places, torn up trees by the

roots, in others, only torn away the upper portions, and that at some points they have not touched them at all. This alternate rising and sinking often becomes very evident when a water-spout traverses a plain or the sea.

The circular rapidity of water-spouts is also very variable, for frequently the eye can hardly follow it, while at other times their motion is not so violent. Almost all observers expressly mention this circular movement, and I do not find that its existence is contradicted by any one who have themselves seen the phenomenon. It is true that two American naturalists, who examined the traces left by a destructive water-spout, declared that these traces exhibited no circular movement, whereas Professor Hare mentions that there was an indication of rotary motion on a chimney. We shall see, however, in the prosecution of our investigation, that the lower part of the water-spout has no circular movement, so long as it does not touch the ground.

There has also been noticed an ascending and a descending movement of water-spouts, the one being, of course, nearer the middle than the other. In respect to the directions observed, there prevailed some apparent contradictions, but these will be explained in the sequel.

Many observers have distinctly seen windings like those of a screw; and not unfrequently, some of these spiral windings are turned right and some of them left, one winding being nearer the middle than the other. Friedrich Rabe, who observed a water-spout in Laaland, saw straw, leaves, and other light objects, raised in spiral windings without the water-spout.

Power of Water-Spouts.—The power with which water-spouts act is often very great. They have been known to move heavy cannons, and to tear up large trees by their roots. A water-spout has been seen to transport a large tree to a distance of 600 feet. They sometimes unroof houses, nay, even overthrow the houses themselves. Beams employed in the support of roofs, have been carried to a distance of 1400 feet; and entire houses, composed of wood, have been raised up and removed to new positions. On one occasion, a water-spout was seen to roll up moist linen on a bleaching ground, and to transport it, together with a beam accidentally enveloped in it, the whole weighing upwards of 500 pounds, over a house forty feet high, and to a distance of 150 feet. Objects of little weight are carried to very great distances;

thus, a water-spout has been known to transport a sewing-bag about seven English miles, and a letter upwards of twenty English miles. A fish-pond has been emptied by a water-spout, and the fish scattered round its margin. On Christiansöe, a water-spout emptied the harbor to such an extent, that the greater portion of the bottom was uncovered. But the action is not always so violent. They have occasionally passed over small vessels without doing them much harm. On land, men have been carried up by them, and yet let down again unharmed. An individual, who had the curiosity and boldness to follow a water-spout, was involved in one of its spiral windings, but escaped without injury.

It is probable that, in some of the cases, where a fall of seeds, animals, and other similar objects from the atmosphere, has been noticed, the phenomenon is to be ascribed to water-spouts.

The examples already given, prove clearly that there is an elevating power in water-spouts, and it would be easy to multiply them to a great extent, if we had not, at another part of this essay, to adduce many similar ones for other reasons. I shall here notice only one other instance, which is of consequence, from the care with which it was observed. On the 19th of June, 1835, a great water-spout passed over New Brunswick in North America. Three days afterwards, its effects were carefully investigated by three scientific men, and more especially with reference to the direction of those displays of violent action which had been exhibited. Of course, such an investigation could only discover the direction in the immediate vicinity of the earth. The water-spout followed a course from west to east, and traversed a space of about thirty five English miles in less than fifty minutes. It was found that those trees which were overturned in the middle of its course or near it, lay with the tops towards the east, so that the existence was thus shown of a current of air having the same direction as that taken by the water-spout. On the other hand, those trees which had fallen further out on either side, lay, it is true, with their tops towards the east, but not directly so, being at the same time turned towards the centre of the course of the water-spout. It was also discovered, that at first, an opposite direction, viz. from east to west, must have been followed at every place, for rotten and brittle trees, which must have been first overthrown, lay under the others, and were turned to that direc-

tion whence the water-spout came. This is easily explained by the supposition that currents of air, near the earth's surface, move every where towards the centre of that place in which the water-spout is for the moment; whence it follows, that, round the anterior half of the latter, streams of air must occur in which the east is the prevalent direction, while the western direction is the predominant one in the currents round the posterior half. In some places, where it appeared that the water-spout had receded for some time, and had again descended, it was ascertained, that the overturned trees were turned with their summits to a common center. Many circumstances also demonstrated to the observers, that a rarefaction of the air in the interior of the water-spout, and one of great extent, had occurred. Not only were roofs and the upper coverings of houses removed, but even floors were broken up; a phenomenon not easily explained, unless we assume that the pressure of the air from without had become very rapidly and greatly diminished, so that the expansive force of the inclosed air must have acquired a very considerable preponderance. Many other effects of this same water-spout confirm this belief. Walls and windows were often thrown or broken outwards. In one house which had suffered much from the water-spout, a bed cover was pressed into a crack in the wall, and remained as firmly fixed as though it had been intentionally thrust into it; a pocket handkerchief likewise was found in a crack of the opposite wall. Those objects which had been transported by the water-spout, were conveyed to the north side, and to a greater or less distance, according to their greater or less weight.

Sound and Smell of Water-Spouts.—Water-spouts are often accompanied by a violent noise, which, for the most part, has been compared to the sound of many heavily laden waggons moving over a stone pavement, or to the breaking of the waves of an agitated sea against the coast; but, by some, has been said to resemble the roar of a great waterfall. Besides these great noises, a whistling or piping sound has not unfrequently been heard.

Water-spouts often leave behind a sulphureous smell, and there are examples of a disagreeable smell remaining along the whole tract traversed by them. One individual, however, who became involved in a water-spout, perceived no odor.

Situations and Circumstances in which Water-Spouts occur.—

Water-spouts do not occur with equal frequency in all situations. They are more abundant on the sea than on the land; more frequent on coasts than far out at sea, or at a distance in the interior of the dry land; and they have been more often noticed in warm regions than in cold ones. They seem to occur more especially at places where calms frequently alternate with storms.

Water-spouts take place for the most part in still weather, and during unsteady winds. In the greater number of instances, storm clouds have been remarked in the sky before their appearance. Most frequently several occur, either at the same time, or immediately after one another; and often there is observed a new one forming where another disappeared a short time previously.

We seldom read accounts of water-spouts without finding also that electrical phenomena were noticed at the same time. Lightning is almost never wanting; thunder is likewise often connected with them, and it has been remarked that the loud noise which follows water-spouts easily prevents feeble peals of thunder from being heard. Now and then, a more widely dispersed light has been seen; so that people imagined that the corn in the fields was on fire, but afterwards to their joyful astonishment found it uninjured. It has been reported of one water-spout that fire balls proceeded from it, of which one was accompanied by a report like that of a musket. Probably, however, in this instance, electric sparks caused a deception. Frequently, great storms follow the occurrence of water-spouts; sometimes they precede them.

Water-spouts are often accompanied by hail; also by rain in large drops either during the period of their occurrence, or shortly afterwards. The pressure of the atmosphere has been very rarely recorded by those who have described this phenomenon. In my notes I find only one instance of the height of the quicksilver in the barometer being mentioned, and this is in the observation of a water-spout which, on the 16th of June 1775, traversed the neighborhood of the town of Eu. The height of the barometer for three days had been 28 In. 5 L. (= 30.28 English,) but fell at 7 o'clock in the morning 2½ L. (= .22 English.) At 8 o'clock the water-spout made its appearance, and about noon the quicksilver had risen to the same height at which it stood in the morn-

ing. This result is sufficiently remarkable to make us desirous of possessing further observations of a similar nature; but, as I have already said, my notes contain no others; and on referring to the books in my possession, I have found no information on this subject.

Formation and Phenomena of Water-Spouts.—In most accounts it is stated that water-spouts are formed from above. Some observers, however, expressly say, that they have seen them in the act of being formed from below. *Michaud*, who in 1789, observed some water-spouts in the harbor of Nice, laid much stress on this commencement from the surface of the sea; it will appear, however, from what is to follow, that this only seems to be the case, and proceeds from the circumstance that the whirl of wind which forms it, so long as it is not impregnated with vapor or drops of water is not visible.

When a water-spout begins to be formed over the sea, there is generally to be observed a circular portion of the surface of which is uneven, and has a black appearance. Soon after, the water is elevated in the form of a pillar, in which a violent internal movement is observable, the height being several fathoms. It foams, and produces drops of water above, which it scatters in great quantity on all sides, so that it distinctly exhibits an ascending and descending course, which moves in parabolic curves, like spring water ascending in a slanting direction. The internal movement has been compared to boiling, and it has been believed that this idea was confirmed by the mass of vapor and fog which generally floats above the water-spout. *De la Nux*, however, who, for forty years, lived in the Island Bourbon, where water-spouts are extremely common, maintains that this vapor is only apparent, and that it proceeds from the great number of drops of water spurted about. He also says, that, in order to be convinced of this, it is only necessary to see the phenomenon in a proper light, it would, however, be too bold to assert that this is always the case. It is not impossible that vapors may be formed around the agitated water, if that water possessed a lower temperature, than the air and thus cooled the moisture contained in it. That this takes place, must not be assumed, until the circumstances observed shall give sufficient support to the idea.

On land, the nature of the phenomenon does not easily allow observers to see the beginning of the formation of the lowest

part of a water-spout; and accordingly, I find no data on the subject in the published descriptions. The upper part is always described as proceeding as if from a thick cloud. There is often remarked only a very slight increase of size of the cloud, which, however, is gradually extended, and presents the lengthened funnel-shaped portion. Over the sea, the upper part of the water-spout has been seen to stand far from the place which lay perpendicularly over the lower portion, until its line of union approached more nearly to the perpendicular position.

Both on land and water, there has often been seen, in the upper part of a water-spout, a thin streak of vapor which seemed to sink downwards from the cloud, and afterwards maintained itself in the fully developed water-spout. This is most easily observed at sea, when the lower portion is generally transparent. Such a streak is naturally removed from observation when the water-spout is opaque. It was remarked on one occasion, that it became visible while a land water-spout was crossing a river.

We can hardly assume that the top of the water-spout is at that point, where, to the inattentive eye, it appears to lose itself in the clouds. Shortly before the appearance of that water-spout which occurred in the neighborhood of Eu, it was observed that the clouds separated, and that some went in an opposite direction from the rest, a fact which seemed to indicate a consequent turning round. A careful observer, *Holm*, remarked during a water-spout near Copenhagen, through the openings in the lower strata of clouds, a rotatory movement in those lying above. From the upper portion of the water-spout, there proceeded white clouds which had a whirling motion like the water-spout itself.

When the dissolution of the water-spout approaches, the middle portion, especially that part nearest the earth, becomes more and more transparent. The water-spout generally breaks up in the middle. The upper portion shrinks and disappears in the clouds. It is not probable that the latter immediately pass into a state of repose. According to what has been already mentioned, regarding the observations of *Holm*, it is evident, that the clouds, after all appearances of a water-spout have ceased, nevertheless retained a rotating movement. It was at the same time remarked, that not only those clouds which formed the upper portion of the water-spout, but also the rest at some distance, possessed a circular movement.

On the actual nature of a Water-Spout.—If now, after all this, we ask, what a water-spout really is ; the answer would be : it is a whirlwind (Luftwirbel.) By itself, a water-spout is not more visible than air itself, but those portions which are mixed either with vapor, drops of water, or solid matter, become visible.

The source of this vortex is not to be sought in the lower regions. There is no peculiarity of the earth's crust with which the phenomena of water-spouts seems to be connected ; for, they occur in countries of the most diversified constitution, as, for example, in volcanic, as well as in non-volcanic districts: In the sea also, there seems to be no condition of the water or of the bottom, on which their occurrence is dependent. Just as little can these vortices be produced by the winds prevailing at the earth's surface, for they take place most frequently in the midst of a serene atmosphere. They must, therefore, have their origin in the upper regions.

Owing to the circular motion of water-spouts, all the parts exhibit a centrifugal action towards the circumference. This force is, as is well known, a necessary consequence of the nature of rotatory motion. But any one even who is not acquainted with the laws of circular motion, can form a perfect idea of this matter, by taking a transparent vessel, as for example a flask, filled with a mixture of sand and water, and by some means or other turning it round on a perpendicular axis. The heavier portions will then be observed on the outside, and the lighter in the middle. Those portions which are carried to the greatest distance from the middle, are at the same time upwards ; this takes place because the agency which drives them outwards finds a limit at the circumference, which forces the particles that are in motion to ascend, the only direction in which they can yield to the pressure. We may be easily convinced that this action also takes place in the open air, by distributing smoke in the air, from a tobacco pipe for example, and then, at a distance of one or two feet, producing a rapid rotatory movement, when the extension of the whirlwind becomes apparent by means of the smoke.

Owing to the rotatory motion, the particles in the middle must also have a centrifugal action, and there must thus arise a great rarefaction of the air at the centre. So long as the whirlwind does not reach the earth, the air must ascend, to fill up the

vacant space which has been left by the particles of air proceeding outwards. The air must therefore stream in anew from all directions, so that, when it has no particularly great progressive rapidity, those objects which are carried round by it must be directed to a common centre; but when the progressive rapidity is great, the influence of both forces on the direction must be perceptible. The rotatory movement does not affect those currents flowing inwards, inasmuch as it is taken for granted in this case, that the water-spout, although very near the earth, has not touched it; for, in the latter case, the centrifugal force would also drive outwards the particles of air near the earth. So long as the water-spout does not reach the earth's surface, an ascending current must prevail in its interior, which here constitutes the elevating power. When it strikes buildings, it may very often happen that the inward flowing currents from below become either entirely or almost altogether stopped. There thus arises a great rarefaction of the air around and over the building, so that the included air must drive the windows and walls outwards, and must at the same time force upwards roofs, and other objects which have air under them.

A tube of the length formed by the centrifugal force of the water-spout cannot be sufficiently filled from below by the inward flowing currents. A portion of the cloudy mass must hence descend into the vortex. It is naturally the portions nearest the middle which are driven with the greatest force downwards; nay, in a certain state of matters, the portions in sinking will be altogether stopped by the centrifugal force. We can easily understand from all this the funnel-like shape of the upper portion of the water-spout. On the other hand, the great attenuation near the middle, may very easily give rise to the descending stripes of cloud which we so often notice in water-spouts. If the whirl of air is immediately over the sea, the water must ascend under it, partly owing to the rarefaction of the air above it, and partly owing to the air streaming in from all sides. Besides, the air contained in the water must get out, and must force itself towards the less filled space above, as always happens when the pressure of the atmosphere is diminished over water, and especially when there is rapid motion. We therefore find that the water, when the whirlwind approaches, rises up, foams, and is agitated. The greater or less proximity of the vortex must have great influence on the extent of the action.

When the whirlwind comes entirely in contact with the surface, whether it be on dry land or water, the particles of air must be sent outwards by the centrifugal force, and the currents towards the spout must consequently cease. The motion of the air is also communicated to all easily moved solid as well as liquid particles which come in contact with the vortex. They thus acquire, not only a movement outwards, but also a movement inwards. This occurs in the following manner: The circular motion extends itself downwards, and thus throws outwards towards the circumference, solid particles or water, according as the water-spout is over land or water; but, on the direct course outwards, such particles experience great resistance from the surrounding mass, so that they must ascend as they retire from the middle. This is shown in the excavation left when the water-spout passes over loose soil, and also by the uncovering of the bottom when it traverses shallow water. It cannot be doubted, that a deepening of the sea also takes place, but this cannot be so easily observed.

On water, the combined movements upwards and outwards can be seen in great perfection, for, round the foot of the water-spout, water is thrown out in parabolic curves; nay, one observer has remarked water round the base in the form of a reversed basin. Upon the whole, it may be said that the water round the base of the water-spout forms a great wreath of elevated water, with a bubbling and foaming surface.

The particles carried up in the water-spout at the same time acquire a spiral motion, owing to the whirling which is combined with it. The falling particles, as, for example, drops, or minute solid substances, which, ere the water-spout reached the earth, had been driven upwards, or descending rain-drops and hailstones, must also enter windings, which, however, cross the windings already mentioned; for movements which are ascending and descending, and which are directed to one and the same side, must cross each other as *ab* and *cd* in the accompanying figure.

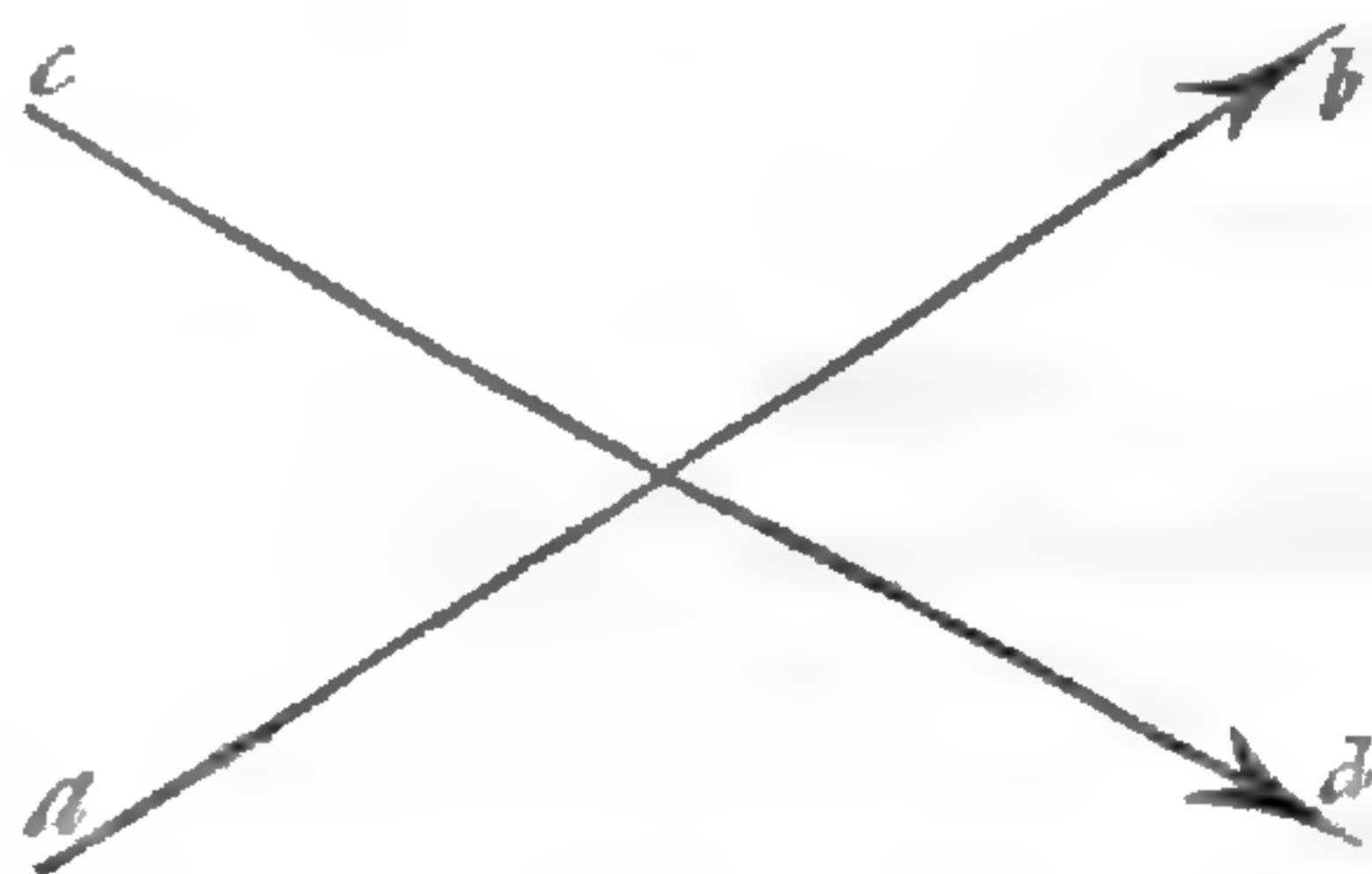

Hence there are generally two spiral movements in a transparent water-spout, one to the right and another to the left.

It has been said that water-spouts over water are for the most part transparent, because they contain water; but experience proves, as well as the very nature of the thing, that in the interior there is no connected mass of water. It would be more correct to say that water-spouts which come over sea are more rarely opaque, because they can contain no dust, and hence can only be so far opaque that they include numerous minute drops, or, what is most usual, a portion of the fog-like cloudy mass. We can, therefore, easily understand why the lower part of the middle portion of a water-spout becomes generally transparent at last, viz., because the whirling movement becomes weakened, and the cloud-funnel is hence shortened.

We have seen that the air which is immediately above a water-spout, must descend into that portion of it in which the air is attenuated, and, therefore, in the vicinity of the axis more especially. If now, as we suppose, the whirlwind extends upwards, far above the cloudy mass, in which mere observation would assign its commencement, the descending air, coming from colder regions, must condense the vapors which it meets with on its path, and partly produce large drops and partly hailstones. We can thus easily imagine that the frozen particles, during all these movements, are sometimes out of contact with warmer and moist air, and also that they are again equally often brought back to situations where they meet them, so that alternately they become so much cooled that the water by which they are coated becomes ice, or they meet moist air in which they acquire a new covering of water. Hence large hailstones may be formed, composed of various layers, the one including the other.

All this corresponds in the most remarkable manner with the facts observed. Great storms of hail and violent showers of rain almost invariably accompany water-spouts. It may, perhaps, not be too bold to suppose, that the great falls of hail, which so frequently devastate long but narrow tracts of fruitful land, are produced by great air-vortices in the higher regions of the atmosphere, or, if I may be allowed so to express myself, by water-spouts which extend beyond the lower strata of clouds. So far as I can judge, no circumstance occurs during great showers of hail, which does not harmonize with this idea. Electricity, which accompanies most hailstorms as well as water-spouts, may perhaps contribute by causing a greater variety of movements

than those which arise from vortices, and thus assisting the formation of hail, so that Volta's supposition, that electricity co-operates in producing hail, here finds an application; but we should not wish to see ourselves forced to assume this co-operation, in case the presence of electricity should not show itself so distinctly in all these formations of hail.

In the axis of water-spouts, and near it, there must also, without doubt, be a portion of watery vapor condensed. From this source, probably, is derived the rain which falls in large drops on ships that encounter water-spouts, and which has been found to consist of fresh water. The water-spout mentioned above, whose effects were so carefully noticed in North America, must also have contained water, as all objects it met with were sprinkled with mould on the west, that is the side from which it came.

When moisture is rapidly condensed, electricity is produced, and we have an opportunity of observing this sufficiently well in storms. Hence water-spouts must also be accompanied by thunder and lightning. By means of the electricity developed in water-spouts, we may, perhaps, explain the power by which, as has been occasionally observed, water-spouts alternately repel and again attract small cloudy masses. That they should be attracted by a different portion from that which repelled them, agrees precisely with the natural laws of electricity.

Although we are certain that the formation of water-spouts is accompanied by electrical action, yet we are not therefore entitled to conclude that electricity is their cause. Distinguished naturalists have expressed this opinion, but without explaining the manifold peculiarities of water-spouts. But still, even more recently, it has been attempted to explain by this cause their rotatory movement, by assuming in them, the existence of a strong electrical current, which, by means of the magnetism of the earth, received its circular movement. It appears to me, however, that there is much to contradict this opinion. Although we possess the clearest proofs of the electrical nature of water-spouts, yet it seems to me not at all proved by any of the effects noticed, that they contain an actual electrical current. Individuals who have been in contact with water-spouts, never felt an electrical shock, or should a shock actually have been experienced in any instance without our being aware of it, yet there have been many cases in which it was not the case, although the human

body can neither enter nor quit an electric current without receiving a shock. A decisive argument, in my opinion, which can be opposed to such a view, is, that a water-spout, whose electricity should be of such a description that the magnetism of the earth could communicate a stronger circular movement, must act very violently on the magnetic needle; now this has never been noticed in any one of the numerous vessels which have been in the vicinity of water-spouts. Even though it were to happen that *on one occasion* the needle should be affected by the approach of a water-spout, still this would by no means afford sufficient proof, for such an electric current as that assumed to exist by the theory must *always* throw the magnetic needle into considerable agitation. Hence it seems evident to me that the electricity of the water-spout as well as that of the thunder storm, is not the cause but the effect of the natural phenomenon.

The sulphureous smell which has been perceived after a water-spout, would seem to be of the same nature as that remarked after a stroke of lightning.

The sound which so often accompanies a water-spout may be produced by the striking together of the hailstones; for this must here be very violent, and, on account of the proximity, much more easily heard than the rattling of more remote hail-clouds. The hissing noise must occur when the air is streaming into the water-spout from beneath.

The circumstance that many water-spouts are often suspended from one cloud must doubtless be explained in this way, that the cloud is not simple, but contains as many vortices as there are water-spouts exhibited. This agrees also with Holm's observations made at Stockholm in 1779, when he saw several clouds turned round in one vortex.

It is plain that the whirlwind must not necessarily remain perpendicular to the earth. Hence it follows that it may seem as if the upper part of the water-spout did not belong to the lower. Should the oblique whirlwind raise itself and approach the perpendicular line, it will appear as if the upper and under portions were approaching each other. We have examples in which the water-spout has formed oval holes in the earth. This must naturally have happened when the whirlwind deviated from the upright position.

The direction of water-spouts from southwest to northeast, may be ascribed to the circumstance of this wind preceding their occurrence.

Water-spouts are often bent; and this must arise from those winds which prevail at various heights above the earth, and which transport the entire masses of air in which the whirlwinds are contained. There is nothing in such a case to prevent one whirlwind continuing to act on the other.

It has been maintained that sharp cannon shots can drive a water-spout asunder. It is by no means inconceivable that balls which strike in such a manner that their direction is the opposite of the circular movement of those portions that they meet, can produce such an effect; but I do not venture to decide if the accounts we possess are sufficient to prove the actual occurrence of such a consequence.

In considering the water-spout, we have endeavored to arrive at its proximate causes from the effects which have been observed and recorded; and we have ascertained that a whirlwind which begins in the higher regions of the air, and becomes expanded as it descends, constitutes the essential element of the phenomenon. It will, however, be further asked, What is the cause of this vortex? We perceive plainly that a whirlwind can be produced by two currents of air following parallel courses, but flowing in opposite directions. There is nothing to prevent us from assuming the existence of such currents in the higher regions of the atmosphere. They must often occur there while the air beneath is perfectly tranquil; at least, during an aerial voyage, a whirling cloud was met with; but we must also admit that we are in possession of no evidence of such air-currents actually existing at the period when a whirlwind is formed. But still, that this is the case seems very probable, when we reflect that they must be of frequent occurrence, and that they are capable of producing the effect we have said might be ascribed to them.

Experience teaches us, that such opposite streams in the higher regions of the air often contend with each other, while profound repose pervades the lower strata. We know also that the opposite currents produced by the inequality of temperature over the land and sea, often extend upwards to a great height, and are there in a state of great commotion, while all is tranquil beneath.

It is evident that opposite and crossing currents of wind are capable of producing also whirlwinds whose axes should run parallel with the earth. These must likewise produce great mixtures of the upper and lower strata of air, and give rise to rain and hail. This seems to correspond very well with our storms; but I am not yet able to say how far we can carry this opinion.*

ART. IX.—*Brief notice of the Extrication of Barium, Strontium and Calcium by exposure of their chlorides to a powerful voltaic circuit in contact with mercury as a "cathode;" and the distillation of the resulting amalgams by means of vessels of iron.*

AGREEABLY to the statements made by Sir Humphrey Davy in his Bakerian lecture, that celebrated chemist was not quite successful in isolating either barium or strontium, as he declares that he was not enabled to expel from them completely the mercury, by amalgamation with which they had been reduced to the metallic state from that of oxide. In the most successful experiments made by him, for the isolation of calcium, the tube broke, and the mass took fire before the distillation was accomplished.

Dr. Hare has recently obtained by an improved process all three of the metals above mentioned. In this, saturated solutions of the chlorides, are substituted for moistened oxides; the mercury and the solutions being both refrigerated by ice-water, or a freezing mixture within receptacles contrived for the purpose. Two deflagrators each comprising one hundred Cruikshank pairs, severally exposing one hundred inches of zinc surface were employed alternately. In consequence of this mode of operating, the charge of acid, at first feeble, was gradually strengthened by additions so as to render the reaction towards the close as forcible as at the commencement. This is highly important, since the difficulty of decomposing the chloride increases with the quantity of calcium combined with the mercury.

The resulting amalgams were severally subjected to distillation by means of a crucible enclosed in an air-tight iron alembic being protected from the access of air by caoutchouehine naphtha, mercury and desiccated hydrogen. For the complete expulsion

* From "*Schumacher's Jahrbuch für 1833.*"

of the mercury a heat above the softening point of glass was necessary.

So great was the avidity for oxygen of the metals thus obtained, that to see their bright metallic white color, the eye must follow closely after the movements of a file or burnisher employed to expose a fresh surface. Metallic whiteness is soon succeeded by a straw color, as in the case of steel filed at a high temperature. But the whole mass is soon reduced to the state of a pulverulent oxide. Of this the color is dark, in consequence of a resinous coating resulting from reaction of the metal with the naphtha necessarily employed to prevent the excess of atmospheric oxygen. In consequence of this coating being insoluble in water, but readily soluble in hydric-ether, oxidizement ensues more readily in the last mentioned liquid than in water.

The metals in question were all brittle, and much harder than potassium or sodium. By the evolution of the mercury, they are left in a form resembling, in some degree, that of metallic arsenic.

Davy informs us that he employed only fifty or sixty grains of mercury. Dr. Hare has employed a half a pound avoirdupois, which is seventy times as great, and is under the impression that with sixty grains it would not be possible to isolate a perceptible quantity of calcium. Operating with much larger quantities of amalgam, he has found no residue besides a stain upon the glass of the tube employed to distill off the mercury.

ART. X.—Process for a Fulminating Powder—for the Evolution of Calcium and Galvanic Ignition of Gunpowder; by Dr. HARE.

AN equivalent of quick lime, with an equivalent and a half of bycyanide of Mercury, is subjected to a red heat in a porcelain crucible enclosed within an air tight alembick of iron so as completely to exclude atmospheric air. The resulting residual mass was found in two experiments, to have the weight which would correspond with an equivalent of calcium, united to an equivalent of Cyanogen. From the filtered solution of the compound, thus produced, in acetic acid, a precipitate was obtained by the addition of nitrate of the protoxide of mercury. This precipitate when well dried was found to constitute a powder capable of fulminating by percussion.

Isolation of calcium by the deflagration in a receiver of desiccated hydrogen, of the compound formed by igniting in a close vessel, bityanide of mercury with pure quick lime.

By exposing the compound of cyanogen with calcium, obtained as above mentioned, either in vacuo or in an atmosphere of desiccated hydrogen to a current from two hundred pairs of Cruikshank plates, each comprising 100 square inches of zinc surface, the calcium appeared to be isolated. Particles displaying metallic characteristics under the burnisher, and which effervesced in water, were observed, while the gas escaping had an odor resembling that of silicuretted hydrogen evolved by silicuret of potassium under like circumstances.

Deflagration of phosphuret of calcium.—By exposure of the phosphuret of calcium to the current from the deflagrators, as above described, calcium containing a trace of phosphorus appeared to remain. The phosphorus was condensed upon the receiver in sufficient quantity to obscure the glass. The residual mass thrown into water effervesced extricating hydrogen slightly phosphoric in its odor. When compounds of carbon with calcium were similarly exposed, the residue had a metallic appearance, but did not decompose water.

On one occasion a portion of the charcoal forming the anode was fused into a globule, having the consistency and other characteristics of plumbago. It appeared more compact than the globules obtained by us many years since of which a portion was forwarded to Dr. Hare at the time.

Of Prof. Daniell's adoption of Dr. Hare's method of igniting gunpowder by galvanic ignition.

During the summer of 1831, a method of igniting gunpowder by galvanism was contrived by Dr. Hare, the idea having been suggested by the abortive efforts of an ingenious individual of the name of Shaw, to effect this object by mechanical electricity. Of the apparatus described for the purpose in question by Dr. Hare, engravings and descriptions were published in this Journal in the Autumn of 1833. We advert to these facts now, in consequence of the recent publication of analogous experiments by Prof. Daniell of Kings' College, who in this case, as well as in that of his "re-invention" of a hydro-oxygen blowpipe of Dr. Hare, was no doubt ignorant that he had been anticipated.

In performing his experiments, it would seem that Prof. Daniell used his ingenious apparatus, known as the sustaining battery, which, although peculiarly qualified for the production of a durable current, is, as we think, far less competent than the calorimeter of Dr. Hare, to produce a transient intense ignition such as would be the most efficacious in igniting gunpowder.

ART. XI.—*On the Boracic Acid Lagoons of Tuscany; by*
 JOHN BOWRING, LL. D.*

THE borax lagoons of Tuscany are entitled to a detailed description. They are unique in Europe, if not in the world; and their produce is become an article of equal importance to Great Britain as an import, and to Tuscany as an export. They are spread over a surface of about 30 miles, and exhibit from the distance columns of vapor, more or less according to the season of the year and state of the weather, which rise in large volumes among the recesses of the mountains.

As you approach the lagoons, the earth seems to pour out boiling water as if from volcanos of various sizes, in a variety of soil, but principally of chalk and sand. The heat in the immediate adjacency is intolerable, and you are drenched by the vapor, which impregnates the atmosphere with a strong and somewhat sulphurous smell. The whole scene is one of terrible violence and confusion—the noisy outbreak of the boiling element—the rugged and agitated surface—the volumes of vapor—the impregnated atmosphere—the rush of waters—among bleak and solitary mountains.

The ground, which burns and shakes beneath your feet, is covered with beautiful crystallizations of sulphur and other minerals. Its character beneath the surface at Mount Cerbole is that of a black marl streaked with chalk, giving it, at a short distance, the appearance of variegated marble.

Formerly the place was regarded by the peasants as the entrance of hell, a superstition derived no doubt from very ancient times, for the principal of the lagoons and the neighboring vol-

* From Dr. Bowring's Report on the Statistics of Tuscany.

cano still bear the name of Monte Cerboli (*Mons Cerberi*). The peasantry never passed by the spot without terror, counting their beads, and praying for the protection of the Virgin.

The borax lagoons have been brought into their present profitable action within a very few years. Scattered over an extensive district, they are become the property of an active individual, M. Larderel, to whom they are a source of wealth, more valuable perhaps, and certainly less capricious, than any mine of silver that Mexico or Peru possesses. The process of manufacture is simple, and is effected by those instruments which the localities themselves present. The soffioni, or vapors, break forth violently in different parts of the mountain recesses. They only produce boracic acid when they burst with a fierce explosion. In these spots artificial lagoons are formed by the introduction of the mountain streams. The hot vapor keeps the water perpetually in ebullition; and after it has received its impregnation during twenty four hours at the most elevated lagoon, the contents are allowed to descend to the second lagoon, where a second impregnation takes place, and then to the third, and so forth, till it reaches the lowest receptacle; and having thus passed through from six to eight lagoons, it has gathered one half per cent. of the boracic acid. It is then transferred to the reservoirs, from whence, after a few hours rest, it is conveyed to the evaporating pans, where the hot vapor concentrates the strength of the acid by passing under shallow leaden vessels from the boiling fountains above, which is quite at a heat of 80° of Reaumur,* and is discharged at a heat of 60° † There are from ten to twenty pans, in each of which the concentration becomes greater at every descent till it passes to the crystallizing vessels, from whence it is carried to the drying rooms, where, after two or three hours, it becomes ready to be packed for exportation.

The number of establishments is nine.‡ The whole amount produced varies from 7000 to 8000 pounds (of 12 ounces) per day. The produce does not appear susceptible of much extension, as the whole of the water is turned to account; the atmosphere has, however, some influence on the result. In bright and

* The boiling point.

† 167° of Fahrenheit.

‡ The principal are Monte Cerboli, Monte Rotondo, Susso, Serazzono and Castelnuovo.

clear weather, whether in winter or summer, the vapors are less dense, but the depositions of boracic acid in the lagoons are infallible barometers to the neighborhood, even at a great distance, serving to regulate the proceedings of the peasantry in their agricultural pursuits.

It had been long supposed that the boracic acid was not to be found in the vapors of the lagoons; and when it is seen how small the proportion of acid must originally be, it will not be wondered at that its presence should have escaped attention. In the lowest of the lagoons, after five, six, and in some cases a greater number of impregnations, the quantity of boracic acid given out does not exceed one half per cent.; thus if the produce be estimated at 7500 pounds per day, the quantity of saturated water daily discharged is a million and a half of Tuscan pounds, or five hundred tons English.

The lagoons are ordinarily excavated by the mountaineers of Lombardy, who emigrate into Tuscany during the winter season, when their native Apennines are covered with snow. They gain about one Tuscan lira per day. But the works are conducted, when in operation, by natives, all of whom are married, and who occupy houses attached to the evaporating pans. They wear a common uniform, and their health is generally good.

A great improvement in the cultivation, and a great increase in the value of the neighboring soil, has naturally followed the introduction of the manufacture of the boracic acid. A rise of wages has accompanied the new demand for labor; much land has been brought into cultivation by new directions given to the streams of smaller rivers. Before the boracic lakes were turned to profitable account, their fetid smell, their frightful appearance, agitating the earth around them by the ceaseless explosions of boiling water, and not less the terrors with which superstition invested them,* made the lagoons themselves to be regarded as

* So unwilling were the peasants to settle in these districts, that very extraordinary encouragements were held out to them. In the commune of Monte Cerboli, any inhabitant of the town may sow and reap whatever he pleases without requiring the consent of the owner of the soil; so it frequently happens that small tracts are cultivated which are particularly favored by water or other advantages, and all the surrounding land left untouched. As the inhabitants have the primary right, the landlord generally abandons his property to the chance cultivation of

public nuisances, and gave to the surrounding country a character which alienated all attempts at improvement.

Nor were the lagoons without real and positive dangers, for the loss of life was certain where man or beast had the misfortune to fall into any of those boiling baths. Cases frequently occurred in which cattle perished; and one chemist, of considerable eminence, met with a horrible death by being precipitated into one of the lagoons. Legs were not unfrequently lost by a false step into the smaller pits (*putizze*), where, before the foot could be withdrawn, the flesh would be separated from the bone.

That these lagoons, now a source of immense revenue, should have remained for ages unproductive; that they should have been so frequently visited by scientific men, to none of whom (for ages at least) did the thought occur that they contained in them mines of wealth, is a curious phenomenon; nor is it less remarkable, that it was left for a man, whose name and occupation are wholly disassociated from science, to convert these fugitive vapors into substantial wealth.

Though to the present proprietor (the Chevalier Larderel*) the merit attaches of having given to the boracic lagoons the immense importance they now possess, a succession of adventurers had made many experiments, and had produced a considerable quantity of boracic acid, but at a cost (from the expenditure of combustible) which left but little profit.† The small value that was attached to them may be seen in the fact, that the largest and most productive district of the lagoons, that of Monte Cerboli, was offered in perpetuity, so lately as 1818, at an annual ground-rent of £T. 200*l.* or 6*l.* 13*s.* 4*d.* per annum, though it now pro-

the peasant, who leaves fallow nine-tenths of the land. In the district of Riparbella the landlords and cultivators have come to a sensible agreement, by apportioning the lands in equal moieties.

Many mineral waters are in the neighborhood of the lagoons, some of which possess medical virtues, and are visited by the Tuscans in the bathing season.

* While these sheets have been passing through the press the Grand Duke of Tuscany has conferred on M. Larderel the title of Count de Pomerance.

† Hoefler first announced the presence of boracic acid in the Maremman districts, and Mascagni in his Commentaries suggests the manufacture of borax as an object worthy of attention. Professor Gazzeri in 1807, made experiments, which however seemed to show that the quantity of boracic acid contained in the waters was too small to promise much success.

duces several thousand pounds sterling. The immense increase in their value arose from the simplest of improvements, the abandonment of the use of charcoal, and the application of the heat of the lagoons or soffioni to the evaporation of their own waters. Improvements, however, and very important ones, particularly by subjecting the waters to a succession of impregnations, had been gradually introduced by a Signor Ciaschi, and the importation of boracic acid from Tuscany into France, before 1817, had been between 7000 and 8000 pounds, of a quality gradually increasing in purity: but Ciaschi perished miserably, in consequence of falling into one of the lagoons which he himself had excavated, leaving his family in a state of extreme poverty. His death (which happened in 1816) naturally threw a damp upon adventure. The experiments were resumed in the following year, and in the midst of violent claims and controversies, M. Larderel has become the monopolist of the boracic productions of Tuscany.

With the increased productions of boracic acid has arisen an increased demand, growing out of the more extensive application of it to manufacturing purposes. In about four years the quantity has been quadrupled by superior modes of extraction, and by greater care employed in the collection of the boracic vapor. In 1833 about 650,000 Tuscan pounds were obtained, in 1836 two millions and a half.

But it appears to me that the powers and riches of these extraordinary districts remain yet to be fully developed. They exhibit an immense number of mighty steam-engines, furnished by nature at no cost, and applicable to the production of an infinite variety of objects. In the progress of time this vast machinery of heat and force will probably become the moving central point of extensive manufacturing establishments. The steam, which has been so ingeniously applied to the concentration and evaporation of the boracic acid, will probably hereafter, instead of wasting itself in the air, be employed to move huge engines, which will be directed to the infinite variety of production which engages the attention of laboring and intelligent artisans; and thus, in the course of time, there can be little doubt, that these lagoons, which were fled from as objects of danger and terror by uninstructed man, will gather round them a large intelligent population, and become sources of prosperity to innumerable individuals through countless generations.

ART. XII.—*Magneto-Electric Multiplier*; by CHARLES G. PAGE,
M. D. Washington City, D. C.

IN Vol. xxxiv, No. 2, of this Journal, a new instrument was described to which I gave the name of Magneto-Electric Multiplier, from its affording a method of increasing the ordinary magneto-electric power of an electro-magnet. The instrument here represented (Fig. 1,) was invented about the same time with the former,

Fig. 1.

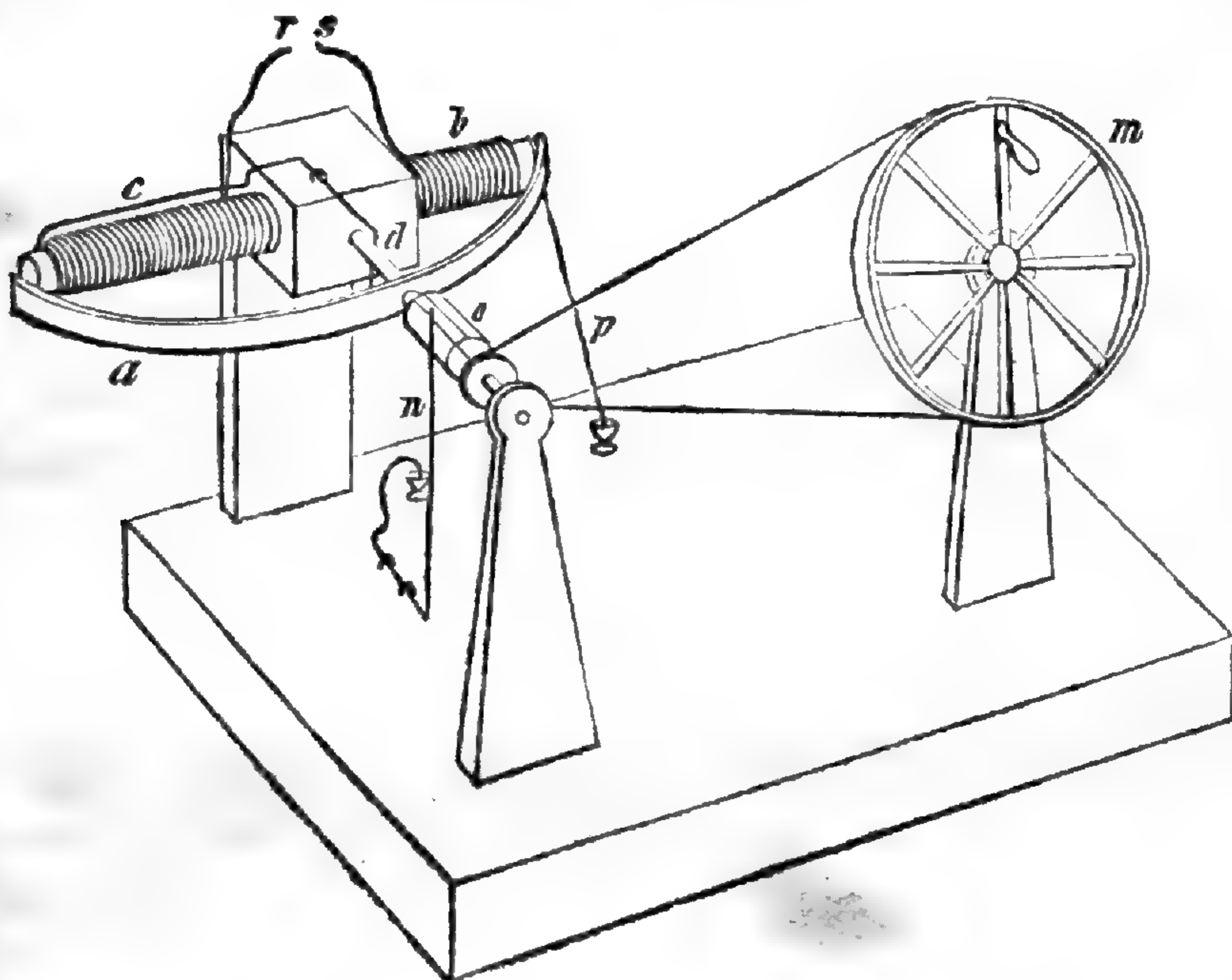

and is much its superior for magnetic electrical experiments, but it does not answer so well for the exhibition of independent rotations. The only difference in the construction of the two machines, is in the form of the magnets. The U form magnet of the first machine, is better adapted for the display of magnetic power, but does not afford so delicate a test of weak magnetic electrical currents as the straight magnet, as the hardness and irregular texture of the iron at the bend of the U form magnet, and the proximity of its poles, tend to retard the neutralization of magnetic forces, and consequently to diminish the magneto-electric current.* The magnet *bc*, is about six inches in length, and half an inch in diameter before it is covered. For machines of this description, the magnet should not much exceed this in length

* For a full explanation of the action of this instrument, the reader is referred to Vol. xxxiv, No. 2.

or diameter; for if longer, the armature will be unnecessarily long and retain a considerable degree of magnetism, which would be equivalent in the result to the retention of magnetism by the magnet itself; and if the diameter be increased, it will be disproportionate to the length. The magnet *bc*, is compound, and made of the best annealed soft iron wire, No. 18. It is covered with four superficial helices of No. 16 copper wire, and exterior to this, about four hundred feet of fine copper wire. The armature *a* is slightly curved, and its extremities are made to pass very near the poles of the magnet. At *a*, upon the revolving shaft, is placed the electrotome, made of copper or silver, into which are fitted segments of wood or ivory to intercept the galvanic current at proper intervals; *p*, *n*, are the cups to receive the wires completing battery connexion. The wire, *n*, rests with a slight spring upon the electrotome; *p*, is one termination of the large wires of the magnet. The other magnet wire, *c*, springs against the shaft at *d*, so as to be in metallic communication with *o* and *n*; *r*, *s*, are the fine wire terminations from which the shocks are received; they may at pleasure be inserted in mercury cups screwed to the top of the pillar. The cups are convenient in certain experiments, but if the wires are left as in the figure, when the machine is in action, a beautiful purple light plays between their quivering extremities, provided they previously touch; *m*, is the multiplying wheel, with its band running upon a small pulley on the shaft. The electrotome, *o*, is set upon the shaft so that its metallic portions shall separate from the wire spring, *n*, immediately after the extremities of the armature, *a*, have passed the poles of the magnet. The electrotome may also be so adjusted, that the armature will revolve of itself when a large battery is applied. The most interesting and important application of this instrument is to obtain a spark and shock from a single thermo-electric pair. A common pair of bismuth and antimony plates, heated and cooled, are connected with the cups *n*, *p*, and as the wheel is turned, a shock is felt as far as the wrist and sometimes to the elbow, by touching *r*, *s*, with wetted metallic handles. The spark is seen at *o*, upon the electrotome. When the shock is desired, the electrotome is oiled; when the spark is to be observed, the electrotome is to be cleaned, and if of copper, rubbed with some fine amalgam. The sparks and shocks occur at each separation of the armature and magnet.

Washington, July 23d, 1839.

ART. XIII.—*Method of adjusting the Dipping Needle*; by THOMAS H. PERRY, Professor of Mathematics United States Navy.

TO THE EDITORS.

Gentlemen,—Finding it necessary, some months since, to re-adjust a needle belonging to my instrument for measuring the magnetic dip,—I adopted a method which, from its simplicity, I am induced to communicate, in the hope that it may be serviceable to others in similar circumstances.

The instrument being firmly fixed, and accurately leveled, the direction of the magnetic parallel of latitude, and meridian, and the true dip, were approximately ascertained by properly reversing its faces, axis, and poles. The plane of its face was then made to coincide with the parallel of magnetic latitude, and the substance of the needle carefully ground away, *from the sides perpendicular* to its plane of motion, until it assumed the same position (the vertical) upon reversing its axis. The plane of the face was then brought into the magnetic meridian, and the needle again ground upon the sides parallel to the plane of motion so as not to affect the previous adjustment much, until it indicated nearly the true dip. These processes were successively repeated, until the errors, saving such as result from the imperfection of the circles, were found, upon making all possible reversions, to be less than the probable errors of observation.

This method may be advantageously employed in the final adjustment of new needles. I have employed it successfully in one instance. Two small screws at right angles with each other, might also be added, which would render grinding unnecessary; but their weight would prove some incumbrance, and they would increase the liability of the adjustments to derangement.

The value of the process results from the difficulty of rendering manufactured and tempered steel devoid of magnetism. Its correctness of principle is obvious from the impossibility of correct indications in two different positions of the needle, except when the centre of gravity coinciding with the axis of motion, the influence of this force becomes nothing in all cases.

In making these adjustments, it is better that the magnetism be of feeble intensity, provided that it be sufficient to overcome

inertia and friction, as, in this case, the influence of any other force is more obvious. Any two different planes or even the same might be employed by a little modification of the process, but those specified are most eligible, as in them the forces affecting the position of the needle present the greatest disparity.

U. S. Ship Independence, Jan. 28, 1839.

ART. XIV.—*Results of Experiments on the Vibrations of Pendulums, with different suspending springs; being the substance of a paper by W. J. FRODSHAM, F. R. S., read before the Royal Society, June 21, 1838. Forwarded for insertion in this Journal.*

THE experiments of which I am about to give an account, and from which I propose to draw some practical conclusions, were undertaken with a view to determine whether some particular condition of the suspending spring of the pendulum, with respect either to its length, its strength, or both, might not cause it, with a lighter maintaining power, to produce a given arc of vibration, or, with a given maintaining power, to produce a greater arc of vibration than any other; and at the same time to ascertain whether some practical means might not be devised for making unequal arcs of vibration in the ordinary pendulum, correspond to equal intervals of time.

My attention was drawn to the subject many years ago, when, having replaced the spring of a turret-clock by a stronger one, I found the arc of vibration materially altered.

Having often reflected upon the subject, I at length resolved to make some experiments to satisfy my mind respecting it; and I accordingly had made for the purpose a lenticular pendulum bob of about fourteen pounds weight, a cylindrical rod passing through it, with a nut working on a screw at the lower end, and supporting the bob.

The upper end of the rod was slit to receive the spring; and the spring and the rod were attached to each other by a pin passing through a hole in both.

But before fixing the pin, what I call an *isochronal piece* was slid over the top of the rod, and if this part of the apparatus had served only to attach the rod and spring more firmly together, and prevent any wavering motion of the pendulum, it would have rendered

an important service. This, however, was but a secondary and incidental effect of its application.

The piece, which I have so named, is a brass tube about five inches long, fitting the pendulum rod very nicely, and slit to form a spring for about an inch at the bottom, so as to slide rather stiffly on the rod. At the upper end of the tube is a *clip*, which is made to embrace the suspending spring firmly by means of two screws; so that after the pendulum has been brought to the proper length by the adjusting nut at the lower end of the rod, the length of the acting part of the suspending spring may be varied at pleasure, without in the least altering the length of the pendulum, by merely sliding the isochronal piece up or down the rod, and tightening the screws of the *clip*.

I also provided five springs of different degrees of strength, and a silken string, by which, in the first experiments, the pendulum was suspended.

The pendulum used was an uncompensated one, but in each experiment it was adjusted to nearly the proper length for mean time.

Commencing with the silken thread, or rather two parallel threads, one behind the other, I suspended the pendulum within the case of a clock, perfectly detached from the works, no maintaining power being applied.

Each degree of the scale on which the arcs of vibration were noted, was nearly $\cdot 8$ of an inch in length, and a degree was subdivided into twenty equal parts.

I drew the bob aside 2° , and leaving it to vibrate by its own gravity, I found the arc of vibration was reduced from 2° to 1° , and from 1° to $\frac{1}{2}^\circ$, in the times noted as under:—

Arc of vibration from 2° to 1°	in 20m. 15s.
Do. do. 1 to $\frac{1}{2}$	23 6

On repeating the experiment, the results were:—

Arc of vibration from 2° to 1°	in 21m. 0s.
Do. do. 1 to $\frac{1}{2}$	24m. 0s.

Drawing the pendulum aside 1° , I found from five successive trials that the arc of vibration was reduced to half a degree in the times following:—

From 1° to $\frac{1}{2}^\circ$ in 21m. 45s.

Do. do. 22 45

Do. do. 22 0

Do. do. 22 30

Do. do. 23 0

Mean, - - - 22 24

The mean of the two preceding corresponding results is 23m. 12s. The difference may be satisfactorily accounted for, by the difficulty of setting off the pendulum at the precise point intended, and of noting the time when the arc is diminished to the proposed quantity.

It is apparent from these experiments, that when a pendulum is freely suspended, and left to vibrate from its own gravity, the arc of vibration is sooner reduced from 2° to 1° , than from 1° to $\frac{1}{2}^\circ$, as might indeed be anticipated from the increased resistance experienced by the bob, while moving through a greater space in the same time.

I attached the pendulum, suspended as before, to a clock, with a maintaining power of 6lb. 8oz., but the clock stopped in 39 minutes; and setting it off again, it stopped in 43 minutes; but on applying a weight of 6lb. 11oz., the clock continued to go; thus showing that a weight of 6lb. 11oz. was sufficient to keep the pendulum in vibration, while one only 3oz. lighter was not.

The arcs of vibration in the preceding experiments being smaller than is desirable in practice, I proceeded to experiment with heavier weights, the pendulum being still suspended by the parallel silk threads, noting in each case the arc of vibration and the *rate* of the clock, viz., its gain or loss in 24 hours.

In the following experiments each succeeding pair is to be considered as giving the results for two consecutive days, though more than one day occasionally elapsed between the times at which the sets were taken.

Weight.		Arc of Vibration.		Rate.	
14lb.	6oz.	2°	3'	-	9s. .0 } + 0 .7 }
8	0	1	30		
14	6	2	3	-	10 .0 } 0 .0 }
8	0	1	30		
11	2 1	1	45	-	7 .0 } + 1 .0 }
8	0	1	30		
= 19	0	2	15	-	13 .0 }

It hence appears, that when a pendulum is suspended by a flexible string, a heavier weight and a consequent greater arc of vibration, causes the clock to lose.

The following are the dimensions of the springs which were experimented with:—

Number.	Breadth.	Thickness.
1	·350 inch	·001 inch.
2	·390	·002
3	·395	·003
4	·395	·004
5	·400	·005

The pendulum being suspended by the weakest spring, No. 1, the times were noted as before, in which the arcs of vibration were reduced from 2° to 1°, and from 1° to ½°, no maintaining power being applied.

Arc reduced from 2° to 1° in 1h. 58m.
Do. do. 1 57
Do. 1 to ½ 2 8
Do. do. ½ 2 10

With the same spring, and a maintaining power of 4lb. 1oz. and 2lb. 2oz., the following arcs of vibration and rate of the clock resulted from two consecutive days, the effective length of the spring being ·92 inches.

Weight.	Arc.	Rate.
4lb. 1oz.	2° 3'	— 9s. ·6
2 2	1 30	— 6 ·1

The pendulum being suspended with spring No. 2, and clipped at ·92 inch, without maintaining power, the arcs of vibration were reduced as follows:—

From 2° to 1° in 2h. 20m. 0s.
Do. 2 — 1 — 2 20 44
Do. 1 — ½ — 2 26 0
Do. 1 — ½ — 2 26 0

Applying 4lb. 1oz. and 2lb. 2oz. in succession, as a maintaining power, I found as under:—

Weight.	Arc.	Rate.
4lb. 1oz.	2° 9'	— 0s. ·2 } + 2 ·5 }
2 2	1 36	

With spring No. 3, and effective length $\cdot 92$ inch, the following results were obtained on two consecutive days:—

Weight.	Arc.	Rate.
4lb. 1oz.	$2^{\circ} 15'$	—2s. $\cdot 5$
2 2	1 39	—2 $\cdot 8$

Reducing the effective length of the spring to $\cdot 80$ inch, the following results were obtained on consecutive days:—

Weight.	Arc.	Rate.
4lb. 1oz.	$2^{\circ} 9'$	0s. $\cdot 0$ } 0. 0 }
2 2	1 30	—0 $\cdot 5$ } —0 $\cdot 2$ } —0 $\cdot 2$ }
4 1	2 9	
2 2	1 30	
4 1	2 9	

Hence, with either of these lengths of this spring, the rate does not appear to be perceptibly influenced by the extent of the arcs of vibration. In fact, the vibrations of the pendulum may, for all practical purposes, be considered as isochronous.

The effective length of the spring was then increased to $\cdot 92$ inch, and the following results were noted, without maintaining power:—

Arc reduced from 2° to 1° in 2h. 26m.	0s.
Do. do.	2 1 2 25 45
Do. do.	1 $\frac{1}{2}$ 2 37 0
Do. do.	1 0 2 36 40

On three other occasions, with the same spring, and effective length, $\cdot 92$ inch, the following comparative results were obtained:—

Weight.	Arc.	Rate.
4lb. 1oz.	$2^{\circ} 15'$	—4s. $\cdot 0$ } —4 $\cdot 2$ } —5 $\cdot 0$ } —5 $\cdot 2$ } —5 $\cdot 0$ } —5 $\cdot 0$ }
2 2	1 39	
4 1	2 15	
2 2	1 39	
4 1	2 15	
4 1	2 15	

Showing that even with different lengths of this spring, the vibration may be considered as isochronous, with considerably different arcs of vibration; and also that with this spring, a greater arc of vibration is produced with the same maintaining power, than with any other spring that has been tried.

Spring No. 4 was next applied without maintaining power.

With it the arc of vibration was from

2°	to	1°	in	1h.	47m.
do.				1	48
do.				1	50
1°	to	½°		1	54
do.				1	55
do.				1	58
do.				2	0

Applying maintaining power of 4lb. 1oz. and 2lb. 2oz. respectively, with .97 inch effective length of the following results were noted :—

Weight.	Arc.	Rate.
4lb. 1oz.	2° 6'	—2s. .2
2 2	1 30	+1 .2

Even with this comparatively stiff spring, the arc of vibration is greater with a maintaining power of 4lb. 1oz., than it was with 14lb. 6oz., when the pendulum was suspended by two parallel silk threads. But the rate appears to vary more with the arc of vibration, than it did when No. 3 was used.

Reducing the length of this spring to .66 inch, the following results were obtained :—

Weight.	Arc.	Rate.
4lb. 1oz.	2° 3'	—14s. .1
2 2	1 27	—11 .5

Sliding up the isochronal piece still further, till the length of the effective part of the spring was reduced to .50 inch, the following were the results :

Weight.	Arc.	Rate.
4lb. 1oz.	2° 3'	—18s. .0
2 2	1 12	—14 .5

This further shortning of the spring appears to have had a perceptible effect on the arc of vibration, when the lighter weight was applied.

I lastly attached the strongest spring, No. 5, and with effective length 1.0 inch.

Weight.	Rate.
4lb. 13oz.	—15s. .5
2 10	—13 .5

Reducing the length of this spring to .8, the following results were obtained :

Weight.		Rate.
6lb.	3oz.	— 14s. 6
2	10	— 12 4

Sliding up the isochronal piece still further, till the length of the effective part of the spring was reduced to $\cdot 50$ inch, the following were the results :

Weight.		Rate.
4lb.	13oz.	— 12s. 0
2	10	— 8 2

The lighter weight, 2lb. 2oz. employed on experimenting with the weaker springs, was found insufficient to keep the pendulum in vibration with No. 5; 2lb. 10oz. was found adequate to the purpose, and it was therefore employed.

In experimenting with this spring, the arcs of vibration were not noted, as I found that both it and No. 4 were too strong for the weight of the bob I was using, and to which the experiments indicate that No. 3 was excellently adapted.

The arc of vibration with the spring, No. 3, (viz. $2^{\circ} 15'$) using a weight of 4lb. 1oz., required 19lb. weight to produce it when the pendulum was suspended by the silken threads.

It appears then, from the preceding experiments on suspending springs differing in length and strength, that there is one which, with a given maintaining power, produces a greater arc of vibration than others, and gives the same arc to vibration with a smaller maintaining power; and, further, that with this same spring the vibrations may, in point of time, be all considered as isochronous, whether the arcs are large or small. And with the aid of the *isochronal* piece, a spring of the proper length and thickness may easily be selected in a very few trials.

It may be noticed too, that unless the pendulum is first *isochronized* by some such method as that which has been pointed out, anomalies may be imputed to *imperfect compensation*, which have their origin in a very different source.

In fine, it may be stated in conclusion, that if the pendulums of astronomical clocks were furnished with what I have called an isochronal piece, any person possessing a few springs of different degrees of strength, may with very little difficulty determine what spring is best adapted to the weight of the pendulum, and also what part of the spring may be most advantageously employed in action; and I shall not think that the attention which

I have given to this subject has been misspent, if any thing that I have done may contribute to the advancement of an art to which I have been professionally devoted during the whole of my life.

London, March, 1839.

ART. XV.—*On Coins and Medals, with a notice of the Medal which has been recently struck to commemorate the settlement of New Haven, Connecticut.* Communicated at the request of the editors, by Mr. JOHN ALLAN of New York.

As to the question, at what period of the world the study of coins and medals commenced, or at what precise time they were first fabricated, we are ignorant, although several writers have endeavored to trace their origin to a very remote antiquity. The states of Italy were the first, after the revival of literature and the fine arts, to commence the study and striking of coins and medals; and the modern governments of Europe have all, more or less, followed their example.

Medals have been admired by many of the wisest and best of ancient and modern times; by Pliny, Alfred, Petrarch, Cambden, Selden, and others; for they have beauties inherently their own, which being founded on the immutable principles of human nature, must ever afford delight to the human mind.

Novelty, beauty and sublimity are the three great sources of moral and intellectual pleasure, and the incitements to these are well supplied by medals.

They display the usages of society, and the habits and forms of persons, with whom history having made us acquainted, we long to see the faces on which their minds and characters were impressed. From a similar feeling we are delighted with the exhibition of the battles, edifices, religious rites, costumes, and innumerable other interesting circumstances belonging to the age, or illustrating the characters and actions of eminent individuals.

Hence Greece and Rome, the noblest states in ancient times were most distinguished for their attachment to, and production of coins and medals. A vast number of these have been spared by the destroyer time, to attest the pains and success with which they were executed, thus evincing the high importance attached to them in those ages, not only as commemorating passing

events, but as gratifying the ardent wish of posterity, to look back into remote times, and thus to obtain the most important aids to history.

No adequate conception can be formed by persons who have paid no attention to the subject, how highly subservient medals may be made to the gratification of private taste, to the perpetuation of the memory of objects of personal history, of domestic endearment, and individual honor; to the illustration of the success of well laid plans of public enterprize, to the commemoration of marriages and births, to perpetuating the knowledge of new inventions, and of the memory of men eminent for learning and talent, and for public as well as private virtues.

As medals are the least perishable of all the materials upon which the artist displays his powers, they continue current on the tide of time when the productions of all other arts have sunk into oblivion.

A desire to possess modern as well as ancient medals exists, at present, in the most distinguished academies, and among individuals of all enlightened countries: medals are eagerly sought for public libraries, and museums, and governments employ the mint in striking medals and coins to heighten the splendor of the existing administration and to extend and perpetuate their civil and military renown.

Another source of pleasure and amusement which attends the study of medals, is the finish and beauty displayed in their workmanship, by the designers and engravers.

We have already remarked that the states of Italy were the first after the revival of literature to commence the study and striking of medals.

The papal medals form a magnificent series. Germany possesses many cabinets of coins and medals and many books which have been written on the subject in that country.

Russia and Sweden have each a series of medals in honor of national victories. Holland has a similar series, commemorating her struggles for liberty, and her final emancipation from the Spanish yoke. France has an immense national collection. England, till lately, was behind the continent in her medallic history. Several fine medals were struck by the celebrated Simon, in Cromwell's time; and a very excellent series by Crocker to celebrate the victories of Marlborough, in the reign of Queen Ann.

A series of English sovereigns was engraved and struck by Dassin, a native of Geneva, in the reign of George the first—and recently, an additional series consisting of forty, has been struck to commemorate the national achievements during the late war with France, and the powers on the continent. But many elegant private medals of individuals in Britain have been executed; of men who have been eminent in various walks of life, or who by their talents have added to the discoveries in the sciences, in agriculture, or the mechanical and other arts. For the improvement on the steam engine by Watt, a medal was struck;* but where is the medal in honor of Fulton?—where is that in honor of Whitney?

The most distinguished collection of medals of the present day, is the Napoleon series of one hundred and sixty, commemorating the civil and military actions of that extraordinary man; they were done chiefly from the designs, and under the direction of the celebrated Denon. Most of them are beautiful in design and execution, and unequalled by any of modern times.

Several medals were struck at Paris to commemorate the American revolution. Congress, some years since, made an appropriation to have the whole series placed in the national library at Washington; the vessel that had them in charge (if I recollect right) was lost, and whether any further action has been had, or any progress since made, I am ignorant.

A medal was struck on Commodore Truxton's victory,—and another on the war with Tripoli under Commodore Preble.

Medals also were struck by order of Congress, to carry down to posterity the naval victories of the United States, in the late war with Great Britain. In 1817, a medal was struck to commemorate the union of Lake Erie with the Atlantic, by the great canal.

Since that time, no medals worthy of commemoration have been executed either by individuals, or any of the states or cities of the United States, till lately, New Haven in the state of Connecticut, has taken the lead, and on the return of the second centennial anniversary of the founding of the colony by Eaton and Davenport, has had a medal engraved and struck to commemorate the first settlement of the City. The medal does honor to both the designer and engraver, as well as to those patriotic citizens of New Haven, at whose instance it was done.

* The writer has one.

On the obverse is a view of the place where New Haven now stands, as it was in April, 1638, with the band of pilgrim settlers under a tree, listening to a sermon on the first Sabbath in the wilderness, from the Rev. John Davenport, their spiritual leader, while the aborigines on the opposite bank of the river are looking on; the reverse has a view of New Haven as it is at the present day, or rather a bird's eye view of the public square or green, now in the centre of the town, with the different churches, the state house, colleges, &c. Legend on the top of the obverse, ("Quinnipiack, 1638") the Indian name,—underneath, "The desert shall rejoice."—On the reverse, "and blossom as the rose." "New Haven, 1838." On the exergue, a ship in full sail, a steamboat, railroad cars.

May this patriotic effort of New Haven be imitated by every town and state in the union, and may every college and literary institution possess a cabinet of coins and medals!

Remarks.—An eminent artist has pronounced that this medal is the best hitherto executed in this country. It has been struck both in bronze and in silver. The medal is $2\frac{1}{8}$ inches in diameter; the silver $\frac{1}{8}$ inch thick; the bronze $\frac{3}{16}$ inch thick. The silver medal weighs 1 oz. and seventeen and a half pwts., and sells for six dollars. The bronze 3 oz. and two pwts., and sells for three dollars. The impression of the medal is in high relief, and its most minute lines are exceedingly sharp and well defined. The costume and manner and even the features of the pilgrims are highly characteristic and illustrate the humble beginning of this now large and beautiful town. The numerous objects grouped together to indicate its present prosperity, although on a crowded field, are perfectly distinct; the architecture of the public buildings is so exactly copied that they are instantly recognized by an eye that is familiar with them, and the exuberant foliage of this city of groves, is gracefully displayed among its squares and temples. This medal* was designed by Mr. Hezekiah Augur, the well known sculptor, with the advice of Mr. Ithiel Town, and it was executed in New York, by Mr. John Wright.

* For sale at the bookstore of Young & Ulhorn. For a very interesting account of the rise and progress of the colony, see Prof. Kingsley's excellent historical discourse, and the volume of historical sermons—of deep interest—by the Rev. Leonard Bacon.

ART. XVI.—*Formula for discovering the Weight and Volume in a Mixture of two Bases*; by Dr. JNO. M. B. HARDEN, Riceboro, Liberty County, Geo.

TO THE EDITORS.

IN the 12th volume of the "Philosophical Magazine," there is a paper by Mr. Golding Bird, upon the subject of "indirect chemical analysis," in which he gives two formulæ by Poggen-dorff, for the quantitative estimation of two different bases in mixtures of those bases. These formulæ are sufficiently exact, but probably not as simple or comprehensive as might be desired. He alludes also to one annexed by the French translator to the "Analysis of inorganic bodies," by Berzelius which I do not find in the English translation of that work. As it may be well to multiply methods for the solution of such problems, I send you the following formula, which, although from the well known principles which it involves, I cannot suppose it has any claim to novelty, I have never seen proposed for this object. If you should consider it worthy the notice of the analytic chemist you will please insert it in your highly useful Journal.

In the mixture of two bases it is proposed to find the weight and volume or bulk of each base, by having given the specific gravity of each ingredient together with the specific gravity of the mixture and its weight. Now since the specific gravities of each base or ingredient of the mixture are supposed to be known in most if not all cases, all that is necessary will be to determine by experiments the specific gravity and weight of the mixture, in order to find the quantities desired. Let A = sp. gr. of one ingredient, B = sp. gr. of the other, and C = sp. gr. of mixture. Let also the weight of the mixture = 1, and x and y = the weights of the bases; then it is evident that

$$\frac{x}{A} + \frac{y}{B} = \frac{x+y}{C} = \frac{1}{C} \text{ and } x+y=1.$$

These equations reduced give

$$x = \frac{AC - AB}{AC - BC} \text{ and } y = \frac{AB - BC}{AC - BC}.$$

Multiply these fractions by the number expressing the weight of the mixture, and we have the weight of each base or ingredi-

ent; and as the volumes are inversely as the specific gravities they are found by dividing the weights by the sp. gr. of each.

We give as an example the mixture of oxygen and azote in atmospheric air.

$$x = \frac{1.1111 - 1.1111 \times .9722}{1.1111 - .9722} = \frac{309}{1389} = \text{proportional weight of oxygen.}$$

$$y = \frac{1.1111 \times .9722 - .9722}{1.1111 - .9722} = \frac{1080}{1389} = \text{do. do. of Azote.}$$

Now since 100 cubic inches of air weigh 30.5 grains, it will be found that the *weight* per cent. of oxygen in atmospheric air is 22.23, and of azote 77.77, divide these by the sp. gr. of each, and it will be found that the *volume* per cent. of azote is 79.8 that of oxygen 20.2 nearly, which corresponds exactly with the result of the most rigid and careful experiments.

I need scarcely remark that this formula applies only in cases where the specific gravities are determined by the same standard of comparison, although in every case they may be reduced to the same by an easy mathematical calculation.

Liberty Co., Geo., Aug. 15th, 1839.

ART. XVII.—*Abstract of a Monograph of the Genus Sciurus, with descriptions of several new species and varieties; by J. BACHMAN, D. D., President of the Lit. and Phil. Soc. of Charleston, S. C.**

MANY of the species of this very widely diffused genus are, through the influence of climate and other alterative causes, subject to remarkable variations, which have proved a fruitful source of error in characterizing the specific forms of such as inhabit the Old World.

From the vastness of the territory over which they are dispersed, still greater difficulties have presented themselves in describing and separating the species of *Sciuri* peculiar to our own continent. Their anatomy and habits through the whole genus, present striking similarities, while on the other hand differences nearly as remarkable both in size, color and habit, are observable

* Abridged from *Mag. of Nat. Hist.* for March, 1839, et seq.

among varieties of the same species. From such causes of uncertainty, and the too slight attention which American naturalists have hitherto given to their elucidation, all our existing monographs remain all more or less erroneous.

The task of correcting these deficiencies, and adding to our former knowledge of the genus, has not been undertaken by me without due caution. Many hundred specimens from various parts of North America have been carefully examined and compared. I have been enabled to procure specimens of all the species with but one exception, (*S. macrourus*, Say) and this latter I had also an opportunity of examining in the collection of the Philadelphia Museum.

Many species, no doubt, remain as yet undiscovered. Louisiana, with the countries bordering upon Texas and Mexico, may hereafter reward the quest of naturalists with many new and interesting forms.

Order RODENTIA.

GENUS *Sciurus*, Linn., Cuvier, etc.

Dental formula—Incis. $\frac{2}{2}$ Can. $\frac{0}{0}$ Gr. $\frac{4}{4}$ or $\frac{5}{4}$ —20 or 22.

SPECIES—*Capistratus*. FOX SQUIRREL.

S. capistratus; Bosc, 'Ann. du Museum,' v. i. p. 281.

S. vulpinus? Linn. Ed. Gmelini, 1788.

S. niger; Catesby.

Black squirrel; Bartram's Travels.

S. capistratus; Desm. Mammalogie, p. 332.

S. variegatus; Desm. idem, p. 333.

S. capistratus; C. 'Regne An.' v. i. p. 193.

Fox squirrel; Lawson's Carolina, p. 124.

S. vulpinus; Godman.

ESSENT. CHAR. *Size large; tail longer than the body; hair coarse; ears and nose white; subject to great varieties in color.*

Dental formula. In. $\frac{2}{2}$. Can. $\frac{0}{0}$. Grind. $\frac{4}{4}$.—20.

General description. Forehead slightly arched; whiskers black, longer than the head; hair very coarse, appearing in some specimens geniculate; tail broad and distichous; body strong and heavy. *Var. griseus*, nose, ears, feet and belly white; fore-

head and cheeks brownish black ; hairs of the back, plumbeous at the roots, then cinereous, then black, with white lips ; hairs of the tail white with a ring of black three fourths of the way from roots. General hue light grey, with occasional black hairs interspersed mostly on the neck and shoulders. This is the variety called by Bosc, *S. capistratus*.

Var. *niger*. (*S. niger*. Cates. and Bartram.) Nose and ears white, with a few light colored hairs on the feet. Body and tail black.

Var. *griseo-nigricans*. Nose, mouth, under-jaw and ears white ; head, thighs, and beneath, black. Desm. Encyc. Method. Mam. 333. A fourth variety is common in Alabama ; sometimes also seen in South Carolina. Of this, the head and neck are black ; the ears and nose white ; back, dark rusty brown ; neck, thighs, and beneath, bright ferruginous ; tail annulated with black and red. The color of the young does not always correspond with that of the parent of the same sex. Thus the male parent of a black color, may produce young of the same sex which are grey. and *vice versa*.

Dimensions of the Fox Squirrel.

	In.	Lines.
Length of head and body, - - - -	14	5
“ of tail, (vertebræ,) - - - -	12	4
“ of palm, and middle fore claw, - -	1	9
“ of sole and middle hind claw, - -	2	11
“ of fur on back, - - - -	“	8
Height of ear posteriorly, - - - -	“	7

Geographical distribution and habits.—Exists sparingly in New Jersey ; not observable in the mountainous districts of Virginia. In the pine forests of the Carolinas, it is a common inhabitant. Found also in Florida and Alabama. The fox squirrel prefers high and thinly wooded pine ridges, and frequently resorts to the vicinities of rich valleys for the nuts, acorns, and chinkapins, *Castanea pumila*, which such soils produce. The nest is commonly a hollow oak, through the thin decayed trunk of which it either gnaws with its teeth a sufficient cavity, or occupies the deserted hole of the ivory-billed woodpecker. (*Picus. principalis*.)

“ The summer duck too is frequently a competitor for the same residence ; contests for possession occasionally take place between these three species, and I have generally observed, that the tenant that

has already deposited its eggs or young in such situations is seldom ejected. The male and female summer duck unite in chasing and beating with their wings any squirrel that may approach their nests, nor are they idle with their bills and tongues, but continue biting, hissing, and flapping their wings until the intruder is expelled. On the other hand, when the squirrel has its young in the hole of a tree, and is intruded on either by a woodpecker or a summer duck, it immediately rushes to its hole, and after having entered, remains at the mouth of it, occasionally protruding its head, and with a low and angry bark keeps possession until the intruder, weary of the contest, leaves it unmolested. Thus, nature imparts to each species additional spirit and vigor in defence of its young; whilst at the same time the intruder on the possession of others, as if conscious of the injustice of his acts, evinces a spirit of pusillanimity and cowardice.

“In the vicinity of this permanent residence of the fox squirrel, several nests, composed of sticks, leaves and mosses, are usually seen on the pine trees. These are seldom placed on the summits, but in the fork of a tree, and more frequently where several branches unite to afford a sure resting-place to these nests. This may be called their summer home, for it seems to be occupied only in fine weather, and is deserted during wintry and stormy seasons.”

The breeding season is in December and January, and the young are frequently produced as early as the first of March. The nests containing young, as often as I have observed them, were always found in the hollow of decayed trees. They appear to bring forth young but once during the year.

“The food of this species is various; besides acorns and the different kinds of nuts, its principal subsistence for many weeks in autumn is on the fruit extracted from the cones of the pine, especially that of our long-leaved pitch pine (*Pinus palustris*.) Whilst the green corn is yet in its milky state, the fox squirrel makes long journeys to visit the fields, and for the sake of convenience frequently builds a temporary summer-house in the vicinity, in order to share with the little Carolina squirrel and the crow a portion of the delicacies and treasures of the husbandman; where he is also exposed to the risks incurred by the thief and plunderer; for these fields are usually guarded by a gunner, and in this way thousands of squirrels are destroyed during the green corn season. It is doubtful whether the fox squirrel lays up any winter stores. There appears to be no food in any of his nests, nor does he, like the red squirrel (*Sciurus Hudsonius*) resort to any hoards which, in the season of abundance, were buried in the earth or concealed under logs and leaves. During this season he leaves his retreat but seldom, and then only for a short

time, and in fine weather in the middle of the day. He has evidently the power, like the marmot and racoon, of being sustained for a considerable length of time, without much suffering, in the absence of food. When this animal makes his appearance in the winter, he is seen searching among the leaves where the wild turkey has been busy at work, and gleaning the refuse acorns which have escaped his search; at such times also this species does not reject worms and insects which he may detect beneath the bark of fallen or decayed trees. Towards spring he feeds on the buds of the hickory, oak, and various other trees, as well as on several kinds of roots, especially of the wild potato. As the spring advances farther, he is a constant visitor to the black mulberry tree (*Morus rubra*) where he finds a supply for several weeks. From this time till winter the fruits of the field and forests enable him to revel in abundance.

“Most other species of this genus when alarmed in the woods immediately betake themselves to the first convenient tree that presents itself,—not so with the fox squirrel. When he is aware of being discovered whilst on the ground, he pushes directly for a hollow tree, which is often a quarter of a mile distant, and it requires a good dog, a man on horseback, or a very swift runner, to induce him to alter his course, or compel him to ascend any other tree. When he is silently seated on a tree, and imagines himself unperceived by the person approaching him, he suddenly spreads himself flatly on the limb, and gently moving to the opposite side, often by this stratagem escapes detection. When however he is on a small tree, and is made aware of being observed, he utters a few querulous, barking notes, and immediately leaps to the ground and hastens to a more secure retreat. If overtaken by a dog he defends himself with great spirit, and is often an overmatch for the small terriers which are used for the purpose of treeing him. He is very tenacious of life, and an ordinary shot gun, although it may wound him repeatedly, will seldom bring him down from the tops of the high pines to which he retreats when pursued, and in such situations the rifle is the only certain enemy he has to dread.

“This squirrel is seldom seen out of its retreat early in the mornings and evenings, as is the habit of the other species. He seems to be a late riser, and usually makes his first appearance at 10 or 11 o'clock, and retires to his domicile long before evening. He does not appear to indulge so frequently in the barking propensities of the genus as the other and smaller species. This note when heard is not very loud but hoarse and guttural. He is easily domesticated, and is occasionally seen in cages, but is less active and sprightly than the smaller species.

“As an article of food the fox squirrel is apparently equally good with any other species, although I have observed that the little Carolina squirrel, is usually preferred, as being more tender and delicate. Where how-

ever squirrels are very abundant, men soon become surfeited with this kind of food, and in Carolina, even among the poorer class, it is not generally preferred.

“This species, like all the rest of the squirrels, is infested during the summer months with a troublesome *larva*, which, fastening itself on the neck or shoulders, must be very annoying, as those most affected in this manner are usually poor, and their fur appears thin and disordered. It is however less exposed to destruction from birds of prey and wild beasts than the other species. It leaves its retreat so late in the mornings and retires so early in the afternoons, that it is wholly exempt from the depredations of owls, so destructive to the Carolina squirrel. I have seen it bid defiance to the attacks of the red-shouldered hawk, (*Falco lineatus*,) the only abundant species in the south, and it frequents those high grounds and open woods where the fox and wild cat seldom resort, during the middle of the day, so that man is almost the only enemy it has to dread.”

2. SPECIES *Texianus*. (n. s.) **TEXIAN SQUIRREL.**

In the Museum at Paris, I observed a species of squirrel said to have been received from Mexico, of which I could find no description. At Berlin and Zurich I observed the same species, and in the British Museum a specimen obtained by Douglass in Texas, agreeing with the former in every particular. I have also the descriptions of a specimen received from the southwestern part of Louisiana, which differs from the above in no important particulars.

General description.—Size of *S. capistratus*; above, mingled black and yellow; beneath, deep yellow; under sides of the limbs whitish; fore legs externally and feet rich yellow; ears yellow, with white hairs interspersed; nose and lips brownish white. Hairs of tail rusty yellow at base, with a broad black space near extremity, and tip with yellow.

Dimensions.

	In.	Lines.
Length of body, - - - - -	13	6
“ of tail to end of hair, - - - - -	15	0
“ of <i>tarsus</i> , - - - - -	3	0
Height of ears to end of fur, - - - - -	“	6½

3. SPECIES *sub-auratus*. (n. s.) **GOLDEN-BELLIED SQUIRREL.**

ESSENTIAL CHARACTERS.—Size intermediate between the Northern Grey and the Little Carolina Squirrel; tail longer than the body; color above grey, with a wash of yellow, beneath deep golden yellow.

Dental formula.—Incis. $\frac{2}{2}$. Can. $\frac{0}{0}$. Mol. $\frac{4}{4}$.—20.

General description.—Body slight and formed for activity; tail broad and long; *color*, above grey, washed with yellow; hairs of the upper surface, slate colored at base, annulate with yellow, then black, and annulated with yellowish white; sides of the face and neck and *all beneath*, with the feet and inner side of limbs golden yellow; hair of the ears, long, golden yellow; hairs of the feet blackish at root, sometimes tipped with black; hairs of tail black at base, yellow, triannulate with black; whiskers black, longer than the head.

Dimensions.

					In.	Lin.
Length of head and body,	-	-	-	-	10	6
Ditto of tail, (<i>vertebræ</i>),	-	-	-	-	9	2
Ditto including fur,	-	-	-	-	12	0
Ditto of palm to end of middle fore claw,	-	-	-	-	1	7
Ditto of heel to point of middle nail,	-	-	-	-	2	7
Ditto of fur on the back,	-	-	-	-	“	7
Height of ear posteriorly,	-	-	-	-	“	5
Breadth of tail with hair extended,	-	-	-	-	8	6
Weight 1½ lbs.						

4. SPECIES *magnicaudatus*. GREAT-TAILED SQUIRREL.

Sciurus macrourus. Say, Long's Expedition, vol. i, p. 115.

——— *magnicaudatus*. Harlan's Fauna, p. 170.

——— *macrourus*. Godman's Nat. Hist. Vol. 2, p. 134.

ESSENTIAL CHARACTERS.—*Size intermediate between S. cinereus and S. leucotis; body above and on each side mingled grey and black; ears long; tail very broad.*

General description.—Fur plumbeous; black at the base; then, in succession, pale cinnamon, black, cinereous, and tipped with black; ears, *without*, bright ferruginous, *within*, dull ferruginous, with the hairs tipped with black; sides of the head, with the orbits of the eyes and belly, pale ferruginous; under part of head and neck, upper part of feet, with the tail, ferruginous; this latter *beneath*, bright, and *above*, marked with black; cheeks beneath the eyes and ears dusky, and the mouth margined with black; whiskers disposed in five series of flattened hairs, the inferior more distinct. The fur of the belly is plumbeous at the base; fur of the under surface of the tail, bright ferruginous at base with a sub-marginal line, that of the upper surface of a pale cinnamon within, with the base and three bands black; palms of the fore

feet black; rudimental thumb covered by a broad flat nail. The hair in summer $\frac{7}{8}$ of an inch in length, which increases in winter to one and one and three quarter inches.

The bones of this species are distinguished by their remarkable red color.

5. SPECIES *aureogaster*. (F. Cuv. and Geoff.) CALIFORNIAN SQUIRREL.

“*Sciurus aureogaster*; F. Cuv. and Geoff. Mamm.

“*Ecureuil de la Calafornie*; Id.

“General hue above deep grey grizzled with yellow; under parts and inner side of limbs deep rusty red; chin, throat and cheeks pale grey; limbs externally and feet colored as the body above; hairs on the toes chiefly dirty white; tail large and very bushy; hairs of the tail black, twice annulated with dirty yellow, and broadly tipped with white, the white very conspicuous where the hairs are in their natural position; ears thickly clothed, chiefly with blackish hairs, the hinder basal part externally with long white hairs, extending slightly on the neck; all the hairs of the body are grey at the base, those of the upper parts annulated first with yellow, then black, and then white; whiskers black, the hairs very long and bristly; the under incisors almost as deep an orange color as the upper.

“*Habitat* Mexico and California.

DIMENSIONS.

	In.	lines.
“Length from nose to root of tail, - - - -	12	0
Ditto of tail to end of hair, - - - -	10	6
Ditto of heel to end of claws, - - - -	2	5 $\frac{1}{2}$
Ditto from nose to ear, - - - -	2	1 $\frac{1}{2}$
Height of ear posteriorly, - - - -	2	7 $\frac{1}{2}$ ”

6. SPECIES *cinereus*. Lin. CAT SQUIRREL.

ESSENTIAL CHARACTERS.—A little smaller than the Fox Squirrel; larger than the northern Grey Squirrel; body stout; legs rather short; nose and ears not white; tail, longer than the body.

General description.—Head shorter and more obtuse than that of the fox squirrel; neck short, legs short and stouter; tail also shorter, less distichous; the body is also stronger and of a more heavy, clumsy appearance. Incisors narrower than those of the fox squirrel, also shorter and less prominent; the nails shorter, narrower, and less arched. The color is subject to considerable variations between light grey and black; sometimes they are found nearly white, without the red eyes of the albinos. The varieties

of *S. capistratus* are permanent in their colors, while those of the present may be found of every shade between black and white.

“ On the cheeks there is a slight tinge of yellowish brown, extending to the neck at the insertion of the head ; the inner surface of the ears of the same color, the outer surface of the fur on the ear, which extends a little beyond the outer edge, and is of a soft woolly appearance, is light cinereous edged with rusty brown ; whiskers black and white, the former color predominating. Under the throat, the inner surface of the legs and thighs, and the whole under surface, white ; on the back the fur is dark cinereous near the roots, then light ash, then a line of black and tipped with white, giving it on the outer surface an iron-grey appearance. The tail, which does not present the flat distichous appearance of the majority of the other species, but is more rounded and narrower, is composed of hairs which, separately examined, are of a soiled white tint near the roots, then a narrow marking of black, then white, then a broad line of black, and finally broadly edged with white.

DIMENSIONS.

						In.	lines.
“ Length of head and body,	-	-	-	-	-	11	3
Ditto of tail, (<i>vertebræ</i>),	-	-	-	-	-	9	6
Ditto of tail to the tips,	-	-	-	-	-	12	6
Height of ear posteriorly,	-	-	-	-	-	“	6
Palm and middle fore claw,	-	-	-	-	-	1	6
Heel and middle hind claw,	-	-	-	-	-	2	9
Length of fur on the back,	-	-	-	-	-	“	7”

This species is said to be common in the oak and hickory woods of Pennsylvania. I also observed one in the hands of a gunner near Fredericksburgh, Va. It is very uncommon in the northern parts of New York, but more frequent in the southern counties. Its habits are sluggish when compared with the lightness and activity of the grey squirrel. It rarely leaps, and seldom mounts to the tops of trees, but contents itself with creeping slowly and cautiously along the branches.

7. SPECIES *leucotis*. NORTHERN GREY AND BLACK SQUIRREL.

“ *Grey Squirrel* ; Pennant's Arctic Zool., vol. i, p. 135 ; Hist. Quad. No. 272.

“ *Sci. Carolinensis* ; Godman, non Gmel.

“ *Sciurus leucotis* ; Gapper, Zool. Journ. vol. v, p. 206, published about 1830.

“ ESSENT. CHAR.—Larger than the Carolina Grey Squirrel ; tail much longer than the body ; smaller than the Cat Squirrel ; subject to many varieties in color.

“This sprightly and very common species, existing in the northern and middle States, has hitherto been united with the Carolina grey squirrel; the name having been first appropriated to the latter, and the present species being, as I shall endeavor, in this and the succeeding article, to prove, specifically distinct, I have proposed for it the above name.

“This squirrel seems to have permanently twenty two teeth; among a large number procured in different seasons of the year and some of them, from the manner in which their teeth were worn, appearing to be old animals, all presented the small front molars in the upper jaw, except a single specimen, and even in this instance, these teeth may have accidentally dropped out. This permanency in teeth that have been usually regarded as deciduous, would seem to require an enlargement of the characters given to this genus; it will moreover be seen that the majority of our species are similar to this in their dental arrangements.”

General description.—Incisors strong, compressed, the upper ones with a sharp cutting edge and chisel-shaped; the lower ones much longer and thinner. The anterior grinder round and small, and equal in length with the second; the remaining four grinders present two transverse ridges of enamel. The lower grinders corresponding with those above have also elevated crowns. Hair a little softer than that of the cat squirrel, being coarser on the forehead. The winter clothing is longer than that of summer.

“*Color.*—Although this species exist under many varieties, there appear to be two very permanent ones, which I shall attempt to describe.

“1. *Grey variety.*—The nose, cheek, around the eyes extending to the insertion of the neck, the upper surface of the fore, and hind feet, and a stripe along the sides, yellowish brown; the ears on their posterior surface are a soiled white, edged with brown; on the back from the shoulder there is an obscure stripe of brown, broadest at its commencement, and running down to a point at the insertion of the tail; in a few specimens this stripe is wanting. On the neck, sides, and hips the color is light grey; the hairs separately are for one half their length dark cinereous, then light umber, then a narrow mark of black, and tipped with white; a considerable number of black hairs are interspersed, giving it above a grey color; the hairs in the tail are light yellowish brown from the roots, with three stripes of black, the outer one being widest, and broadly tipped with white; the whole under surface is white.

“2. *Black variety.*—This variety I have, on several occasions, seen taken from the same nest with the grey squirrel. They breed and rear their young together, and the observations made with regard to the fox squirrel will also apply to these. This is of the size and form of the grey variety; it is a dark brownish black on the whole of the upper surface,

a little lighter beneath. In summer its color is less black than in winter. The hairs of the back and sides of the body and tail are obscurely annulated with yellow. There is here and there a white hair interspersed among the fur of the body, but no tuft of white as in *Sciurus niger*.

DIMENSIONS.

	In.	Lines.
" Length of head and body,	11	9
Ditto of tail, (<i>vertebræ</i>),	10	0
Ditto of the tip,	13	0
Height of ear,	"	7
Ditto to the end of fur,	"	9
Palm to end of middle claw,	1	10
Heel to end of middle nail,	2	6
Length of fur on the back,	"	7
Breadth of tail with hairs extended,	4	2

"*Geographical Distribution.*—The northern limits of this species are not determined; it however exists as far as Hudson's Bay, was formerly very common in the New England States, and in the less cultivated portions is still frequently met with. It is abundant in New York, and in the mountainous portions of Pennsylvania. I have observed it on the northern mountains of Virginia. It probably extends still farther south; in the lower parts of North and South Carolina however it is replaced by a smaller species. The black variety is more abundant in upper Canada, in the western part of New York, and in the states of Ohio and Indiana. It does not exist in Georgia, Florida, or Alabama; and among the specimens sent from Louisiana, stated to be of all the species existing in that state, I discovered that this squirrel was not of the number.

"*Habits.*—This appears to be the most active and sprightly species existing in our Atlantic states. It rises with the sun, and continues industriously engaged in search of food during four or five hours in the morning, scratching among leaves, running over fallen logs, ascending trees, and playfully coursing from limb to limb—often making almost incredible leaps from the higher branches of one tree to another. In the middle of the day it retires for a few hours to its nest, resuming its active labors and amusements in the afternoon, and continuing without intermission till the setting of the sun. During the warm weather of spring and summer it prepares itself a summer house on a tree, but not often at its summit. In constructing this nest, it does not descend to the earth in search of materials, but finds them ready at hand on the tree where it intends to take up its temporary residence. It first breaks off dried sticks, if they can be procured, to make a superstructure; if however such materials are not within reach, it commences gnawing off the green branches of the size of a thumb, and lays them in the crutch of the tree, or of some

large branch. It then proceeds to the extremities of the branches, and breaks off those portions that contain tufts of leaves, with which a compact nest is constructed, which, in the inner side, is sometimes lined with such mosses as are found on the bark of trees. In the preparation of this nest a pair is usually engaged, for an hour in the morning, during several successive days; and the noise they make in cutting the branches, and dragging them with their leaves to the nests, can be heard at a great distance. In winter they reside altogether in holes of trees, where their young, in most instances, are brought forth. Although a family to the number of five or six, probably the produce of a pair from the preceding season, may occupy the same nest during winter, yet they all pair off in spring, when each couple seems to occupy a separate nest, in order to engage in the duties of reproduction. The young, in number from four to six, are in the northern states, brought forth in May; they are of quick growth, and sufficiently advanced in a few weeks to leave the nest: at such times they are seen clinging around the tree which contains their domicile, and as soon as alarmed, they run to the hole, when one of them usually returns, and, protruding his head out of the hole, watches the movements of the intruder. In this stage of growth they are easily captured; their hole is stopped up, another opening is made beneath, and they are taken out by the hand protected by a glove. They soon become tolerably gentle, and are frequently kept in cages with a wheel attached, in which, as in the interior of a tread mill, they amuse themselves in playing for hours together. Sometimes two are placed together, and they soon learn to accommodate themselves to the wheel, and move together with great regularity. However gentle they may become in confinement, no instance has come to my knowledge of their having produced young in a state of domestication; although in a suitable cage such a result would in all probability be produced. A tame squirrel is, however, a troublesome pet; it is always ready to use its teeth on the fingers of every intruder on its cage, and does not always spare even its feeder; and when permitted to have the freedom of the house, it soon incurs the displeasure of the prudent housewife by its habit of gnawing chairs, tables, and books.

“During the breeding season the males, like those of deer and other species, engage in frequent contests, and often bite and wound each other severely. The story of their emasculating each other on these occasions has been so often repeated, that it has become a matter of history, and it would now be somewhat dangerous to set it down as a vulgar error. It might however be advanced, on the other hand, that the admission of such skill and refinement in cruelty would be ascribing to the squirrel a higher degree of physical and surgical knowledge than is possessed by any other quadruped. From the observations I have been enabled to make, I have been led to believe that the error has originated from the

fact that those parts in the male which in one season are greatly enlarged, are in the other equally diminished, and that in young males especially, they are drawn into the *pelvis* by the contraction of the muscle. As a proof of this, a friend, who was a strenuous believer in this spiteful propensity ascribed to the squirrel, was induced to test the inquiry by an examination of a suitable number of specimens. He obtained in a few weeks upwards of thirty males;—in none of these had this mutilation taken place. Two however, out of this number were triumphantly brought forward as evidences of the truth of the doctrine; on examination it appeared that these were young animals, with the organs perfect, but concealed in the manner above stated.

“It is generally believed that this species lays up a great hoard of food as a winter supply; it may however be reasonably doubted whether they are so provident in this respect. The trees in which they conceal themselves in winter are frequently cut down, and no supply of provisions is ever found in their nests. In following their tracks in the snow they cannot be traced to any hoards buried in the ground. I have moreover observed them during a warm day in winter coming from great distances into the open fields, in search of a few dry hickory nuts which were still left suspended on the trees; if provisions had been laid up nearer home, they would hardly have undertaken these long journeys, or exposed themselves to so much danger in procuring a precarious supply. In fact, this species, in cold climates, seldom leaves its nest in winter, except in a warm sunny day; and in this state of inactivity and partial torpidity, it requires but little food.

“This squirrel feeds upon the various nuts, seeds, and grain which are periodically sought for by all the species of this genus, but it seems to prefer the shell-bark (*Carya alba*) and the several species of hickory, to any other kind of food. Even when the nuts are so green as to afford scarcely any nourishment, the northern grey squirrel is seen gnawing off the thick epidermis, which drops to the ground like rain, and then, with its lower incisors, makes a small linear opening in the thinnest part of the shell, immediately over the kernel. When this part has been extracted it proceeds to another, till in an incredible short space of time, the nut is cut longitudinally on its four sides, and the whole kernel secured, leaving the portions of the hard shell untouched. Were, however, this species to confine its depredations to the hickory, chestnut, beech, oak, and maple, it would be less obnoxious to the farmer; but unfortunately for the peace of both, it is fond of the green corn and young wheat, to which the rightful owner imagines himself to have a prior claim. A war of extermination consequently ensues, and various inducements are held out to tempt the gunner to destroy them. In Pennsylvania an ancient law existed, offering three pence a head for every squirrel destroyed, and in one year (1749) the enormous sum of £8000 was paid out of the treasury, in pre-

miums for the destruction of these depredators. In several of the northern and western states, the inhabitants on an appointed day, are in the habit of turning out on what is called a squirrel hunt. They arrange themselves under opposite leaders, each party being stimulated by the ambition of victory, and of fastening on the other the expense of a bountiful supper. The hunters range the forest in every direction, and the accounts given us of the number of squirrels brought together at the evening rendezvous, are almost incredible.

“ In addition to the usual enemies of this species in the northern states, such as the weasel, fox, lynx, &c., the red-tailed hawk seems to regard it as his natural and lawful prey. It is amusing to see the skill and dexterity exercised by both in the attack and defence. When the hawk is unaccompanied by his mate, he finds it no easy matter to secure the squirrel; unless the latter be unconsciously pounced upon whilst on the ground, he is enabled, by his dodgings and twistings round the limb of a tree, to evade the attacks of the hawk for hours, and frequently worries him into a reluctant retreat. But the red-tail, like other robbers, has learnt by experience that he is most certain of his prey when hunting in couples. He is frequently accompanied by his mate, especially in the breeding season, and in this case the contest is soon decided. They course rapidly, in opposite directions, above and below the limb; the attention of the squirrel is thus divided and distracted, and before he is aware of it, the talons of the hawk are in his back, and with a shriek of triumph the latter bears him off, either to the aery of his young, or to some low limb of a tree, or to a sheltered situation on the ground, where, with a suspicious glance towards each other, and an occasional hissing and growling for the choice parts, the hawks devour their prey.

“ This species of squirrel has occasionally excited the wonder of the populace, by its wandering habits, and its singular and long migrations. Like the lemming (*Lemmus Norvegicus*) of the eastern continent, it is stimulated, either from a scarcity of food, or from some other inexplicable instinct, to leave its native haunts, and seek for adventures or for food in some distant and, to him, unexplored portion of our land. The newspapers from the west contain frequent details of these migrations; they appear to have been more frequent in former years than at the present time. The farmers in the western wilds regard them with sensations which may be compared to the anxious apprehensions of the eastern nations at the flight of the devouring locust. At such periods, which usually occur in autumn, the squirrels congregate in different districts of the far northwest, and, in irregular troops, bend their way instinctively in an eastern direction. Mountains and cleared fields,—the head waters of lakes and broad rivers,—present no unconquerable impediments. Onward they come, devouring on their way every thing that is suited to a squirrel's taste,—laying waste the corn and wheat fields of the farmer;

and as their numbers are thinned by the gun, the dog and the club, others are ready to fall in the rear and fill up the ranks, till they occasion infinite mischief and call forth no empty threats of revenge. It is often inquired how these little creatures, that on common occasions, have such an instinctive dread of water, are enabled to cross broad and rapid rivers, like the Ohio and Hudson for instance. It is usually asserted, and believed by many, that they carry to the shore a suitable piece of bark, and seizing the opportunity of a favorable breeze, seat themselves upon this substitute for a boat, hoist their broad tails as a sail, and float safely to the opposite shore. This, together with many other traits of intelligence ascribed to this species, I suspect to be apocryphal. That they do migrate at irregular, and occasionally at distant periods, is a fact sufficiently established; but in the only instance in which I had an opportunity of witnessing the migrations of the squirrel, it appeared to me that he was not only an unskilful sailor, but a clumsy swimmer. It was (as far as my recollection serves me of the period of early life) in the autumn of 1808 or 9; troops of squirrels suddenly and unexpectedly made their appearance in the neighborhood, but among the grey ones were varieties not previously seen in those parts; some were broadly striped with yellow on the sides, and a few with a black stripe on each side, bordered with yellow or brown, resembling the stripes of the little chipping squirrel (*Tamias Lysteri*.) They swam the Hudson in various places between Waterford and Saratoga; those which I observed crossing the river were swimming deep and awkwardly, their bodies and tails wholly submerged; several that had been drowned were carried downward by the stream, and those which were so fortunate as to reach the opposite bank were so wet and fatigued, that the boys stationed there with clubs, found no difficulty in securing them alive or in killing them. Their migrations on that occasion did not, as far as I could learn, extend farther eastwardly than the mountains of Vermont; many remained in the county of Rensselaer, and it was remarked that for several years afterwards the squirrels were far more numerous than before. It is doubtful whether any ever return westwardly, but finding forests and food suited to their taste and habits, they take up their permanent residence in their newly explored country; there they remain and propagate their species, until they are gradually thinned off by the effects of improvement, and the dexterity of the sportsmen around them."

8. SPECIES *Carolinensis*, Gmel. LITTLE CAROLINA GREY SQUIRREL.

Ecureuil gris de la Carolina. Bosc, ii, 96, pl. 29.

ESSENT. CHAR. Smaller than the Northern Grey Squirrel, tail narrower than in that species, the length of the body; color

above, rusty grey, white beneath, not subject to vary in color. Dental formula: Incis. $\frac{2}{2}$; Can. $\frac{0}{0}$; mol. $\frac{5}{4}$;—22.

This has been invariable considered as identical with the *Northern Grey Squirrel*, but it is undoubtedly a distinct species. The head of the *S. Carolinensis* is shorter, and the space between the ears proportionately broader; and the nose is sharper. The small anterior molar in the upper jaw is permanent. It is considerably larger than in *S. leucotis*, and all my specimens, which indicate that the animal was more than a year old, instead of the small, thread-like, single tooth of the *S. leucotis*, have a distinct double tooth with a double crown; the other molars are in form not unlike those of the other species, but are shorter and smaller; the upper incisors are nearly a third shorter. The body is shorter, less elegant in shape, and has not the appearance of sprightliness and agility, for which the other species is so distinguished. The ears, which are nearly triangular in shape, are so slightly clothed with hair internally that they may be said to be nearly naked: externally they are sparsely clothed with short woolly hair, which, however does not extend beyond the margins, as in the other species. The nails are shorter and less hooked. The tail is shorter and does not present the broad distichous appearance of the other. This species is not subject to run into varieties.

DIMENSIONS.

	In.	Lines.
Length of head and body,	9	6
Ditto of tail, (<i>vertebræ</i>),	7	4
Ditto to point of hair,	9	6
Height of ear,		6
Palm to end of middle claw,	1	3
Heel to end of middle nail,	2	6
Length of fur on the back,		5
Breadth of tail with hairs extended,	3	0

Color.—Teeth light orange; nails brown, lighter at the extremities; whiskers black; nose and cheeks, and around the eyes, a slight tinge of rufous grey. The fur on the back is for three fourths its length, dark plumbeous, then a slight marking of black, edged with brown in some hairs and black in others, giving it, on the whole upper surface, a uniform dark ochreous

color. In a few specimens there is an obscure line of lighter brown along the sides, where the ochreous color prevails, and a tinge of the same color on the upper surface of the fore legs above the knees. The feet are light grey; the tail, for three fourths of its length from the root is yellowish brown, then black edged with white; the throat, inner surface of the legs and the belly, white.

This species is common in South Carolina, Alabama, Florida, &c. and is probably not rare as far north as Philadelphia.

In habits this species differs much from the *S. leucotis*. Its bark is less full, and much shriller and more querulous. Its usual haunts are in low swampy places, and among the trees overhanging rivers. It is very active even after dusk, and in moonlit evenings. The young are commonly five or six in number and brought forth in March.

9. SPECIES *nigrescens*. Bennett. DUSKY SQUIRREL.

DIMENSIONS.

	In.	Lines.
Length from point of nose to root of tail,	12	4
Ditto of tail to end of hair,	15	4
<i>Tarsus</i> , claws included,	2	7½
Nose to ear,	2	2½
Height of ear posteriorly,		8½

Prevailing color black, slightly grizzled on the body, crown of the head and legs, with grey; sides of the neck, groins, upper parts of the thighs and rump, grizzled with pale yellow; cheeks, chin, throat, neck, breast and the whole of the under surface, including the interior of the legs, dingy grey. Ears well clothed with hairs; hind part dingy grey, fore part the color of the back; hairs of the hinder parts of thighs black. Tail, hairs black at the roots, then grey, then a broad band of black, and broadly tipped with white. Feet black; the hairs of the toes grizzled with white points. Whiskers about the length of the head, black. Hairs on the back plumbeous black at the roots, for two thirds of their length, then grey, then black, and tipped with whitish grey. Numerous strong black hairs interspersed over the body.

Described from the original specimen in the Museum of Zoological Society: No. 429 in the Catalogue.

10. SPECIES *Colliei*, Richardson. COLLIE'S SQUIRREL.

Dimensions.

	In.	Lines.
" Length from nose to root of tail,	10	9
" of tail to end of hair,	9	6
<i>Tarsus</i> , including nail,	2	5
Height of ear posteriorly,	0	6
Nose to ear,	2	0

" *Color*.—Above, grizzled black and buff yellow; sides of muzzle, under parts, and inner sides of limbs white. Tail moderate, the hairs greyish white, three times annulated with black. Hairs of the body, both above and beneath, grey at the root; that of the back with a lengthened black tip, and broadly annulated with buff yellow. The hairs of the head resemble those of the back, except on the fore part, where they are annulated with whitish. Top of the muzzle brown, cheeks greyish. Ears well clothed with hairs, which are internally of a yellowish color, externally grizzled with black and yellow on the fore part, but posteriorly with long whitish hairs. Hairs of feet white, black at the root; the whiskers are as long as the head, composed of bristly black hairs.

" Described from the original specimen deposited by Dr. Richardson in the Museum of the Zoological Society.

11. SPECIES *niger*. THE BLACK SQUIRREL.

" *Sciurus niger*; Linn. non Catesby.

————— Desm. Mammalogie, p. 334.

————— Godman; Nat. Hist. vol. ii, p. 133.

" A little larger than the Northern Grey Squirrel. Fur soft and glossy; ears, nose, and the whole body pure black, a few white tufts of hair interspersed. Dental formula; Incisors, $\frac{2}{2}$; Canines, $\frac{0}{0}$; Molars, $\frac{14}{14}$;—20.

" Much confusion has existed with regard to this species. The original *Sciurus niger* of Catesby is the black variety of the fox squirrel. It is difficult to decide, from the description of Drs. Harlan and Godman, whether they described from specimens of the black variety of the northern grey squirrel, or of the species which I am about to describe. Indeed, there is so strong a similarity, that I have admitted it as a species with some doubt and hesitation. Dr. Richardson has, under the head of *Sciurus niger*, (see 'Fauna Boreali-Americana,' p. 191), described a specimen from Lake Superior, of what I conceive to be the black variety of the grey squirrel; but at the close of the same article (p. 192), he has described another specimen from Fort William, which answers to the description of the specimens now before me. There is great difficulty in finding suitable characters by which the majority of our species of squir-

rel can be designated ; but in none is there greater than in the present. All our naturalists seem to insist that we have a *Sciurus niger*, although they have applied the name to the black varieties of several other species. As the name, however, is likely to continue on our books, and as the specimens before me, if they do not establish a true species, will show a very permanent variety, I shall describe them under the above name.

“ Dr. Godman states (Nat. Hist. vol. ii, p. 133), that the black squirrel has only twenty teeth ;—the specimens before me have no greater number, with the exception of one, evidently a young animal, a few months old, which has an additional tooth on one side, so small that it appears like a white thread, the opposite and corresponding one having already been shed. If further examinations go to establish the fact, that this additional molar in the northern grey squirrel is persistent, and that of the present deciduous, there can be no doubt of their being distinct species. Its head appears to be a little shorter and more arched than that of the grey squirrel, although it is often found that these differences exist among different individuals of the same species. Incisors compressed, strong, and of a deep orange color anteriorly. Ears elliptical, and slightly rounded at the tip, thickly clothed with fur on both surfaces, that on the outer surface in a winter specimen, extending three lines beyond the margin : there are, however, no distinct tufts. Whiskers a little longer than the head ; tail long and distichous, thickly clothed with moderately coarse hair.

“ The fur is softer to the touch than that of the northern grey squirrel. The whole of the upper and lower surface, as well as the tail are bright glossy black ; at the roots the hairs are a little lighter. The summer specimens do not differ materially in the color of their fur from the winter ones, except that they are not so intensely black. In all the specimens I have had an opportunity of examining, there are small tufts of white hairs irregularly situated on the under surface, resembling those on the body of the mink. There are also a few scattered white hairs on the back and tail.

Dimensions.

	In.	Lines.
“ Length of head and body,	13	0
“ of tail (<i>vertebræ</i>),	9	1
“ including fur,	13	0
Palm to end of middle fore claw,	1	7
Length of heel to the point of middle claw,	2	7
“ of fur on the back,	2	8
Breadth of tail with hair extended,	5	0

“ *Geographical Distribution.*—The specimens from which this description has been taken were procured, through the kindness of friends,

in the counties of Rensselaer and Queen's, New York. I have seen it on the borders of Lake Champlain, at Ogdensburgh, and on the eastern shores of Lake Erie; also near Niagara, on the Canada side. The individual described by Dr. Richardson, and which may be clearly referred to this species, was obtained by Capt. Bayfield at Fort William, on Lake Superior. Black squirrels exist through all our western wilds, and to the northward of the great lakes; but whether they are of this species, or the black variety of the grey squirrel, I have not had the means of deciding.

“*Habits*.—An opportunity was afforded me many years since of noticing the habits of this species in the northern parts of the state of New York. A seat under the shadow of a rock, and near a stream of water, was, for several successive summers, a favorite resort for retirement and reading. In the immediate vicinity were several large trees, in which were a number of holes, and from which, at almost every hour of the day, were seen issuing this species of black squirrel. There seemed to be a dozen of them; they were all of the same glossy black color; and although the northern grey squirrel and its black variety were not rare in that neighborhood, yet, during a period of five or six years I never witnessed any other than the present species in that locality; and recently, after the lapse of twenty years, a specimen, from which the above description was in part drawn up, was sent to me, which had been procured on that identical spot. They appeared to possess all the sprightliness of the northern grey squirrel;—appearing to prefer valleys and swamps to drier and more elevated situations: and I observed that one of their favorite trees, to which they retreated on hearing the slightest noise, was a large white pine (*Pinus Strobus*), in the immediate vicinity. I was surprised at sometimes seeing a red squirrel (*Sciurus Hudsonius*), which seemed also to have given a preference to this tree, pursuing the black squirrel, seeming to quarrel with and scold it vociferously, till the latter was obliged to make its retreat. When the squirrels approached the stream which ran within a few feet of my seat, they often stopped to drink, and instead of lapping the water like the dog and cat, they protruded their mouths a considerable distance into the stream, and drank greedily; they would afterwards sit upright, supported by the *tarsus*, and, with tail erect, busy themselves for a quarter of an hour in wiping their faces with their paws, the latter being also occasionally dipped in the water. Their barking and other habits did not seem to differ from those of the northern grey squirrel.

“*General Remarks*.—I have admitted this as a true species, not so much in accordance with my own positive conviction, as partly in deference to the opinions of all our naturalists, and principally from the consideration that if it be no more than a variety, it has, by time and suc-

cession, been rendered a permanent race: and as the species differ so widely and uniformly in color, we may perhaps be warranted in regarding them as distinct. The only certain mode of deciding whether this is a true species or merely a variety, would be to ascertain if the opposite sexes of these differently marked animals associate and breed together in a state of nature. Where the produce of two animals, however different in size and color, are in the constant habit of propagating their species in a wild state, we are warranted in pronouncing them identical. Where, on the contrary, there is no such result, we are compelled to come to an opposite conclusion.

[To be continued.]

ART. XVIII.—*Catalogue of Botanical Specimens collected by J. WOLLE and A. L. HUEBENER, during the year 1837, in the vicinity of Bethlehem and other parts of Northampton County, Pennsylvania, in the order as they were found in bloom.*

Bethlehem, Nov. 2d, 1838.

TO PROF. SILLIMAN.

Dear Sir,—I take the liberty to transmit to you a Catalogue of Botanical Specimens collected by my friends Jacob Wolle, Esq. and Dr. A. L. Huebener of this place. Should it be desirable to have any specimens, you will please address Dr. A. L. Huebener, who is enabled to give any further information respecting the locality, habits, &c. of the different plants.

It gives me pleasure as Principal of the Seminary for Young Ladies at this place, to contribute my mite to the extension of the Science of Botany; and to encourage my friends already urged by every means in my power to prosecute their researches, in hopes that many others may be induced to examine the Flora of their own neighborhood with equal diligence.

I am, dear sir, with sentiments of esteem, yours,

Very respectfully,

JOHN G. KUMMER.

April.

Symplocarpus foetidus.

Alnus serrulata.

Corylus Americana.

Corylus rostrata.

Draba verna.

Gnaphalium plantagineum.

Stellaria media.

- Taxus Canadensis.*
Acer rubrum.
Ulmus Americana.
do. *fulva.*
Caltha palustris.
Corydalis Cucullaria.
Saxifraga Virginica.
Populus balsamifera.
do. *candicans.*
Chrysoplenium oppositifolium.
Hepatica triloba.
Anemone thalictroides.
Sanguinaria Canadensis.
Dirca palustris.
Laurus Benzoin.
Populus tremuloides.
do. *grandidentata.*
Juniperus Virginiana.
do. *Sabina.*
Pinus microcarpa.
Houstonia coerulea.
Aronia Botryapium.
Equisetum arvense.
Epigaea repens.
Salix recurvata.
do. *Mühlenbergiana.*
Hamamelis Virginica.
Leontodon Taraxacum.
Thlaspi Bursa pastoris.
Ranunculus abortivus.
do. *fascicularis.*
Anemone quinquefolia.
Salix vitellina.
Thalictrum dioicum.
Erythronium Americanum.
Lithospermum arvense.
Potentilla Canadensis.
Glechoma hederacea.
Lamium amplexicaule.
May.
Viola obliqua.
do. *debilis.*
do. *hastata.*
do. *cucullata.*
do. *ovata.*
do. *pedata.*
Viola blanda.
- do. *ochroleuca.*
do. *eriocarpa Schw.*
do. *sagittata.*
do. *clandestina.*
do. *villosa.*
do. *pubescens.*
do. *striata.*
do. *Canadensis.*
do. *primulaefolia.*
do. *velutina.*
do. *asarifolia.*
do. *palmata.*
do. *dentata.*
do. *rostrata.*
do. *lanceolata.*
Jeffersonia diphylla.
Zanthoxylum fraxineum.
Thuja occidentalis.
Acer dasycarpum.
Trillium sessile.
do. *cernuum.*
Betula lenta.
do. *nigra.*
do. *excelsa.*
do. *populifolia.*
do. *papyracea.*
Chelidonium majus.
Aquileja Canadensis.
**Draba glabella.*
Comptonia asplenifolia.
Cerastium tenuifolium.
do. *glutinosum.*
Claytonia Virginica.
Ranunculus acris.
Euchroma coccinea.
Pedicularis Canadensis.
Saxifraga Pennsylvanica.
Uvularia sessilifolia.
do. *perfoliata.*
do. *flava.*
Arum triphyllum.
Veronica agrestis.
do. *serpyllifolia.*
do. *peregrina.*
do. *arvensis.*
Orontium aquaticum.
Cardamine Virginica.

- Dodecatheon Meadia.
 Panax trifolia.
 Phlox reptans.
 do. setacea.
 Asarum Canadense.
 Fraxinus juglandifolia.
 Osmunda interrupta.
 do. cinnamomea.
 Prunus borealis.
 Mitella diphylla.
 Laurus Sassafras.
 Orchis spectabilis.
 Cypripedium pubescens.
 do. parviflorum.
 Vaccinium corymbosum.
 Andromeda racemosa.
 Aesculus glabra.
 Trientalis Americana.
 Fagus sylvatica, (*Linn.*)
 Cornus florida.
 Convallaria biflora.
 do. bifolia.
 Arabis rhomboidea.
 Carpinus Americana.
 Dentaria laciniata.
 Ribes floridum.
 * do. aureum.
 Senecio aureus.
 Convallaria racemosa.
 Polemonium reptans.
 Cercis Canadensis.
 Myrrhis Claytoni.
 Tiarella cordifolia.
 Cerastium vulgatum.
 Fedia radiata.
 Ranunculus recurvatus.
 do. bulbosus.
 Caulophyllum thalictroides.
 Hydrophyllum Virginicum.
 Acer Negundo.
 Pinus Canadensis.
 Cypripedium acaule.
 Quercus Banisteri.
 do. rubra.
 do. coccinea.
 do. alba.
 do. Prinus palustris.
- Quercus Chinquapin.
 do. tinctoria.
 do. Castanea.
 do. montana.
 do. triloba.
 do. discolor.
 (The remaining oaks found after
 they had flowered.)
 Pinus (*Larix*) pendula.
 Polygala paucifolia.
 Juniperus communis.
 Azalea nudiflora.
 Blitum capitatum.
 Vicia Cracca.
 Myrrhis procumbens.
 do. longistylis.
 Erigeron bellidifolius.
 Crataegus cordata.
 do. punctata.
 Smyrnum cordatum.
 Equisetum hyemale.
 Geranium maculatum.
 Prunus Virginiana.
 Obolaria Virginica.
 Juglans nigra.
 do. cinerea.
 Vaccinium frondosum.
 do. resinosum.
 do. Pennsylvanicum.
 do. stamineum.
 Convallaria multiflora.
 Platanus occidentalis.
 Cardamine Pennsylvanica.
 Corydalis glauca.
 Staphylea trifolia.
 Lonicera parviflora.
 Rumex Acetosella.
 Galium Aparine.
 Viburnum pyrifolium.
 Carya alba.
 do. tomentosa.
 do. sulcata.
 do. amara.
 do. porcina.
 Batschia canescens.
 Phlox aristata.
 Aronia arbutifolia.

Aronia ovalis.
 Crataegus coccinea.
 do. Crus-galli.
 Sisyrrinchium anceps.
 Orobanche uniflora.
 Salix repens (Linn.)
 Plantago lanceolata.
 Convallaria stellata.
 Oxalis violacea.
 do. stricta.
 Arenaria serpyllifolia.
 Sison integerrimus.
 Cochlearia officinalis.
 Senecio obovatus.
 Gyromia Virginica.
 Podophyllum peltatum.
 Myosotis scorpioides.
 Iris versicolor.
 Morus rubra.
 Carya squamosa.
 Smilax paniculata.
 Chrysanthemum Leucanthemum.
 Aralia nudicaulis.
 Sysyrrinchium mucronatum.
 Thesium umbellatum.
 Krigia Virginica.
 Ornithogalum umbellatum.
 Geranium Robertianum.
 Acer saccharinum.
 do. nigrum.
 Vicia Americana.
 Senecio gracilis.
 Cardamine teres.
 Sison aureus.
 Viburnum prunifolium.
 Ranunculus hispidus.
 Pinus Strobus.
 do. rigida.
 Sanicula Marilandica.
 Fagus ferruginea.
 Cynoglossum officinale.
 Cornus sericea.
 Fraxinus sambucifolia.

June.

Pyrus coronaria.

Lupinus perennis.
 Nuphar Advena.
 Andromeda Mariana.
 Stellaria pubera.
 Plantago Virginica.
 Rubus villosus.
 Veronica scutellata.
 do. officinalis.
 do. Beccabunga.
 Cornus circinata.
 Silene antirrhina.
 Aristolochia Sipro.
 Polygala Senega.
 Potentilla Norvegica.
 Gillenia trifoliata.
 Helianthemum Canadense.
 Kalmia angustifolia.
 do. latifolia.
 do. glauca.
 do. rosmarinifolia.
 Arum Dracontium.
 Nyssa aquatica.
 Chionanthus Virginica.
 Lepidium hirtum (Smith.)
 Krigia amplexicaulis.
 Cerastium nutans.
 Solanum Dulcamara.
 Arabis lyrata.
 Senecio vulgaris.
 Celastrus scandens.
 *Ulmus Americana var. pendula.
 Vaccinium dumosum.
 Smilax caduca.
 Galium lanceolatum.
 Symphoria racemosa.
 Iris Virginica.
 Osmunda regalis.
 Viburnum acerifolium.
 Spiraea opulifolia.
 Sparganium ramosum.
 do. simplex.
 Rhus Toxicodendron.
 Heuchera Americana.
 Cochlearia Armoracia.
 Trifolium pratense.
 Symphytum officinale.
 Corydalis fungosa.

- Geranium striatum.
 Gleditschia triacanthos.
 do. inermis.
 Smilax Pseudo-China.
 Lonicera sempervirens.
 Fumaria officinalis.
 Myrrhis Canadensis.
 Angelica atropurpurea.
 Salix lucida.
 Asclepias quadrifolia.
 Helonias dioica.
 Diervilla Tournesortii.
 Scrophularia Marilandica.
 Cyrtopodium pubescens (var.)
 Thalictrum pubescens.
 Ranunculus aquatilis.
 Juncus effusus.
 Agrostemma Githago.
 Quercus obtusiloba.
 Senecio heterophyllus.
 Hieracium venosum.
 Salix nigra.
 Sarracenia purpurea.
 Apocynum hypericifolium.
 Robinia hispida.
 Erigeron strigosus.
 do. purpureus.
 Pentstemon pubescens.
 Rhus radicans.
 Liriodendron Tulipifera.
 Rumex acutus.
 Ptelea trifoliata.
 Asplenium angustifolium.
 do. ebenum.
 do. Trichomanes.
 do. Ruta muraria.
 Tradescantia Virginica.
 Prunella vulgaris.
 Rubus occidentalis.
 do. trivialis.
 Anemone Virginiana.
 Vitis vulpina.
 Celtis occidentalis.
 Panicum latifolium.
 Juncus conglomeratus.
 Trifolium repens.
 Phlox maculata.
 Neottia latifolia.
 Habenaria Herbiola.
 Crataegus parvifolia.
 Heracleum lanatum.
 Viburnum prunifolium.
 do. dentatum.
 Erigeron integrifolius.
 Melampyrum lineare.
 Andromeda racemosa.
 Menispermum Canadense.
 Equisetum sylvaticum.
 Lysimachia quadrifolia.
 Vitis Labrusca.
 Senecio Balsamitae.
 Lepidium Virginicum.
 Mitchella repens.
 Malaxis liliifolia.
 Polypodium vulgare.
 Adiantum pedatum.
 Oenothera ambigua.
 do. muricata.
 do. biennis.
 do. grandiflora.
 Aspidium marginale.
 Lathyrus palustris.
 Aristolochia Serpentaria.
 Spiraea alba.
 do. corymbosa.
 Phalaris Americana.
 do. Canariensis.
 Gratiola Virginica.
 do. megalocarpa.
 Callitriche verna.
 Galium pilosum.
 Cornus stricta.
 Asclepias amoena.
 Pteris aquilina.
 Hypericum perforatum.
 Sanicula Canadensis.
 Pastinaca sativa.
 Campanula amplexicaulis.
 Antirrhinum Linaria.
 Oenothera pumila.
 Triosteum perfoliatum.
 Bromus mollis.
 Aspidium acrostichoides.
 do. punctilobum.

Daucus Carota.
 Thymus Serpyllum.
 do. vulgaris.
 Evonymus atropurpureus.
 Monotropa uniflora.
 Vitis aestivalis.
 Leonurus Cardiaca.
 Polypodium hexagonopterum.
 Apocynum androsaemifolium.
 Salix conifera.
 Botrychium Virginicum.
 do. gracile.
 Vitis riparia.
 Urtica urens.
 do. dioica.
 Sambucus Canadensis.
 Potamogeton compressus.
 Rosa Carolina.
 do. gemella.
 Rhus typhina.
 Smilax pandurata (Pursh.)
 Verbascum Blattaria.
 Achillea Millefolium.
 Cypripedium spectabile.
 Poa compressa.
 Convolvulus sepium.
 do. spithameus.
 Physalis viscosa.
 do. obscura.
 Rosa parviflora.
 Galium circaezans.
 Ceanothus Americanus.
 Pyrola elliptica.
 do. umbellata.
 Linum usitatissimum.
 Calopogon pulchellus.
 Oxycoccus macrocarpus.
 Asclepias phytolaccoides.
 Erigeron Canadensis.
 Smilax rotundifolia.
 Asplenium rhizophyllum.
 Lilium Philadelphicum.
 Quercus palustris.
 do. falcata.
 do. bicolor.
 Asclepias Syriaca.
 Rubus cuneifolius.

Lysimachia stricta.
 Rumex crispus.
 Hydrocotyle Americana.
 Aspidium asplenioides.
 Ledum pulchellum.
 do. repens.
 Agrimonia Eupatoria.
 Erigeron Philadelphicus.
 Crataegus apiifolia.
 Rhododendron maximum.
 Angelica lucida.
 do. triquinata.
 Ligustrum vulgare.
 Robinia viscosa.
 Malva rotundifolia.
 Chrysanthemum Parthenium.
 Pyrola rotundifolia.
 Polygonum sagittatum.
 Campanula rotundifolia.

July.

Nymphaea odorata.
 Marrubium vulgare.
 Cuphea viscosissima.
 Conium maculatum.
 Cornus sericea.
 Panicum depauperatum.
 Habenaria grandiflora.
 Periploca Graeca.
 Asclepias variegata.
 Cimicifuga racemosa.
 Circaea Lutetiana.
 do. Alpina.
 Quercus discolor.
 Geum album.
 Heliopsis laevis.
 Phryma leptostachya.
 Prinus verticillatus.
 Microstylis ophioglossoides.
 Asclepias purpurascens.
 Nepeta Cataria.
 Galium boreale.
 Sonchus oleraceus.
 Lilium Canadense.
 do. superbum.
 Habenaria lacera.
 Arabis falcata.

- Gratiola Caroliniana*,
Campanula aparinoides.
Scutellaria pilosa.
Verbascum Thapsus.
Hedysarum acuminatum.
Verbena urticifolia.
do. *hastata*.
Apocynum pubescens.
Gnaphalium Germanicum.
Cucubalus stellatus.
Clinopodium vulgare.
Chenopodium Botrys.
Diospyros Virginiana.
Asclepias viridiflora.
Typha latifolia.
Veratrum viride.
Sagittaria sagittifolia.
Phytolacca decandra.
Gnaphalium purpureum.
Lemna polyrhiza.
Asclepias debilis.
Campanula Americana.
Gerardia flava.
Dulichium spathaceum.
Asclepias verticillata.
Baptisia tinctoria.
Pyrola maculata.
Lechea major.
do. *minor*.
Gaultheria procumbens.
Linum Virginianum.
Hypericum punctatum.
Galium trifidum.
Sonchus spinulosus.
Hydrangea vulgaris.
Castanea vesca.
Tilia glabra.
Hordeum jubatum.
Menyanthes trifoliata.
Helianthus mollis.
Convolvulus panduratus.
Pycnanthemum incanum.
Monarda fistulosa.
Melanthium Virginicum.
Penthorum sedoides.
Thalictrum Cornuti.
Clematis Virginiana,
Urtica Canadensis.
Sium lineare.
Mimulus ringens.
do. *alatus*.
Galium Aparine.
Polygonum mite.
Anthemis Cotula.
Quercus macrocarpa.
do. *oliviformis*.
do. *imbricaria*.
Caltha flabellifolia.
Lobelia Dortmanna.
Hypericum cistifolium vel ad-
pressum.
Eriocaulon pellucidum.
Coptis trifolia.
Drosera rotundifolia.
Oxalis Acetosella.
Linnaea borealis.
* *Aralia calendulacea*.
* do. *hispida. a.*
* do. *viscosa*.
Hypericum Canadense.
Dalibarda repens.
Habenaria orbiculata.
do. *fimbriata*.
Orchis tridentata.
Cornus Canadensis.
Sparganium natans.
Lygodium palmatum.
Oenothera pusilla.
Gaultheria hispidula.
Epilobium spicatum.
do. *tetragonum*.
Ledum latifolium.
Rhodora Canadensis.
Hypericum parviflorum vel quin-
quenervium.
Briza Canadensis.
do. *media*.
Hypericum Sarothra.
Scutellaria lateriflora.
Eupatorium ternifolium.
Helonias erythrosperma.
Isnardia palustris.
* *Aralia hispida. c.*
Trillium erythrocarpum.

Liatris spicata.
 Lechea racemulosa.
 Ribes hirtellum.
 Ilex Canadensis.
 Betula glandulosa.
 Polygonum cilinode.
 Spiraea tomentosa.
 Pontederia cordata.
 do. angustifolia.
 Vaccinium Vitis idaea.
 *Dracaena umbellulata.
 Aspidium asplenioides.
 Pyrola secunda.
 Sambucus pubens.
 Lycopodium complanatum.
 do. dendroideum.
 do. lucidulum.
 do. clavatum.
 Prunus Pennsylvanica.
 Aspidium Noveboracense.
 do. Thelypteris.
 do. Goldianum.
 do. dilatatum.
 Ribes prostratum.
 Rubus idaeus.
 Viburnum lantanoides.
 do. nudum.
 Gnaphalium margaritaceum.
 Sorbus Americana.
 Nuphar Kalmiana.
 Cephalanthus occidentalis.
 Linum Virginianum.
 Polygala verticillata.
 do. purpurea.
 do. sanguinea.
 Lobelia inflata.
 Cnicus odoratus.
 Rhexia Virginica.
 Pycnanthemum muticum.
 do. linifolium.
 Rochelia Virginiana.
 Euphorbia Peplus.
 *Coreopsis tinctoria.
 Ludvigia microcarpa.
 Eupatorium purpureum.
 Cichorium Intybus.
 Hyoscyamus niger.

Teucrium Canadense.
 Goodyera pubescens.
 Anychia dichotoma.
 Polygonum aviculare.
 Gnaphalium uliginosum.
 Scutellaria integrifolia.
 Solidago squarrosa.
 Tephrosia Virginica.
 Xyris Caroliniana.
 Solidago bicolor.
 Trifolium procumbens.
 Agrimonia parviflora.
 Geum Virginianum.
 Polygonum hastatum.
 Erigeron integrifolius.
 Scirpus acicularis.
 Sida Abutilon.
 Leptandra Virginica.
 Datura Stramonium.
 Actaea Americana.
 Hedysarum laevigatum.
 Solidago viminea.
 Helianthus trachelifolius.
 Potamogeton fluitans.
 do. perfoliatus.
 Oenothera ambigua.
 Buchnera Americana.
 Bignonia radicans.
 Argemone Mexicana.
 Urtica pumila.
 Phlox undulata.
 *Borkhausia Caroliniana.
 Silene Pennsylvanica.
 Atropa physaloides.

August.

Potamogeton lucens.
 Rosa rubiginosa.
 do. nitida.
 Vallisneria spiralis.
 Lobelia Cardinalis.
 Hyssopus nepetoides.
 do. scrophularifolius.
 Potamogeton compressus.
 Silphium perfoliatum.
 Cassia nictitans.
 do. Chamaecrista.

- Cassia Marilandica.*
Solidago ciliaris.
Prenanthes deltoidea.
Humulus Lupulus.
Elodea Canadensis.
Podostemum ceratophyllum.
Cissus hederacea.
Hedysarum viridiflorum.
Euphorbia maculata.
Lycopus Virginicus.
 do. *angustifolius.*
Catalpa cordifolia.
Lindernia dilatata.
 do. *attenuata.*
Crotolaria sagittalis.
Botrychium obliquum.
 do. *fumarioides.*
 do. *dissectum.*
Ambrosia trifida.
 do. *integrifolia.*
Sabbatia angularis.
Hedysarum nudiflorum.
 do. *rotundifolium.*
 do. *paniculatum.*
 do. *Canadense.*
 do. *rigidum.*
 do. *canescens.*
 do. *Marilandicum.*
 do. *strictum.*
 do. *obtusum.*
 do. *cuspidatum.*
Chara vulgaris.
Equisetum palustre.
Potamogeton natans.
Brasenia peltata.
Polygonum amphibium.
Rudbeckia laciniata.
Sagittaria pubescens.
Scirpus tenuis.
 do. *capitatus.*
Veronia praealta.
 do. *Noveboracensis.*
Bidens bipinnata.
 do. *connata.*
 do. *chrysanthemoides.*
Cnicus lanceolatus.
 do. *discolor.*
- Cnicus horridulus.*
 do. *muticus.*
Collinsonia Canadensis.
Sium latifolium.
Mentha borealis.
 do. *viridis.*
 do. *Canadensis.*
Sanguisorba Canadensis.
Cnicus pumilus.
Aster pumilus.
 do. *Radula.*
 do. *cordifolius.*
 do. *linarifolius.*
 do. *humilis.*
 do. *sagittifolius.*
 do. *puniceus.*
 do. *corymbosus.*
 do. *amygdalinus.*
 do. *macrophyllus.*
 do. *patens.*
Eupatorium perfoliatum.
 do. *ageratoides.*
 do. *verticillatum.*
 do. *aromaticum.*
 do. *sessilifolium.*
 do. *linearifolium.*
 do. *ovatum.*
 do. *trifoliatum.*
 do. *punctatum.*
Boehmeria cylindrica.
 do. *lateriflora.*
Stachys intermedia.
Stilosanthes elatior.
Hieracium Gronovii.
 do. *paniculatum.*
Amphicarpaea monoica.
Corallorrhiza multiflora.
 do. *odontorrhiza.*
Pycnanthemum lanceolatum.
Solanum Lycopersicon.
Saponaria officinalis.
Habenaria ciliaris.
Prenanthes altissima.
Monarda oblongata.
 do. *fistulosa.*
 do. *diyma.*
 do. *punctata.*

- Cannabis sativa.*
Gaura biennis.
Schollera graminea.
Sagittaria acutifolia.
Lysimachia ciliaris.
Potamogeton pauciflorus.
Apios tuberosa.
Asimina triloba.
Sagittaria obtusa.
 do. *latifolia.*
 do. *simplex.*
Rumex Britannica.
Aralia racemosa.
Hedeoma pulegioides.
Hypericum Kalmianum.
Campanula acuminata.
Polygala ambigua.
Rhus Cotinus.
Solanum nigrum.
Trichostema dichotoma.
Myriophyllum ambiguum.
Gerardia tenuifolia.
 do. *purpurea.*
 do. *glauca.*
 do. *quercifolia.*
 do. *auriculata.*
Spiraea salicifolia.
Lobelia siphilitica.
Rudbeckia purpurea.
Lythrum verticillatum.
Inula Helenium.
Chelone glabra.
 do. *latifolia.*
Impatiens fulva.
 do. *pallida.*
Onoclea sensibilis.
Helianthus mollis.
 do. *giganteus.*
 do. *altissimus.*
 do. *frondosus.*
 do. *divaricatus.*
 do. *angustifolius.*
Lespedeza capitata.
 do. *sessiliflora.*
 do. *hirta.*
 do. *prostrata.*
 do. *violacea.*
- Lespedeza Stuvei.*
Parnassia Caroliniana.
Solidago gigantea.
 do. *serotina.*
 do. *odora.*
 do. *nemoralis.*
 do. *rugosa.*
 do. *altissima.*
 do. *patula.*
 do. *aspera.*
 do. *latifolia.*
Eupatorium maculatum.
Dracocephalum Virginianum.
Gratiola aurea.
Hieracium marianum.
Ceratophyllum demersum.
Ambrosia artemisifolia.
Chenopodium album.
 do. *rhombofolium.*
Sicyos angulata.
Bidens frondosa.
Bartonia tenella.
Rudbeckia hirta.
Neottia tortilis.
 do. *cernua.*
Gerardia pedicularia.
Prenanthes virgata.
 do. *Serpentaria.*
Hieracium Kalmii.
Arctium Lappa.
Polygala fastigiata.
Amarantus hybridus.
Heteranthera reniformis.
Urtica divaricata.
Monotropa Hypopithys.
 do. *lanuginosa.*
Mollugo verticillata.
Acalypha Virginica.
Zannichellia intermedia.
Chenopodium anthelminticum.
 do. *ambrosioides.*
Polygonum punctatum.
Hibiscus palustris.
Pennisetum verticillatum.
Sonchus Floridanus.
 do. *acuminatus.*
Aster simplex.

Aster multiflorus.
 do. miser.
 Solidago rigida.
 do. puberula.
 Lysimachia ciliata.
 Lycopus Virginicus.
 Gnaphalium uliginosum.
 Euphorbia marginata.
 Berberis vulgaris.
 Halesia tetraptera.
 Solidago arguta.

September.

Festuca elatior.
 Panicum Crus-galli.
 Cunila Mariana.
 Senecio hieracifolius.
 Lespedeza reticulata.
 Aster Novae Angliae.
 Polygonum Convolvulus.
 Neottia cernua.
 Gentiana Saponaria.
 Polygonum latifolium.
 Phaseolus perennis.
 Aster ericoides.
 do. lævis.
 do. paniculatus.
 Hypericum Virginicum,
 Eriophorum Virginicum.
 Polygala sanguinea.
 Helianthemum ramuliflorum.
 Solidago serotina.
 do. flexicaulis.
 do. juncea.
 Lemna polyrrhiza.
 Ranunculus tomentosus.
 Pedicularis pallida.
 ?Cnicus Hystrix.
 Xanthium strumarium.
 Althaea officinalis.
 Amarantus hypochondriacus.
 do. melancholicus.
 do. sanguineus.
 Ruellia strepens.
 Lycopus uniflorus.
 Chenopodium viride.
 Solidago rugosa.
 Aster divergens.

Lespedeza procumbens.
 Solidago lateriflora.
 *Sempervivum tectorum.
 Kuhnia Critonia.
 Chenopodium ambrosioides.
 Agrostis lateriflora.
 Aster rigidus.
 Vernonia praealta.
 Cuphea viscosissima.
 Bidens petiolata.
 Tussilago Farfara.
 Gentiana quinqueflora.
 Isanthus caeruleus.
 Solidago speciosa.
 do. caesia.
 Petris atropurpurea.
 Schizaea pusilla.
 Aster solidaginoides.
 do. subulatus.
 do. foliolosus.
 do. tenuifolius.
 do. salicifolius.
 Lycopodium apodum.
 do. rupestre.
 Lemna trisulca.
 Aletris farinosa.
 Gerardia purpurea.
 Isoetes lacustris.
 Ophioglossum vulgatum.
 Cyperus inflexus.
 Euphorbia pilosa.
 Aspidium Thelypteris.
 do. Noveboracense.
 do. dilatatum.
 do. Lancastriense.
 Asplenium ebum.
 do. thelypteroides.
 Aster conyzoides.
 do. phlogifolius.
 do. laevigatus.
 do. Novi Belgii.
 do. acuminatus.
 Gentiana crinita.
 Lycopodium?
 Aspidium montanum.
 Epiphegus Virginianus.
 Panicum barbatum.
 Quercus ambigua.

ART. XIX.—*Effects of Lightning upon the packet ship New York*; by Mr. CHARLES RICH, at the request of the editors.*

UPON my first visit to Liverpool in May, 1827, the vessel in which I arrived was moored in Prince's dock along side the packet ship *New York*, Capt. Bennett. This ship I repeatedly visited, and indeed was obliged to cross her deck to reach the wharf. Having been informed that she had been injured by lightning during her passage, I examined her several times, and the following are the main facts that I remember.

The ship sailed from New York in April, and on the third day out, being the 19th, while in the Gulf Stream, in lat. $38^{\circ} 9' N.$ and lon. $61^{\circ} 17' W.$, was struck by lightning at about daylight in the morning. The passengers being still in their berths, were roused by a heavy report like that of a cannon close to their ears, and the cabin was filled with a dense smoke smelling like sulphur. It had been broad daylight, but was now almost dark as night. Rain fell in torrents—hail covered the deck; the lightning and thunder were almost simultaneous; the sea ran very high, and the water being at $74^{\circ} F.$ and the air at 48° , the copious evaporation produced pillars of condensed vapor reaching to the clouds. The scene was one of terrific sublimity. Some parts of the ship and spars were for a moment on fire, but were quickly extinguished by the rain.

The fluid first struck her main royal mast, burst asunder three stout iron hoops with which it was bound, and shattered the mast head and cap. It passed down the mainmast, one branch entered a store-room and demolished the bulk heads and fittings; thence it went into the cabin, and conducted by a lead pipe passed out through the ship's side between wind and water, starting the ends of three five inch planks. During its progress it burst open the harness casks, shivered to pieces the large looking glass in the ladies' cabin, and being conducted by the quicksilver on the back, it left the frame uninjured; it overturned the piano forte, split into several pieces the dining table, and by its influence so highly magnetized the chronometer as to render it during *that* passage not trust-worthy. Most of the watches

* With additional facts selected by the editors from the full account published in *Liverpool*, May 12, 1827, and quoted in the *New York Spectator*, June 20, 1827.

which were under the gentlemen's pillows were so highly magnetized as to stop them, and render it necessary to remove all the steel work. The gentlemen themselves were, without exception uninjured, owing doubtless to the non-conducting properties of the beds upon which they were sleeping. At the time the ship was struck, the lightning conductor had not been put up; but it was immediately after the accident raised to the main-royal-mast head.

The conductor consisted of an iron chain with links one fourth of an inch thick and two feet long, turned into hooks at each end; at top it ended in an iron rod half an inch thick and four feet long, having a polished point and rising two feet above the mast head; the chain descended down over the quarter, and being pushed out from the ship's side about ten feet by an oar, descended a few feet below the surface of the water.

Near 2 o'clock, P. M. it was observed that only four seconds intervened between the lightning and the thunder. At 2 o'clock there was a simultaneous flash and a shock like that in the morning; passengers in the cabin saw the appearance of a ball of fire darting before them while the glass in the round house came rattling down. To those on deck the ship appeared to be in a blaze, so vivid was the flash which they saw distinctly darting down the conductor and agitating the water. All parts of the ship as before were filled with smoke smelling of sulphur. Although the conductor was of the size which Dr. Franklin thought sufficient to sustain the severest shock of lightning without injury, yet it was literally torn to pieces and scattered to the winds, while it saved the ship. The pointed rod at the top of the conductor being fused, was shortened several inches and covered over with a dark coating; some of the links of the chain had been snapped off and others melted.*

The shock affected the polarity of all the compasses on board, causing them to vary from the true point and to range between each other, but they gradually returned within three points of truth. The chronometer of Capt. Bennett, the commander of the ship, which did not usually vary more than three seconds in crossing the Atlantic, was now quite out of time; it had gained

* It is said that the same thing once happened in a Dutch church in New York; a chain connected with the clock was melted and probably saved the church.

for a considerable period seven tenths of a second (in 24 hours,) and being 9m. 42s. *slow* of Greenwich time when the vessel left New York, was found at Liverpool to be 24m. 33s. *fast* of Greenwich, making a difference of 34m. 15s.

Three gold lever watches belonging to gentlemen passengers became so magnetized as to require that the principal part of the steel work should be removed. These parts had become true loadstones acting as magnets. It is in our recollection also that in other accounts published at the time it was stated that the knives and forks and other articles of steel and iron became magnetized. Happily no person was killed, although several were knocked down and more or less injured.

Remarks.—In consequence of receiving the notice* communicated by Mr. Rich, we have been induced to republish the principal facts in the case of the packet ship New York, although the events happened twelve years ago. The case was so remarkable, that the results ought to be preserved as part of the permanent records of science.

No case could more decisively prove the importance of conductors. Had the ship been furnished with the iron chain and rod at the moment of the first stroke it is almost certain that she would have escaped with little or no injury. Had the topmast which was then shivered (its stout iron bands two or three inches broad and half an inch thick being burst asunder) been protected, there can be no doubt that the lightning would have shot down the conductor, saved the mast, and passed harmlessly into the sea. This was decisively proved in the second case, when the ship was again struck at 2 o'clock, P. M.

Her iron chain was then up, and the pointed iron rod ascended two feet above the highest topmast. She appears to have been enveloped in a condensed electrical atmosphere; the clouds being so low that the flash and explosion were simultaneous; and had there been no conductor, the second stroke, which appears to have been more powerful than the first, might have proved fatal to many of those on board. The discharge which the conductor received seems to have been more than it was able to convey away; hence some of the people were prostrated although not killed; they were evidently affected mechanically by the explo-

* Of which a short account was published in this Journal, Vol. XXI, p. 351.

sion, and electrically by the all-pervading electrical atmosphere around, but not being made part of the chain of discharge they escaped with little harm. The conductor was melted at the top and glazed, doubtless with vitrified oxide, and the chain exploded in fragments all about the ship. This proves that the conductor, although it preserved the ship, was not perfect in construction or sufficient in size.

Hooks and chains are objectionable because the continuity of communication is interrupted by the intervening films of air. It were much better to adopt the rope made of twisted copper wire. It might be made of any desired size, and having perfect continuity, there would be no interruption to the passage of the electricity. Being perfectly flexible, it might easily be coiled and stowed away like any of the rigging, and it would adapt itself to any flexion of the spars and masts. It should be terminated above by a solid pointed conductor of copper or iron. Such a protection as this we can hardly doubt would prove sufficient, although in the case of very long ships it might be proper to have more than one conductor. In steam ships there is an additional protection derived from their vast metallic apparatus which by its communication with the water affords the best possible channel of discharge.

It is true that some years ago an explosion occurred in Charleston harbor, in the boiler of the Savannah steam packet, from her being struck by lightning; caused possibly by the sudden expansion of the steam already generated, or the sudden generation of more steam by the intense heat. In conversation with the late Mr. Samuel Howard in whose charge the boat was at the time, he distinctly attributed the explosion to the lightning.*

In the case of steam ships it may therefore be prudent to pass the conductor directly into the water and not to the boilers or other metallic apparatus; although we should hardly expect any mischief, especially in the Atlantic steamers, whose amount of conducting surface is so prodigious. Every thing however goes to prove that all ships, especially ships for passengers where the risk of life may be great, should be provided with the best metallic conductors.

Another fact which is remarkable in the case of the packet ship *New York*, is the energetic magnetism that attended the light-

* He was a gentleman of uncommon intelligence and good judgment.—SEN. ED.

ning ; chronometers, common watches, and compass-needles being all (by the lightning) rendered erratic and dangerous guides, no longer to be relied on. We conceive that good conductors would probably prevent or greatly mitigate even these effects ; but as it may not be possible entirely to shun the effects of electricity, and as it is of the utmost importance that the compass-needle should always be correct, we venture to suggest a remedy.

Let every ship be provided with a small calorimotor and the appendages of helix-wires, acids, &c. With this apparatus the needles could be instantly restored or new ones (unmagnetized and carried for the purpose) may be magnetized with certainty and with all requisite energy and dispatch. Practical directions can easily be given if desired.

New Haven, September 9, 1839.—E^Us.

ART. XX.—*Report on the Shooting Stars of August 9th and 10th, 1839, with other facts relating to the frequent occurrence of a meteoric display in August ;* by EDWARD C. HERRICK, Rec. Sec. Conn. Acad.

THE present year has contributed additional strength to the probability of the annual occurrence of a season of meteoric abundance about the 9th and 10th of August. The state of the weather, and other causes, have rendered it impracticable to observe at this place the course of the phenomenon as thoroughly as was desired, yet there has been ample opportunity to ascertain that at the expected time shooting stars were uncommonly abundant. Arrangements were made to secure observations during this season at numerous places far and near, but at this early date few returns are to be expected.

1. *Observations at New Haven.*—The evening of the 1st of August, 1839, was clear. I watched from 9h. 30m. to 10h. 10m. P. M., and saw but *one* meteor.*

The night of the 2d was overcast as late as 11h. P. M. The night of the 3d was clear, and several meteors were casually seen. On the night of the 4th, Mr. C. P. Bush and myself watched from

* I have been informed that on the evening of July 31, meteors were much more numerous than common. Perhaps they will be found unusually frequent about the 23th or 30th of that month.

9h. to 11h. P. M. The sky was cloudless, but somewhat hazy. In two hours we saw 36 meteors as follows:—

From 9h. to 10h. in s. 4, N. N. E. 9, = 13
 “ 10h. to 11h. “ s. s. E. 13, N. 10, = 23—About three fourths of these might be traced back to the vicinity of Cassiopeia.

The evening of the 5th was mostly clear. We made no continued observation; but several shooting stars of unusual splendor were accidentally seen. Two persons who were abroad about 1 A. M., of the 6th, were attracted by the frequency of meteors, and counted them for about ten minutes, at the rate of one per minute. The night of the 6th was overcast. The evening of the 7th was partly clear up to 11h. 30m. Before 9h. several meteors larger than Sirius were noticed by various persons. Mr. A. B. Haile watched from 9h. 30m. to 11h. 30m., and saw *twenty-one*. The evening of the 8th was overcast. At 1 A. M. of the 9th, I found it clear. From a window, I watched a small segment of the heavens in the N. for ten minutes, and saw five meteors. The sky then suddenly clouded and rain soon followed. The night of the 9th was clear, and every way favorable. Messrs. F. Bradley, C. P. Bush, A. B. Haile and myself, watched for five hours, and observed in all *six hundred and ninety-one* different meteors as follows:—

	N.	E.	S.	W.	Total.
9h. 7m. to 10h. P. M.,	7	28	9	14	58
10h. “ 11h. “	17	44	16	24	101
11h. “ 12h. “	21	62	25	37	145
0h. “ 1 A. M. (10th,)	38	50	36	35	159
1h. “ 2h, “	31	69	35	59	194
2h. “ 2h. 7m., “	6	9	6	13	34
					691

The meteors were increasing in frequency when we left the field, and had we continued observation until 4 o'clock, we should doubtless have seen in all more than a thousand. Several of the meteors were as brilliant as Venus. About one third surpassed in brightness stars of the first magnitude, and a larger portion than this left luminous trains. We noticed nothing peculiar as to the duration of their flights: few of them exceeded half a second. About 1h. 50m. (A. M. 10th,) a fire ball, much superior in splen-

dor to Venus, fell almost vertically in the S. S. E., and suddenly, when at the brightest, disappeared near Fomalhaut. It traversed an arc of about 20° , and was remarkable for its great magnitude, its brilliant train, and its golden green light.*

The night of the 10th was also very favorable. Prof. Stanley, Messrs. Bush and Haile, and myself, watched for three hours, and saw during that time, *four hundred and ninety-one* different meteors as follows:—

	N.	E.	S.	W.	Total.
10h. to 11h. P. M.,	25	35	30	33	123
11h. to 12h. P. M.,	50	44	36	59	189
0h. to 1h. A. M., (11th,)	32	44	51	52	179†
					491

As to general characters the meteors were similar to those of the night preceding. Several of the most splendid ones were on both nights seen before we commenced observations. On the evening of the 10th, two were plainly seen a few minutes after 7 P. M., while the daylight was quite strong. About 11 P. M. we saw one low in the N., which after traversing an arc of about 5° , flashed out with greenish blue scintillations, of dazzling brilliancy. The train remained in sight from 18 to 20 seconds after.‡ Mr. E. P. Mason, who was using the large Reflector, for several hours on both nights, saw during that period, about twenty meteors, less brilliant than stars of the seventh magnitude, (and of course invisible to the naked eye,) passing across the field of view. When we left our station, soon after 1 A. M. of 11th, the meteors were becoming a little more frequent; but owing to fatigue incurred the day previous, and to the expectation of a watch

* Several of the meteors showed a greenish tinge. Meteors wholly green have been sometimes observed. One is described by B. D. Silliman, Esq., in this Journal, vol. xiv, p. 199.

† Owing to an interruption of the observations, several meteors were during this hour, lost in the N. and W. quadrants: probably as many as 20 in all. The apparent diminution is therefore not real.

‡ The permanence of some meteoric trains is truly astonishing. They are occasionally seen to remain as long as thirty seconds after the extinction of the meteor. On the morning of November 14th, 1833, trustworthy observers, who were then in about lat. 15° S., lon. 34° W., saw among other meteors one at 1h. 40m. A. M., whose train continued visible *four minutes*. During the meteoric shower of November, 1833, the train of a large fire ball is said to have been seen nearly or quite fifteen minutes.

on the nights following, we thought best to retire. The time of the greatest abundance cannot be determined from our data; but there is reason to presume that it occurred after three o'clock in the morning. It ought to be mentioned that at our station, the sky around the horizon was somewhat obstructed, so that probably a tenth or fifteenth part of the meteors which might have been seen above our horizon, were concealed from view. The *radiant* of the meteors, being a matter of great importance, received our special attention. It would have been more satisfactory if we could have determined it by marking, on a celestial map, the track of each meteor; but this we could not do without losing great numbers. During the whole period of observation this subject was in mind, and each morning, after we ended the enumeration, we devoted several minutes solely to this purpose. The radiant was, as we have heretofore seen, not a definite point, but a region comprehending several degrees. During both nights the *centre* of radiation was not far from the cluster of stars in the sword-handle of Perseus. About 1h. A. M. of the 11th, we considered the centre to be nearer θ Persei. We did not notice during the two nights, any very perceptible change of radiant with regard to the fixed stars.*

The nights of the 11th, 12th, and 13th, were too cloudy to permit observation. The evening of the 14th was clear. Messrs. Bradley and Haile, and myself, watched from 10h. to 12h. P. M., and saw seventy-two meteors as follows:—

10h. to 11h. P. M.	N. N. E.	9	s. by E.	10	N. W.	9	=28
11h. to 12h.	"	13	"	16	"	15	=44

Of these, about 15 equaled stars of the first magnitude. The radiant was less definite than on the nights of the 9th and 10th, but nearly in the same region of the heavens. At midnight the sky was becoming cloudy. The nights of the 15th, 16th, 17th, and 18th, were almost wholly overcast. On the night of the 31st, I watched in the N. N. E. from 8h. 55m. to 10 P. M., and saw *seven* meteors. Most of them might be traced back to a region between Cassiopeia and Perseus.

* It is worthy of mention, that a faint Aurora Borealis was visible during our observations on the night of the 10th. It was seen also on the 28th and 31st.

2. *Middletown, Ct.*—Mr. L. L. Knox, of the Wesleyan University, has communicated to me the following particulars. “On the evening of the 10th of August, 1839, I commenced my observations at 9 o’clock; I had however seen four meteors in the west before this. The following were the hours of observation and the number of meteors seen during each.

9h. to 10h. P. M. between S. and W.,	31 meteors,	=31
10h. to 11h. “ “	41, and 2 in E.	=43
11h. to 12h. “ “	45, and 2 in N.E.	=47
3h. to 4h. A. M. (11th,) various quarters,	66,	=66

From 9h. to midnight, my attention was directed almost entirely to the S. W. I turned my eye a few times to the N. E. and saw four meteors in that direction, as stated above. With a few exceptions, these meteors seemed to converge nearly, to a point in the Milky Way in the S. W., 10° or 15° below the horizon. Their directions would not cross each other in a *single point*, but would intersect within a space of 4° or 5° . The paths of a very few were nearly at right angles to the general direction. Between 11 and 12 o’clock, only ten were seen the first half hour. They increased so much that the next half hour produced 37. I retired at midnight, and rose in season to recommence observations at 3 A. M. of the 11th. During the first 35 minutes I saw *fifty*, but as the morning light increased, the number of meteors diminished so much that only 16 more appeared before 4 o’clock. At 3h. A. M., the place of convergence had descended so far below the horizon, that I directed my attention to the point of divergence, which was now but little to the N. E. of the zenith. The meteors appeared to radiate still from the same place in the heavens, and moved in all directions from this point. The meteors were generally very brilliant. Three which I saw in the S. W. between 11h. and 12h., were equal in brilliancy to the planet Venus. About 15 minutes before 11h., while looking towards the S. W., I observed a bright flash on surrounding objects, exactly similar to a faint flash of lightning, which at first I supposed it was, but it soon occurred to me that it must have been a meteor. I immediately turned to the N. E. and saw the train it had left, still quite brilliant, and it was several seconds before it entirely disappeared. The train was short, and lay in

a horizontal direction, directly west from the point of divergence.*

“Professor Smith requests me to say that he saw 23 meteors in N. E. and E. between 9h. 30m. and 10 P. M. and 9 or 10 after 10 o'clock. The point or rather *space* of divergence he places near *Algenib* in the constellation Perseus.”

3. *New York City*.—Mr. Charles Baldwin writes me as follows:—“About 9 P. M. of the 10th Aug., I saw several meteors in quick succession; and walking on, I met a friend who had been abroad for about an hour previous, during which time he had counted upwards of 40 meteors. Between that time and half past 10, I observed for about 30 to 45 minutes; my field of view being from the N. by way of the E. to the S. E. In that time I counted 36 meteors, many of which left long luminous trains behind them. They moved almost universally in a southern direction.”

4. *Niagara, N. Y.*—Mr. W. C. Redfield of New York, has favored me with the following memorandum. “On the evening of the 10th of August, 1839, about 9 o'clock, being at Niagara Falls, my attention was arrested by several brilliant shooting stars which successively crossed the heavens. This led me to recollect that it was one of the periods at which their recurrence was expected, and on giving my attention for a part of the time between 9 and half past 10, I saw many of these meteors, differing from each other in brilliancy and apparent magnitude, but all passing in a southerly direction. One of great brilliancy passed to the west of south, and was lost to me behind the roof of the hotel. My estimate of the probable number that might be seen by constant observation, was an average of one per minute; but in one instance three or four were seen in less than a minute.”

5. *Philadelphia, Pa.*—Mr. Azariah Smith, Jr., has published in the “Public Ledger,” an account of the observations made by him at Philadelphia, of which the following is an abstract. The number of meteors seen between 10h. P. M. of the 9th and 1 A. M. of the 10th, by one observer watching only half the time, was about 50. The position was unfavorable, viz. in the street,

* Mr. Knox has minutely described the apparent position of this meteor, which was probably identical with the brilliant one we saw about the same time, but unfortunately we did not fix its place with sufficient precision, to enable us to determine its altitude, size, &c.

or at a third-story window of a building in the city, the houses on the opposite side of the street being one story higher. Seven meteors were seen between 11h. 55m. and 12h., four of which fell in one minute; and in two other instances three were seen to fall in the same time. At least four fifths of the whole number seen had manifest trains, and one fourth of these were unusually brilliant, and varying from 10° to 20° in length. We were unable to fix upon the radiating point until 11 o'clock, when it was in the breast of Cassiopeia; at 12 it was near δ Cassiopeiæ, and at 1 near the tail of the Camelopard. At none of these times, however, was the radiant an exact point; and twice the routes of two meteors were observed to cross each other, in the first case at 2° , and in the last at about 4° from their origin. Four or five of the 12 seen before 10h. P. M. seemed to come from near the body of the Swan; and two or three of those observed after this hour must be set down as unconformable, since although they came from the Northern part of the heavens, they could not be traced to the radiant region of the others.*

On the 10th I commenced observations with a friend, from the top of a building, at 8h. 20m. P. M., and although both looked in the same direction, (N.) we saw 36 meteors between that time and 9 o'clock. From 9h. to 9h. 15m. the number seen was 13, while in the half hour succeeding, only 19 were observed.

At this time we began to observe in different portions of the heavens, and before 10h. we saw six in the N. and seven in the S. In the next fifteen minutes, ten were seen in the same manner, when we retired to our room; after which, and before 11h., twelve were seen through a window opening towards the north; the whole number seen after 8h. 20m. being ninety-three. These, with the exception of not more than 13, were visible to one observer, and we have consequently *eighty* left as the number observed in 2h. 40m., or an average of 30 per hour, which is about six times the number ordinarily seen in an hour by one observer. The trains left by the meteors were less brilliant than on the 9th. The region of radiation was not as clearly circumscribed as on the evening of the 9th, and at half past 8, was in the same situation as it was on that evening at 11. It appeared to move slowly in the same direction, and when we ceased our observations, had

* Doubtless some were unconformable; but as we see only the position of the *plane* in which the meteor moves, its real direction may in some cases be nearly opposite to its apparent course.

apparently advanced about the same distance. We would suggest the query, whether these meteors do not generally come from a belt of the heavens, rather than from a circumscribed spot.

Several persons have remarked to us that more than an ordinary number of meteors were seen on the evenings of the 7th and 8th, but no definite observations were made.—*Ledger, Aug. 13, 1839.*

6. *Mississippi and Ohio Rivers.*—Mr. Forrest Shepherd of this city, who was travelling from the 3d to the 12th of August last on the Mississippi and Ohio, made during that period such observations for meteors as his circumstances permitted, and with the following general results. During the nights from 3d to 6th, inclusive, the number of meteors was greater than usual. On the 7th, the number was somewhat diminished. From the 8th to 10th, inclusive, meteors were much more abundant, and attracted the attention of unconcerned persons. On the 12th he made no observation, and on the next night he found that they were becoming less frequent.

7. *Pensacola, Florida.*—Mr. E. Fitch, Prof. Maths. U. S. N., has sent me an account of some brief observations which intervals of clear sky permitted him to make about the 9th of August. His letter not being at hand, I can here only state that during the early part of the night, at that epoch, it did not appear that meteors were unusually numerous, but after midnight they were rather more frequent than common. At *Claiborne, Ala.*, the state of the sky prevented the observers at that place from obtaining any satisfactory view.

8. *At sea, lat. about 44° N. ; lon. 46° to 44° W.*—Prof. C. U. Shepard expected to observe, (on his passage to London in the steamship *British Queen*,) the meteors which might appear on and about the 9th of August. I have this day learned from him that all the evenings, from the 9th to the 13th, inclusive, proved unfavorable. “On the evening of the 7th, several meteors were seen, one of which, at 11h. 5m. P. M., was very splendid, and illuminated the northern quarter of the heavens for at least *one minute*.* Capt. Roberts informed me the next day that between midnight and 4 A. M., (of the 8th,) he was struck by the number of shooting stars. He was decidedly of opinion that they were more frequent than common.” On the evening of the 8th, it did not ap-

* From this it may be inferred that the *train* of the meteor remained in sight for one minute.

pear that they were more numerous than usual, but there was no systematic observation. For five days subsequent to this, the weather was unpropitious. I am indebted to Prof. S. for the following extract from the London Globe of Aug. 20, 1839.

9. *Brussels, Belgium.*—“*Falling Stars.*—During the nights of Friday and Saturday, the 9th and 10th of August, the heavens were bestrewed with little falling stars of extraordinary brightness. Mr. [T. ?] Forster counted above 600 of them. It is not a little singular that the peasants of Franconia and Saxony have believed for ages past, that St. Lawrence weeps tears of fire, which fall from the sky every year on his fête, (the 10th of August.) This ancient popular German tradition or superstition has been found, within these few years, to be a fact which engages the attention of astronomers. The inhabitants of Brussels can bear witness that on the night of the 10th, this year, St. Lawrence shed abundance of tears.—*Brussels Paper.*”

Remarks.

It is evident from the observations above detailed, that on the nights of August 9th and 10th, 1839, shooting stars were much more abundant than usual; and it will probably not be doubted that they were also unusually numerous, but to a less degree, during a few days previous and subsequent to that time. At this place, (and probably in all parts of the globe having about the same or a higher northern latitude,) the number seen during these two nights was at least four or five times greater than the yearly average. This average is not yet settled with much exactness, but from several observations made here, it seems improbable that it exceeds 30 per hour for four observers. On the night succeeding July 16, 1839, Messrs. Bush and Haile, and myself, observed for three hours, ending at 2 A. M. of the 17th, with special reference to a comparison with August 9th and 10th. We saw in all 74 meteors; adding to this number a third part, we have nearly 100, or an average of 33 per hour for *four* observers. The time of night at which the meteors were most frequent, was, probably, as appears by the observations of Mr. Knox, at Middletown, later than 3 A. M., at which time the radiant was not far from the meridian. The place of the radiant as determined here, differs but little from the mean of the observations made in this country in August, 1838, (this Jour., vol. 35, p. 169, etc.,) but it cannot be considered as settled with all the precision which may be hereafter attained.

It will be noticed that its centre is about 40° N. of the point in the ecliptic, towards which at that time the earth's motion is directed, but differs little from it in Right Ascension. It will also be remarked, that the radiants of the meteors of August 9 and 10, and of December 6 and 7, (1838, this Jour., vol. 35, p. 364,) are in the same region of the heavens, and that at the former time the earth is moving towards a point about 117° from the place towards which its motion is directed at the latter season. It remains to be ascertained what is the position of the radiant as observed in southern latitudes; if indeed meteors are found to be unusually abundant there at this epoch, which is somewhat doubtful.

Further Observations on the Meteors of Aug. 9th and 10th, 1838.

1. Professor Barnard of the University of Alabama, *Tuscaloosa*, in an article published in July, 1838, in "The Flag of the Union," at the place just named, invited the attention of the southern public to the meteoric season expected during the August ensuing. At the appointed time the weather was generally very unfavorable for observation. In a communication to the above-mentioned paper of Sept. 12th, 1838, Professor Barnard remarks, "During the entire night of the 9th—10th ult., the sky was heavily overcast, the greatest rain of the month having occurred on the evening of the preceding day. Clouds very much obscured the heavens on several nights previous. Nevertheless, I observed an unusual number of *remarkably bright* meteors, though nothing which could be denominated a shower. The same was the result of observations continued through the two succeeding nights, though the heavens were then clearer. I have heard but from two places in the south which enjoyed an unobscured sky on the night of the 9th—10th. In those places quite an unusual number of meteors was observed, amounting in one place to more than fifty in half an hour before midnight."

2. The Lond. and Ed. Phil. Mag. Oct. 1838, contains observations by M: A. Quetelet at *Brussels*; and by Messrs. E. J. Cooper, L. F. Wartmann and others at *Geneva*. (1.) At *Brussels* the night of the 9th Aug. was overcast. Night of 10th partly clear; three (?) observers saw from 9h. 15m. to 10, 16 meteors; from 10—11, 29; from 11—11h. 50m., 39; afterwards cloudy. Night of 11th, four observers saw from 9—10, 34 meteors; from 10—11, 19; from 11—12, 24; from 12—1, 32; from 1—2, 12; from

2—2½, 10. M. Quetelet remarks that their general direction was from N. E. to S. W.; and if the sky had been clear, many more would doubtless have been seen. (2.) At Geneva, during the night of the 10th, six observers saw from 8 P. M. to 4 A. M. (11th,) 380 meteors. Mr. C. states that the meteors did not appear to come from a common focus; but the details which he gives, correspond substantially with the account of their direction given by Quetelet. On the night of the 11th, meteors were nearly as abundant as on the 10th. M. Wartmann, in his account of the same observations, (*Bib. Univ. Août, 1838,*) adds, that—(3.) At Planchettes, Switzerland, M. Reynier, observed alone, between 9 P. M. of 9th and 2 A. M. of 10th August, *sixty-three* meteors; and on the night succeeding, from 8½ P. M. to 2 A. M., *one hundred and four*. (4.) At Vienna, (as appears by a note in L'Institut, No. 261, Dec. 27, 1838,) M. Littrow (with how many assistants is not stated) observed at the August epoch in 1838, with the following results. On the 7th and 8th, meteors were counted at the rate of about 6 per hour; 9th, 15 per hour; 10th, 60 per hour; 11th and 12th, about 30 per hour. It was then cloudy until 18th, and the mean number seen during the clear intervals was 10 per hour.

It must be remembered, that on this occasion the light of the moon greatly interfered with the observations, concealing, probably, full half of the meteors which might have been seen in her absence.

Additional facts concerning the Meteoric season of August.

During the year past, the following additional evidence has come to my knowledge.

(1.) In a letter to Dr. Rush, dated Northumberland, Pa., May 4th, 1801, Dr. Joseph Priestley makes the annexed statement, which, although expressed with singular indirectness, doubtless refers to a very considerable display of shooting stars. "Also on the eighth of August last, I was called out of my house to observe a singular kind of lightning; indeed, it was more of the nature of a meteor than of lightning; for the flashes were of some continuance, and many of them threw out a prodigious number of balls of fire. One of these *streams* of lightning, for they could not well be called *flashes*, very much resembled a rocket. It arose from below the horizon, and extended beyond the zenith; and there came from all the parts of it, in every direction, small

balls of fire, which, by a common optical deception, seemed to be connected with their source by fine strings of fire. They went to some distance and then vanished. It was a magnificent fire-work. Those flashes, some more and some less remarkable, but all differing from common lightning, continued for a long time, and I doubt not, were of the nature of meteors."—*Medical Repos.*, 8vo. N. Y. vol. 5. (1802.) pp. 33, 34.

(2.) I am indebted to Prof. Olmsted, for the following facts recently communicated to him by an officer of the U. S. Navy, who made the memoranda at the time.

"August 8, 1836. I have observed for several nights past, an unusual number of shooting stars, darting towards all parts of the heavens.

"Lat. at merid. $34^{\circ} 45'$ N. Long. $174^{\circ} 49'$ E. of Greenwich.

"August 9, 1836. Saw more brilliant meteoric appearances last night; one of them left a train similar to a rocket.

"Lat. at merid. $33^{\circ} 49'$ N. Long. $177^{\circ} 10'$ E. of Greenwich.

"August 11, 1836. Last night I again observed an unusual number of brilliant meteors, and I find that the officers have noticed the same in their watches.

"Lat. at merid. $31^{\circ} 27'$ N. Long. $179^{\circ} 50'$ E. of Greenwich."

It will be remembered that unusual numbers of meteors were seen in this country about the same time, by Prof. Joslin and others. (This Jour. vol. 33, p. 178.)

(3.) Chladni, (über Feuer-Meteore, etc. 4to. Wien, 1819,) after referring to the meteoric showers of 533, 763, 1096, 1798 (Dec. 6,) 1799 (Nov. 12,) adds, "On the evening of the 10th of August, 1815, also, as I have been assured by a trustworthy observer, there must have appeared a very large number of shooting stars." p. 89.

(4.) In "A History of the Proceedings of the Board of Health of the city of New York in the summer and fall of 1822," (8vo. N. Y. 1823, pp. 270,) Dr. Richard Pennel remarks, "On the night of the 9th and 10th, (of August, 1822,) I observed a number of shooting meteors." p. 227.

(5.) In Long's Expedition to the Rocky Mountains, (2 vols. 8vo. Phil. 1823,) vol. 2. p. xlviii, under date of Missouri, August 13, 1819, appears "Night, meteors shooting to the North." This extract and the one next preceding, are too indefinite to be of much consequence, but they are perhaps worth quoting in this connection.

Former knowledge of the Meteoric epoch of August.

The annual occurrence of a meteoric display about the 10th of August, appears to have been recognized for a very great length of time. Below will be found some of the facts connected with the history of this subject: more can doubtless be collected by those who have access to extensive libraries.

1. According to Mr. T. Forster, a superstition has "for ages" existed among the Catholics of some parts of England and Germany, that the *burning tears* of St. Lawrence are seen in the sky on the night of the 10th of August; this day being the anniversary of his martyrdom. Quetelet, in *L'Institut*, No. 222, p. 395;—*ante*, p. 333.

2. In the curious descriptive calendar subjoined to Forster's *Pocket Encyclopedia of Natural Phenomena, &c.*, (London, 1827, 12mo.,) the 10th of August is characterized by the word METEORODES. M. Quetelet, (*Institut*, 222: 395,) states that it appears to have been composed by a monk towards the close of the last century, and that the manuscript (entitled *Ephemerides Rerum Naturalium*) is preserved in Corpus Christi College at Cambridge. M. Arago (*Comptes Rendus*, 1837, 2d. sem. 850,) remarks, that it is probably as old as the close of the 17th century. If it has suffered no modern alterations, it may be presumed that it was made since the introduction of the Gregorian style in 1582.

3. A native of Thessaly has informed me that an ancient superstition is prevalent among the inhabitants of "the 24 towns of Bolos," around Pelion in Thessaly, to this effect, viz., that on the night of the feast of the Transfiguration, (Aug, 6,) the heavens divide, and lights (*καινθήλια*) are seen through the opening. It is quite probable that the meteoric season of August will supply the interpretation of this belief. The day being in Thessaly the 6th of August, old style, corresponds now to the 18th of our calendar. If, however, in order to reduce this to our 10th, we carry back the origin of this tradition ten or twelve centuries, we encounter a difficulty arising from the probability, that at this remote period the display occurred several days earlier than at the present time.

4. M. Quetelet (in a paper read Oct. 7, 1837, before the Royal Acad. of Brussels; *Institut*, 222: 395,) has pointed out a passage in the *Introductio ad Philosophiam Naturalem* of Musschenbroek, (1762, 2 vols. 4to.,) which reads thus: "Stars are seen to

shoot chiefly in the month of August after a hot time, at least in Belgium, Leyden, and Utrecht." t. ii, p. 1061.

5. In Forster's Encyclopedia before quoted, under date of August 10th, in the Rustic Calendar, it is distinctly affirmed, that "Falling stars and meteors most abound about this time of year."

6. Dr. James Eights, in the "Naturalist's Every Day Book," (*Zodiac*, vol. 1, p. 44, Albany, 1835-6,) under date of August 22, 1835, remarks: "Meteors and falling stars have been quite common for the last few weeks, and this is the month in which it is generally believed that they most commonly occur: and they were very numerous to night."

7. M. Quetelet, at the session of the Royal Academy of Brussels, Dec. 3, 1836, announced his belief, that shooting stars were unusually numerous about the 10th of August. In consequence of his efforts, observations at the next occurrence of that season were made in various parts of Europe, and as is well known, the result verified the prediction. The attention of the writer of this was first attracted to the subject, by the display *accidentally* observed here on the night of August 9, 1837.

A few references, by various writers, to the occurrence of meteors in August, but all of them pertaining to years which have been already noticed in this Journal, might be mentioned here. None of them, however, appears to recognize the periodicity of the phenomenon.

New Haven, Conn., Sept. 11, 1839.

ART. XXI.—*Description of a New Species of Liatris*; by DAVID THOMAS.

SPECIFIC CHARACTER.—*L. flexuosa*. Stem flexuous. Leaves few; upper lance-linear, semi-amplexicaul Peduncles from the upper axils, bracted, supporting one flower.

OBSERVATIONS.—*Root*, tuberous. *Stem*, a foot high, simple, smooth, striate. *Leaves*, 12 to 15, clasping the stem half round, acute, nerved; ciliate near the base, slightly pubescent on the upper surface, smooth beneath. Lower leaves linear, somewhat tapering towards the base, from 6 to 10 inches long, but shortening from the middle of the stem upwards, until the upper

leaves become lance-linear, resembling bracts. *Flowers* from 2 to 10, pale red-purple. *Involucre* with about 15 florets.

I have cultivated this plant two years: it increases in size and height. From one root, four stems have arisen more than 22 inches high; but of a dozen plants which I gathered in a state of nature, no root had more than one stem.

HABITAT.—East bank of the Niagara river, below the Falls. **Flowers** in the eighth month, (August.)



Liatris flexuosa.

ART. XXII.—*Observations on the New Haven Tornado of July 31, 1839*; by DENISON OLMSTED, Professor of Natural Philosophy and Astronomy in Yale College.

ON the 31st of July, 1839, there occurred, on the western skirts of the city of New Haven, a tornado of the most violent class. The preceding morning had been cloudy and sultry, and immediately previous to the tornado, a thunder storm seemed approaching from the west, attended by some appearances of high wind. I was, at the time, about a mile eastward of the track of the storm, observing the phenomena from my chamber window. The clouds betrayed that singular agitation, which usually forebodes a hurricane, and the vane of a neighboring steeple was constantly shifting its position. A short time before the tornado commenced, the wind blew fresh from the southeast, having been in this quarter during the preceding morning; it changed suddenly to the south, and in a moment more it was west, where it continued fixed. Accompanying these changes a heavy rumbling noise was heard, not unlike the passing of a long train of railway cars, which was audible in every part of the city.

Such were the only facts of importance which I had an opportunity of observing at the time; but the circumstances have proved unusually favorable for investigating the laws of the storm, occurring as it did at mid-day, and so near to us that we have been able to repeat our examinations of the grounds a number of times. Among those included within the limits of the tornado, were several accurate and intelligent observers, who remarked the phenomena with much attention; and even those who were buried beneath the ruins of their houses, have all survived to tell their story. In addition to these peculiar opportunities for ascertaining the facts respecting the storm, I have had the still greater advantage of comparing my own observations with those of my friends, Professor Stanley, Mr. A. B. Haile, and Mr. E. C. Herrick, all of whom have taken the greatest pains to investigate the phenomena and laws of the tornado. Hence the facts which I have to state, are, I think, the result of better opportunities for observation, and of a more elaborate and careful examination, than has been usual in storms of this class.

In order to make our descriptions intelligible to strangers, it may be proper to premise, that the city of New Haven is situated at the head of a bay, that sets up five miles from the north side of Long Island Sound. It is built on a plain which is bounded on the west by a low range of hills, called the Woodbridge hills. At the northwestern and northeastern angles of the town are the two celebrated bluffs, called West and East Rock, respectively, well known as the southern terminations of the chains of trap mountains, that extend northward through Connecticut and Massachusetts. The storm commenced in the low ground at the eastern base of the Woodbridge hills. Its course was N. E. by E. across a level region occupied by farm-houses, cornfields, and gardens for a mile and a half. It then ascended an inclined plane to a higher level, and passed through a wood towards East Rock. Bounding over this eminence, it descended its eastern declivity, and lost itself in an extensive salt meadow that lies eastward of the mountain.

Throughout this region its progress was indicated by marks of the greatest violence. Nearly every tree that came in its way through the open country, was prostrated or broken off; six houses, and a number of barns, were completely demolished; several other houses and barns were unroofed; fields of corn, then just earing, were laid close to the ground; and indeed, the whole space over which the tornado had passed, presented one uniform scene of ruin and desolation.

In *extent*, this tornado appears to have been very limited. Its length did not exceed four miles, and its average breadth was only sixty rods, varying however a little in different places. Its *duration* at any one place did not exceed half a minute, and its progressive motion may be estimated at 40 miles per hour. These estimates are made by comparing the impressions and statements of various individuals who were within the limits of the storm.

The appearance of the storm as it approached, was deliberately contemplated by numerous observers, who saw it coming over the plain. All describe it as a strange cloud, of terrific aspect, white like a driving snow-storm, or light fog, and agitated by the most violent intestine motions. It came suddenly upon them with torrents of water—"there was a rush—a crash—and it was gone." When first seen coming over East Rock, it seemed lifted above the ridge of the mountain, but fell nearer to the earth as it descended the eastern declivity, and renewed its work of destruction when it reached the plain.

Let us now trace more particularly those facts which have a bearing upon the laws which govern this storm.

1. The first great fact that strikes us, is, that all the trees and other objects that mark the direction of the wind which prostrated them, are with very few exceptions, turned inwards on both sides towards the center of the track; while near the center, the direction of the prostrate bodies is coincident with that of the storm.

2. On more minute inspection, we find prevailing a remarkable *law of curvature*. This is most favorably seen in cornfields, as the prostrate corn indicates the course of the wind at each spot, with great precision. The law is this. Commencing on the northern margin of the track, the stalks of corn are turned backward, that is, toward the S. E.;—proceeding towards the center of the track, their inclinations to the south become constantly less and less, turning gradually towards the course of the storm, until when we reach the center, they lie to the N. E., exactly in the line of the storm. This curvature is in all cases more observable on the northern, than on the southern side of the track. In the latter case, the stalks of corn lie more nearly at right angles to the course of the storm, (but inclining forward;) still, on reaching the center, they turn to the northeast, and become coincident with that course.

3. Numerous examples are seen where the bodies as they fell towards the center of the track, or after they had fallen, were turned farther round towards the direction in which the tornado was moving, that is, towards the northeast.

4. The ruins of buildings that were demolished, are scattered in nearly a right line towards the center of the track; but they frequently are strewed quite across the central parts, reaching, in some instances almost to the opposite margin. In this case, they are often found covered with trees, and other bodies lying in precisely the opposite direction.

5. In a few instances, very limited spots are found where the prostrate bodies, as hills of corn, lie in all directions. Examples occur where one portion of the same hill of corn is turned westward, and another portion eastward.

After these general statements we may now have recourse to the accompanying diagram, and review particular cases of the foregoing laws or modes of action. For this representation of

This diagram represents four successive sections of the storm, considerable intervals near the bounding lines of the sections, being omitted for want of room.

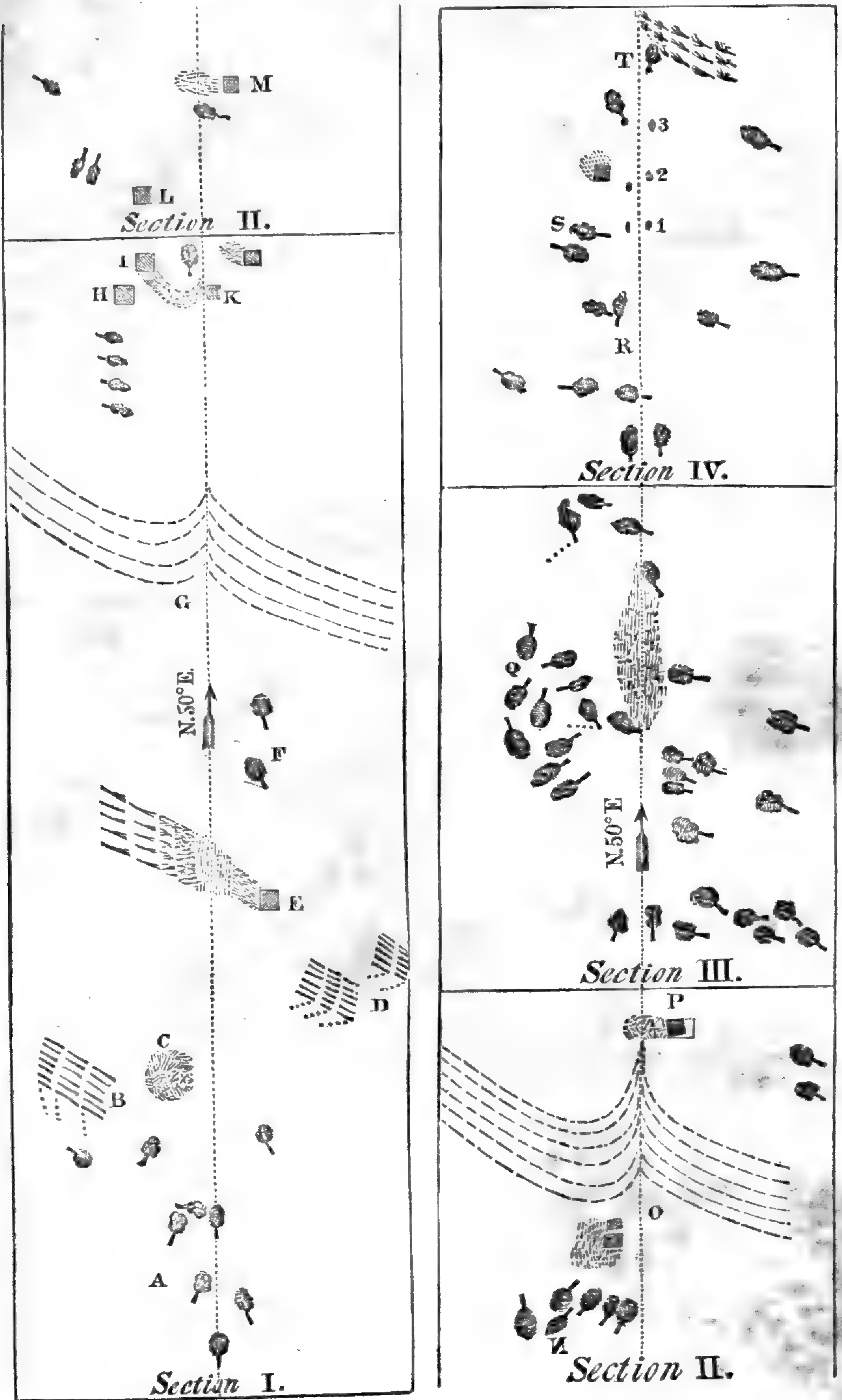

the phenomena of the tornado, I am indebted to Mr. A. B. Haile, who took the bearings of the various prostrate objects with a compass. In most cases, I have been able to attest the accuracy of the representations by actual inspection; and in regard to the few instances where my attention has not been particularly attracted to the fact represented, I entertain no doubt of the entire accuracy of the delineation.

The diagram commences at A, at a mulberry grove half a mile from the spot where the tornado first formed. The dotted line bears N. 50° E. It will be perceived that the trees which lie in the center of the track generally coincide with it, and that those which lie on either side are turned inwards towards the center. Yet several examples are seen, where trees lie pointing outward from the center, both in the middle and in the marginal portions of the track, as at N, Q, R and S. These exceptions moreover, are all on the north side of the track. Examples of the remarkable *law of curvature* referred to, are seen at G and O, where the figures represent the direction of stalks of corn in two fields nearly a mile distant from each other. It will be observed by the diagram, that from the margin the direction of the stalks inclines more and more inwards, and finally, in the center, coincides with the course of the storm. It is also obvious from the figure that this law is more fully developed on the left than on the right side of the track. The same tendency to this curve is exhibited in the scattered fragments of a roof at I.

The dotted lines connected with the figures of some of the bodies that were thrown down, as at B, D and F, show the position in which the bodies first fell, and from which they were moved round into the places they now occupy. In some cases a tree is seen to have commenced falling at right angles to the track, but during its fall to have been twisted round towards the course of the storm. Similar examples are found of limbs bent around the trunks of the trees from which they were partially severed.

At E are represented the ruins of a building which was completely demolished, and its fragments carried in a right line far beyond the center of the track. According to Mr. Haile, the fragments in the central parts of the track are arranged in parallel lines, coinciding with the course of the storm, while in places farther from the center, they lie promiscuously. In the parts

most remote from the building, the fragments are covered by corn thrown down in the opposite direction. A more striking example of the same fact, is seen near the eastern limits of the tornado, where the fragments of a roof are scattered towards the west, while a tree a few paces from the building, is turned directly towards the building, covering a portion of the fragments.

At C is represented a limited spot in a cornfield where the stalks lie in every direction. While in a few places, at distant points, particular spots seem to have been subjected to a peculiar violence, other limited spots exhibit a remarkable exemption from the effects of the tornado. In a garden near H, are a few rows of pole beans apparently untouched by the storm, while within a few feet on either hand, the most violent effects are exhibited. Near L, a barn was demolished, and a dove-cote scattered in fragments, while a hen-roost which stood feebly on blocks, was unharmed. Large trees in the immediate vicinity were torn up by the roots. A house that stood between I, and L, was completely torn in pieces, leaving nothing but the southern half of the ground floor. In the room of this floor, a woman was washing, and another was at work in a basement room immediately below, while her child was asleep in a cradle in a room above, at the northeastern angle of the house. They saw the tornado approaching; the woman in the basement ran up and caught her child in her arms, and immediately afterwards found herself and child in an open field a few paces north of the house, the child having been carried only a few feet from the spot where they were, while the mother was carried eighteen or twenty feet farther to the westward. The other woman meanwhile was swept off from the floor where she was standing and carried northward and deposited in the cellar, the floor of the northern half of the house having been borne away along with other parts of the building. None of the party were seriously injured. A bureau that was in the room where the woman was washing, was carried half a mile to the eastward, and portions of it were found sticking in the sides of a barn, having penetrated the thick wall of plank. A silk cape also was taken from this house, and carried over East Rock to the distance of three miles. In a barn that was blown down on the east side of East Rock, a boy that was on a load of hay in the barn, was transported across the street and deposited in a neighboring field unharmed.

In other cases, however, forces seem to have acted with great violence upon the individual parts of bodies. Numerous instances occurred where hens were completely stripped of their feathers. A wagon was taken up along with the shed in which it was standing. The shed was scattered in fragments, and the wagon was carried northward a hundred feet or more and dashed sideways against a barn, leaving a full impression of one of the wheels on the walls of the barn. Having here nearly reached the center of the track, it took a turn to the northeast and was deposited at the distance of several rods in an exceedingly mutilated state, the top having been carried off and not yet found, and the strong iron springs broken and bent in a manner that denoted an exceedingly violent action. No part of this violence is to be ascribed to the force with which it fell to the ground; for it must have fallen very gently, since the ground was scarcely broken at all. The same fact was observed in the cases of trees and other heavy bodies that were raised into the atmosphere and transported to a distance. They did not generally appear to have fallen with the ordinary force of falling bodies.

These forces which acted upon the individual parts of a body often appear to have acted in contrary directions. The legs of the same table were found deposited at the distance of many feet from each other in different directions; and this was true also of the hinges of the same door.

We examined diligently for evidence of an explosive force acting on buildings from within, in consequence of a sudden rarefaction of the air on the outside of the building, agreeably to what is reported of the New Brunswick tornado, and of other similar storms. We found but one case that favored such a supposition. This was the case of a barn where the walls were thrown out on every side, and without much apparent violence.

At T, near the center of the track, are exhibited two trees, each of which bounded along in the direction of the storm. The tree on the right was torn up at the place marked 1, and struck the ground successively at the points 2 and 3.

With the foregoing facts before us, we should naturally proceed next to the inquiries,—How was this tornado formed? Whence did it derive its violent intestine motions? What was the nature of these? Whence its progressive motion?

In order to obtain a correct answer to these inquiries, we ought to compare the facts exhibited in this storm with those of various other storms similar to this, as has been done by Mr. Redfield and Col. Reid in respect to the great gales of the Atlantic. I have not at present the leisure for such an investigation, but may possibly recur to the subject in a future number of the Journal.

MISCELLANIES.

FOREIGN AND DOMESTIC.

Notices of geological and other physical facts and of antiquities in Asia, from Sir Robert K. Porter's Travels in Georgia, Persia, Armenia, Ancient Babylonia, &c. &c., during the years 1817, '18, '19, and '20, with numerous engravings of portraits, costumes, antiquities, &c. In two 4to vols. London, 1821. Vol. I, pp. 720. Vol. II, pp. 869.

The splendid volumes whose title is cited above, are, we have reason to believe, little known to the reading public of this country. Being, from their size and their numerous graphic illustrations, very expensive, they are found in few of our libraries; and it was during a detention of some weeks in the spring of 1838 at Hanover, that we had opportunity to peruse a copy belonging to the library of Dartmouth College.

Although the book is out of print, we are assured that a copy may be occasionally obtained in England, and we venture strongly to recommend the work as a great treasure in all libraries, especially in those of colleges and other public institutions. We hesitate not to say, that these volumes form the most instructive, valuable and interesting book of travels which we have ever read. They are replete with the most important information, and from the numerous and striking proofs of the truth of the scripture history which are found in the places where the events occurred as well as from innumerable relics of ancient structures and of primitive manners which, after thousands of years, linger still in their native places, Sir Robert Kerr Porter's work leaves on the mind of the reader, and especially of the young, the strongest conviction that the Old Testament is true, and that therefore the New cannot be false. Sir Robert's mind seems to have been imbued with the highest reverence for the book of God, and he appears to be never more gratified than when he finds, as he often does, illustrations of its truth.

Being himself an artist, he enjoyed and enables his readers to enjoy the highest advantage of vivid graphic sketches, made on the spot, and thus his great work is rendered perfectly intelligible and highly impressive and delightful. He disclaims all skill as a writer, while his intellectual sketches vie with those of his pencil, and his eloquent and beautiful descriptions leave the strongest and most agreeable impressions on the mind.

In perusing his work we made short notes of subjects relating chiefly to physical facts and phenomena, and especially to geology. Although they were made merely for private reference, we have thought on a reperusal fifteen months from their date, after our first vivid impressions have subsided, that they may be useful to others cultivating similar fields of knowledge, and we therefore insert them under our miscellany. They are more condensed than they would have been had we selected them originally with reference to the present use, but, as we have no copy of the work we cannot revise them either for enlargement or for correction.

1. Vol. I, p. 75. THE CAUCASUS RANGE is described with the remarkable Pass of Darial on the river Terek, where there is a chasm of 1,000 feet high, while the general elevation of the mountain range is not less than 3,780* feet.

2. BASALT.—*In the valley are Basaltic Columns* arranged in huge masses over the surface of the mountain, and taking various directions; some shoot horizontally into its side, some stand in erect piles against it, and others incline more or less from the perpendicular; resembling the palaces, castles, temples, embattled walls, and other ruins of some vast antediluvian city.

This basaltic valley exhibits the most extraordinary features. It appears not only as already remarked like the ruins of some vast city, but on the top of one of its cliffs are the ruins of a real ancient tower, or castle, or temple, probably Roman.

The basaltic columns have sometimes serpent-like forms—twining together or radiating in a hundred points: others are again perfectly perpendicular, forming vast and sublimely pillared walls; or they are horizontal or traverse each other obliquely, or, perhaps tumble together in all directions—standing, lying, and leaning, composing the wildest and most picturesque combinations. The columns are in general pentagons, usually with the upper surface convex like those of the giant's causeway; texture close, color dark grey. In gene-

* Mount Elborus is the highest point being 16,700 feet above the sea level. Mount Kasibek is 14,400 feet; both are covered by eternal snow.

ral the masses shoot up from the valley vertically to the height of 300 to 400 feet; at the summit there is a short receding ledge of rocks sloping inwards, and thence springs a second wall of columns running up to the same height; then comes another slope and another wall and so on till these successions of terraces and basaltic superstructures terminate at the top of the mountain under a thick stratum of shapeless rock. Consequently the entire height of these groups or successions of columnar terraces must be from 1,000 to 2,000 or more feet high.

3. FLOODS.—*Immense floods*, arising from the thawing of the snows, throw down tremendous avalanches of rocks. There was a deluge in the Caucasus in June, 1776, when the water rose 258 feet; the depth of the snow rolled down owing to the fall of the peak of the Kasibek was 186 feet; it dammed the Terek for twelve days, when it burst away in an overwhelming torrent, resounding louder than thunder, and burying valleys, villages, and people under snow, ice, and rocky ruins.

4. HOT BATHS.—Near Tiflis (Geo.) the hot water is very abundant, feeding the baths; the temperature at their source is $42. R = 94\frac{1}{4} F$: the smell is sulphureous; there is a great number of baths frequented by all classes, and every thing about them is wet and dirty; the baths are excavated in the solid rock over which the water formerly flowed. In the female apartments there was no disguise; the females did not shrink from observation. At Elija, near one of the sources of the Euphrates, there is a hot spring where three or four buffaloes were enjoying the bath, and about fifteen or twenty boys were playing beneath them.

5. BOILING SPRING NEAR THE AKHOOR RIVER.—The spring issues from the ground with volumes of steam, wreathing in white clouds through the air.

6. ARARAT—EXTINCT VOLCANO NEAR MOUNT ARARAT.—There is no verdure, but universal sterility; all parts are covered with volcanic stones or masses like cinders, black, heavy and honey-combed, as if thrown from an iron-forge. A hill near Ararat is evidently an extinct volcano, although no author mentions any volcano near to this mountain.

From the plain below Ararat appeared “as if the hugest mountains in the world had been piled upon each other to form this one sublime immensity of earth, and rock, and snow. The icy peaks of its double heads rose majestically into the clear and cloudless heavens: the sun blazed bright upon them; and the reflection sent forth

a dazzling radiance equal to other suns. The eye, not able to rest, for any length of time, upon the blinding glory of its summits, wandered down the apparently interminable sides till their vast lines could be no longer traced in the mists of the horizon; when the eye was by an irrepressible impulse carried up again to fix its gaze upon the awful glare of Ararat." No one has ascended the peaks of Ararat, which is covered with eternal ice and snow.*

7. AN INTERNAL VOLCANO.—In the Courdish country there is a hill 250 feet high, with a rocky crater forty five feet wide at top and with a funnel-shaped hole, as wide as a well, and quite fathomless. Several stones thrown in produced no report; the natives said that the hole reached through to *Yankey Doonia*, i. e. *the new world*. A register kept at Eitch-mai-adzen for 800 years, makes no mention of any volcanic eruption.

8. SALT NEAR TABRIZ.—Salt is dug in the hills near this place, and the river Augi is perfectly salt.

9. SALT IN LAKE OROOMIA, about five days journey long.—This water contains one third more salt than the sea; the lake is hemmed in by a broad border or belt of salt looking at a distance like a violent surf (congealed); it is three or four miles wide, and one foot thick, or more in places where the shore shelves or gently slopes.

10. SALT MINE NEAR ERIVAN.—There is a salt mine in the hills; the revenue to the governor of Erivan is about £5,000 sterling. It supplies the neighborhood, and Turks and Georgians repair to it for immense loads; several hundred bullocks were at the time carrying it away in large slabs like alabaster. There are excavations in the mountain in vast galleries and caverns giving a dazzling reflection from the surface when any light strikes them; the salt has been wrought from the earliest times, gives great supplies, and is not yet exhausted.

11. SALT OF THE GREAT SALT DESERT.—Lat. 35° N. Long. 70° E.—There is a copious salt stream and over some hills is seen the salt desert, and east and southwest a vast region of sand reaching to the horizon. The large tracts of salt appeared in the distance, spotting the burning plain like so many shining lakes, one fourth of an inch thick and smooth as a mirror; the view was one of awful grandeur, connected as sandy deserts usually are with "consuming blasts, overwhelming sands and the burying of thousands of human beings."

* Sir R. K. P. thinks that the ark rested in the hollow between the two peaks.

12. **EARTHQUAKES AT TABRIZ.**—In 1727, 70,000, and in 1787, 40,000, persons nearly the entire population of Tabriz, perished by earthquakes. During the present season, (Jan. 1819,) and towards the spring, scarce a week passes without some dreadful signals. The first signal is a heaving of the earth with rapid shaking of doors and windows; sometimes whole ranges of houses fall, and all their inmates disregarding the timely warning, are buried in their ruins.

There are generally two thunderings in the ground, seeming to roll regularly on towards the mountains, whence after a pause of several seconds, loud noises are heard, like distant tremendous explosions. If the imprisoned powers (gases, vapors, &c.) do not find vent, they then roll back again, filling every creature with horror. The earth becomes literally palsied, and even should the dreadful current again take a retrograde motion, every building falls a heap of ruins where the convulsion is felt. During the awful suspense, the people run out to avoid the shock, the most piercing cries are heard, and the very dogs howl and bark. To the European residents at Tabriz, these sounds are often the first signals of alarm; their houses being so constructed as to yield like wicker work. The whole environs, for more than a mile around the walls, are covered with overturned houses, mosques, &c., half buried among the shattered rocks which mingle in every direction with torn heaps of earth and ruins.

13. **TAURUS MOUNTAINS, SOUTH OF THE EUXINE.**—This range was passed by Sir R. K. Porter, in the night. These mountains are fearfully magnificent. In passing them, there was the utmost danger of plunging down perpendicularly many hundred feet; the party ascended steeps and passed along rocky ledges, scarcely wide enough to admit a single horse, on the brink of precipices so terrifically high, that in broad light they would not have dared to tempt them on foot. The train of baggage horses, tied head and tail by halters, and loaded with heavy cases, scrambled over the most dangerous points, when it was so dark that nothing but some preternatural instinct could guide them. In this way they moved with an unswerving pace along the narrowest ridges, with a wall of rock pressing on one side, and the shelving path receding from their footsteps on the other. Sir R. K. P. committed himself entirely to the little creature he rode, and never once touched the bridle; if the animal's head is at liberty he feels confidence in himself, while the pulling of the bridle often brings him to the ground.

14. **COPPER MINES.**—Near the town of Samsoon are silver and copper mines, two of which, called Malett and Jumbish, are very ancient, and have been recently opened; this district, reaching quite to the Eux-

ine, has always been famous for workers in iron, which is both dug from the mountain and imported from the Crimea.

15. **COPPER, LEAD, AND SILVER.**—Tokat, (where Henry Martyn died, south of the Euxine,) carries on a considerable trade in cups and other utensils of its own manufacture; there being mines about 50 hours distant, and 20 from Too-az; besides copper they produce lead and silver, and have 50 furnaces constantly at work; they furnish most of the silver for the mint at Constantinople.

16. **IRON ORE** is found, equal to the Swedish, lat. 40° N. long. 40° E., near Derband.

17. **CHERRY TREES.**—Lucullus took cherry trees from the vicinity of Tokat, and in about one hundred years they were naturalized in Great Britain.

18. **ALUM.**—Great quantities are brought from the mountain chain of Mousselim Ovedan.

19. **AVALANCHES OF MUD, STONES, AND MOUNTAINS.**—They are tremendous from mount Mousselim, being the effects of frost, thaw, rain, &c.; masses measuring several hundred yards sometimes break away and slide down into the valley, destroying men and cattle. A king of Trebizond, marching along this pass during the marshy season, to invade the country westward, is reported to have been suddenly buried with his army, by the fall of half the mountain.

20. **IMMENSE BLOCK OF GRANITE.**—Near Hamadan, the ancient Eabatana, is a block of fine grained red granite of the weight of many thousand tons. Ten feet from the ground there are two square excavations, about five feet square and one foot deep, each of which contains three columns of engraved arrow-headed writing, in the most excellent preservation; hitherto they have never been decyphered. There are granite mountains here, and Elwund is probably of that rock: from its summit are seen the peculiarities of an Asiatic landscape—rock, mountain, desert, and a sky of fire.

21. **NITROUS EFFLORESCENCE**—is found on the ruins of Babylon and in many other places.

22. **TOWER OF BABEL.**—This is an immense pile of ruins,—at its base it measures 3082 feet (in circuit,)—width 450 feet; it presents two stages of hills; the first about 60 feet high, cloven into a deep ravine by the rain, and intersected by the furrows of ages. To the base of the second ascent is about 200 feet from the bottom of the entire pile, and from the base of this ruin to the top is 35 feet. On the western side, the entire mass rises at once from the plain in one stupendous

though irregular pyramidal hill, broken in the slopes of its sweeping acclivities by time and violence. The south and north fronts are particularly abrupt towards the point of the brick ruin; on the north side there are large piles of ruins of fine and solid brick-work, projecting from among immense masses of rubbish at the base; the fine bricks were evidently part of the facing of this side. The tower-like ruin of the extreme summit is a solid mass 28 feet broad, made of the most beautiful brick masonry, and presenting the apparent angle of some structure originally of a square shape, the remains of which stand on the east to the height of 35 feet, and to the south 22 feet. It is rent from the top to nearly half way down; the remains of the masonry are furnace-burnt bricks: they are united by a calcareous cement about $\frac{1}{4}$ of an inch in thickness, having in it a layer of straws, and so hard that it could not be separated. The base of the structure was not altered, but the piles of fine bricks thrown down were vitrified with the various colors, and they gave the ringing sound belonging to the vitrifications of glass in the manufactories; the lines of cement are visible and distinct, and are vitrified. The consuming power appears to have acted from above, and the scattered ruins fell from a higher point than the summit of the present standing fragment.

“The heat of the fire which produced such amazing effects, must have burned with the force of the strongest furnace; and from the general appearance of the cleft in the wall and these vitrified masses, I should be inclined, says the author, to attribute the catastrophe to lightning from heaven. Ruins, by the explosion of any combustible matter, would have exhibited very different appearances.” The entire surface of the structure appears to have been faced with fine brick.

23. NAPHTHA SPRINGS AND SULPHUR.—Lat. $34\frac{1}{2}^{\circ}$ N., Long. 45° E. Near Sulimania or Shinkook, in Old Assyria, ten in number—they were described by Strabo. A sulphurous air is mentioned, (probably it was mistaken for the vapor of the Naptha,) which, on drawing near, produced instantly excruciating headaches.

Several pits or wells, seven or eight feet in diameter, and ten or twelve feet deep, are found all within the compass of 400 or 500 yards; a flight of steps is cut in each pit down to the fluid, which rises or falls according to the dryness or moisture of the weather. The natives dip it out with ladles into bags of skins, which are carried to Kirkook for sale—profits per annum 30,000 to 40,000 piastres.

24. THE KIRKOOK NAPHTHA.—The Kirkook Naptha is black, and is consumed in the S. W. of Courdistan. Bagdad and its environs are

supplied chiefly from Kufri. Near to the wells is a pool of muddy stagnant water, covered with a thick scum deeply tinged with sulphur. A few hundred yards to the east of the top of the same hill is a flat circular spot, 50 feet in diameter, perforated by 100 or more small holes, whence issue clear smokeless flames, smelling strongly of sulphur. In fact, the whole surface of this perforated spot of ground appeared as a crust of sulphur over a body of fire within; the surface being perforated by a dagger, a flame instantly issued, rising, sometimes, even higher than the others.

The government derives a revenue from the sale of the sulphur from this place; it is called by the natives *Baba Gurgur*—gur being their name for naphtha or bitumen. Between *Baba Gurgur* and *Kirkook* were observed innumerable spots of native sulphur, and a great many pools sharing its properties, which might be converted into excellent medicinal baths.

25. NAPHTHA SPRINGS OF BAKON.—N. Lat. 40° —20, E. Long. 49° —50.—The peninsula of the Caspian is called *Absheron*. These fountains of light and heat are even more productive than those of *Kirkook*, and like them are deemed inexhaustible.

Near the springs spreads the celebrated burning plain, almost a mile wide. To this place the disciples of Zoroaster resort, by thousands, to adore the eternal blaze, and to convey to their own hearths a portion of the sacred flame. At the distance of one mile and three fourths from the naphtha springs is the fine temple of the *Gubres*, nearly a mile in circumference, from the centre of which arises a bluish flame. Some small houses have been built on the spot, and the people smother the flame by covering the earth with a thick coating of loam; on perceiving this, they light a flame at the orifice and apply it to culinary purposes, and the flame is easily extinguished by closing the aperture. A sulphurous gas arises from the flame, and a strong current of inflammable air continues to issue even after the flame is extinguished, and leathern bottles are frequently filled with it.

The whole country around *Bakon* appears sometimes as if enveloped in flames; the fire appears to roll down from the mountains with incredible velocity and in large masses, and during the clear moonshine nights of November and December, a bright blue light is observed at times to cover the whole western range. *Jonas Hanway* mentions six springs of white naphtha near *Niezabad*; there were wells of dark naphtha not far off. When the weather is thick and hazy, the springs boil up higher, and the naphtha sometimes taking fire, runs, like burning lava, into the sea. In boiling over around the mouths of the pits, the oily substance sometimes becomes of the consistency of pitch. The poorer people sometimes use it as we do oil, to boil

their food ; it burns best when mixed with a small quantity of ashes ; and to avoid accidents, they preserve it at a distance from their houses in earthen pots, under ground. Both the black and white naphtha are used for varnishes. When the naphtha has been kindled accidentally, the effects have often been fatal, and Strabo says the flame cannot be extinguished by water.

The flaming soil, or *everlasting fire*, as it is called, of Bakon, is not less famous than its naphtha springs. According to Mr. Rich, the principal bitumen pit at HIT,* (which place must have furnished the builders of Babylon,) has two sources, divided by a wall, on one side of which the bitumen bubbles up, and on the other the oil of naphtha.

In order to enable the bitumen to adhere to the bricks, as a cement, it must be boiled with a certain proportion of oil; the principal object is to guard against dampness, especially in the lower parts of buildings ; it is at present used for caulking cisterns and boats,† &c. Rock salt and sulphur are obtained in the naphtha country (near Niezabad.)

26. YELLOW TRANSPARENT MARBLE OF TABRIZ, NEAR L. OROOMIA.—This is found in the heights near Deygurgan. It is a kind of petrification (calc sinter) formed by water flowing from the rocks above and depositing itself, by a gradual sinking through the surface of the earth, to a certain depth beneath. A sort of incrustation covers the whole far spread mass, which extends down the slope of the hill, and over the level of its valley for a considerable way ; it is found some few feet below the crust, in thin layers, which are cut into long and wide slabs, about ten or twelve inches thick ; they are used for skirting decorations for the saloons of the opulent, bordering the room all around just above the floor. When cut into very thin sheets it is translucent, like ground glass, and is used for windows of baths, &c. Pieces of it are also cut into small tablets for tomb-stones, to be impressed with words from the Koran.

27. ENORMOUS CALCAREOUS DEPOSIT.—Near the ruins of an ancient city called Tact i Solomon, is a lake 60 yards by 30 ; its water issues from a channel and strikes down the side of the hill ; it is so highly charged with lime, that the courses through which it has flowed are now transformed into long serpentine ridges of stone, running not only down the hill, but to a considerable distance along the valley, and then standing nearly three feet high above the level of the ground. The overflowings of the lake have incrustated the earth and ruins, and

* About four days journey N. W. of Bagdad.

† And now (1839) for making pavements and roads.—B. S.

the face of the fortress in that direction, with a cream colored deposit; nay, the hill itself on which the old city was built, 50 feet high above the plain, may probably have been raised in the same way, the present small lake being only the remains of a much larger one formerly level with the plain; and this may explain why the present lake appears to be fathomless. The hill thus raised by the waters became eventually covered by a noble city, the ruins of which are now in turn covered more or less by the calcareous deposit.

28. **LIMESTONE WITH SHELLS.**—At Kerefto there are vast caverns wrought by art in limestone, or natural caverns enlarged and modified by art; in this limestone were remains of shells “resembling cockles, and of nearly the same size;” the caverns were very numerous and curiously wrought.—Vol. II, pp. 550, &c.

29. **LIMESTONE PROMONTORY ON ISLAND OROOMIA**—It rises 800 feet high out of the lake, and is an island in the winter when the water is high, but becomes a peninsula when it is low. It is called Goorohin Shala. It has been made a fortress, and has but one entrance into its natural or artificial caverns, in which there is abundance of the most pellucid fresh water in a rock rising out of one of the saltiest lakes in the world. The ridge of the rock is scarcely six feet broad, and while the observer stands upon it at the giddy height of 800 feet above the azure Oroomia, the hollow roarings of whose waters dashing into the caverns they have worn through the rock at its base, serve to increase his nervous giddiness.

30. *Mica containing Potash and Lithia.*—M. V. Regnault has analyzed these micas; they fuse easily at a red heat, and without suffering any sensible loss of weight, and are afterwards easily reduced to a fine powder.

The analysis was performed by acting upon the mica, previously fused and reduced to fine powder, with hydrochloric acid, and separating the silica in the usual way. The alumina and peroxide of iron were precipitated together by carbonate of ammonia; the liquors being evaporated, after the addition of sulphuric acid, left a residue, which, when calcined, yielded the alkaline sulphates, which were dissolved in water, and decomposed by chloride of barium. The excess of barytes added was afterwards precipitated by dilute sulphuric acid, added gradually; and the solution containing the alkaline chlorides, after the addition of chloride of platina, was evaporated nearly to dryness. By the addition of alcohol, the double chloride of potassium and platina was separated; the lithia was determined by difference, and by the composition of the sulphates.

In order to determine the fluorine, the mica was acted upon with carbonate of soda, and then treated with boiling water. The alkaline liquor was concentrated after filtration, and then subjected to a current of carbonic acid gas, which produced an abundant precipitate of glutinous silica. A solution of oxide of zinc in carbonate of ammonia was afterwards added to the filtered liquor, and it was then evaporated to dryness; the last traces of silica and alumina were thus separated. The saline mass was treated with a small quantity of boiling water, and the liquor was supersaturated with hydrochloric acid in a platina capsule. The solution was suffered to remain for twenty four hours, in order to allow the carbonic acid to separate perfectly. It was then saturated by ammonia, and the fluorine precipitated by chloride of calcium.—*Lond. and Edin. Phil. Mag.*

31. *Heat of the interior of the earth.*—As the result of numerous experiments and observations on the temperature of artesian wells in Mid-Lothian, Sterlingshire, and Clackmannanshire in Scotland, Dr. Robert Patterson has deduced the following table.

Name of Place.	Temp. of Spring.	Temp. of District.	Depth of Spring.	Rate of Increase.
			Feet.	Feet.
Meadowbank	49½	46½	159	1 for every 53
Kerse	51½	46	231	1 “ 42
Mumrills	51	46	213	1 “ 42.7
Loanside	48	46	100	1 “ 50
Kennetpans Distillery Bore	51½	46	270	1 “ 49.1
Spring immediately under Mr. Bruce of Kennet's house	53	46	350	1 “ 50
The four springs here noted are in the immediate neighborhood of Kennetpans, and quite close to the roadside	51	46	210	1 “ 42
	49	46	160	1 “ 53.1
	50¾	46	200	1 “ 42.6
	51	46	210*	1 “ 42
Parish of Slamannant	48	45	180	1 “ 60
			Average	1 for every 47.11

A simple inspection of this table will show how very nearly the results of different localities approximate; and if we take the average number of these results, 1° for every 48 feet as we descend, we shall find that it comes very near the average, as fixed upon by the British Association, which is 1° for every 45 feet in depth. On comparing this table with the following, which has been drawn up from a variety of sources, but more especially from papers which are to be found in Professor Jameson's Journal, we shall find that the average of the former is much less than the latter, and this chiefly in consequence of some of the observations we have quoted having been made on en-

* This is the supposed depth; accurate information regarding it could not be procured.

† Mr. Kincaid has furnished me with this observation, on which perfect reliance can be placed.

closed waters at the bottom of old pits. We have altogether kept out of view the experiments of Spasky and Kupffer on the artesian wells of Vienna, as there is certainly some mistake, or rather, as Professor Bischof remarks, some militating cause, and he conjectures "that the depths of these springs are not equal to the lowest point of the course of the spring, but that the springs rise from a still greater depth."

	o	Feet.
Rüdersdorf (Magnus and Erman,)	1 in every	48.3
Latter observations,	1 "	51.2
Still more recent,	1 "	54.1
Erzgebirge (Bischof,) from observations on enclosed waters,	1 "	61.8
Monk Wearmouth,	1 "	59.7
* Cornwall, from springs,	1 "	54.8
Cornwall, from enclosed waters,	1 "	52.7
Uralian Mountains, from a comparison of the most authentic observations in these regions,	1 "	55.4
Rüdersdorf, from rising springs,	1 "	54.4
Paris, Well at Port St. Ouen,	1 "	72.1
Departments du Nord, { Well of Marquette,	1 "	61.
et du Pas de Calais, { " Aire,	1 "	41.
{ " St. Vincent,	1 "	47.
Sheerness,	1 "	41.
Tours,	1 "	41.8
Geneva (De la Rive et Marcet,)	1 "	50.
Paris, Slaughterhouse of Grenelle,	1 "	57.1
Average,		1 for every 53.1

Jameson's Journal, April to July, 1839.

32. *Notice of remarkable Agitations of the Sea at the Sandwich Islands, on the 7th November, 1837; by T. CHAS. BYDE ROOKE, F. R. C. S.*—On the evening and night of the 7th November, a most remarkable commotion of the sea was witnessed at Hanolulu, in many respects similar to that witnessed at these islands in May, 1819. One inch and a half of rain had fallen during the previous twenty four hours; the wind was fresh from the N. E., squally at intervals. The atmosphere was clear and cool. Therm. 74.5; the barometer had gradually fallen during the four previous days, but this evening had again risen to 30.06, at six o'clock, when the alarm was given that the sea was retiring. The first recession was the greatest, something more than eight feet; but being unprepared to make observations at the moment, the exact fall was not measured. The reefs surrounding the harbor were left dry, and the fish aground were mostly dead.

* Copied and reduced from Professor Bischof's paper on Thermal Springs.

The sea quickly returned, and in twenty eight minutes reached the height of an ordinary high tide; scarcely remaining stationary, it again receded and fell six feet. This was repeated at intervals of twenty eight minutes. On the third rising it was four inches above ordinary high-water mark, and fell again six feet four inches. After the fourth rising, the length of time occupied by the rise and fall varied, and the rise and fall diminished gradually but not regularly. At eleven p. m. the therm. stood at 74° ; barometer 30.04; wind freshening and frequent showers; the ebb now occupied twenty six minutes, and the flow ten. At eleven, 30, it became calm, with constant rain. Therm. 73.5; barometer, 30.03. The ebb and flow still continued occupying the same space of time, but the rise and fall decreasing. This continued during the forenoon of the 8th. The rapidity with which the water fell varied in different parts of the harbor. On the east side, the greatest rapidity noticed was six inches in a minute; but on the north, at one time during the third recession, it fell twelve inches in thirty seconds. At no time did the water rise higher than a common spring tide; but the fall was about six feet below low water-mark. The same occurrence is related to have taken place in 1819, when the tide rose and fell thirteen times in the space of a few hours. On neither occasion was there any perceptible motion or trembling of the earth, or unusual appearance of the atmosphere. Since the above was written, distressing accounts have been received from Maui, and Hawaii, of the damage done to property and loss of life. On the leeward side of Maui, the same rise and fall took place as at Honolulu; but on the windward part of the Island, the sea retired about twenty fathoms, and quickly returned in one gigantic wave, sweeping every thing before it;—houses, trees, canoes, and every moveable object exposed to its fury. At a small village called Kahului, in the district of Walluku, on the sea retiring, the amazed inhabitants followed it as it receded, eagerly catching the stranded fish, shouting and hallooing with pleasure, when suddenly the sea rose perpendicularly before them like a precipice, and, rushing to the beach, buried the assembled multitudes in the flood, and overflowing the shore, swept away every house in the village but one; the canoes and property of the natives were all destroyed. Happily, owing to the amphibious education of the people, but two lives were lost here; but as the same occurrence happened all along the sea-side, we shall probable hear of more deaths.

At Byron's Bay, on Hawaii, the same phenomenon took place. An unusual number of persons were collected together attending a protracted meeting, consequently every house was crowded. At half past six, the sea retired at the rate of four or five knots an hour, re-

ducing the soundings from five to three and half fathoms at the anchorage, and leaving a great extent of the harbor dry. Hundreds of curious souls rushed down to witness the novelty, when a gigantic wave came roaring to the shore at the rate of six or eight knots an hour, rising twenty feet above high water mark, and fell on the beach with a noise resembling a heavy peal of thunder, burying the people in the flood, destroying houses, canoes, and fish-ponds, washing away the food and clothing of the inhabitants, large quantities of animals, fire wood, and timber collected on the strand for sale. The cries of distress were horrible; those in the water, unable to swim among the wreck of houses and pieces of timber, struggling for their lives, and those on shore wailing for their friends and relatives. The British whale ship, Admiral Cockburn, was at anchor in the bay, and to the timely aid and humane exertions of her master (Lawrence) and crew, many are indebted for their lives; but for the assistance rendered by their boats, many, who were stunned and insensible, would have been carried out to sea and perished, as the natives had not a single canoe left that would float. Every thing was destroyed; those who escaped with their lives had neither food nor raiment left. In Kanokapa and Kaahelu alone sixty six houses were destroyed, and eleven persons lost their lives, four men, two women, and five children; at Waiolama and Hauna a woman and child were drowned; at Kauwale one woman lost her life. The amount of damage done has not yet been ascertained, nor is it known how many times the sea rose and fell. There was no shock of an earthquake felt at Hilo, or elsewhere, although it is ascertained that the volcano of Kilauea was unusually disturbed the previous evening,—the fires were suddenly quenched, and yawning chasms were burst open in previously tranquil places, accompanied with violent explosions. Inquiries have been made of masters of vessels who were to the north and to the east of the islands on the 7th, at various distances, but none of them noticed any thing unusual in the sea or atmosphere. That this apparent submarine volcanic action has taken place at some distance from the islands, is proved by the wave striking the different islands simultaneously, and apparently in the same direction; but at what distance we have no means at present to determine. Perhaps the internal fires have found a new vent, which may be laying the foundation of a new group of islands in our neighborhood. It is now $19\frac{1}{2}$ years since a similar phenomenon occurred here, but not so violently as the last, nor was it attended with any loss of life. On the second day after an affecting scene was witnessed at Wailuku (Maui :) the bodies that had been recovered from the sea were conveyed together to the church, followed by a great multitude: a funeral sermon was preached on the

occasion;—this solemn warning made a deep, and it is hoped, a lasting impression on those who witnessed it, of the uncertain tenure by which we hold our lives.” Copied from the *Ceylon Chronicle* in the *Literary Gazette* of Jan. 1839.—*ib.*

33. *Rose Mica Lepidolite*.—This mica has the form of very small rose-colored plates. It is found disseminated in a kaolin, which is employed in the porcelain manufactures of Vienna. It is separated by washing from the kaolin. The mean of four analyses gave

Silica	52.40
Alumina	26.80
Potash	9.14
Lithia	4.85
Fluorine	4.40
Deutoxide of manganese	1.50—99.09.

Yellow Mica.

Silica	49.78
Alumina	19.88
Peroxide of iron	13.22
Potash	8.79
Lithia	4.15
Fluorine	4.24—100.06.

Annales de Chimie et de Phys., pp. 69–72.—*Lond. & Edin. Phil. Mag.*

34. *Notice of a cheap and simple method of preparing paper for Photographic Drawing, in which the use of any salt of silver is dispensed with*; by MUNGO PONTON, Esq., F. R. S. E., Foreign Secretary Society of Arts for Scotland. Communicated by the Society of Arts.*—While attempting to prepare paper with the chromate of silver, for which purpose I used first the chromate of potash, and then the bichromate of that alkali; I discovered that when paper was immersed in the bichromate of potash alone, it was powerfully and rapidly acted on by the sun's rays. It accordingly occurred to me, to try paper so prepared to obtain drawings, though I did not at first see how they were to be fixed. The result exceeded my expectations. When an object is laid in the usual way on this paper, the portion exposed to the light speedily becomes tawny, passing more or less into a deep orange, according to the strength of the solution, and the intensity of the light. The portion covered by the object retains the original bright yellow tint, which it had before exposure, and the object is thus represented yellow upon an orange ground,

* Read before the Society of Arts for Scotland 29th May, 1839.

there being several gradations of shade, or tint, according to the greater or less degree of transparency in the different parts of the object.

In this state, of course, the drawing though very beautiful, is evanescent. To fix it, all that is required is careful immersion in water, when it will be found that those portions of the salt which have not been acted on by the light are readily dissolved out, while those which have been exposed to the light are completely fixed in the paper. By this second process, the object is obtained white upon an orange ground, and quite permanent. If exposed for many hours together to strong sunshine, the color of the ground is apt to lose in depth, but not more so than most other coloring matters.

The action of light on the bichromate of potash differs from that upon the salts of silver. Those of the latter which are blackened by light are of themselves insoluble in water, and it is difficult to impregnate paper with them in an equable manner. The blackening seems to be caused by the formation of oxide of silver. In the case of the bichromate of potash, again, that salt is exceedingly soluble, and paper can be easily saturated with it. The agency of light not only changes its color, but deprives it of solubility, thus rendering it fixed in the paper. This action appears to me to consist in the disengagement of free chromic acid, which is of a deep red color, and which seems to combine with the paper. This is rendered more probable from the circumstance that the neutral chromate exhibits no similar change.

The active power of the light in this instance, resides principally in the violet rays, as is the case with the blackening of the salts of silver. To demonstrate this, three similar flat bottles were filled, one with ammoniuret of copper which transmits the violet rays, one with bichromate of potassa transmitting the yellow rays, the third with tincture of iodine transmitting the red rays. The paper was readily acted on through the first, but scarcely if at all through the second and third; although much more light passed through the bottle filled with bichromate of potassa than through the one filled with ammoniuret of copper.

The best mode of preparing paper with bichromate of potash is to use a saturated solution of that salt; soak the paper well in it, and then dry it rapidly at a brisk fire, excluding it from daylight. Paper thus prepared acquires a deep orange tint on exposure to the sun. If the solution be less strong or the drying less rapid the color will not be so deep.

A pleasing variety may be made by using sulphate of indigo along with the bichromate of potash, the color of the object and of the pa-

per being then of different shades of green. In this way also the object may be represented of a darker shade than the ground.

Paper prepared with bichromate of potash is equally sensitive with most of the papers prepared with salts of silver, though inferior to some of them. It is not sufficiently sensitive for the camera obscura, but answers quite well for taking drawings from dried plants, or for copying prints, &c. Its great recommendation is its cheapness and the facility with which it can be prepared. The price of the bichromate of potash is 2s. 6d. per lb., whereas of the nitrate of silver only half an ounce can be obtained for that sum. The preparing of paper with the salts of silver is a work of extreme nicety, whereas both the preparing of the paper with the bichromate of potash and the subsequent fixing of the images are matters of great simplicity, and I am therefore hopeful that this method may be found of considerable practical utility in aiding the operations of the lithographer.—*Jameson's Journal, April to July—1839.*

Edinburgh, 18, May, 1839.

35. *Fossil-Tree at Granton, near Edinburgh.*—A great fossil-tree similar to that at Craigleith, has been discovered in the sandstone quarry at Granton. Its dimensions cannot yet be ascertained, but the distance between the extreme points already uncovered is about forty five feet, and its breadth, where most exposed, is about three feet.—*Ib.*

36. *Notice upon the Alcoholic Strength of Wines*; by Dr. CHRISTISON.—Various accounts have been given of the alcoholic strength of wines by Mr. Brande, Julia-Fontenelle, and others. The author has been engaged for some time in experiments for determining the proportion of alcohol contained in various wines of commerce, and also the circumstances which occasion a variety in this respect. The present paper is an interim notice of the results.

The method of analysis consisted in the mode of distillation, which was applied with such contrivances for accuracy that nearly the whole spirit and water was distilled over without a trace of empyreuma, and without the loss of more than between two and six grains in 2000. From the quantity and density of the spirit, the *weight* of absolute alcohol of the density 793.9, as well the *volume* of proof spirit of the density 920, was calculated from the tables of Richter founded on those of Gilpin.

The author has been led to the general conclusion that the alcoholic strength of many wines has been overrated by some experimentalists, and gives the following table as the result of the investigations he has hitherto conducted. The first column gives the per-centage of

absolute alcohol by weight in the wine, the second the per-centage of proof spirit by volume.

	Alc. p. c. by weight.	P. Sp. p. c. by volume.
Port—Weakest,	14.97	30.56
Mean of 7 wines,	16.20	33.91
Strongest,	17.10	37.27
White Port,	14.97	31.31
Sherry—Weakest,	13.98	30.84
Mean of 13 wines, excluding those very long kept in cask,	15.37	33.59
Sherry—Strongest,	16.17	35.12
Mean of 9 wines very long kept in cask in the East Indies,	14.72	32.30
Madre da Xeres,	16.90	37.06
Madeira, { all long in cask } Strongest	14.09	30.80
{ in East Indies } Weakest	16.90	36.81
Teneriffe, long in cask at Calcutta,	13.84	30.21
Cercial,	15.45	33.65
Dry Lisban,	16.14	34.71
Shiraz,	12.95	28.30
Amontillado,	12.63	27.60
Claret, a first growth of 1811,	7.72	16.95
Chateau-Latour, first growth 1825,	7.78	17.06
Rosan, second growth 1825,	7.61	16.74
Ordinary Claret, a superior "vin ordinaire,"	8.99	18.96
Rives Altes,	9.31	22.35
Malmsey,	12.86	28.37
Rudesheimer, superior quality,	8.40	18.44
Rudesheimer, inferior quality,	6.90	15.19
Hambacher, superior quality,	7.35	16.15
Giles' Edinburgh Ale, before bottling,	5.70	12.60
The same Ale, two years in bottle,	6.06	13.40
Superior London Porter, four months bottled,	5.36	11.91

In addition to certain obvious general conclusions which may be drawn from this table, the author stated, as the result of his experiments, that the alcoholic strength of various samples of the same kind bears no relation whatever to their commercial value, and is often very different from what would be indicated by the taste even of an experienced wine taster.

Some observations were next made on the effect produced on the alcoholic strength of wines by certain modes of keeping or ripening them, more especially by the method employed in the case of sherry, madeira, and such other wines, which consists of slow evaporation

for a series of years through the cask, above all, in hot climates. The researches made by the author on this head are not yet complete; but he is inclined to infer, from the experiments already made, that, for a moderate term of years, the proportion of alcohol increases in the wine, but afterwards, on the contrary, diminishes; and that the period when the wine begins to lose in alcoholic strength is probably that at which it ceases to improve in flavor. The increase which takes place at first in the alcohol of wine undergoing evaporation through the cask, appeared at first view parallel to the fact generally admitted on the authority of Söemering, that spirit becomes stronger when confined in bladder, or in a vessel covered with bladder, in consequence of the water passing out by elective exosmose.

The author, however, on repeating the experiments of Söemering, as related by various writers (for he could not obtain access to the original account of them,) was unable, by any variation of the process he could devise, to obtain the results indicated by the German anatomist. Constantly the spirit, whatsoever its strength, whether proof spirit or rectified spirit, became weaker. It was observed at the same time, that if the bladder containing spirit was enclosed in a confined space with quicklime, the spirit slowly became absolute alcohol of the density 796, in consequence of a permanent atmosphere of alcohol being speedily formed, while the watery atmosphere was absorbed by the quicklime as fast as it was produced. Subsequently it was proved that the bladder was not essential to the process; for an open cup of rectified spirit, enclosed in a confined space with quicklime, to absorb the water which arose from the spirit, became in two months absolute alcohol of the density 796. Professor Graham of London, some time ago proved the analogous fact, that spirit might be thus rendered pure alcohol in the air pump vacuum. A vacuum, however, is, upon principle, as well as in fact, not necessary for the process; it merely accelerates it. The new method is obviously applicable on the great scale for obtaining absolute alcohol, wherever time may be allowed.—*Jameson's Journal, April to July, 1839.*

37. *Dr. Berendt's Investigations on Amber.*—We learn with much satisfaction, from a letter sent us very recently by Dr. Berendt of Dantzic, that his important work on the insects, &c. found imbedded in amber, and which, though commenced in 1830, has been interrupted in its publication, is now to be carried on and completed with as little delay as possible. The first part contains an analytical or rather synthetical account of the *amber tree*, and of the flowers and fruits of other vegetable productions which grew in the amber woods. Dr. Berendt has transmitted to us the fifteen lithographed

plates illustrative of his second part, and which have greatly interested and surprised us by the richness of the Entomological Fauna they exhibit. These figures represent the Crustacea, Myriopoda, Arachnida, and Aptera, examined by the author; and it would appear that all the species found in amber are now extinct, and that but a small number of the genera at present exist. Many new genera have therefore been formed, and also one entirely new family. Of the latter, the species *Archæa paradoxa*, figured in plate 2d, at once arrests the attention by its singular structure and form. The 3d part is also in preparation, and will include the Hemiptera, Orthoptera, and Lepidoptera; the 4th will contain the Neuroptera, and Hymenoptera; the 5th, the very numerous division of the Diptera: and the 6th and last will contain the equally rich section of the Coleoptera.—*Ib.*

38. *Notice regarding the Stone used in constructing the Temples at Pæstum.*—When at Pæstum, on the 3d of June, 1838, I observed a fact regarding the travertine of which the splendid Grecian temples there are constructed, which you may perhaps think worth inserting in your Journal, and thus lead future travellers to inquire into the cause of the phenomenon. We remarked, that the *color* of the three temples was very different, although they are all built of the same materials, (travertine or fresh-water limestone, containing imbedded fresh-water shells;) two of them being of a grey color, and the other, that usually known as the “Temple of Neptune,” of a rich yellowish brown. On closer examination, I found that this difference in the color was caused by the two former being covered with a grey crustaceous lichen, from which the latter was perfectly free. I was for some time unable to account for this, when it struck me, that it might be caused by the stone containing some matter inimical to vegetation; and on applying a freshly broken piece to the tongue, I perceived a distinctly saline taste. I brought away specimens of the stone from the different temples, which I gave for examination to my friend Mr. Kemp, who informs me, that after reducing portions of it to powder and boiling it in distilled water, he found, in a portion taken from one of the smaller temples, no saline matter in solution; but in that from the largest, or the “Temple of Neptune,” a considerable quantity of *muriate* of lime. This fact accounts at once for the absence of vegetation on that building. It would be interesting to ascertain whence this salt was derived, and I regret much that we had not time to examine the spot where are said to be the ancient quarries, about two miles inland from the ruins, an inspection of which might clear up this point.—*Letter from W. C. Trevelyan, Esq.—Ib.*

39. *Products of Respiration at different periods of the day*; by CHAS. T. COATHUPE, Esq.—*Lon. and Edin. Phil. Mag.*, June, 1839.

The subject of the experiments was 38 years old, stature 5 feet 8 inches, weight 140 pounds; average pulse 60 to 62 per minute; average inspiration 18 to 21 per minute.

Omitting the description of apparatus, and the details of experiment; some of the most important results are as follows:

The corrected result of 32 experiments made before breakfast and comprising 8 days, gave 4.37 for the per centage of carbonic acid produced in respiration.

Fifteen experiments between 10 and noon in 7 days indicated 3.90 per cent. of carbonic acid.

Seven experiments between noon and 1 P. M. in five days gave 3.92 per cent.

Twenty nine experiments between 2 P. M. and 5½ P. M. in 8 days, indicated 4.17 per cent.

Seventeen experiments between 7 P. M. and 8½ P. M. in 8 days, gave 3.63 per cent.

Twenty four experiments between 9 P. M. and midnight indicated 4.12 per cent. and the average of all the experiments, 124 in number, in almost every hour between 8 A. M. and midnight in eight days, gives 4.09 per cent. as the total daily average of the carbonic acid gas in the air respired from the lungs.

The carbonic acid gas produced in respiration, is therefore, a variable quantity—less during active digestion and increasing with abstinence from food; in the same individual, it varies at similar periods of different days. Excitement of any kind, whether from stimulus or annoyance, caused a diminution of carbonic acid in the air respired, compared with the ordinary average of that respired at a similar period of the day, and during a state of ordinary tranquillity. While the total average indicated 4.09 the maximum observed at any single examination was 7.98. This was at 8 A. M., Feb. 5, the maximum was 1.91; at 7½ P. M., Feb. 7th. These results differ widely from those of Messrs. Allen and Popys, published in *Phil. Trans.* in 1809. Their average was 3 per cent. of carbonic acid in the air respired. By protracting the respiratory process, there was an increase of carbonic acid of one fourth more than the average of natural respiration. Due allowance being made for this and for aqueous vapor, the 8 per cent. of Allen and Popys is reduced to 6.4 per cent. Their experiments were made before breakfast and just before dinner when the largest quantity of carbonic acid is produced; the considerable volumes of air which they employed were renewed not over thrice, and were obtained at one period of the day; the quantity of carbonic acid which they found, had it been obtained in natural respiration, would not have been over 6.4 per cent., which is the maximum at the most favorable periods for its production.

The experiments of Mr. Coathupe, were many times repeated upon other individuals and always accorded with the average results already stated.

General conclusions.

1. The average respirations by most adult individuals, varying between 17 and 20 per minute, may be stated at 20 per minute.

2. The average bulk of air, varying between 14 and 18 cubic inches, may be stated at 20 cubic inches.

3. The average production of carbonic acid gas in human respiration, varying between 1.9 and 7.98 per cent., may be stated at 4 per cent.

Hence 460.800 cubic inches, or 266.66 cubic feet of air respired by a healthy adult, of average stature and health in 24 hours, of which 10.666 cubic feet will be converted into carbonic acid = 2386.27 grains, or 5.45 avoird. ounces of carbon.

This gives 99.6 grains of carbon per hour by one human adult, or 124.328 pounds annually. The population of Great Britain and Ireland 26½ millions, emit 147.070 tons of carbon annually.

The maximum quantity of air requisite for a healthy adult during 24 hours, (even supposing that no portion of the air was inspired twice,) will not exceed 266.666 cubic feet. For the proofs of these important conclusions we must refer to their very valuable memoir already cited; it occupies 14 pages 8vo., with a large proportion of figures and tables.—
EDS.

40. *Chemical Equivalents.*—Richard Phillips, Esq., F. R. S., in a paper read to the Royal Society on the chemical equivalents of certain bodies, concludes that “no material and even scarcely any appreciable error can arise from considering the equivalent numbers of hydrogen, azote, and chlorine, as being 1, 8, 14 and 36 respectively.”

It is most desirable to be freed from the necessity of introducing fractions into the numbers representing chemical equivalents.—*Lond. and Edin. Phil. Mag., May, 1839.*

41. *Photogenic power of Light from burning Coke.*—Mr. Robert Mallet has discovered that the light emitted by incandescent coke blackens photogenic paper in about forty five seconds; a property possessed in a sufficient degree by few artificial lights. The author discovered a considerable time since that the light emitted by incandescent coke at the twyer of a cupola furnace contains the chemical rays in sufficient abundance. It is supposed that there will be no difficulty in burning a small quantity of coke at a high temperature, and that the light may be made use of to register nocturnal observations.—*Id.*

42. *Lethæa Geognostica of Prof. Bronn. Exchanges of objects of Natural History.*—We have mentioned with approbation the fine work of Prof. Bronn on fossil organic remains, (Vol. xxxiii, p. 204.)

By a letter received from him dated Heidelberg, October 26, 1838, we learn that the first edition of the *Lethæa Geognostica* was already exhausted even before the volume was finished. This volume has therefore been reprinted, an enlarged edition of the second volume has been published, and a new edition is spoken of as necessary.

The author being occupied with other labors and being anxious to correct all errors that may be discovered, to add to the text all new discoveries and a certain number of supplementary plates, so that the possessor of the first or second edition shall have no occasion to purchase any thing more than the additional text and plates; for these reasons the new edition will not appear under from two to four years. It is not improbable that a French edition will then appear.

This will be an important acquisition, as many persons in countries where the English language is spoken, can read works of science in French who cannot read them in German.

Prof. Bronn having already arranged for exchanges on the part of the Museum of Heidelberg with certain individuals in Boston, New York, and Philadelphia, as far as regards birds, shells, and petrifications, is still desirous of effecting the same object in other branches of natural history, especially for quadrupeds, insects, and reptiles. We beg leave to commend this subject to the attention of our naturalists, not doubting (and our own experience justifies the confidence) that they will receive a fair and honorable equivalent for the objects they may send.

The labors of Prof. Bronn are worthy of all encouragement, and it gives us pleasure to keep them in the view of our countrymen both on account of their intrinsic value, and because the German savans are distinguished for their courteous and liberal treatment of this country.

43. *Prof. Agassiz on the Echinodermata.**—The first Livraison of this work has been kindly forwarded to us by the author. In Vol. xxxiv, p. 212, we announced the intention of Prof. Agassiz to publish it, and are happy now to add our confirmation that it well maintains the enviable reputation of the author of the *Poissons Fossiles*.

In the introduction he recapitulates the facilities which he has enjoyed in drawing up his history, from the liberality of all his scientific friends on the continent and in England, in placing at his disposal their collections and labors in this department of Natural History. Speaking of the

* *Monographies D'Echinodermes Vivans et Fossiles, par L. Agassiz, 1er Livraison, contenant les Salenies. Neuchatel, Suisse—prix 10 frs de France; subscriptions received by A. Mayor, 8 Pine-street, New York.*

plan of his work he says: "My intention is to figure and describe all the new and less common species, as well as those hitherto incorrectly figured. But not being able consistently with the interests of the work to confine myself to a regular mode of publication, and to that end to publish on a given day, before the rest, those parts of my researches in which I have united the new materials and the most perfect notes, I will publish in succession, monographies, each embracing a natural group and forming continuous wholes, whose order of sequence will be of little consequence, since they will, in the conclusion, fall into their proper places, with those general considerations which will terminate this work. These monographies whose extent will be proportioned to their contents, will appear at irregular intervals. This is I believe the only course which an author can follow, who publishes his labors in *Livraisons*, without continually incurring the reproach of delay and remissness, often so little merited. Thus conducted, this work may in some sort, be regarded during the course of its publication, as a journal or record devoted to the investigation of the whole class of Echinodermata; and I shall be happy to record there any new facts which may be transmitted to me.

"The new species, which have been omitted in the chapter devoted to their genera, will be described in the supplements which will accompany the monographies, as often as there is occasion for them. I have (that my correctness may be tested) caused plaster casts to be made of all my new genera and species when the specimens would permit, which I now offer to museums and individuals in hopes of obtaining by exchange new materials for my work."

The present *Livraison* is devoted to the consideration of the *Salénies* the number of whose species he has quadrupled and divided in the following manner.

1. Those having the anal aperture in front, comprising I. *personata*, Ag. the *Cidaris personata* of DeFrance. II. *scripta*, Ag. The only example of this species which I have seen, forms part of the Paris Museum, and was communicated to me by M. Valenciennes; its origin is unknown. III. *petalifera*, Ag. *Echinus petaliferus*, Des M. IV. *geometrica*, Ag. V. *scutigera*, Gray. *Cidarites scutiger*. Münst. VI. *gibba*, Ag. VII. *S. trigonata*, Ag.

2. Those having the anal aperture placed posteriorly. VIII. *S. stellulata*, Ag. IX, *S. areolata*, Ag. Chapter II treats of the new genus *Goniopygus*, Ag. containing the following species: I. *G. peltatus*, Ag. II. *G. intricatus*. III. *G. Menardi*, Ag. *Echinus Menardi*, Desm. IV. *G. heteropygus*, Ag. V. *G. globosus*, Ag. VI. *G. major*, Ag. Chapter III contains the genus *Peltastes*, Ag. in two species, viz. I. *P. pulchellus*, Ag. II. *P. marginalis*. Chapter IV is devoted to the genus *Goniophorus*, of which he has described I. *G. lunulatus*, Ag. and *G. apiculatus*, Ag.

The above enumeration of species comprises the contents of the 1st Livraison of thirty two pages of description and five plates. Each species described is illustrated by eight figures on stone by M. Nicolet, very beautiful, but still small, although some of the parts are much magnified. We could wish that he may be cheered in his noble exertions for the advancement of Geological Science, not only by the liberal patronage of his work among our countrymen, but also by the transmission of specimens in this branch of Natural History, which will then be accurately figured and ably described earlier than we can hope to do it at home.

44. *Solid impressions and casts of Drops of Rain.*—Mr. Cunningham communicated to the Geological Society, Feb. 27, 1839, an account of impressions and casts of drops of rain in the quarries at Storeton Hill, Cheshire, England. The effects of a shower falling on very fine ashes of Vesuvius in 1822, are seen in the rounded globules like those that arise from sprinkling water on a dusty floor; these accumulated globules formed a mass in some places a foot or more thick, and they became afterwards so firm as to require a smart blow with a hammer to break the mass.

In the Storeton quarry, where the footsteps of the chirotherium were found, "the under surface of two strata at the depth of thirty two and thirty five feet from the top of the quarry, presents a remarkably blistered or watery appearance, being densely covered by minute hemispheres of the same substance as the sandstone. These projections are casts in relief of indentations in the upper surface of a thin subjacent bed of clay and due in the author's opinion to drops of rain. On one of the layers of clay they are small and circular, as if produced by a gentle shower; on the other, they are larger, deeper, and less regular in form, indicating a more violent operation possibly accompanied by hail. On the surface of these layers of clay there are also impressions of the feet of small animals, which appear to have passed over the clay during the showers or not long before. Ripple marks are also exhibited on the surface of many sandstone strata in the same quarries." Prof. Hitchcock of Amherst, Mass., is also disposed to believe that he has found similar appearances in the sandstone of the Connecticut river valley, and we understand from him that a specimen of the stone has been taken to England by Prof. Shepard for the purpose of comparison.—*Lond. and Edin. Phil. Mag. sup. July, 1839.*

45. *Megatherium.*—Mr. Owen, after a careful examination of the related animals fossil and recent, and especially of the armadillo, concluded that the Megatherium had not a bony armor, and states that in no case among twelve skeletons of that animal of which he gives a table, did any

portion of bony armor occur with or near the bones: he concludes that both by its tegumentary covering and its osseous system it is more nearly allied to the ant-eaters and sloths than to the armadillos.—*Id.*

46. *Hot Springs.*—Hot springs burst forth in great force about seven and a half miles east of Singerli, in Asia Minor; the temperature is supposed by Mr. Hamilton to be equal to that of boiling water.* Depositions in some places eight or ten feet thick occur around the mouths of the springs with a strong sulphureous smell; yet the cool water is tasteless. The water after flowing a mile and a half and turning several mills is used for a warm bath.—*Id.*

47. *Additional Observations on the Meteors of November 13 and 14, 1838.*

1. *Canton, China.* Through the zeal of Rev. Peter Parker, M. D., watch was maintained by several observers on the nights of the 12th and 13th Nov. 1838, and some time subsequent. From a notice published by him in the Canton Register of Dec. 11, 1838, it appears that the chief display was during the night of the 13th. "The meteors of the 13th with few exceptions, were very similar to each other. They bore no comparison with the splendid meteoric shower of November 13, 1833, which I fortunately witnessed in America, yet they were more than ordinary. *Thirty one* were seen in the quick succession of half a minute, and one minute, others at longer intervals during *the few hours of clear sky* of the night."

2. *At sea, N. lat. 8° 27'; W. lon. 23° 48'.* *Observations by Rev. S. R. Brown, and Rev. David Abeel, on board the ship Morrison bound for Canton.* By a letter received here from Mr. B., we learn that the night of the 13th–14th, was chiefly clear, and that early in the evening meteors were rather more numerous than usual. "From 2h. to 4h. A. M. we numbered *fifty*, and from that time till the moon rose, about a quarter before 5, we took note of *twenty five* more. Thus there were about 25 an hour from 2 to 5 o'clock according to our reckoning. Soon after the moon rose, the sky was overcast so as to prevent any further observations. All these meteors were rather small, except one which shone with a splendor and red light like that of a rocket, and exploded much in the same manner. They all either radiated from a point in the curve of the *sickle* (in *Leo*), or else their paths being traced back would intersect each other somewhere between *Regulus* and λ *Leonis*. In appearance they were somewhat unlike ordinary meteors, their trains of light being longer and rather more permanent than is usual, while their direction was from E. to W. in most cases and always from the point before mentioned. Sometimes they shot across and behind an intervening cloud."

* Memoir by W. I. Hamilton, Esq., on the Geology of the western part of Asia Minor.

48. *Stars missing*.—The *Greenwich Observations for 1837*, (recently published in a large quarto volume,) contains the following list of stars which have been repeatedly sought for at the Observatory, but of which no traces are now discoverable. In the *Astronomical Society's Catalogue*, the stars Nos. 337, 805, and 2460; the stars L and c', observed at Cambridge with Halley's comet; (Camb. Obs. 1835;) and the following stars observed by Sir John Herschel with Halley's comet, (Ast. Soc. Mem. Vol. X,) A. R. 10h. 12m. 10s., N. P. D. $99^{\circ} 17'$; A. R. 15h. 38m. 31s., N. P. D. $119^{\circ} 30'$; A. R. 15h. 41m. 4s., N. P. D. $119^{\circ} 16'$ (?); and A. R. 15h. 42m. 39s., N. P. D. $119^{\circ} 6'$. Thus ten small stars, at least, have disappeared from the places which they once occupied in the heavens.—*Railway Mag.* June, 1839.

49. *Double Stars*.—It is a curious fact that has often been noticed as indicating one common cause for the motions of the planets about the sun, and about their own axes, that except the satellites of Herschel, they all move one way. The comets, however, seem to obey no law, as they are found moving in almost all possible directions. Professor Mädler, of Berlin, was led to inquire whether a uniformity in the motions of certain fixed stars about others, might not exist, like that among the planets. The result is, that out of 51 cases, 34 are in favor of it and 17 against it.—*Ibid.*

50. *Five or more rings around Saturn*.—On the night of May 29, 1838, the astronomers of the Roman College, using their large and excellent telescope (of Cauchoix's manufacture) thought they saw several new divisions in the rings of Saturn. Careful examination on the 7th of June following, rendered perfectly certain the existence of four distinct rings around that planet. M. Decuppis was invited to assist in the observations, and on the night of June 18, he distinctly saw the four rings. On attentive examination he imagined that he saw a new division in the interior ring. A higher power was applied, and it was then evident to all the observers that there were *five* rings. A fifth division was indistinctly traced, dividing the third ring; reckoning *from* the planet. This division was again seen June 27 and July 10, and more clearly than at first. Micrometrical measurements of the planet, rings, &c. were several times taken, and are given in the table below.

M. Decuppis adds, that they saw with perfect distinctness and certainty, the *seven* satellites of Saturn, two of which have probably never been hitherto seen except by Herschel.

A law similar to that detected by Bode among the planets, obtains among these satellites; their distances from Saturn being represented

by 1, 2, 4, 8, 16, . . . 64. There seems to be a blank between the sixth and seventh; to be filled perhaps by the discovery of a new satellite; as was the apparent *hiatus* between Mars and Jupiter by the four telescopic planets.

Table of the approximate dimensions of Saturn and of his rings.

	French leagues.
Equatorial diameter of the planet, - -	28,664
Interval between Saturn and interior ring, -	6,912
Internal diameter of do. -	42,488
Diameter of first division, - -	45,468
second, - -	49,720
third, - -	52,806 ?
External diameter of interior ring, - -	54,926
Interval between the two rings, - -	648 ?
Internal diameter of the exterior ring, - -	56,223
Diameter of the fourth division, - -	60,286
External diameter of the exterior ring, - -	63,880
Thickness of ring, according to Herschel, -	36 ?

Comptes Rendus Acad. Sci. Sept. 24, 1838, p. 658, 9.

It will be remembered that several divisions in Saturn's ring have long been suspected and occasionally seen, as by Cassini, Short, Quetelet, and Kater; but the evidence hitherto brought forward is far less satisfactory than that above recorded.

51. *Solar Painting*.—The barbarous term, *Daguerrotype*, invented to commemorate M. Daguerre, the discoverer of the improved method of copying figures by the sun's light, denotes the instrument by which this beautiful result is obtained.

M. Arago has recently revealed the secret to the French Institute at Paris. We omit his recapitulation of the rise and progress of discovery in regard to the effect of the sun's rays on colors, and also the more appropriate notice of the labors of M. Niepce, who preceded M. Daguerre in the research.

The following is the account of the process of M. Daguerre:—A copper sheet, plated with silver, well cleaned with diluted nitric acid, is exposed to the vapor of iodine, to form the first coating, which is very thin, as it does not exceed the millionth part of a millimetre in thickness. There are certain indispensable precautions necessary to render this coating uniform, the chief of which is the using of a rim of metal round the sheet. The sheet thus prepared, is placed in the camera obscura, where it is allowed to remain from eight to ten minutes. It is then taken out, but the most experienced eye can scarcely

detect any trace of the drawing. The sheet is now exposed to the vapor of mercury, and when it has been heated to a temperature of 60 degrees of Reaumur, or 167 Fahr., the drawings come forth as if by enchantment. One singular and hitherto inexplicable fact in this process is, that the sheet, when exposed to the action of the vapor, must be inclined, for if it were placed in a direct position over the vapor the results would be less satisfactory. The angle used is 48 degrees. The last part of the process is to place the sheet in a solution of the hyposulphite of soda, and then to wash it in a large quantity of distilled water. The description of the process appeared to excite great interest in the auditory, amongst whom were many distinguished persons connected with science and the fine arts.

Unfortunately the locality was not adjusted suitably for the performance of M. Daguerre's experiments, but we understand that arrangements will be made for a public exhibition of them. Three highly curious drawings obtained in this manner were exhibited; one of the Pont Marie; another of Mr. Daguerre's atelier; and a third of a room containing some rich carpeting, all the minutest threads of which were represented with the most mathematical accuracy, and with wonderful richness of effect.—*London Globe of 23d August.*

We have to add, that a professional gentleman in New York informed us before the late arrival of the British Queen, (which brought the first printed account of M. Arago's disclosure,) that he was in possession of the secret, and in connection with an eminent chemist in New York had already obtained beautiful results, but is not able as yet fully to arrest them.

The surface of the mercury should be as large as the plate.

Practical difficulties are encountered in giving the mercury the proper temperature and in avoiding the corrosive vapors so distressing to the eyes; but we trust that these and all other difficulties will be overcome, and that we may have the pleasure of announcing the entire success of the ingenious experimenters.—*Eds.*

52. *Aurora Borealis of Sept. 3, 1839.*—An auroral display of the most magnificent character was seen throughout the country on the night of September 3, 1839. An account of observations upon it at various stations, will be given in our next number.

53. *Geological Surveys.*—We have before us numerous reports on geological surveys, most of which were named at the close of Vol. xxxvi. It has been found hitherto impossible to peruse and digest them intelligently, and indeed the wide range of geological exploration in the various states presents such voluminous details, that we are compelled to relinquish the effort to present even a condensed summary of them. This

we have in various cases attempted in former volumes—with what success our readers must judge. But we are almost in despair of carrying out this plan, because we have, from several states, annual reports; the same ground is explored first in generality and afterwards in specific details, topographical, geological, economical, &c.; in many cases the mineral features of certain districts and even of particular townships and estates are given; mountain ranges and valleys and systems of strata with their mineral and organic contents are described often with great minuteness, and this multifarious information scarcely admits of abridgment or generalization. The local facts and deductions are in many cases scarcely intelligible without sections, maps and plans, which when given we cannot copy; but more frequently they are postponed to a concluding general report, in which we are led to hope that all the materials will be arranged in symmetry and lucid clearness. For these concluding summaries we shall wait with no small interest, expecting from them much instruction; but we must be first placed in a condition to understand their extent and the manner in which they will be exhibited, as well as to appreciate our own various engagements before we can decide how far we can exhibit those results in this Journal.

That they will eventually be highly important both to scientific and economical geology, cannot be doubted. This will, we are convinced, appear still more conspicuously when after many more years of laborious research all our states and territories shall have been surveyed, and geologists of high attainments, under we trust a national direction, and sustained by national funds, shall give a clear digest of our scientific geology, and draw with a masterly hand, not only our great outlines but the most important of our local geological features. For the present our effort will be to record the progress of geological exploration without pretending to give even a summary of the facts, but selecting from this immense storehouse some leading particulars of chief interest.

Drawing near to the conclusion of the present volume, we can do little more than name three reports, reserving the mention of others to a future occasion.

1. Third annual report of the Geology of the state of Maine; by Charles T. Jackson, M. D., State Geologist, &c., 1839.

2. First, second, and third reports of the progress of the geological survey of the state of Virginia, for 1836–37 and 38; by Prof. Wm. B. Rogers, State Geologist.

3. Third annual report of the state of Pennsylvania; by Prof. Henry D. Rogers, State Geologist.

1. *Maine*.—Dr. Jackson's labors in this state have been repeatedly noticed in former volumes. The present report contains 272 pages, of which 59 are occupied by elaborate tables of the barometer and thermometer, and there is an appendix of 64 pages containing catalogues of spe-

cimens collected for the state in 1836-7 and 8; they exceed sixteen hundred in number and are arranged and ticketed. There are also ten other collections for the colleges, academies, and societies provided for by law. There is an introduction of 14 pages, containing a sketch of elementary geology as far as Maine is concerned. Under the head of Diluvial Deposit, it is said that there are abundant proofs of a cataclysm in every part of Maine—the course being from north towards the south, sweeping with it all loose materials and depositing them far from their parent beds; the record of facts in the state “is so legible that he who runs may read.” A letter of 10 pages is prefixed to the Report and addressed to Gov. Fairfield, explaining the progress and results of the survey.

To a highly practical people, having more in view the immediate pecuniary advantages of the survey than the higher claims of science, Dr. Jackson has thought it necessary to address strongly their love of emolument, public and private. This is a prominent and pervading object in the report, nor can we censure it, since it is probable that no other argument would have prevailed with the legislature to continue the survey, especially absorbed as it has been with the din of diplomatic and ministerial conflict, and the more ominous belligerent movements of armed bands on its disputed frontier. But as these clouds of war have rolled away, leaving a clear sky, we trust that the legislature will no longer hesitate to sustain their zealous and able geologist, until his laborious and responsible duty shall be consummated. In the letter to Gov. Fairfield, it is stated that *immense quantities of limestone have been discovered*, suitable for agricultural and common uses, and which may be afforded for twenty five to fifty cents a cask, instead of from two to four dollars, the present price in particular districts.

Eighteen pages are occupied by tabular results of the analysis of many varieties of soils, and five more by that of limestones applicable to agriculture as well as to other purposes. This important subject is strongly and deservedly urged upon the state as being of the highest importance to its agricultural interests, and we trust that Dr. Jackson's labors on this subject will be the beginning of a new era in the husbandry of Maine.

Black oxide of manganese has been discovered in immense beds on the Piscataqua river, and will doubtless be applied to great use in bleaching.

Extensive resources exist within the state for the *manufactures of iron and glass*, and the roofing slate on the Piscataqua will probably, on this side of the Atlantic, supersede the use of that of Wales.

Impressions of fern leaves with drooping fronds and of fuci, on the Waterville slate, geologically too ancient for the coal formation, indicate that the former plants “were brought down by some ancient river from higher land at the time when the present slate rocks were the bottom of some ancient sea.”

Diluvial markings are common on the rocks, generally they run N. and S., while the strata bear N. E. and S. W.

Boulders are common, some weighing twenty or thirty tons; in the town of Avon there is a granite boulder measuring $30 \times 20 \times 15$ feet = 9000 cub. feet or 643 tons; these boulders have been removed doubtless by ice and water from their native beds in the mountains to the north—probably of the Mount Abraham range. There are also boulders of novaculite and magnetic iron ore, the latter with granite boulders on the summit of an insulated hill with an infinity of deeply worn diluvial furrows, running N. 50° W. and S. 50° E., pointing directly to Saddleback Mountains. Every part of Maine evinces, that since the consolidation of all the rocks and the deposition of the tertiary clays, a deluge has swept along forcing large masses of rocks from their parent ledges and depositing them in distant regions.

Mount Abraham is 2470 feet high above the base, and 3387 above the sea. In a high mountain valley—June 16—in very hot weather, the explorers found abundance of ice still solid beneath rocks and moss. In Mount Vernon the strata of mica slate run N. E. and S. W., and dip in opposite directions on each side of the granite, which in a vein 90 feet wide and of unknown length in the direction of the strata, has broken through and elevated them.

Tertiary deposits form the substratum of a large portion of the valley of Augusta, and rise from 88 to 100 feet above the level of high water on the Kennebec.

In Bloomfield, gypsum is rapidly formed by the decomposition of pyrites, the soil affording the lime. At Cornville are rounded masses of fine grauwacke, filled with impressions of terebratulæ.

Boundary between Canada and Maine.

In lat. N. $45^\circ 48'$, long. $70^\circ 82'$ W. from Greenwich, the road crosses the frontier at 2000 feet elevation above the sea in Portland harbor.

On this hill or mountain, there is a new cottage formerly kept as a tavern by a French creole by the name of De Longe—"a large sign is here erected upon a post, on the dividing line, the British armorial bearings being painted on the north side of it, and those of the United States on the south."

Fossiliferous rocks.—A few miles from Moose river bridge, half a mile north of Parlin pond, a bed of fine grauwacke was discovered, replete with impressions of fossil shells, many perfect—among them terebratulæ, spiriferæ and turritellæ. These fossiliferous strata, cross Moose river and the head of Moose lake and extend far north to the Aroostock and from it were evidently derived the numerous erratic fossiliferous boulders which cover the country to the outer islands of Penobscot bay and the mouth of

Kennebec river. No fossiliferous rock occurs between; the masses increase in size as we approach their source, and immense numbers of smaller ones of six or eight inches in diameter, have travelled 126 miles in a right line; the marks on the fixed rocks leave no doubt as to the origin of the boulders in this state and of the truth of diluvial action on a great scale, and pervading great distances.

At Alna is a bed of oyster shells, forming a cliff 25 feet above the sea level, sloping down to about 6 feet above high water, 180 rods long by 100 broad; the shells are stratified and are in high preservation, except where the frost has crumbled them to a fine shell marl.

It is not credible that they are the result of Indian banquets, (the popular impression in all similar cases, which are numerous.) They are estimated at nearly 45 millions of cubic feet and we should judge must be an oceanic deposit in shallow waters, and afterwards elevated by force from below.

At Vassalboro' tertiary shells were found in digging a well; they were 50 feet above the Kennebec river, and the tertiary sea appears never to have risen more than 150 feet above the present tide waters in Maine.

Basalt in regular horizontal columns, springing in a dyke from a granite wall is found at Bristol; the rock contains olivine and crystallized basaltic hornblende.

A *trap dyke* two feet wide, lies in horizontal columns across a bed of limestone in Beech wood quarry. A dyke of red compact feldspar porphyry 10 feet wide, intersects granite in Raymond, and is itself intersected by two dykes of green trap, one 6 and the other 4 feet wide; the trap dykes being of course the most recent.

In Oxford a loose granitic rock is intersected by numerous trap dykes, presenting great contrast of colors.

Crystals of spodumene are found in detached blocks of granite in Windham.

Large ridges of diluvial gravel are called in Maine horsebacks and whale backs.

In the town of Liberty there are extensive beds of granular quartz well adapted to the manufacture of glass. Of that portion of Dr. Jackson's report which is devoted to agriculture, it is impossible within our limits to give any adequate account. It is both scientific and practical, and presents many useful results and directions especially in regard to the use of lime, of manure formed from peat, &c. It must be attentively perused to be fully appreciated. The report is sustained by important documents derived from the communications of others not only on agriculture, but on the leading objects of the survey.

Dr. Jackson and his coadjutors have acquitted themselves with so much ability thus far in the survey of Maine, that we must again express equally our confidence and our hope that this important labor will be fully carried

out by the State for its own honor and advantage and as an important aid to the cause of science.

2. *Survey of Virginia*, 1836, '37, '38.

3. *Survey of Pennsylvania*, 1839.

We have in Vol. xxxii, p. 192, mentioned with decided approbation the preliminary survey of Virginia, by Prof. Wm. B. Rogers. The preliminary report published by him on that occasion gave equally an earnest of the importance of the undertaking and of the talent and zeal with which it would be prosecuted.

We have mentioned (*Id.*) in similar terms the labors of his brother Prof. Henry D. Rogers in Pennsylvania; and the present notice will have reference to both the above, because the states are contiguous and have many geological features in common, and because also a similar mode of investigation has been pursued by these gentlemen.

Their reports are abstracts giving a brief sketch of their plan of research and of the progress in their plan of investigation during each season. They have great similarity in their mode of grouping the formations of the Appalachian and Allegany regions; we are indeed assured that they work in concert, and coinciding in their geological views, they have adopted the same method. Their cautious and laborious mode of research is likely to insure the approbation of all sound and judicious geologists, and when the entire body of their results with a multitude of illustrative sections and other delineations shall be made public, it does not admit of a doubt that the course of strict induction which they are pursuing will be fully approved.

The phenomena of structure, the illustration of the directions, and comparative energies of geological powers, are among the most important results of geological research. The wide scale of the formations which they are investigating and the apparently symmetrical operation of the great disturbing forces to which they have been exposed, will afford them the opportunity of elucidating perhaps more clearly than it can have been done elsewhere many important general views not always without novelty.

Such we presume are the general views of these gentlemen, although in their annual reports they are merely glanced at, but will have their full development in the end. We contemplate also with satisfaction the coincidence of similar labors in the State of New York whose formations are but the extension of some of the most important of those of Pennsylvania and Virginia. Able geologists are there in the field and we have already presented an earnest of the result of their examination although it is not now in our power to survey their most recent labors.

In relation to Virginia and Pennsylvania it is not our purpose to enumerate even the most important facts which the reports present. We cannot however omit the mention of a few.

A great abundance of hydraulic limestones has been discovered in the Appalachian series, and the interesting fact ascertained or confirmed, that, in all cases, these rocks are highly magnesian. Numerous analyses have settled this point; well known hydraulic limestones uniformly yielding by analysis a large proportion of magnesia, and limestones found by analysis to have a magnesian composition proving on trial to be decidedly hydraulic. When silica is entirely absent the hardening property is diminished but is still evident, while a small portion of silica is capable of giving full development to the character, provided the magnesia be abundant. It has been before proved in one or two instances in England that magnesia produces this effect, but it is now for the first time fully proved in this country by numerous careful analyses attended by corresponding practical trials of the cement. There is reason to conclude that as analyses are extended it will prove to be a universal rule that all magnesian limestones are capable of induration under water; limestones of this description probably form a very large proportion of those of the transition series, particularly in the great valley of Virginia, Pennsylvania, Maryland, and Tennessee; and the same fact has been abundantly proved as to these limestones from New York and Kentucky. Prof. W. B. Rogers finds that in them the carbonate of magnesia is 3 where that of lime is 5. The natural bridge of Virginia consists of magnesian limestone a part of which is eminently hydraulic.

The shells of the tertiary region of Virginia furnish an important resource for agriculture; but the proportion of carbonate of lime in the marls and other earthy mixtures varies very much. Not unfrequently the sulphuric acid formed from pyrites decomposes the carbonate of lime of the shells and forms sulphate of lime, a useful ingredient in the soil; in which are present also sulphates of iron, alumina, and magnesia, and even free sulphuric acid. The coal of Virginia has in many instances a composition which adapts it happily to use; the amount of bitumen varies between 27 and 38 per cent., the ash from 2 to 5, and the carbon from 75 to 80; a composition not unlike that of the Frostburgh coal in Maryland,* combining combustibility, endurance, and intensity. Iron ore is found in vast abundance in Virginia and of an excellent quality: gold is extensively diffused, and although justly regarded as an important interest of the State, it is practically of less importance than coal, iron, limestone, and gypsum. There is a large deposit of lead in Wythe county; and salt springs abound in the valley of the Holston—thirty thousand gallons are evaporated in a day, producing one thousand bushels of salt.

The sandstones of the Blue Ridge are now known to be subjacent to the limestone of the great valley, and from the peculiar attitude in which this rock, (the sandstone,) is found, and from the marine and littoral

* Which we have examined in situ and by analysis.

impressions with which it is sometimes crowded, it marks out the ancient coast line of a wide spread sea, beneath whose waters the vast extent of sedimentary rocks stretching westward from the Blue Ridge were successively deposited. The rock appears to have had a littoral origin, or at least to have been deposited in shallow water and near the margin of the sea. Throughout the whole of the vast area extending from the Blue Ridge westward, the strata are for the most part of oceanic origin. The ancient coast line has been traced out by Prof. H. D. Rogers, in a vast circuit north and west through Pennsylvania and New York, and even into the valley of the Mississippi, along the region of the great lakes—over which wide area similar geological laws prevailed—to an extent without any known parallel—marine and littoral animals prevailing throughout the whole of this region. The series of rocks is numbered and described in detail in the reports. The limestone of the great valley of Virginia affords numerous marbles—grey, white, red, and of many colors.

Near Wyer's cave a dyke of trap is found contiguous to the limestone, and is the only mass of "igneous rock intruded among the limestones of the valley;" it is observed also that along the line of the canal near Harper's ferry the sandstones are vitrified by the subjacent igneous rocks, while both they and the slates contain specks of epidote and chlorite, and the lower beds have a jointed structure and confused stratification. It is added, that in another place even the massive beds of hard sandstone "display the marks of those violent agencies to which they owe their present erect or inverted position, in countless intersecting joints and surfaces, polished by the attrition of rock grinding against rock, under the most enormous pressure."

Prof. Rogers is happy in his descriptions, which are pictures to the mind, and his style throughout is that of a scholar accustomed to good writing.

The rocks of Pennsylvania are in many respects very similar to those of Virginia, but in the latter state there are vast deposits of the marine tertiary which are absent from the former. We shall not attempt to give the characters of the various formations which are described by Prof. H. D. Rogers in regular order from the primary rocks to those above the coal formation.

No portion of the United States is richer in valuable minerals than Pennsylvania and Virginia. Coal, iron, lead, gold, limestone, gypsum, and valuable saline and mineral waters are among their treasures, and the marine tertiary affords to Virginia inexhaustible resources for agriculture. Large portions of secondary rocks appear to have been swept away by floods.

The Potomac marble, used for columns in the capitol at Washington, is member of the red sandstone formation; it extends into Pennsylvania and New Jersey on the one hand and into Virginia on the other. It is a con-

glomerate made up from pebbles derived from a great variety of rocks, of which a large proportion are limestone, and the cementing earth, frequently red and also of various colors, contains much lime mixed with other materials; when polished it is beautiful, especially in large masses. This rock belongs to the middle secondary, and appears to have been produced along with other rocks of the same age at a period subsequent to the elevation of the lower secondary, including the coal formation.

The red sandstone formation is frequently disrupted by trap, which rises above it in ridges and peaks, and has frequently indurated the shales and sands into a rock resembling a brick or tile.

The strata of the anthracite coal formation evidently owe their position and limits to elevation by fire, and denudation by water, which has often swept away extensive masses formerly connected.

We cannot enter upon the phenomena of the coal fields, nor upon the proofs of their disturbance, which are presented by their synclinal and anticlinal axes, and by innumerable indications of violent movements, as by the upheaving of the strata along certain lines, and "the simultaneous destruction of large portions of them by the scooping action of a mighty flood. To the effects of these grand geological dynamics Prof. Rogers will himself do justice in his final report.

The geological statistics of our surveys are now swelling annually into a vast magazine of materials entirely incompatible with the limits of a journal of science even to sketch, but affording to local interests a happy guide, and an encouraging excitement, while science will in the end vindicate her claims by drawing those conclusions which are the safer, and the more important as they are built upon a wider induction from facts well observed and faithfully described.

54 Dr. Hare's new Eudiometer.—At a conversation meeting of the Franklin Institute of Philadelphia, held May 23d, 1839, Dr. Hare exhibited an improved aqueous, sliding-rod, hydro-oxygen Eudiometer, and stated that this instrument enabled him to analyze the air accurately within thirty seconds. Being, however, made to be used with water, accurate results could not be obtained by it when carbonic acid was one of the products, of which an accurate measurement would be necessary. It would of course be impossible to ascertain how far an absorption of this gas by water might add to the absorption resulting from the combustion and consequent condensation of hydrogen. Hence, in order to analyze gaseous carburets, another eudiometrical instrument had been constructed many years ago, in which mercury was the confining liquid. The mercurial sliding-rod eudiometer, now laid before the Institute, was an improved modification of that instrument. The pressure within the receiver of the apparatus in question being varied, (by pushing in or pulling out the rod through a collet

of leathers, or stuffing box,) a communication was successively made, by means of cocks, with a reservoir of the gas to be analyzed, a reservoir of oxygen, and with a receptacle of ammonia: an appeal was made intermediately, in each case, to a mercurial glass syphon gauge, in order to bring the density, at the time of admeasurement, to the atmospheric standard. The ignition of the gaseous mixture was effected by means of the discharge of a calorimotor through a platina wire.

These preliminary explanations being made, the process for analyzing the carburetted hydrogen furnished by the Gas Light Company, was then performed by Dr. Hare's skillful and intelligent assistant, Mr. J. Bishop.

The following results were obtained, agreeably to several experiments in which the condensation and absorption were the same.

The oxygen employed having been first analyzed, by igniting it with three volumes of hydrogen, was found to contain four per cent. of impurity.

The gas exploded with the oxygen imparted to it, one measure of impurity for every 20 measures employed.

Hence, 20 measures being assumed as representing one volume, in order to have that quantity of pure gas, 21 measures were taken into the eudiometrical receiver, and were mingled and ignited with seventy-five measures of oxygen.

A condensation of thirty-five measures was found to ensue—one volume, or twenty measures, being attributable to the disappearance of the gas. Since by its conversion into carbonic acid, oxygen undergoes no change of volume, fifteen measures out of the thirty-five were to be ascribed to the oxygen consumed by hydrogen. But fifteen measures of oxygen require thirty of hydrogen, equal to a volume and a half; and thus it appeared that this last mentioned quantity of the last mentioned gas existed in the volume of gas subjected to analysis.

The residue, after being well washed with ammonia, was found to have lost fifteen measures, which, containing, agreeably to the known composition of carbonic acid, a like volume of carbon, represents the quantity of this element in the gaseous volume subjected to examination.

It follows, that there are three-fourths of a volume of carbon, and one and a half of hydrogen, condensed into one volume of the gas; so that in four cubic feet, there are three cubic feet of vapor of carbon, and six of hydrogen.

The gas obtained by passing the vapor of alcohol through a porcelain tube, has been found, by Dr. Hare, to contain a volume of carbon and a volume of hydrogen condensed into one volume. That obtained

from the same liquid by sulphuric acid, usually known as olefiant gas, and with which the former has been confounded, contains two of carbon and two of hydrogen in one volume, as is generally received.

The gas-light gas therefore contains twice as much hydrogen in proportion to its carbon, as those above described, and this might have been inferred from its being sufficiently buoyant for balloons, agreeably to Mr. Wise's aëronautical experience. As the excess of hydrogen tends to lessen the liability to smoke, it is presumed that the gas, as constituted, may be preferable, for the purpose of illumination, to such as contain a greater proportion of carbon.—*Journal of the Franklin Institute, July, 1839.*

55. *Fall of a Meteorite in Missouri, February 13, 1839.*—On the afternoon of the 13th of February, 1839, a meteor exploded near the settlement of Little Piney, Missouri, (lat. $37^{\circ} 55'$ N.; lon. $92^{\circ} 5'$ W.) and cast down to the earth one stony mass or more in that vicinity. Mr. Forrest Shepherd, of this city, who was at the time exploring this region in the line of his profession; viz. that of a mineralogical and geological surveyor; hearing of the explosion of the meteor, exerted himself to collect all the circumstances of the occurrence. He subsequently succeeded in obtaining several fragments of one of the stones thrown down by the meteor. Mr. Shepherd has favored me with an opportunity to examine these fragments, and has also communicated to me the details below related.

The meteor exploded between 3 and 4 o'clock P. M., of the 13th of February, 1839, and although the sky was clear, and the sun of course shining at the time, the meteor was plainly seen by persons in Potosi, Caledonia, and other towns near which it passed. At Caledonia, which is about nine miles southwesterly from Potosi, the meteor passed a little north, and at the latter place, a little to the south of the zenith. Its course was almost precisely to the west. The most eastern spot at which it was seen is about fifteen miles west of St. Genevieve, (or about lat. $37^{\frac{5}{6}}^{\circ}$ N.; lon. 90° W.)—the most western is Little Piney, near which it exploded. To the observers at the latter place, the meteor appeared of the size of a large star. They represent its motion as very slow; but do not state how many seconds it was in sight. We have no data for determining the meteor's size, or velocity, or the inclination of its path to the horizon. The direction of the meteor's motion with regard to that of the earth, was probably such that the velocity of the former would be apparently diminished; and as at Little Piney the meteor must have traversed only a small arc, its motion, to an observer there, would appear quite slow. At the time of the occurrence, Mr. Shepherd was on the western bank of the Missis-

issippi, near St. Mary's landing, and heard a distant report, which he was afterwards inclined to refer to the explosion of this meteor. At Little Piney, Mr. Harrison and others saw the meteor burst in pieces, and in a minute or a minute and a half afterwards, they heard three explosions in quick succession. Some of the inhabitants went in quest of the stones which they supposed had fallen, and finally found a tree which appeared to have been recently injured by the collision of some solid body. Near this tree they discovered (although the ground was covered with three or four inches of snow,) one of the meteoric stones, about as large as a man's head, partly imbedded in the earth; and from the circumstances of its position and appearance, there could be no reasonable doubt that this was the body which had struck the tree. It is to be hoped that further search will be made for other portions of this meteorite.

The total weight of all the fragments which Mr. S. has brought home, is 973 grains. The specific gravity of one of the small fragments is 3.5; but different portions of the stone may vary slightly in this respect, as they may contain more or less of the metallic matter. The resemblance between this meteorite and those of Tennessee, (this Jour. 17, 323,) of Georgia, (Ib. 18, 389,) and of Weston, Conn., is very close, and one might almost imagine that they were all parts of the same original mass. The cohesion of the stone is not great, as it crumbles under a moderate blow. Two of the fragments retain portions of the crust or exterior coating. This is a fifteenth of an inch thick, and bears evidence of intense ignition and partial fusion. It is black, with a wrinkled or cellular surface, and is traversed with seams. The general color of the interior is an ash-gray. The whole mass is studded with metallic particles, (varying from the size of small shot down to mere points,) and presents numerous rusty spots, and occasional small spheroidal concretions which do not appear to differ in materials from other parts of the stone. The little metallic masses (doubtless of nickeliferous iron) are attracted by the magnet; and are generally permeated by the earthy matter. They are mostly of an iron-white color, but several are yellow and slightly iridescent. One of these minute masses being removed from the stone, it was by the hammer at once extended into a thin lamina, and was evidently malleable. An analysis may be expected hereafter.

E. C. HERRICK.

Sept. 25, 1839.

Remark.—Having been familiar with meteorites and examined many of them, I hesitate not to say that I am perfectly assured of the genuine meteoric origin of the fragments described above, even without any reference to the testimony.—*Sen. Ed.*

56. *Explosions in American Coal Mines.*—Those distressing events formerly so frequent in England, are beginning to happen in this country.

It is desirable that the memory of them should not pass away, but produce a strong impression on the public mind, which may lead to all possible caution and to the use of every available protection, for as our numerous mines are wrought deeper, such casualties will become more frequent. We have heard of several explosions in our mines, but cannot present the details. We are assured even that our anthracite mines are not exempt from them. We should hardly have looked for their occurrence in them, although we have proved* that a large quantity of inflammable gas is extricated by heat from these coals. The following account is from the Richmond Compiler of April, 1839.

Explosion of Gas in the Black Heath Coal Mine.—The Black Heath Mine, worked by the “Black Heath Coal Company,” is one of the richest and most extensive in this country. It is twelve miles from Richmond, in nearly a western direction, and is situated in the midst of bituminous coal fields of unknown extent. The shaft from which the explosion recently took place, has not been long sunk, and we believe is the deepest in the Union: being more than 700 feet to its bottom. Upwards of 10,000,000 bushels of coal had been obtained in the pit reached by it; and none can conjecture how much more a further exploration would discover.

The steam engines and apparatus for hoisting coal from the shaft were excellent; and the system and facility with which the hoisting process was conducted, produced an average of about 2,500 bushels of coal per day. It is to be regretted that these operations—adding so much to our productive capital and commercial strength, have been interrupted—and this regret is increased by an afflicting catastrophe.

The explosion was most violent, but its origin is uncertain, although it is beyond all doubt that it occurred from neglect or disregard of the positive orders and regulations of the pit. The drifts and “*air coasts*,” (passages for the air from chamber to chamber,) were so arranged as to keep up constant ventilation. It is the general opinion that one of the doors of the *air coasts* must have been closed, and that thus the “Inflammable gas” accumulated on Sunday to such an extent as to produce the explosion soon after the laborers entered the pit, on Monday morning. Sir Humphry Davy’s safety lamp was regularly used in the mine, and no doubt is entertained but that it was used on Monday morning. It was commonly carried forward to test the presence of the gas. It may have been out of order; a slight rent in the wire gauze covering, would readily ignite the gas. Other lamps were used; and one of these may have been taken into a chamber or drift where the safety lamp had not

* This Journal, vii, pp. 78 to 100.

been presented. Either of these causes would have involved carelessness. The density and inflammability of the gas might have caused the wire to have become oxidated, and thus to fall to pieces; but that could not have occurred till after indication by flame inside the gauze, of a danger in the face of which it would have been madness in the laborers to remain. Whatever might have been the immediate cause, the arrangements and rules of the pit, drawn from the lights of science and experience in mining, were such as if properly attended to, to have insured safety. But would it not be well, in order to diminish the chances of danger from even *carelessness* itself, to use Davy's lamp *exclusively*, in all pits, where there has been an exhibition of carburetted hydrogen or "inflammable gas?"

One of the superintendents of the operations in the pit, who was below when the explosion took place, was a man of great skill in his profession, having been many years engaged in it, in some of the most famous of the English mines. He was a Scotchman, named John Rynard.

Mr. John Hancock, a native of Chesterfield, of respectable family, was the other unfortunate superintendent.

The laborers were all colored men. The superintendents above the shafts say that about forty were below. They cannot speak with certainty. Many had gone to distant plantations to see their wives, and it was not known how many had returned.

The explosion was so powerful as to blow pieces of timber out of the shaft to a distance of one hundred yards from it. Three men were blown up in a coal hamper, to a height of some thirty or forty feet above its top; two of them fell out of the hamper in different directions, and were immediately killed—the third remained in it, and fell with it, escaping most miraculously with his life, having both legs broken. He is now doing very well. Much loose coal was blown from the drifts to the bottom of the shaft, and four of the bodies, as we have already stated, were taken from beneath a large bulk there, in a mutilated state. Four were taken out shortly after the explosion on Monday—one of whom died. The others are in a fair way to recover.

Every possible exertion consistent with safety, has been made to rescue the unfortunate beings. It appeared upon going down the shaft, that much carbonic acid gas (the product of combustion) was present. This is called at the mines "black damp," and though not inflammable, is well known to be eminently destructive to human life. This then had first to be dispersed. The partitions too, in the shaft, necessary for the ingress and egress of air in the pit, were much torn to pieces by the explosion and had to be repaired, as death would have resulted to those who went down the shaft.

These explosions were formerly very common in the north of England. One occurred at the Felling colliery in Northumberland, England, on

the 25th May, 1812, in which 92 lives were lost. This is the greatest destruction ever known from the same causes. In 1815, an explosion occurred in a mine at Durham, in which 57 persons were destroyed, and in another, 22 were killed in the same manner. The discoveries of Sir Humphry Davy and other contributors to science and benefactors of mankind have since rendered it certainly possible to avoid these destructive explosions.

In our mines, no explosions of any extent has ever occurred from the ignition of inflammable gas. Such events may as certainly be guarded against as the bursting of steam boilers, the safeguards in each case being as simple as effective.

57. *Relative temperature of the water of the Saco river, and the atmosphere for the years 1837 and 1838.*—The table annexed gives the mean temperature of the water of the Saco river, and of the air as observed at Portland.—The fifth column shows what the temperature of the river would be, provided it was subject to no other influences than those of the atmosphere.—For example; take the month of September;—54° air in '37 : 63° .6 water in '37 :: 56° air in '38 : 65° .9; while the water by observation was 63° .2,—difference 2° .7. It will be observed that the difference in the mean temperature for the year is but $\frac{5.2}{100}$ of a degree.

I am aware that this is only an approximation to the truth, for in order to insure perfect accuracy, the observations should be made throughout the whole course of the river.

J. M. BATCHELDER.

	Air 1837.	Water 1837.	Air 1838.	Water 1838.	Ratio.
January, - - -	14°	32° .0	28°	32° .0	64° .0
February, - - -	19	32 .0	14	32 .0	23 .6
March, - - -	26	32 .0	32	32 .0	51 .2
April, - - -	38	36 .6	36	43 .1	32 .1
May, - - -	46	50 .2	49	53 .3	53 .2
June, - - -	58	63 .8	62	67 .6	68 .2
July, - - -	63	71 .4	68	73 .5	77 .1
August, - - -	61	69 .0	64	72 .7	72 .4
September, - - -	54	63 .6	56	63 .2	65 .9
October, - - -	44	49 .9	42	49 .8	47 .6
November, - - -	34	36 .6	31	36 .9	33 .4
December, - - -	24	32 .4	20	32 .0	27 .0
	481	569.5	502	588.1	
Mean temp. for the year,	40.08	47.46	41.83	49.01	49.53

58. *British Association.*—This interesting meeting convened on the 26th of August at Birmingham. Prof. C. U. Shepard of this city

(New Haven) was one of the number, and to attend the meeting went from London to Birmingham, one hundred and eight miles, in five hours. One thousand members appeared at the first meeting, and at a conversation assembly in the evening, one thousand five hundred were present of whom about one half were ladies; the scene was one of animated conversation with incessant promenading, and sublime music from the largest organ in the world played by a first rate German performer and composer. The evening was closed by a supper. The next day Sir Robert Peel, now in retirement from ministerial power, gave a splendid entertainment to a select party of scientific and literary men at his magnificent villa of Drayton Manor, 24 miles from Birmingham, at which our correspondent was present with Rev. Mr. Harcourt the President of the British Association, Drs. Buckland and Daubeny of Oxford University, Professors Peacock and Hopkins of Cambridge, Mr. de la Beche, Mr. Greenough, Mr. Hallam the historian, Prof. Shœnbein of Basle, Count de Tambone, the dean of Ely, Mr. Horner, Mr. James Peel, and others.

Scientific Excursion to the Dudley Coal Mines.—Friday, Aug. 30, a party of 450 in number went by canal in five boats to visit the Dudley coal and iron region. The canal is very large and expensive; manufactories are every where in view on all the route of nine miles, and for the last six miles it is one vast coal region; a bed of coal 30 feet thick passes under the whole country and deep pits descend into it in almost innumerable places, over which the lofty chimneys like shot towers were throwing out dense clouds of smoke, and over every one of them is a furnace both for the working of steam engines and for ventilating the mines. The party penetrated the vast tunnel, excavated about 100 years ago under Dudley castle, which was built as it is said in A. D. 700, or about that time. The tunnel, which is about three quarters of a mile long, is one vast cavern, in some places 60 feet high and every where from 30 to 100 feet wide. Large boats, holding each 60 persons, conveyed the party.

The sides of the tunnel were illuminated by 4000 candles, besides a splendid exhibition of lights disposed in regular figures at its extremity. For the first quarter of a mile, the party proceeded in almost the darkness of midnight, when suddenly they descried in the distance an immense concourse of people of both sexes, occupying an extended platform of the rock, which was illuminated by the light of day descending upon them through an opening carried up through the solid strata 150 feet to the surface. The effect was wonderful, and it seemed as though the party had arrived in another world, while shouts and cheers were given and returned. From the point where the illumination began, the company in the boats continued on while the people

on the platform accompanied them, walking along on the side of the cavern. A great cavern it literally is, and all the rock that has been blasted out is used as a flux for iron ore, and has been and is worth more than the richest mine in England. When they reached the end of the gallery Mr. Murchison gave a lecture, and the marquis of Northumberland (query—Northampton?) made an address. At a signal given, blue lights were kindled behind the columns of stone, left for the support of the mine, when suddenly all the cavern for a length as far as the eye could see, was illuminated, and repeated discharges of cannon at the entrance of the tunnel were reverberated in deafening echoes. Then came red lights alternating with the blue, thousands of persons manifesting their delight by cheering and clapping, and all united in the national hymn, God save the Queen. The party then returned to the mouth of the cave where they had landed and having formed a circle round an eminence, Dr. Buckland gave an interesting lecture of an hour, and after an excursion of a mile, Mr. Murchison, gave another.

59. *Proceedings of the Boston Society of Natural History, from September 19th, 1838, to March 21st, 1839. Compiled from the Records of the Society, by JEFFRIES WYMAN, M. D., Recording Secretary.*

In accordance with the intention of the Society, as explained in a preceding number of the Journal, the following contribution of the proceedings of the Society has been drawn up by its direction. It is proper to state that the original record was made by the late secretary, Dr. A. A. GOULD.

Sept. 19, 1838.—Dr. J. B. S. JACKSON, in the chair.

Dr. T. W. HARRIS exhibited and presented for the herbarium, specimens of the following plants; *Liatris scariosa* from Exeter, N. H.; which had also been found by Mr. Tuckerman in Cambridge—*Sabbatia chloroides*, with a white variety, growing on the clean sand, on borders of ponds in Plymouth, not on salt bogs as stated by Beck—*Drosera tenuifolia*, *Utricularia purpurea*, and *U. resupinata*, all from Plymouth.

Mr. G. B. EMERSON had also found the three species of *Drosera* growing together at Plymouth, and also four species of *Utricularia*.

Mr. E. had lately visited the Saddleback Mt., which he strongly recommended to the notice of every lover of nature. He exhibited specimens of *Taxus Canadensis* and *Pinus Fraseri* from this locality.

Dr. STORER had recently met with two rare fishes, and had been able to determine them satisfactorily. One of them, commonly called

Havre mackerel or Albicore, proves to be the tunny, *Thynnus vulgaris*, of the Mediterranean.* The other is the *Xiphias gladius*, sword fish, which Dr. Richardson thinks does not exist on this coast. This, however, as well as several others, was taken near Martha's Vineyard. Great discrepancy exists in the figures of this fish, especially as to the dorsal fin.

Dr. S. also stated that the Siren recently presented by Mr. Olmstead was the *Menobranchus lineatus*.

Mr. T. M. BREWER had met with the *Lestris pomerana*, or Yager, killed on the south shore. It is said by Nuttall to come only as far south as Hudson's Bay.

Mr. EDWARD TUCKERMAN, Jr., exhibited specimens of *Crypta minima* found at Cambridge in company with another plant of similar character. Beck places this plant in the genus *Adatone*.

Oct. 22, 1838.—G. B. EMERSON, Esq., President, in the chair.

Dr. STORER communicated a paper from Dr. Kirtland of Ohio, describing several new species of fishes from the waters of that State. Dr. Kirtland is engaged in the zoological survey of the State.

Dr. T. M. BREWER presented some specimens of madrepore taken from the stomachs of fishes on the coast of Labrador. He also presented the eggs of the following birds:—*Fringilla socialis* and *tristis*—*Sylvia aestiva*—*Sturnus Ludovicianus*—*Turdus polyglottus* and *Ardea virescens*.

Mr. E. TUCKERMAN, Jr., read a paper entitled "Notices of plants new to the Boston Flora." The species detected by him, which were new to our Flora were as follows:—*Camelina sativa*—*Urtica urens*—*Viola primulifolia*—*Lechea thymifolia*—*Hypericum ellipticum*—*Sida abutilon*—*Malva sylvestris*—*Malva crispa*—*Sycyas angulata*—*Alnus undulata*—*Salix herbacea*—*Ceanothus ovalis*—*Elatine diandra*—*Sedum telephinum*—*Convallaria trifolia*—*Digitaria filiformis*—*Paspalum ciliatifolium*—*Setaria viridis*. He also added many new localities to numerous other rare plants. He added the testimony of his observation to the constancy of the characters of Bigelow's *Viola acuta*—*Salicornia mucronata* and *Sonchus spinulosus*.

Dr. A. A. GOULD, stated that he had recently received a specimen of *Helix aspersa* from Portland, from a gentleman who assured him that it was very common in that vicinity, and appeared in great numbers after the ground had been burned over.

Dr. AMOS BINNEY exhibited specimens of *Helices* from Martinique, and the beautiful *Carocolla spinosa*, Lea, of our Southern States.

* An individual of this species was taken in New Haven harbor in June, 1839.—E. C. H.

November 6, 1838.—Rev. F. W. P. GREENWOOD, Vice President, in the chair.

J. E. TESCHEMACHER, Esq., made a report on the *Gomphocarpus fruticosus*, a native of the Cape of Good Hope. It is one of the Asclepiadeæ, allied to *Asclepias Syriaca*; differing from it in the shape of the wings of the seed vessel and in not having a milky juice. The coma is composed of the pollen tubes and not of the compressed calyx, as in the composite plants.

Mr. TESCHEMACHER exhibited some crystals of stilbite and fluor spar, illustrative of the theory of decrement by solid angles, in which nature strictly accords with theory.

Dr. J. WYMAN exhibited the skeleton of a human fœtus of about the third month, illustrating the comparative size of the head and the rest of the body, the advanced state of ossification of the ribs and jaws beyond other parts of the skeleton; this last observation is interesting in connection with the fact, that respiration and nursing, in which the jaws and ribs play an important part, are the first voluntary acts of the new born child.

Mr. EDWARD APPLETON had noticed a hyacinth whose bulb had been accidentally planted in an inverted position. A scape had descended into the earth and was terminated by a spike of colorless flowers, the whole plant being six inches in length. When placed erect in the earth they did not survive.

Dr. C. T. JACKSON exhibited some maize from the Rocky Mountains, with only two kernels in each husk, and stated that it was not yet determined whether it was a new species or merely a variety.

Dr. RAY of Augusta, Ga., being present, observed that it was not unlikely to be the normal form of the fruit of the bread corn. A partial calyx encloses two kernels, and a number of these are enclosed in a common calyx. It is supposed that the partial calyces are obliterated by pressure of the kernel enlarged under cultivation, thus forming the ear as we usually find it. He states that this form had appeared in Tennessee, extending to Georgia, and did great damage to the crops, its farina being disseminated to the impoverishment of the full ear.

Dr. C. T. JACKSON gave an analysis of Indian pipe-stone from the famous quarry of Coteau du Prairie, and brought from thence by Mr. Catlin, the first white man allowed by the Indians to visit it. The layers of pipe-stone are overlaid by polished quartz rock in which are found relievos, which must have been wrought by the hand of man; the Indians however declare them to be the tracks of the Great Spirit. It is usually called steatite, but is not this mineral; it is harder than gypsum and softer than carbonate of lime. Dr. Jackson

proposes for it the name of **Catlinite**, in honor of the famous delineator of the Indians. The following is the result of chemical analysis.

Water,	-	-	-	-	-	8.4
Silica,	-	-	-	-	-	48.2
Alumina,	-	-	-	-	-	28.2
Magnesia,	-	-	-	-	-	6.0
Carbonate of lime,	-	-	-	-	-	2.6
Peroxide of iron,	-	-	-	-	-	5.0
Oxide of manganese,	-	-	-	-	-	.6
						<hr/>
						99.0
Loss, probably magnesia,	-	-	-	-	-	1.0
						<hr/>
						100.0

December 6, 1838.—**REV. F. W. P. GREENWOOD**, Vice President, in the chair.

MR. EDWARD TUCKERMAN, Jr. read a paper entitled, "An enumeration of the Lichens of New England not included in our Floras, with notices of some interesting species." He also read a historical sketch of Lichenography; these papers being the commencement of a monograph to be prepared in connection with another gentleman.

DR. A. A. GOULD exhibited living specimens of the beautiful *Beroë Pileus*; and also the *Mysis Fabricii*, a species of crustacea, not previously observed in our waters, both taken from the river under Cragie's bridge.

December 18, 1838.—**GEO. B. EMERSON, Esq.**, President, in the chair.

DR. D. H. STORER stated that he had examined the donation of fishes received last summer from **MR. CORDIS**, and had ascertained that there were 87 species, belonging to the following 38 genera, viz. *Serranus*; *Merra*; *Plectropoma*; *Mesoprion*; *Holocentrum*; *Polynemus*; *Sphyræna*; *Mullus*; *Dactylopterus*; *Cottus*; *Scorpæna*; *Sciæna*; *Chætodon*; *Holocanthus*; *Caranx*; *Zeus*; *Acanthurus*; *Mugil*; *Blennius*; *Julis*; *Scarus*; *Clupea*; *Alosa*; *Chatoessus*; *Engraulis*; *Monochamus*; *Solea*; *Echineis*; *Ammodytes*; *Hippocampus*; *Tetraodon*; *Balistes*; *Monacanthus*; *Ostracion*; and *Carcharias*.

DR. J. WYMAN had examined as far as practicable the collection of fossil bones recently received from Athens. They were principally bones of large Ruminants mixed with those of Solidungulated animals. Those of the former consisting of fragments of jaws, head of a tibia, and lower extremity of a femur; those of the latter were metacarpal and phalangeal bones.

January 16, 1839.—Rev. F. W. P. GREENWOOD, Vice President, in the chair.

Dr. MARTIN GAY made a report upon some specimens of minerals committed to him, and more particularly upon what is termed Arborescent native Silver. It is usually supposed that minerals assume the arborescent, fibrous form, by a sort of crystallization. But he had been led to suppose that it was produced mechanically, something in the following way: A mass of ore is subjected to heat, sufficient to reduce the metal to a semifluid state. This is suddenly cooled, when the whole mass as suddenly contracts, and forces out the metal through the interstices of the matrix in the thread like form in which we find it. Dr. Gay has in his possession a piece of copper ore which he took from a furnace and which afterwards presented upon its surface these so called arborescent crystals. Dr. Gay had not heard the phenomenon accounted for in this way, nor met with any detail of so plausible an explanation in any book.

Dr. D. H. STORER announced the reception of a collection of fishes from Puerto Cabello, among which were the following genera; Mesoprion; Prionotus; Hemiramphus; Exocetus; Clupea; Caranx; Chætodon and Acanthurus.

February 5, 1839.—Geo. B. EMERSON, Esq., President, in the chair.

Dr. D. H. STORER read a letter from J. G. Anthony, Esq., of Cincinnati, Ohio, containing the description and figure of a new species of *Anculotus*, found near that city, to which he gave the name of *Anculotus costatus*. Also announcing a new species of fossil *Calymene*, and another curious fossil recently discovered by him and about to be published.

SIMON E. GREENE, Esq., stated that he had lately seen the *Parus Hudsonianus* in Brookline, which is much farther south than it has been before noticed. Audubon had seen it in Labrador, and believed that it had been seen in Maine. Nuttall mentions its original discovery at Hudson's Bay.

Dr. T. M. BREWER exhibited the skin of a goose, killed in Boston harbor, and which is rarely seen in this region; it was the young of the snow goose.

Dr. J. WYMAN exhibited the head of a young Lemur, (*Lemur cotta*), from Madagascar—also specimens of "measly pork" in which were vast numbers of parasitic animals, inhabiting the cellular membrane; they did not agree in their characters with the *Cysticencus*, which is usually described as constituting this disease.

February 20, 1839.—Rev. F. W. P. GREENWOOD, Vice President, in the chair.

J. E. TESCHEMACHER, read a report on the fruit commonly called the sea-cocoa. It was the fruit of the *Lodoicea Sechellarum*, a noble palm, found only at the Seychelles Islands, a small rocky and mountainous group, to the northeast of Madagascar. He gave an account of its fabulous history, and of its final discovery at these islands in 1743, after which, it was described by Sonnerat. Previous to this period, it had only been found floating on the sea, about the Maldivé Islands. As a medicine, the nut was regarded as a specific for all maladies. It was highly valued, and esteemed one of the most costly of regal gifts. Rochon says, the Emperor Rhodolphus offered 4000 florins for one; and that another was valued at £400. A particular account was given of the tree, and its mode of fructification illustrated. He also proceeded to demonstrate that the shell of the nut was but a modification of the leaf; and made an interesting demonstration of the hilum and the course of the nutritive vessels, which were here exhibited on a large scale.

Dr. T. W. HARRIS, had in his possession some notes, which went to show that Sonnerat was not the discoverer of this plant, but that it was discovered by Alexis Marie de Rochon, as early as 1679.

Mr. EDWARD TUCKERMAN, Jr., presented specimens of *Marchantia polymorpha*, with its fructification, and another specimen of which he had not determined the species.

March 6, 1839.—Rev. F. W. P. GREENWOOD, Vice President, in the chair.

Dr. A. A. GOULD, exhibited specimens of a rare shell from the northern Atlantic shores. It was originally described by Beck, as a fossil shell from the St. Lawrence Bay, and is figured in Guerin's *Magazin de Zoologie*. It is not a fossil shell. It is named *Rostellaria (Aporrhais) occidentalis*, and is frequently taken from the stomachs of codfish taken on the bank fisheries. A nearly entire one has been found near Portland, one at Saco Beach, and another at Nahant Beach, and numerous tips of the spire at Phillips Beach and other points in our harbor.

Mr. J. E. TESCHEMACHER, presented numerous specimens of vegetable impressions from Bridgeport coal mines, N. S. Most of them were ferns, and one of them appeared to be a seed-vessel;—there were also other forms which he had been unaccustomed to see.

A large and exceedingly valuable collection of zoological specimens, recently received from Dr. F. W. Crogin, of Surinam, was laid on the table. It consisted of a great variety of mammalia, birds, rep-

tiles, fishes, insects and crustacea. Among them were specimens of the *Molossus ater*, *Didelphis opossum*; Surinam toad (*Rana pipa*); *Gymnotus electricus* and others equally rare and valuable.

March 21, 1839.—G. B. EMERSON, Esq., President, in the chair.

Mr. J. E. TESCHEMACHER, read a report on Darlington's "Flora Cestrica." This work contains a vast quantity of original and valuable information; the details are minute and correct. It is the work of a thorough and zealous botanist of the Linnæan school. The minute and faithful description of many plants renders it indispensable to the library of the botanist.

Mr. T. also made a report on some minerals from Franconia; viz., Garnets associated with iron, and green Epidote, *Andalusite* or Mackle; this had been analyzed by Dr. C. T. JACKSON, but he did not indicate the black substance connected with it. Upon analysis Mr. T. found it to contain $\frac{4}{12}$ magnesia, and concluded that it was hornblende.

Mr. T. had examined a doubtful mineral from Franconia, and found it to be the black sulphuret of zinc, or blende, in the unusual form of the rhomboid dodecahedron. It is of rare occurrence, and may indeed be worthy to be considered as a new species.

Dr. D. H. STORER, spoke of the changeable localities of the Mollusca, and mentioned particularly the *Nucula thraciæformis*, which was not uncommonly found a year since, in the *Platessa dentata*, taken off Race point, Cape Cod; but though these fishes have been taken there more abundantly than usual during the past winter, only a single specimen has been heard of. The same fact with regard to other species sometimes found abundantly on our coast, was adverted to by Messrs. Emerson & Gould.

Dr. J. WYMAN, made a report on three specimens of bats, two of which were from Surinam, and the other from this state. The former were specimens of the *Molossus ater*, a male and female. The Molossi are characterized by incisors $\frac{11}{11}$, those of the lower jaw seeming to be crowded out of their places by the great development of the canines; ears broad, meeting on the median line over the nose; tragus round, outside of concha; hair black; tail not developed by interfemoral membrane. The other specimen was the *Vespertilio emarginatus*.

60. *British Antarctic Expedition*.—The British Government have determined to send out an expedition for scientific discovery in the Antarctic seas, under command of Capt. James C. Ross. The scientific instructions prepared for the expedition, by the Council of the Royal Society, are given in the London Athenæum, August, 1839.

61. *Liquefaction of Carbonic Acid.*—In Vol. xxxv, p. 346, we republished from the Franklin Journal an account of the liquefaction of carbonic acid by Prof. J. K. Mitchell. Dr. Hare, Dr. Torrey, Dr. J. W. Webster, and Prof. Bailey have labored with success on this subject. A letter from Prof. Bailey contain the following remarks :

I have had several fine trials of Prof. Mitchell's apparatus and can now manage it with perfect ease. I have repeatedly made masses of the solid CO_2 as large as two fists, and have frozen by means of it as much as four ounces of mercury into one mass. Several of my students have had blisters raised on their hands by pressing the solid into close contact with the flesh.

West Point, January 21, 1839.

62. *A new mineral.*—Dr. Charles T. Jackson, of Boston, has just discovered a new mineral among those which he brought from Chessy copper mines in central France. He was led to analyze it in consequence of its resemblance to the artificial crenates of copper which he had formed while analyzing peat and soils; he then discovered that it was a *native Crenated Hydro-Silicate of Copper*.

Composition, Silica 21.0; Oxide of Copper 46.8; Crenic acid 15.8; Water 10.0; Al. and Ox. Iron 4.4; Carb. Acid 2.0 = 100.

Dr. Jackson names this new mineral Beaumontite, after the celebrated Prof. L. Elie De Beaumont of Paris.*

63. *Progress of the U. S. Exploring Expedition.*—We learn from the National Intelligencer that letters were received in August last, stating that the vessels of the Exploring Squadron which departed from Tierra del Fuego Feb. 26, 1839, had succeeded in pushing their explorations to a point farther south than American enterprize or the exploring vessels of the French and the Russians had ever penetrated. They returned to Valparaiso about the middle of May. The officers and crews of the different vessels were generally in excellent health and spirits, notwithstanding the fatigues which they had undergone.

By more recent intelligence it appears that the *Relief* arrived at Callao on the 5th of June, and that the other vessels had sailed for Juan Fernandez.

64. *Mechanical Vaporization of Earths by distillation; extract of a letter to Prof. Silliman, from Willis Gaylord, dated at Otisco.*—My inquiry of you respecting distilled water, or whether distillation completely separated it from all earthy ingredients, arose from the manner in which some writers have spoken of the effects of watering plants with distilled

* Not less known for his scientific attainments than for his courtesy to strangers, especially Americans.

water, as though all earthy ingredients were separated. Of this I have some doubts, and think that distilled water will contain as much earthy matter as plants require in ordinary cases. Our water in this section of country as you are well aware, contains large quantities of sulphate or carbonate of lime in solution, while the water is as transparent as air. A short time since from the steam pipe of an old distillery, a pipe through which nothing but steam had ever passed, I cut a section of the wood, and this disclosed a perfect tube of stone nearly three eighths of an inch in thickness, smooth and solid. The base of it is lime, as it effervesces freely in muriatic acid; and of course it must have been arrested from the steam in its passage, by condensation against the sides of the tube. I have no doubt that silex when in a state of solution would also pass over in all the necessary quantities required to perfect plants; and hence deem the doctrine that the earths found in plants watered with distilled water, is created by them, absurd. Your answer confirmed me that my suspicions were correct; and that the theories built on distilled water are in the main untenable.

65. *New Hall of the Academy of Natural Sciences at Philadelphia.*—We are happy to observe that this early and most respectable institution is soon to be accommodated by a new fire proof building forty five feet front by eighty five deep, which will contain “a single saloon with ranges of galleries, beneath which, in the basement, will be a lecture room for five hundred persons.”

WILLIAM MACLURE, long known for his great munificence to objects of science and benevolence, has contributed twenty thousand dollars* to the society during the last two years, seventeen thousand of which have been reserved for the erection of the building, and this sum has been greatly enlarged by the liberal subscriptions of members and others friendly to the cause of science.

The foundation stone of the building was laid May 25, 1839, and a very appropriate discourse delivered by Walter R. Johnson, A. M., M. A. N. S., &c. &c.

Philadelphia and New York may now vie with each other in the accommodations of their respective academies; the younger sister having been laudably emulous of the fame and worthy deeds of the elder.

66. *Dr. Hare's method of removing the resin which contaminates the best Oil of Turpentine of commerce by an alcoholic solution of Chloride of Calcium.*—Mr. Guthrie recommended some years since in an article published by us, the employment of diluted sulphuric acid to remove resin from Oil of Turpentine. Dr. Hare has for the same purpose used suc-

* An invaluable library and many specimens in natural history had been before given to the Academy by Mr. Maclure.

cessfully a saturated solution of Chloride of Calcium in Alcohol, which he considers as preferable because the acid is liable to produce a resin as well as to remove it from the oil.

67. *British Annual and Epitome of the progress of Science for 1839.* Edited by R. D. Thomson, M. D. London, 1838.—It might seem inappropriate to notice an *Annual* so long after the time of its appearance, were it not that this little work, like its prototype the *Annuaire*, contains information of lasting and general interest on many subjects, while its minute and accurate tables give it the character of a hand book for all classes of readers. We have been much struck in the perusal of this and the previous volumes with the valuable condensation they contain of different scientific subjects. Of this character are Dr. Robert E. Grant's general view of the characters and the distribution of extinct animals in the present volume. On the principles of classification as applied to the primary divisions of the animal kingdom by the same author; and a sketch of the history and present state of Geology, by Thomas Thomson, M. D., F. R. S. But it may appear invidious to attempt a distinction among so many articles where all are of great value, and we accordingly give a classified condensation of the table of contents of the present volume.

An Astronomical Calendar; Table of the Chronology of Science; Weights and Measures and Coins of many countries; Table of Specific Gravities and Atomic Weights; Universities, Academies of Science, Professional Schools, &c. in Britain, Ireland, France, Holland, Russia, &c.; Population and Power of Europe, Asia, Australia, and the Polar regions; Statistics of the World; British Population; Crimes and Punishments; Steam Navigation; Learned Societies; Dr. Grant's view already named; Hints on National Education; New Chemical Substances.

We have heard with much regret from the learned editor (to whose polite attention we owe the receipt of the three volumes of the *Annual* now published) that this interesting work will probably be discontinued after the present year, owing partly to want of encouragement and partly to the pressure of numerous more important duties. We cannot but hope however that so valuable a work will be continued.

68. *Longitude of New York.*—At the very conclusion of our number we have received from Messrs. E. & G. W. Blunt, a copy of a paper read by Mr. E. J. Dent, F. R. A. S. before the British Association at Birmingham, Aug. 26, 1839, giving the details of a recent successful experiment to determine by means of Chronometers, the dif-

ference of longitude between Greenwich and New York. Our limits permit us to give only the results. The longitude of N. Y. City Hall, resulting from the observations of three chronometers (sent by Mr. D. in July last, in the steamship *British Queen*; their rates being duly ascertained at Greenwich, Brooklyn, and again at Greenwich,) is 4h. 56m. 3.35s. W. As given by M. Daussy, in the *Connaissance des Temps*, it is 4h. 56m. 0.72s.; difference, 2.63s. As determined by R. T. Paine, Esq., and published in the *American Almanac*, the longitude of N. Y. City Hall is 4h. 56m. 4.5s. (previous determinations being about .5s. less,) which differs only 1.15s. from the result of these Chronometrical observations.

69. *Jay's Catalogue of Shells, 3d edition.**—At page 399 of Vol. 36, we acknowledged the receipt of a copy of Dr. Jay's new catalogue, intending to revert to it again. This edition is a great enlargement and improvement on the two former; it contains the names of 3872 species arranged according to Lamarck's System, with a full reference to the habitat and the original description. As the numbers on the left of the names are constant and intended to remain so, this work becomes a very convenient form of catalogue for all conchological collectors, as by placing on the specimen the number of the catalogue they have without further trouble a systematic arrangement of their own cabinets.

There are ten quarto colored plates attached to the catalogue, with descriptions of new and rare shells in the collection, which add much to the value as well as beauty of the work. The shells figured and described are, plate I, *Bulimus cinctus*, *Turbo Rotelliformis*, *Ampullaria Brownii*, and *A. Storeria*, *Helix Planorbis*, *Paludina scalaris*, *Lymnaea gracilis*, *Nucula Eightsii*, Couthouy; *Venerupis Peruviana*, *Fissurella nigrita*? Sowb., *Trichotropis costellatus*, Couthouy; *Nucula Portlandica*, Hitchcock; *Helix denticulata*. Plate II, *Cerithium marmoratum*, Quoy et Gaimard; *Ranella pulchra*, Gray. Plate III, *Ampullaria scalaris*, D'Orbigny; *A. ochracea*, *Helix speciosa*. Plate IV, *Natica fluctuata*, Sowb.; *Neritina granosa*, Sowb.; Plate V, *Unio spinosus*, Lea; Plate VI, *Bulimus ustulatus*, *B. Aurora*, *Achatina bicolor*, *Bulimus virgatus*, *B. porraceus*, *Pandora striata*, Quoy et Gaimard. Plate VII, *Bulimus tristis*, *Conus rhododendron*, Couthouy; *Cyclostoma Cumingii*? Sowb.; *Bulimus dubiosus*, *Cyclostoma multicarinata*, *Cyclostoma maculosa*, *Melania laeta*, *Cyclostoma multilineata*. Plates VIII and IX, *Dolium melanostomum*. Plate X, *Voluta*

* A Catalogue of the shells arranged according to the Lamarckian System, contained in the collection of John Clarkson Jay, M. D. Illustrated by ten plates. 3d edition. New York. Wiley & Putnam, 161 Broadway, and 35 Paternoster Row, London. April, 1839. 4to.

armata, var. In the above enumeration those names without any author annexed are the new species of Dr. Jay.

The plates are in general beautifully executed, although the author expresses his regret in the introduction, that they do so little justice to the originals.

70. *Lizards in Chalk*.—We were more than two years since favored by a lady of New York, formerly resident in England, with the copy of a letter, of which the following is an extract. It is from the Rev. William Bassett, curate of Brandon in Suffolk, to a former college friend. Although it has lain on file till this time, the facts have not become obsolete.—*Sen. Ed.*

Mr. Farvell, a clergyman, formerly living at Elvedon, was present when some workmen dug up two lizards at a depth of fifty feet in a chalk pit, and which on being put into water lived till his father, having the care of them, let them escape. The one about which I wrote was found at Brandon at the depth of twelve feet; lived and changed its skin twice, but escaping from a bowl in which it was kept, was found dead. Dr. Clarke showed the two found by Mr. Farvell, for several years at his lectures at Cambridge.

At the time I wrote the letter to which your cousin adverts, Dr. Clarke thought, and I believed, that there were no living lizards in England of the same kind, but have since seen them in the same Parish.

I have observed that ponds in Suffolk which abound with lizards in the spring, contain none in the autumn or winter, and in directing a lad a few years since to dig a hole in which to plant a tree, he in a solid piece of grass-land in my sight, dug up two lizards, one like those found in the chalk, and the other the *Lacertus vulgaris* of Linnæus, though I know not what Cuvier calls it. Now I am as unable to say how these lizards got into the place where I saw them found, as I am to tell how the others got into the chalk; but in the last, which I myself witnessed, they seemed only to be hybernating, and to have removed themselves out of the reach of frost. This discovery diminished certainly my former confidence, that the other lizards had been so long in the chalk as I had thought, and although those found by Mr. Farvell were fifty feet deep, yet I reflected that these pits were not sunk at once, but in successive years; and supposing one to be sunk forty nine feet in one year, a lizard had only to burrow into the chalk one foot in order to be found fifty feet from the original surface. I am now in suspense upon the subject.* Toads and bats have often been found in trees alive, in situations where they must have been many years, and if an animal can live ten years in a tree or in the earth, I know not where to fix any limit to the time its life may continue. As far as I recollect, the gentleman in Warwickshire, whose name was Hoare, found a toad and a lizard in a rock in his garden, which he supposed must have been confined within a foot of each other. Both, if not alive, became so on being exposed to the air.

* What the really learned, such as Prof. Sedgwick, (to whom I communicated these facts, and he said that he would speak to me about them, but I have not seen him since,) and Buckland say, I know not.

INDEX TO VOLUME XXXVII.

A.

- Academy of Natural Sciences of Philadelphia, their new hall, 399.
 Acid, carbonic, liquefaction of, 398.
 Agassiz, his work on the Echinodermata, noticed, 369.
 Alcoholic strength of wines, 363.
 Allan, John, on Coins and Medals, 285.
 New Haven Centennial Medal, 287.
 Amber, on Insects in, by Dr. Berendt, 365.
 American Philos. Society, notice of their transactions, 188.
 Antarctic expedition, British, for scientific discovery, 397.
 Ararat, extinct volcano near, 349.
 Asaphus diurus, a new trilobite, 40.
 August, shooting stars of, 325.
 Aurora Borealis of Sept. 3, 1839, 375.

B.

- Babel, ruins of the tower of, 352.
 Bachman, Dr. J. abstract of his monograph of the Sciuri, 290.
 Bailey, Prof. J. W. on liquefaction of carbonic acid, 398.
 Barium, on the extrication of, by Dr. Hare, 267.
 Basaltic columns of the Caucasus range, 348.
 Bassett, Rev. William, on Lizards in chalk, 402.
 Batchelder, J. M. on temperature of Saco river and adjacent air, 389.
 Baths, hot, near Tiflis, 349.
 Beaumontite, a new mineral, 398.
 Berendt, his work on insects in amber, 365.
 Berzelius on meteoric stones, 93.
 Bethlehem, Pa. catalogue of plants collected near, 310.
 Bevan, Benj. biographical notice of, 120.
 Bewick, Thos. do. do. 158.
 Biography, scientific, announced by J. W. Webster, 193.
 Bischof, Prof. Gustav, natural history of volcanos and earthquakes, 41.
 Black Heath coal mine, explosion in, 387.
 Boracic acid lagoons of Tuscany, 270.
 Boston Society of Natural History, proceedings of, 391.
 Bowring, Dr. J. on boracic acid lagoons of Tuscany, 270.
 British Annual, by Dr. R. D. Thomson, noticed, 400.

- British Antarctic Expedition, 397.
 Association, August, 1839, 389.
 Naturalists, notices of, by Rev. C. Fox, 136.
 Bronn, Prof. his *Lethæa Geognostica*, noticed, 369.
 exchanges of specimens of Natural History, 369.
 Brown coal formation of Texas, 216.

C.

- Calcareous deposits in Persia, &c., 355.
 Calcium, evolution of, by Dr. Hare, 267, 269.
 Caldas on measuring heights by the boiling of water, 19.
 Calymene Bufo, remarks on, by Prof. J. Green, 32.
 Carbonic acid, liquefaction of, 398.
 Catlinite, name proposed for Ind. Pipe Stone, 394.
 Chalk, lizards in, 402.
 Christison on alcoholic strength of wines, 363.
 Chronometrical determination of the longitude of New York, 400.
 Cinnabar not found in Michigan, 185.
 Climate of Colombia, 11.
 Coal mines, American, explosions in, 387.
 of Dudley, excursion to, 390.
 Coal strata of the Trinity County, Texas, 216.
 Coathupe on products of respiration at different hours, 367.
 Coke, burning, its light used in photography, 368.
 Cold, points of maximum, connected with magnetic poles, 100.
 Colombia, meteorological observations in, by Col. R. Wright, 1.
 Comet of Encke, observed in 1838, 191.
 Conductors of lightning, for ships, remarks on, by the editors, 323.
 Conjugations, Greek, tables of, by Prof. J. W. Gibbs, 112.
 Copper, native crenated hydro-silicate of, 398.

D.

- Da Costa, biog. notice of, 155.
 Daguerre's photographic drawing, 169.
 process for, 374.
 Darlington's Essay on vegetable metamorphosis, noticed, 187.
 Daubeny, Prof. his views of volcanoes, thermal springs, &c. 53.

- Daubeny, his reply to Prof. Bischof, on volcanoes, 78.
- Dent, E. I. chronometrical determination of longitude of New York, 400.
- Desmarest, A. G., biog. notice of, 124.
- Dewey, Chester, on polished limestone of Rochester, N. Y. 240.
temperature of lake Ontario, 242.
- Dipping needle, mode of adjusting, 277.
- Drury, Thos., on electrical excitement of leather by friction, 197.
- Dudley coal mines, excursion to, 390.
- E.**
- Earth, heat of the interior of, 357.
- Earths carried over in distillation, 398.
- Earthquakes at Tabriz, 351.
natural history of, by Prof. G. Bischof, 41.
- Echinodermata, Agassiz's work on, noticed, 369.
- Editor, Senior, note on the *Limulus Polyphemus*, 27.
- Editors, remarks on a tornado in Alleghany Co. N. Y. 90.
on effects of lightning on packet ship New York, 323.
geological and other notices from Sir R. K. Porter's *Travels*, 347.
notices of geological surveys of the States, 375.
restoration of magnetism to compass needles, 325.
notice to subscribers and readers, 200.
- Ehrenberg's discoveries concerning fossil animalcules, 116.
- Electrical excitement produced in leather by friction, 197.
- Emmons, Prof. E., on heights of mountains in New York, 85.
- Encke's comet, observations in 1838, 191.
- Equivalents, chemical, of certain gases, 368.
- Essex Co. Nat. Hist. Soc., notice of their *Journal*, 187.
- Etching on glass, by photographic processes, 178.
- Exploring Expedition, U. S. progress of, 189, 398.
- Explosions in American coal mines, 387.
- Explosion of hydrogen and oxygen, remarks on, 104.
- Eudiometer, new, by Dr. R. Hare, 383.
- F.**
- Faraday's analysis of Cold Bokkeveld meteorites, 190.
- Fat of animals, mode of preserving, 194.
- Felis borealis* (?) taken in Conn., 194.
- Fire-dump, chemical examination of, 201.
- Footsteps in new red sandstone, 223.
- Formula for finding the weight and volume in a mixture of two bases, 289.
- Fossil tree at Granton, 363.
- Fox, Rev. Chas., notices of British Naturalists, 136.
- Fox, R. W., on formation of metallic veins, 199.
- Frodsham, W. J., on vibrations of pendulums, 278.
- Fulminating powder, by Dr. Hare, 268.
- Fyfe, Andrew, on photographic processes, 175.
- G.**
- Galvanic ignition of gunpowder in blasting, by Dr. Hare, 269.
- Gaylord, Willis, on mechanical vaporization of earths, 398.
account of a tornado in New York, 91.
- Geological Dynamics, Prof. Whewell on, 234.
- Geological Society of London, officers of, 129.
- Geological Society of London, Whewell's address before, 116.
Surveys of the States, noticed, 375.
- Gibbs, Prof. J. W., on the Greek conjugations, 112.
- Goethe on the metamorphosis of the organs of plants, 187.
- Greek conjugations, remarks on, 112.
- Green, Prof. J., description of a new trilobite, 40.
- Green, Prof. J., on trilobites in general, 25.
remarks on *Calymene* *Bufo*, 32.
- H.**
- Haile, A. B., map of path of New Haven tornado, 343.
- Hamilton, J., on terrestrial magnetism, 100.
- Harden, Dr. J. M. B., formula for analysis of mixtures, 289.
- Hare, Clark, on reaction of sulphuric acid with essential oil of hemlock, 246.
- Hare's compound blowpipe, remarks on, 104.
- Hare, Dr. Robert, on extrication of barium, calcium and strontium, 267.
a fulminating powder, 268.
galvanic ignition of gunpowder, in blasting rocks, 269.
a new eudiometer, 383.
a new method of purifying oil of turpentine, 399.
- Heat of the interior of the earth, 357.
- Heights measured by the boiling of water, 19.

- Heights of certain mountains in N. Y., measured trigonometrically and barometrically, 84, 194.
- Hemlosulphuric acid, 249.
- Hemming's safety-tube, remarks on, 105.
- Herrick, E. C., on the fall of a meteorite in Mo. Feb. 1839, 385.
- the meteor of Dec. 14, 1837, 130.
- a Northern Lynx taken in Conn., 194.
- shooting stars of August, 1839, &c., 325.
- velocity of Weston meteorite, 132.
- Hewitson, Wm., notice of, 166.
- Hopkins, Thos., on malaria, 196.
- his table of mortality, 196.
- Hopkins's mathematical investigations into the condition of the earth's interior, 235.
- Hot baths near Tiflis, 349.
- Huebener, A. L., & J. Wolle, their catalogue of plants, 310.
- Hume, Sir A., biographical notice of, 118.
- I.
- Icterus phœniceus, notice of, 196.
- Ignition of gunpowder by galvanism, 269.
- J.
- Jackson, Dr. C. T., his account of Beaumontite, a new mineral, 398.
- analysis of Indian pipe-stone, (Catlinite.) 394.
- his geological report of Maine, noticed, 376.
- Jay, Dr. J. C., his Catalogue of shells, noticed, 401.
- Jenyns, Rev. Leonard, notice of, 165.
- Johnson, E. F., on heights of certain mountains in N. Y., 84, 194.
- Journal of Essex Co. Nat. Hist. Soc., noticed, 187.
- London Statistical Soc., noticed, 189.
- K.
- Knox, L. L., observations on meteors of August 10, 329.
- Kuhlmann, on action of spongy platinum, 198.
- L.
- Larned, Rev. W. A., translation of Berzelius on meteoric stones, 93.
- Latanium, a new metal, 192.
- Leather electrically excited by friction, 197.
- Lepidolite, (rose mica) analysis of, 361.
- Lethæa Geognostica of Prof. Bronn, noticed, 369.
- Liatris, new species of, 338.
- Lightning, effects of, on packet ship New York, 321.
- magnetizing powers of, 322.
- Limestone, polished of Rochester, N. Y., 240.
- Limulus Polyphemus, remarks on, 27.
- Linnæus, notice of, 142.
- Linsley, Rev. Jas. H., notice of Icterus phœniceus, 195.
- Linsley, Rev. Jas. H., notice of Vespertilio pruinus, 195.
- Lister, Martin, notice of, 136.
- Lizards in Chalk, 402.
- Longitude of New York, determined chronometrically, 400.
- Lunar origin of meteoric stones, supposed, 94.
- Lynx, Northern, taken in Connecticut, 194.
- M.
- Maclure, Wm., his munificent donations to science, 399.
- Magnetical observations, scheme for, 198.
- Magnetism, terrestrial, remarks on, by J. Hamilton, 100.
- Magneto-electric multiplier, by Dr. C. G. Page, 275.
- Maine, Dr. Jackson's geological report on, noticed, 376.
- Malaria, effects of water in generating, 196.
- Mallet, Robt. on use of light of burning coke in photography, 368.
- Marble, yellow transparent, of Tabriz, 355.
- Marsupial remains in Stonesfield slate, discussion concerning, 228.
- Mastodon, remains of, in Missouri, 191.
- Medal, New Haven centennial, described, 287.
- Medals and coins, remarks on, 285.
- Megatherium, nature of its covering, 371.
- Mercury, sulphuret of, not found in Michigan, 185.
- Metal, new, discovered by Mosander, 192.
- Meteor of December 14, 1837, 130.
- Meteoric iron from Potosi, 190.
- Meteorite of Weston, velocity of, 132.
- Meteorites, fall of, in South Africa in 1838, 190.
- Meteorites, fall of, in Missouri, February, 1839, 385.
- investigations concerning, by Berzelius, 93.
- Meteorological observations in Columbia, 1.
- Meteors of August 9 and 10, 1839, 325.
- Nov. 13 and 14, 1838, 372.
- Mica, analyses of, 361.
- Mica containing potash and lithia, 356.

- Mineral, new, called Beaumontite, 398.
springs in Texas, 214.
- Missouri, fall of a meteorite in, 385.
remains of Mastodon in, 191.
- Montague, Geo. notice of, 162.
- Montlosier, Count, biog. notice of, 121.
- Mortality among troops in W. Indies,
tables of, 196.
- Mosander's discovery of Lanthanum, a
new metal, 192.
- Murchison's Silurian Syst., noticed, 219.
- Museums of Nat. Hist. when established
in England, 143.
- N.**
- Naphtha springs in Persia, &c., 353.
- Natural History, exchanges in, 369.
society of Boston, pro-
ceedings of, 391.
- Naturalists, British, notices of, 136.
- Needle, dipping, mode of adjusting, 277.
- Needles, how magnetized speedily on
shipboard, 325.
- New Brunswick tornado, 255.
- New Haven Centennial Medal descri-
bed, 287.
tornado, account of, 340.
- New York, heights of certain mountains
in the state of, 84.
packet ship, struck by light-
ning, 321.
City Hall, its longitude de-
termined by chronometers, 400.
- Niepce, his photographic processes, 173,
374.
- Notice to subscribers and readers, 200.
- O.**
- Ørsted on Waterspouts, 250.
- Oil of hemlock, its reaction with sulphu-
ric acid, 246.
- Oil of turpentine, how purified from res-
in, 399.
- Olmsted, Prof. D., account of the New
Haven tornado, 340.
- Ontario Lake, temperature of, 242.
- Owen on the Megatherium, 371.
- P.**
- Pæstum, on the stone of which its tem-
ples are built, 366.
- Page, Dr. C. G. his magneto-electric
multiplier, 275.
- Palæontology, Prof. Whewell's remarks
on, 227.
- Pendulums, experiments on their vi-
brations, with different suspending
springs, 278.
- Pennant, Thos. notice of, 146.
- Pennsylvania, notice of Prof. H. D. Ro-
gers's geological report of, 380.
- Perry, Prof. Thos. H. mode of adjusting
the dipping needle, 277.
- Philadelphia, Acad. of Nat. Sciences,
their new hall, 399.
- Phillips, R. on certain chemical equiva-
lents, 368.
- Photographic or photogenic drawing,
169, 361, 368, 374.
- Pipe-stone, Indian, analysis of, 394.
- Plants collected near Bethlehem, Pa.
Catalogue of, 310.
- Platinum, spongy, action of, 198.
- Ponton, M., on preparation of paper for
photography, 361.
- Porter, Sir R. K. extracts from his trav-
els in Persia, &c., 347.
great value of his work,
347.
- Potosi, analysis of meteoric iron from,
190.
- Proceedings of Boston Nat. Hist. Soc'ty,
391.
- R.**
- Rain drops, solid impressions and casts
of, 371.
- Raphael tapestries, revival of their col-
ors, 244.
- Regnault, analysis of mica containing
potash and lithia, 356.
- Respiration, products of, at different
hours, 367.
- Rich, Charles, on the effects of lightning
on the packet ship New York, 321.
- Riddell, Prof. J. L., geology of the Trin-
ity Country, Texas, 211.
- Rings of Saturn, five or more in num-
ber, 373.
- Robison, John, on photographic draw-
ing, 183.
- Rochester, polished limestone of, 240.
- Rogers, Prof. H. D., notice of his geolo-
gical report of Pa., 380.
- Rogers, Prof. W. B., notice of his geolo-
gical report of Va., 380.
- S.**
- Saco river, temperature of, 389.
- Salmon, Wm. biog. notice of, 121.
- Salt, deposits of in Persia, &c., 350.
- Salt springs in Texas, 213.
- Sandwich Islands, great agitations of
the sea at, 358.
- Saturn's rings, five or more seen, 373.
- Schlotheim, Baron, biog. notice of, 128.
- Sciuri, monograph of the, by Dr. J. Bach-
man, 290.
- Sea, near Sandwich Islands, greatly agi-
tated, Nov. 7, 1837, 358.
- Sedgwick on the Cambrian system of
rocks, noticed, 220.
- Selby, P. J., notice of, 164.
- Shells, Dr. Jay's catalogue of, noticed,
401.
- Shepherd, Forrest, account of the fall of
a meteorite in Missouri, 385.
- Shooting Stars of August, 1839, &c., 325.
November, 1838, 372.
- Sibbald, Sir Robert, notice of, 138.

- Silurian System of Murchison, noticed 219.
- Soap, economical mode of making, 194.
- Solar Painting, 169, 374.
- Springs, mineral in Texas, 213.
thermal, their connection with volcanoes, 53.
at Singerli, 372.
- Squirrels of North America described, 290.
- Stars, double, motions of, 373.
missing, 373.
- Statistical Society of London, notice of their Journal, 189.
- Sternberg, Kaspar, biog. notice of, 125.
- Stickney, B. F., on supposed discovery of cinnabar in Michigan, 185.
- Stones meteoric, fall of in Missouri, 385.
South Africa, 190.
investigation of, by Berzelius, 93.
- Strontium, extrication of, by Dr. Hare, 267.
- Sulphuric acid, its reaction with essential oil of hemlock, 246.
- T.**
- Tabriz, earthquakes at, 351.
- Talbot, H. F., photographic drawing, 171.
- Tapestries of Raphael, revival of their colors, 244.
- Taurus mountains described, 351.
- Thermal springs, causes of, 53.
- Thomas, David, on a new species of *Liatris*, 338.
- Thomson, R. D., his *British Annual* noticed, 400.
- Tomlinson, D., on preserving animal fat, 194.
- Tornado in Allegany Co. N. Y., July 25, 1838, 90.
New Brunswick, N. J. June 19, 1835, 255.
New Haven, July 31, 1839, 340.
- Tower of Babel, ruins of, 352.
- Transactions of Amer. Phil. Soc. Vol. 6, pt. 2, noticed, 188.
- Tree, fossil at Granton, 363.
- Trevelyan on materials of the temples at Pæstum, 366.
- Trilobite, new species of, 40.
- Trilobites, remarks on, by Prof. J. Green, 25.
Dr. Buckland, 27.
- Trinity Country, Texas, geology of, 211.
- Trull on the colors of the Raphael Tapestries, 244.
- Tuckerman, Edward Jr., on the Lichens of N. E., 394.
- Turner, Prof. E., chemical examination of the fire damp, 201.
- Turpentine, oil of, how purified, 399.
- Turton, Wm., notice of, 161.
- Tuscany, boracic acid lagoons of, 270.
- V.**
- Vaporization of earths by distillation, 398.
- Vegetation as affected by climate, 15.
- Veins metallic, formed by voltaic agency, 199.
- Vespertilio pruinosis, notice of, 195.
- Virginia, notice of Prof. W. B. Rogers' geological report of, 380.
- Volcano, extinct, near Ararat, 349.
internal, in the Courdish country, 350.
- Volcanoes, chemical theory of, defended by Daubeny, 78.
natural history of, by Prof. G. Bischof, 41.
- W.**
- Water, boiling of, its use in measuring heights, 19.
- Waterspouts, Ærsted's essay on, 250.
- Webster, Prof. J. W., on explosions of hydrogen and oxygen, 104.
his proposed biography of scientific men, 193.
- Weston meteorite, velocity of, 132.
- Whewell, Rev. Wm., address before Lond. Geological Society, 116, 218.
- White, Gilbert, notice of, 155.
- Winch, N. J., notice of, 120.
- Wines, alcoholic strength of, 363.
- Wolle, J., and A. L. Huebener, their Catalogue of Plants, 310.
- Wright, Col. Richard, meteorological observations in Colombia, 1.
- Wyman, Dr. J., proceedings of Boston Soc. of Nat. Hist., 391.
- Y.**
- Yarrell, Wm., notice of, 167.

ALTERATIONS AND CORRECTIONS.

The following alterations and corrections were received after the article to which they refer, and the page containing the errata, were printed.

Page 392, line 1, for *Havre*, read *horse*. Page 392, line 8, for *lineatus*, read *lateralis*. Page 392, line 9, *pomerana*, read *pomarina*. Page 392, line 28, *Sycyas*, read *Sycyos*. Page 394, line 33, *Monochamus*, read *Monochirus*. Page 395, line 29, *Hudsonianus*, read *Hudsonicus*. Page 395, line 37, *cotta*, read *catta*. Page 395, line 39, *Cysticencus*, read *Cysticercus*. Page 396, line 41, *Crogin*, read *Cragin*. Page 397, line 35, *developed*, read *enveloped*.

CONTENTS OF VOLUME XXXVII.

NUMBER I.

	Page.
ART. I. Meteorological Observations during a Residence in Colombia, between the Years 1820 and 1830; by Col. Richard Wright,	1
II. Remarks on the Trilobite; by Prof. Green, M. D.,	25
III. Description of a New Trilobite; by Prof. Jacob Green, M. D.,	40
IV. On the Natural History of Volcanos and Earthquakes; by Prof. Gustav Bischof, M. D.,	41
V. Reply of Dr. Daubeny to Prof. Bischof's Objections to the Chemical Theories of Volcanos,	78
VI. Mountains in New York; by E. F. Johnson,	84
VII. Account of a Tornado; by Willis Gaylord,	90
VIII. On Meteoric Stones—From the Annual Account of the Progress of Physics and Chemistry; by Berzelius,	93
IX. Terrestrial Magnetism; by J. Hamilton,	100
X. Explosion of Hydrogen and Oxygen, with Remarks on Hemming's Safety Tube; by Prof. J. W. Webster,	104
XI. On the Greek Conjugations; by Prof. J. W. Gibbs,	112
XII. Notice of Prof. Ehrenberg's Discoveries in relation to Fossil Animalcules; also Notices of Deceased Members of the Geological Society of London, being extracts from the Address of Rev. William Whewell, B. D. F. R. S.,	116
XIII. Account of a Meteor seen in Connecticut, December 14, 1837; with some considerations on the Meteorite which exploded near Weston, Dec. 14, 1807; By Edward C. Herrick,	130
XIV. Some Notice of British Naturalists; by Rev. Charles Fox,	136

MISCELLANIES.

1. Pictorial delineations by light; solar, lunar, stellar, and artificial, called Photogenic and the art Photography,	169
2. Correction of an Error—Cinnabar not found in Michigan,	185

	Page.
3, 4. An Essay on the Development and Modifications of the external Organs of Plants—Journal of the Essex County (Mass.) Natural History Society,	187
5. Transactions of the American Philosophical Society,	188
6, 7. Notice of the Journal of the Statistical Society of London.—Progress of the U. S. Exploring Expedition,	189
8, 9. Cold Bokkeveld Meteorites—Meteoric Iron from Potosi,	190
10, 11. Encke's Comet—Remains of the Mastodon in Missouri,	191
12. Lanthanum, a New Metal,	192
13. Biography of Scientific Men,	193
14, 15, 16. Note by Mr. E. F. Johnson, Civil Engineer—A Northern Lynx taken in Connecticut—Preservation of animal Fat for Soap Making,	194
17. Notice of <i>Vespertilio Pruinosus</i> and <i>Icterus Phœniceus</i> ,	195
18. Malaria,	196
19. Electrical Excitement in Leather by Friction,	197
20, 21. Great Scheme for Magnetical Observations—Action of Spongy Platina,	198
22. Formation of Metallic Veins by Galvanic Agency,	199
To our Subscribers and Readers,	200

NUMBER II.

ART. I. Chemical Examination of the Fire-Damp from the Coal Mines near Newcastle. By [the late] EDWARD TURNER, M. D., F. R. S. Lon. and Edin., V. P. G. S., Professor of Chemistry in the University of London,	201
II. Observations on the Geology of the Trinity Country, Texas, made during an excursion there in April and May, 1839; by Prof. J. L. RIDDELL, M. D.,	211
III. Extracts from the Anniversary Address of the Rev. WM. WHEWELL before the Geological Society of London,	218
IV. On the Polished Limestone of Rochester; by Prof. CHESTER DEWEY,	240
V. On the Temperature of Lake Ontario; by Prof. CHESTER DEWEY,	242
VI. On the Effects of Light and Air in restoring the faded Colors of the Raphael Tapestries; by Mr. TRULL,	244
VII. Of the Reaction of Sulphuric Acid with the Essential Oil of Hemlock; by CLARK HARE,	246

	Page.
VIII. On Water Spouts; by Prof. HANS CHRISTIAN ÆRSTED,	250
IX. Brief notice of the extrication of Barium, Strontium and Calcium by exposure of their chlorides to a powerful voltaic circuit in contact with mercury as a "cathode;" and the distillation of the resulting amalgams by means of vessels of iron,	267
X. Process for a Fulminating Powder—for the Evolution of Calcium and Galvanic Ignition of Gunpowder; by Dr. HARE,	268
XI. On the Boracic Acid Lagoons of Tuscany; by JOHN BOWRING, LL. D.,	270
XII. Magneto-Electric Multiplier; by CHAS. G. PAGE, M. D.,	275
XIII. Method of adjusting the Dipping Needle; by Prof. THOMAS H. PERRY,	277
XIV. Results of Experiments on the Vibrations of Pendulums with different suspending springs; being the substance of a paper by W. J. FRODSHAM, F. R. S., . .	278
XV. On Coins and Medals, with a notice of the Medal which has been recently struck to commemorate the settlement of New Haven, Connecticut,	285
XVI. Formula for discovering the Weight and Volume in a Mixture of two Bases; by Dr. JNO. M. B. HARDEN,	289
XVII. Abstract of a Monograph of the Genus Sciurus, with descriptions of several new species and varieties; by J. BACHMAN, M. D.,	290
XVIII. Catalogue of Botanical Specimens, collected by J. WOLLE and A. L. HUEBENER, during the year 1837, in the vicinity of Bethlehem and other parts of Northampton County, Pennsylvania, in the order as they were found in bloom,	310
XIX. Effects of Lightning upon the packet ship New York; by Mr. CHARLES RICH,	321
XX. Report on the Shooting Stars of August 9th and 10th, 1839, with other facts relating to the frequent occurrence of a meteoric display in August; by EDWARD C. HERRICK,	325
XXI. Description of a New Species of Liatris; by DAVID THOMAS,	338
XXII. Observations on the New Haven Tornado of July 31, 1839; by Prof. DENISON OLMSTED,	340

MISCELLANIES.

	Page.
Notices of geological and other physical facts and of antiquities in Asia, from Sir Robert K. Porter's Travels in Georgia, Persia, Armenia, Ancient Babylonia, &c. &c.,	347
1, 2. The Caucasus Range—Basalt,	348
3, 4, 5, 6. Floods—Hot Baths—Boiling Spring near the Akhoor River—Ararat—Extinct Volcano near Mount Ararat,	348
7, 8, 9, 10, 11. An Internal Volcano—Salt near Tabriz—Salt in Lake Oroomia—Salt Mine near Erivan—Salt of the Great Salt Desert,	350
12, 13, 14. Earthquakes at Tabriz—Taurus Mountains, south of the Euxine—Copper Mines,	351
15, 16, 17, 18, 19, 20, 21, 22. Copper, Lead, and Silver—Iron Ore—Cherry Trees—Alum—Avalanches of mud, stones, and mountains—Immense block of Granite—Nitrous Efflorescence—Tower of Babel,	352
23, 24. Naptha Springs and Sulphur—The Kirkook Naptha,	353
25. Naptha Springs of Bakon,	354
26, 27. Yellow Transparent Marble of Tabriz, near L. Oroomia—Enormous Calcareous Deposit,	355
28, 29, 30. Limestone with Shells—Limestone Promontory on Island Oroomia—Mica containing Potash and Lithia,	356
31. Heat of the interior of the earth,	357
32. Notice of remarkable agitations of the Sea at the Sandwich Islands, on the 7th November, 1837,	358
33, 34. Rose Mica Lepidolite—Notice of a cheap and simple method of preparing paper for Photographic Drawing, in which the use of any salt of silver is dispensed with,	361
35, 36. Fossil Tree at Granton, near Edinburgh—Notice upon the Alcoholic Strength of Wines,	363
37. Dr. Berendt's Investigations on Amber,	365
38. Notice regarding the Stone used in constructing the Temples at Pæstum,	366
39. Products of Respiration at different periods of the day,	367
40, 41. Chemical Equivalents—Photogenic power of Light from burning Coke,	368
42, 43. Lethæa Geognostica of Prof. Bronn. Exchange of objects of Natural History—Prof. Agassiz on the Echinodermata,	369

	Page.
44, 45. Solid impressions and casts of Drops of Rain—Megatherium,	371
46, 47. Hot Springs—Additional Observations on the Meteors of November 13 and 14, 1838,	372
48, 49, 50. Stars Missing—Double Stars—Five or more rings around Saturn,	373
51. Solar Painting,	374
52, 53. Aurora Borealis of Sept. 3, 1839—Geological Survey,	375
54. Dr. Hare's new Eudiometer,	383
55. Fall of a Meteorite in Missouri, Feb. 13, 1839,	385
56. Explosions in American Coal Mines,	387
57, 58. Relative temperature of the water of the Saco river, and the atmosphere for the years 1837 and 1838—British Association,	389
59. Proceedings of the Boston Society of Natural History,	391
60. British Antarctic Expedition,	397
61, 62, 63, 64. Liquefaction of Carbonic Acid—A new Mineral—Progress of the U. S. Exploring Expedition—Mechanical Vaporization of Earths by distillation,	398
65, 66. New Hall of the Academy of Natural Sciences at Philadelphia—Dr. Hare's method of removing the resin which contaminates the best Oil of Turpentine of commerce by an alcoholic solution of Chloride of Calcium,	399
67, 68. British Annual and Epitome of the progress of Science for 1838—Longitude of New York,	400
69. Jay's Catalogue of Shells, 3d edition,	401
70. Lizards in Chalk,	402

ERRATA.

P. 292, l. 2, for *lips*, read *tips*.—P. 297, l. 28, for 2 7½, read 7½.—P. 287, l. 2, for *Dassin*, read *Dassier*; for *first*, read *second*; l. 29, for 1817, read 1825.—P. 368, l. 28, before *azote*, read *oxygen*.

NOTICE TO SUBSCRIBERS AND AGENTS.

The Editors will pay \$1 50 in cash per No. for the following numbers of the American Journal of Science. Or if preferred, they will credit them to the account of any subscriber at the rate at which recent numbers are charged. Or they will exchange for them such other numbers as may be desired of which they have a supply. The Nos. wanted are shown below in a tabular form. If any No. is sent by mail, the word RETURNED must be put on the envelope.

Vol.	V.	XI.	XIII.	XIV.	XVI.	XVII.	XXII.	XXVII.
Number	2.	1.	1, 2.	1, 2.	1, 2.	1, 2.	1, 2.	1, 2.
Entire No.	12.	24.	27, 28.	29, 30.	33, 34.	35, 36.	45, 46.	55, 56.

Our agents and friends are requested to make search for the above and forward them promptly to us.

New Haven, Oct. 1, 1839.

✍ Several complete sets are still on hand for sale.

THE AMERICAN JOURNAL, &c.—AGENTS.

<p>MAINE. SACO, Rufus Nichols. PORTLAND, Colman, Holden, & Co. NEW HAMPSHIRE. Dart. Coll. HANOVER, { Prof. Oliver P. Hubbard. MASSACHUSETTS. NEWBURYPORT, Charles Whipple. BOSTON, { Otis Broaders & Co. Weeks Jordan & Co. SALEM, Henry Whipple. NEW BEDFORD, William C. Taber. SPRINGFIELD, G. & C. Merriam. AMHERST, J. S. & C. Adams. WORCESTER, { Dorr, Howland, & Co. Clareadon Harris. LOWELL, D. Bixby. RHODE ISLAND. PROVIDENCE, B. Cranston & Co. CONNECTICUT. HARTFORD, Canfield & Robins. NORWICH, Thomas Robinson. MIDDLETOWN, Luke C. Lyman. NEW YORK. NEW YORK, A. T. Goodrich. WEST POINT, John DeWitt. NEWBURGH, H. P. Bepham. ALBANY, W. C. Little. TROY, Elias Gates. ITHACA, D. D. Spencer. LITTLE FALLS, Edward M. Griffing</p>	<p>ROCHESTER, Hoyt, Porter & Co. BUFFALO, O. G. Steele & Co. PENNSYLVANIA. PITTSBURGH, John J. Kay & Co. MARYLAND. BALTIMORE, N. Hickman. DISTRICT OF COLUMBIA. WASHINGTON, Frank Taylor. NORTH CAROLINA. CHAPEL-HILL, Prof. F. Mitchell. SOUTH CAROLINA. CHARLESTON, { John P. Beild. Ebeneser Thayer. VIRGINIA. RICHMOND, R. I. Smith & Co. WHEELING, J. Fisher & Sons. NORFOLK, Richard Worthington. OHIO. COLUMBUS, I. N. Whiting. GEORGIA. SAVANNAH, Wm. T. Williams. AUGUSTA, Th. F. Wray. COLUMBUS, J. C. Plant & Co. TENNESSEE. NASHVILLE, Wm. A. Eichbaum. ALABAMA. HUNTSVILLE, Iby & Smith. MISSISSIPPI. GRAND GULF, Wm. M. Smyth. CANADA. QUEBEC, Samuel Nelson.</p>
--	---

TERMS.

Six dollars per annum; published in four Quarterly numbers, making two volumes a year, of from eight to nine hundred pages for both volumes, which are fully illustrated by plates.

Terms of credit to general agents, six months from the publication of No. 1, of each volume.

The Editor will draw on the agents, semi-annually, i. e. on the publication of No. 2 of each Vol., payable, six months from the publication of No. 1, in all cases, where payment is not otherwise provided for.

Remittances may be made through postmasters (i. e. Jan. and July): sums of \$5 or \$10 are convenient, as they can be credited in account.

Money remitted will in all cases be acknowledged by a bill and receipt in the next No. of the Journal: if no such paper is received, it may be presumed that the remittance has miscarried, (a very rare occurrence.)

Complete sets, now 27 vols., are furnished at a suitable discount.

The expense of this Journal being greater, and the patronage less than that of the literary journals, the price is necessarily one dollar more per annum.

TO CORRESPONDENTS.

This work is most safely and expeditiously transmitted to distant subscribers by mail. This No. contains 13 sheets; postage, under 100 miles, 25 cents, over 100 miles, 32½ cents.

The titles of communications and of their authors, to be fully given.

When extra copies are desired, the notice should be placed at the head of the MS.

Notice always to be sent of discontinuance, removals and deaths of subscribers.

Return proofs, not to be sealed, or inscribed with any thing except corrections.

Notice to be given when communications are intended, also, for other Journals, or have been already published in them.